

FCC Test Report

Report No.: RF160205C08C

FCC ID: PY315200317

Test Model: EX7300

Received Date: Feb. 04, 2016

Test Date: Feb. 23 ~ Mar. 17, 2016 (For radiated emissions below 1GHz and conducted emission tests)

May 13 ~ May 31, 2016 (For all tests except radiated emissions below 1GHz and conducted emission)

Issued Date: Jun. 03, 2016

Applicant: NETGEAR, INC.

Address: 350 East Plumeria Drive San Jose, CA 95134

Issued By: Bureau Veritas Consumer Products Services (H.K.) Ltd., Taoyuan Branch

Lab Address: No. 47-2, 14th Ling, Chia Pau Vil., Lin Kou Dist., New Taipei City, Taiwan (R.O.C.)

Test Location: No. 19, Hwa Ya 2nd Rd., Wen Hwa Vil., Kwei Shan Dist., Taoyuan City 33383, TAIWAN (R.O.C.)



This report is for your exclusive use. Any copying or replication of this report to or for any other person or entity, or use of our name or trademark, is permitted only with our prior written permission. This report sets forth our findings solely with respect to the test samples identified herein. The results set forth in this report are not indicative or representative of the quality or characteristics of the lot from which a test sample was taken or any similar or identical product specifically and expressly noted. Our report includes all of the tests requested by you and the results thereof based upon the information that you provided to us. You have 60 days from date of issuance of this report to notify us of any material error or omission caused by our negligence, provided, however, that such notice shall be in writing and shall specifically address the issue you wish to raise. A failure to raise such issue within the prescribed time shall constitute your unqualified acceptance of the completeness of this report, the tests conducted and the correctness of the report contents. Unless specific mention, the uncertainty of measurement has been explicitly taken into account to declare the compliance or non-compliance to the specification. The report must not be used by the client to claim product certification, approval, or endorsement by TAF or any government agencies.

Table of Contents

Release Control Record	4
1 Certificate of Conformity	5
2 Summary of Test Results	6
2.1 Measurement Uncertainty	6
2.2 Modification Record	6
3 General Information	7
3.1 General Description of EUT	7
3.2 Description of Test Modes	9
3.2.1 Test Mode Applicability and Tested Channel Detail	10
3.3 Duty Cycle of Test Signal	12
3.4 Description of Support Units	14
3.4.1 Configuration of System under Test	14
3.5 General Description of Applied Standard	14
4 Test Types and Results	15
4.1 Radiated Emission and Bandedge Measurement.....	15
4.1.1 Limits of Radiated Emission and Bandedge Measurement	15
4.1.2 Test Instruments	17
4.1.3 Test Procedure	18
4.1.4 Deviation from Test Standard	18
4.1.5 Test Setup.....	19
4.1.6 EUT Operating Conditions.....	19
4.1.7 Test Results	20
4.2 Conducted Emission Measurement	36
4.2.1 Limits of Conducted Emission Measurement	36
4.2.2 Test Instruments	36
4.2.3 Test Procedure	37
4.2.4 Deviation from Test Standard	37
4.2.5 Test Setup.....	37
4.2.6 EUT Operating Conditions.....	37
4.2.7 Test Results	38
4.3 Transmit Power Measurement	40
4.3.1 Limits of Transmit Power Measurement	40
4.3.2 Test Setup.....	40
4.3.3 Test Instruments	41
4.3.4 Test Procedure	41
4.3.5 Deviation from Test Standard	41
4.3.6 EUT Operating Conditions.....	41
4.3.7 Test Result.....	42
4.4 Peak Power Spectral Density Measurement	48
4.4.1 Limits of Peak Power Spectral Density Measurement	48
4.4.2 Test Setup.....	48
4.4.3 Test Instruments	48
4.4.4 Test Procedure	48
4.4.5 Deviation from Test Standard	48
4.4.6 EUT Operating Condition	48
4.4.7 Test Results	49
4.5 Frequency Stability.....	55
4.5.1 Limits of Frequency Stability Measurement	55
4.5.2 Test Setup.....	55
4.5.3 Test Instruments	55
4.5.4 Test Procedure	55
4.5.5 Deviation from Test Standard	55
4.5.6 EUT Operating Condition	55

4.5.7 Test Results	56
4.6 6dB Bandwidth Measurement.....	57
4.6.1 Limits of 6dB Bandwidth Measurement.....	57
4.6.2 Test Setup.....	57
4.6.3 Test Instruments	57
4.6.4 Test Procedure	57
4.6.5 Deviation from Test Standard	57
4.6.6 EUT Operating Condition	57
4.6.7 Test Results	58
5 Pictures of Test Arrangements.....	62
Annex A- Radiated Out of Band Emission (OOBE) Measurement (For U-NII-3 band).....	63
Appendix – Information on the Testing Laboratories	68

Release Control Record

Issue No.	Description	Date Issued
RF160205C08C	Original release.	Jun. 03, 2016

1 Certificate of Conformity

Product: Nighthawk X4 AC2200 WiFi Range Extender

Brand: NETGEAR

Test Model: EX7300

Sample Status: Engineering sample

Applicant: NETGEAR, INC.

Test Date: Feb. 23 ~ Mar. 17, 2016 (For radiated emissions below 1GHz and conducted emission tests)

May 13 ~ May 31, 2016 (For all tests except radiated emissions below 1GHz and conducted emission)

Standard: 47 CFR FCC Part 15, Subpart E (Section 15.407)

ANSI C63.10:2013

The above equipment has been tested by **Bureau Veritas Consumer Products Services (H.K.) Ltd., Taoyuan Branch**, and found compliance with the requirement of the above standards. The test record, data evaluation & Equipment Under Test (EUT) configurations represented herein are true and accurate accounts of the measurements of the sample's EMC characteristics under the Conditions specified in this report.

Prepared by : *Suntee Liu* , **Date:** Jun. 03, 2016
Suntee Liu / Specialist

Approved by : *Ken Liu* , **Date:** Jun. 03, 2016
Ken Liu / Senior Manager

2 Summary of Test Results

47 CFR FCC Part 15, Subpart E (Section 15.407)			
FCC Clause	Test Item	Result	Remarks
15.407(b)(6)	AC Power Conducted Emissions	PASS	Meet the requirement of limit. Minimum passing margin is -12.70dB at 0.54112MHz.
15.407(b) (1/2/3/4(i/ii)/6)	Radiated Emissions & Band Edge Measurement	PASS	Meet the requirement of limit. Minimum passing margin is -1.5dB at 2629.60MHz.
15.407(a)(1/2/3)	Max Average Transmit Power	PASS	Meet the requirement of limit.
15.407(a)(1/2/3)	Peak Power Spectral Density	PASS	Meet the requirement of limit.
15.407(e)	6dB bandwidth	PASS	Meet the requirement of limit. (U-NII-3 Band only)
15.407(g)	Frequency Stability	PASS	Meet the requirement of limit.
15.203	Antenna Requirement	PASS	No antenna connector is used.

3 General Information

3.1 General Description of EUT

Product	Nighthawk X4 AC2200 WiFi Range Extender
Brand	NETGEAR
Test Model	EX7300
Sample Status	Engineering sample
Power Supply Rating	100-240Vac
Modulation Type	256QAM, 64QAM, 16QAM, QPSK, BPSK
Modulation Technology	OFDM
Transfer Rate	802.11a: 54/48/36/24/18/12/9/6Mbps 802.11n: up to 600Mbps 802.11ac: up to 1733Mbps
Operating Frequency	5745 ~ 5825MHz
Number of Channel	5745 ~ 5825MHz: 5 for 802.11a, 802.11n (HT20), 802.11ac (VHT20) 2 for 802.11n (HT40), 802.11ac (VHT40) 1 for 802.11ac (VHT80)
Output Power	CDD Mode: 5745 ~ 5825MHz: 758.319mW Beamforming Mode: 5745 ~ 5825MHz: 445.274mW
Antenna Type	Refer to Note
Antenna Connector	Refer to Note
Accessory Device	NA
Data Cable Supplied	NA

Note:

1. This report is prepared for FCC class II permissive change. The difference compared with the original report (BV ADT report no.: RF160205C08-1) is updating U-NII-3 Band to new rule. All test items except radiated emission below 1GHz and conducted emission had been tested for this addendum and the other original test data was kept in this report.
2. The EUT incorporates a MIMO function. Physically, the EUT provides 4 completed transmitters and 4 receivers.

Band	Modulation Mode	Beamforming Mode	TX Function
2.4GHz	802.11b	Not Support	3TX
	802.11g	Not Support	3TX
	802.11n (HT20)	Not Support	3TX
	802.11n (HT40)	Not Support	3TX
5GHz	802.11a	Not Support	4TX
	802.11n (HT20)	Support	4TX
	802.11n (HT40)	Support	4TX
	802.11ac (VHT20)	Support	4TX
	802.11ac (VHT40)	Support	4TX
	802.11ac (VHT80)	Support	4TX

* The modulation and bandwidth are similar for 802.11n mode for 20MHz/40MHz and 802.11ac mode for 20MHz/40MHz, therefore investigated worst case to representative mode in test report. (Final test mode refer section 3.2.1)

* For 5GHz band 802.11n and 802.11ac, CDD mode is the worst case for final power line conducted emission test after pretesting CDD mode and beamforming mode.

3. The EUT uses following antennas.

Antenna Type	Chain 0/1/2: PIFA, Chain 3: PCB										Antenna Connector	NA					
Antenna Gain (dBi)																	
Chain	Frequency (MHz)																
	2412	2422	2437	2452	2462	5180	5200	5240	5190	5230	5210	5745	5785	5825	5755	5795	5775
0	2.5	2.5	3	3.5	4	1.7	2.2	2.5	1.9	2.2	2.2	3.7	4	4	3.9	4	4
1	1.5	1.7	2.1	2.3	2.4	3.6	3.6	3.8	3.6	3.7	3.7	4	4.2	4.1	4.1	4.2	4.2
2	3.1	3.3	3.6	4	4	2.6	2.7	3.1	2.6	3	3	2.5	2.9	3.1	2.5	3	2.9
3	-	-	-	-	-	2.3	2.4	2.5	2.3	2.5	2.4	3.2	3	3.2	3.2	3.1	3

3.2 Description of Test Modes

FOR 5745 ~ 5825MHz:

5 channels are provided for 802.11a, 802.11n (HT20), 802.11ac (VHT20):

Channel	Frequency	Channel	Frequency
149	5745MHz	161	5805MHz
153	5765MHz	165	5825MHz
157	5785MHz		

2 channels are provided for 802.11n (HT40), 802.11ac (VHT40):

Channel	Frequency	Channel	Frequency
151	5755MHz	159	5795MHz

1 channel is provided for 802.11ac (VHT80):

Channel	Frequency
155	5775MHz

3.2.1 Test Mode Applicability and Tested Channel Detail

EUT Configure Mode	Applicable to				Description
	RE \geq 1G	RE<1G	PLC	APCM	
-	√	√	√	√	-

Where RE \geq 1G: Radiated Emission above 1GHz & Bandedge Measurement
 RE<1G: Radiated Emission below 1GHz
 PLC: Power Line Conducted Emission
 APCM: Antenna Port Conducted Measurement

Note: The EUT had been pre-tested on the positioned of each 3 axis. The worst case was found when positioned on Z-plane.

Radiated Emission Test (Above 1GHz):

- Pre-Scan has been conducted to determine the worst-case mode from all possible combinations between available modulations, data rates and antenna ports (if EUT with antenna diversity architecture).
- Following channel(s) was (were) selected for the final test as listed below.

EUT CONFIGURE MODE	MODE	FREQ. BAND (MHz)	AVAILABLE CHANNEL	TESTED CHANNEL	MODULATION TECHNOLOGY	MODULATION TYPE	DATA RATE (Mbps)
-	802.11a	5745-5825	149 to 165	149, 157, 165	OFDM	BPSK	6.0
-	802.11ac (VHT20)		149 to 165	149, 157, 165	OFDM	BPSK	7.2
-	802.11ac (VHT40)		151 to 159	151, 159	OFDM	BPSK	15.0
-	802.11ac (VHT80)		155	155	OFDM	BPSK	130.0

Radiated Emission Test (Below 1GHz):

- Pre-Scan has been conducted to determine the worst-case mode from all possible combinations between available modulations, data rates and antenna ports (if EUT with antenna diversity architecture).
- Following channel(s) was (were) selected for the final test as listed below.

EUT CONFIGURE MODE	MODE	FREQ. BAND (MHz)	AVAILABLE CHANNEL	TESTED CHANNEL	MODULATION TECHNOLOGY	MODULATION TYPE	DATA RATE (Mbps)
-	802.11a	5745-5825	149 to 165	157	OFDM	BPSK	6.0

Power Line Conducted Emission Test:

- Pre-Scan has been conducted to determine the worst-case mode from all possible combinations between available modulations, data rates and antenna ports (if EUT with antenna diversity architecture).
- Following channel(s) was (were) selected for the final test as listed below.

EUT CONFIGURE MODE	MODE	FREQ. BAND (MHz)	AVAILABLE CHANNEL	TESTED CHANNEL	MODULATION TECHNOLOGY	MODULATION TYPE	DATA RATE (Mbps)
-	802.11a	5745-5825	149 to 165	157	OFDM	BPSK	6.0

Antenna Port Conducted Measurement:

- This item includes all test value of each mode, but only includes spectrum plot of worst value of each mode.
- Pre-Scan has been conducted to determine the worst-case mode from all possible combinations between available modulations, data rates and antenna ports (if EUT with antenna diversity architecture).
- Following channel(s) was (were) selected for the final test as listed below.

EUT CONFIGURE MODE	MODE	FREQ. BAND (MHz)	AVAILABLE CHANNEL	TESTED CHANNEL	MODULATION TECHNOLOGY	MODULATION TYPE	DATA RATE (Mbps)
-	802.11a	5745-5825	149 to 165	149, 157, 165	OFDM	BPSK	6.0
-	802.11ac (VHT20)		149 to 165	149, 157, 165	OFDM	BPSK	7.2
-	802.11ac (VHT40)		151 to 159	151, 159	OFDM	BPSK	15.0
-	802.11ac (VHT80)		155	155	OFDM	BPSK	130.0

Test Condition:

Applicable to	Environmental Conditions	Input Power	Tested by
RE \geq 1G	23 deg. C, 64% RH 24 deg. C, 67% RH	120Vac, 60Hz	Chris Lin
RE<1G	23 deg. C, 64% RH	120Vac, 60Hz	Chris Lin
PLC	24 deg. C, 64% RH	120Vac, 60Hz	Chris Lin
APCM	25 deg. C, 60% RH	120Vac, 60Hz	Leo Tsai

3.3 Duty Cycle of Test Signal

CDD Mode

802.11ac (VHT20): Duty cycle of test signal is $\geq 98\%$, duty factor is not required.

802.11a, 802.11ac (VHT40), 802.11ac (VHT80): Duty cycle of test signal is $< 98\%$, duty factor shall be considered.

802.11a: Duty cycle = $2.025/2.095 = 0.967$, Duty factor = $10 * \log(1/0.967) = 0.15$

802.11ac (VHT20): Duty cycle = $5/5.075 = 0.985$

802.11ac (VHT40): Duty cycle = $2.407/2.482 = 0.969$, Duty factor = $10 * \log(1/0.969) = 0.14$

802.11ac (VHT80): Duty cycle = $1.13/1.212 = 0.932$, Duty factor = $10 * \log(1/0.932) = 0.30$

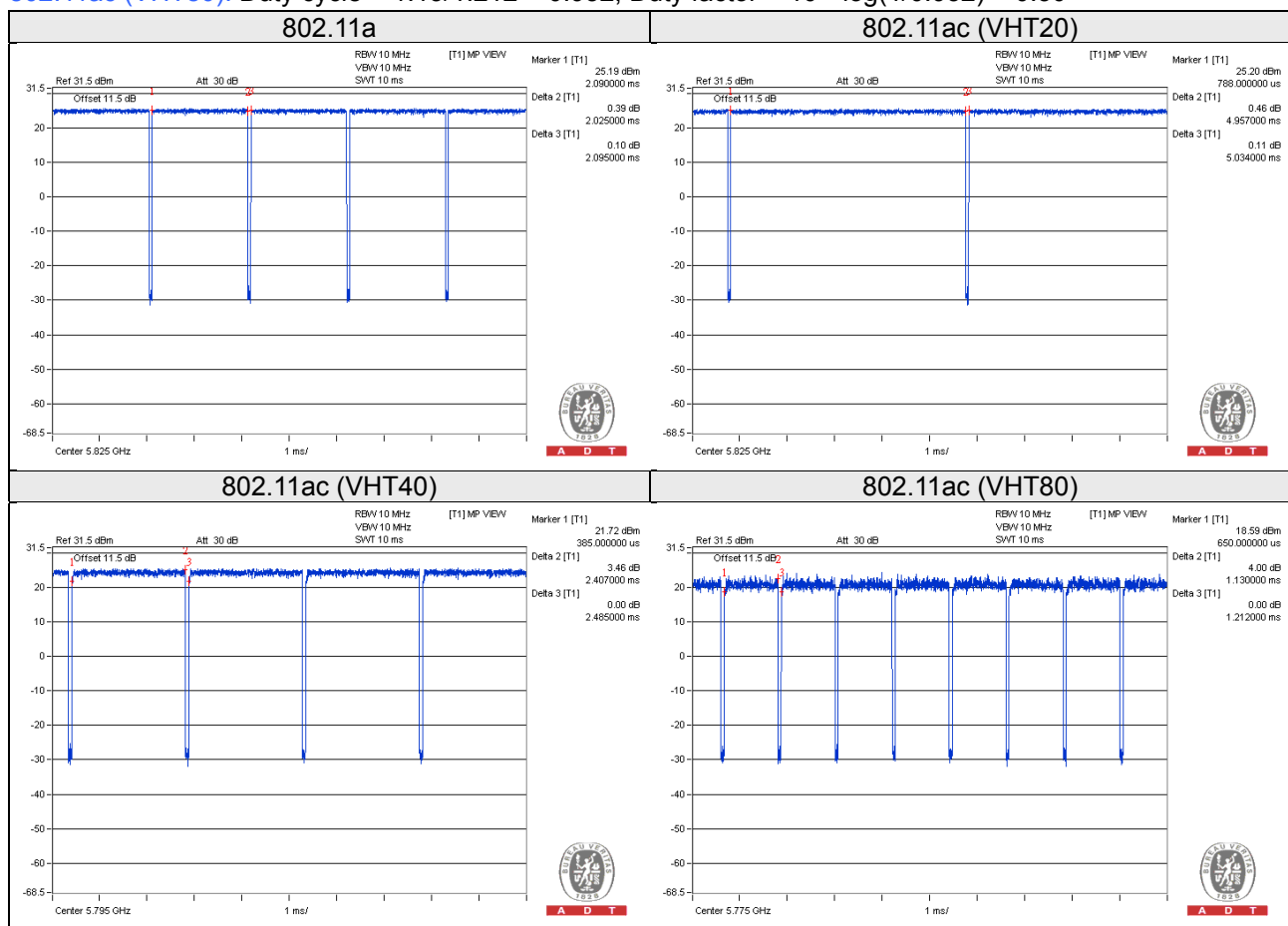

Beamforming Mode

802.11ac (VHT20): Duty cycle of test signal is $\geq 98\%$, duty factor is not required.

802.11ac (VHT40), 802.11ac (VHT80): Duty cycle of test signal is $< 98\%$, duty factor shall be considered.

802.11ac (VHT20): Duty cycle = $4.969/5.059 = 0.982$

802.11ac (VHT40): Duty cycle = $2.415/2.483 = 0.973$, Duty factor = $10 * \log(1/0.973) = 0.12$

802.11ac (VHT80): Duty cycle = $1.132/1.202 = 0.942$, Duty factor = $10 * \log(1/0.942) = 0.26$



3.4 Description of Support Units

The EUT has been tested as an independent unit together with other necessary accessories or support units. The following support units or accessories were used to form a representative test configuration during the tests.

ID	Product	Brand	Model No.	Serial No.	FCC ID	Remarks
A.	Notebook	DELL	E5410	BPQ7MQ1	FCC DoC Approved	-

Note:

1. All power cords of the above support units are non-shielded (1.8m).
2. Item A acted as a communication partner to transfer data.

ID	Descriptions	Qty.	Length (m)	Shielding (Yes/No)	Cores (Qty.)	Remarks
1.	RJ45	1	5	N	0	-

3.4.1 Configuration of System under Test

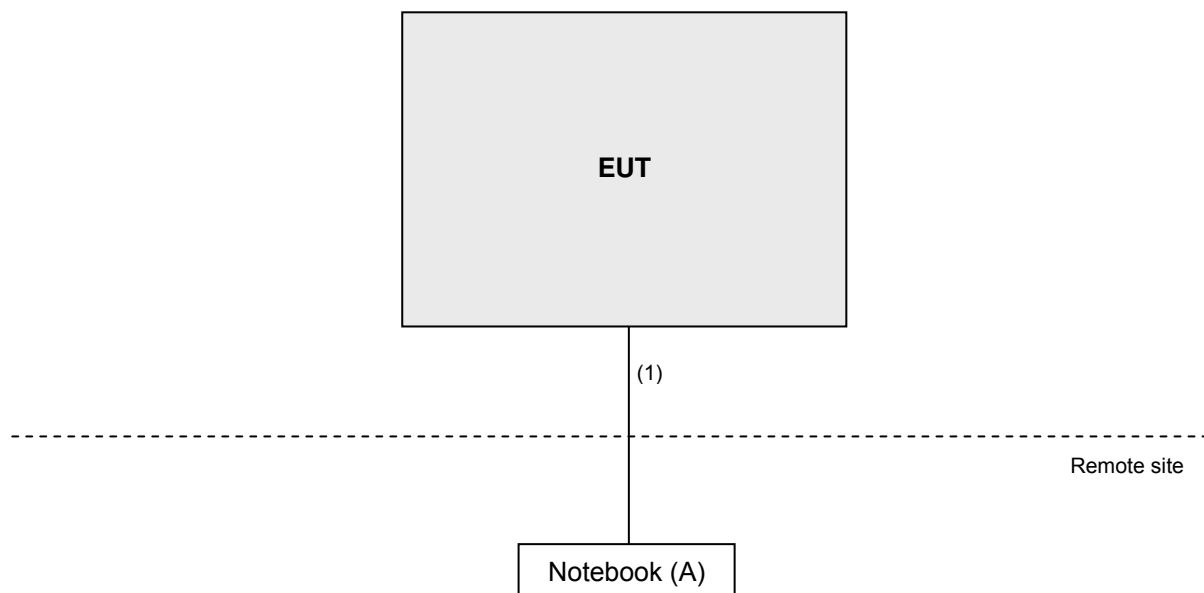

3.5 General Description of Applied Standard

The EUT is a RF Product. According to the specifications of the manufacturer, it must comply with the requirements of the following standards:

FCC Part 15, Subpart E (15.407)
789033 D02 General UNII Test Procedures New Rules v01r02
662911 D01 Multiple Transmitter Output v02r01
 ANSI C63.10:2013

All test items have been performed and recorded as per the above standards.

Note: The EUT has been verified to comply with the requirements of FCC Part 15, Subpart B, Class B (DoC). The test report has been issued separately.

4 Test Types and Results

4.1 Radiated Emission and Bandedge Measurement

4.1.1 Limits of Radiated Emission and Bandedge Measurement

Radiated emissions which fall in the restricted bands must comply with the radiated emission limits specified as below table.

Frequencies (MHz)	Field Strength (microvolts/meter)	Measurement Distance (meters)
0.009 ~ 0.490	2400/F(kHz)	300
0.490 ~ 1.705	24000/F(kHz)	30
1.705 ~ 30.0	30	30
30 ~ 88	100	3
88 ~ 216	150	3
216 ~ 960	200	3
Above 960	500	3

NOTE:

1. The lower limit shall apply at the transition frequencies.
2. Emission level (dBuV/m) = 20 log Emission level (uV/m).
3. For frequencies above 1000MHz, the field strength limits are based on average detector, however, the peak field strength of any emission shall not exceed the maximum permitted average limits, specified above by more than 20dB under any condition of modulation.

Limits of Unwanted Emission Out of The Restricted Bands

Applicable To	Limit	
789033 D02 General UNII Test Procedures New Rules v01r02	Field Strength at 3m	
	PK:74 (dBµV/m)	AV:54 (dBµV/m)
Applicable To	EIRP Limit	Equivalent Field Strength at 3m
15.407(b)(1)	PK: -27 (dBm/MHz)	PK: 68.2 (dBµV/m)
15.407(b)(2)		
15.407(b)(3)		
15.407(b)(4)(i)	PK: -27 (dBm/MHz) ^{*1} PK: 10 (dBm/MHz) ^{*2} PK: 15.6 (dBm/MHz) ^{*3} PK: 27 (dBm/MHz) ^{*4}	PK: 68.2 (dBµV/m) ^{*1} PK: 105.2 (dBµV/m) ^{*2} PK: 110.8 (dBµV/m) ^{*3} PK: 122.2 (dBµV/m) ^{*4}
15.407(b)(4)(ii)	Field Strength at 3m / § 15.247(d)	
	PK: 74 (dBµV/m)	AV: 54 (dBµV/m)
^{*1} beyond 75 MHz or more above of the band edge.		^{*2} below the band edge increasing linearly to 10 dBm/MHz at 25 MHz above.
^{*3} below the band edge increasing linearly to a level of 15.6 dBm/MHz at 5 MHz above.		^{*4} from 5 MHz above or below the band edge increasing linearly to a level of 27 dBm/MHz at the band edge.

NOTE: The following formula is used to convert the equipment isotropic radiated power (eirp) to field strength:

$$E = \frac{1000000 \sqrt{30P}}{3} \quad \mu\text{V/m, where P is the eirp (Watts).$$

4.1.2 Test Instruments

Description & Manufacturer	Model No.	Serial No.	Cal. Date	Cal. Due
Test Receiver ROHDE & SCHWARZ	ESCI	100424	Oct. 12, 2015	Oct. 11, 2016
Spectrum Analyzer ROHDE & SCHWARZ	FSP40	100040	Jul. 08, 2015	Jul. 07, 2016
BILOG Antenna SCHWARZBECK	VULB9168	9168-155	Jan. 07, 2016	Jan. 06, 2017
HORN Antenna SCHWARZBECK	BBHA 9120D	9120D-1170	Jan. 08, 2016	Jan. 07, 2017
HORN Antenna SCHWARZBECK	BBHA 9170	BBHA9170241	Jan. 18, 2016	Jan. 17, 2017
Preamplifier Agilent	8449B	3008A01960	Aug. 09, 2015	Aug. 08, 2016
Preamplifier Agilent	8447D	2944A10631	Aug. 09, 2015	Aug. 08, 2016
RF signal cable HUBER+SUHNER	SUCOFLEX 104	Cable-CH4-02(295012+309220)	Aug. 09, 2015	Aug. 08, 2016
RF signal cable HUBER+SUHNER	SUCOFLEX 104	Cable-CH4-03(250724)	Aug. 09, 2015	Aug. 08, 2016
Software BV ADT	ADT_Radiated_V7.6.15.9.4	NA	NA	NA
Antenna Tower inn-co GmbH	MA 4000	010303	NA	NA
Antenna Tower Controller BV ADT	AT100	AT93021703	NA	NA
Turn Table BV ADT	TT100	TT93021703	NA	NA
Turn Table Controller BV ADT	SC100.	SC93021703	NA	NA
26GHz ~ 40GHz Amplifier	EM26400	815221	Oct. 18, 2015	Oct. 17, 2016
High Speed Peak Power Meter	ML2495A	0824011	Jul. 09, 2015	Jul. 08, 2016
Power Sensor	MA2411B	0738171	Jul. 09, 2015	Jul. 08, 2016

- Note:
1. The calibration interval of the above test instruments is 12 months and the calibrations are traceable to NML/ROC and NIST/USA.
 2. The test was performed in HwaYa Chamber 4.
 3. The horn antenna and preamplifier (model: 8449B) are used only for the measurement of emission frequency above 1GHz if tested.
 4. The FCC Site Registration No. is 460141.
 5. The IC Site Registration No. is IC7450F-4.

4.1.3 Test Procedure

- a. The EUT was placed on the top of a rotating table 0.8 meters (for below 1GHz) / 1.5 meters (for above 1GHz) above the ground at 3 meter chamber room for test. The table was rotated 360 degrees to determine the position of the highest radiation.
- b. The EUT was set 3 meters away from the interference-receiving antenna, which was mounted on the top of a variable-height antenna tower.
- c. The height of antenna is varied from one meter to four meters above the ground to determine the maximum value of the field strength. Both horizontal and vertical polarizations of the antenna are set to make the measurement.
- d. For each suspected emission, the EUT was arranged to its worst case and then the antenna was tuned to heights from 1 meter to 4 meters and the rotatable table was turned from 0 degrees to 360 degrees to find the maximum reading.
- e. The test-receiver system was set to quasi-peak detect function and specified bandwidth with maximum hold mode when the test frequency is below 1 GHz.
- f. The test-receiver system was set to peak and average detect function and specified bandwidth with maximum hold mode when the test frequency is above 1 GHz. If the peak reading value also meets average limit, measurement with the average detector is unnecessary.

Note:

1. The resolution bandwidth and video bandwidth of test receiver/spectrum analyzer is 120kHz for Quasi-peak detection (QP) at frequency below 1GHz.
2. The resolution bandwidth of test receiver/spectrum analyzer is 1 MHz and the video bandwidth is 3 MHz for Peak detection (PK) at frequency above 1GHz.
3. The resolution bandwidth of test receiver/spectrum analyzer is 1MHz and the video bandwidth is 3MHz for RMS Average (Duty cycle < 98%) for Average detection (AV) at frequency above 1GHz, then the measurement results was added to a correction factor ($10 \log(1/\text{duty cycle})$).
4. The resolution bandwidth of test receiver/spectrum analyzer is 1MHz and the video bandwidth is 10Hz (Duty cycle \geq 98%) for Average detection (AV) at frequency above 1GHz.
5. All modes of operation were investigated and the worst-case emissions are reported.

4.1.4 Deviation from Test Standard

No deviation.

4.1.5 Test Setup

<Frequency Range 30MHz~1GHz>

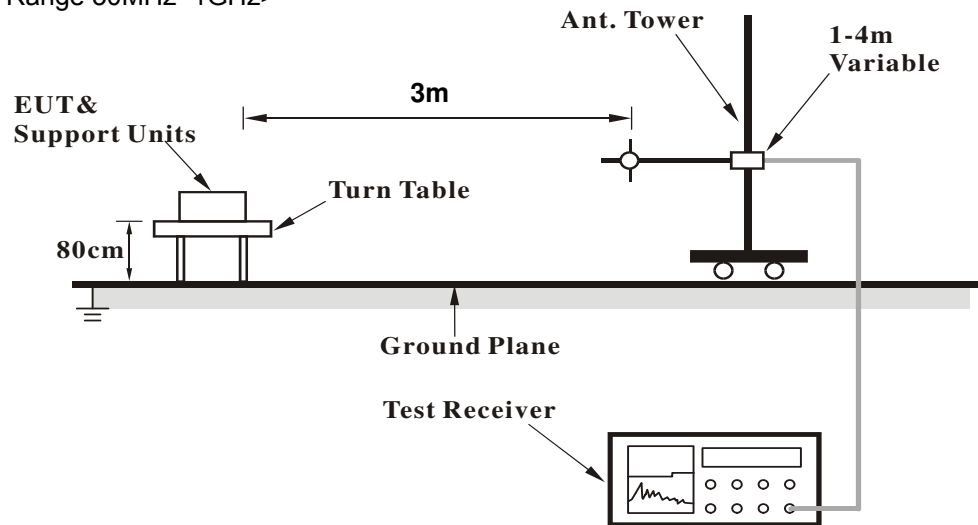

<Frequency Range above 1GHz>

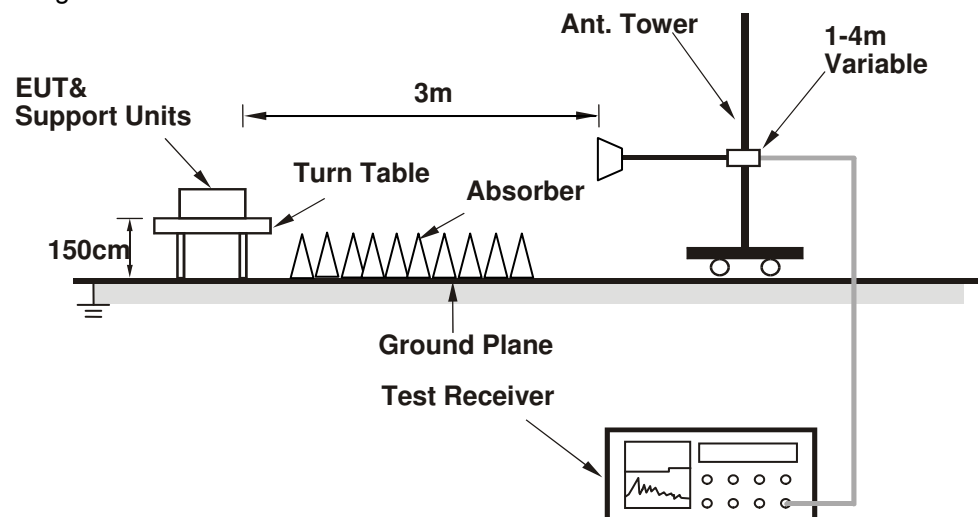

For the actual test configuration, please refer to the attached file (Test Setup Photo).

4.1.6 EUT Operating Conditions

- Placed the EUT on the testing table.
- Prepared a notebook to act as a communication partner and placed it outside of testing area.
- The communication partner connected with EUT via a RJ45 cable and ran a test program (provided by manufacturer) to enable EUT under transmission condition continuously at specific channel frequency.
- The communication partner sent data to EUT by command "PING".
- The necessary accessories enable the system in full functions.

4.1.7 Test Results

Above 1GHz Data:

CDD Mode

CHANNEL	TX Channel 149	DETECTOR FUNCTION	Peak (PK) Average (AV)
FREQUENCY RANGE	1GHz ~ 40GHz		

ANTENNA POLARITY & TEST DISTANCE: HORIZONTAL AT 3 M

NO.	FREQ. (MHz)	EMISSION LEVEL (dBuV/m)	LIMIT (dBuV/m)	MARGIN (dB)	ANTENNA HEIGHT (m)	TABLE ANGLE (Degree)	RAW VALUE (dBuV)	CORRECTION FACTOR (dB/m)
1	#5627.20	58.7 PK	68.2	-9.5	1.00 H	118	52.6	6.1
2	*5745.00	118.9 PK			1.00 H	118	78.5	40.4
3	*5745.00	108.8 AV			1.00 H	118	68.4	40.4
4	#5940.80	59.2 PK	68.2	-9.0	1.00 H	118	52.5	6.7
5	11490.00	61.8 PK	74.0	-12.2	1.10 H	180	42.5	19.3
6	11490.00	48.9 AV	54.0	-5.1	1.10 H	180	29.6	19.3

ANTENNA POLARITY & TEST DISTANCE: VERTICAL AT 3 M

NO.	FREQ. (MHz)	EMISSION LEVEL (dBuV/m)	LIMIT (dBuV/m)	MARGIN (dB)	ANTENNA HEIGHT (m)	TABLE ANGLE (Degree)	RAW VALUE (dBuV)	CORRECTION FACTOR (dB/m)
1	#5624.80	58.9 PK	68.2	-9.3	1.56 V	345	52.8	6.1
2	*5745.00	115.9 PK			1.56 V	345	75.5	40.4
3	*5745.00	105.7 AV			1.56 V	345	65.3	40.4
4	#5971.20	58.8 PK	68.2	-9.4	1.56 V	345	52.1	6.7
5	11490.00	61.1 PK	74.0	-12.9	1.13 V	287	41.8	19.3
6	11490.00	48.7 AV	54.0	-5.3	1.13 V	287	29.4	19.3

Remarks:

1. Emission Level(dBuV/m) = Raw Value(dBuV) + Correction Factor(dB/m)
2. Correction Factor(dB/m) = Antenna Factor(dB/m) + Cable Factor(dB)
3. The other emission levels were very low against the limit.
4. Margin value = Emission Level – Limit value
5. " * ": Fundamental frequency.
6. " # ": The radiated frequency is out of the restricted band.

CHANNEL	TX Channel 157	DETECTOR FUNCTION	Peak (PK)
FREQUENCY RANGE	1GHz ~ 40GHz		Average (AV)

ANTENNA POLARITY & TEST DISTANCE: HORIZONTAL AT 3 M

NO.	FREQ. (MHz)	EMISSION LEVEL (dBuV/m)	LIMIT (dBuV/m)	MARGIN (dB)	ANTENNA HEIGHT (m)	TABLE ANGLE (Degree)	RAW VALUE (dBuV)	CORRECTION FACTOR (dB/m)
1	*5785.00	118.0 PK			1.00 H	120	77.5	40.5
2	*5785.00	108.6 AV			1.00 H	120	68.1	40.5
3	11570.00	61.5 PK	74.0	-12.5	1.10 H	85	42.5	19.0
4	11570.00	48.2 AV	54.0	-5.8	1.10 H	85	29.2	19.0

ANTENNA POLARITY & TEST DISTANCE: VERTICAL AT 3 M

NO.	FREQ. (MHz)	EMISSION LEVEL (dBuV/m)	LIMIT (dBuV/m)	MARGIN (dB)	ANTENNA HEIGHT (m)	TABLE ANGLE (Degree)	RAW VALUE (dBuV)	CORRECTION FACTOR (dB/m)
1	*5785.00	115.8 PK			1.15 V	61	75.3	40.5
2	*5785.00	105.3 AV			1.15 V	61	64.8	40.5
3	11570.00	61.2 PK	74.0	-12.8	1.08 V	84	42.2	19.0
4	11570.00	48.0 AV	54.0	-6.0	1.08 V	84	29.0	19.0

Remarks:

1. Emission Level(dBuV/m) = Raw Value(dBuV) + Correction Factor(dB/m)
2. Correction Factor(dB/m) = Antenna Factor(dB/m) + Cable Factor(dB)
3. The other emission levels were very low against the limit.
4. Margin value = Emission Level – Limit value
5. " * ": Fundamental frequency.
6. " # ": The radiated frequency is out of the restricted band.

CHANNEL	TX Channel 165	DETECTOR FUNCTION	Peak (PK)
FREQUENCY RANGE	1GHz ~ 40GHz		Average (AV)

ANTENNA POLARITY & TEST DISTANCE: HORIZONTAL AT 3 M

NO.	FREQ. (MHz)	EMISSION LEVEL (dBuV/m)	LIMIT (dBuV/m)	MARGIN (dB)	ANTENNA HEIGHT (m)	TABLE ANGLE (Degree)	RAW VALUE (dBuV)	CORRECTION FACTOR (dB/m)
1	#5633.60	58.9 PK	68.2	-9.3	1.00 H	121	52.8	6.1
2	*5825.00	118.2 PK			1.00 H	121	77.6	40.6
3	*5825.00	107.8 AV			1.00 H	121	67.2	40.6
4	#5960.00	58.4 PK	68.2	-9.8	1.00 H	121	51.7	6.7
5	11650.00	61.0 PK	74.0	-13.0	1.10 H	163	42.5	18.5
6	11650.00	47.4 AV	54.0	-6.6	1.10 H	163	28.9	18.5

ANTENNA POLARITY & TEST DISTANCE: VERTICAL AT 3 M

NO.	FREQ. (MHz)	EMISSION LEVEL (dBuV/m)	LIMIT (dBuV/m)	MARGIN (dB)	ANTENNA HEIGHT (m)	TABLE ANGLE (Degree)	RAW VALUE (dBuV)	CORRECTION FACTOR (dB/m)
1	#5647.20	58.9 PK	68.2	-9.3	1.07 V	59	52.8	6.1
2	*5825.00	115.8 PK			1.07 V	59	75.2	40.6
3	*5825.00	105.1 AV			1.07 V	59	64.5	40.6
4	#5956.80	58.9 PK	68.2	-9.3	1.07 V	59	52.2	6.7
5	11650.00	60.6 PK	74.0	-13.4	1.12 V	106	42.1	18.5
6	11650.00	47.1 AV	54.0	-6.9	1.12 V	106	28.6	18.5

Remarks:

1. Emission Level(dBuV/m) = Raw Value(dBuV) + Correction Factor(dB/m)
2. Correction Factor(dB/m) = Antenna Factor(dB/m) + Cable Factor(dB)
3. The other emission levels were very low against the limit.
4. Margin value = Emission Level – Limit value
5. " * ": Fundamental frequency.
6. " # ": The radiated frequency is out of the restricted band.

802.11ac (VHT20)

CHANNEL	TX Channel 149	DETECTOR FUNCTION	Peak (PK)
FREQUENCY RANGE	1GHz ~ 40GHz		Average (AV)

ANTENNA POLARITY & TEST DISTANCE: HORIZONTAL AT 3 M								
NO.	FREQ. (MHz)	EMISSION LEVEL (dBuV/m)	LIMIT (dBuV/m)	MARGIN (dB)	ANTENNA HEIGHT (m)	TABLE ANGLE (Degree)	RAW VALUE (dBuV)	CORRECTION FACTOR (dB/m)
1	#5611.20	58.5 PK	68.2	-9.7	1.03 H	120	52.5	6.0
2	*5745.00	118.9 PK			1.03 H	120	78.5	40.4
3	*5745.00	108.0 AV			1.03 H	120	67.6	40.4
4	#5968.80	59.2 PK	68.2	-9.0	1.03 H	120	52.5	6.7
5	11490.00	61.1 PK	74.0	-12.9	1.08 H	89	41.8	19.3
6	11490.00	47.8 AV	54.0	-6.2	1.08 H	89	28.5	19.3

ANTENNA POLARITY & TEST DISTANCE: VERTICAL AT 3 M								
NO.	FREQ. (MHz)	EMISSION LEVEL (dBuV/m)	LIMIT (dBuV/m)	MARGIN (dB)	ANTENNA HEIGHT (m)	TABLE ANGLE (Degree)	RAW VALUE (dBuV)	CORRECTION FACTOR (dB/m)
1	#5613.60	59.9 PK	68.2	-8.3	1.10 V	60	53.8	6.1
2	*5745.00	115.4 PK			1.10 V	60	75.0	40.4
3	*5745.00	104.9 AV			1.10 V	60	64.5	40.4
4	#5928.00	59.2 PK	68.2	-9.0	1.10 V	60	52.5	6.7
5	11490.00	60.8 PK	74.0	-13.2	1.00 V	42	41.5	19.3
6	11490.00	47.6 AV	54.0	-6.4	1.00 V	42	28.3	19.3

Remarks:

1. Emission Level(dBuV/m) = Raw Value(dBuV) + Correction Factor(dB/m)
2. Correction Factor(dB/m) = Antenna Factor(dB/m) + Cable Factor(dB)
3. The other emission levels were very low against the limit.
4. Margin value = Emission Level – Limit value
5. " * ": Fundamental frequency.
6. " # ": The radiated frequency is out of the restricted band.

CHANNEL	TX Channel 157	DETECTOR FUNCTION	Peak (PK)
FREQUENCY RANGE	1GHz ~ 40GHz		Average (AV)

ANTENNA POLARITY & TEST DISTANCE: HORIZONTAL AT 3 M

NO.	FREQ. (MHz)	EMISSION LEVEL (dBuV/m)	LIMIT (dBuV/m)	MARGIN (dB)	ANTENNA HEIGHT (m)	TABLE ANGLE (Degree)	RAW VALUE (dBuV)	CORRECTION FACTOR (dB/m)
1	*5785.00	119.4 PK			1.20 H	121	78.9	40.5
2	*5785.00	109.0 AV			1.20 H	121	68.5	40.5
3	11570.00	61.7 PK	74.0	-12.3	1.00 H	147	42.7	19.0
4	11570.00	47.7 AV	54.0	-6.3	1.00 H	147	28.7	19.0

ANTENNA POLARITY & TEST DISTANCE: VERTICAL AT 3 M

NO.	FREQ. (MHz)	EMISSION LEVEL (dBuV/m)	LIMIT (dBuV/m)	MARGIN (dB)	ANTENNA HEIGHT (m)	TABLE ANGLE (Degree)	RAW VALUE (dBuV)	CORRECTION FACTOR (dB/m)
1	*5785.00	116.2 PK			1.16 V	60	75.7	40.5
2	*5785.00	105.6 AV			1.16 V	60	65.1	40.5
3	11570.00	61.4 PK	74.0	-12.6	1.00 V	104	42.4	19.0
4	11570.00	47.4 AV	54.0	-6.6	1.00 V	104	28.4	19.0

Remarks:

1. Emission Level(dBuV/m) = Raw Value(dBuV) + Correction Factor(dB/m)
2. Correction Factor(dB/m) = Antenna Factor(dB/m) + Cable Factor(dB)
3. The other emission levels were very low against the limit.
4. Margin value = Emission Level – Limit value
5. " * ": Fundamental frequency.
6. " # ": The radiated frequency is out of the restricted band.

CHANNEL	TX Channel 165	DETECTOR FUNCTION	Peak (PK)
FREQUENCY RANGE	1GHz ~ 40GHz		Average (AV)

ANTENNA POLARITY & TEST DISTANCE: HORIZONTAL AT 3 M

NO.	FREQ. (MHz)	EMISSION LEVEL (dBuV/m)	LIMIT (dBuV/m)	MARGIN (dB)	ANTENNA HEIGHT (m)	TABLE ANGLE (Degree)	RAW VALUE (dBuV)	CORRECTION FACTOR (dB/m)
1	#5613.60	58.9 PK	68.2	-9.3	1.23 H	123	52.8	6.1
2	*5825.00	119.5 PK			1.23 H	123	78.9	40.6
3	*5825.00	108.7 AV			1.23 H	123	68.1	40.6
4	#5953.60	59.2 PK	68.2	-9.0	1.23 H	123	52.5	6.7
5	11650.00	60.5 PK	74.0	-13.5	1.00 H	164	42.0	18.5
6	11650.00	47.4 AV	54.0	-6.6	1.00 H	164	28.9	18.5

ANTENNA POLARITY & TEST DISTANCE: VERTICAL AT 3 M

NO.	FREQ. (MHz)	EMISSION LEVEL (dBuV/m)	LIMIT (dBuV/m)	MARGIN (dB)	ANTENNA HEIGHT (m)	TABLE ANGLE (Degree)	RAW VALUE (dBuV)	CORRECTION FACTOR (dB/m)
1	#5604.80	58.7 PK	68.2	-9.5	1.15 V	59	52.8	5.9
2	*5825.00	115.0 PK			1.15 V	59	74.4	40.6
3	*5825.00	104.5 AV			1.15 V	59	63.9	40.6
4	#5952.00	59.6 PK	68.2	-8.6	1.15 V	59	52.9	6.7
5	11650.00	60.3 PK	74.0	-13.7	1.00 V	24	41.8	18.5
6	11650.00	47.0 AV	54.0	-7.0	1.00 V	24	28.5	18.5

Remarks:

1. Emission Level(dBuV/m) = Raw Value(dBuV) + Correction Factor(dB/m)
2. Correction Factor(dB/m) = Antenna Factor(dB/m) + Cable Factor(dB)
3. The other emission levels were very low against the limit.
4. Margin value = Emission Level – Limit value
5. " * ": Fundamental frequency.
6. " # ": The radiated frequency is out of the restricted band.

802.11ac (VHT40)

CHANNEL	TX Channel 151	DETECTOR FUNCTION	Peak (PK)
FREQUENCY RANGE	1GHz ~ 40GHz		Average (AV)

ANTENNA POLARITY & TEST DISTANCE: HORIZONTAL AT 3 M								
NO.	FREQ. (MHz)	EMISSION LEVEL (dBuV/m)	LIMIT (dBuV/m)	MARGIN (dB)	ANTENNA HEIGHT (m)	TABLE ANGLE (Degree)	RAW VALUE (dBuV)	CORRECTION FACTOR (dB/m)
1	#5602.40	58.9 PK	68.2	-9.3	1.04 H	117	53.0	5.9
2	*5755.00	116.3 PK			1.04 H	117	75.8	40.5
3	*5755.00	107.4 AV			1.04 H	117	66.9	40.5
4	#5957.60	58.8 PK	68.2	-9.4	1.04 H	117	52.1	6.7
5	11510.00	61.0 PK	74.0	-13.0	1.10 H	69	41.9	19.1
6	11510.00	48.3 AV	54.0	-5.7	1.10 H	69	29.2	19.1
ANTENNA POLARITY & TEST DISTANCE: VERTICAL AT 3 M								
NO.	FREQ. (MHz)	EMISSION LEVEL (dBuV/m)	LIMIT (dBuV/m)	MARGIN (dB)	ANTENNA HEIGHT (m)	TABLE ANGLE (Degree)	RAW VALUE (dBuV)	CORRECTION FACTOR (dB/m)
1	#5612.00	59.5 PK	68.2	-8.7	2.81 V	176	53.5	6.0
2	*5755.00	114.1 PK			2.81 V	176	73.6	40.5
3	*5755.00	108.8 AV			2.81 V	176	68.3	40.5
4	#5970.40	59.3 PK	68.2	-8.9	2.81 V	176	52.6	6.7
5	11510.00	61.2 PK	74.0	-12.8	1.00 V	224	42.1	19.1
6	11510.00	47.9 AV	54.0	-6.1	1.00 V	224	28.8	19.1

Remarks:

1. Emission Level(dBuV/m) = Raw Value(dBuV) + Correction Factor(dB/m)
2. Correction Factor(dB/m) = Antenna Factor(dB/m) + Cable Factor(dB)
3. The other emission levels were very low against the limit.
4. Margin value = Emission Level – Limit value
5. " * ": Fundamental frequency.
6. " # ": The radiated frequency is out of the restricted band.

CHANNEL	TX Channel 159	DETECTOR FUNCTION	Peak (PK)
FREQUENCY RANGE	1GHz ~ 40GHz		Average (AV)

ANTENNA POLARITY & TEST DISTANCE: HORIZONTAL AT 3 M

NO.	FREQ. (MHz)	EMISSION LEVEL (dBuV/m)	LIMIT (dBuV/m)	MARGIN (dB)	ANTENNA HEIGHT (m)	TABLE ANGLE (Degree)	RAW VALUE (dBuV)	CORRECTION FACTOR (dB/m)
1	#5608.00	58.4 PK	68.2	-9.8	1.27 H	120	52.4	6.0
2	*5795.00	116.4 PK			1.27 H	120	75.9	40.5
3	*5795.00	106.1 AV			1.27 H	120	65.6	40.5
4	#5929.60	59.3 PK	68.2	-8.9	1.27 H	120	52.6	6.7
5	11590.00	61.4 PK	74.0	-12.6	1.00 H	155	42.7	18.7
6	11590.00	47.7 AV	54.0	-6.3	1.00 H	155	29.0	18.7

ANTENNA POLARITY & TEST DISTANCE: VERTICAL AT 3 M

NO.	FREQ. (MHz)	EMISSION LEVEL (dBuV/m)	LIMIT (dBuV/m)	MARGIN (dB)	ANTENNA HEIGHT (m)	TABLE ANGLE (Degree)	RAW VALUE (dBuV)	CORRECTION FACTOR (dB/m)
1	#5612.00	58.5 PK	68.2	-9.7	1.15 V	345	52.5	6.0
2	*5795.00	112.1 PK			1.15 V	345	71.6	40.5
3	*5795.00	102.1 AV			1.15 V	345	61.6	40.5
4	#5980.00	58.4 PK	68.2	-9.8	1.15 V	345	51.7	6.7
5	11590.00	61.5 PK	74.0	-12.5	1.00 V	298	42.8	18.7
6	11590.00	47.6 AV	54.0	-6.4	1.00 V	298	28.9	18.7

Remarks:

1. Emission Level(dBuV/m) = Raw Value(dBuV) + Correction Factor(dB/m)
2. Correction Factor(dB/m) = Antenna Factor(dB/m) + Cable Factor(dB)
3. The other emission levels were very low against the limit.
4. Margin value = Emission Level – Limit value
5. " * ": Fundamental frequency.
6. " # ": The radiated frequency is out of the restricted band.

802.11ac (VHT80)

CHANNEL	TX Channel 155	DETECTOR FUNCTION	Peak (PK)
FREQUENCY RANGE	1GHz ~ 40GHz		Average (AV)

ANTENNA POLARITY & TEST DISTANCE: HORIZONTAL AT 3 M								
NO.	FREQ. (MHz)	EMISSION LEVEL (dBuV/m)	LIMIT (dBuV/m)	MARGIN (dB)	ANTENNA HEIGHT (m)	TABLE ANGLE (Degree)	RAW VALUE (dBuV)	CORRECTION FACTOR (dB/m)
1	#5656.00	70.0 PK	72.7	-2.7	1.00 H	119	63.9	6.1
2	*5775.00	113.0 PK			1.00 H	119	72.5	40.5
3	*5775.00	102.6 AV			1.00 H	119	62.1	40.5
4	#5929.60	66.7 PK	68.2	-1.5	1.00 H	119	60.0	6.7
5	11550.00	61.2 PK	74.0	-12.8	1.10 H	98	42.2	19.0
6	11550.00	47.8 AV	54.0	-6.2	1.10 H	98	28.8	19.0

ANTENNA POLARITY & TEST DISTANCE: VERTICAL AT 3 M								
NO.	FREQ. (MHz)	EMISSION LEVEL (dBuV/m)	LIMIT (dBuV/m)	MARGIN (dB)	ANTENNA HEIGHT (m)	TABLE ANGLE (Degree)	RAW VALUE (dBuV)	CORRECTION FACTOR (dB/m)
1	#5620.00	61.8 PK	68.2	-6.4	1.11 V	354	55.7	6.1
2	*5775.00	109.0 PK			1.11 V	354	68.5	40.5
3	*5775.00	98.4 AV			1.11 V	354	57.9	40.5
4	#5932.00	62.9 PK	68.2	-5.3	1.11 V	354	56.2	6.7
5	11550.00	61.1 PK	74.0	-12.9	1.00 V	317	42.1	19.0
6	11550.00	48.0 AV	54.0	-6.0	1.00 V	317	29.0	19.0

Remarks:

1. Emission Level(dBuV/m) = Raw Value(dBuV) + Correction Factor(dB/m)
2. Correction Factor(dB/m) = Antenna Factor(dB/m) + Cable Factor(dB)
3. The other emission levels were very low against the limit.
4. Margin value = Emission Level – Limit value
5. " * ": Fundamental frequency.
6. " # ": The radiated frequency is out of the restricted band.

Beamforming Mode

802.11ac (VHT20)

CHANNEL	TX Channel 149	DETECTOR FUNCTION	Peak (PK)
FREQUENCY RANGE	1GHz ~ 40GHz		Average (AV)

ANTENNA POLARITY & TEST DISTANCE: HORIZONTAL AT 3 M								
NO.	FREQ. (MHz)	EMISSION LEVEL (dBuV/m)	LIMIT (dBuV/m)	MARGIN (dB)	ANTENNA HEIGHT (m)	TABLE ANGLE (Degree)	RAW VALUE (dBuV)	CORRECTION FACTOR (dB/m)
1	#5619.20	57.9 PK	68.2	-10.3	1.15 H	213	51.8	6.1
2	*5745.00	115.1 PK			1.15 H	213	74.7	40.4
3	*5745.00	104.1 AV			1.15 H	213	63.7	40.4
4	#5952.80	58.6 PK	68.2	-9.6	1.15 H	213	51.9	6.7
5	11490.00	61.5 PK	74.0	-12.5	1.00 H	188	42.2	19.3
6	11490.00	48.1 AV	54.0	-5.9	1.00 H	188	28.8	19.3
ANTENNA POLARITY & TEST DISTANCE: VERTICAL AT 3 M								
NO.	FREQ. (MHz)	EMISSION LEVEL (dBuV/m)	LIMIT (dBuV/m)	MARGIN (dB)	ANTENNA HEIGHT (m)	TABLE ANGLE (Degree)	RAW VALUE (dBuV)	CORRECTION FACTOR (dB/m)
1	#5640.00	61.0 PK	68.2	-7.2	1.12 V	330	54.9	6.1
2	*5745.00	113.8 PK			1.12 V	330	73.4	40.4
3	*5745.00	101.6 AV			1.12 V	330	61.2	40.4
4	#5964.80	61.4 PK	68.2	-6.8	1.12 V	330	54.7	6.7
5	11490.00	64.6 PK	74.0	-9.4	1.00 V	289	45.3	19.3
6	11490.00	51.6 AV	54.0	-2.4	1.00 V	289	32.3	19.3

Remarks:

1. Emission Level(dBuV/m) = Raw Value(dBuV) + Correction Factor(dB/m)
2. Correction Factor(dB/m) = Antenna Factor(dB/m) + Cable Factor(dB)
3. The other emission levels were very low against the limit.
4. Margin value = Emission Level – Limit value
5. " * ": Fundamental frequency.
6. " # ": The radiated frequency is out of the restricted band.

CHANNEL	TX Channel 157	DETECTOR FUNCTION	Peak (PK)
FREQUENCY RANGE	1GHz ~ 40GHz		Average (AV)

ANTENNA POLARITY & TEST DISTANCE: HORIZONTAL AT 3 M

NO.	FREQ. (MHz)	EMISSION LEVEL (dBuV/m)	LIMIT (dBuV/m)	MARGIN (dB)	ANTENNA HEIGHT (m)	TABLE ANGLE (Degree)	RAW VALUE (dBuV)	CORRECTION FACTOR (dB/m)
1	*5785.00	117.9 PK			1.00 H	119	77.4	40.5
2	*5785.00	106.4 AV			1.00 H	119	65.9	40.5
3	11570.00	60.6 PK	74.0	-13.4	1.10 H	76	41.6	19.0
4	11570.00	47.3 AV	54.0	-6.7	1.10 H	76	28.3	19.0

ANTENNA POLARITY & TEST DISTANCE: VERTICAL AT 3 M

NO.	FREQ. (MHz)	EMISSION LEVEL (dBuV/m)	LIMIT (dBuV/m)	MARGIN (dB)	ANTENNA HEIGHT (m)	TABLE ANGLE (Degree)	RAW VALUE (dBuV)	CORRECTION FACTOR (dB/m)
1	*5785.00	114.2 PK			1.35 V	329	73.7	40.5
2	*5785.00	103.4 AV			1.35 V	329	62.9	40.5
3	11570.00	63.1 PK	74.0	-10.9	1.00 V	281	44.1	19.0
4	11570.00	50.5 AV	54.0	-3.5	1.00 V	281	31.5	19.0

Remarks:

1. Emission Level(dBuV/m) = Raw Value(dBuV) + Correction Factor(dB/m)
2. Correction Factor(dB/m) = Antenna Factor(dB/m) + Cable Factor(dB)
3. The other emission levels were very low against the limit.
4. Margin value = Emission Level – Limit value
5. " * ": Fundamental frequency.
6. " # ": The radiated frequency is out of the restricted band.

CHANNEL	TX Channel 165	DETECTOR FUNCTION	Peak (PK)
FREQUENCY RANGE	1GHz ~ 40GHz		Average (AV)

ANTENNA POLARITY & TEST DISTANCE: HORIZONTAL AT 3 M

NO.	FREQ. (MHz)	EMISSION LEVEL (dBuV/m)	LIMIT (dBuV/m)	MARGIN (dB)	ANTENNA HEIGHT (m)	TABLE ANGLE (Degree)	RAW VALUE (dBuV)	CORRECTION FACTOR (dB/m)
1	#5604.00	58.4 PK	68.2	-9.8	1.30 H	121	52.5	5.9
2	*5825.00	116.0 PK			1.30 H	121	75.4	40.6
3	*5825.00	105.9 AV			1.30 H	121	65.3	40.6
4	#5934.40	59.2 PK	68.2	-9.0	1.30 H	121	52.5	6.7
5	11650.00	60.1 PK	74.0	-13.9	1.00 H	105	41.6	18.5
6	11650.00	46.8 AV	54.0	-7.2	1.00 H	105	28.3	18.5

ANTENNA POLARITY & TEST DISTANCE: VERTICAL AT 3 M

NO.	FREQ. (MHz)	EMISSION LEVEL (dBuV/m)	LIMIT (dBuV/m)	MARGIN (dB)	ANTENNA HEIGHT (m)	TABLE ANGLE (Degree)	RAW VALUE (dBuV)	CORRECTION FACTOR (dB/m)
1	#5601.60	60.0 PK	68.2	-8.2	1.09 V	53	54.1	5.9
2	*5825.00	115.4 PK			1.09 V	53	74.8	40.6
3	*5825.00	102.4 AV			1.09 V	53	61.8	40.6
4	#5990.40	59.8 PK	68.2	-8.4	1.09 V	53	53.1	6.7
5	11650.00	63.4 PK	74.0	-10.6	1.00 V	73	44.9	18.5
6	11650.00	50.0 AV	54.0	-4.0	1.00 V	73	31.5	18.5

Remarks:

1. Emission Level(dBuV/m) = Raw Value(dBuV) + Correction Factor(dB/m)
2. Correction Factor(dB/m) = Antenna Factor(dB/m) + Cable Factor(dB)
3. The other emission levels were very low against the limit.
4. Margin value = Emission Level – Limit value
5. " * ": Fundamental frequency.
6. " # ": The radiated frequency is out of the restricted band.

802.11ac (VHT40)

CHANNEL	TX Channel 151	DETECTOR FUNCTION	Peak (PK)
FREQUENCY RANGE	1GHz ~ 40GHz		Average (AV)

ANTENNA POLARITY & TEST DISTANCE: HORIZONTAL AT 3 M								
NO.	FREQ. (MHz)	EMISSION LEVEL (dBuV/m)	LIMIT (dBuV/m)	MARGIN (dB)	ANTENNA HEIGHT (m)	TABLE ANGLE (Degree)	RAW VALUE (dBuV)	CORRECTION FACTOR (dB/m)
1	#5611.20	59.1 PK	68.2	-9.1	1.00 H	203	53.1	6.0
2	*5755.00	113.0 PK			1.00 H	203	72.5	40.5
3	*5755.00	103.1 AV			1.00 H	203	62.6	40.5
4	#5979.20	58.9 PK	68.2	-9.3	1.00 H	203	52.2	6.7
5	11510.00	60.9 PK	74.0	-13.1	1.13 H	224	41.8	19.1
6	11510.00	47.9 AV	54.0	-6.1	1.13 H	224	28.8	19.1

ANTENNA POLARITY & TEST DISTANCE: VERTICAL AT 3 M								
NO.	FREQ. (MHz)	EMISSION LEVEL (dBuV/m)	LIMIT (dBuV/m)	MARGIN (dB)	ANTENNA HEIGHT (m)	TABLE ANGLE (Degree)	RAW VALUE (dBuV)	CORRECTION FACTOR (dB/m)
1	#5640.00	60.6 PK	68.2	-7.6	1.00 V	336	54.5	6.1
2	*5755.00	111.3 PK			1.00 V	336	70.8	40.5
3	*5755.00	100.6 AV			1.00 V	336	60.1	40.5
4	#5987.20	59.9 PK	68.2	-8.3	1.00 V	336	53.2	6.7
5	11510.00	63.2 PK	74.0	-10.8	1.14 V	277	44.1	19.1
6	11510.00	49.9 AV	54.0	-4.1	1.14 V	277	30.8	19.1

Remarks:

1. Emission Level(dBuV/m) = Raw Value(dBuV) + Correction Factor(dB/m)
2. Correction Factor(dB/m) = Antenna Factor(dB/m) + Cable Factor(dB)
3. The other emission levels were very low against the limit.
4. Margin value = Emission Level – Limit value
5. " * ": Fundamental frequency.
6. " # ": The radiated frequency is out of the restricted band.

CHANNEL	TX Channel 159	DETECTOR FUNCTION	Peak (PK)
FREQUENCY RANGE	1GHz ~ 40GHz		Average (AV)

ANTENNA POLARITY & TEST DISTANCE: HORIZONTAL AT 3 M

NO.	FREQ. (MHz)	EMISSION LEVEL (dBuV/m)	LIMIT (dBuV/m)	MARGIN (dB)	ANTENNA HEIGHT (m)	TABLE ANGLE (Degree)	RAW VALUE (dBuV)	CORRECTION FACTOR (dB/m)
1	#5617.60	58.1 PK	68.2	-10.1	1.19 H	118	52.0	6.1
2	*5795.00	116.7 PK			1.19 H	118	76.2	40.5
3	*5795.00	101.6 AV			1.19 H	118	61.1	40.5
4	#5972.80	57.8 PK	68.2	-10.4	1.19 H	118	51.1	6.7
5	11590.00	60.8 PK	74.0	-13.2	1.00 H	131	42.1	18.7
6	11590.00	47.7 AV	54.0	-6.3	1.00 H	131	29.0	18.7

ANTENNA POLARITY & TEST DISTANCE: VERTICAL AT 3 M

NO.	FREQ. (MHz)	EMISSION LEVEL (dBuV/m)	LIMIT (dBuV/m)	MARGIN (dB)	ANTENNA HEIGHT (m)	TABLE ANGLE (Degree)	RAW VALUE (dBuV)	CORRECTION FACTOR (dB/m)
1	#5630.40	60.6 PK	68.2	-7.6	1.35 V	79	54.5	6.1
2	*5795.00	114.3 PK			1.35 V	79	73.8	40.5
3	*5795.00	100.2 AV			1.35 V	79	59.7	40.5
4	#5981.60	61.1 PK	68.2	-7.1	1.35 V	79	54.4	6.7
5	11590.00	63.2 PK	74.0	-10.8	1.00 V	102	44.5	18.7
6	11590.00	50.0 AV	54.0	-4.0	1.00 V	102	31.3	18.7

Remarks:

1. Emission Level(dBuV/m) = Raw Value(dBuV) + Correction Factor(dB/m)
2. Correction Factor(dB/m) = Antenna Factor(dB/m) + Cable Factor(dB)
3. The other emission levels were very low against the limit.
4. Margin value = Emission Level – Limit value
5. " * ": Fundamental frequency.
6. " # ": The radiated frequency is out of the restricted band.

802.11ac (VHT80)

CHANNEL	TX Channel 155	DETECTOR FUNCTION	Peak (PK)
FREQUENCY RANGE	1GHz ~ 40GHz		Average (AV)

ANTENNA POLARITY & TEST DISTANCE: HORIZONTAL AT 3 M								
NO.	FREQ. (MHz)	EMISSION LEVEL (dBuV/m)	LIMIT (dBuV/m)	MARGIN (dB)	ANTENNA HEIGHT (m)	TABLE ANGLE (Degree)	RAW VALUE (dBuV)	CORRECTION FACTOR (dB/m)
1	#5630.40	59.0 PK	68.2	-9.2	1.34 H	137	52.9	6.1
2	*5775.00	104.1 PK			1.34 H	137	63.6	40.5
3	*5775.00	91.5 AV			1.34 H	137	51.0	40.5
4	#5943.20	58.2 PK	68.2	-10.0	1.34 H	137	51.5	6.7
5	11550.00	62.3 PK	74.0	-11.7	1.69 H	85	43.3	19.0
6	11550.00	48.5 AV	54.0	-5.5	1.69 H	85	29.5	19.0

ANTENNA POLARITY & TEST DISTANCE: VERTICAL AT 3 M								
NO.	FREQ. (MHz)	EMISSION LEVEL (dBuV/m)	LIMIT (dBuV/m)	MARGIN (dB)	ANTENNA HEIGHT (m)	TABLE ANGLE (Degree)	RAW VALUE (dBuV)	CORRECTION FACTOR (dB/m)
1	#5645.60	60.0 PK	68.2	-8.2	1.67 V	339	53.9	6.1
2	*5775.00	103.6 PK			1.67 V	339	63.1	40.5
3	*5775.00	91.3 AV			1.67 V	339	50.8	40.5
4	#5952.80	66.0 PK	68.2	-2.2	1.67 V	339	59.3	6.7
5	11550.00	64.2 PK	74.0	-9.8	1.33 V	312	45.2	19.0
6	11550.00	50.6 AV	54.0	-3.4	1.33 V	312	31.6	19.0

Remarks:

1. Emission Level(dBuV/m) = Raw Value(dBuV) + Correction Factor(dB/m)
2. Correction Factor(dB/m) = Antenna Factor(dB/m) + Cable Factor(dB)
3. The other emission levels were very low against the limit.
4. Margin value = Emission Level – Limit value
5. " * ": Fundamental frequency.
6. " # ": The radiated frequency is out of the restricted band.

Below 1GHz Worst-Case Data: 802.11a

CHANNEL	TX Channel 157	DETECTOR FUNCTION	Quasi-Peak (QP)
FREQUENCY RANGE	9kHz ~ 1GHz		

ANTENNA POLARITY & TEST DISTANCE: HORIZONTAL AT 3 M

NO.	FREQ. (MHz)	EMISSION LEVEL (dBuV/m)	LIMIT (dBuV/m)	MARGIN (dB)	ANTENNA HEIGHT (m)	TABLE ANGLE (Degree)	RAW VALUE (dBuV)	CORRECTION FACTOR (dB/m)
1	39.60	32.0 QP	40.0	-8.0	2.00 H	6	46.70	-14.70
2	124.98	32.2 QP	43.5	-11.3	2.00 H	157	48.00	-15.80
3	330.66	33.0 QP	46.0	-13.0	1.01 H	145	45.10	-12.10
4	499.48	29.4 QP	46.0	-16.6	1.51 H	192	38.80	-9.40
5	625.60	35.2 QP	46.0	-10.8	1.51 H	232	41.80	-6.60
6	730.38	33.8 QP	46.0	-12.2	1.51 H	176	38.40	-4.60

ANTENNA POLARITY & TEST DISTANCE: VERTICAL AT 3 M

NO.	FREQ. (MHz)	EMISSION LEVEL (dBuV/m)	LIMIT (dBuV/m)	MARGIN (dB)	ANTENNA HEIGHT (m)	TABLE ANGLE (Degree)	RAW VALUE (dBuV)	CORRECTION FACTOR (dB/m)
1	157.97	30.5 QP	43.5	-13.0	1.01 V	171	44.20	-13.70
2	299.62	34.0 QP	46.0	-12.0	2.00 V	285	46.80	-12.80
3	499.48	29.0 QP	46.0	-17.0	1.51 V	208	38.40	-9.40
4	625.60	34.5 QP	46.0	-11.5	1.01 V	304	41.10	-6.60
5	872.03	31.3 QP	46.0	-14.7	1.01 V	6	33.50	-2.20

Remarks:

1. Emission Level(dBuV/m) = Raw Value(dBuV) + Correction Factor(dB/m)
2. Correction Factor(dB/m) = Antenna Factor(dB/m) + Cable Factor(dB)
3. The other emission levels were very low against the limit.
4. Margin value = Emission Level – Limit value

4.2 Conducted Emission Measurement

4.2.1 Limits of Conducted Emission Measurement

Frequency (MHz)	Conducted Limit (dBuV)	
	Quasi-peak	Average
0.15 - 0.5	66 - 56	56 - 46
0.50 - 5.0	56	46
5.0 - 30.0	60	50

Note: 1. The lower limit shall apply at the transition frequencies.

2. The limit decreases in line with the logarithm of the frequency in the range of 0.15 to 0.50MHz.

4.2.2 Test Instruments

Description & Manufacturer	Model No.	Serial No.	Cal. Date	Cal. Due
Test Receiver ROHDE & SCHWARZ	ESCI	100613	Nov. 16, 2015	Nov. 15, 2016
RF signal cable (with 10dB PAD) Woken	5D-FB	Cable-cond1-01	Dec. 26, 2015	Dec. 25, 2016
LISN ROHDE & SCHWARZ (EUT)	ESH3-Z5	835239/001	Feb. 26, 2016	Feb. 25, 2017
LISN ROHDE & SCHWARZ (Peripheral)	ESH3-Z5	100311	Jul. 24, 2015	Jul. 23, 2016
Software ADT	BV ADT_Cond_ V7.3.7.3	NA	NA	NA

Note: 1. The calibration interval of the above test instruments is 12 months and the calibrations are traceable to NML/ROC and NIST/USA.

2. The test was performed in HwaYa Shielded Room 1.

3. The VCCI Site Registration No. is C-2040.

4.2.3 Test Procedure

- a. The EUT was placed 0.4 meters from the conducting wall of the shielded room with EUT being connected to the power mains through a line impedance stabilization network (LISN). Other support units were connected to the power mains through another LISN. The two LISNs provide 50 ohm/ 50uH of coupling impedance for the measuring instrument.
- b. Both lines of the power mains connected to the EUT were checked for maximum conducted interference.
- c. The frequency range from 150kHz to 30MHz was searched. Emission levels under (Limit - 20dB) was not recorded.

NOTE: The resolution bandwidth and video bandwidth of test receiver is 9kHz for quasi-peak detection (QP) and average detection (AV) at frequency 0.15MHz-30MHz.

4.2.4 Deviation from Test Standard

No deviation.

4.2.5 Test Setup

4.2.7 Test Results

Phase	Line (L)	Detector Function	Quasi-Peak (QP) / Average (AV)
-------	----------	-------------------	--------------------------------

No	Freq. [MHz]	Corr. Factor (dB)	Reading Value [dB (uV)]		Emission Level [dB (uV)]		Limit [dB (uV)]		Margin (dB)	
			Q.P.	AV.	Q.P.	AV.	Q.P.	AV.	Q.P.	AV.
			1	0.15400	10.08	40.87	25.40	50.95	35.48	65.78
2	0.22200	10.09	34.97	21.60	45.06	31.69	62.74	52.74	-17.68	-21.05
3	0.31365	10.13	25.56	12.21	35.69	22.34	59.87	49.87	-24.18	-27.53
4	0.54255	10.20	26.64	18.50	36.84	28.70	56.00	46.00	-19.16	-17.30
5	0.87800	10.27	12.76	3.25	23.03	13.52	56.00	46.00	-32.97	-32.48
6	2.11000	10.38	12.06	4.25	22.44	14.63	56.00	46.00	-33.56	-31.37

Remarks:

1. Q.P. and AV. are abbreviations of quasi-peak and average individually.
2. The emission levels of other frequencies were very low against the limit.
3. Margin value = Emission level - Limit value
4. Correction factor = Insertion loss + Cable loss
5. Emission Level = Correction Factor + Reading Value.

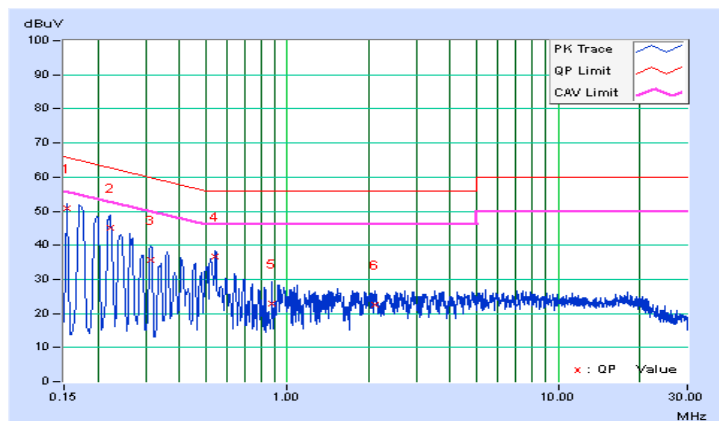

Phase	Neutral (N)	Detector Function	Quasi-Peak (QP) / Average (AV)
-------	-------------	-------------------	--------------------------------

No	Freq. [MHz]	Corr. Factor (dB)	Reading Value [dB (uV)]		Emission Level [dB (uV)]		Limit [dB (uV)]		Margin (dB)	
			Q.P.	AV.	Q.P.	AV.	Q.P.	AV.	Q.P.	AV.
			1	0.16600	10.08	40.36	27.33	50.44	37.41	65.16
2	0.21406	10.09	33.53	19.93	43.62	30.02	63.05	53.05	-19.43	-23.03
3	0.54112	10.25	31.03	23.05	41.28	33.30	56.00	46.00	-14.72	-12.70
4	1.53197	10.34	18.00	9.36	28.34	19.70	56.00	46.00	-27.66	-26.30
5	3.76198	10.57	15.32	5.99	25.89	16.56	56.00	46.00	-30.11	-29.44
6	19.35400	11.53	11.75	6.12	23.28	17.65	60.00	50.00	-36.72	-32.35

Remarks:

1. Q.P. and AV. are abbreviations of quasi-peak and average individually.
2. The emission levels of other frequencies were very low against the limit.
3. Margin value = Emission level - Limit value
4. Correction factor = Insertion loss + Cable loss
5. Emission Level = Correction Factor + Reading Value.

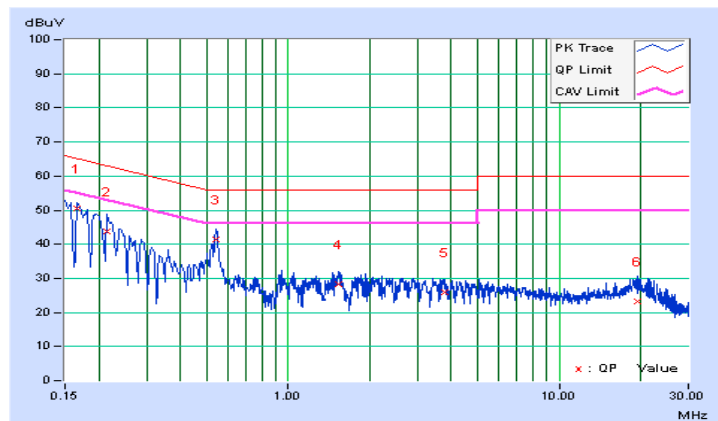

4.3 Transmit Power Measurement

4.3.1 Limits of Transmit Power Measurement

Operation Band	EUT Category	Limit
U-NII-1	Outdoor Access Point	1 Watt (30 dBm) (Max. e.i.r.p)

*B is the 26 dB emission bandwidth in megahertz

Per KDB 662911 Method of conducted output power measurement on IEEE 802.11 devices,

Array Gain = 0 dB (i.e., no array gain) for $N_{ANT} \leq 4$;

Array Gain = 0 dB (i.e., no array gain) for channel widths ≥ 40 MHz for any N_{ANT} ;

Array Gain = $5 \log(N_{ANT}/N_{SS})$ dB or 3 dB, whichever is less for 20-MHz channel widths with $N_{ANT} \geq 5$.

For power measurements on all other devices: Array Gain = $10 \log(N_{ANT}/N_{SS})$ dB.

4.3.2 Test Setup

For Power Output Measurement

For 802.11a, 802.11n (HT20), 802.11n (HT40)

For 802.11ac (VHT80)

For Bandwidth

4.3.3 Test Instruments

Refer to section 4.1.2 to get information of above instrument.

4.3.4 Test Procedure

For Average Power Measurement

For 802.11a, 802.11ac (VHT20), 802.11ac (VHT40)

Method PM is used to perform output power measurement, trigger and gating function of wide band power meter is enabled to measure max output power of TX on burst. Duty factor is not added to measured value.

For 802.11ac (VHT80)

- a. Set span to encompass the entire 26 dB EBW (or, alternatively, the entire 99% occupied bandwidth) of the signal.
- b. Set sweep trigger to "free run".
- c. Set RBW = 1 MHz
- d. Set VBW \geq 3 MHz
- e. Number of points in sweep \geq 2 Span / RBW
- f. Sweep time \leq (number of points in sweep) * T
- g. Using emission bandwidth to determine the frequency span for integration the channel bandwidth.
- h. Detector = RMS
- i. Trace mode = max hold
- j. Allow max hold to run for at least 60 seconds, or longer as needed to allow the trace to stabilize.

For Occupied Bandwidth

The transmitter output was connected to the spectrum analyzer through an attenuator. The bandwidth of the fundamental frequency was measured by spectrum analyzer with 300 kHz RBW and 1MHz VBW. The width of a frequency band such that, below the lower and above the upper frequency limits, the mean powers emitted are each equal to a specified percentage 0.5 % of the total mean power of a given emission.

4.3.5 Deviation from Test Standard

No deviation.

4.3.6 EUT Operating Conditions

The software provided by client to enable the EUT under transmission Condition continuously at lowest, middle and highest channel frequencies individually.

4.3.7 Test Result

Power Output:

CDD Mode

802.11a

Channel	Frequency (MHz)	Maximum Conducted Power (dBm)				Total Power (mW)	Total Power (dBm)	Power Limit (dBm)	Pass / Fail
		Chain 0	Chain 1	Chain 2	Chain 3				
149	5745	22.75	22.82	22.77	22.66	753.527	28.77	30	Pass
157	5785	22.72	22.85	22.62	22.77	751.864	28.76	30	Pass
165	5825	22.76	22.81	22.63	22.74	750.947	28.76	30	Pass

802.11ac (VHT20)

Channel	Frequency (MHz)	Maximum Conducted Power (dBm)				Total Power (mW)	Total Power (dBm)	Power Limit (dBm)	Pass / Fail
		Chain 0	Chain 1	Chain 2	Chain 3				
149	5745	22.69	22.79	22.61	22.70	744.487	28.72	30	Pass
157	5785	22.71	22.86	22.60	22.68	747.158	28.73	30	Pass
165	5825	22.66	22.83	22.72	22.69	749.217	28.75	30	Pass

802.11ac (VHT40)

Channel	Frequency (MHz)	Maximum Conducted Power (dBm)				Total Power (mW)	Total Power (dBm)	Power Limit (dBm)	Pass / Fail
		Chain 0	Chain 1	Chain 2	Chain 3				
151	5755	22.68	22.89	22.75	22.74	756.186	28.79	30	Pass
159	5795	22.74	22.88	22.76	22.73	758.319	28.80	30	Pass

802.11ac (VHT80)

Channel	Frequency (MHz)	Maximum Conducted Power (dBm)				Total Power (mW)	Total Power (dBm)	Power Limit (dBm)	Pass / Fail
		Chain 0	Chain 1	Chain 2	Chain 3				
155	5775	22.69	22.78	22.62	22.65	742.338	28.71	30	Pass

Beamforming Mode

802.11ac (VHT20)

Channel	Frequency (MHz)	Maximum Conducted Power (dBm)				Total Power (mW)	Total Power (dBm)	Power Limit (dBm)	Pass / Fail
		Chain 0	Chain 1	Chain 2	Chain 3				
149	5745	20.39	20.49	20.31	20.40	438.387	26.42	26.61	Pass
157	5785	20.41	20.56	20.30	20.38	439.960	26.43	26.44	Pass
165	5825	20.36	20.41	20.22	20.30	430.892	26.34	26.37	Pass

Note:

5745MHz: Directional gain = $10 \log[(10^{G1/20} + 10^{G2/20} + \dots + 10^{GN/20})^2/N]$ = 9.39dBi > 6dBi, so the limit shall be reduced to 30-(9.39-6) = 26.61dBm.

5785MHz: Directional gain = $10 \log[(10^{G1/20} + 10^{G2/20} + \dots + 10^{GN/20})^2/N]$ = 9.56dBi > 6dBi, so the limit shall be reduced to 30-(9.56-6) = 26.44dBm.

5825MHz: Directional gain = $10 \log[(10^{G1/20} + 10^{G2/20} + \dots + 10^{GN/20})^2/N]$ = 9.63dBi > 6dBi, so the limit shall be reduced to 30-(9.63-6) = 26.37dBm.

802.11ac (VHT40)

Channel	Frequency (MHz)	Maximum Conducted Power (dBm)				Total Power (mW)	Total Power (dBm)	Power Limit (dBm)	Pass / Fail
		Chain 0	Chain 1	Chain 2	Chain 3				
151	5755	20.38	20.59	20.45	20.44	445.274	26.49	26.53	Pass
159	5795	20.44	20.31	20.26	20.43	434.639	26.38	26.39	Pass

Note:

5755MHz: Directional gain = $10 \log[(10^{G1/20} + 10^{G2/20} + \dots + 10^{GN/20})^2/N]$ = 9.47dBi > 6dBi, so the limit shall be reduced to 30-(9.47-6) = 26.53dBm.

5795MHz: Directional gain = $10 \log[(10^{G1/20} + 10^{G2/20} + \dots + 10^{GN/20})^2/N]$ = 9.61dBi > 6dBi, so the limit shall be reduced to 30-(9.61-6) = 26.39dBm.

802.11ac (VHT80)

Channel	Frequency (MHz)	Maximum Conducted Power (dBm)				Total Power (mW)	Total Power (dBm)	Power Limit (dBm)	Pass / Fail
		Chain 0	Chain 1	Chain 2	Chain 3				
155	5775	20.39	20.48	20.32	20.35	437.122	26.41	26.44	Pass

Note:

5775MHz: Directional gain = $10 \log[(10^{G1/20} + 10^{G2/20} + \dots + 10^{GN/20})^2/N]$ = 9.56dBi > 6dBi, so the limit shall be reduced to 30-(9.56-6) = 26.44dBm.

Occupied Bandwidth:

CDD Mode

802.11a

Channel	Frequency (MHz)	Occupied Bandwidth (MHz)			
		Chain 0	Chain 1	Chain 2	Chain 3
149	5745	19.30	22.96	16.70	16.61
157	5785	23.04	24.48	16.80	16.68
165	5825	26.04	23.04	16.92	16.68

802.11ac (VHT20)

Channel	Frequency (MHz)	Occupied Bandwidth (MHz)			
		Chain 0	Chain 1	Chain 2	Chain 3
149	5745	20.28	21.72	17.76	17.64
157	5785	24.60	22.56	17.88	17.76
165	5825	27.00	21.84	17.88	17.76

802.11ac (VHT40)

Channel	Frequency (MHz)	Occupied Bandwidth (MHz)			
		Chain 0	Chain 1	Chain 2	Chain 3
151	5755	46.52	48.60	36.84	36.96
159	5795	49.68	49.68	36.96	37.08

802.11ac (VHT80)

Channel	Frequency (MHz)	Occupied Bandwidth (MHz)			
		Chain 0	Chain 1	Chain 2	Chain 3
155	5775	98.84	97.44	76.72	76.44

Spectrum Plot of Worst Value

802.11a

802.11ac (VHT20)

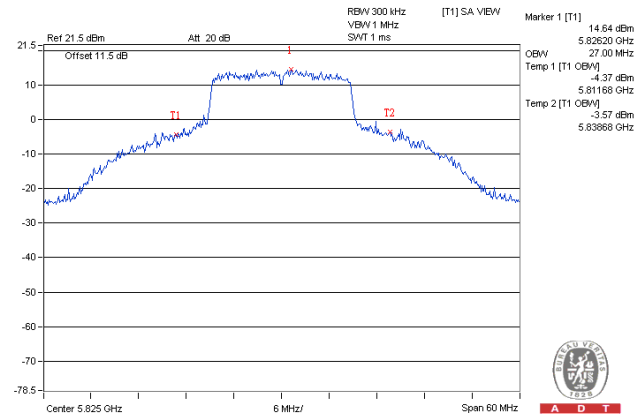
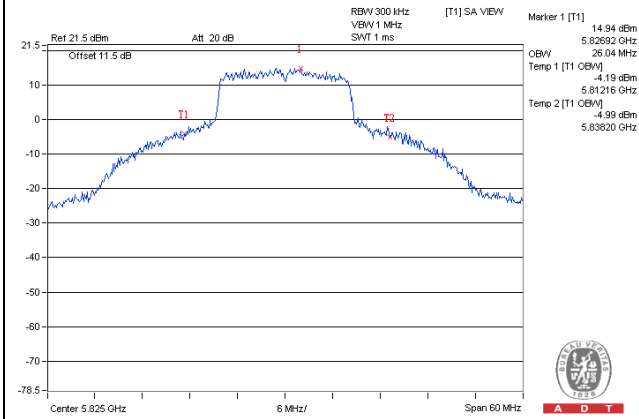

802.11ac (VHT40)

802.11ac (VHT80)

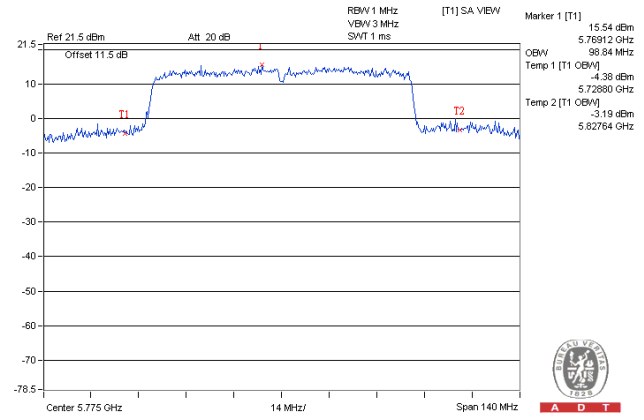
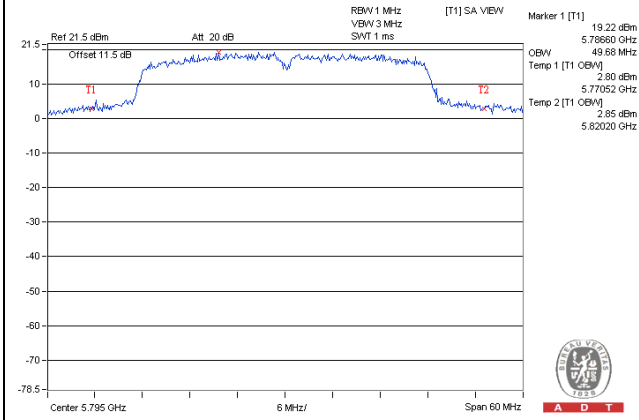

Beamforming Mode

802.11ac (VHT20)

Channel	Frequency (MHz)	Occupied Bandwidth (MHz)			
		Chain 0	Chain 1	Chain 2	Chain 3
149	5745	17.57	17.65	17.65	17.57
157	5785	17.64	17.64	17.64	17.64
165	5825	17.64	17.64	17.64	17.64

802.11ac (VHT40)

Channel	Frequency (MHz)	Occupied Bandwidth (MHz)			
		Chain 0	Chain 1	Chain 2	Chain 3
151	5755	36.24	36.36	36.12	36.24
159	5795	36.24	36.36	36.24	36.24

802.11ac (VHT80)

Channel	Frequency (MHz)	Occupied Bandwidth (MHz)			
		Chain 0	Chain 1	Chain 2	Chain 3
155	5775	75.88	76.16	75.60	75.88

Spectrum Plot of Worst Value

802.11ac (VHT20)

802.11ac (VHT40)

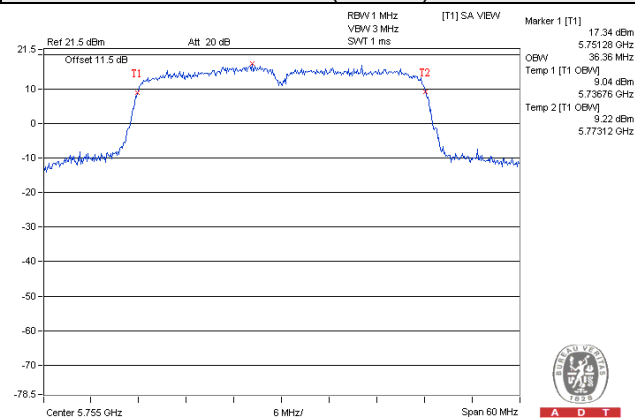
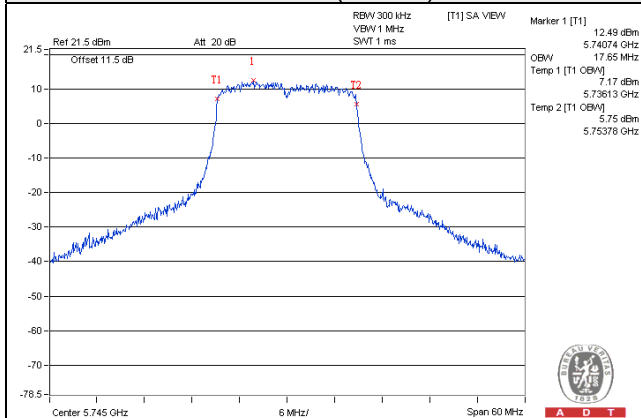

802.11ac (VHT80)

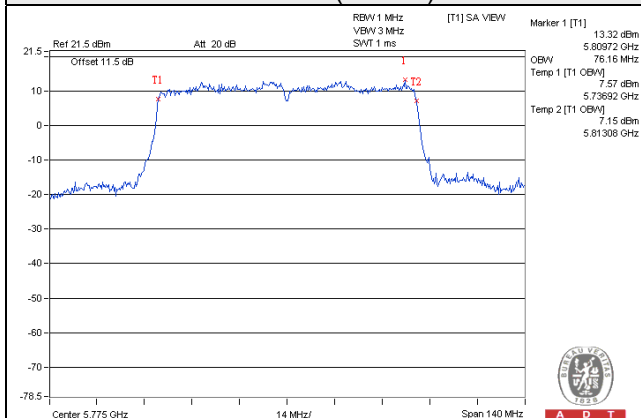

4.4 Peak Power Spectral Density Measurement

4.4.1 Limits of Peak Power Spectral Density Measurement

Operation Band	EUT Category		Limit
U-NII-1		Outdoor Access Point	17dBm/ MHz
		Fixed point-to-point Access Point	
		Indoor Access Point	
		Mobile and Portable client device	11dBm/ MHz
U-NII-2A	---		11dBm/ MHz
U-NII-2C	---		11dBm/ MHz
U-NII-3	√		30dBm/ 500kHz

4.4.2 Test Setup

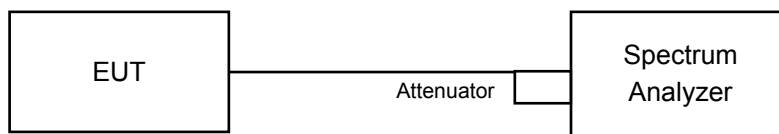

4.4.3 Test Instruments

Refer to section 4.1.2 to get information of above instrument.

4.4.4 Test Procedure

- 1) Set span to encompass the entire emission bandwidth (EBW) of the signal.
- 2) Set RBW = 300 kHz, Set VBW ≥ 1 MHz, Detector = RMS
- 3) Sweep time = auto, trigger set to “free run”.
- 4) Trace average at least 100 traces in power averaging mode.
- 5) Record the max value and add 10 log (1/duty cycle)
- 6) Scale the observed power level to an equivalent value in 500 kHz by adjusting (reducing) the measured power by a bandwidth correction factor (BWCF) where $BWCF = 10\log(500 \text{ kHz}/300\text{kHz})$

4.4.5 Deviation from Test Standard

No deviation.

4.4.6 EUT Operating Condition

Same as Item 4.3.6.

4.4.7 Test Results

CDD Mode

802.11a

TX chain	Channel	Freq. (MHz)	PSD (dBm/300kHz)	PSD (dBm/500kHz)	10 log (N=4) dB	Duty factor	Total PSD (dBm/500kHz)	Limit (dBm/500kHz)	Pass / Fail
0	149	5745	1.86	4.08	6.02	0.15	10.25	26.61	Pass
	157	5785	2.18	4.40	6.02	0.15	10.57	26.44	Pass
	165	5825	2.51	4.73	6.02	0.15	10.90	26.37	Pass
1	149	5745	1.87	4.09	6.02	0.15	10.26	26.61	Pass
	157	5785	1.88	4.10	6.02	0.15	10.27	26.44	Pass
	165	5825	1.86	4.08	6.02	0.15	10.25	26.37	Pass
2	149	5745	1.83	4.05	6.02	0.15	10.22	26.61	Pass
	157	5785	1.64	3.86	6.02	0.15	10.03	26.44	Pass
	165	5825	1.83	4.05	6.02	0.15	10.22	26.37	Pass
3	149	5745	2.06	4.28	6.02	0.15	10.45	26.61	Pass
	157	5785	2.15	4.37	6.02	0.15	10.54	26.44	Pass
	165	5825	2.27	4.49	6.02	0.15	10.66	26.37	Pass

Note:

- Method 1 of power density measurement of KDB 662911 is using for calculating total power density. Total power density is summing entire spectra across corresponding frequency bins on the various outputs by computer.
- 5745MHz: Directional gain = $10 \log[(10^{G1/20} + 10^{G2/20} + \dots + 10^{GN/20})^2/N]$ = 9.39dBi > 6dBi, so the limit shall be reduced to 30-(9.39-6) = 26.61dBm.
 5785MHz: Directional gain = $10 \log[(10^{G1/20} + 10^{G2/20} + \dots + 10^{GN/20})^2/N]$ = 9.56dBi > 6dBi, so the limit shall be reduced to 30-(9.56-6) = 26.44dBm.
 5825MHz: Directional gain = $10 \log[(10^{G1/20} + 10^{G2/20} + \dots + 10^{GN/20})^2/N]$ = 9.63dBi > 6dBi, so the limit shall be reduced to 30-(9.63-6) = 26.37dBm.
- Refer to section 3.3 for duty cycle spectrum plot.

802.11ac (VHT20)

TX chain	Channel	Freq. (MHz)	PSD (dBm/300kHz)	PSD (dBm/500kHz)	10 log (N=4) dB	Total PSD (dBm/500kHz)	Limit (dBm/500kHz)	Pass / Fail
0	149	5745	1.55	3.77	6.02	9.79	26.61	Pass
	157	5785	1.83	4.05	6.02	10.07	26.44	Pass
	165	5825	2.13	4.35	6.02	10.37	26.37	Pass
1	149	5745	1.47	3.69	6.02	9.71	26.61	Pass
	157	5785	1.63	3.85	6.02	9.87	26.44	Pass
	165	5825	1.68	3.90	6.02	9.92	26.37	Pass
2	149	5745	1.26	3.48	6.02	9.50	26.61	Pass
	157	5785	1.07	3.29	6.02	9.31	26.44	Pass
	165	5825	1.24	3.46	6.02	9.48	26.37	Pass
3	149	5745	1.55	3.77	6.02	9.79	26.61	Pass
	157	5785	1.57	3.79	6.02	9.81	26.44	Pass
	165	5825	1.71	3.93	6.02	9.95	26.37	Pass

Note:

- Method 1 of power density measurement of KDB 662911 is using for calculating total power density. Total power density is summing entire spectra across corresponding frequency bins on the various outputs by computer.
- 5745MHz: Directional gain = $10 \log[(10^{G1/20} + 10^{G2/20} + \dots + 10^{GN/20})^2/N]$ = 9.39dB > 6dBi, so the limit shall be reduced to 30-(9.39-6) = 26.61dBm.
 5785MHz: Directional gain = $10 \log[(10^{G1/20} + 10^{G2/20} + \dots + 10^{GN/20})^2/N]$ = 9.56dB > 6dBi, so the limit shall be reduced to 30-(9.56-6) = 26.44dBm.
 5825MHz: Directional gain = $10 \log[(10^{G1/20} + 10^{G2/20} + \dots + 10^{GN/20})^2/N]$ = 9.63dB > 6dBi, so the limit shall be reduced to 30-(9.63-6) = 26.37dBm.

802.11ac (VHT40)

TX chain	Channel	Freq. (MHz)	PSD (dBm/300kHz)	PSD (dBm/500kHz)	10 log (N=4) dB	Duty factor	Total PSD (dBm/500kHz)	Limit (dBm/500kHz)	Pass / Fail
0	151	5755	-0.12	2.10	6.02	0.14	8.26	26.53	Pass
	159	5795	0.07	2.29	6.02	0.14	8.45	26.39	Pass
1	151	5755	-0.30	1.92	6.02	0.14	8.08	26.53	Pass
	159	5795	-0.18	2.04	6.02	0.14	8.20	26.39	Pass
2	151	5755	-0.57	1.65	6.02	0.14	7.81	26.53	Pass
	159	5795	-0.40	1.82	6.02	0.14	7.98	26.39	Pass
3	151	5755	0.20	2.42	6.02	0.14	8.58	26.53	Pass
	159	5795	0.20	2.42	6.02	0.14	8.58	26.39	Pass

Note:

- Method 1 of power density measurement of KDB 662911 is using for calculating total power density. Total power density is summing entire spectra across corresponding frequency bins on the various outputs by computer.
- 5755MHz: Directional gain = $10 \log[(10^{G1/20} + 10^{G2/20} + \dots + 10^{GN/20})^2/N]$ = 9.47dB > 6dBi, so the limit shall be reduced to 30-(9.47-6) = 26.53dBm.
 5795MHz: Directional gain = $10 \log[(10^{G1/20} + 10^{G2/20} + \dots + 10^{GN/20})^2/N]$ = 9.61dB > 6dBi, so the limit shall be reduced to 30-(9.61-6) = 26.39dBm.
- Refer to section 3.3 for duty cycle spectrum plot.

802.11ac (VHT80)

TX chain	Channel	Freq. (MHz)	PSD (dBm/300kHz)	PSD (dBm/500kHz)	10 log (N=4) dB	Duty factor	Total PSD (dBm/500kHz)	Limit (dBm/500kHz)	Pass / Fail
0	155	5775	-4.35	-2.13	6.02	0.30	4.19	26.44	Pass
1	155	5775	-4.27	-2.05	6.02	0.30	4.27	26.44	Pass
2	155	5775	-4.49	-2.27	6.02	0.30	4.05	26.44	Pass
3	155	5775	-4.06	-1.84	6.02	0.30	4.48	26.44	Pass

Note:

- Method 1 of power density measurement of KDB 662911 is using for calculating total power density. Total power density is summing entire spectra across corresponding frequency bins on the various outputs by computer.
- 5755MHz: Directional gain = $10 \log[(10^{G1/20} + 10^{G2/20} + \dots + 10^{GN/20})^2/N]$ = 9.56dBi > 6dBi, so the limit shall be reduced to $30-(9.56-6) = 26.44$ dBm.
- Refer to section 3.3 for duty cycle spectrum plot.

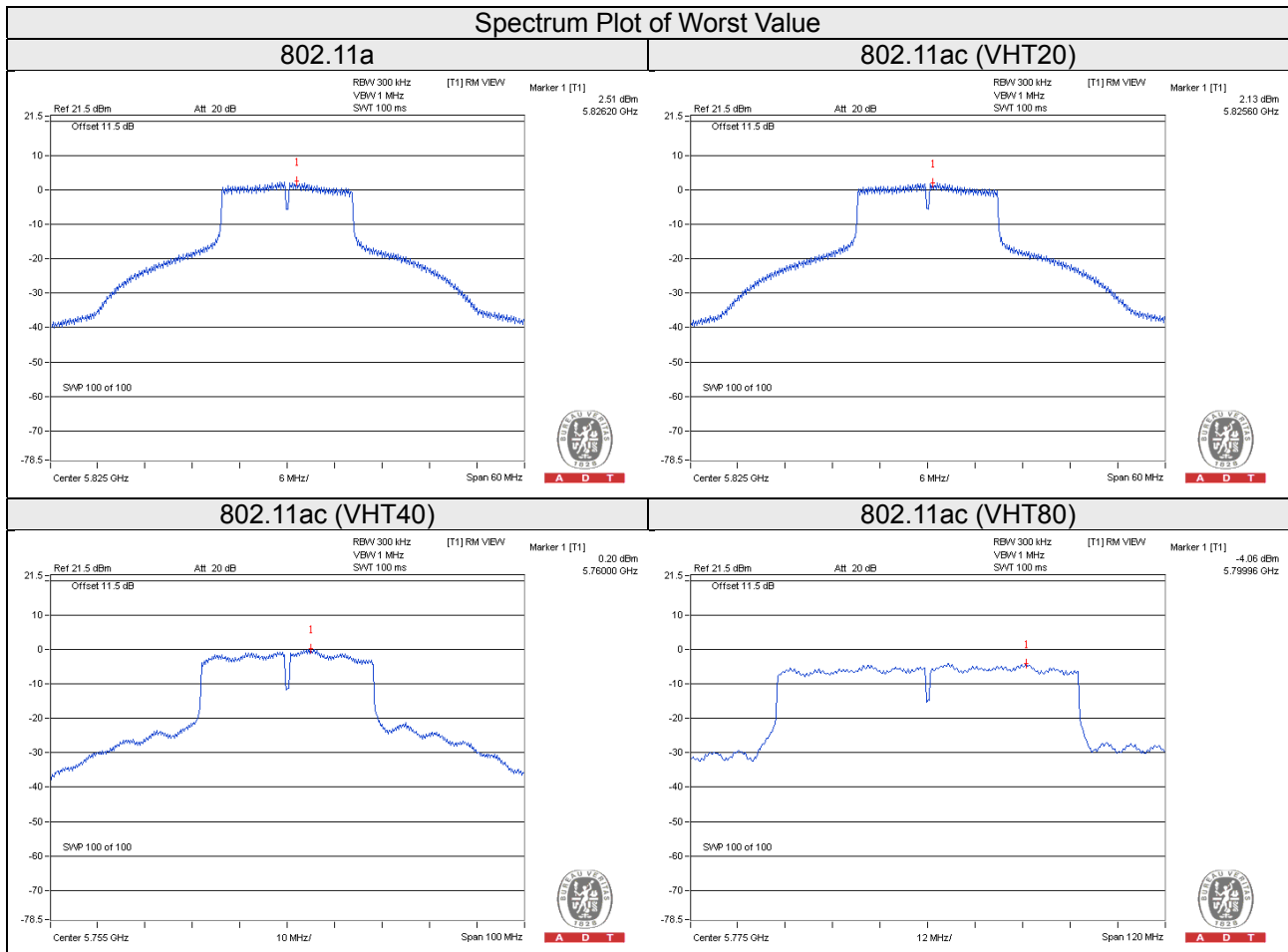

Beamforming Mode

802.11ac (VHT20)

TX chain	Channel	Freq. (MHz)	PSD (dBm/300kHz)	PSD (dBm/500kHz)	10 log (N=4) dB	Total PSD (dBm/500kHz)	Limit (dBm/500kHz)	Pass / Fail
0	149	5745	-0.52	1.70	6.02	7.72	26.61	Pass
	157	5785	-0.55	1.67	6.02	7.69	26.44	Pass
	165	5825	-0.60	1.62	6.02	7.64	26.37	Pass
1	149	5745	-0.61	1.61	6.02	7.63	26.61	Pass
	157	5785	-0.52	1.70	6.02	7.72	26.44	Pass
	165	5825	-0.54	1.68	6.02	7.70	26.37	Pass
2	149	5745	-0.84	1.38	6.02	7.40	26.61	Pass
	157	5785	-1.02	1.20	6.02	7.22	26.44	Pass
	165	5825	-0.96	1.26	6.02	7.28	26.37	Pass
3	149	5745	-0.52	1.70	6.02	7.72	26.61	Pass
	157	5785	-0.32	1.90	6.02	7.92	26.44	Pass
	165	5825	-0.38	1.84	6.02	7.86	26.37	Pass

Note:

- Method 1 of power density measurement of KDB 662911 is using for calculating total power density. Total power density is summing entire spectra across corresponding frequency bins on the various outputs by computer.
- 5745MHz: Directional gain = $10 \log[(10^{G1/20} + 10^{G2/20} + \dots + 10^{GN/20})^2/N]$ = 9.39dBi > 6dBi, so the limit shall be reduced to 30-(9.39-6) = 26.61dBm.
5785MHz: Directional gain = $10 \log[(10^{G1/20} + 10^{G2/20} + \dots + 10^{GN/20})^2/N]$ = 9.56dBi > 6dBi, so the limit shall be reduced to 30-(9.56-6) = 26.44dBm.
5825MHz: Directional gain = $10 \log[(10^{G1/20} + 10^{G2/20} + \dots + 10^{GN/20})^2/N]$ = 9.63dBi > 6dBi, so the limit shall be reduced to 30-(9.63-6) = 26.37dBm.

802.11ac (VHT40)

TX chain	Channel	Freq. (MHz)	PSD (dBm/300kHz)	PSD (dBm/500kHz)	10 log (N=4) dB	Duty factor	Total PSD (dBm/500kHz)	Limit (dBm/500kHz)	Pass / Fail
0	151	5755	-1.92	0.30	6.02	0.12	6.44	26.53	Pass
	159	5795	-1.78	0.44	6.02	0.12	6.58	26.39	Pass
1	151	5755	-2.24	-0.02	6.02	0.12	6.12	26.53	Pass
	159	5795	-2.18	0.04	6.02	0.12	6.18	26.39	Pass
2	151	5755	-2.54	-0.32	6.02	0.12	5.82	26.53	Pass
	159	5795	-2.36	-0.14	6.02	0.12	6.00	26.39	Pass
3	151	5755	-1.82	0.40	6.02	0.12	6.54	26.53	Pass
	159	5795	-1.84	0.38	6.02	0.12	6.52	26.39	Pass

Note:

- Method 1 of power density measurement of KDB 662911 is using for calculating total power density. Total power density is summing entire spectra across corresponding frequency bins on the various outputs by computer.
- 5755MHz: Directional gain = $10 \log[(10^{G1/20} + 10^{G2/20} + \dots + 10^{GN/20})^2/N]$ = 9.47dBi > 6dBi, so the limit shall be reduced to 30-(9.47-6) = 26.53dBm.
5795MHz: Directional gain = $10 \log[(10^{G1/20} + 10^{G2/20} + \dots + 10^{GN/20})^2/N]$ = 9.61dBi > 6dBi, so the limit shall be reduced to 30-(9.61-6) = 26.39dBm.
- Refer to section 3.3 for duty cycle spectrum plot.

802.11ac (VHT80)

TX chain	Channel	Freq. (MHz)	PSD (dBm/300kHz)	PSD (dBm/500kHz)	10 log (N=4) dB	Duty factor	Total PSD (dBm/500kHz)	Limit (dBm/500kHz)	Pass / Fail
0	155	5775	-6.18	-3.96	6.02	0.26	2.32	26.44	Pass
1	155	5775	-6.24	-4.02	6.02	0.26	2.26	26.44	Pass
2	155	5775	-6.34	-4.12	6.02	0.26	2.16	26.44	Pass
3	155	5775	-6.13	-3.91	6.02	0.26	2.37	26.44	Pass

Note:

- Method 1 of power density measurement of KDB 662911 is using for calculating total power density. Total power density is summing entire spectra across corresponding frequency bins on the various outputs by computer.
- 5755MHz: Directional gain = $10 \log[(10^{G1/20} + 10^{G2/20} + \dots + 10^{GN/20})^2/N]$ = 9.56dBi > 6dBi, so the limit shall be reduced to 30-(9.56-6) = 26.44dBm.
- Refer to section 3.3 for duty cycle spectrum plot.

Spectrum Plot of Worst Value

802.11ac (VHT20)

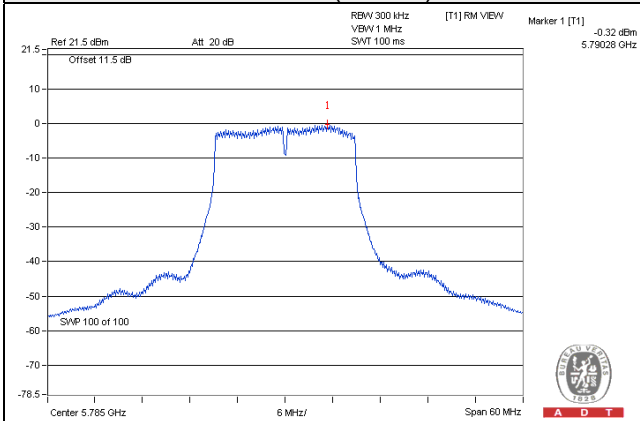

802.11ac (VHT40)

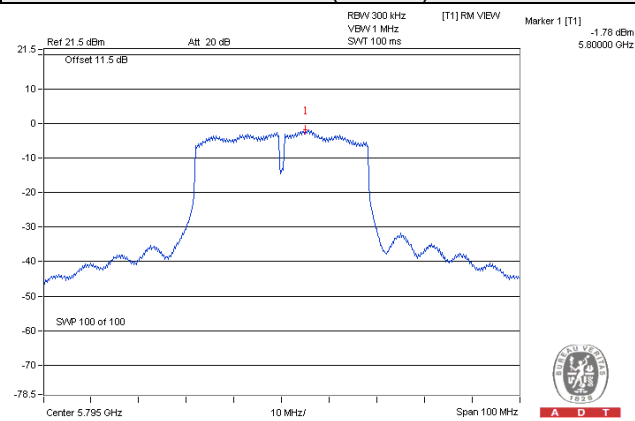

802.11ac (VHT80)

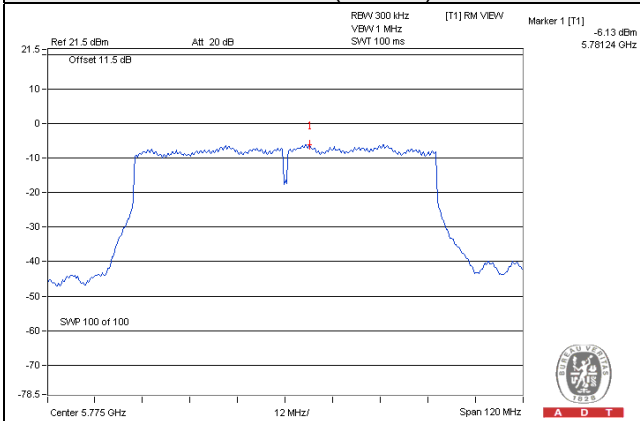

4.5 Frequency Stability

4.5.1 Limits of Frequency Stability Measurement

The frequency of the carrier signal shall be maintained within band of operation

4.5.2 Test Setup

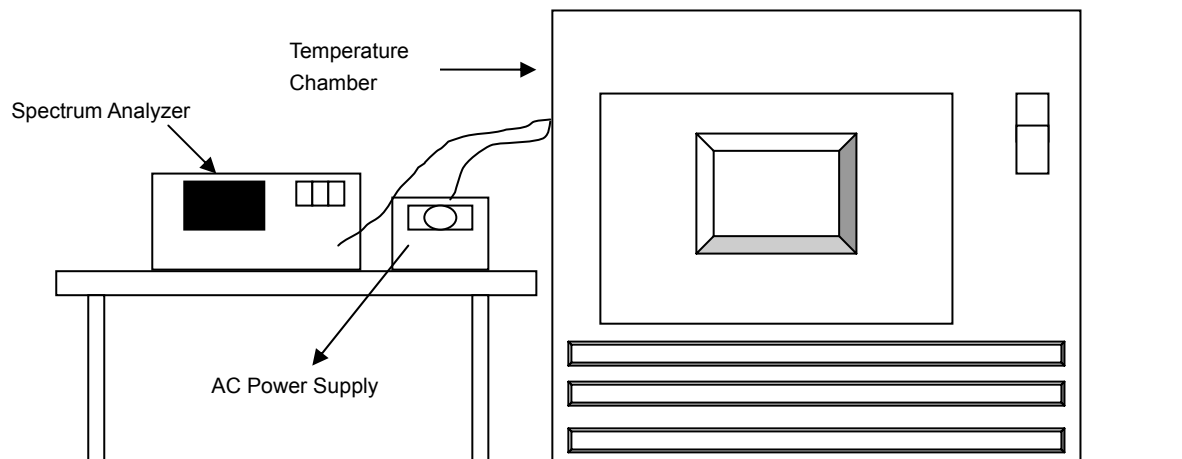

4.5.3 Test Instruments

Refer to section 4.1.2 to get information of above instrument.

4.5.4 Test Procedure

- The EUT was placed inside the environmental test chamber and powered by nominal AC voltage.
- Turn the EUT on and couple its output to a spectrum analyzer.
- Turn the EUT off and set the chamber to the highest temperature specified.
- Allow sufficient time (approximately 30 min) for the temperature of the chamber to stabilize, turn the EUT on and measure the operating frequency after 2, 5, and 10 minutes.
- Repeat step 2 and 3 with the temperature chamber set to the lowest temperature.
- The test chamber was allowed to stabilize at +20 degree C for a minimum of 30 minutes. The supply voltage was then adjusted on the EUT from 85% to 115% and the frequency record.

4.5.5 Deviation from Test Standard

No deviation.

4.5.6 EUT Operating Condition

Set the EUT transmit at un-modulation mode to test frequency stability.

4.5.7 Test Results

Frequency Stability Versus Temp.

Operating Frequency: 5745MHz

Temp.
(

4.6 6dB Bandwidth Measurement

4.6.1 Limits of 6dB Bandwidth Measurement

The minimum of 6dB Bandwidth Measurement is 0.5MHz.

4.6.2 Test Setup

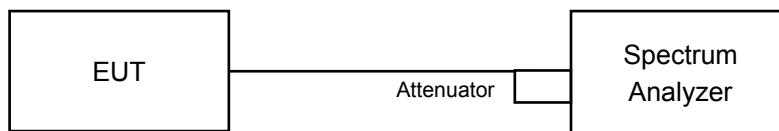

4.6.3 Test Instruments

Refer to section 4.1.2 to get information of above instrument.

4.6.4 Test Procedure

- Set resolution bandwidth (RBW) = 100kHz
- Set the video bandwidth (VBW) $\geq 3 \times$ RBW, Detector = Peak
- Trace mode = max hold
- Sweep = auto couple
- Measure the maximum width of the emission that is constrained by the frequencies associated with the two amplitude points (upper and lower) that are attenuated by 6 dB relative to the maximum level measured in the fundamental emission

4.6.5 Deviation from Test Standard

No deviation.

4.6.6 EUT Operating Condition

The software provided by client to enable the EUT under transmission Condition continuously at lowest, middle and highest channel frequencies individually.

4.6.7 Test Results

CDD Mode

802.11a

Channel	Frequency (MHz)	6dB Bandwidth (MHz)				Minimum Limit (MHz)	Pass / Fail
		Chain 0	Chain 1	Chain 2	Chain 3		
149	5745	16.36	16.33	16.34	15.33	0.5	Pass
157	5785	16.37	16.37	16.38	15.20	0.5	Pass
165	5825	16.35	16.38	16.42	15.18	0.5	Pass

802.11ac (VHT20)

Channel	Frequency (MHz)	6dB Bandwidth (MHz)				Minimum Limit (MHz)	Pass / Fail
		Chain 0	Chain 1	Chain 2	Chain 3		
149	5745	17.59	16.83	17.33	15.19	0.5	Pass
157	5785	17.57	17.58	17.61	15.76	0.5	Pass
165	5825	17.18	17.33	17.65	15.76	0.5	Pass

802.11ac (VHT40)

Channel	Frequency (MHz)	6dB Bandwidth (MHz)				Minimum Limit (MHz)	Pass / Fail
		Chain 0	Chain 1	Chain 2	Chain 3		
151	5755	34.14	32.74	35.22	35.13	0.5	Pass
159	5795	35.76	32.66	35.22	33.84	0.5	Pass

802.11ac (VHT80)

Channel	Frequency (MHz)	6dB Bandwidth (MHz)				Minimum Limit (MHz)	Pass / Fail
		Chain 0	Chain 1	Chain 2	Chain 3		
155	5775	75.29	74.03	75.40	75.39	0.5	Pass

Spectrum Plot of Worst Value

802.11a

802.11ac (VHT20)

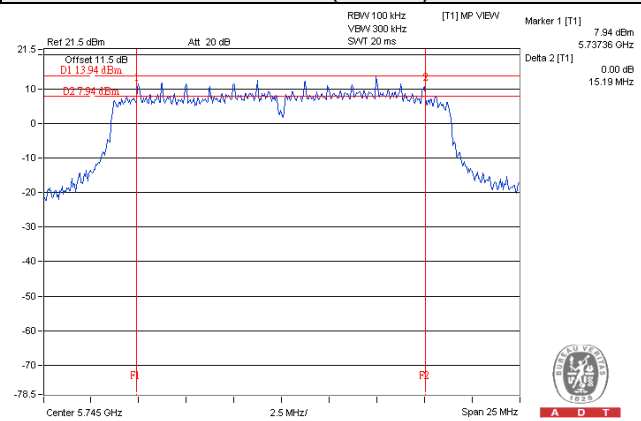
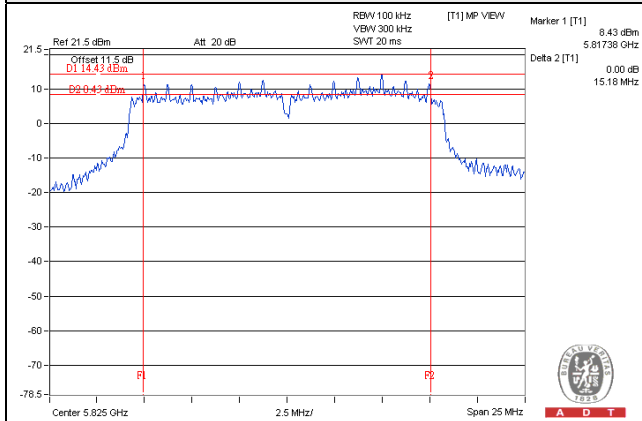

802.11ac (VHT40)

802.11ac (VHT80)

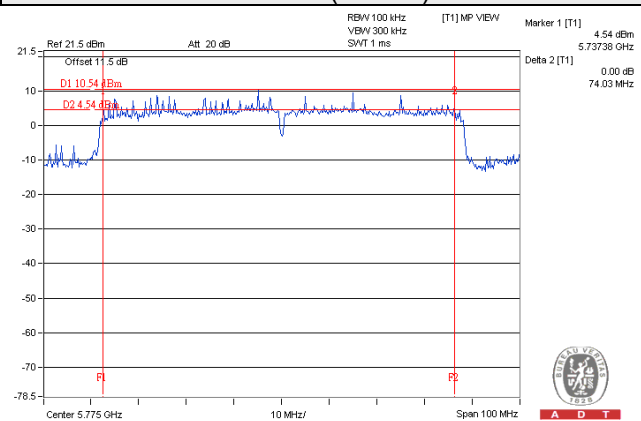
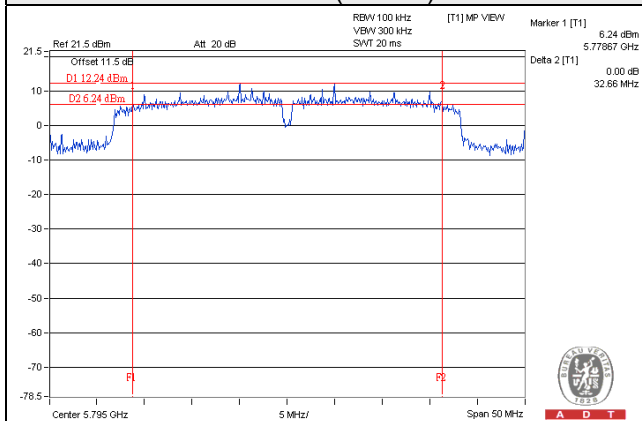

Beamforming Mode

802.11ac (VHT20)

Channel	Frequency (MHz)	6dB Bandwidth (MHz)				Minimum Limit (MHz)	Pass / Fail
		Chain 0	Chain 1	Chain 2	Chain 3		
149	5745	15.74	15.67	17.56	15.34	0.5	Pass
157	5785	15.74	15.98	17.61	15.14	0.5	Pass
165	5825	15.18	17.16	17.61	15.16	0.5	Pass

802.11ac (VHT40)

Channel	Frequency (MHz)	6dB Bandwidth (MHz)				Minimum Limit (MHz)	Pass / Fail
		Chain 0	Chain 1	Chain 2	Chain 3		
151	5755	35.18	33.97	35.27	35.18	0.5	Pass
159	5795	35.14	33.97	35.09	35.14	0.5	Pass

802.11ac (VHT80)

Channel	Frequency (MHz)	6dB Bandwidth (MHz)				Minimum Limit (MHz)	Pass / Fail
		Chain 0	Chain 1	Chain 2	Chain 3		
155	5775	75.42	75.32	75.44	75.43	0.5	Pass

Spectrum Plot of Worst Value

802.11ac (VHT20)

802.11ac (VHT40)

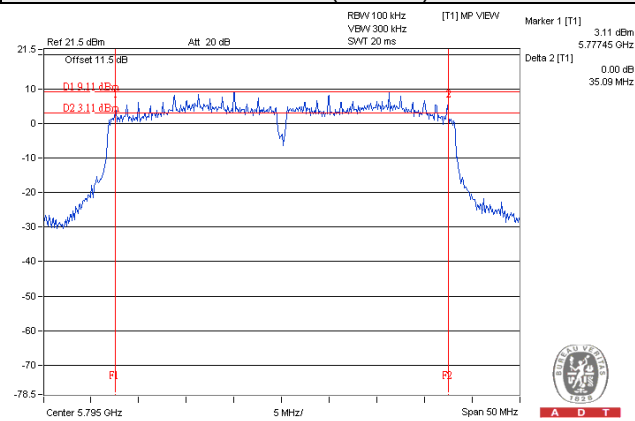
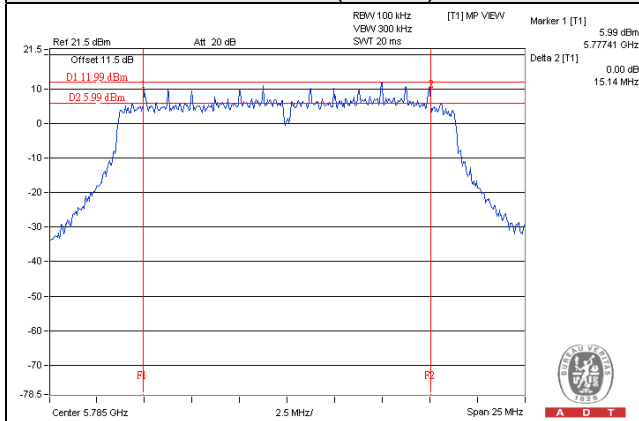

802.11ac (VHT80)

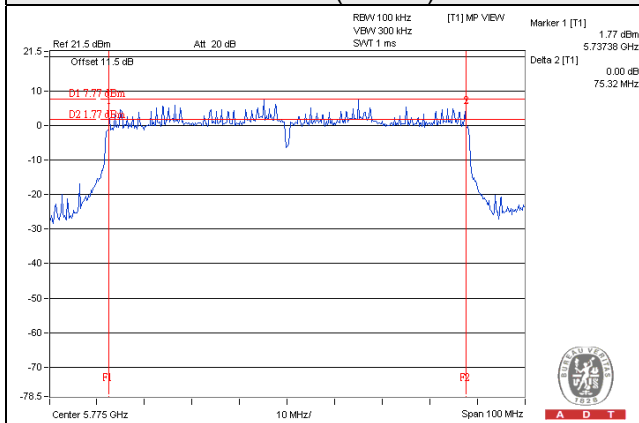

5 Pictures of Test Arrangements

Please refer to the attached file (Test Setup Photo).

Annex A- Radiated Out of Band Emission (OOBE) Measurement (For U-NII-3 band)

CDD Mode

802.11a

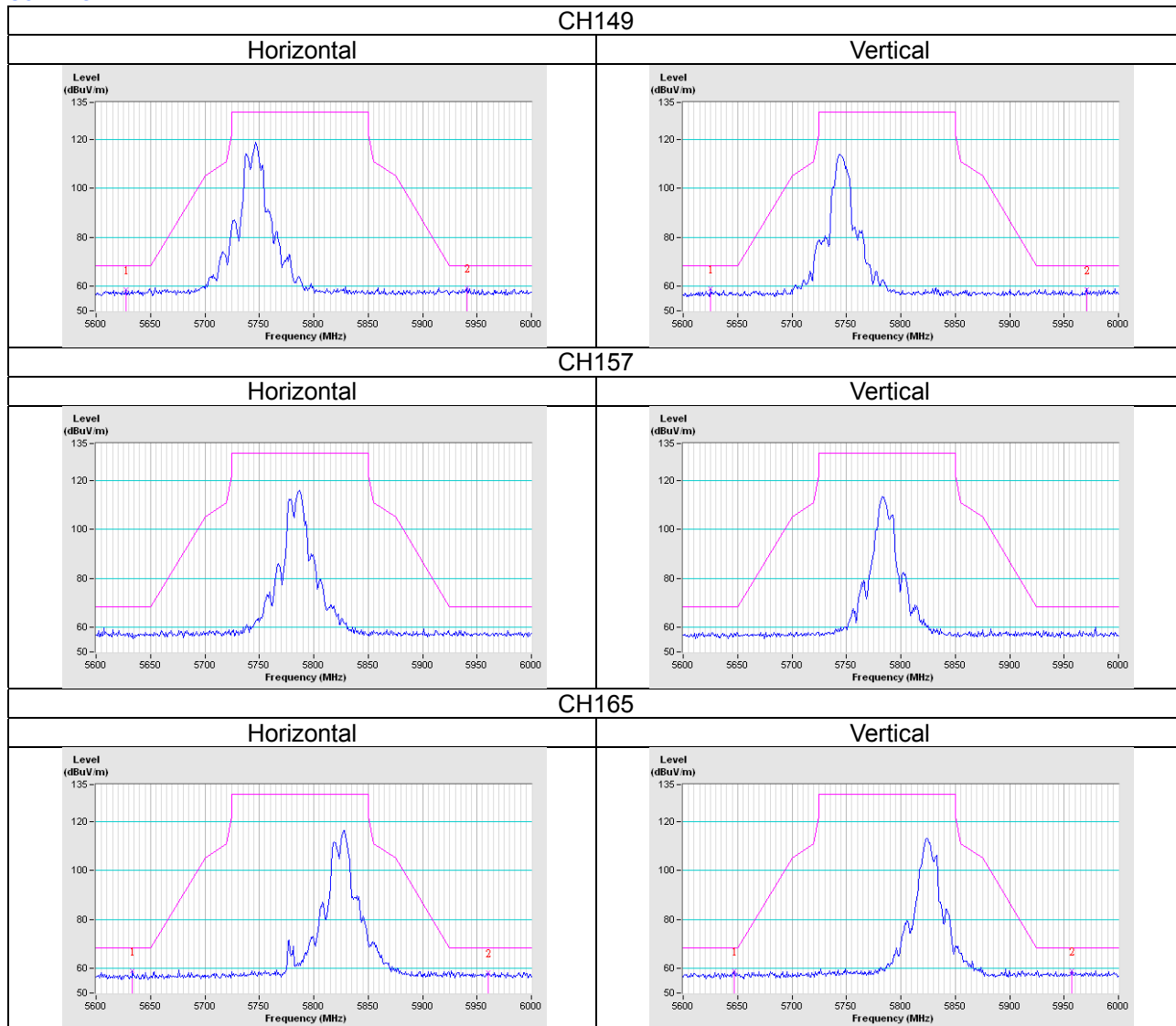

802.11ac (VHT20)

CH149

Horizontal

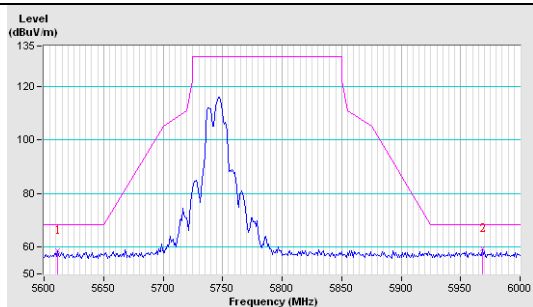

Vertical

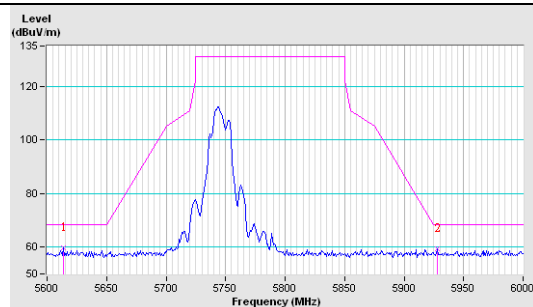

CH157

Horizontal

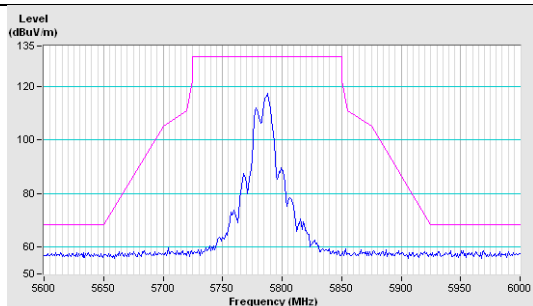

Vertical

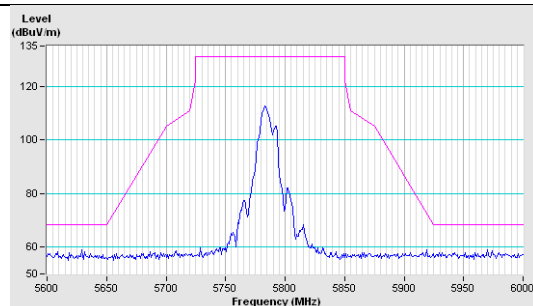

CH165

Horizontal

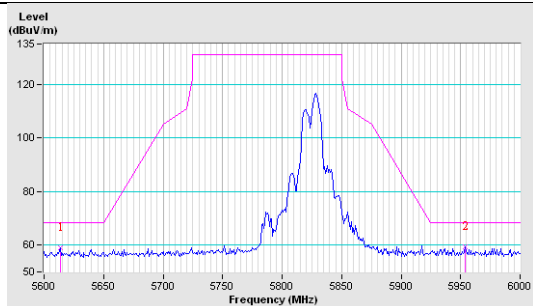

Vertical

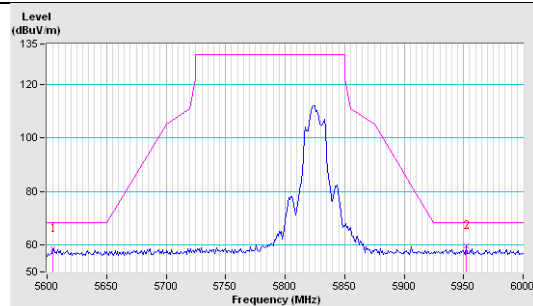

802.11ac (VHT40)

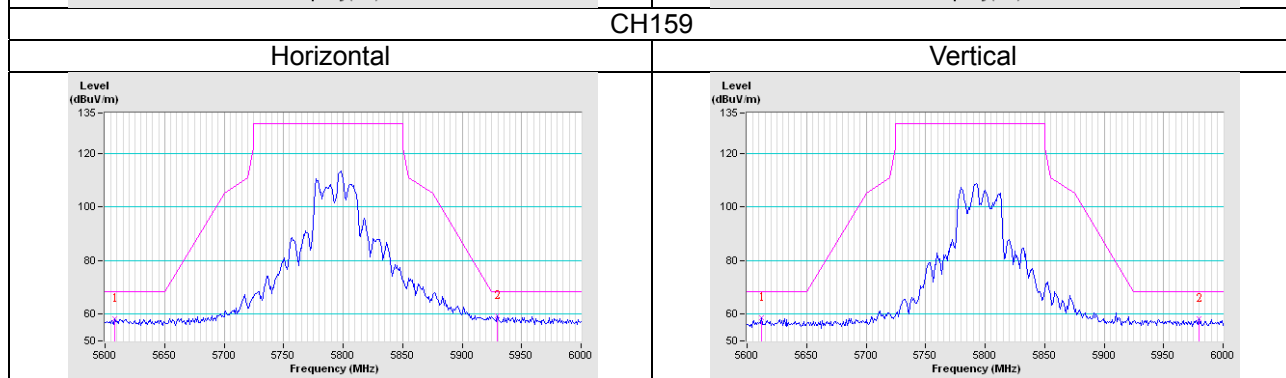
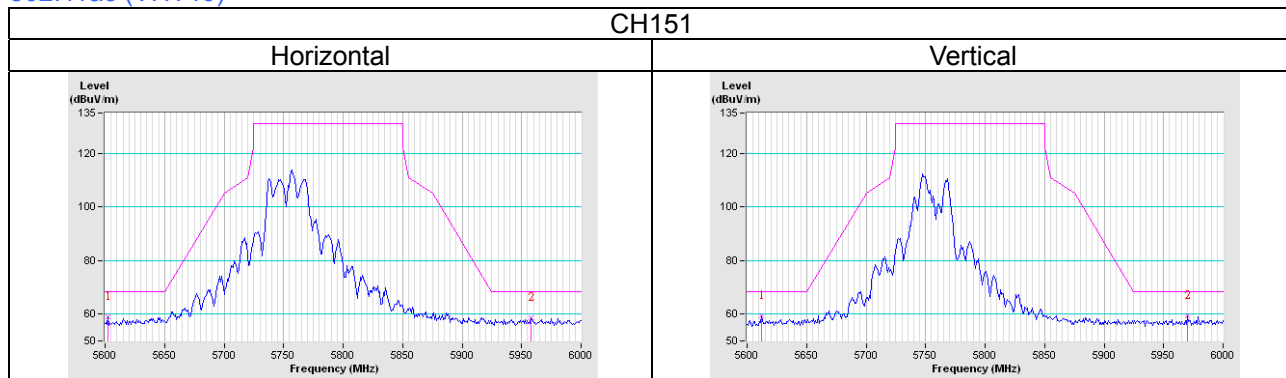

802.11ac (VHT80)

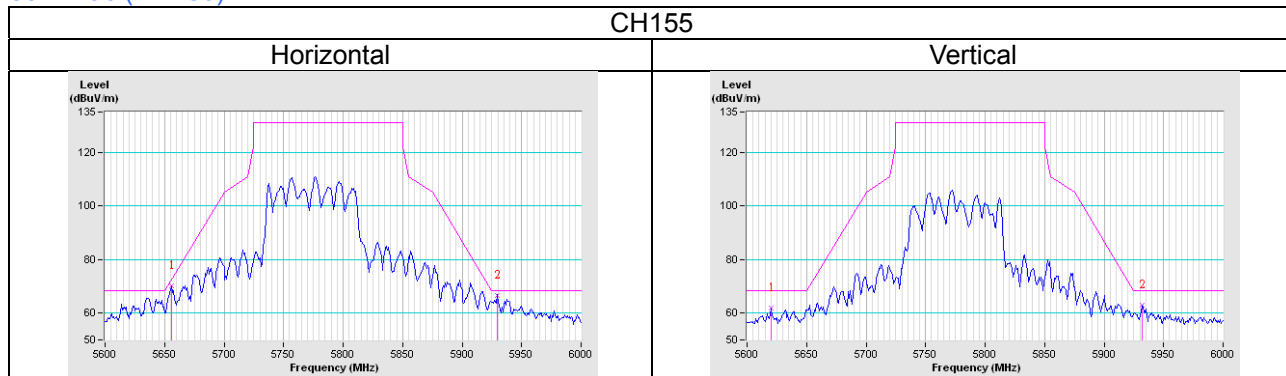

Beamforming Mode

802.11ac (VHT20)

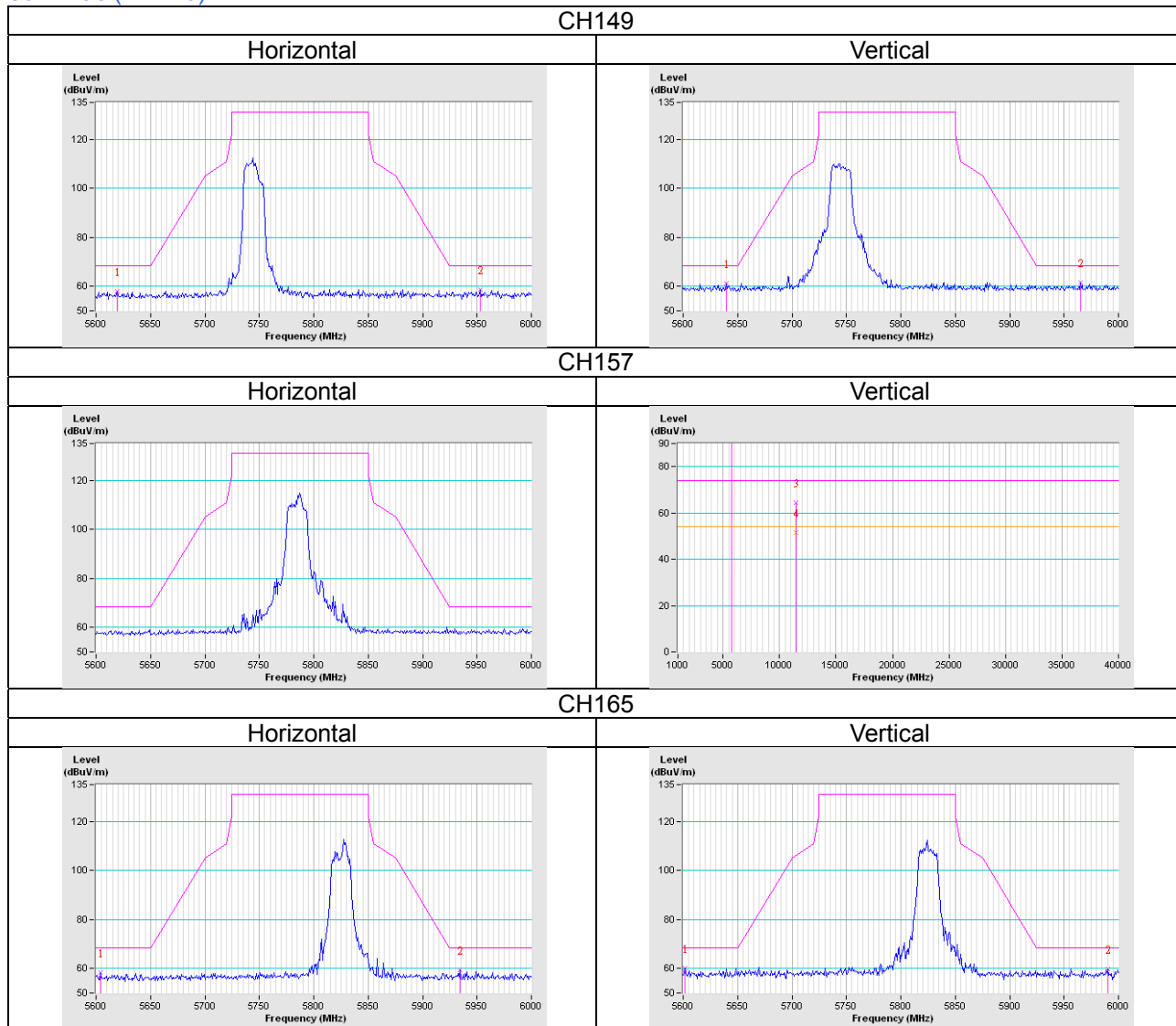

802.11ac (VHT40)

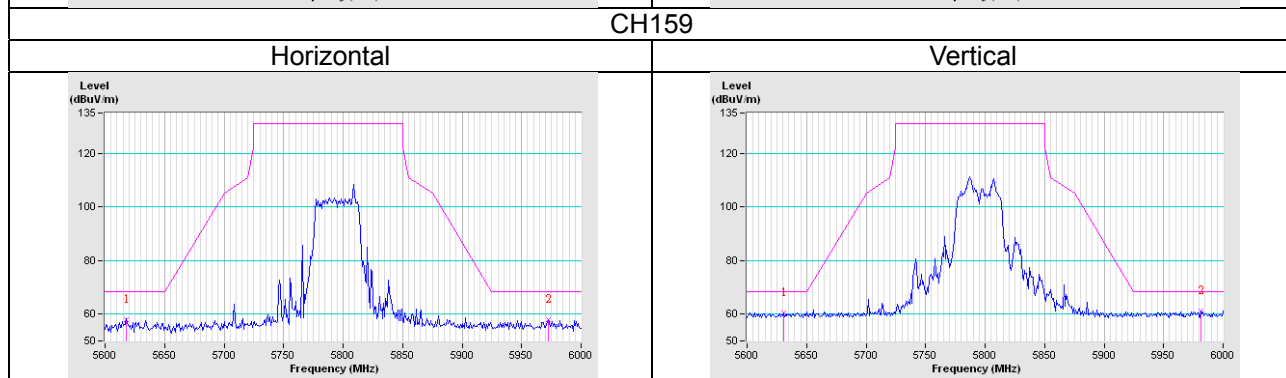
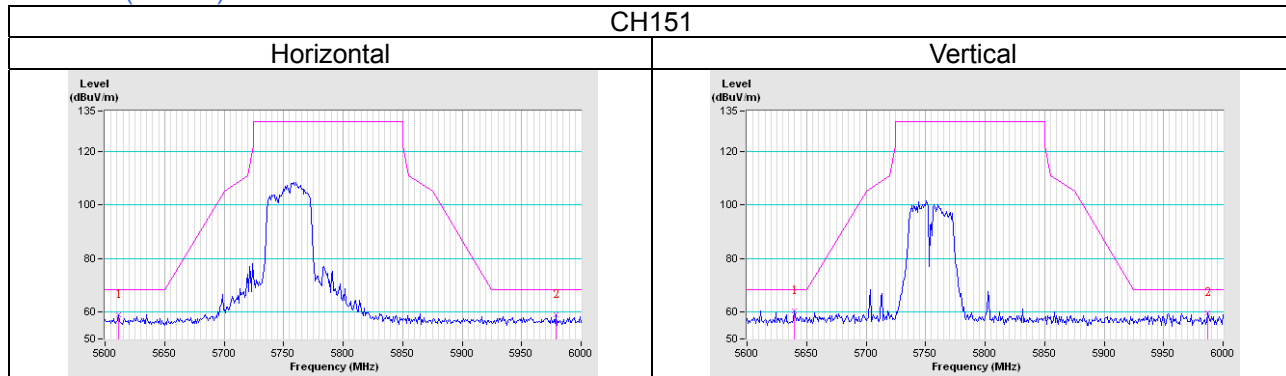

802.11ac (VHT80)

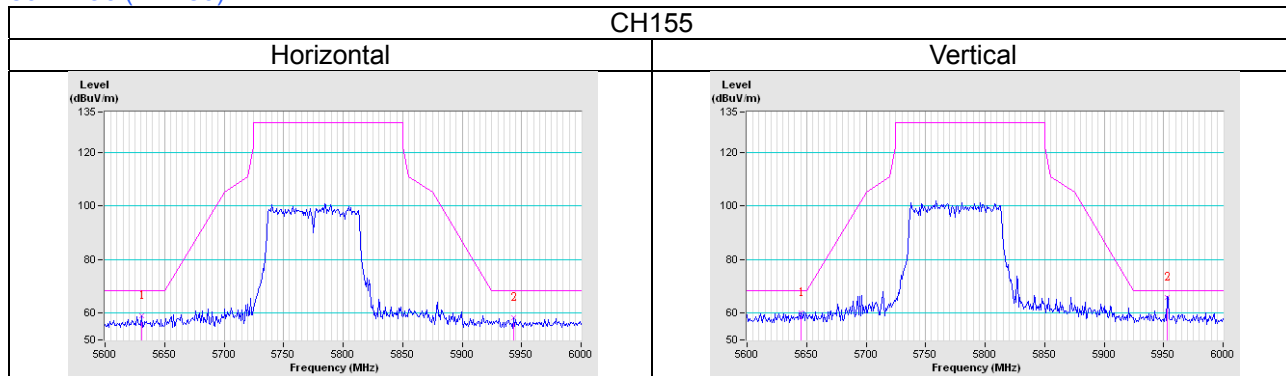

Appendix – Information on the Testing Laboratories

We, Bureau Veritas Consumer Products Services (H.K.) Ltd., Taoyuan Branch, were founded in 1988 to provide our best service in EMC, Radio, Telecom and Safety consultation. Our laboratories are accredited and approved according to ISO/IEC 17025.

If you have any comments, please feel free to contact us at the following:

Linko EMC/RF Lab

Tel: 886-2-26052180

Fax: 886-2-26051924

Hsin Chu EMC/RF/Telecom Lab

Tel: 886-3-6668565

Fax: 886-3-6668323

Hwa Ya EMC/RF/Safety Lab

Tel: 886-3-3183232

Fax: 886-3-3270892

Email: service.adt@tw.bureauveritas.com

Web Site: www.bureauveritas-adt.com

The address and road map of all our labs can be found in our web site also.

--- END ---