

FCC Test Report

Report No.: RF150826C05

FCC ID: PY315100319

Test Model: R7800

Received Date: Aug. 21, 2015

Test Date: Sep. 04 ~ Oct. 28, 2015

Issued Date: Oct. 30, 2015

Applicant: NETGEAR INC.

Address: 350 East Plumeria Drive, San Jose, CA 95134, USA

Issued By: Bureau Veritas Consumer Products Services (H.K.) Ltd., Taoyuan Branch

Lab Address: No. 47-2, 14th Ling, Chia Pau Vil., Lin Kou Dist., New Taipei City, Taiwan, R.O.C.

Test Location: No. 19, Hwa Ya 2nd Rd., Wen Hwa Vil., Kwei Shan Dist., Taoyuan City 33383, TAIWAN (R.O.C.)



This report is for your exclusive use. Any copying or replication of this report to or for any other person or entity, or use of our name or trademark, is permitted only with our prior written permission. This report sets forth our findings solely with respect to the test samples identified herein. The results set forth in this report are not indicative or representative of the quality or characteristics of the lot from which a test sample was taken or any similar or identical product unless specifically and expressly noted. Our report includes all of the tests requested by you and the results thereof based upon the information that you provided to us. You have 60 days from date of issuance of this report to notify us of any material error or omission caused by our negligence, provided, however, that such notice shall be in writing and shall specifically address the issue you wish to raise. A failure to raise such issue within the prescribed time shall constitute your unqualified acceptance of the completeness of this report, the tests conducted and the correctness of the report contents. Unless specifically mentioned, the uncertainty of measurement has been explicitly taken into account to declare the compliance or non-compliance to the specification. The report must not be used by the client to claim product certification, approval, or endorsement by TAF or any government agencies

Table of Contents

Release Control Record	5
1 Certificate of Conformity	6
2 Summary of Test Results	7
2.1 Measurement Uncertainty.....	7
2.2 Modification Record.....	7
3 General Information	8
3.1 General Description of EUT.....	8
3.2 Description of Test Modes.....	11
3.2.1 Test Mode Applicability and Tested Channel Detail.....	12
3.3 Duty Cycle of Test Signal.....	16
3.4 Description of Support Units.....	21
3.4.1 Configuration of System under Test.....	21
3.5 General Description of Applied Standards.....	22
4 Test Types and Results (For 2.4GHz Band)	23
4.1 Radiated Emission and Bandedge Measurement.....	23
4.1.1 Limits of Radiated Emission and Bandedge Measurement.....	23
4.1.2 Test Instruments.....	24
4.1.3 Test Procedures.....	25
4.1.4 Deviation from Test Standard.....	25
4.1.5 Test Set Up.....	26
4.1.6 EUT Operating Conditions.....	26
4.1.7 Test Results.....	27
4.2 Conducted Emission Measurement.....	40
4.2.1 Limits of Conducted Emission Measurement.....	40
4.2.2 Test Instruments.....	40
4.2.3 Test Procedures.....	41
4.2.4 Deviation from Test Standard.....	41
4.2.5 Test Setup.....	41
4.2.6 EUT Operating Conditions.....	41
4.2.7 Test Results.....	42
4.3 6dB Bandwidth Measurement.....	44
4.3.1 Limits of 6dB Bandwidth Measurement.....	44
4.3.2 Test Setup.....	44
4.3.3 Test Instruments.....	44
4.3.4 Test Procedure.....	44
4.3.5 Deviation from Test Standard.....	44
4.3.6 EUT Operating Conditions.....	44
4.3.7 Test Result.....	45
4.4 Conducted Output Power Measurement.....	49
4.4.1 Limits of Conducted Output Power Measurement.....	49
4.4.2 Test Setup.....	49
4.4.3 Test Instruments.....	49
4.4.4 Test Procedures.....	49
4.4.5 Deviation from Test Standard.....	49
4.4.6 EUT Operating Conditions.....	49
4.4.7 Test Results.....	50
4.5 Power Spectral Density Measurement.....	53
4.5.1 Limits of Power Spectral Density Measurement.....	53
4.5.2 Test Setup.....	53
4.5.3 Test Instruments.....	53
4.5.4 Test Procedure.....	53
4.5.5 Deviation from Test Standard.....	53
4.5.6 EUT Operating Condition.....	53

4.5.7	Test Results	54
4.6	Conducted Out of Band Emission Measurement	63
4.6.1	Limits of Conducted Out of Band Emission Measurement	63
4.6.2	Test Setup	63
4.6.3	Test Instruments	63
4.6.4	Test Procedure	63
4.6.5	Deviation from Test Standard	64
4.6.6	EUT Operating Condition	64
4.6.7	Test Results	64
5	Test Types and Results (For 5.0GHz Band).....	97
5.1	Radiated Emission and Bandedge Measurement.....	97
5.1.1	Limits of Radiated Emission and Bandedge Measurement	97
5.1.2	Test Instruments	97
5.1.3	Test Procedures.....	97
5.1.4	Deviation from Test Standard	97
5.1.5	Test Setup.....	97
5.1.6	EUT Operating Conditions.....	97
5.1.7	Test Results	98
5.2	Conducted Emission Measurement	109
5.2.1	Limits of Conducted Emission Measurement	109
5.2.2	Test Instruments	109
5.2.3	Test Procedures.....	109
5.2.4	Deviation from Test Standard	109
5.2.5	Test Setup.....	109
5.2.6	EUT Operating Conditions.....	109
5.2.7	Test Results	110
5.3	6dB Bandwidth Measurement.....	112
5.3.1	Limits of 6dB Bandwidth Measurement	112
5.3.2	Test Setup.....	112
5.3.3	Test Instruments	112
5.3.4	Test Procedure	112
5.3.5	Deviation from Test Standard	112
5.3.6	EUT Operating Conditions.....	112
5.3.7	Test Result.....	113
5.4	Conducted Output Power Measurement.....	119
5.4.1	Limits of Conducted Output Power Measurement	119
5.4.2	Test Setup.....	119
5.4.3	Test Instruments	119
5.4.4	Test Procedures.....	119
5.4.5	Deviation from Test Standard	119
5.4.6	EUT Operating Conditions.....	119
5.4.7	Test Results	120
5.5	Power Spectral Density Measurement.....	123
5.5.1	Limits of Power Spectral Density Measurement	123
5.5.2	Test Setup.....	123
5.5.3	Test Instruments	123
5.5.4	Test Procedure	123
5.5.5	Deviation from Test Standard	123
5.5.6	EUT Operating Condition	123
5.5.7	Test Results	124
5.6	Conducted Out of Band Emission Measurement.....	136
5.6.1	Limits of Conducted Out of Band Emission Measurement	136
5.6.2	Test Setup.....	136
5.6.3	Test Instruments	136
5.6.4	Test Procedure	136
5.6.5	Deviation from Test Standard	136
5.6.6	EUT Operating Condition	136



5.6.7 Test Results 136

6 Pictures of Test Arrangements..... 173

Appendix – Information on the Testing Laboratories 174



A D T

Release Control Record

Issue No.	Description	Date Issued
RF150826C05	Original release	Oct. 30, 2015

1 Certificate of Conformity

Product: Nighthawk X4S AC2600 Smart WiFi Router

Brand: NETGEAR

Test Model: R7800

Sample Status: Engineering sample

Applicant: NETGEAR INC.

Test Date: Sep. 04 ~ Oct. 28, 2015

Standards: 47 CFR FCC Part 15, Subpart C (Section 15.247)
ANSI C63.10:2013

The above equipment has been tested by **Bureau Veritas Consumer Products Services (H.K.) Ltd., Taoyuan Branch**, and found compliance with the requirement of the above standards. The test record, data evaluation & Equipment Under Test (EUT) configurations represented herein are true and accurate accounts of the measurements of the sample's EMC characteristics under the conditions specified in this report.

Prepared by :



Date:

Oct. 30, 2015

Polly Chien / Specialist

Approved by :



Date:

Oct. 30, 2015

Ken Liu / Senior Manager

2 Summary of Test Results

47 CFR FCC Part 15, Subpart C (Section 15.247)			
FCC Clause	Test Item	Result	Remarks
15.207	AC Power Conducted Emission	Pass	Meet the requirement of limit. Minimum passing margin is -14.25dB at 0.51754MHz.
15.205 / 15.209 / 15.247(d)	Radiated Emissions and Band Edge Measurement	Pass	Meet the requirement of limit. Minimum passing margin is -0.1dB at 2483.50MHz.
15.247(d)	Antenna Port Emission	Pass	Meet the requirement of limit.
15.247(a)(2)	6dB bandwidth	Pass	Meet the requirement of limit.
15.247(b)	Conducted power	Pass	Meet the requirement of limit.
15.247(e)	Power Spectral Density	Pass	Meet the requirement of limit.
15.203	Antenna Requirement	Pass	Antenna connector is RSMA not a standard connector.

2.1 Measurement Uncertainty

Where relevant, the following measurement uncertainty levels have been estimated for tests performed on the EUT as specified in CISPR 16-4-2:

Measurement	Frequency	Expanded Uncertainty (k=2) (±)
Conducted Emissions at mains ports	150kHz ~ 30MHz	2.44 dB
Radiated Emissions up to 1 GHz	30MHz ~ 200MHz	3.59 dB
	200MHz ~ 1000MHz	3.60 dB
Radiated Emissions above 1 GHz	1GHz ~ 18GHz	2.29 dB
	18GHz ~ 40GHz	2.29 dB

2.2 Modification Record

There were no modifications required for compliance.

3 General Information

3.1 General Description of EUT

Product	Nighthawk X4S AC2600 Smart WiFi Router
Brand	NETGEAR
Test Model	R7800
Status of EUT	Engineering sample
Power Supply Rating	12Vdc from adapter
Modulation Type	CCK, DQPSK, DBPSK for DSSS 256QAM, 64QAM, 16QAM, QPSK, BPSK for OFDM
Modulation Technology	DSSS, OFDM
Transfer Rate	802.11b: 11.0/ 5.5/ 2.0/ 1.0Mbps 802.11g: 54.0/ 48.0/ 36.0/ 24.0/ 18.0/ 12.0/ 9.0/ 6.0Mbps 802.11a: 54.0/ 48.0/ 36.0/ 24.0/ 18.0/ 12.0/ 9.0/ 6.0Mbps 802.11n: up to 600.0Mbps 802.11ac: up to 1300.0Mbps
Operating Frequency	2.4GHz: 2412 ~ 2462MHz 5.0GHz: 5745 ~ 5825MHz
Number of Channel	2.4GHz: 11 for 802.11b, 802.11g, 802.11n (20MHz) 7 for 802.11n (40MHz) 5.0GHz: 5 for 802.11a, 802.11n (20MHz) , 802.11ac (20MHz) 2 for 802.11n (40MHz), 802.11ac (40MHz) 1 for 802.11ac (80MHz), 802.11ac (80MHz+80MHz)
Output Power	CDD Mode: 974.700mW for 2412 ~ 2462MHz 998.805mW for 5745 ~ 5825MHz Beamforming_NSS1 Mode: 903.458mW for 2412 ~ 2462MHz 699.389mW for 5745 ~ 5825MHz Beamforming_NSS2 Mode: 910.747mW for 2412 ~ 2462MHz 998.441mW for 5745 ~ 5825MHz
Antenna Type	Refer to Note
Antenna Connector	Refer to Note
Accessory Device	Adapter
Data Cable Supplied	1.45m shielded RJ45 cable w/o core

Note:

1. The EUT incorporates a MIMO function. Physically, the EUT provides 4 completed transmitters and 4 receivers.

Band	Modulation Mode	Beamforming Mode	TX Function	Available Channel
2.4GHz	802.11b	Not Support	4TX	1 ~ 11
	802.11g	Not Support	4TX	1 ~ 11
	802.11n (20MHz)	Support (CDD / Nss=1 / Nss=2)	4TX	1 ~ 11
	802.11n (40MHz)	Support (CDD / Nss=1 / Nss=2)	4TX	3 ~ 9
5GHz (U-NII-3 band)	802.11a	Not Support	4TX	149 ~ 165
	802.11n / ac (20MHz)	Support (CDD / Nss=1 / Nss=2)	4TX	149 ~ 165
	802.11n / ac (40MHz)	Support (CDD / Nss=1 / Nss=2)	4TX	151 ~ 159
	802.11ac (80MHz)	Support (CDD / Nss=1 / Nss=2)	4TX	155
	802.11ac (80MHz+80MHz)	Support (CDD / Nss=1)	2TX+2TX	42 + 155

* For 2.4GHz Band and 802.11a/b/g, the EUT doesn't support Beamforming mode.

* The modulation and bandwidth are similar for 802.11n mode for 20MHz / 40MHz and 802.11ac mode for V20MHz / V40MHz, therefore investigated worst case to representative mode in test report. (Final test mode refer section 3.2.1)

* For 5GHz band 802.11n and 802.11ac, after pre-tested two modes (with beamforming mode Nss=1 / 2 and CDD mode) found CDD mode was the worst, therefore chosen for final test for radiated emission and power line conducted emission test and presented in the test report.

2. The EUT uses following antennas.

Ant. Type	Connector Type	Antenna Gain (dBi)				
		2412MHz	2422MHz	2437MHz	2452MHz	2462MHz
Dipole	RSMA	0.21	0.41	0.41	0.21	0.11
		5180MHz	5190MHz	5200MHz	5210MHz	5230MHz
		0.61	0.71	0.71	0.81	0.91
		5240MHz	5745MHz	5755MHz	5775MHz	5785MHz
		0.91	1.61	1.51	1.51	1.51
		5795MHz	5825MHz			
		1.61	1.61			

3. The EUT consumes power from the following adapters.

Adapter 1	
Brand	NETGEAR (LEI)
Model	MU42-3120350-A1
Part No.	332-10762-01
Input Power	100-240Vac, 50/60Hz, 1.5A
Output Power	12Vdc, 3.5A
Power Line	1.8m cable without core attached on adapter

Adapter 2	
Brand	NETGEAR (CWT)
Model	2ABN042F NA
Part No.	332-10761-01
Input Power	100-240Vac, 50/60Hz, 1.3A
Output Power	12Vdc, 3.5A
Power Line	1.85m cable without core attached on adapter

**After pre-tested two of adapters found adapter 2 was the worst case, therefore chosen for final tests and presented in the test report.

3.2 Description of Test Modes

For 2.4GHz:

11 channels are provided for 802.11b, 802.11g and 802.11ac (20MHz):

Channel	Frequency	Channel	Frequency
1	2412MHz	7	2442MHz
2	2417MHz	8	2447MHz
3	2422MHz	9	2452MHz
4	2427MHz	10	2457MHz
5	2432MHz	11	2462MHz
6	2437MHz		

7 channels are provided for 802.11ac (40MHz):

Channel	Frequency	Channel	Frequency
3	2422MHz	7	2442MHz
4	2427MHz	8	2447MHz
5	2432MHz	9	2452MHz
6	2437MHz		

For 5.0GHz (5745 ~ 5825MHz):

5 channels are provided for 802.11a, 802.11n (20MHz), 802.11ac (20MHz):

Channel	Frequency	Channel	Frequency
149	5745MHz	161	5805MHz
153	5765MHz	165	5825MHz
157	5785MHz		

2 channels are provided for 802.11n (40MHz), 802.11ac (40MHz):

Channel	Frequency	Channel	Frequency
151	5755MHz	159	5795MHz

1 channel is provided for 802.11ac (80MHz)

Channel	Frequency
155	5775MHz

3.2.1 Test Mode Applicability and Tested Channel Detail

FOR 2.4GHz:

EUT CONFIGURE MODE	APPLICABLE TO				DESCRIPTION
	RE \geq 1G	RE<1G	PLC	APCM	
-	√	√	√	√	-

Where **RE \geq 1G**: Radiated Emission above 1GHz & Bandedge Measurement

RE<1G: Radiated Emission below 1GHz

PLC: Power Line Conducted Emission

APCM: Antenna Port Conducted Measurement

Note: The EUT had been pre-tested on the positioned of each 3 axis. The worst case was found when positioned on **X-plane**.

Radiated Emission Test (Above 1GHz):

Pre-Scan has been conducted to determine the worst-case mode from all possible combinations between available modulations, data rates and antenna ports (if EUT with antenna diversity architecture).

Following channel(s) was (were) selected for the final test as listed below.

EUT CONFIGURE MODE	MODE	AVAILABLE CHANNEL	TESTED CHANNEL	MODULATION TECHNOLOGY	MODULATION TYPE	DATA RATE (Mbps)
-	802.11b	1 to 11	1, 6, 11	DSSS	DBPSK	1.0
-	802.11g	1 to 11	1, 6, 11	OFDM	BPSK	6.0
-	802.11n (20MHz)	1 to 11	1, 6, 11	OFDM	BPSK	7.2
-	802.11n (40MHz)	3 to 9	3, 6, 9	OFDM	BPSK	15.0

Radiated Emission Test (Below 1GHz):

Pre-Scan has been conducted to determine the worst-case mode from all possible combinations between available modulations, data rates and antenna ports (if EUT with antenna diversity architecture).

Following channel(s) was (were) selected for the final test as listed below.

EUT CONFIGURE MODE	MODE	AVAILABLE CHANNEL	TESTED CHANNEL	MODULATION TECHNOLOGY	MODULATION TYPE	DATA RATE (Mbps)
-	802.11b	1 to 11	1	DSSS	DBPSK	1.0

Power Line Conducted Emission Test:

Pre-Scan has been conducted to determine the worst-case mode from all possible combinations between available modulations, data rates and antenna ports (if EUT with antenna diversity architecture).

Following channel(s) was (were) selected for the final test as listed below.

EUT CONFIGURE MODE	MODE	AVAILABLE CHANNEL	TESTED CHANNEL	MODULATION TECHNOLOGY	MODULATION TYPE	DATA RATE (Mbps)
-	802.11b	1 to 11	1	DSSS	DBPSK	1.0

Antenna Port Conducted Measurement:

- This item includes all test value of each mode, but only includes spectrum plot of worst value of each mode.
- Pre-Scan has been conducted to determine the worst-case mode from all possible combinations between available modulations, data rates and antenna ports (if EUT with antenna diversity architecture).
- Following channel(s) was (were) selected for the final test as listed below.

EUT CONFIGURE MODE	MODE	AVAILABLE CHANNEL	TESTED CHANNEL	MODULATION TECHNOLOGY	MODULATION TYPE	DATA RATE (Mbps)
-	802.11b	1 to 11	1, 6, 11	DSSS	DBPSK	1.0
-	802.11g	1 to 11	1, 6, 11	OFDM	BPSK	6.0
-	802.11n (20MHz)	1 to 11	1, 6, 11	OFDM	BPSK	7.2
-	802.11n (40MHz)	3 to 9	3, 6, 9	OFDM	BPSK	15.0

Test Condition:

APPLICABLE TO	ENVIRONMENTAL CONDITIONS	INPUT POWER	TESTED BY
RE\geq1G	25deg. C, 65%RH, 29deg. C, 60%RH	120Vac, 60Hz	Alan Wu
RE$<$1G	23deg. C, 66%RH	120Vac, 60Hz	Alan Wu
PLC	26deg. C, 63%RH	120Vac, 60Hz	Alan Wu
APCM	25deg. C, 60%RH	120Vac, 60Hz	Antony Lee

FOR 5.0GHz:

EUT CONFIGURE MODE	APPLICABLE TO				DESCRIPTION
	RE \geq 1G	RE<1G	PLC	APCM	
-	√	√	√	√	-

Where **RE \geq 1G:** Radiated Emission above 1GHz & Bandedge Measurement
RE<1G: Radiated Emission below 1GHz
PLC: Power Line Conducted Emission
APCM: Antenna Port Conducted Measurement

Note: The EUT had been pre-tested on the positioned of each 3 axis. The worst case was found when positioned on **X-plane**.

Radiated Emission Test (Above 1GHz):

- Pre-Scan has been conducted to determine the worst-case mode from all possible combinations between available modulations, data rates and antenna ports (if EUT with antenna diversity architecture).
- Following channel(s) was (were) selected for the final test as listed below.

EUT CONFIGURE MODE	MODE	AVAILABLE CHANNEL	TESTED CHANNEL	MODULATION TECHNOLOGY	MODULATION TYPE	DATA RATE (Mbps)
-	802.11a	149 to 165	149, 157, 165	OFDM	BPSK	6.0
-	802.11n (20MHz)	149 to 165	149, 157, 165	OFDM	BPSK	7.2
-	802.11n (40MHz)	151 to 159	151, 159	OFDM	BPSK	15.0
-	802.11ac (80MHz)	155	155	OFDM	BPSK	130.0
-	802.11ac (80MHz+80MHz)	155	155	OFDM	BPSK	130.0

Radiated Emission Test (Below 1GHz):

- Pre-Scan has been conducted to determine the worst-case mode from all possible combinations between available modulations, data rates and antenna ports (if EUT with antenna diversity architecture).
- Following channel(s) was (were) selected for the final test as listed below.

EUT CONFIGURE MODE	MODE	AVAILABLE CHANNEL	TESTED CHANNEL	MODULATION TECHNOLOGY	MODULATION TYPE	DATA RATE (Mbps)
-	802.11n (20MHz)	149 to 165	165	OFDM	BPSK	7.2

Power Line Conducted Emission Test:

- Pre-Scan has been conducted to determine the worst-case mode from all possible combinations between available modulations, data rates and antenna ports (if EUT with antenna diversity architecture).
- Following channel(s) was (were) selected for the final test as listed below.

EUT CONFIGURE MODE	MODE	AVAILABLE CHANNEL	TESTED CHANNEL	MODULATION TECHNOLOGY	MODULATION TYPE	DATA RATE (Mbps)
-	802.11n (20MHz)	149 to 165	165	OFDM	BPSK	7.2

Antenna Port Conducted Measurement:

- This item includes all test value of each mode, but only includes spectrum plot of worst value of each mode.
- Pre-Scan has been conducted to determine the worst-case mode from all possible combinations between available modulations, data rates and antenna ports (if EUT with antenna diversity architecture).
- Following channel(s) was (were) selected for the final test as listed below.

EUT CONFIGURE MODE	MODE	AVAILABLE CHANNEL	TESTED CHANNEL	MODULATION TECHNOLOGY	MODULATION TYPE	DATA RATE (Mbps)
-	802.11a	149 to 165	149, 157, 165	OFDM	BPSK	6.0
-	802.11n (20MHz)	149 to 165	149, 157, 165	OFDM	BPSK	7.2
-	802.11n (40MHz)	151 to 159	151, 159	OFDM	BPSK	15.0
-	802.11ac (80MHz)	155	155	OFDM	BPSK	130.0
-	802.11ac (80MHz+80MHz)	155	155	OFDM	BPSK	130.0

Test Condition:

APPLICABLE TO	ENVIRONMENTAL CONDITIONS	INPUT POWER	TESTED BY
RE\geq1G	25deg. C, 65%RH, 27deg. C, 61%RH	120Vac, 60Hz	Alan Wu
RE$<$1G	23deg. C, 66%RH	120Vac, 60Hz	Alan Wu
PLC	26deg. C, 63%RH	120Vac, 60Hz	Alan Wu
APCM	25deg. C, 60%RH	120Vac, 60Hz	Antony Lee

3.3 Duty Cycle of Test Signal

2.4GHz Band:

CDD Mode

Duty cycle of test signal is > 98 %, duty factor is not required.

Duty cycle of test signal is < 98%, duty factor shall be considered.

802.11b: Duty cycle = $0.147/0.157 = 0.936$, Duty factor = $10 * \log(1/0.936) = 0.29$

802.11g: Duty cycle = $2.025/2.095 = 0.967$, Duty factor = $10 * \log(1/0.967) = 0.15$

802.11n (20MHz): Duty cycle = $4.953/4.973 = 0.996$

802.11n (40MHz): Duty cycle = $2.407/2.472 = 0.974$, Duty factor = $10 * \log(1/0.974) = 0.11$

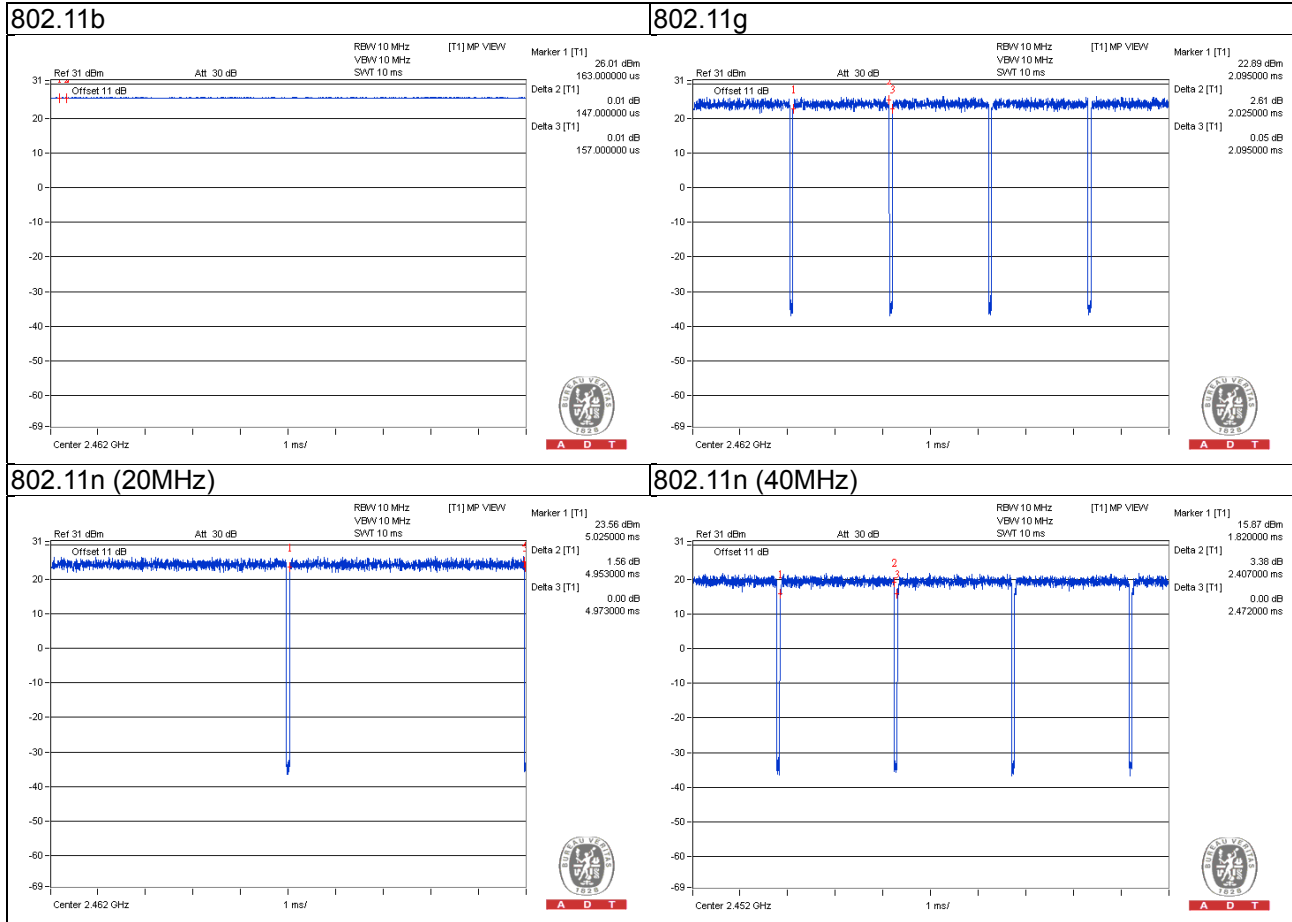

Beamforming_NSS1 Mode

Duty cycle of test signal is > 98 %, duty factor is not required.

Duty cycle is < 98%, duty factor shall be considered.

802.11n (20MHz): Duty cycle = 4.955/5.025 = 0.986

802.11n (40MHz): Duty cycle = 2.408/2.483 = 0.970, Duty factor = $10 * \log(1/0.970) = 0.13$

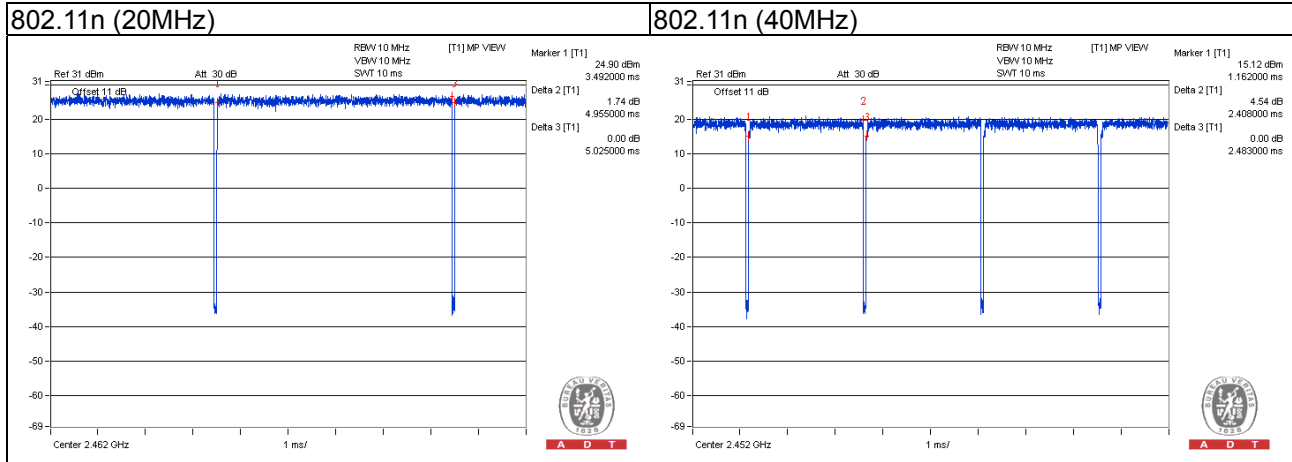

Beamforming_NSS2 Mode

Duty cycle of test signal is > 98 %, duty factor is not required.

Duty cycle is < 98%, duty factor shall be considered.

802.11n (20MHz): Duty cycle = 4.957/5.027 = 0.986

802.11n (40MHz): Duty cycle = 2.407/2.482 = 0.970, Duty factor = $10 * \log(1/0.970) = 0.13$

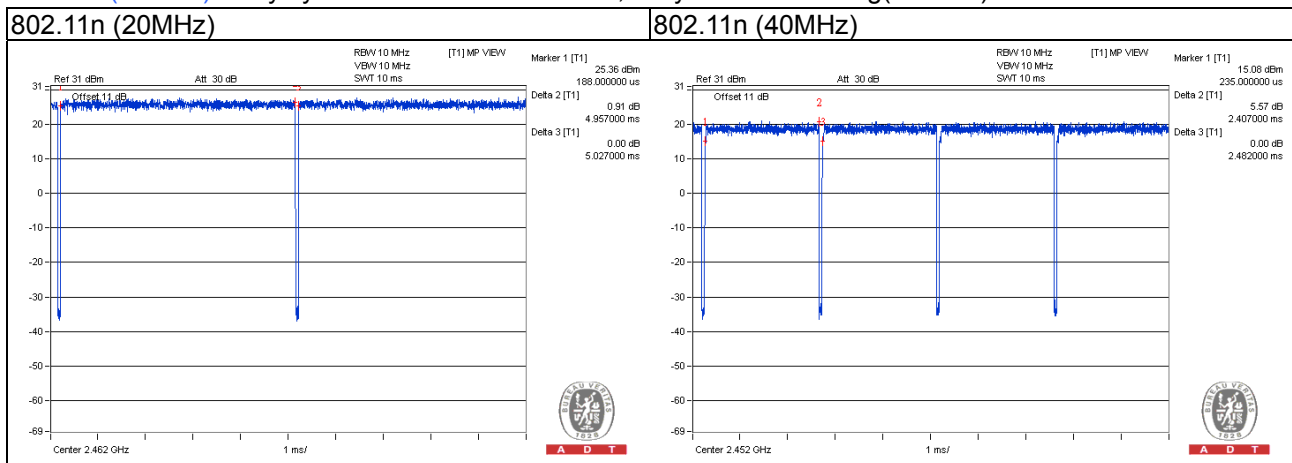

5GHz Band:

CDD Mode

Duty cycle of test signal is < 98%

802.11a: Duty cycle = 1.988/2.100 = 0.947, Duty factor = $10 \cdot \log(1/0.947) = 0.24$

802.11n (20MHz): Duty cycle = 4.913/5.025 = 0.978, Duty factor = $10 \cdot \log(1/0.978) = 0.10$

802.11n (40MHz): Duty cycle = 2.374/2.474 = 0.960, Duty factor = $10 \cdot \log(1/0.960) = 0.18$

802.11ac (80MHz): Duty cycle = 1.075/1.250 = 0.860, Duty factor = $10 \cdot \log(1/0.860) = 0.66$

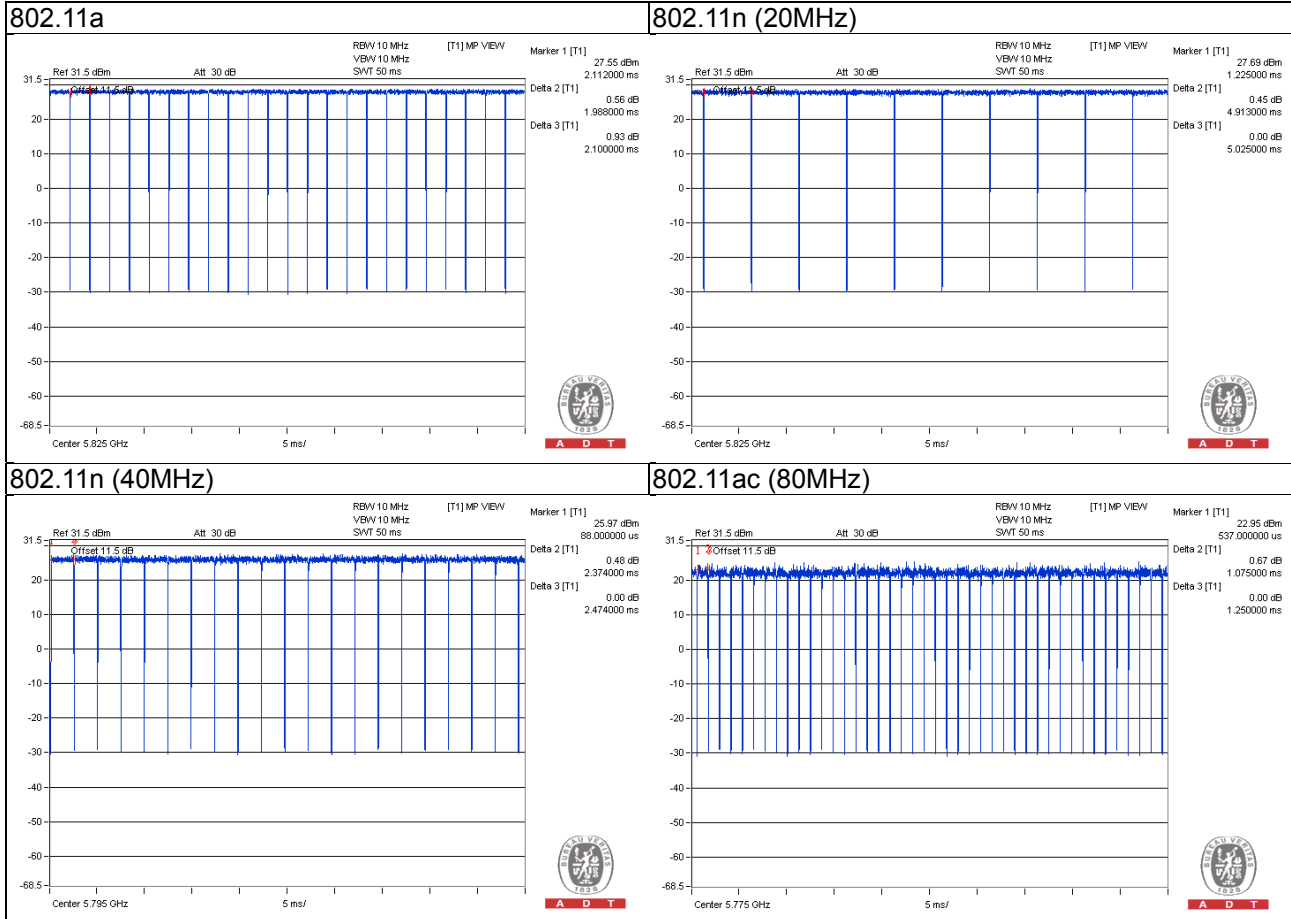

Beamforming_NSS1 Mode

Duty cycle of test signal is > 98 %, duty factor is not required.

Duty cycle is < 98%, duty factor shall be considered.

802.11n (20MHz): Duty cycle = $4.925/5.025 = 0.9801$

802.11n (40MHz): Duty cycle = $2.325/2.462 = 0.944$, Duty factor = $10 * \log(1/0.944) = 0.25$

802.11ac (80MHz): Duty cycle = $1.100/1.250 = 0.880$, Duty factor = $10 * \log(1/0.880) = 0.56$



Beamforming_NSS2 Mode

Duty cycle is < 98%, duty factor shall be considered.

802.11n (20MHz): Duty cycle = 4.951/5.063 = 0.978, Duty factor = $10 * \log(1/0.978) = 0.10$

802.11n (40MHz): Duty cycle = 2.388/2.513 = 0.950, Duty factor = $10 * \log(1/0.950) = 0.22$

802.11ac (80MHz): Duty cycle = 1.087/1.200 = 0.906, Duty factor = $10 * \log(1/0.906) = 0.43$



3.4 Description of Support Units

The EUT has been tested as an independent unit together with other necessary accessories or support units. The following support units or accessories were used to form a representative test configuration during the tests.

ID	Product	Brand	Model No.	Serial No.	FCC ID	Remarks
A.	Notebook	DELL	E5420	BPQ7MQ1	FCC DoC Approved	-
B.	USB HDD x 2	TOSHIBA	v63700-G-1.5G	13GUTE2ZTTV2	FCC DoC Approved	-
		TOSHIBA	v63700-G-1.5G	3F8PBV6ZTTV2	FCC DoC Approved	-
C.	E-SATA HDD	Sarotech	FHD-354US	E80P048380919	FCC DoC Approved	-
D.	Load	NA	NA	NA	NA	-

Note:

1. All power cords of the above support units are non-shielded (1.8m).
2. Item A acted as communication partner to transfer data.

ID	Descriptions	Qty.	Length (m)	Shielding (Yes/No)	Cores (Qty.)	Remarks
1.	RJ 45	1	3	N	0	-
2.	RJ 45	4	1.8	N	0	-
3.	USB	2	1.8	Y	0	-
4.	E-SATA	1	0.5	Y	0	-

3.4.1 Configuration of System under Test

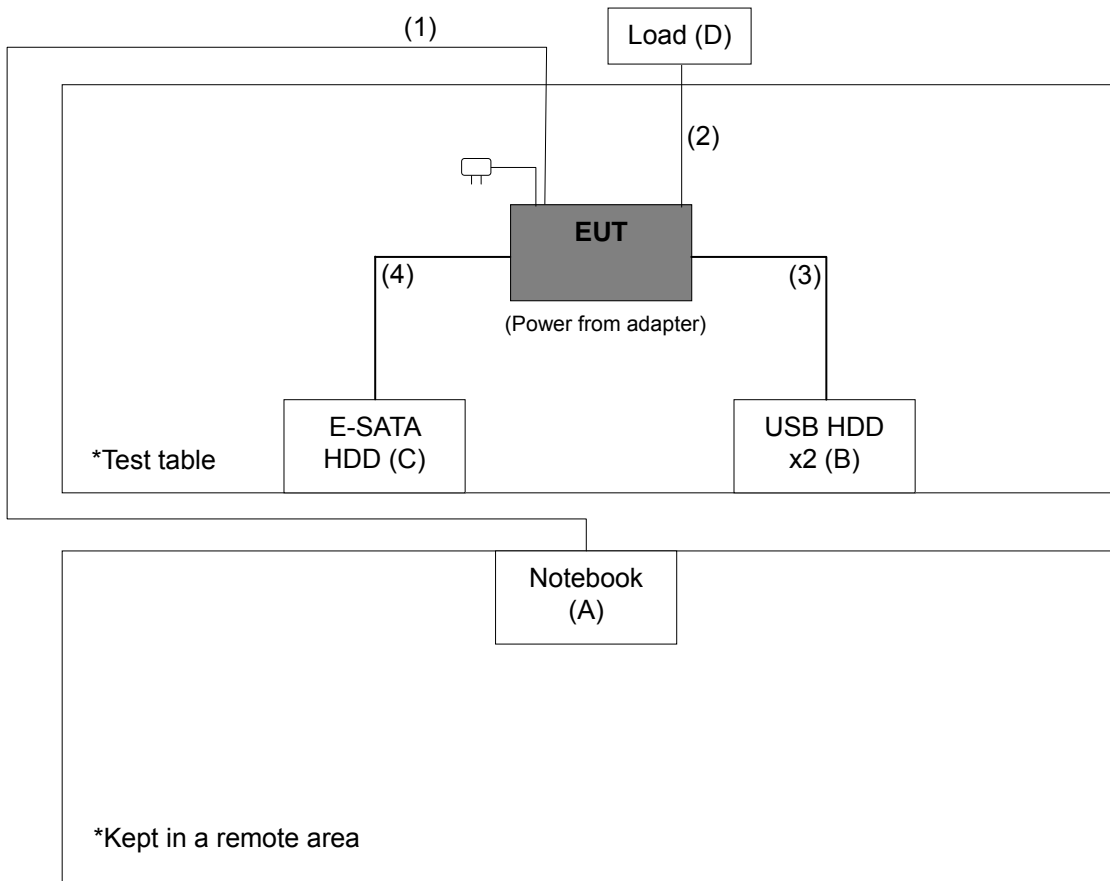

3.5 General Description of Applied Standards

The EUT is a RF Product. According to the specifications of the manufacturer, it must comply with the requirements of the following standards:

FCC Part 15, Subpart C (15.247)

558074 D01 DTS Meas Guidance v03r03

662911 D01 Multiple Transmitter Output v02r01

644545 D01 Guidance for IEEE 802 11ac v01r02 Old Rules

ANSI C63.10-2013

All test items have been performed and recorded as per the above standards.

Note: The EUT is also considered as a kind of computer peripheral, because the connection to computer is necessary for typical use. It has been verified to comply with the requirements of FCC Part 15, Subpart B, Class B (DoC). The test report has been issued separately.

4 Test Types and Results (For 2.4GHz Band)

4.1 Radiated Emission and Bandedge Measurement

4.1.1 Limits of Radiated Emission and Bandedge Measurement

Radiated emissions which fall in the restricted bands must comply with the radiated emission limits specified as below table. Other emissions shall be at least 30dB below the highest level of the desired power:

Frequencies (MHz)	Field Strength (microvolts/meter)	Measurement Distance (meters)
0.009 ~ 0.490	2400/F(kHz)	300
0.490 ~ 1.705	24000/F(kHz)	30
1.705 ~ 30.0	30	30
30 ~ 88	100	3
88 ~ 216	150	3
216 ~ 960	200	3
Above 960	500	3

Note:

1. The lower limit shall apply at the transition frequencies.
2. Emission level (dBuV/m) = 20 log Emission level (uV/m).
3. For frequencies above 1000MHz, the field strength limits are based on average detector, however, the peak field strength of any emission shall not exceed the maximum permitted average limits, specified above by more than 30dB under any condition of modulation.

4.1.2 Test Instruments

Description & Manufacturer	Model No.	Serial No.	Date of Calibration	Due Date of Calibration
Test Receiver ROHDE & SCHWARZ	ESCI	100424	Oct. 06, 2014	Oct. 05, 2015
			Oct. 12, 2015	Oct. 11, 2016
Spectrum Analyzer ROHDE & SCHWARZ	FSP40	100040	Jul. 08, 2015	Jul. 07, 2016
BILOG Antenna SCHWARZBECK	VULB9168	9168-155	Feb. 06, 2015	Feb. 05, 2016
HORN Antenna SCHWARZBECK	BBHA 9120D	9120D-1170	Feb. 05, 2015	Feb. 04, 2016
HORN Antenna SCHWARZBECK	BBHA 9170	BBHA9170241	Feb. 09, 2015	Feb. 08, 2016
Preamplifier Agilent	8449B	3008A01960	Aug. 09, 2015	Aug. 08, 2016
Preamplifier Agilent	8447D	2944A10631	Aug. 09, 2015	Aug. 08, 2016
RF signal cable HUBER+SUHNER	SUCOFLEX 104	Cable-CH4-02(295 012+309220)	Aug. 09, 2015	Aug. 08, 2016
RF signal cable HUBER+SUHNER	SUCOFLEX 104	Cable-CH4-03(250 724)	Aug. 09, 2015	Aug. 08, 2016
Software BV ADT	ADT_Radiated_ V7.6.15.9.4	NA	NA	NA
Antenna Tower inn-co GmbH	MA 4000	010303	NA	NA
Antenna Tower Controller BV ADT	AT100	AT93021703	NA	NA
Turn Table BV ADT	TT100.	TT93021703	NA	NA
Turn Table Controller BV ADT	SC100.	SC93021703	NA	NA
26GHz ~ 40GHz Amplifier	EM26400	815221	Oct. 18, 2014	Oct. 17, 2015
			Oct. 18, 2015	Oct. 17, 2016
High Speed Peak Power Meter	ML2495A	0824011	Jul. 09, 2015	Jul. 08, 2016
Power Sensor	MA2411B	0738171	Jul. 09, 2015	Jul. 08, 2016

- Note:**
1. The calibration interval of the above test instruments is 12 months and the calibrations are traceable to NML/ROC and NIST/USA.
 2. The test was performed in HwaYa Chamber 4.
 3. The horn antenna and HP preamplifier (model: 8449B) are used only for the measurement of emission frequency above 1GHz if tested.
 4. The FCC Site Registration No. is 460141.
 5. The IC Site Registration No. is IC7450F-4.

4.1.3 Test Procedures

- a. The EUT was placed on the top of a rotating table 0.8 meters above the ground at 3 meter chamber room for test. The table was rotated 360 degrees to determine the position of the highest radiation.
- b. The EUT was set 3 meters away from the interference-receiving antenna, which was mounted on the top of a variable-height antenna tower.
- c. The height of antenna is varied from one meter to four meters above the ground to determine the maximum value of the field strength. Both horizontal and vertical polarizations of the antenna are set to make the measurement.
- d. For each suspected emission, the EUT was arranged to its worst case and then the antenna was tuned to heights from 1 meter to 4 meters and the rotatable table was turned from 0 degrees to 360 degrees to find the maximum reading.
- e. The test-receiver system was set to quasi-peak detect function and specified bandwidth with maximum hold mode when the test frequency is below 1 GHz.
- f. The test-receiver system was set to peak and average detect function and specified bandwidth with maximum hold mode when the test frequency is above 1 GHz. If the peak reading value also meets average limit, measurement with the average detector is unnecessary.

Note:

1. For emission measurements above 1 GHz, the EUT shall be placed at a height of 1.5 m above the ground at 3 meter chamber room for test
2. The resolution bandwidth and video bandwidth of test receiver/spectrum analyzer is 120kHz for Quasi-peak detection (QP) at frequency below 1GHz.
3. The resolution bandwidth of test receiver/spectrum analyzer is 1 MHz and the video bandwidth is 3 MHz for Peak detection (PK) at frequency above 1GHz.
4. The resolution bandwidth of test receiver/spectrum analyzer is 1MHz and the video bandwidth is 3MHz for RMS Average (Duty cycle < 98%) for Average detection (AV) at frequency above 1GHz, then the measurement results was added to a correction factor ($10 \log(1/\text{duty cycle})$).
5. The resolution bandwidth of test receiver/spectrum analyzer is 1MHz and the video bandwidth is 10Hz (Duty cycle $\geq 98\%$) for Average detection (AV) at frequency above 1GHz.
6. All modes of operation were investigated and the worst-case emissions are reported.

4.1.4 Deviation from Test Standard

No deviation.

4.1.5 Test Set Up

<Frequency Range below 1GHz>

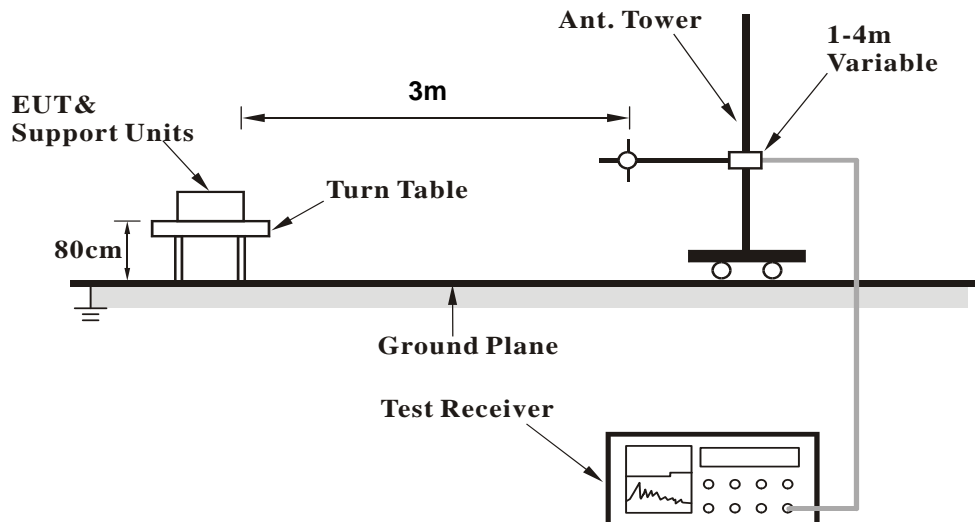

<Frequency Range above 1GHz>

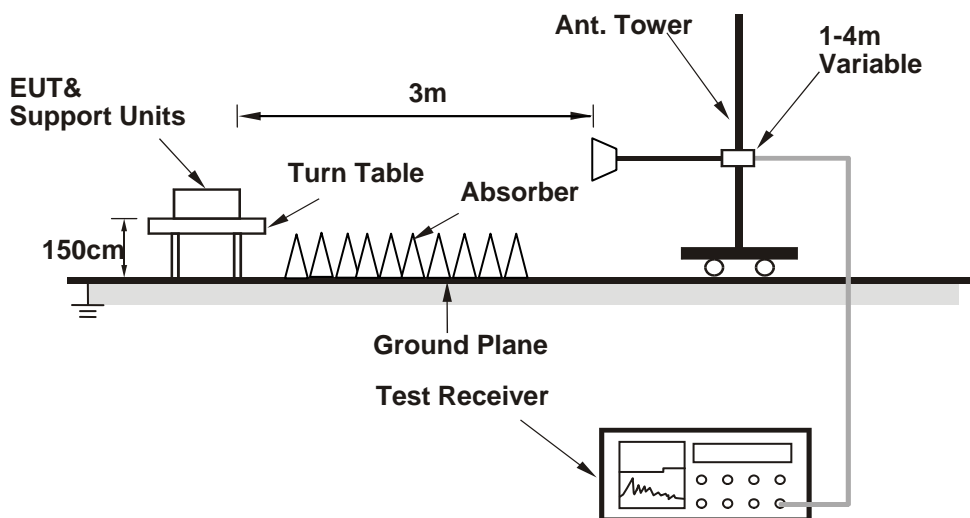

For the actual test configuration, please refer to the attached file (Test Setup Photo).

4.1.6 EUT Operating Conditions

- Placed the EUT on the testing table.
- Prepared a notebook to act as communication partner and placed it outside of testing area.
- The communication partner connected with EUT via a RJ45 cable and ran a test program (provided by manufacturer) to enable EUT under transmission condition continuously at specific channel frequency.
- The communication partner sent data to EUT by command "PING".
- The necessary accessories enable the system in full functions.

4.1.7 Test Results

Above 1GHz Worst-case Data:

802.11b

CHANNEL	TX Channel 1	DETECTOR	Peak (PK)
FREQUENCY RANGE	1GHz ~ 25GHz	FUNCTION	Average (AV)

ANTENNA POLARITY & TEST DISTANCE: HORIZONTAL AT 3 M								
NO.	FREQ. (MHz)	EMISSION LEVEL (dBuV/m)	LIMIT (dBuV/m)	MARGIN (dB)	ANTENNA HEIGHT (m)	TABLE ANGLE (Degree)	RAW VALUE (dBuV)	CORRECTION FACTOR (dB/m)
1	2390.00	56.4 PK	74.0	-17.6	2.07 H	102	24.80	31.60
2	2390.00	43.4 AV	54.0	-10.6	2.07 H	102	11.80	31.60
3	*2412.00	108.8 PK			2.07 H	102	77.00	31.80
4	*2412.00	106.5 AV			2.07 H	102	74.70	31.80
5	4824.00	47.6 PK	74.0	-26.4	1.09 H	158	42.70	4.90
6	4824.00	37.1 AV	54.0	-16.9	1.09 H	158	32.20	4.90
ANTENNA POLARITY & TEST DISTANCE: VERTICAL AT 3 M								
NO.	FREQ. (MHz)	EMISSION LEVEL (dBuV/m)	LIMIT (dBuV/m)	MARGIN (dB)	ANTENNA HEIGHT (m)	TABLE ANGLE (Degree)	RAW VALUE (dBuV)	CORRECTION FACTOR (dB/m)
1	2390.00	61.4 PK	74.0	-12.6	1.02 V	128	29.80	31.60
2	2390.00	53.0 AV	54.0	-1.0	1.02 V	128	21.40	31.60
3	*2412.00	120.1 PK			1.02 V	128	88.30	31.80
4	*2412.00	116.2 AV			1.02 V	128	84.40	31.80
5	4824.00	50.5 PK	74.0	-23.5	1.07 V	226	45.60	4.90
6	4824.00	45.4 AV	54.0	-8.6	1.07 V	226	40.50	4.90

REMARKS:

1. Emission Level(dBuV/m) = Raw Value(dBuV) + Correction Factor(dB/m)
2. Correction Factor(dB/m) = Antenna Factor(dB/m) + Cable Factor(dB)
– Pre-Amplifier Factor(dB)
3. The other emission levels were very low against the limit.
4. Margin value = Emission Level – Limit value
5. " * " : Fundamental frequency.

CHANNEL	TX Channel 6	DETECTOR FUNCTION	Peak (PK)
FREQUENCY RANGE	1GHz ~ 25GHz		Average (AV)

ANTENNA POLARITY & TEST DISTANCE: HORIZONTAL AT 3 M

NO.	FREQ. (MHz)	EMISSION LEVEL (dBuV/m)	LIMIT (dBuV/m)	MARGIN (dB)	ANTENNA HEIGHT (m)	TABLE ANGLE (Degree)	RAW VALUE (dBuV)	CORRECTION FACTOR (dB/m)
1	*2437.00	108.2 PK			2.05 H	131	76.30	31.90
2	*2437.00	105.6 AV			2.05 H	131	73.70	31.90
3	4874.00	48.5 PK	74.0	-25.5	1.01 H	153	43.50	5.00
4	4874.00	38.1 AV	54.0	-15.9	1.01 H	153	33.10	5.00

ANTENNA POLARITY & TEST DISTANCE: VERTICAL AT 3 M

NO.	FREQ. (MHz)	EMISSION LEVEL (dBuV/m)	LIMIT (dBuV/m)	MARGIN (dB)	ANTENNA HEIGHT (m)	TABLE ANGLE (Degree)	RAW VALUE (dBuV)	CORRECTION FACTOR (dB/m)
1	*2437.00	121.1 PK			1.98 V	195	89.20	31.90
2	*2437.00	117.2 AV			1.98 V	195	85.30	31.90
3	4874.00	53.1 PK	74.0	-20.9	1.00 V	224	48.10	5.00
4	4874.00	48.6 AV	54.0	-5.4	1.00 V	224	43.60	5.00

REMARKS:

1. Emission Level(dBuV/m) = Raw Value(dBuV) + Correction Factor(dB/m)
2. Correction Factor(dB/m) = Antenna Factor(dB/m) + Cable Factor(dB)
– Pre-Amplifier Factor(dB)
3. The other emission levels were very low against the limit.
4. Margin value = Emission Level – Limit value
5. " * ": Fundamental frequency.



CHANNEL	TX Channel 11	DETECTOR FUNCTION	Peak (PK)
FREQUENCY RANGE	1GHz ~ 25GHz		Average (AV)

ANTENNA POLARITY & TEST DISTANCE: HORIZONTAL AT 3 M

NO.	FREQ. (MHz)	EMISSION LEVEL (dBuV/m)	LIMIT (dBuV/m)	MARGIN (dB)	ANTENNA HEIGHT (m)	TABLE ANGLE (Degree)	RAW VALUE (dBuV)	CORRECTION FACTOR (dB/m)
1	*2462.00	110.0 PK			1.87 H	181	78.00	32.00
2	*2462.00	107.8 AV			1.87 H	181	75.80	32.00
3	2483.50	56.8 PK	74.0	-17.2	1.87 H	181	24.80	32.00
4	2483.50	44.2 AV	54.0	-9.8	1.87 H	181	12.20	32.00
5	4924.00	48.8 PK	74.0	-25.2	1.00 H	159	43.70	5.10
6	4924.00	38.3 AV	54.0	-15.7	1.00 H	159	33.20	5.10

ANTENNA POLARITY & TEST DISTANCE: VERTICAL AT 3 M

NO.	FREQ. (MHz)	EMISSION LEVEL (dBuV/m)	LIMIT (dBuV/m)	MARGIN (dB)	ANTENNA HEIGHT (m)	TABLE ANGLE (Degree)	RAW VALUE (dBuV)	CORRECTION FACTOR (dB/m)
1	*2462.00	121.1 PK			2.10 V	155	89.10	32.00
2	*2462.00	117.2 AV			2.10 V	155	85.20	32.00
3	2483.50	62.6 PK	74.0	-11.4	2.10 V	155	30.60	32.00
4	2483.50	52.9 AV	54.0	-1.1	2.10 V	155	20.90	32.00
5	4924.00	50.7 PK	74.0	-23.3	1.26 V	98	45.60	5.10
6	4924.00	45.7 AV	54.0	-8.3	1.26 V	98	40.60	5.10

REMARKS:

1. Emission Level(dBuV/m) = Raw Value(dBuV) + Correction Factor(dB/m)
2. Correction Factor(dB/m) = Antenna Factor(dB/m) + Cable Factor(dB)
– Pre-Amplifier Factor(dB)
3. The other emission levels were very low against the limit.
4. Margin value = Emission Level – Limit value
5. " * ": Fundamental frequency.

802.11g

CHANNEL	TX Channel 1	DETECTOR FUNCTION	Peak (PK)
FREQUENCY RANGE	1GHz ~ 25GHz		Average (AV)

ANTENNA POLARITY & TEST DISTANCE: HORIZONTAL AT 3 M								
NO.	FREQ. (MHz)	EMISSION LEVEL (dBuV/m)	LIMIT (dBuV/m)	MARGIN (dB)	ANTENNA HEIGHT (m)	TABLE ANGLE (Degree)	RAW VALUE (dBuV)	CORRECTION FACTOR (dB/m)
1	2390.00	59.1 PK	74.0	-14.9	2.31 H	185	27.50	31.60
2	2390.00	46.7 AV	54.0	-7.3	2.31 H	185	15.10	31.60
3	*2412.00	109.6 PK			2.31 H	185	77.80	31.80
4	*2412.00	98.6 AV			2.31 H	185	66.80	31.80
5	4824.00	46.5 PK	74.0	-27.5	1.08 H	158	41.60	4.90
6	4824.00	34.4 AV	54.0	-19.6	1.08 H	158	29.50	4.90

ANTENNA POLARITY & TEST DISTANCE: VERTICAL AT 3 M								
NO.	FREQ. (MHz)	EMISSION LEVEL (dBuV/m)	LIMIT (dBuV/m)	MARGIN (dB)	ANTENNA HEIGHT (m)	TABLE ANGLE (Degree)	RAW VALUE (dBuV)	CORRECTION FACTOR (dB/m)
1	2390.00	67.0 PK	74.0	-7.0	1.19 V	104	35.40	31.60
2	2390.00	53.8 AV	54.0	-0.2	1.19 V	104	22.20	31.60
3	*2412.00	117.9 PK			1.19 V	104	86.10	31.80
4	*2412.00	107.4 AV			1.19 V	104	75.60	31.80
5	4824.00	47.5 PK	74.0	-26.5	1.17 V	48	42.60	4.90
6	4824.00	35.5 AV	54.0	-18.5	1.17 V	48	30.60	4.90

REMARKS:

1. Emission Level(dBuV/m) = Raw Value(dBuV) + Correction Factor(dB/m)
2. Correction Factor(dB/m) = Antenna Factor(dB/m) + Cable Factor(dB)
– Pre-Amplifier Factor(dB)
3. The other emission levels were very low against the limit.
4. Margin value = Emission Level – Limit value
5. " * ": Fundamental frequency.

CHANNEL	TX Channel 6	DETECTOR FUNCTION	Peak (PK)
FREQUENCY RANGE	1GHz ~ 25GHz		Average (AV)

ANTENNA POLARITY & TEST DISTANCE: HORIZONTAL AT 3 M

NO.	FREQ. (MHz)	EMISSION LEVEL (dBuV/m)	LIMIT (dBuV/m)	MARGIN (dB)	ANTENNA HEIGHT (m)	TABLE ANGLE (Degree)	RAW VALUE (dBuV)	CORRECTION FACTOR (dB/m)
1	*2437.00	112.3 PK			2.30 H	188	80.40	31.90
2	*2437.00	101.4 AV			2.30 H	188	69.50	31.90
3	4874.00	46.7 PK	74.0	-27.3	1.00 H	155	41.70	5.00
4	4874.00	34.9 AV	54.0	-19.1	1.00 H	155	29.90	5.00

ANTENNA POLARITY & TEST DISTANCE: VERTICAL AT 3 M

NO.	FREQ. (MHz)	EMISSION LEVEL (dBuV/m)	LIMIT (dBuV/m)	MARGIN (dB)	ANTENNA HEIGHT (m)	TABLE ANGLE (Degree)	RAW VALUE (dBuV)	CORRECTION FACTOR (dB/m)
1	*2437.00	124.1 PK			2.42 V	186	92.20	31.90
2	*2437.00	113.4 AV			2.42 V	186	81.50	31.90
3	4874.00	46.9 PK	74.0	-27.1	1.23 V	64	41.90	5.00
4	4874.00	35.1 AV	54.0	-18.9	1.23 V	64	30.10	5.00

REMARKS:

1. Emission Level(dBuV/m) = Raw Value(dBuV) + Correction Factor(dB/m)
2. Correction Factor(dB/m) = Antenna Factor(dB/m) + Cable Factor(dB)
– Pre-Amplifier Factor(dB)
3. The other emission levels were very low against the limit.
4. Margin value = Emission Level – Limit value
5. " * ": Fundamental frequency.

CHANNEL	TX Channel 11	DETECTOR FUNCTION	Peak (PK)
FREQUENCY RANGE	1GHz ~ 25GHz		Average (AV)

ANTENNA POLARITY & TEST DISTANCE: HORIZONTAL AT 3 M

NO.	FREQ. (MHz)	EMISSION LEVEL (dBuV/m)	LIMIT (dBuV/m)	MARGIN (dB)	ANTENNA HEIGHT (m)	TABLE ANGLE (Degree)	RAW VALUE (dBuV)	CORRECTION FACTOR (dB/m)
1	*2462.00	110.9 PK			2.50 H	188	78.90	32.00
2	*2462.00	100.0 AV			2.50 H	188	68.00	32.00
3	2483.50	56.6 PK	74.0	-17.4	2.50 H	188	24.60	32.00
4	2483.50	44.6 AV	54.0	-9.4	2.50 H	188	12.60	32.00
5	4924.00	45.9 PK	74.0	-28.1	1.06 H	156	40.80	5.10
6	4924.00	34.8 AV	54.0	-19.2	1.06 H	156	29.70	5.10

ANTENNA POLARITY & TEST DISTANCE: VERTICAL AT 3 M

NO.	FREQ. (MHz)	EMISSION LEVEL (dBuV/m)	LIMIT (dBuV/m)	MARGIN (dB)	ANTENNA HEIGHT (m)	TABLE ANGLE (Degree)	RAW VALUE (dBuV)	CORRECTION FACTOR (dB/m)
1	*2462.00	118.9 PK			2.87 V	188	86.90	32.00
2	*2462.00	108.7 AV			2.87 V	188	76.70	32.00
3	2483.50	66.6 PK	74.0	-7.4	2.87 V	188	34.60	32.00
4	2483.50	53.8 AV	54.0	-0.2	2.87 V	188	21.80	32.00
5	4924.00	46.1 PK	74.0	-27.9	1.26 V	87	41.00	5.10
6	4924.00	35.5 AV	54.0	-18.5	1.26 V	87	30.40	5.10

REMARKS:

1. Emission Level(dBuV/m) = Raw Value(dBuV) + Correction Factor(dB/m)
2. Correction Factor(dB/m) = Antenna Factor(dB/m) + Cable Factor(dB)
– Pre-Amplifier Factor(dB)
3. The other emission levels were very low against the limit.
4. Margin value = Emission Level – Limit value
5. " * ": Fundamental frequency.

802.11n (20MHz)

CHANNEL	TX Channel 1	DETECTOR FUNCTION	Peak (PK)
FREQUENCY RANGE	1GHz ~ 25GHz		Average (AV)

ANTENNA POLARITY & TEST DISTANCE: HORIZONTAL AT 3 M								
NO.	FREQ. (MHz)	EMISSION LEVEL (dBuV/m)	LIMIT (dBuV/m)	MARGIN (dB)	ANTENNA HEIGHT (m)	TABLE ANGLE (Degree)	RAW VALUE (dBuV)	CORRECTION FACTOR (dB/m)
1	2390.00	62.1 PK	74.0	-11.9	2.60 H	188	30.50	31.60
2	2390.00	49.1 AV	54.0	-4.9	2.60 H	188	17.50	31.60
3	*2412.00	109.3 PK			2.60 H	188	77.50	31.80
4	*2412.00	98.4 AV			2.60 H	188	66.60	31.80
5	4824.00	46.2 PK	74.0	-27.8	1.04 H	156	41.30	4.90
6	4824.00	34.2 AV	54.0	-19.8	1.04 H	156	29.30	4.90

ANTENNA POLARITY & TEST DISTANCE: VERTICAL AT 3 M								
NO.	FREQ. (MHz)	EMISSION LEVEL (dBuV/m)	LIMIT (dBuV/m)	MARGIN (dB)	ANTENNA HEIGHT (m)	TABLE ANGLE (Degree)	RAW VALUE (dBuV)	CORRECTION FACTOR (dB/m)
1	2390.00	67.3 PK	74.0	-6.7	2.01 V	103	35.70	31.60
2	2390.00	53.7 AV	54.0	-0.3	2.01 V	103	22.10	31.60
3	*2412.00	118.7 PK			2.01 V	103	86.90	31.80
4	*2412.00	107.1 AV			2.01 V	103	75.30	31.80
5	4824.00	47.5 PK	74.0	-26.5	1.32 V	68	42.60	4.90
6	4824.00	35.3 AV	54.0	-18.7	1.32 V	68	30.40	4.90

REMARKS:

1. Emission Level(dBuV/m) = Raw Value(dBuV) + Correction Factor(dB/m)
2. Correction Factor(dB/m) = Antenna Factor(dB/m) + Cable Factor(dB)
– Pre-Amplifier Factor(dB)
3. The other emission levels were very low against the limit.
4. Margin value = Emission Level – Limit value
5. " * ": Fundamental frequency.

CHANNEL	TX Channel 6	DETECTOR FUNCTION	Peak (PK)
FREQUENCY RANGE	1GHz ~ 25GHz		Average (AV)

ANTENNA POLARITY & TEST DISTANCE: HORIZONTAL AT 3 M

NO.	FREQ. (MHz)	EMISSION LEVEL (dBuV/m)	LIMIT (dBuV/m)	MARGIN (dB)	ANTENNA HEIGHT (m)	TABLE ANGLE (Degree)	RAW VALUE (dBuV)	CORRECTION FACTOR (dB/m)
1	*2437.00	111.0 PK			2.29 H	190	79.10	31.90
2	*2437.00	100.7 AV			2.29 H	190	68.80	31.90
3	4874.00	47.1 PK	74.0	-26.9	1.00 H	158	42.10	5.00
4	4874.00	34.7 AV	54.0	-19.3	1.00 H	158	29.70	5.00

ANTENNA POLARITY & TEST DISTANCE: VERTICAL AT 3 M

NO.	FREQ. (MHz)	EMISSION LEVEL (dBuV/m)	LIMIT (dBuV/m)	MARGIN (dB)	ANTENNA HEIGHT (m)	TABLE ANGLE (Degree)	RAW VALUE (dBuV)	CORRECTION FACTOR (dB/m)
1	*2437.00	119.8 PK			1.02 V	116	87.90	31.90
2	*2437.00	108.7 AV			1.02 V	116	76.80	31.90
3	4874.00	47.6 PK	74.0	-26.4	1.25 V	87	42.60	5.00
4	4874.00	35.1 AV	54.0	-18.9	1.25 V	87	30.10	5.00

REMARKS:

1. Emission Level(dBuV/m) = Raw Value(dBuV) + Correction Factor(dB/m)
2. Correction Factor(dB/m) = Antenna Factor(dB/m) + Cable Factor(dB)
– Pre-Amplifier Factor(dB)
3. The other emission levels were very low against the limit.
4. Margin value = Emission Level – Limit value
5. " * ": Fundamental frequency.

CHANNEL	TX Channel 11	DETECTOR FUNCTION	Peak (PK)
FREQUENCY RANGE	1GHz ~ 25GHz		Average (AV)

ANTENNA POLARITY & TEST DISTANCE: HORIZONTAL AT 3 M

NO.	FREQ. (MHz)	EMISSION LEVEL (dBuV/m)	LIMIT (dBuV/m)	MARGIN (dB)	ANTENNA HEIGHT (m)	TABLE ANGLE (Degree)	RAW VALUE (dBuV)	CORRECTION FACTOR (dB/m)
1	*2462.00	110.3 PK			2.53 H	186	78.30	32.00
2	*2462.00	100.4 AV			2.53 H	186	68.40	32.00
3	2483.50	56.8 PK	74.0	-17.2	2.53 H	186	24.80	32.00
4	2483.50	44.9 AV	54.0	-9.1	2.53 H	186	12.90	32.00
5	4924.00	46.6 PK	74.0	-27.4	1.08 H	150	41.50	5.10
6	4924.00	34.4 AV	54.0	-19.6	1.08 H	150	29.30	5.10

ANTENNA POLARITY & TEST DISTANCE: VERTICAL AT 3 M

NO.	FREQ. (MHz)	EMISSION LEVEL (dBuV/m)	LIMIT (dBuV/m)	MARGIN (dB)	ANTENNA HEIGHT (m)	TABLE ANGLE (Degree)	RAW VALUE (dBuV)	CORRECTION FACTOR (dB/m)
1	*2462.00	119.1 PK			1.31 V	185	87.10	32.00
2	*2462.00	109.0 AV			1.31 V	185	77.00	32.00
3	2483.50	70.0 PK	74.0	-4.0	1.31 V	185	38.00	32.00
4	2483.50	53.9 AV	54.0	-0.1	1.31 V	185	21.90	32.00
5	4924.00	47.7 PK	74.0	-26.3	1.36 V	97	42.60	5.10
6	4924.00	35.2 AV	54.0	-18.8	1.36 V	97	30.10	5.10

REMARKS:

1. Emission Level(dBuV/m) = Raw Value(dBuV) + Correction Factor(dB/m)
2. Correction Factor(dB/m) = Antenna Factor(dB/m) + Cable Factor(dB)
- Pre-Amplifier Factor(dB)
3. The other emission levels were very low against the limit.
4. Margin value = Emission Level – Limit value
5. " * ": Fundamental frequency.

802.11n (40MHz)

CHANNEL	TX Channel 3	DETECTOR FUNCTION	Peak (PK)
FREQUENCY RANGE	1GHz ~ 25GHz		Average (AV)

ANTENNA POLARITY & TEST DISTANCE: HORIZONTAL AT 3 M								
NO.	FREQ. (MHz)	EMISSION LEVEL (dBuV/m)	LIMIT (dBuV/m)	MARGIN (dB)	ANTENNA HEIGHT (m)	TABLE ANGLE (Degree)	RAW VALUE (dBuV)	CORRECTION FACTOR (dB/m)
1	2390.00	56.2 PK	74.0	-17.8	2.31 H	185	24.60	31.60
2	2390.00	45.2 AV	54.0	-8.8	2.31 H	185	13.60	31.60
3	*2422.00	100.6 PK			2.31 H	185	68.80	31.80
4	*2422.00	90.4 AV			2.31 H	185	58.60	31.80
5	4844.00	44.4 PK	74.0	-29.6	1.00 H	156	39.50	4.90
6	4844.00	33.4 AV	54.0	-20.6	1.00 H	156	28.50	4.90

ANTENNA POLARITY & TEST DISTANCE: VERTICAL AT 3 M								
NO.	FREQ. (MHz)	EMISSION LEVEL (dBuV/m)	LIMIT (dBuV/m)	MARGIN (dB)	ANTENNA HEIGHT (m)	TABLE ANGLE (Degree)	RAW VALUE (dBuV)	CORRECTION FACTOR (dB/m)
1	2390.00	66.6 PK	74.0	-7.4	1.31 V	172	35.00	31.60
2	2390.00	53.5 AV	54.0	-0.5	1.31 V	172	21.90	31.60
3	*2422.00	112.1 PK			1.31 V	172	80.30	31.80
4	*2422.00	102.7 AV			1.31 V	172	70.90	31.80
5	4844.00	45.6 PK	74.0	-28.4	1.27 V	41	40.70	4.90
6	4844.00	34.8 AV	54.0	-19.2	1.27 V	41	29.90	4.90

REMARKS:

1. Emission Level(dBuV/m) = Raw Value(dBuV) + Correction Factor(dB/m)
2. Correction Factor(dB/m) = Antenna Factor(dB/m) + Cable Factor(dB)
– Pre-Amplifier Factor(dB)
3. The other emission levels were very low against the limit.
4. Margin value = Emission Level – Limit value
5. " * ": Fundamental frequency.

CHANNEL	TX Channel 6	DETECTOR FUNCTION	Peak (PK)
FREQUENCY RANGE	1GHz ~ 25GHz		Average (AV)

ANTENNA POLARITY & TEST DISTANCE: HORIZONTAL AT 3 M

NO.	FREQ. (MHz)	EMISSION LEVEL (dBuV/m)	LIMIT (dBuV/m)	MARGIN (dB)	ANTENNA HEIGHT (m)	TABLE ANGLE (Degree)	RAW VALUE (dBuV)	CORRECTION FACTOR (dB/m)
1	2390.00	55.1 PK	74.0	-18.9	2.28 H	186	23.50	31.60
2	2390.00	44.6 AV	54.0	-9.4	2.28 H	186	13.00	31.60
3	*2437.00	106.4 PK			2.28 H	186	74.50	31.90
4	*2437.00	96.2 AV			2.28 H	186	64.30	31.90
5	4874.00	45.0 PK	74.0	-29.0	1.01 H	152	40.00	5.00
6	4874.00	34.5 AV	54.0	-19.5	1.01 H	152	29.50	5.00

ANTENNA POLARITY & TEST DISTANCE: VERTICAL AT 3 M

NO.	FREQ. (MHz)	EMISSION LEVEL (dBuV/m)	LIMIT (dBuV/m)	MARGIN (dB)	ANTENNA HEIGHT (m)	TABLE ANGLE (Degree)	RAW VALUE (dBuV)	CORRECTION FACTOR (dB/m)
1	2390.00	68.2 PK	74.0	-5.8	1.26 V	255	36.60	31.60
2	2390.00	53.6 AV	54.0	-0.4	1.26 V	255	22.00	31.60
3	*2437.00	114.1 PK			1.26 V	255	82.20	31.90
4	*2437.00	104.4 AV			1.26 V	255	72.50	31.90
5	4874.00	45.2 PK	74.0	-28.8	1.55 V	201	40.20	5.00
6	4874.00	34.8 AV	54.0	-19.2	1.55 V	201	29.80	5.00

REMARKS:

1. Emission Level(dBuV/m) = Raw Value(dBuV) + Correction Factor(dB/m)
2. Correction Factor(dB/m) = Antenna Factor(dB/m) + Cable Factor(dB)
– Pre-Amplifier Factor(dB)
3. The other emission levels were very low against the limit.
4. Margin value = Emission Level – Limit value
5. " * ": Fundamental frequency.

CHANNEL	TX Channel 9	DETECTOR FUNCTION	Peak (PK)
FREQUENCY RANGE	1GHz ~ 25GHz		Average (AV)

ANTENNA POLARITY & TEST DISTANCE: HORIZONTAL AT 3 M

NO.	FREQ. (MHz)	EMISSION LEVEL (dBuV/m)	LIMIT (dBuV/m)	MARGIN (dB)	ANTENNA HEIGHT (m)	TABLE ANGLE (Degree)	RAW VALUE (dBuV)	CORRECTION FACTOR (dB/m)
1	*2452.00	105.1 PK			2.52 H	187	73.20	31.90
2	*2452.00	95.2 AV			2.52 H	187	63.30	31.90
3	2483.50	58.3 PK	74.0	-15.7	2.52 H	187	26.30	32.00
4	2483.50	44.1 AV	54.0	-9.9	2.52 H	187	12.10	32.00
5	4904.00	44.6 PK	74.0	-29.4	1.00 H	157	39.60	5.00
6	4904.00	34.0 AV	54.0	-20.0	1.00 H	157	29.00	5.00

ANTENNA POLARITY & TEST DISTANCE: VERTICAL AT 3 M

NO.	FREQ. (MHz)	EMISSION LEVEL (dBuV/m)	LIMIT (dBuV/m)	MARGIN (dB)	ANTENNA HEIGHT (m)	TABLE ANGLE (Degree)	RAW VALUE (dBuV)	CORRECTION FACTOR (dB/m)
1	*2452.00	113.0 PK			1.32 V	180	81.10	31.90
2	*2452.00	102.9 AV			1.32 V	180	71.00	31.90
3	2483.50	66.3 PK	74.0	-7.7	1.32 V	180	34.30	32.00
4	2483.50	53.9 AV	54.0	-0.1	1.32 V	180	21.90	32.00
5	4904.00	45.3 PK	74.0	-28.7	1.36 V	87	40.30	5.00
6	4904.00	34.7 AV	54.0	-19.3	1.36 V	87	29.70	5.00

REMARKS:

1. Emission Level(dBuV/m) = Raw Value(dBuV) + Correction Factor(dB/m)
2. Correction Factor(dB/m) = Antenna Factor(dB/m) + Cable Factor(dB)
- Pre-Amplifier Factor(dB)
3. The other emission levels were very low against the limit.
4. Margin value = Emission Level – Limit value
5. " * ": Fundamental frequency.

Below 1GHz Worst-case Data: 802.11b

CHANNEL	TX Channel 1	DETECTOR FUNCTION	Quasi-Peak (QP)
FREQUENCY RANGE	30MHz ~ 1GHz		

ANTENNA POLARITY & TEST DISTANCE: HORIZONTAL AT 3 M								
NO.	FREQ. (MHz)	EMISSION LEVEL (dBuV/m)	LIMIT (dBuV/m)	MARGIN (dB)	ANTENNA HEIGHT (m)	TABLE ANGLE (Degree)	RAW VALUE (dBuV)	CORRECTION FACTOR (dB/m)
1	39.62	34.4 QP	40.0	-5.6	1.49 H	36	48.80	-14.40
2	62.95	36.9 QP	40.0	-3.1	1.49 H	283	51.80	-14.90
3	156.28	34.0 QP	43.5	-9.5	1.49 H	221	47.70	-13.70
4	375.98	38.2 QP	46.0	-7.8	1.24 H	12	49.60	-11.40
5	424.59	39.6 QP	46.0	-6.4	1.99 H	27	50.20	-10.60
6	875.67	32.4 QP	46.0	-13.6	1.49 H	66	34.50	-2.10

ANTENNA POLARITY & TEST DISTANCE: VERTICAL AT 3 M								
NO.	FREQ. (MHz)	EMISSION LEVEL (dBuV/m)	LIMIT (dBuV/m)	MARGIN (dB)	ANTENNA HEIGHT (m)	TABLE ANGLE (Degree)	RAW VALUE (dBuV)	CORRECTION FACTOR (dB/m)
1	51.29	36.3 QP	40.0	-3.7	1.00 V	294	50.20	-13.90
2	61.01	38.8 QP	40.0	-1.2	1.00 V	137	53.40	-14.60
3	160.17	32.6 QP	43.5	-10.9	1.24 V	6	46.30	-13.70
4	375.98	38.9 QP	46.0	-7.1	1.50 V	134	50.30	-11.40
5	624.85	35.4 QP	46.0	-10.6	1.00 V	159	41.90	-6.50
6	875.67	34.2 QP	46.0	-11.8	1.24 V	12	36.30	-2.10

REMARKS:

1. Emission Level(dBuV/m) = Raw Value(dBuV) + Correction Factor(dB/m)
2. Correction Factor(dB/m) = Antenna Factor(dB/m) + Cable Factor(dB)
– Pre-Amplifier Factor (dB)
3. The other emission levels were very low against the limit.
4. Margin value = Emission Level – Limit value

4.2 Conducted Emission Measurement

4.2.1 Limits of Conducted Emission Measurement

Frequency (MHz)	Conducted Limit (dBuV)	
	Quasi-peak	Average
0.15 - 0.5	66 - 56	56 - 46
0.50 - 5.0	56	46
5.0 - 30.0	60	50

- Note:** 1. The lower limit shall apply at the transition frequencies.
 2. The limit decreases in line with the logarithm of the frequency in the range of 0.15 to 0.50MHz.

4.2.2 Test Instruments

Description & Manufacturer	Model No.	Serial No.	Date Of Calibration	Due Date Of Calibration
Test Receiver ROHDE & SCHWARZ	ESCI	100613	Nov. 11, 2014	Nov. 10, 2015
RF signal cable (with 10dB PAD) Woken	5D-FB	Cable-cond1-01	Dec. 26, 2014	Dec. 25, 2015
LISN ROHDE & SCHWARZ (EUT)	ESH3-Z5	835239/001	Feb. 26, 2015	Feb. 25, 2016
LISN ROHDE & SCHWARZ (Peripheral)	ESH3-Z5	100311	Jul. 24, 2015	Jul. 23, 2016
Software ADT	BV ADT_Cond_ V7.3.7.3	NA	NA	NA

- Note:** 1. The calibration interval of the above test instruments is 12 months and the calibrations are traceable to NML/ROC and NIST/USA.
 2. The test was performed in HwaYa Shielded Room 1.
 3. The VCCI Site Registration No. is C-2040.

4.2.3 Test Procedures

- The EUT was placed 0.4 meters from the conducting wall of the shielded room with EUT being connected to the power mains through a line impedance stabilization network (LISN). Other support units were connected to the power mains through another LISN. The two LISNs provide 50 ohm/ 50uH of coupling impedance for the measuring instrument.
- Both lines of the power mains connected to the EUT were checked for maximum conducted interference.
- The frequency range from 150kHz to 30MHz was searched. Emission levels under (Limit - 20dB) was not recorded.

Note: The resolution bandwidth and video bandwidth of test receiver is 9kHz for quasi-peak detection (QP) and average detection (AV) at frequency 0.15MHz-30MHz.

4.2.4 Deviation from Test Standard

No deviation.

4.2.5 Test Setup

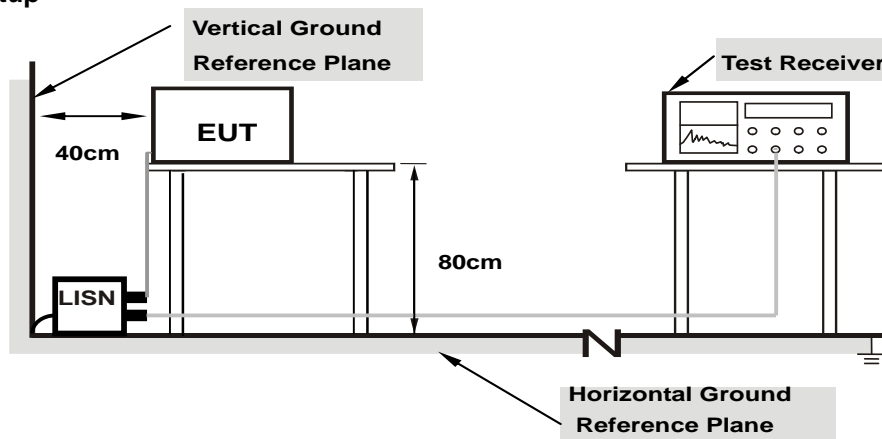

Note: 1.Support units were connected to second LISN.

For the actual test configuration, please refer to the attached file (Test Setup Photo).

4.2.6 EUT Operating Conditions

Same as 4.1.6.

4.2.7 Test Results

Phase	Line (L)	Detector Function	Quasi-Peak (QP) / Average (AV)
-------	----------	-------------------	--------------------------------

No	Freq. [MHz]	Corr. Factor (dB)	Reading Value [dB (uV)]		Emission Level [dB (uV)]		Limit [dB (uV)]		Margin (dB)	
			Q.P.	AV.	Q.P.	AV.	Q.P.	AV.	Q.P.	AV.
			1	0.15391	9.85	32.11	21.25	41.96	31.10	65.79
2	0.16564	9.87	28.68	13.84	38.55	23.71	65.18	55.18	-26.63	-31.47
3	0.18519	9.90	27.16	14.92	37.06	24.82	64.25	54.25	-27.19	-29.43
4	0.52536	9.93	29.99	20.82	39.92	30.75	56.00	46.00	-16.08	-15.25
5	3.47112	10.17	22.04	14.01	32.21	24.18	56.00	46.00	-23.79	-21.82
6	11.53354	10.64	29.65	22.56	40.29	33.20	60.00	50.00	-19.71	-16.80

Remarks:

1. Q.P. and AV. are abbreviations of quasi-peak and average individually.
2. The emission levels of other frequencies were very low against the limit.
3. Margin value = Emission level - Limit value
4. Correction factor = Insertion loss + Cable loss
5. Emission Level = Correction Factor + Reading Value.

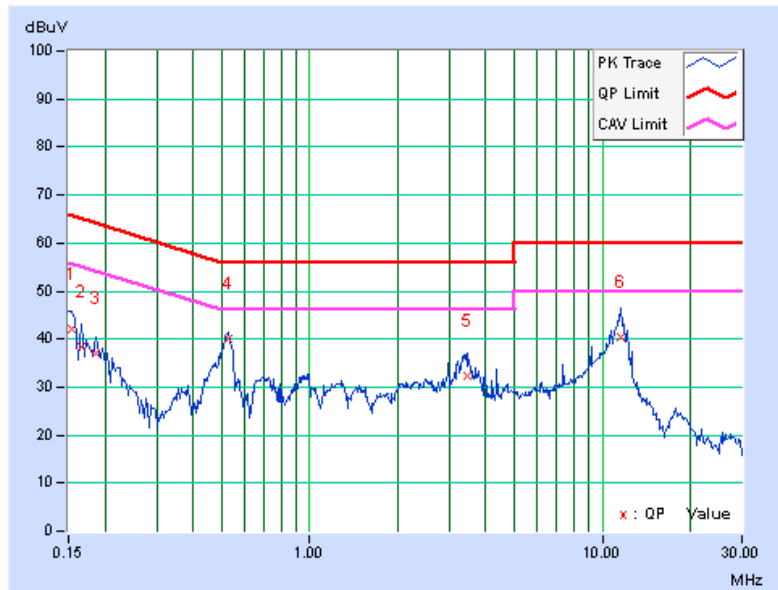

Phase	Neutral (N)	Detector Function	Quasi-Peak (QP) / Average (AV)
-------	-------------	-------------------	--------------------------------

No	Freq. [MHz]	Corr. Factor (dB)	Reading Value [dB (uV)]		Emission Level [dB (uV)]		Limit [dB (uV)]		Margin (dB)	
			Q.P.	AV.	Q.P.	AV.	Q.P.	AV.	Q.P.	AV.
			1	0.15782	9.91	30.99	19.36	40.90	29.27	65.58
2	0.51363	10.00	28.53	21.54	38.53	31.54	56.00	46.00	-17.47	-14.46
3	2.78296	10.18	16.97	9.38	27.15	19.56	56.00	46.00	-28.85	-26.44
4	3.43984	10.26	23.51	14.63	33.77	24.89	56.00	46.00	-22.23	-21.11
5	7.67437	10.49	17.03	11.96	27.52	22.45	60.00	50.00	-32.48	-27.55
6	11.63129	10.67	29.21	22.17	39.88	32.84	60.00	50.00	-20.12	-17.16

Remarks:

1. Q.P. and AV. are abbreviations of quasi-peak and average individually.
2. The emission levels of other frequencies were very low against the limit.
3. Margin value = Emission level - Limit value
4. Correction factor = Insertion loss + Cable loss
5. Emission Level = Correction Factor + Reading Value.

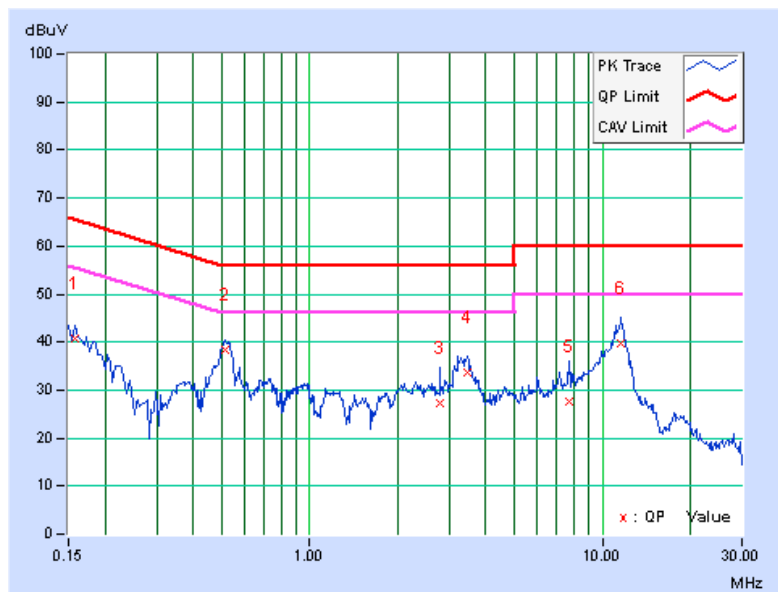

4.3 6dB Bandwidth Measurement

4.3.1 Limits of 6dB Bandwidth Measurement

The minimum of 6dB Bandwidth Measurement is 0.5 MHz.

4.3.2 Test Setup

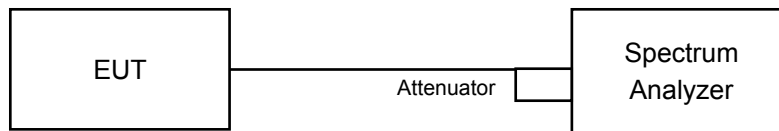

4.3.3 Test Instruments

Refer to section 4.1.2 to get information of above instrument.

4.3.4 Test Procedure

- Set resolution bandwidth (RBW) = 100kHz
- Set the video bandwidth (VBW) $\geq 3 \times$ RBW, Detector = Peak.
- Trace mode = max hold.
- Sweep = auto couple.
- Measure the maximum width of the emission that is constrained by the frequencies associated with the two amplitude points (upper and lower) that are attenuated by 6 dB relative to the maximum level measured in the fundamental emission

4.3.5 Deviation from Test Standard

No deviation.

4.3.6 EUT Operating Conditions

The software provided by client to enable the EUT under transmission condition continuously at lowest, middle and highest channel frequencies individually.

4.3.7 Test Result

CDD Mode

802.11b

Channel	Frequency (MHz)	6dB Bandwidth (MHz)				Minimum Limit (MHz)	Pass / Fail
		Chain 0	Chain 1	Chain 2	Chain 3		
1	2412	8.11	8.08	8.09	8.57	0.5	Pass
6	2437	8.10	7.59	8.59	8.57	0.5	Pass
11	2462	8.08	7.58	8.03	8.52	0.5	Pass

802.11g

Channel	Frequency (MHz)	6dB Bandwidth (MHz)				Minimum Limit (MHz)	Pass / Fail
		Chain 0	Chain 1	Chain 2	Chain 3		
1	2412	16.36	16.33	15.78	16.31	0.5	Pass
6	2437	16.35	15.36	15.75	15.74	0.5	Pass
11	2462	16.37	15.68	16.28	15.74	0.5	Pass

802.11n (20MHz)

Channel	Frequency (MHz)	6dB Bandwidth (MHz)				Minimum Limit (MHz)	Pass / Fail
		Chain 0	Chain 1	Chain 2	Chain 3		
1	2412	17.33	16.34	16.57	15.80	0.5	Pass
6	2437	17.18	16.29	16.32	15.73	0.5	Pass
11	2462	16.95	16.30	16.30	16.32	0.5	Pass

802.11n (40MHz)

Channel	Frequency (MHz)	6dB Bandwidth (MHz)				Minimum Limit (MHz)	Pass / Fail
		Chain 0	Chain 1	Chain 2	Chain 3		
3	2422	35.32	35.42	35.85	35.39	0.5	Pass
6	2437	35.24	35.39	35.82	35.23	0.5	Pass
9	2452	35.18	35.20	35.76	35.39	0.5	Pass

Spectrum Plot of Worst Value

802.11b

802.11g

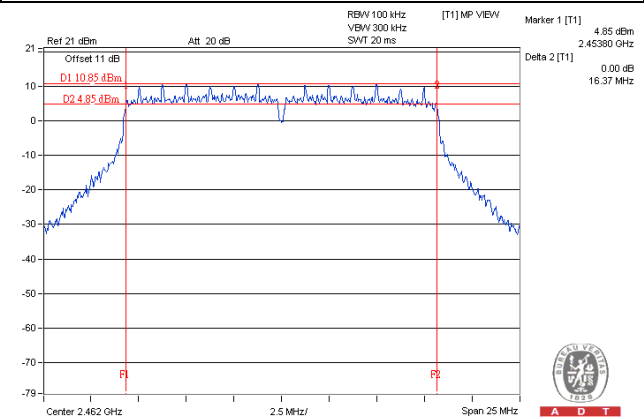
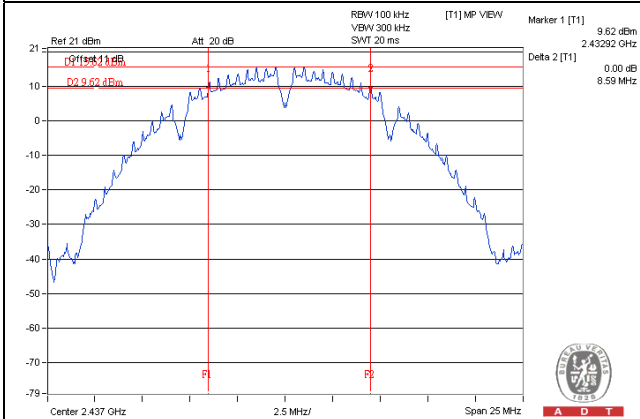

802.11n (20MHz)

802.11n (40MHz)

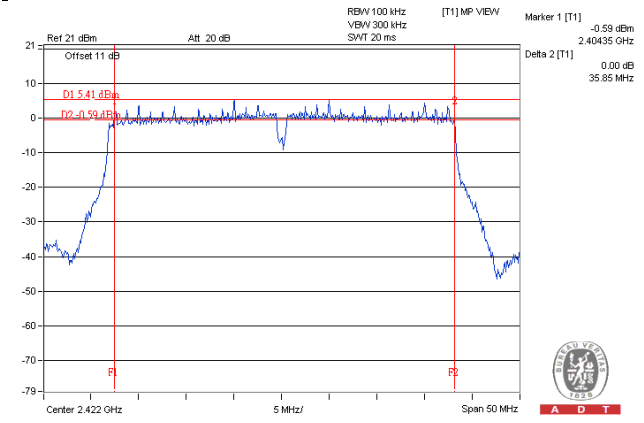
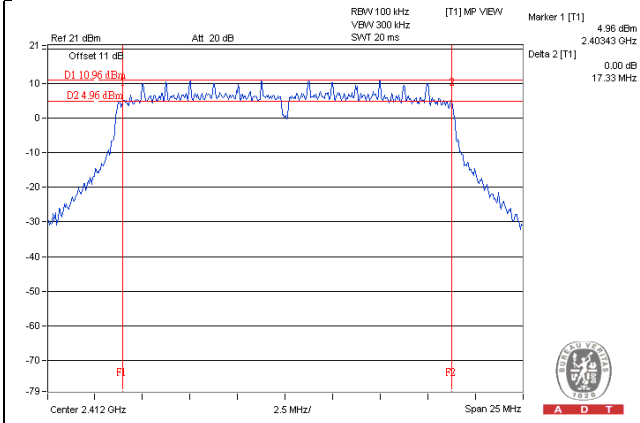

Beamforming_NSS1 Mode

802.11n (20MHz)

Channel	Frequency (MHz)	6dB Bandwidth (MHz)				Minimum Limit (MHz)	Pass / Fail
		Chain 0	Chain 1	Chain 2	Chain 3		
1	2412	17.53	16.33	16.55	16.35	0.5	Pass
6	2437	17.17	16.31	15.72	16.33	0.5	Pass
11	2462	16.94	15.75	15.68	15.93	0.5	Pass

802.11n (40MHz)

Channel	Frequency (MHz)	6dB Bandwidth (MHz)				Minimum Limit (MHz)	Pass / Fail
		Chain 0	Chain 1	Chain 2	Chain 3		
3	2422	35.29	35.55	35.20	35.81	0.5	Pass
6	2437	35.24	35.41	35.22	35.27	0.5	Pass
9	2452	35.46	35.80	35.14	35.38	0.5	Pass

Spectrum Plot of Worst Value

802.11n (20MHz)

802.11n (40MHz)

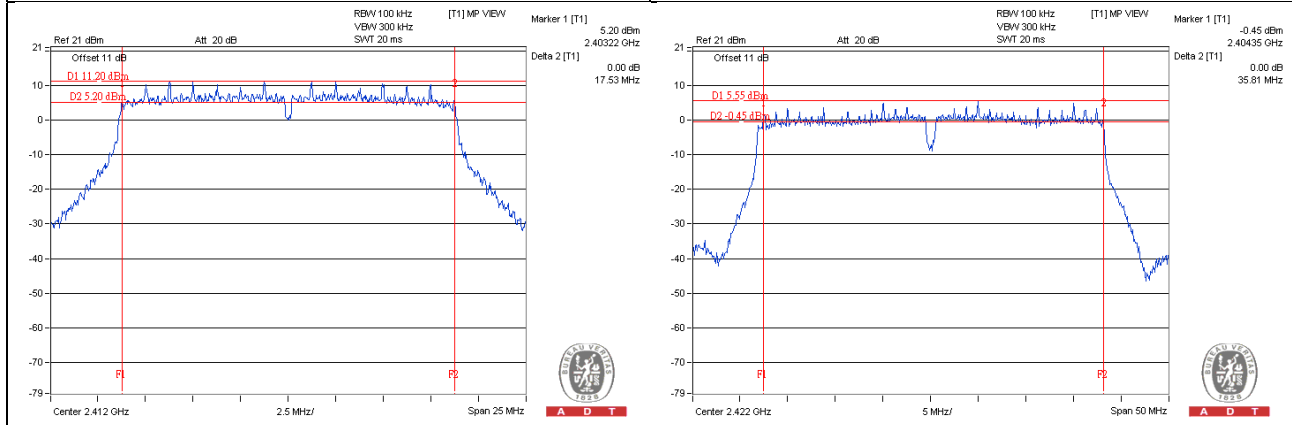

Beamforming_NSS2 Mode

802.11n (20MHz)

Channel	Frequency (MHz)	6dB Bandwidth (MHz)				Minimum Limit (MHz)	Pass / Fail
		Chain 0	Chain 1	Chain 2	Chain 3		
1	2412	16.94	16.31	15.77	16.33	0.5	Pass
6	2437	17.20	16.31	16.33	15.74	0.5	Pass
11	2462	16.96	16.31	15.74	15.74	0.5	Pass

802.11n (40MHz)

Channel	Frequency (MHz)	6dB Bandwidth (MHz)				Minimum Limit (MHz)	Pass / Fail
		Chain 0	Chain 1	Chain 2	Chain 3		
3	2422	35.29	35.84	35.17	35.84	0.5	Pass
6	2437	35.24	35.28	35.24	35.26	0.5	Pass
9	2452	35.20	35.34	35.23	35.75	0.5	Pass

Spectrum Plot of Worst Value

802.11n (20MHz)

802.11n (40MHz)

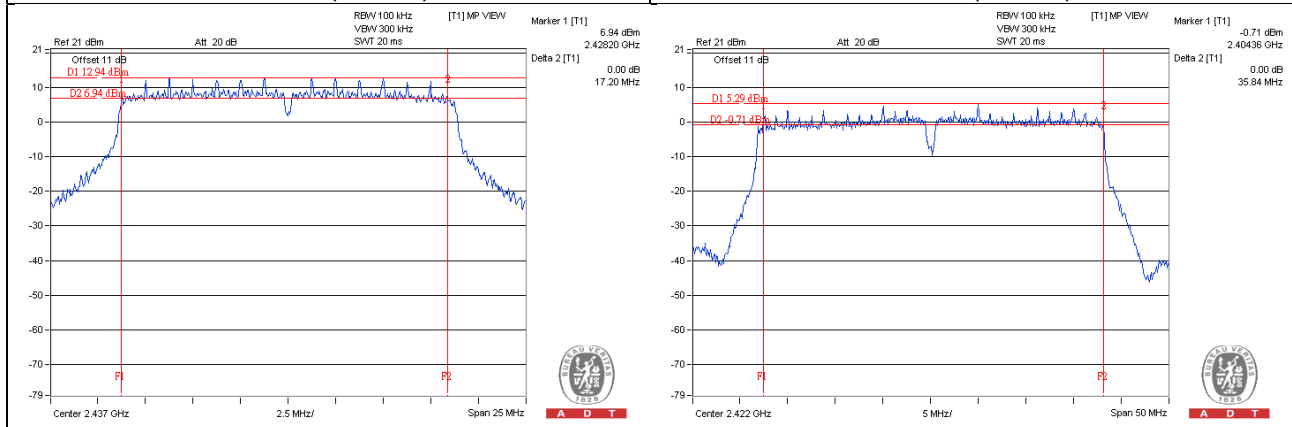

4.4 Conducted Output Power Measurement

4.4.1 Limits of Conducted Output Power Measurement

For systems using digital modulation in the 2400–2483.5 MHz bands: 1 Watt (30dBm)

Per KDB 662911 D01 Multiple Transmitter Output Method of conducted output power measurement on IEEE 802.11 devices,

Array Gain = 0 dB (i.e., no array gain) for $N_{ANT} \leq 4$;

Array Gain = 0 dB (i.e., no array gain) for channel widths ≥ 40 MHz for any N_{ANT} ;

Array Gain = $5 \log(N_{ANT}/N_{SS})$ dB or 3 dB, whichever is less for 20-MHz channel widths with $N_{ANT} \geq 5$.

For power measurements on all other devices: Array Gain = $10 \log(N_{ANT}/N_{SS})$ dB.

4.4.2 Test Setup

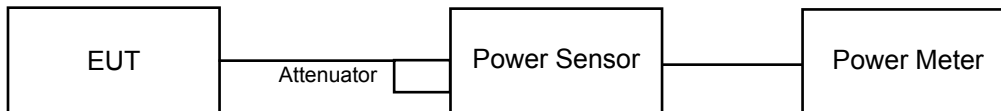

4.4.3 Test Instruments

Refer to section 4.1.2 to get information of above instrument.

4.4.4 Test Procedures

An average power sensor was used on the output port of the EUT. A power meter was used to read the response of the average power sensor. Record the average power level.

4.4.5 Deviation from Test Standard

No deviation.

4.4.6 EUT Operating Conditions

Same as Item 4.3.6.

4.4.7 Test Results

CDD Mode

802.11b

Chan.	Chan. Freq. (MHz)	AVG. Power (dBm)				Total Power (mW)	Total Power (dBm)	Limit (dBm)	Pass / Fail
		Chain 0	Chain 1	Chain 2	Chain 3				
1	2412	23.98	23.78	23.84	23.87	974.700	29.89	30	Pass
6	2437	23.77	23.78	23.89	23.85	964.580	29.84	30	Pass
11	2462	23.87	23.77	23.89	23.74	963.511	29.84	30	Pass

802.11g

Chan.	Chan. Freq. (MHz)	AVG. Power (dBm)				Total Power (mW)	Total Power (dBm)	Limit (dBm)	Pass / Fail
		Chain 0	Chain 1	Chain 2	Chain 3				
1	2412	21.45	21.12	21.41	21.32	542.933	27.35	30	Pass
6	2437	23.89	23.74	23.98	23.68	964.879	29.84	30	Pass
11	2462	20.94	21.23	21.09	21.19	516.955	27.13	30	Pass

802.11n (20MHz)

Chan.	Chan. Freq. (MHz)	AVG. Power (dBm)				Total Power (mW)	Total Power (dBm)	Limit (dBm)	Pass / Fail
		Chain 0	Chain 1	Chain 2	Chain 3				
1	2412	21.33	21.46	21.25	21.27	543.110	27.35	30	Pass
6	2437	23.75	23.91	23.76	23.85	963.519	29.84	30	Pass
11	2462	21.31	21.18	21.37	21.44	542.831	27.35	30	Pass

802.11n (40MHz)

Chan.	Chan. Freq. (MHz)	AVG. Power (dBm)				Total Power (mW)	Total Power (dBm)	Limit (dBm)	Pass / Fail
		Chain 0	Chain 1	Chain 2	Chain 3				
3	2422	17.81	17.64	17.69	17.92	239.164	23.79	30	Pass
6	2437	20.68	20.91	20.46	20.91	474.743	26.76	30	Pass
9	2452	19.37	19.46	19.25	19.84	355.328	25.51	30	Pass

Beamforming_NSS1 Mode

802.11n (20MHz)

Chan.	Chan. Freq. (MHz)	AVG. Power (dBm)				Total Power (mW)	Total Power (dBm)	Limit (dBm)	Pass / Fail
		Chain 0	Chain 1	Chain 2	Chain 3				
1	2412	21.13	21.47	21.23	21.26	536.398	27.29	29.77	Pass
6	2437	23.41	23.67	23.52	23.55	903.458	29.56	29.57	Pass
11	2462	22.34	22.27	22.44	22.55	695.326	28.42	29.87	Pass

Note:

2412MHz: Directional gain = $0.21\text{dBi} + 10\log(4) = 6.23\text{dBi} > 6\text{dBi}$, so the power limit shall be reduced to $30-(6.23-6) = 29.77\text{dBm}$.

2437MHz: Directional gain = $0.41\text{dBi} + 10\log(4) = 6.43\text{dBi} > 6\text{dBi}$, so the power limit shall be reduced to $30-(6.43-6) = 29.57\text{dBm}$.

2462MHz: Directional gain = $0.11\text{dBi} + 10\log(4) = 6.13\text{dBi} > 6\text{dBi}$, so the power limit shall be reduced to $30-(6.13-6) = 29.87\text{dBm}$.

802.11n (40MHz)

Chan.	Chan. Freq. (MHz)	AVG. Power (dBm)				Total Power (mW)	Total Power (dBm)	Limit (dBm)	Pass / Fail
		Chain 0	Chain 1	Chain 2	Chain 3				
3	2422	17.88	17.68	17.85	17.89	242.462	23.85	29.57	Pass
6	2437	20.67	20.82	20.49	20.81	469.910	26.72	29.57	Pass
9	2452	18.21	18.36	18.06	18.70	272.875	24.36	29.77	Pass

Note:

2422MHz: Directional gain = $0.41\text{dBi} + 10\log(4) = 6.43\text{dBi} > 6\text{dBi}$, so the power density limit shall be reduced to $30-(6.43-6) = 29.57\text{dBm}$.

2437MHz: Directional gain = $0.41\text{dBi} + 10\log(4) = 6.43\text{dBi} > 6\text{dBi}$, so the power density limit shall be reduced to $30-(6.43-6) = 29.57\text{dBm}$.

2452MHz: Directional gain = $0.21\text{dBi} + 10\log(4) = 6.23\text{dBi} > 6\text{dBi}$, so the power density limit shall be reduced to $30-(6.23-6) = 29.77\text{dBm}$.

Beamforming_NSS2 Mode

802.11n (20MHz)

Chan.	Chan. Freq. (MHz)	AVG. Power (dBm)				Total Power (mW)	Total Power (dBm)	Limit (dBm)	Pass / Fail
		Chain 0	Chain 1	Chain 2	Chain 3				
1	2412	21.15	21.49	21.34	21.35	543.848	27.35	30	Pass
6	2437	23.44	23.68	23.56	23.61	910.747	29.59	30	Pass
11	2462	22.35	22.32	22.51	22.49	698.056	28.44	30	Pass

2412MHz: Directional gain = $0.21\text{dBi} + 10\log(4/2) = 3.22\text{dBi} < 6\text{dBi}$, so the power density limit no need to reduced.

2437MHz: Directional gain = $0.41\text{dBi} + 10\log(4/2) = 3.42\text{dBi} < 6\text{dBi}$, so the power density limit no need to reduced.

2462MHz: Directional gain = $0.11\text{dBi} + 10\log(4/2) = 3.12\text{dBi} < 6\text{dBi}$, so the power density limit no need to reduced.

802.11n (40MHz)

Chan.	Chan. Freq. (MHz)	AVG. Power (dBm)				Total Power (mW)	Total Power (dBm)	Limit (dBm)	Pass / Fail
		Chain 0	Chain 1	Chain 2	Chain 3				
3	2422	17.72	17.53	17.68	17.61	232.071	23.66	30	Pass
6	2437	20.66	20.81	20.53	20.92	473.492	26.75	30	Pass
9	2452	18.23	18.34	18.11	18.64	272.589	24.36	30	Pass

2412MHz: Directional gain = $0.41\text{dBi} + 10\log(4/2) = 3.42\text{dBi} < 6\text{dBi}$, so the power density limit no need to reduced.

2437MHz: Directional gain = $0.41\text{dBi} + 10\log(4/2) = 3.42\text{dBi} < 6\text{dBi}$, so the power density limit no need to reduced.

2462MHz: Directional gain = $0.21\text{dBi} + 10\log(4/2) = 3.22\text{dBi} < 6\text{dBi}$, so the power density limit no need to reduced.

4.5 Power Spectral Density Measurement

4.5.1 Limits of Power Spectral Density Measurement

The Maximum of Power Spectral Density Measurement is 8dBm.

4.5.2 Test Setup

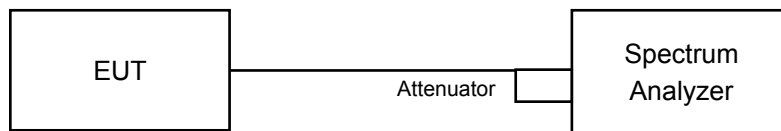

4.5.3 Test Instruments

Refer to section 4.1.2 to get information of above instrument.

4.5.4 Test Procedure

For AVG. power (duty cycle $\geq 98\%$)

- Set instrument center frequency to DTS channel center frequency.
- Set span to at least 1.5 times the OBW.
- Set RBW to: $3 \text{ kHz} \leq \text{RBW} \leq 100 \text{ kHz}$.
- Set VBW $\geq 3 \times \text{RBW}$.
- Detector = power averaging (RMS) or sample detector (when RMS not available).
- Ensure that the number of measurement points in the sweep $\geq 2 \times \text{span}/\text{RBW}$.
- Sweep time = auto couple.
- Employ trace averaging (RMS) mode over a minimum of 100 traces.
- Use the peak marker function to determine the maximum amplitude level.

For AVG. power (duty cycle $< 98\%$)

- Measure the duty cycle (x).
- Set instrument center frequency to DTS channel center frequency.
- Set span to at least 1.5 times the OBW.
- Set RBW to: $3 \text{ kHz} \leq \text{RBW} \leq 100 \text{ kHz}$.
- Set VBW $\geq 3 \times \text{RBW}$.
- Detector = power averaging (RMS) or sample detector (when RMS not available).
- Ensure that the number of measurement points in the sweep $\geq 2 \times \text{span}/\text{RBW}$.
- Sweep time = auto couple.
- Do not use sweep triggering. Allow sweep to “free run”.
- Employ trace averaging (RMS) mode over a minimum of 100 traces.
- Use the peak marker function to determine the maximum amplitude level.
- Add $10 \log (1/x)$, where x is the duty cycle measured in step (a), to the measured PSD to compute the average PSD during the actual transmission time.

4.5.5 Deviation from Test Standard

No deviation.

4.5.6 EUT Operating Condition

Same as Item 4.3.6

4.5.7 Test Results

CDD Mode

802.11b

TX chain	Channel	Freq. (MHz)	PSD (dBm)	10 log (N=4) dB	Total PSD w/o duty factor (dBm)	Duty factor	Total PSD (dBm)	Limit (dBm)	PASS /FAIL
0	1	2412	-2.68	6.02	3.34	0.29	3.63	7.77	Pass
	6	2437	-3.08	6.02	2.94	0.29	3.23	7.57	Pass
	11	2462	-4.30	6.02	1.72	0.29	2.01	7.87	Pass
1	1	2412	-3.79	6.02	2.23	0.29	2.52	7.77	Pass
	6	2437	-3.71	6.02	2.31	0.29	2.60	7.57	Pass
	11	2462	-3.54	6.02	2.48	0.29	2.77	7.87	Pass
2	1	2412	-3.43	6.02	2.59	0.29	2.88	7.77	Pass
	6	2437	-4.19	6.02	1.83	0.29	2.12	7.57	Pass
	11	2462	-3.60	6.02	2.42	0.29	2.71	7.87	Pass
3	1	2412	-3.75	6.02	2.27	0.29	2.56	7.77	Pass
	6	2437	-3.84	6.02	2.18	0.29	2.47	7.57	Pass
	11	2462	-3.75	6.02	2.27	0.29	2.56	7.87	Pass

Note:

- 2412MHz: Directional gain = $0.21\text{dBi} + 10\log(4) = 6.23\text{dBi} > 6\text{dBi}$, so the power density limit shall be reduced to $8-(6.23-6) = 7.77\text{dBm}$.
 2437MHz: Directional gain = $0.41\text{dBi} + 10\log(4) = 6.43\text{dBi} > 6\text{dBi}$, so the power density limit shall be reduced to $8-(6.43-6) = 7.57\text{dBm}$.
 2462MHz: Directional gain = $0.11\text{dBi} + 10\log(4) = 6.13\text{dBi} > 6\text{dBi}$, so the power density limit shall be reduced to $8-(6.13-6) = 7.87\text{dBm}$.
- Refer to section 3.3 for duty cycle spectrum plot.

802.11g

TX chain	Channel	Freq. (MHz)	PSD (dBm)	10 log (N=4) dB	Total PSD w/o duty factor (dBm)	Duty factor	Total PSD (dBm)	Limit (dBm)	PASS /FAIL
0	1	2412	-8.87	6.02	-2.85	0.15	-2.70	7.77	Pass
	6	2437	-7.67	6.02	-1.65	0.15	-1.50	7.57	Pass
	11	2462	-9.66	6.02	-3.64	0.15	-3.49	7.87	Pass
1	1	2412	-8.82	6.02	-2.80	0.15	-2.65	7.77	Pass
	6	2437	-7.00	6.02	-0.98	0.15	-0.83	7.57	Pass
	11	2462	-8.71	6.02	-2.69	0.15	-2.54	7.87	Pass
2	1	2412	-8.89	6.02	-2.87	0.15	-2.72	7.77	Pass
	6	2437	-7.23	6.02	-1.21	0.15	-1.06	7.57	Pass
	11	2462	-8.98	6.02	-2.96	0.15	-2.81	7.87	Pass
3	1	2412	-8.66	6.02	-2.64	0.15	-2.49	7.77	Pass
	6	2437	-6.84	6.02	-0.82	0.15	-0.67	7.57	Pass
	11	2462	-9.01	6.02	-2.99	0.15	-2.84	7.87	Pass

Note:

- 2412MHz: Directional gain = $0.21\text{dBi} + 10\log(4) = 6.23\text{dBi} > 6\text{dBi}$, so the power density limit shall be reduced to $8-(6.23-6) = 7.77\text{dBm}$.

2437MHz: Directional gain = $0.41\text{dBi} + 10\log(4) = 6.43\text{dBi} > 6\text{dBi}$, so the power density limit shall be reduced to $8-(6.43-6) = 7.57\text{dBm}$.

2462MHz: Directional gain = $0.11\text{dBi} + 10\log(4) = 6.13\text{dBi} > 6\text{dBi}$, so the power density limit shall be reduced to $8-(6.13-6) = 7.87\text{dBm}$.
- Refer to section 3.3 for duty cycle spectrum plot.

802.11n (20MHz)

TX chain	Channel	Freq. (MHz)	PSD (dBm)	10 log (N=4) dB	Total PSD (dBm)	Limit (dBm)	Pass / Fail
0	1	2412	-9.93	6.02	-3.91	7.77	Pass
	6	2437	-8.24	6.02	-2.22	7.57	Pass
	11	2462	-9.81	6.02	-3.79	7.87	Pass
1	1	2412	-9.59	6.02	-3.57	7.77	Pass
	6	2437	-7.74	6.02	-1.72	7.57	Pass
	11	2462	-8.93	6.02	-2.91	7.87	Pass
2	1	2412	-9.45	6.02	-3.43	7.77	Pass
	6	2437	-7.60	6.02	-1.58	7.57	Pass
	11	2462	-8.98	6.02	-2.96	7.87	Pass
3	1	2412	-9.39	6.02	-3.37	7.77	Pass
	6	2437	-7.74	6.02	-1.72	7.57	Pass
	11	2462	-8.92	6.02	-2.90	7.87	Pass

Note:

2412MHz: Directional gain = $0.21\text{dBi} + 10\log(4) = 6.23\text{dBi} > 6\text{dBi}$, so the power density limit shall be reduced to $8-(6.23-6) = 7.77\text{dBm}$.

2437MHz: Directional gain = $0.41\text{dBi} + 10\log(4) = 6.43\text{dBi} > 6\text{dBi}$, so the power density limit shall be reduced to $8-(6.43-6) = 7.57\text{dBm}$.

2462MHz: Directional gain = $0.11\text{dBi} + 10\log(4) = 6.13\text{dBi} > 6\text{dBi}$, so the power density limit shall be reduced to $8-(6.13-6) = 7.87\text{dBm}$.

802.11n (40MHz)

TX chain	Channel	Freq. (MHz)	PSD (dBm)	10 log (N=4) dB	Total PSD w/o duty factor (dBm)	Duty factor	Total PSD (dBm)	Limit (dBm)	PASS /FAIL
0	3	2422	-16.10	6.02	-10.08	0.11	-9.97	7.57	Pass
	6	2437	-12.84	6.02	-6.82	0.11	-6.71	7.57	Pass
	9	2452	-14.16	6.02	-8.14	0.11	-8.03	7.77	Pass
1	3	2422	-16.26	6.02	-10.24	0.11	-10.13	7.57	Pass
	6	2437	-12.12	6.02	-6.10	0.11	-5.99	7.57	Pass
	9	2452	-13.76	6.02	-7.74	0.11	-7.63	7.77	Pass
2	3	2422	-15.56	6.02	-9.54	0.11	-9.43	7.57	Pass
	6	2437	-12.39	6.02	-6.37	0.11	-6.26	7.57	Pass
	9	2452	-13.23	6.02	-7.21	0.11	-7.10	7.77	Pass
3	3	2422	-15.41	6.02	-9.39	0.11	-9.28	7.57	Pass
	6	2437	-12.54	6.02	-6.52	0.11	-6.41	7.57	Pass
	9	2452	-13.64	6.02	-7.62	0.11	-7.51	7.77	Pass

Note:

- 2422MHz: Directional gain = $0.41\text{dBi} + 10\log(4) = 6.43\text{dBi} > 6\text{dBi}$, so the power density limit shall be reduced to $8 - (6.43 - 6) = 7.57\text{dBm}$.
 2437MHz: Directional gain = $0.41\text{dBi} + 10\log(4) = 6.43\text{dBi} > 6\text{dBi}$, so the power density limit shall be reduced to $8 - (6.43 - 6) = 7.57\text{dBm}$.
 2452MHz: Directional gain = $0.21\text{dBi} + 10\log(4) = 6.23\text{dBi} > 6\text{dBi}$, so the power density limit shall be reduced to $8 - (6.23 - 6) = 7.77\text{dBm}$.
- Refer to section 3.3 for duty cycle spectrum plot.

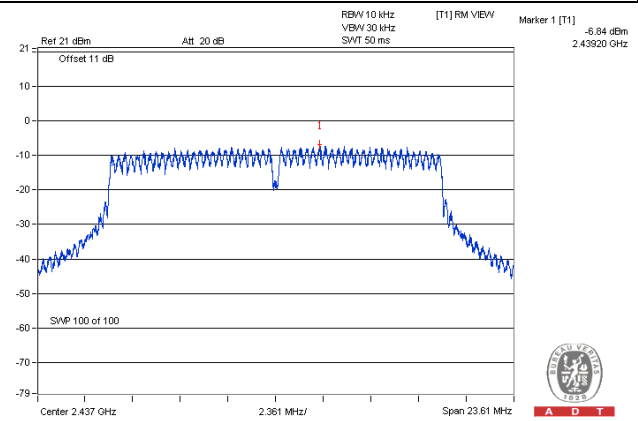
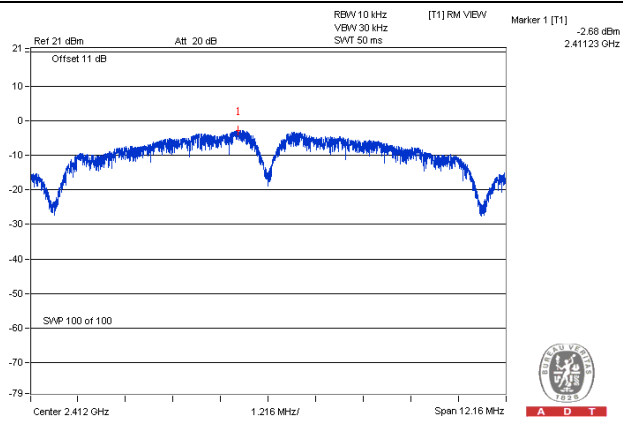
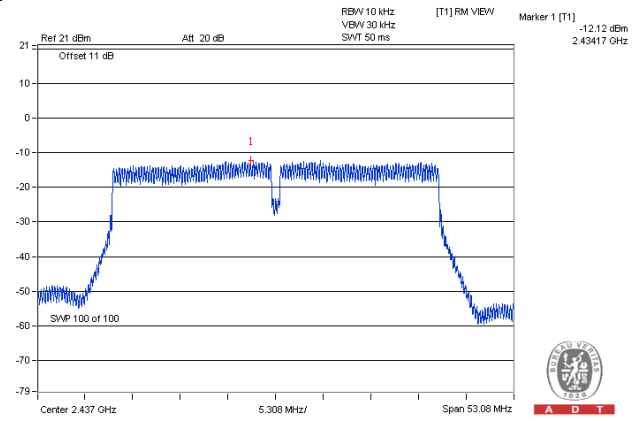
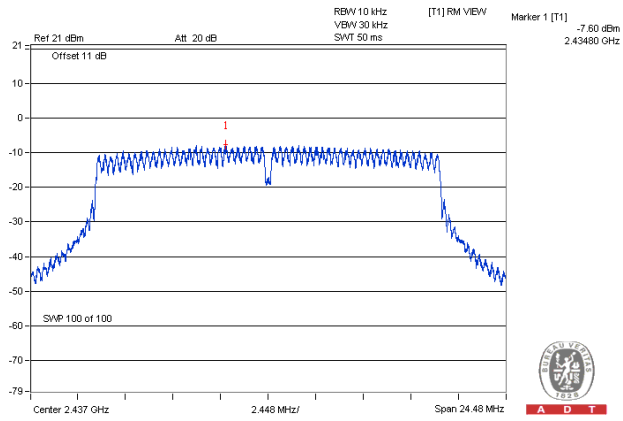
Spectrum Plot of Worst Value**802.11b****802.11g****802.11n (20MHz)****802.11n (40MHz)**

Beamforming_NSS1 Mode

802.11n (20MHz)

TX chain	Channel	Freq. (MHz)	PSD (dBm)	10 log (N=4) dB	Total PSD (dBm)	Limit (dBm)	Pass / Fail
0	1	2412	-9.50	6.02	-3.48	7.77	Pass
	6	2437	-8.18	6.02	-2.16	7.57	Pass
	11	2462	-8.72	6.02	-2.70	7.87	Pass
1	1	2412	-9.74	6.02	-3.72	7.77	Pass
	6	2437	-7.66	6.02	-1.64	7.57	Pass
	11	2462	-7.59	6.02	-1.57	7.87	Pass
2	1	2412	-9.40	6.02	-3.38	7.77	Pass
	6	2437	-7.57	6.02	-1.55	7.57	Pass
	11	2462	-8.23	6.02	-2.21	7.87	Pass
3	1	2412	-9.00	6.02	-2.98	7.77	Pass
	6	2437	-7.78	6.02	-1.76	7.57	Pass
	11	2462	-7.73	6.02	-1.71	7.87	Pass

Note:

2412MHz: Directional gain = $0.21\text{dBi} + 10\log(4) = 6.23\text{dBi} > 6\text{dBi}$, so the power density limit shall be reduced to $8 - (6.23 - 6) = 7.77\text{dBm}$.

2437MHz: Directional gain = $0.41\text{dBi} + 10\log(4) = 6.43\text{dBi} > 6\text{dBi}$, so the power density limit shall be reduced to $8 - (6.43 - 6) = 7.57\text{dBm}$.

2462MHz: Directional gain = $0.11\text{dBi} + 10\log(4) = 6.13\text{dBi} > 6\text{dBi}$, so the power density limit shall be reduced to $8 - (6.13 - 6) = 7.87\text{dBm}$.

802.11n (40MHz)

TX chain	Channel	Freq. (MHz)	PSD (dBm)	10 log (N=4) dB	Total PSD w/o duty factor (dBm)	Duty factor	Total PSD (dBm)	Limit (dBm)	PASS /FAIL
0	3	2422	-15.95	6.02	-8.88	0.13	-9.80	7.57	Pass
	6	2437	-12.17	6.02	-7.06	0.13	-6.02	7.57	Pass
	9	2452	-15.04	6.02	-8.22	0.13	-8.89	7.77	Pass
1	3	2422	-15.59	6.02	-9.71	0.13	-9.44	7.57	Pass
	6	2437	-12.09	6.02	-6.70	0.13	-5.94	7.57	Pass
	9	2452	-14.51	6.02	-8.20	0.13	-8.36	7.77	Pass
2	3	2422	-15.56	6.02	-8.87	0.13	-9.41	7.57	Pass
	6	2437	-12.28	6.02	-5.92	0.13	-6.13	7.57	Pass
	9	2452	-14.67	6.02	-6.89	0.13	-8.52	7.77	Pass
3	3	2422	-15.21	6.02	-8.09	0.13	-9.06	7.57	Pass
	6	2437	-12.30	6.02	-6.40	0.13	-6.15	7.57	Pass
	9	2452	-14.57	6.02	-7.24	0.13	-8.42	7.77	Pass

Note:

- 2422MHz: Directional gain = $0.41\text{dBi} + 10\log(4) = 6.43\text{dBi} > 6\text{dBi}$, so the power density limit shall be reduced to $8 - (6.43 - 6) = 7.57\text{dBm}$.
 2437MHz: Directional gain = $0.41\text{dBi} + 10\log(4) = 6.43\text{dBi} > 6\text{dBi}$, so the power density limit shall be reduced to $8 - (6.43 - 6) = 7.57\text{dBm}$.
 2452MHz: Directional gain = $0.21\text{dBi} + 10\log(4) = 6.23\text{dBi} > 6\text{dBi}$, so the power density limit shall be reduced to $8 - (6.23 - 6) = 7.77\text{dBm}$.
- Refer to section 3.3 for duty cycle spectrum plot.

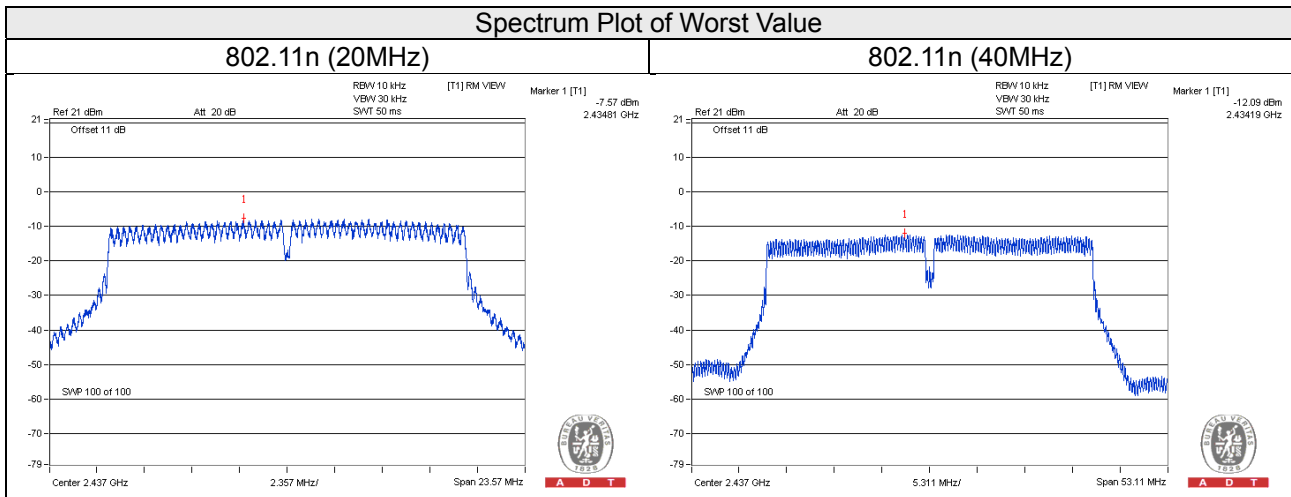

Beamforming_NSS2 Mode

802.11n (20MHz)

TX chain	Channel	Freq. (MHz)	PSD (dBm)	10 log (N=4) dB	Total PSD (dBm)	Limit (dBm)	Pass / Fail
0	1	2412	-9.50	6.02	-3.48	8.00	Pass
	6	2437	-8.02	6.02	-2.00	8.00	Pass
	11	2462	-8.05	6.02	-2.03	8.00	Pass
1	1	2412	-9.57	6.02	-3.55	8.00	Pass
	6	2437	-7.18	6.02	-1.16	8.00	Pass
	11	2462	-7.62	6.02	-1.60	8.00	Pass
2	1	2412	-9.39	6.02	-3.37	8.00	Pass
	6	2437	-7.80	6.02	-1.78	8.00	Pass
	11	2462	-8.37	6.02	-2.35	8.00	Pass
3	1	2412	-9.05	6.02	-3.03	8.00	Pass
	6	2437	-7.81	6.02	-1.79	8.00	Pass
	11	2462	-7.83	6.02	-1.81	8.00	Pass

Note:

2412MHz: Directional gain = $0.21\text{dBi} + 10\log(4/2) = 3.22\text{dBi} < 6\text{dBi}$, so the power density limit no need to reduced.

2437MHz: Directional gain = $0.41\text{dBi} + 10\log(4/2) = 3.42\text{dBi} < 6\text{dBi}$, so the power density limit no need to reduced.

2462MHz: Directional gain = $0.11\text{dBi} + 10\log(4/2) = 3.12\text{dBi} < 6\text{dBi}$, so the power density limit no need to reduced.

802.11n (40MHz)

TX chain	Channel	Freq. (MHz)	PSD (dBm)	10 log (N=4) dB	Total PSD w/o duty factor (dBm)	Duty factor	Total PSD (dBm)	Limit (dBm)	PASS /FAIL
0	3	2422	-15.68	6.02	-9.66	0.13	-9.53	8.00	Pass
	6	2437	-12.51	6.02	-6.49	0.13	-6.36	8.00	Pass
	9	2452	-15.01	6.02	-8.99	0.13	-8.86	8.00	Pass
1	3	2422	-15.61	6.02	-9.59	0.13	-9.46	8.00	Pass
	6	2437	-11.75	6.02	-5.73	0.13	-5.60	8.00	Pass
	9	2452	-14.89	6.02	-8.87	0.13	-8.74	8.00	Pass
2	3	2422	-15.38	6.02	-9.36	0.13	-9.23	8.00	Pass
	6	2437	-12.15	6.02	-6.13	0.13	-6.00	8.00	Pass
	9	2452	-14.64	6.02	-8.62	0.13	-8.49	8.00	Pass
3	3	2422	-15.29	6.02	-9.27	0.13	-9.14	8.00	Pass
	6	2437	-11.79	6.02	-5.77	0.13	-5.64	8.00	Pass
	9	2452	-14.56	6.02	-8.54	0.13	-8.41	8.00	Pass

Note:

- 2412MHz: Directional gain = $0.41\text{dB} + 10\log(4/2) = 3.42\text{dBi} < 6\text{dBi}$, so the power density limit no need to reduced.

2437MHz: Directional gain = $0.41\text{dB} + 10\log(4/2) = 3.42\text{dBi} < 6\text{dBi}$, so the power density limit no need to reduced.

2462MHz: Directional gain = $0.21\text{dB} + 10\log(4/2) = 3.22\text{dBi} < 6\text{dBi}$, so the power density limit no need to reduced.
- Refer to section 3.3 for duty cycle spectrum plot.

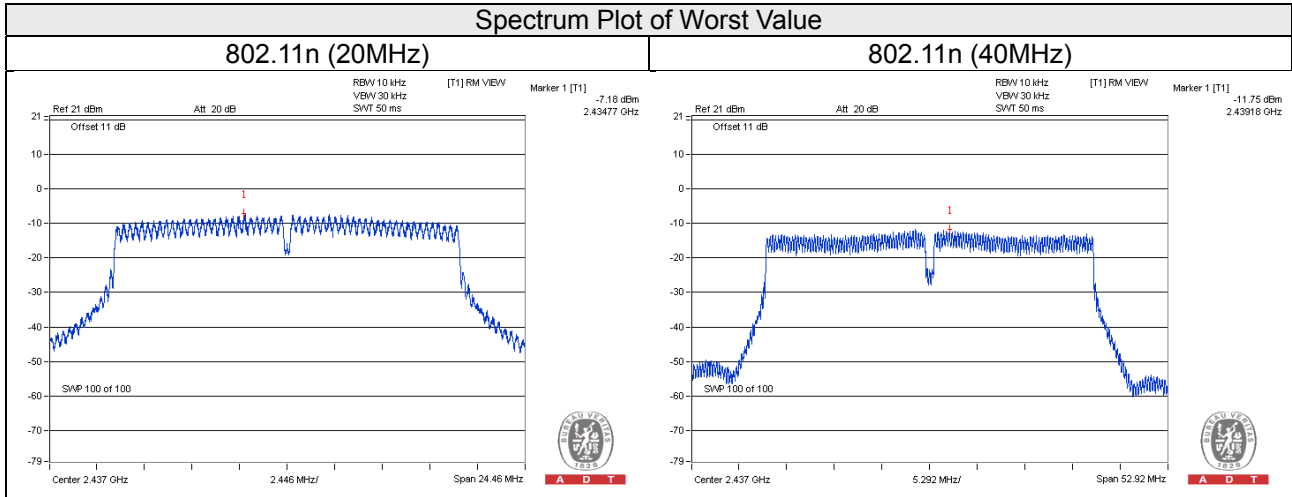

4.6 Conducted Out of Band Emission Measurement

4.6.1 Limits of Conducted Out of Band Emission Measurement

Below 30dB of the highest emission level of operating band (in 100kHz Resolution Bandwidth).

4.6.2 Test Setup

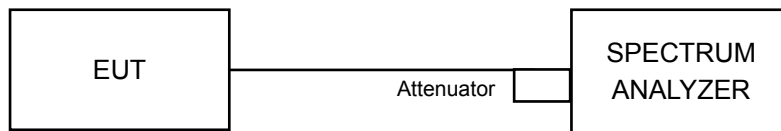

4.6.3 Test Instruments

Refer to section 4.1.2 to get information of above instrument.

4.6.4 Test Procedure

MEASUREMENT PROCEDURE REF

- Set the RBW = 100 kHz.
- Set the VBW \geq 300 kHz.
- Detector = average.
- Sweep time = auto couple.
- Trace mode = max hold.
- Allow trace to fully stabilize.
- Use the peak marker function to determine the maximum power level in any 100 kHz band segment within the fundamental EBW.

MEASUREMENT PROCEDURE OOBE

- Set RBW = 100 kHz.
- Set VBW \geq 300 kHz.
- Detector = peak.
- Sweep = auto couple.
- Trace Mode = max hold.
- Allow trace to fully stabilize.
- Use the peak marker function to determine the maximum amplitude level.

4.6.5 Deviation from Test Standard

No deviation.

4.6.6 EUT Operating Condition

Same as Item 4.3.6

4.6.7 Test Results

The conducted emission test is performed on each TX port of operating mode without summing or adding $10\log(N)$ since the limit is relative emission limit.

The spectrum plots are attached on the following pages. D1 line indicates the highest level, and D2 line indicates the 30dB offset below D1. It shows compliance with the requirement.

CDD Mode
802.11b_Chain 0

CH 1

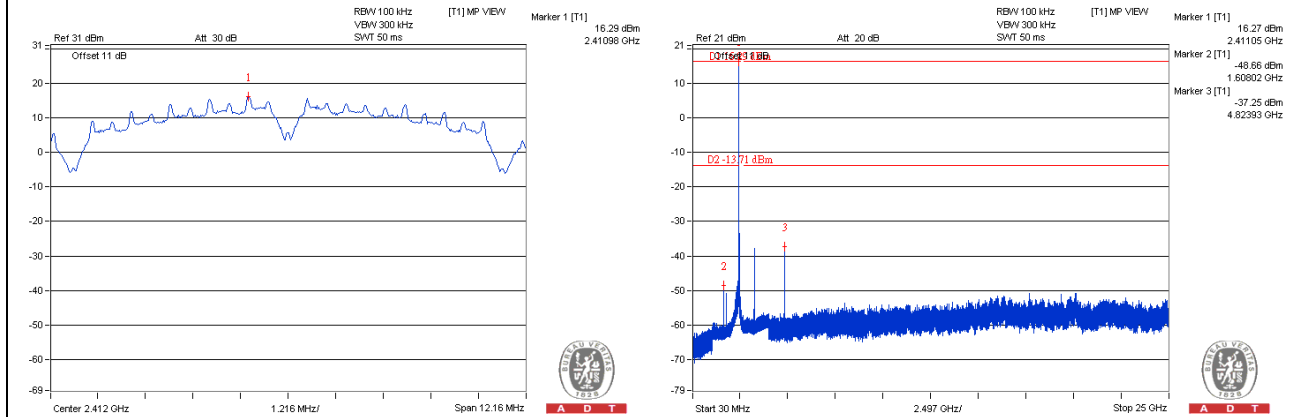

CH 6

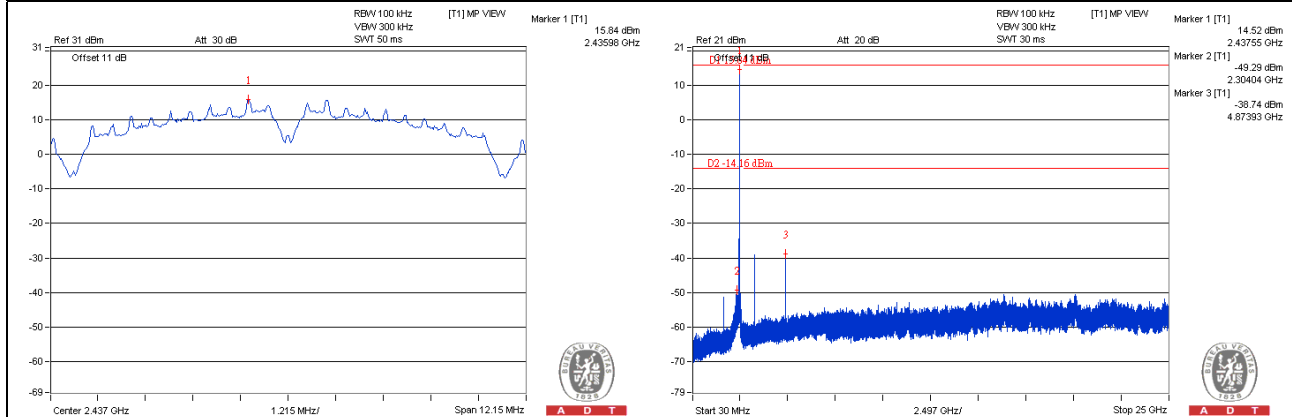

CH 11

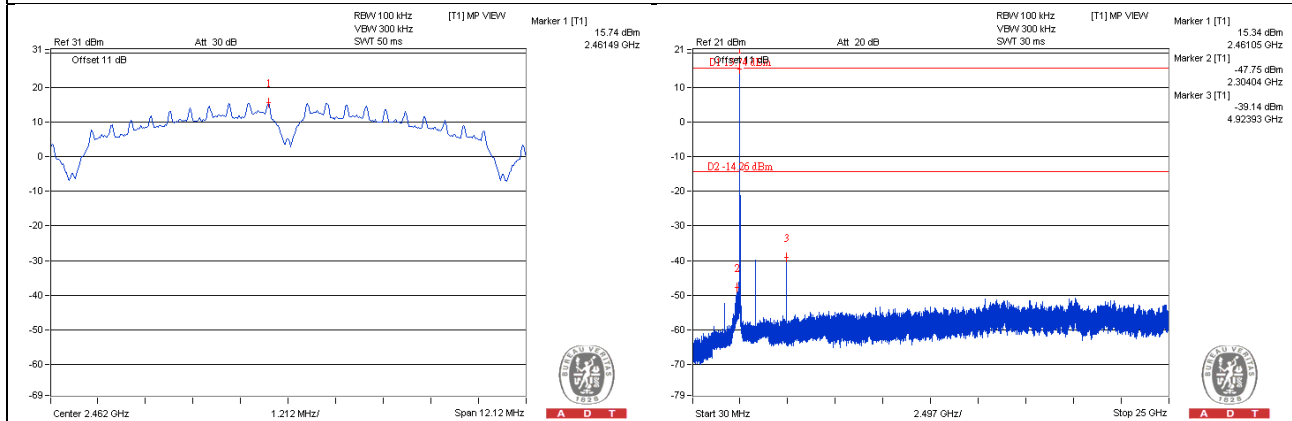

802.11b_Chain 1

CH 1

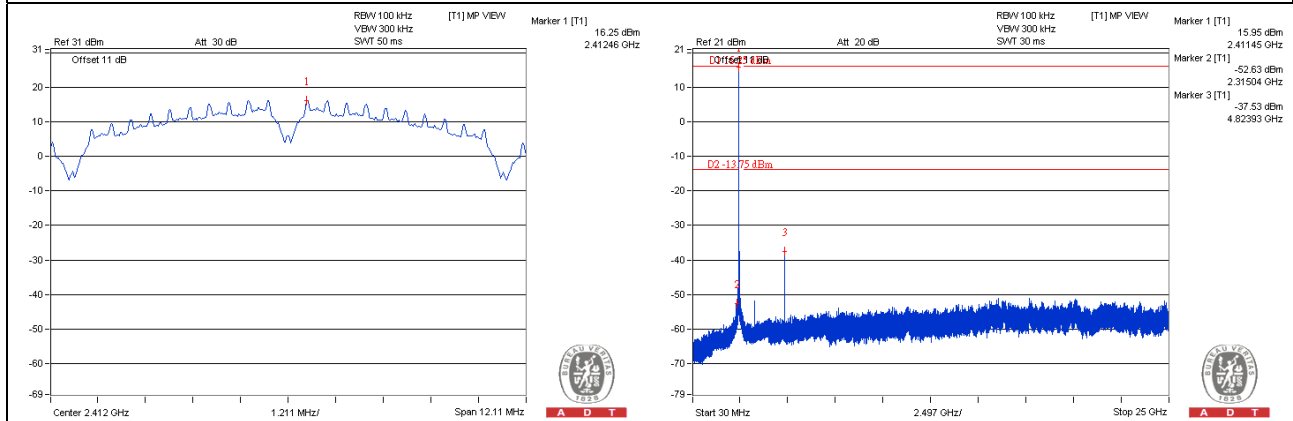

CH 6

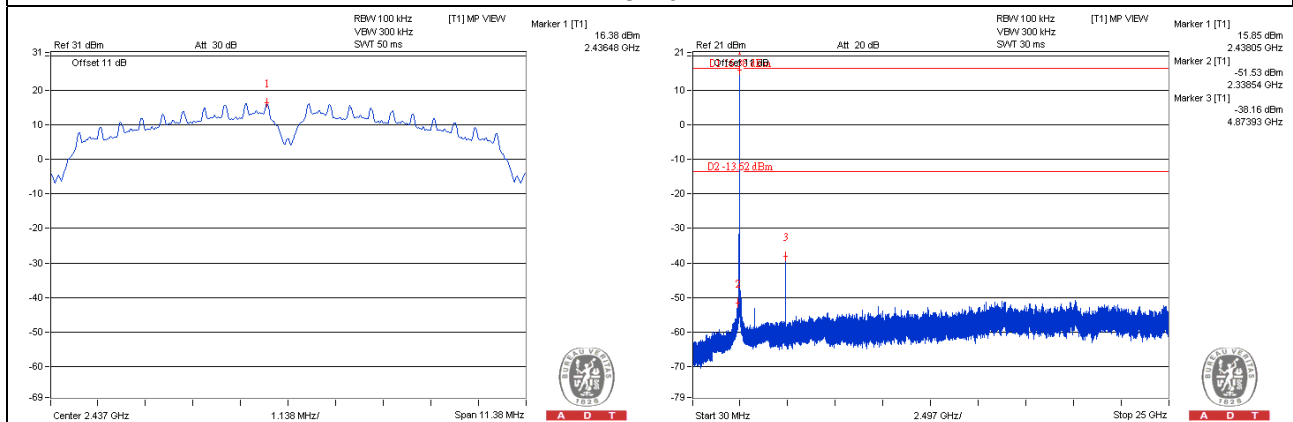

CH 11

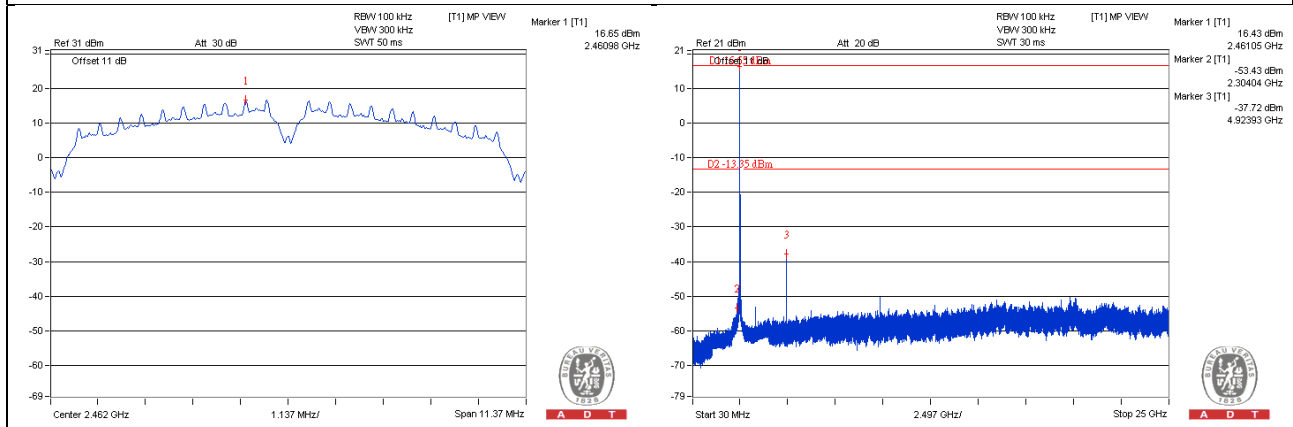

802.11b_Chain 2

CH 1

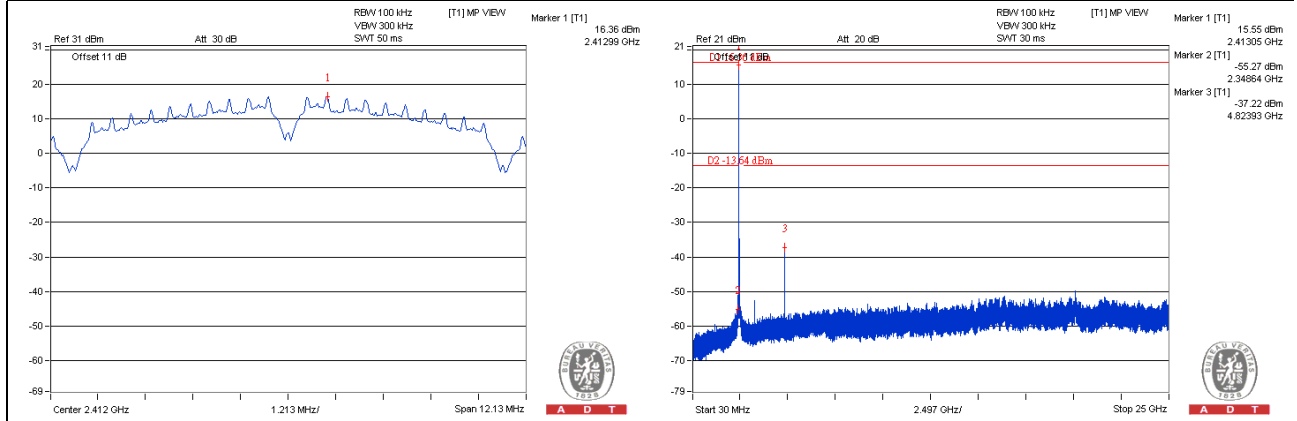

CH 6

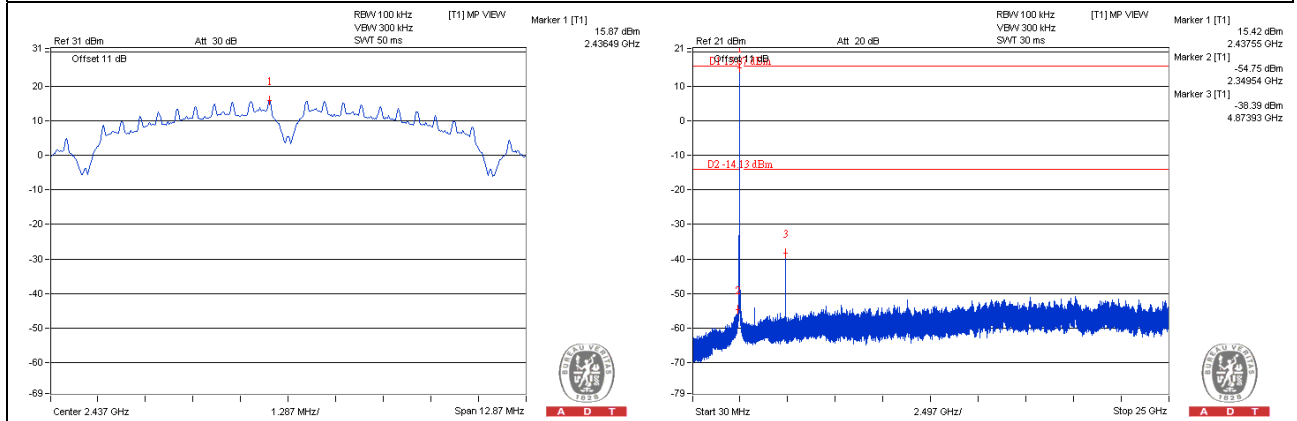

CH 11

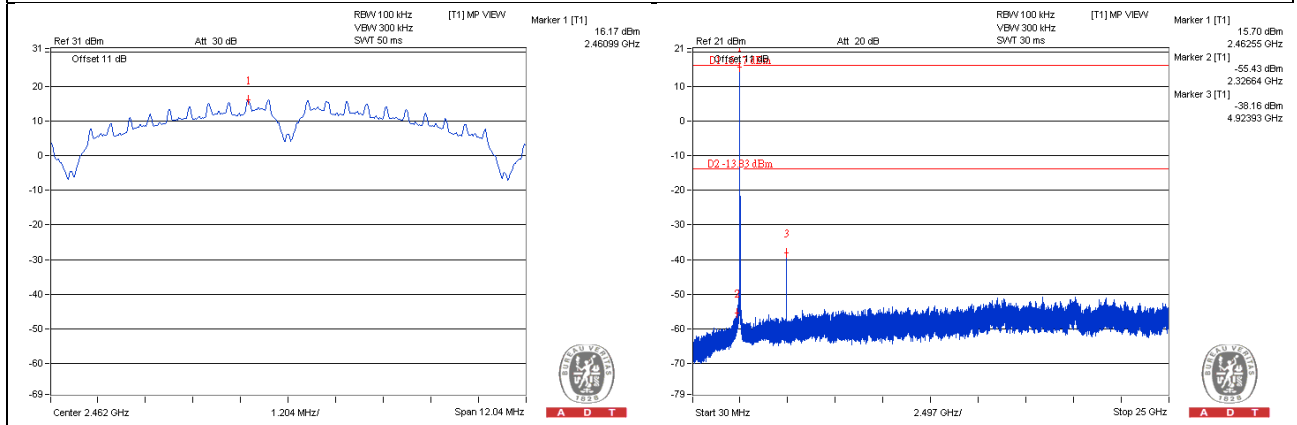

802.11b_Chain 3

CH 1

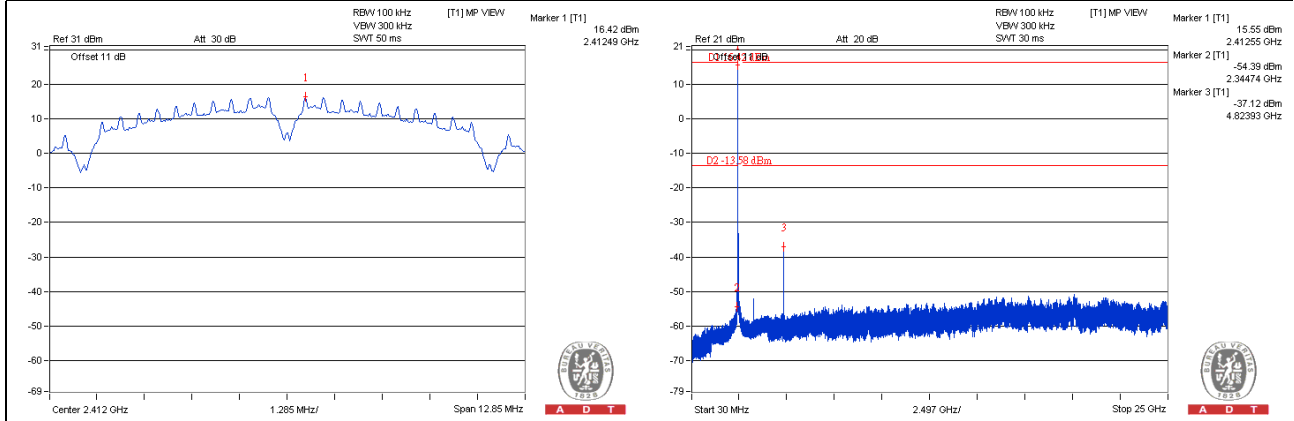

CH 6

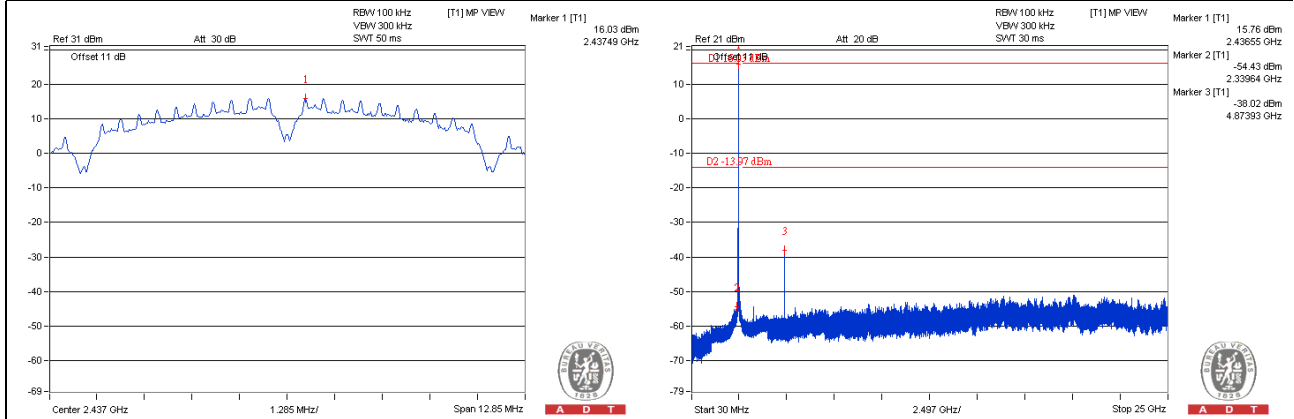

CH 11

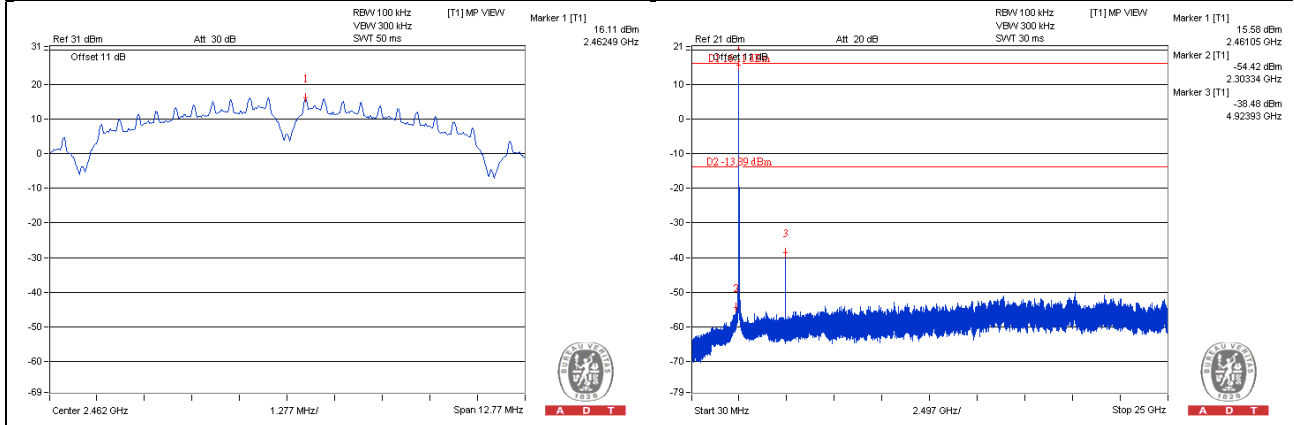

802.11g_Chain 0

CH 1

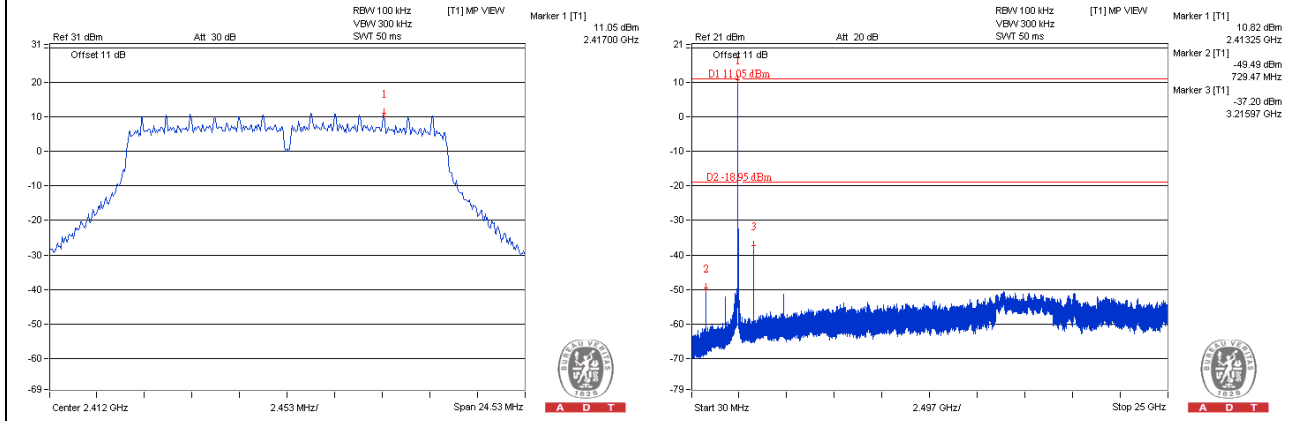

CH 6

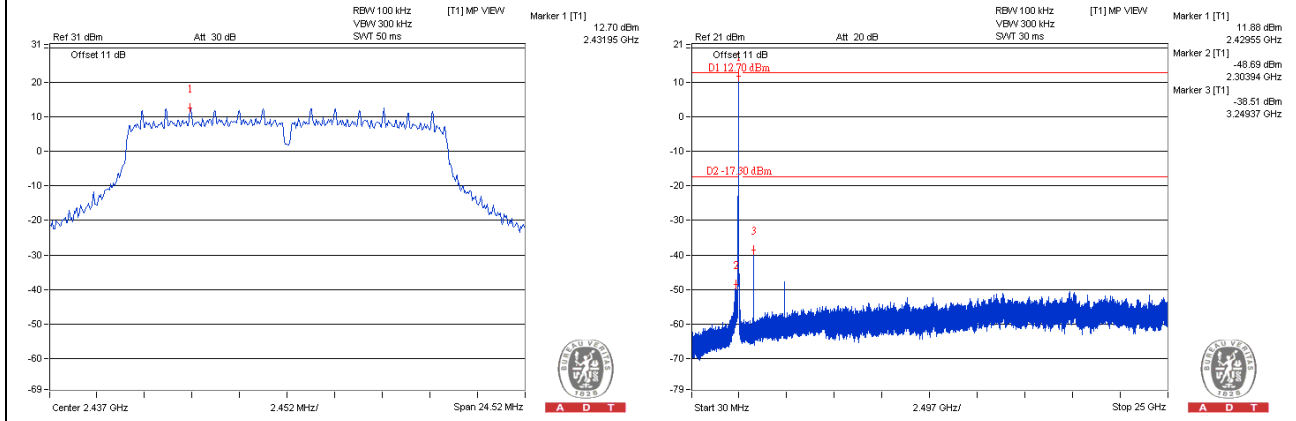

CH 11

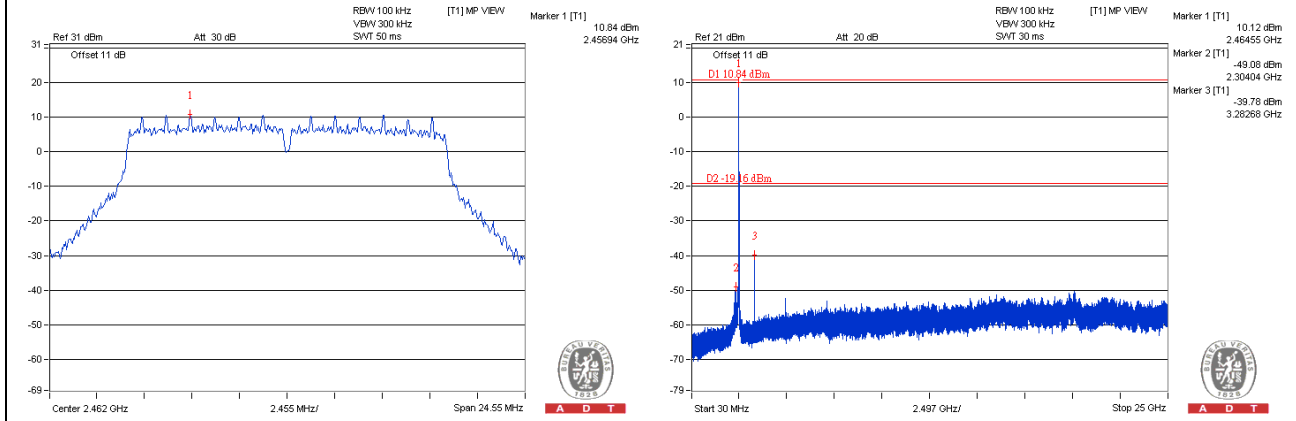

802.11g_Chain 1

CH 1

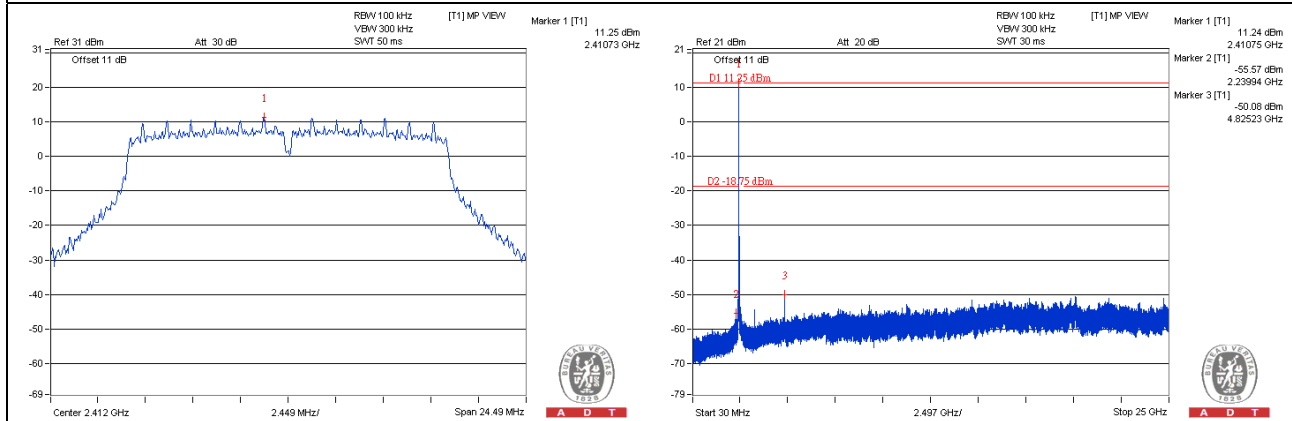

CH 6

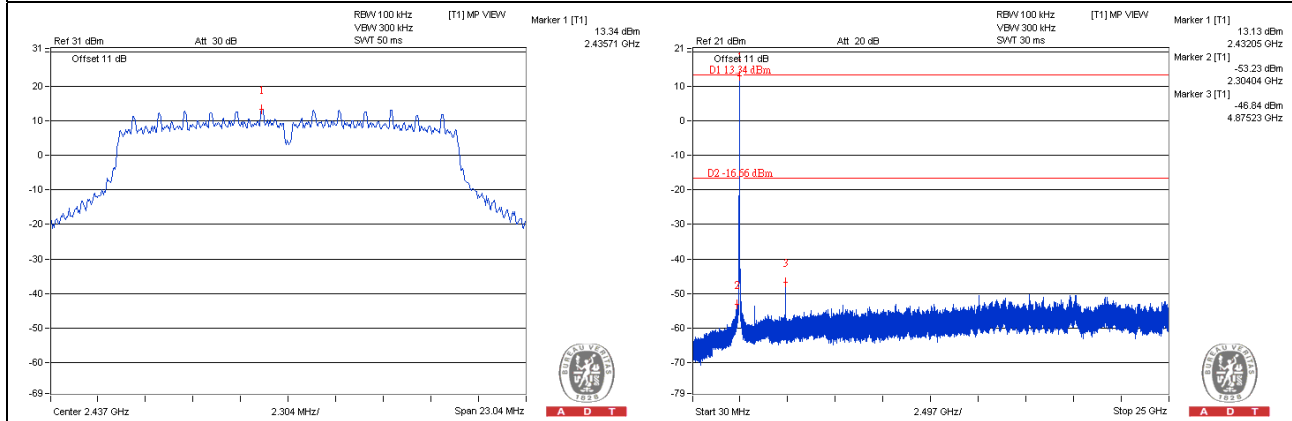

CH 11

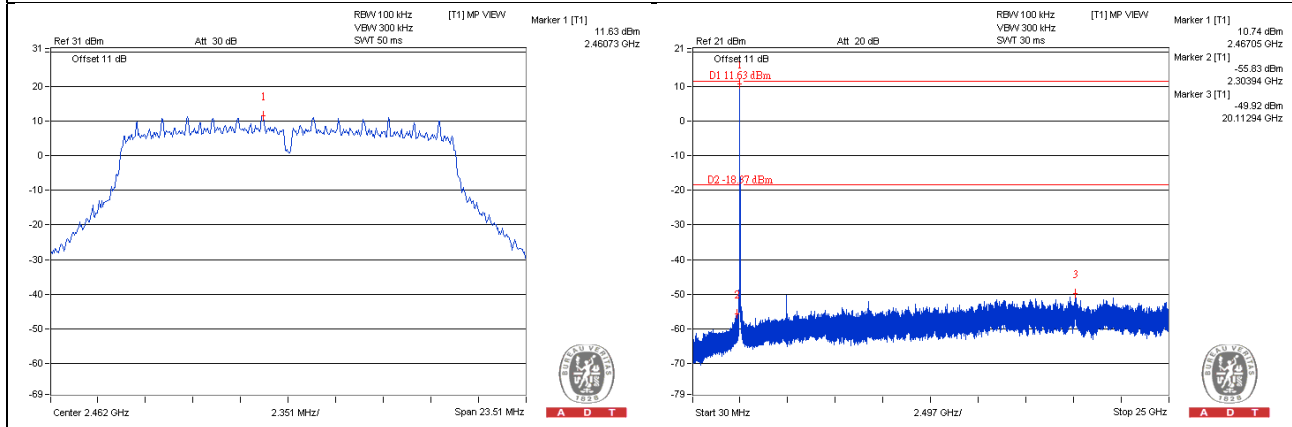

802.11g_Chain 2

CH 1

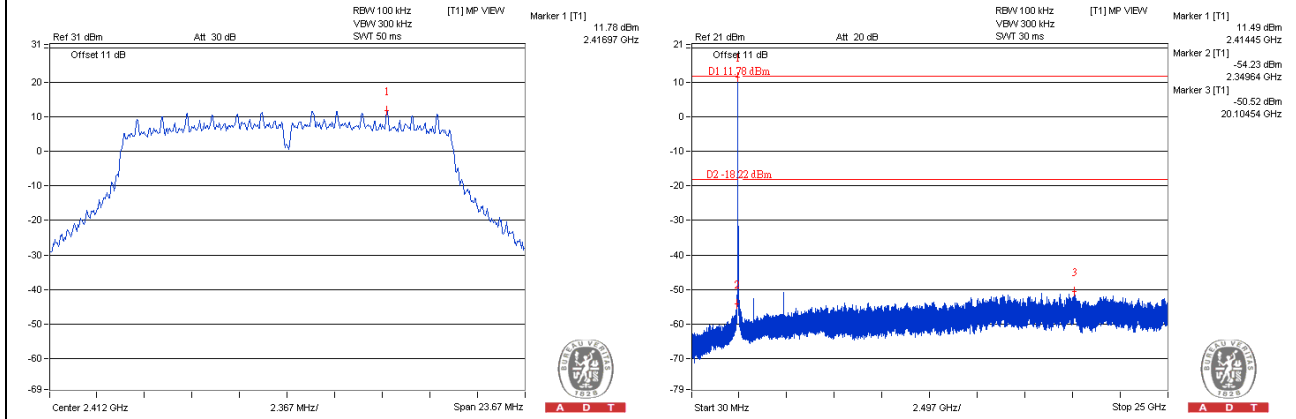

CH 6

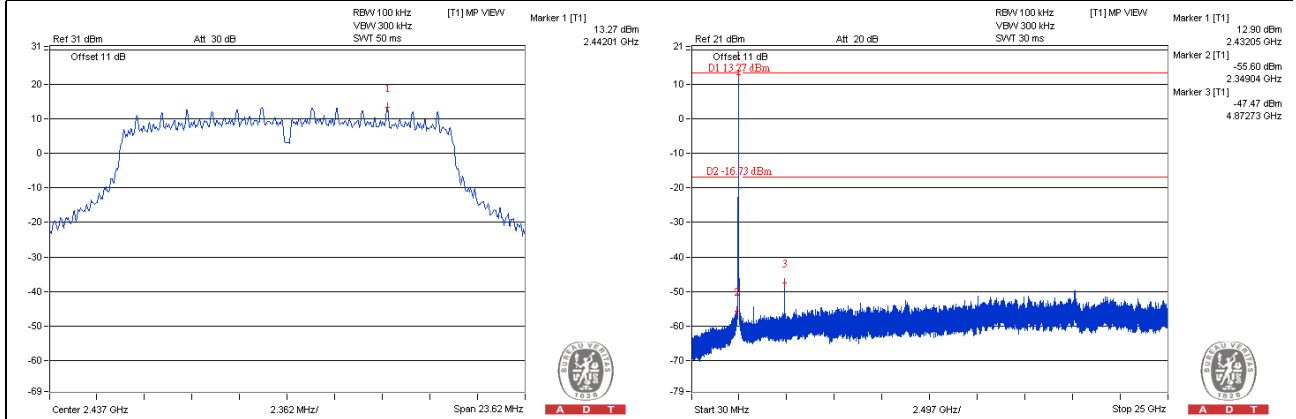

CH 11

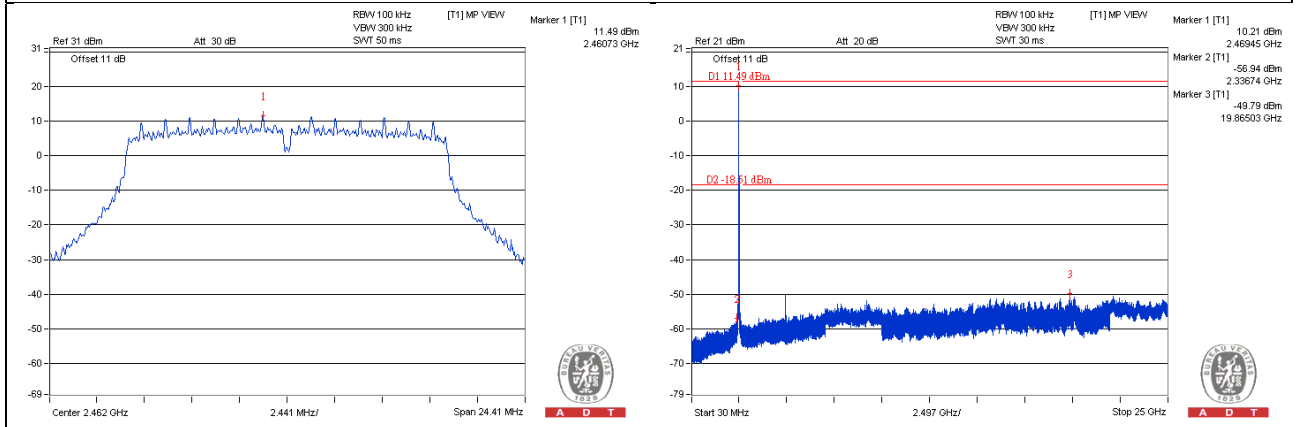

802.11g_Chain 3

CH 1

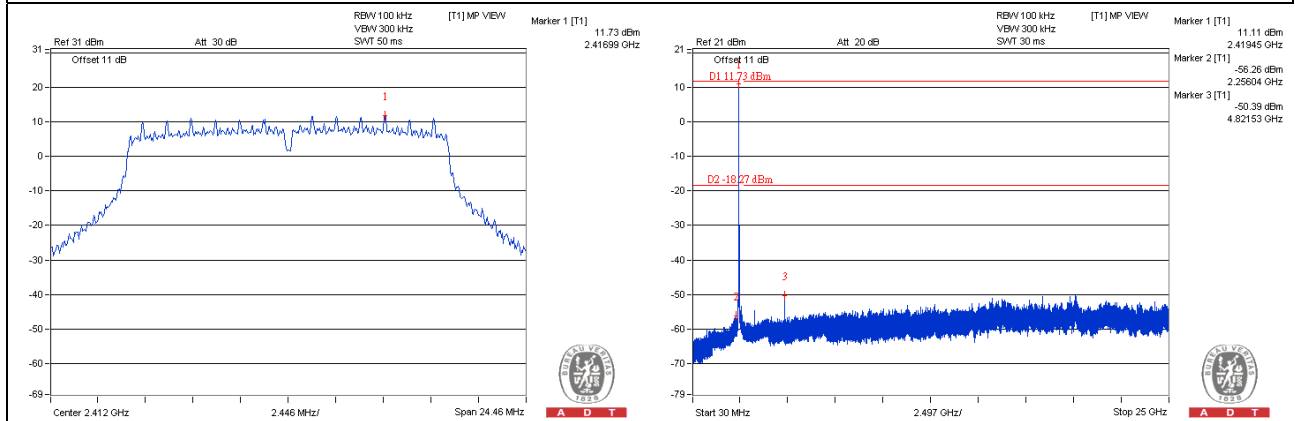

CH 6

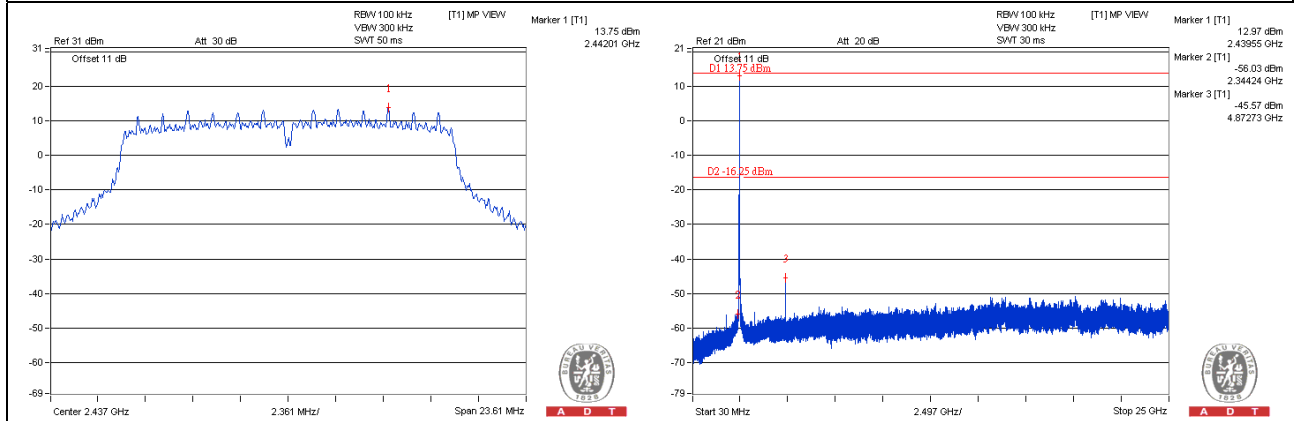

CH 11

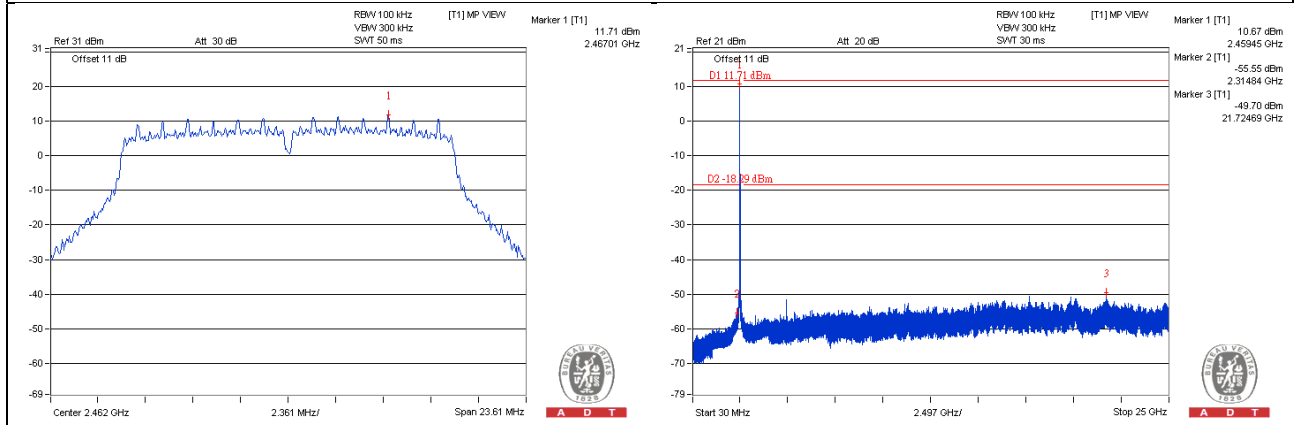

802.11n (20MHz)_Chain 0

CH 1

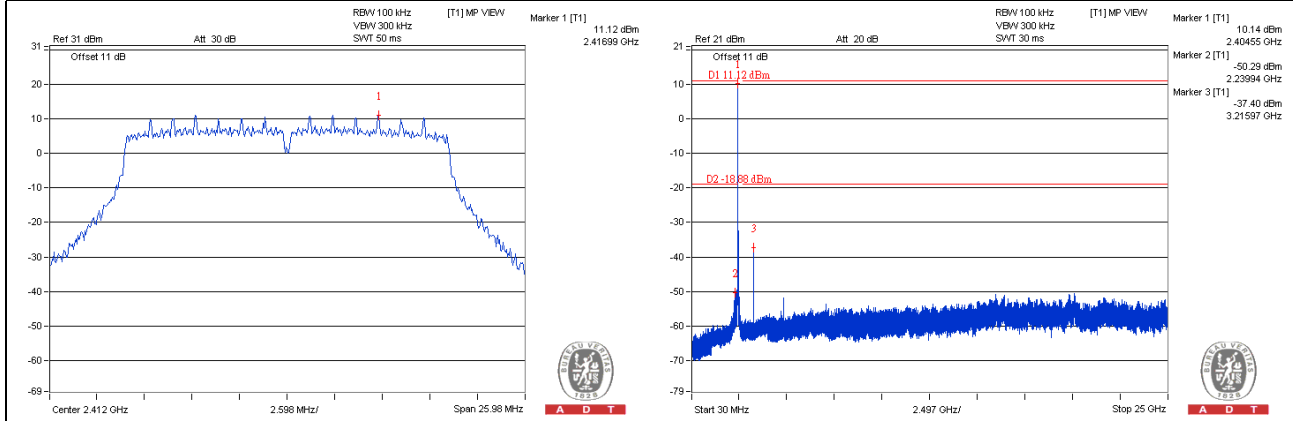

CH 6

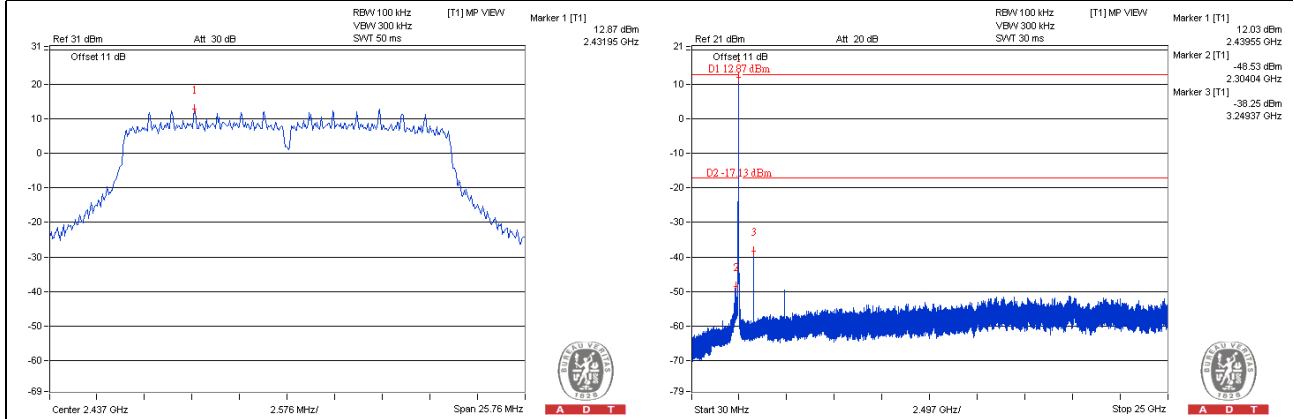

CH 11

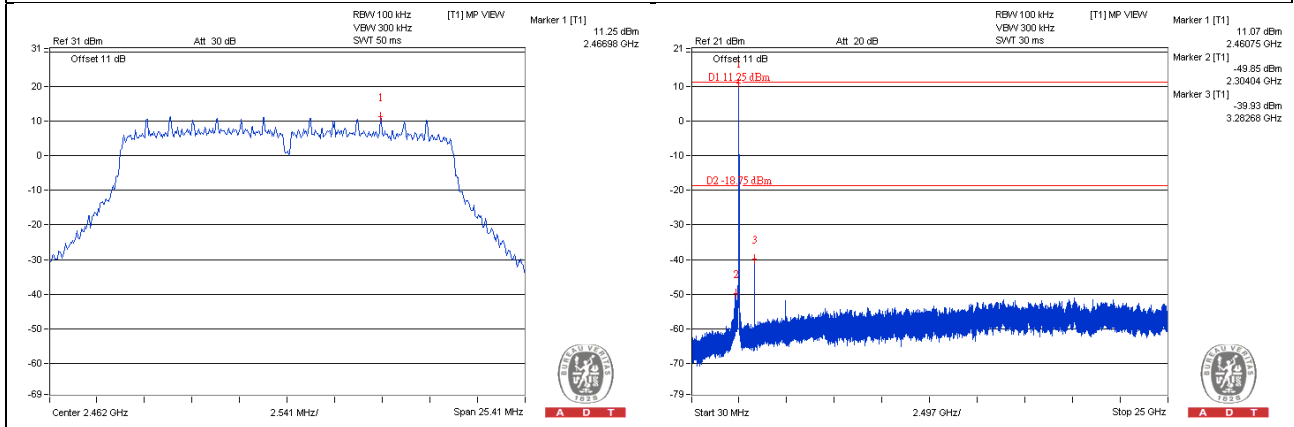

802.11n (20MHz)_Chain 1

CH 1

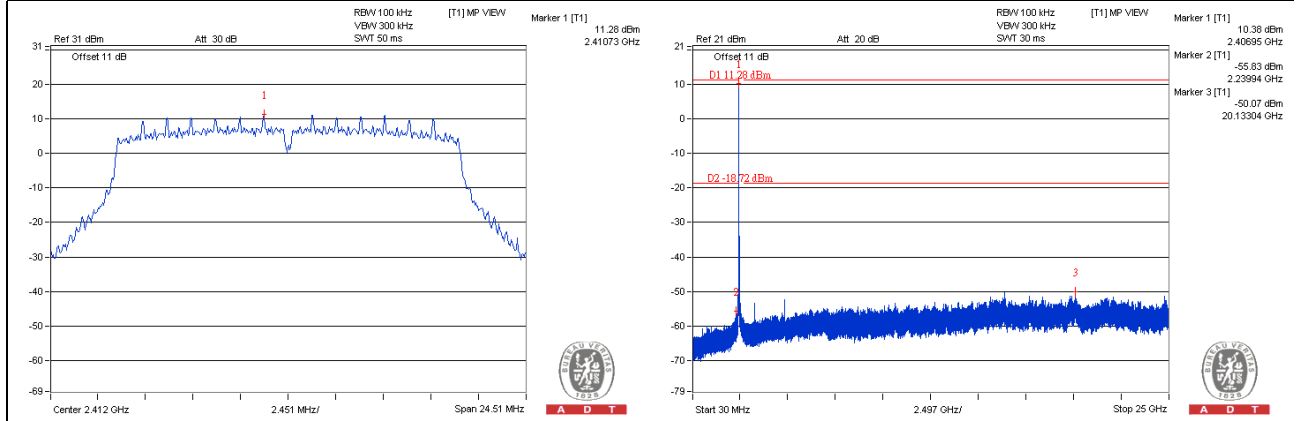

CH 6

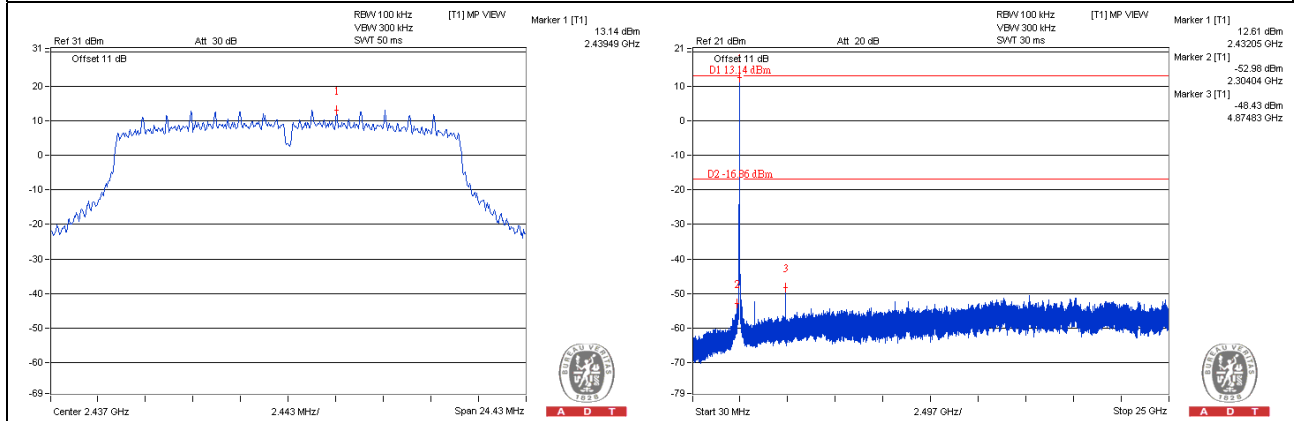

CH 11

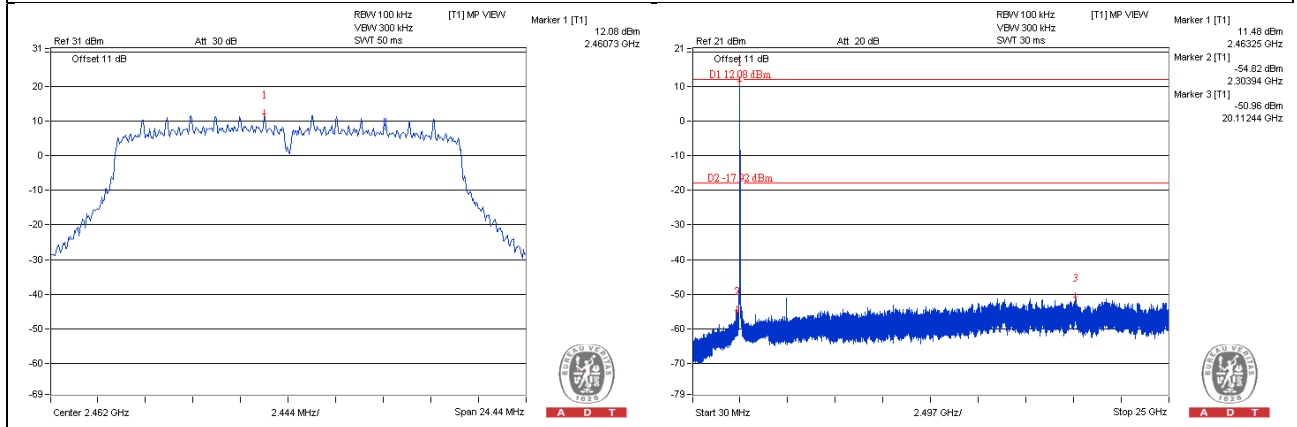

802.11n (20MHz)_Chain 2

CH 1

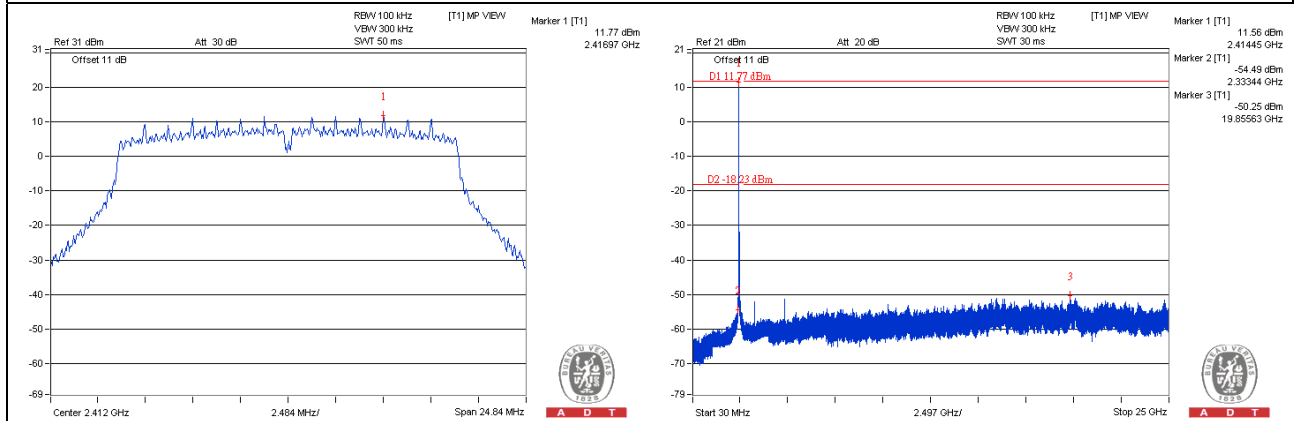

CH 6

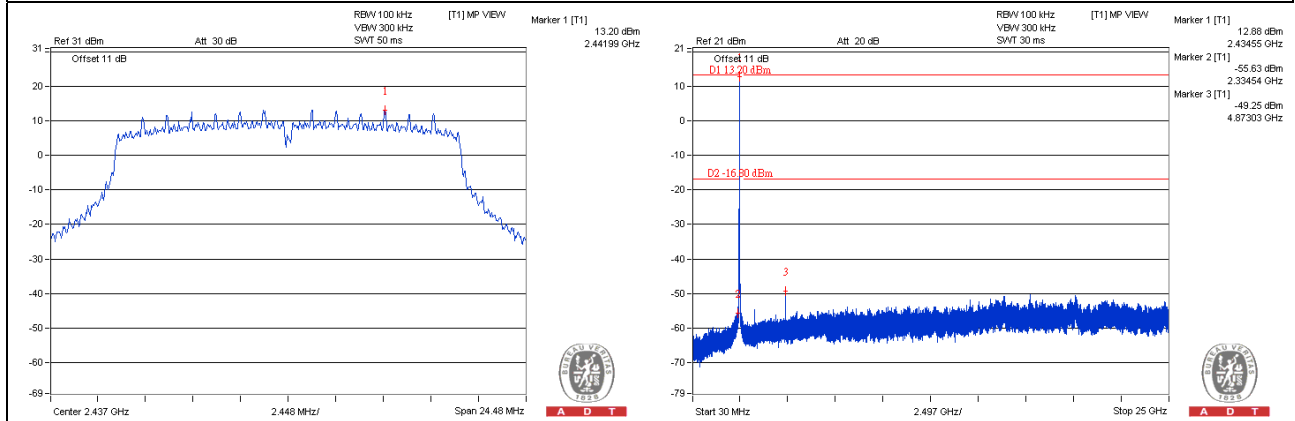

CH 11

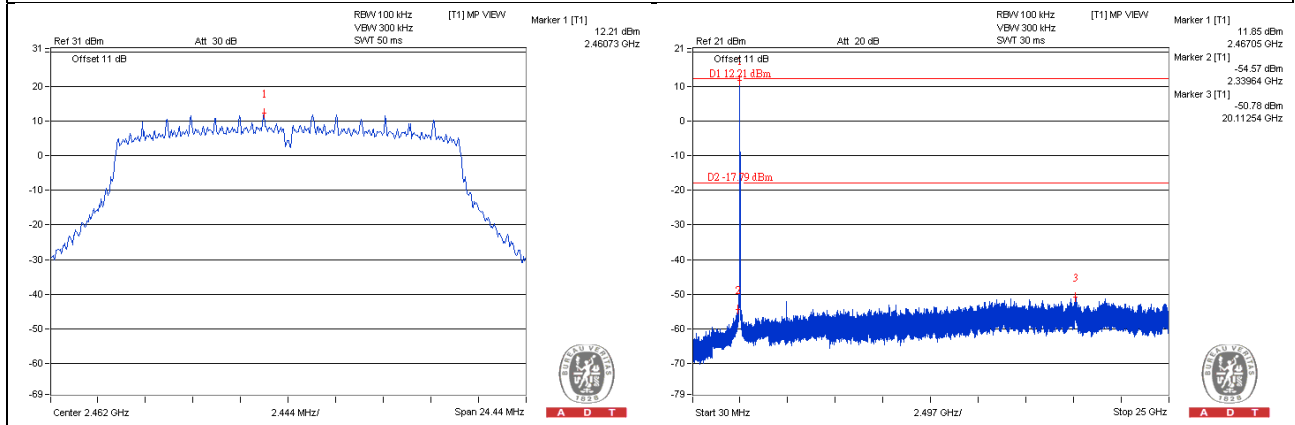

802.11n (20MHz)_Chain 3

CH 1

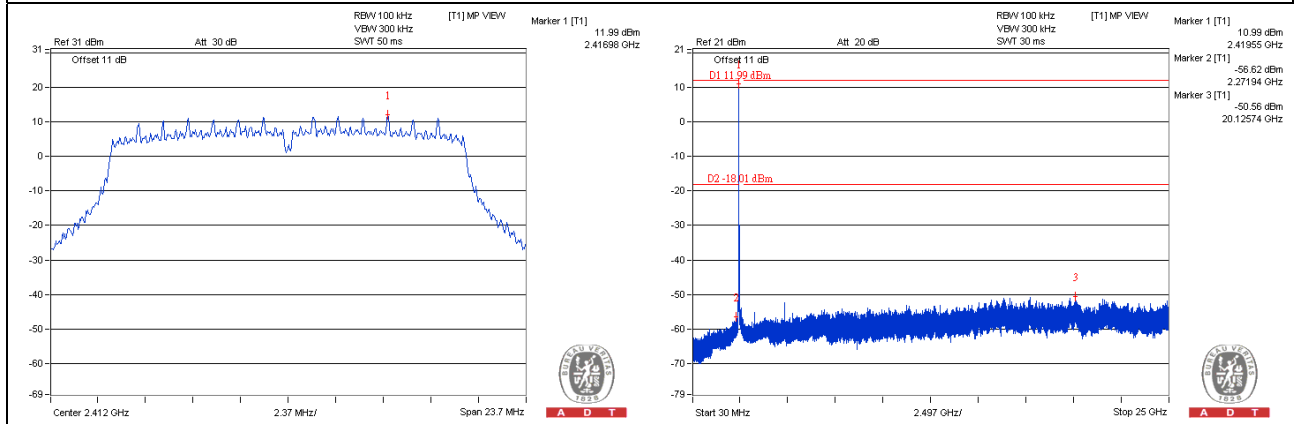

CH 6

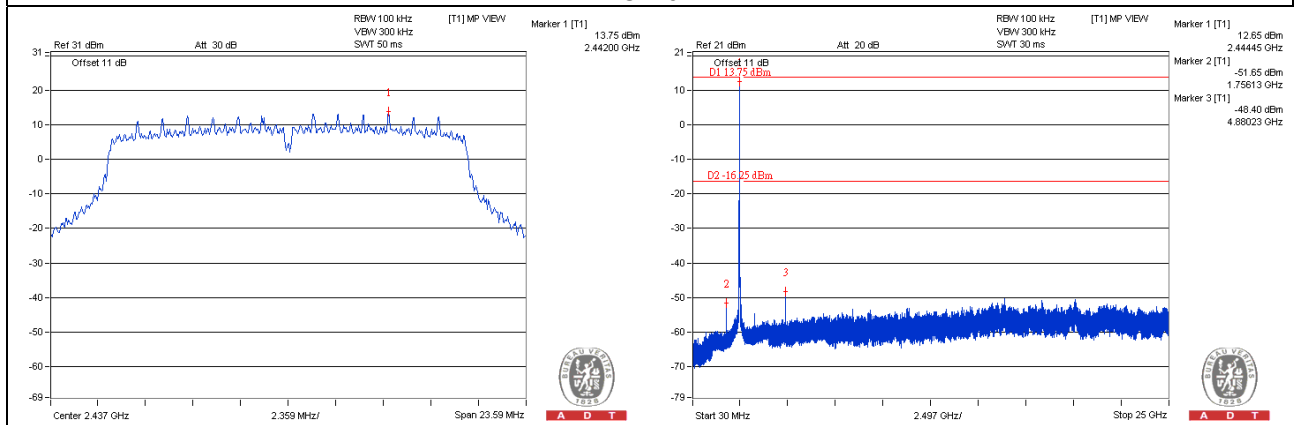

CH 11

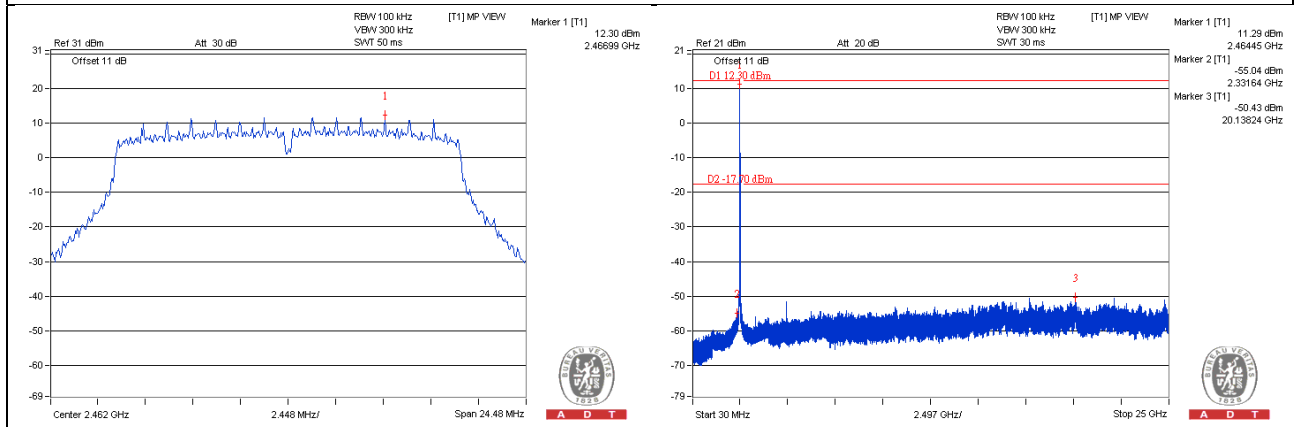

802.11n (40MHz)_Chain 0

CH 3

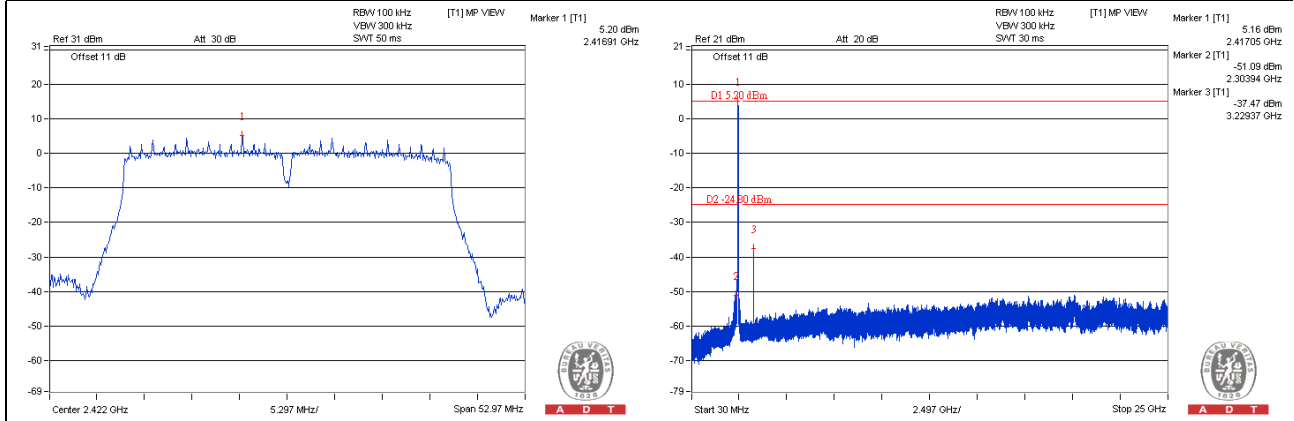

CH 6

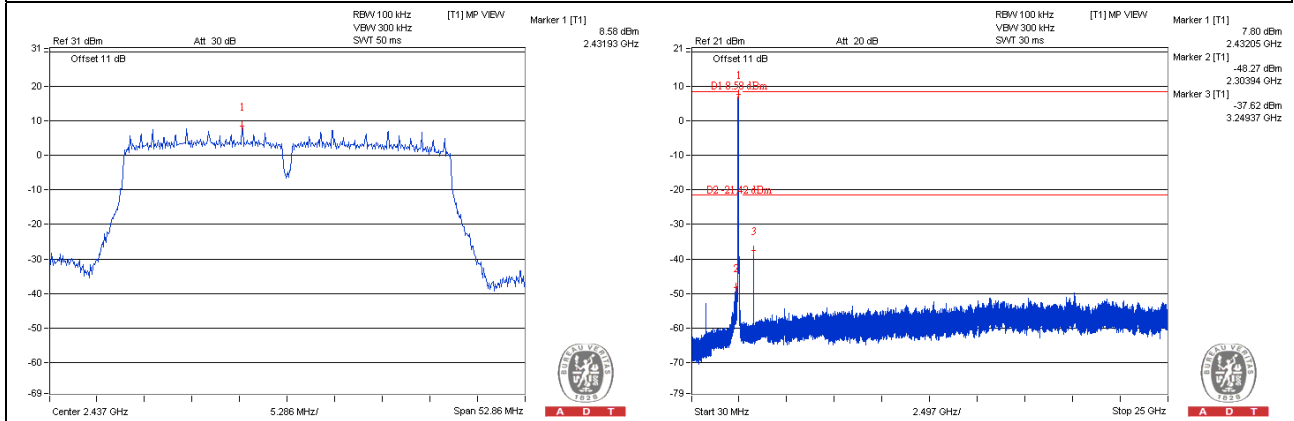

CH 9

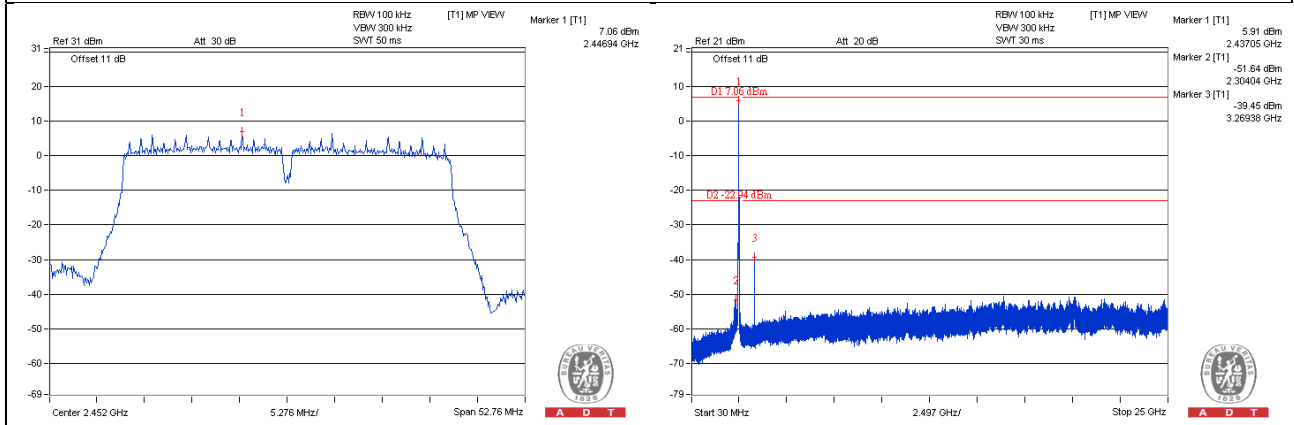

802.11n (40MHz)_Chain 1

CH 3

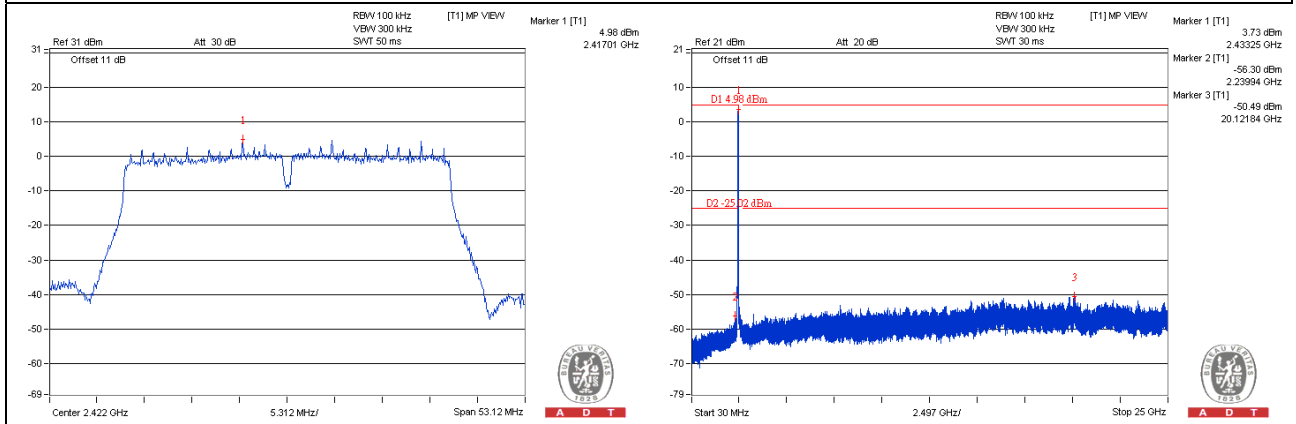

CH 6

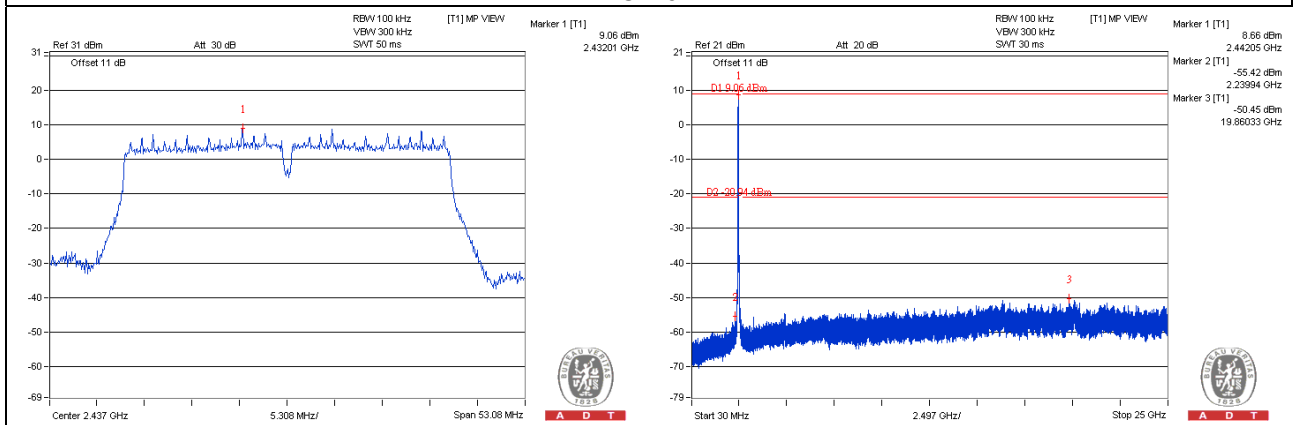

CH 9

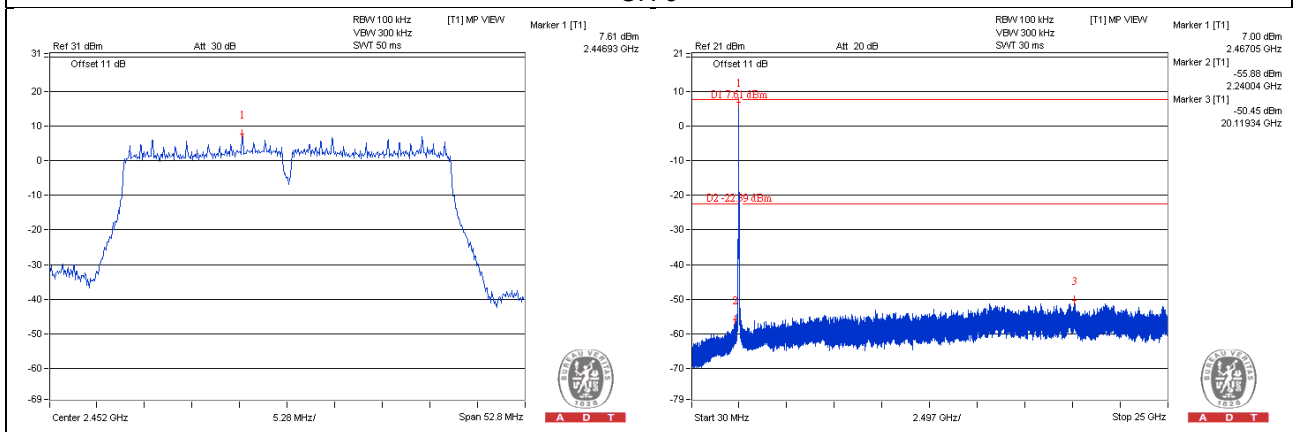

802.11n (40MHz)_Chain 2

CH 3

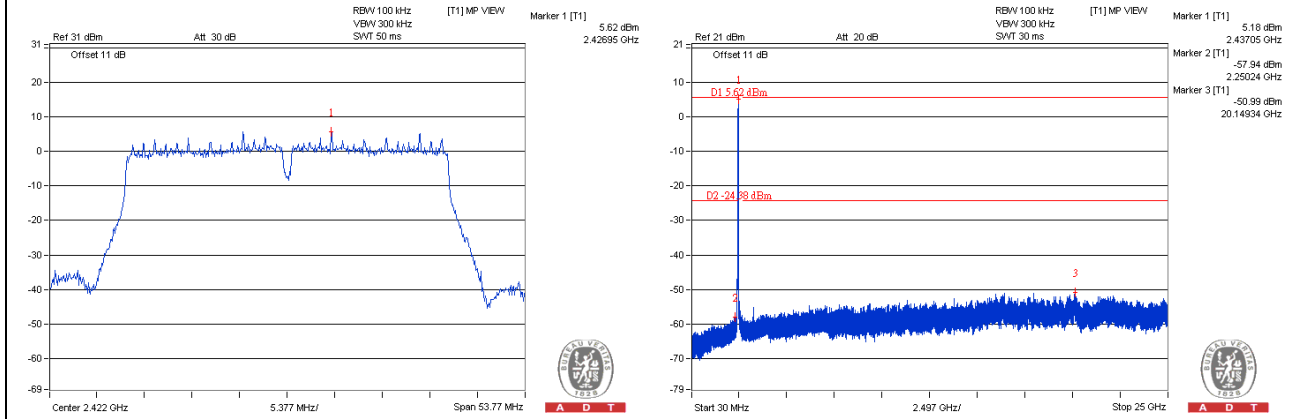

CH 6

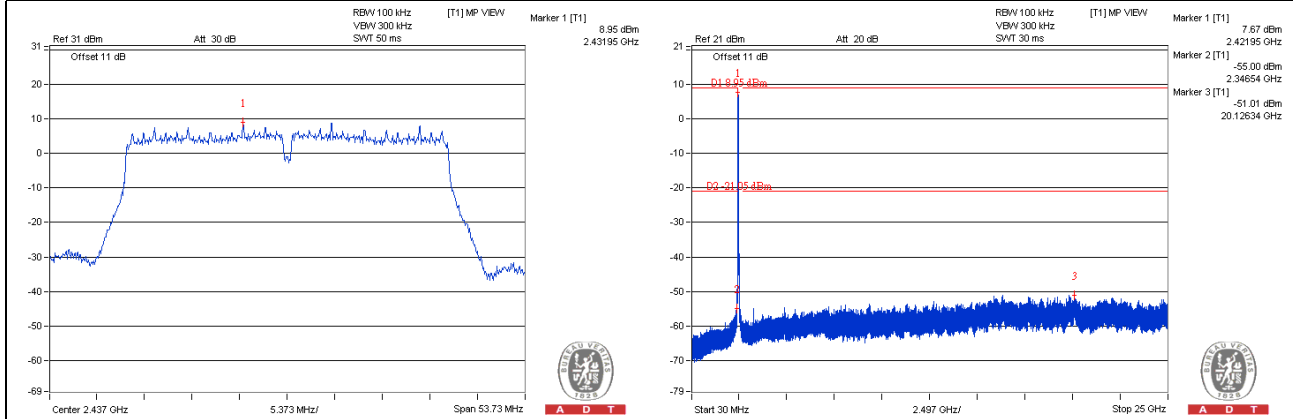

CH 9

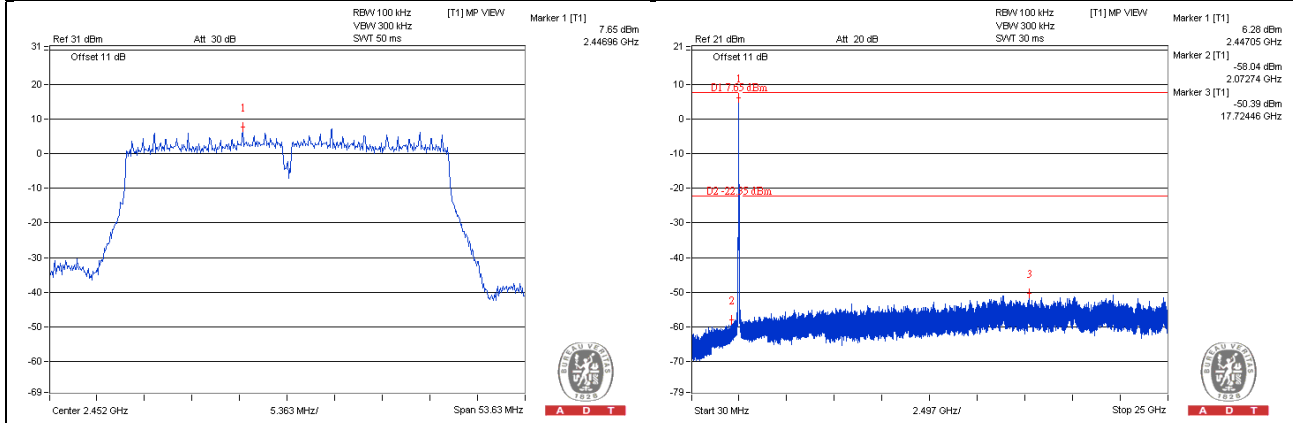

802.11n (40MHz)_Chain 3

CH 3

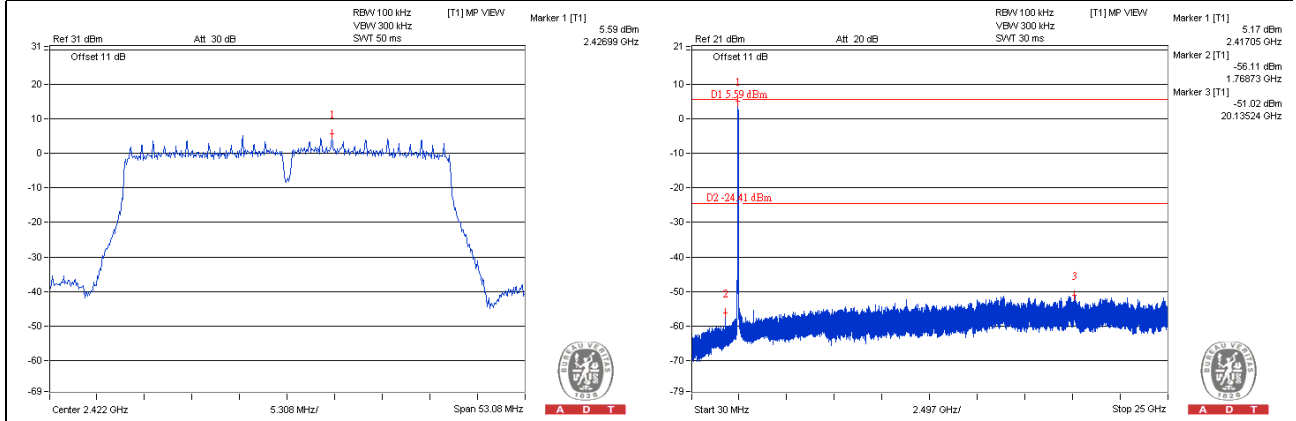

CH 6

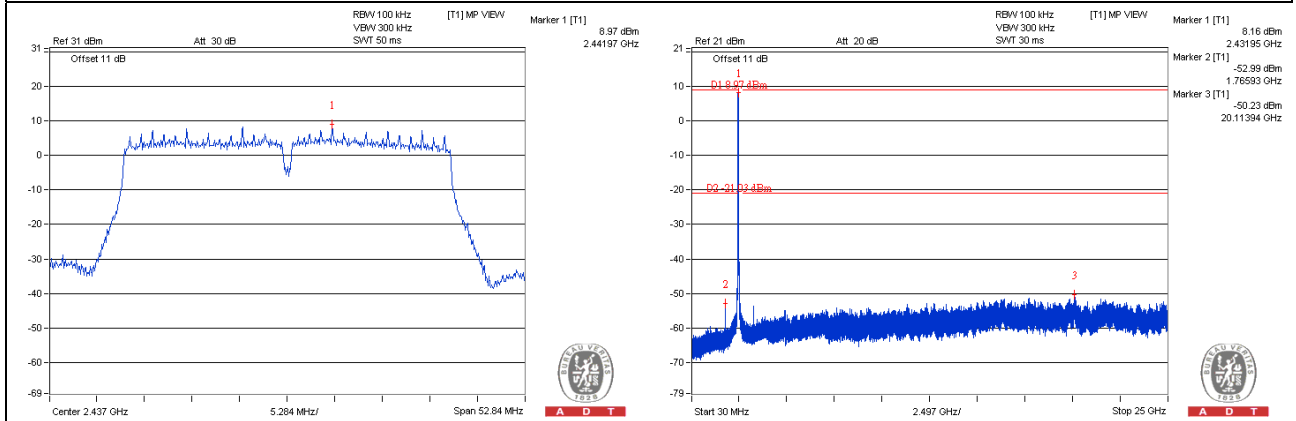

CH 9

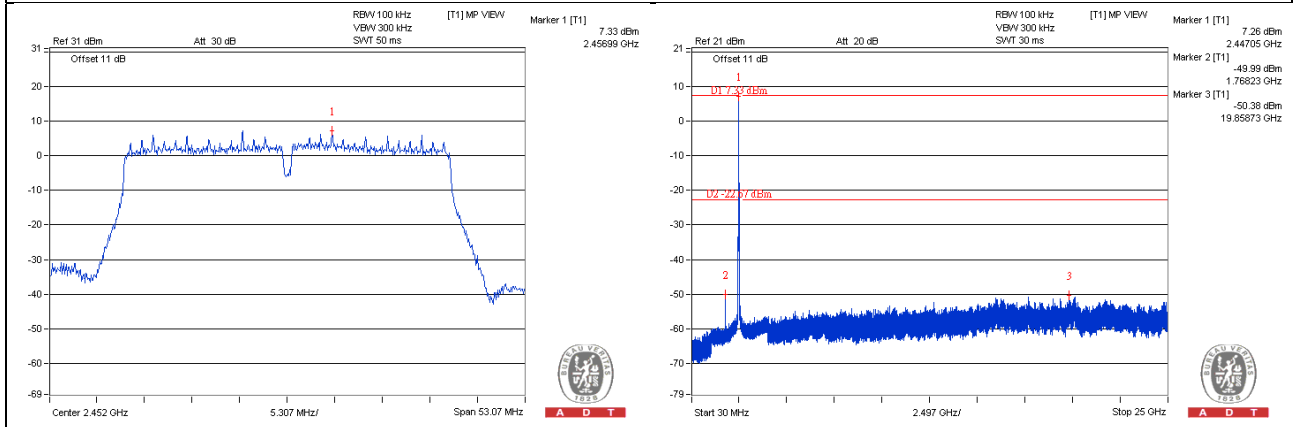

Beamforming_NSS1 Mode
802.11n (20MHz)_Chain 0

CH 1

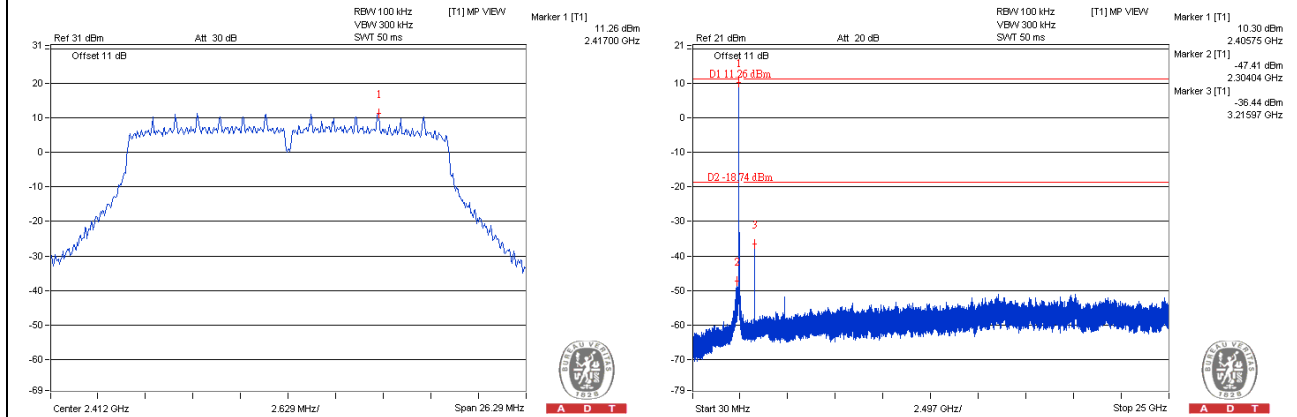

CH 6

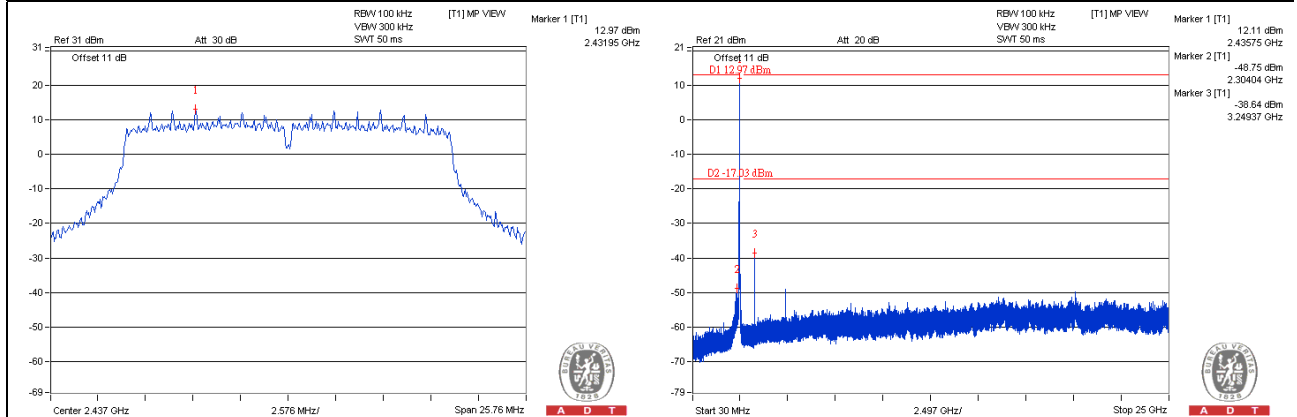

CH 11

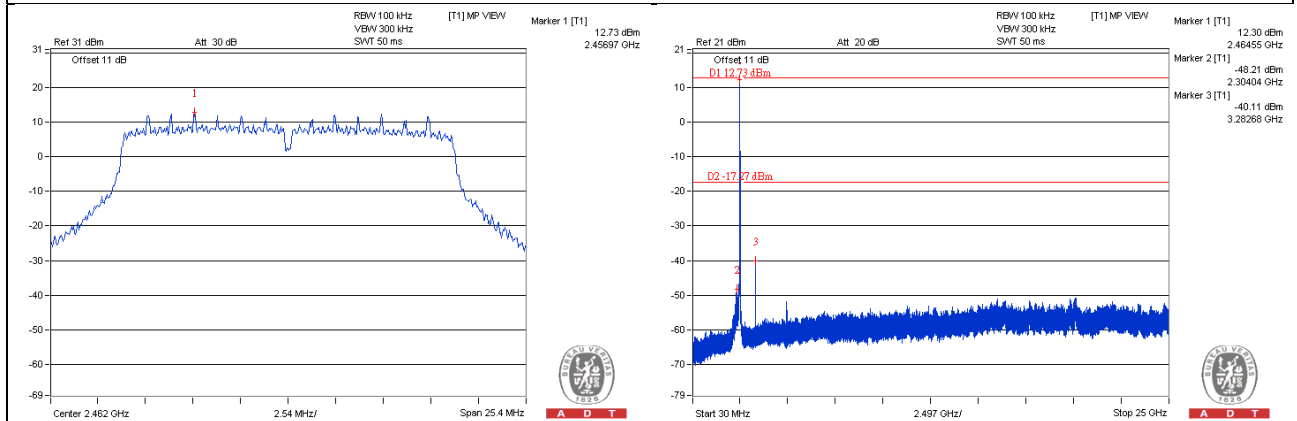

802.11n (20MHz)_Chain 1

CH 1

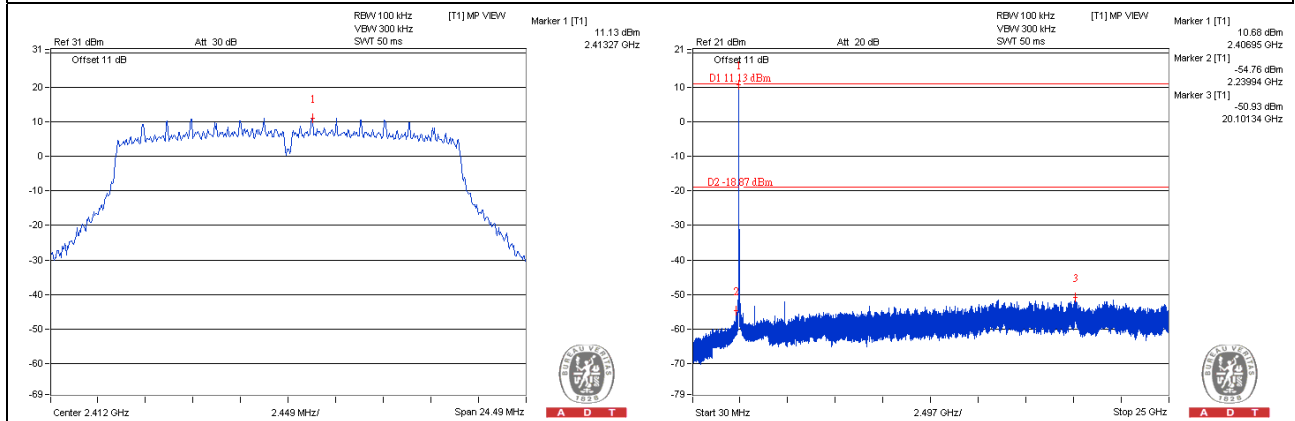

CH 6

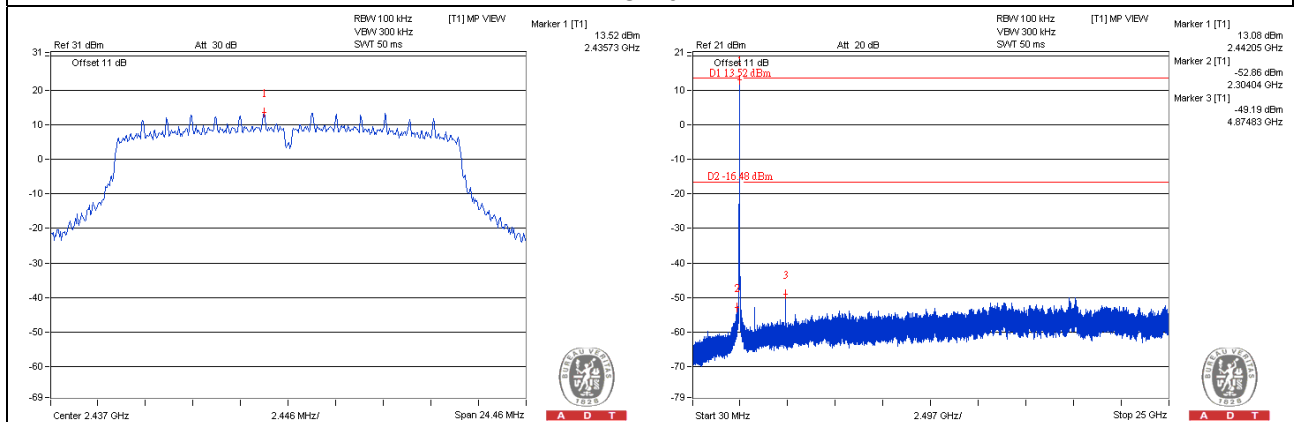

CH 11

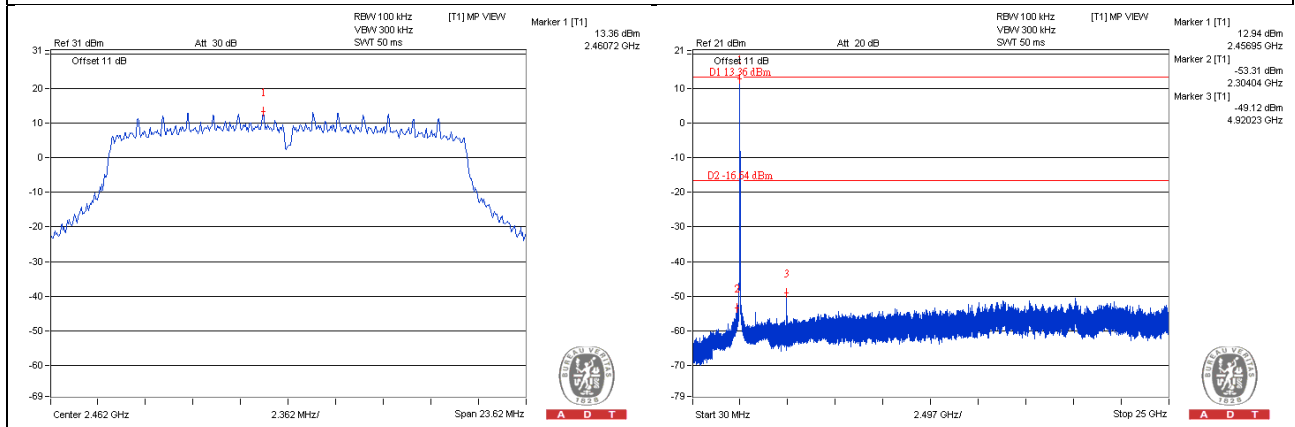

802.11n (20MHz)_Chain 2

CH 1

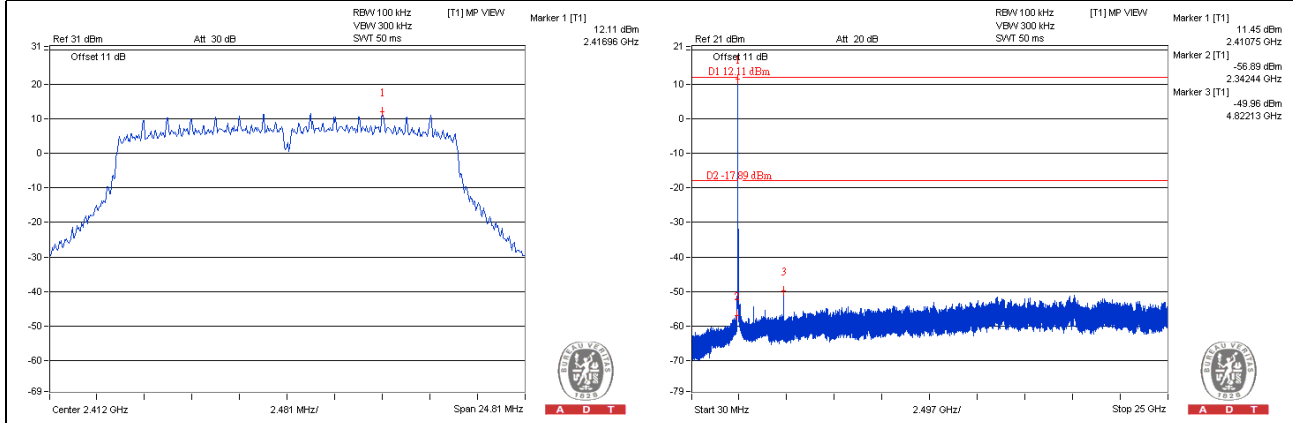

CH 6

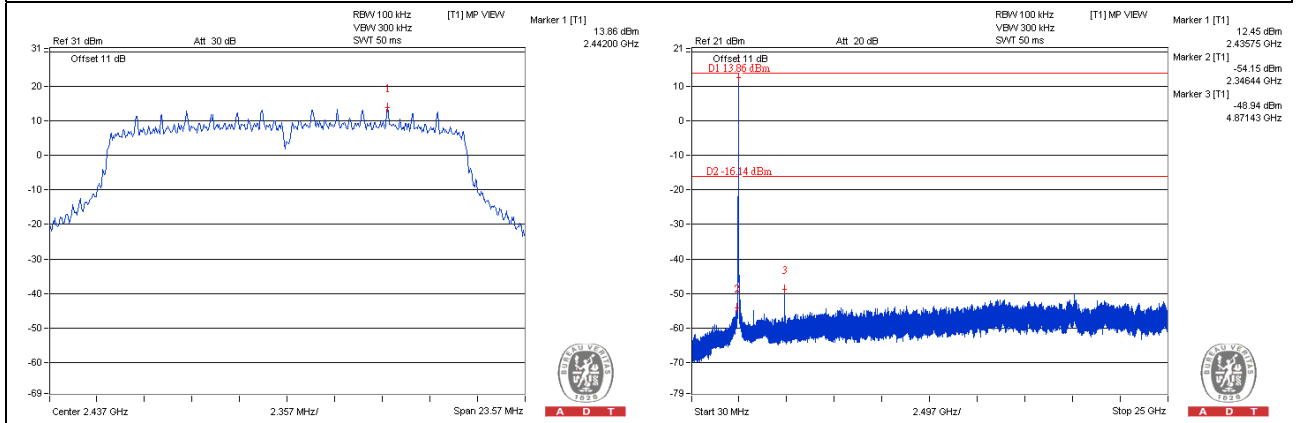

CH 11

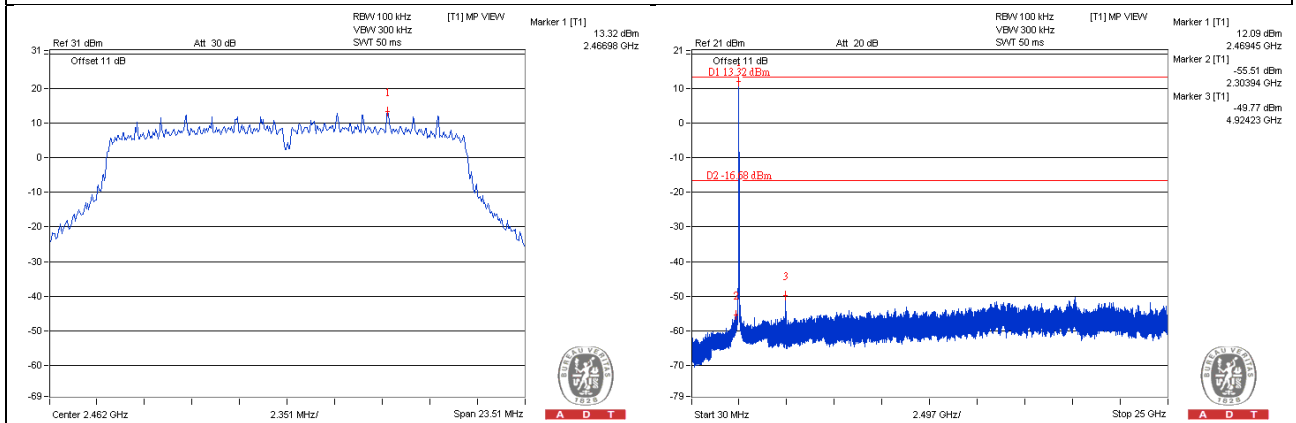

802.11n (20MHz)_Chain 3

CH 1

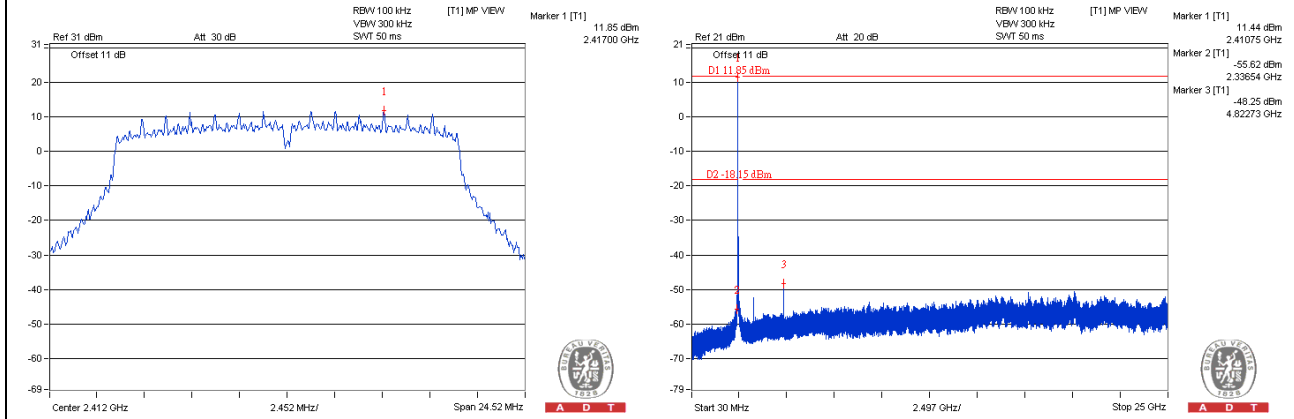

CH 6

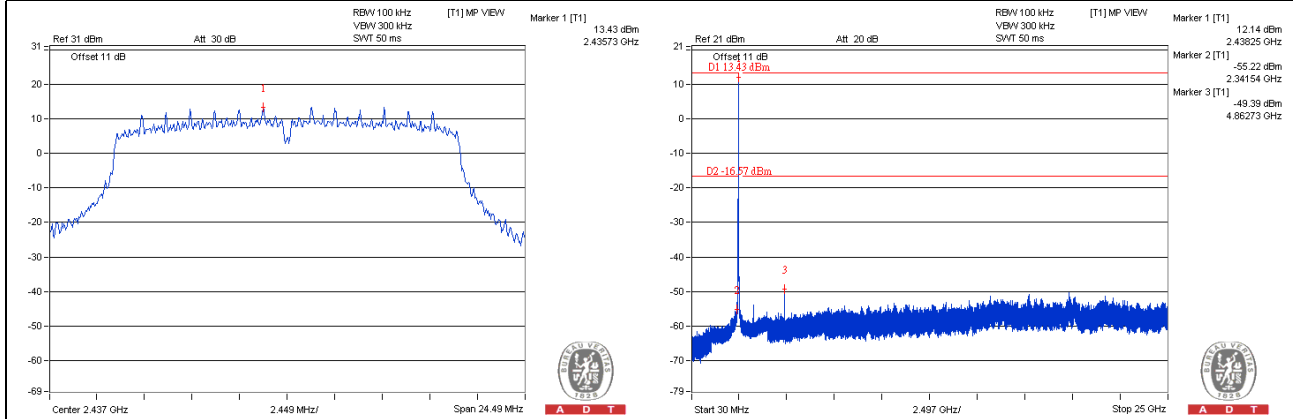

CH 11

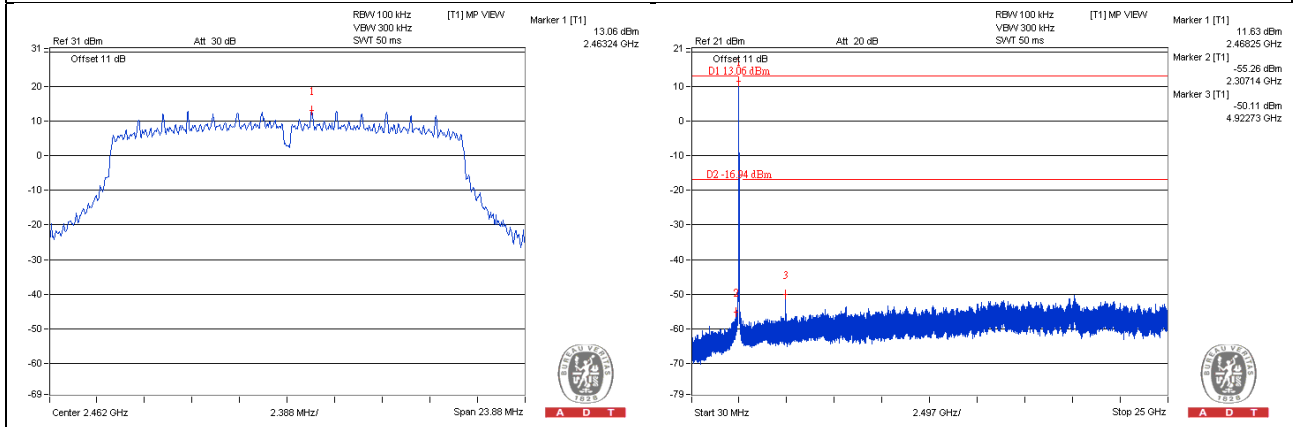

802.11n (40MHz)_Chain 0

CH 3

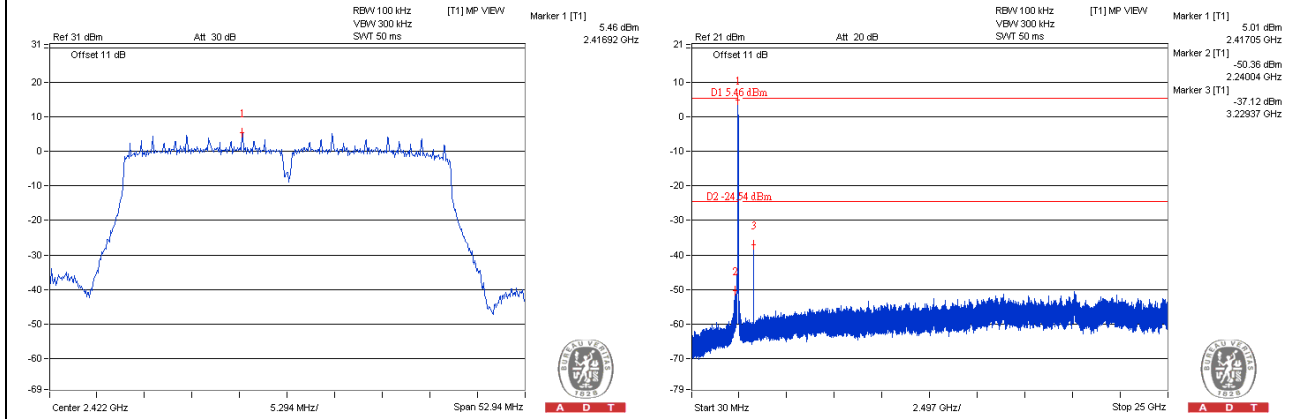

CH 6

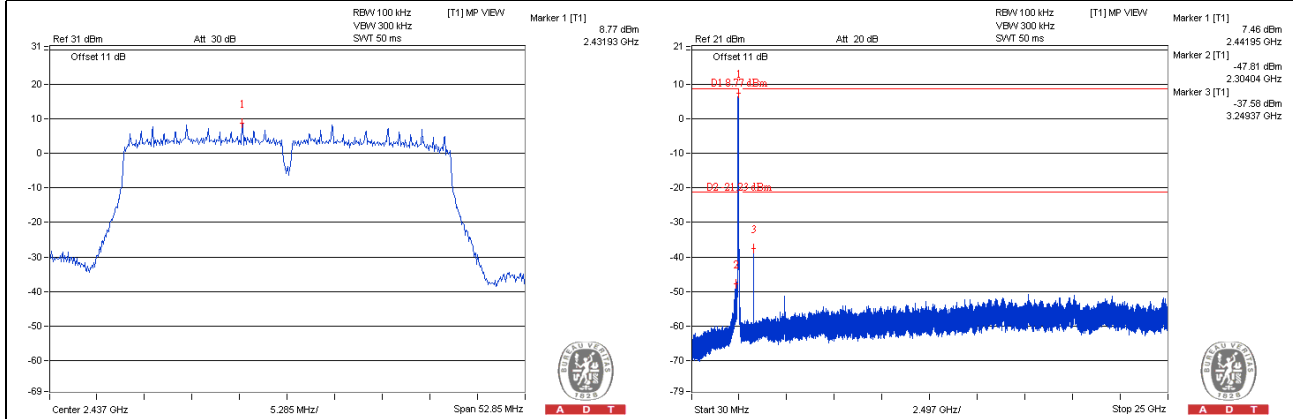

CH 9

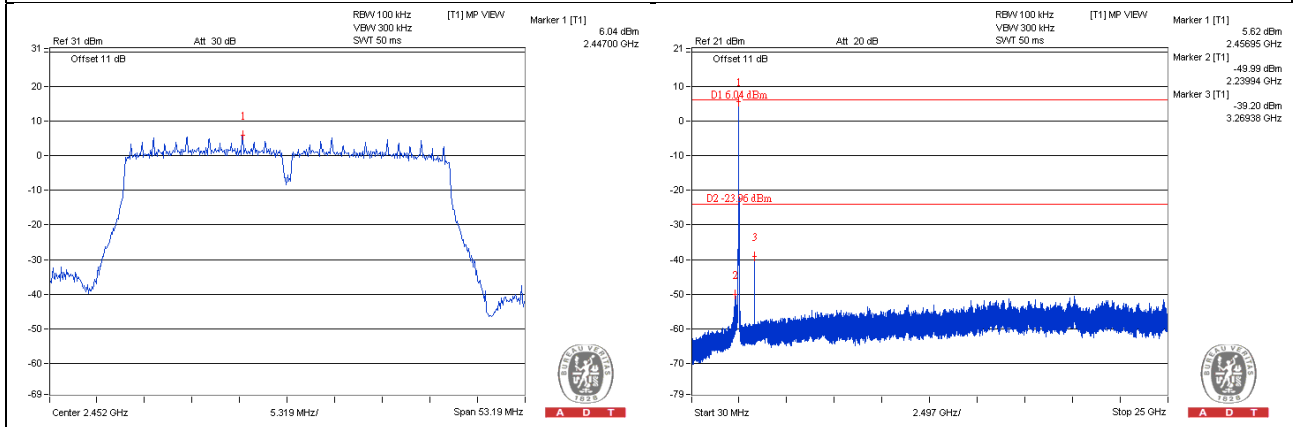

802.11n (40MHz)_Chain 1

CH 3

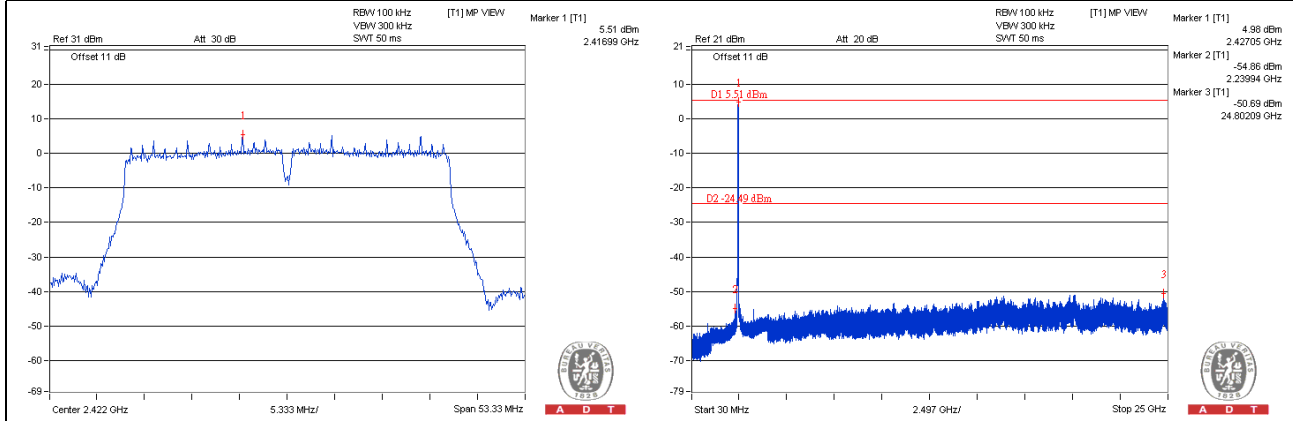

CH 6

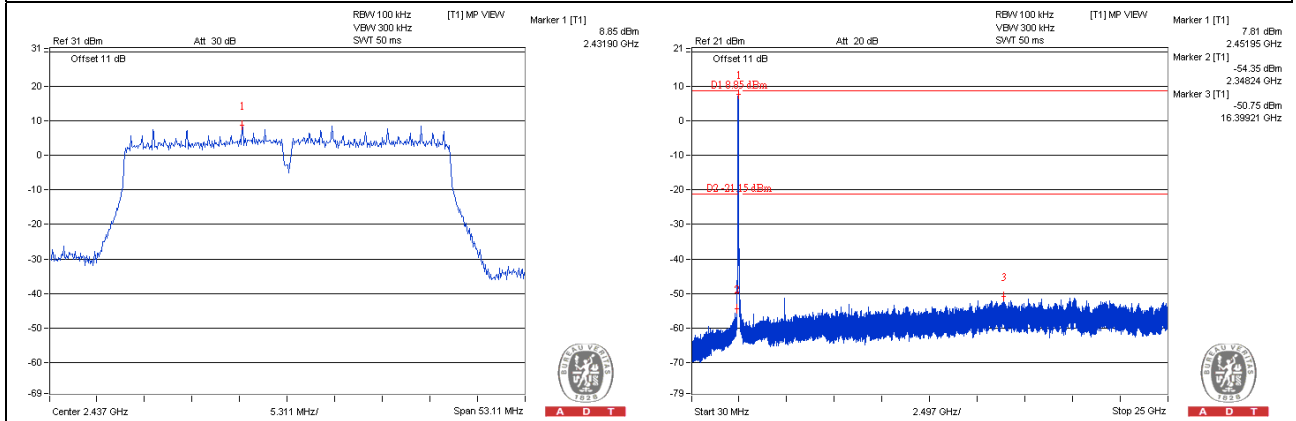

CH 9

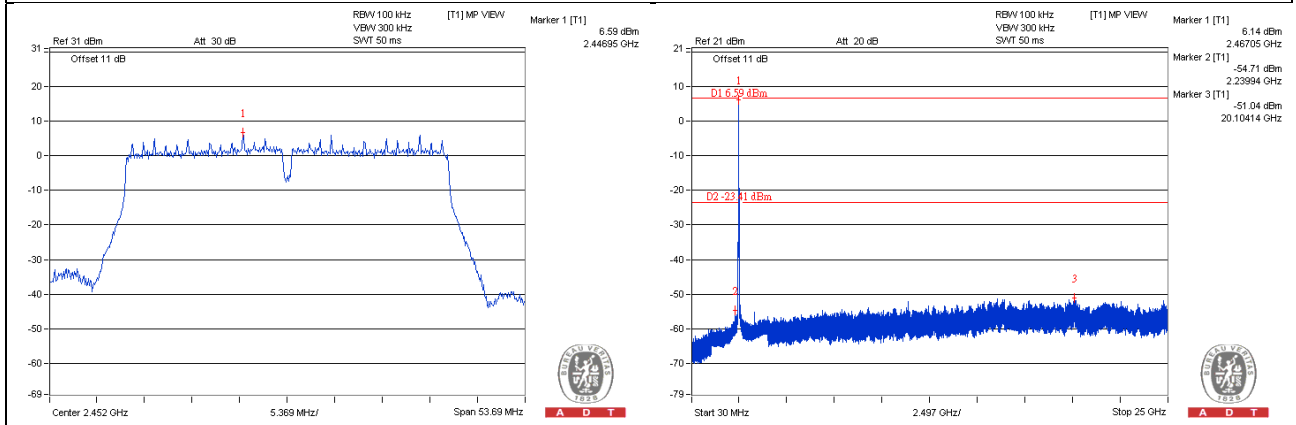

802.11n (40MHz)_Chain 2

CH 3

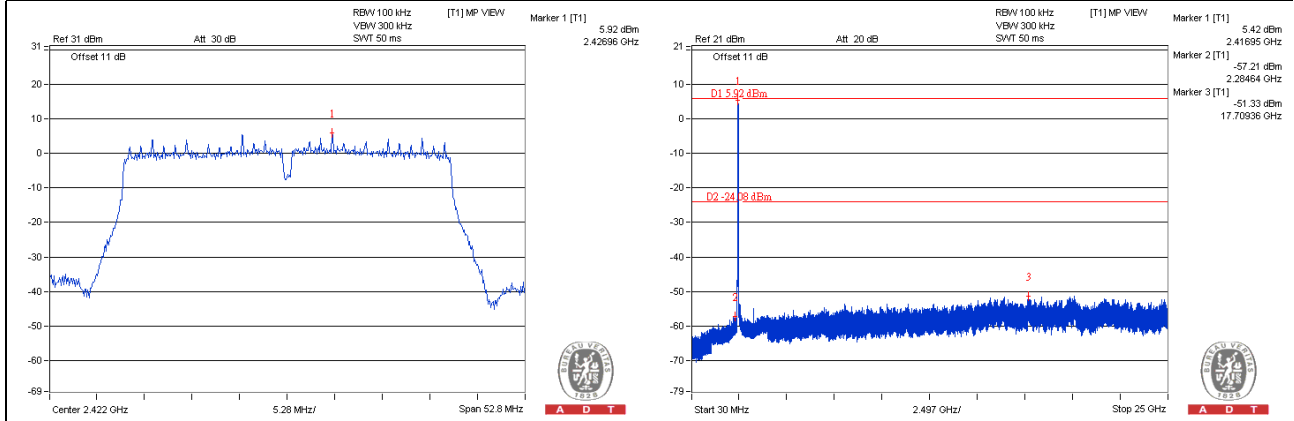

CH 6

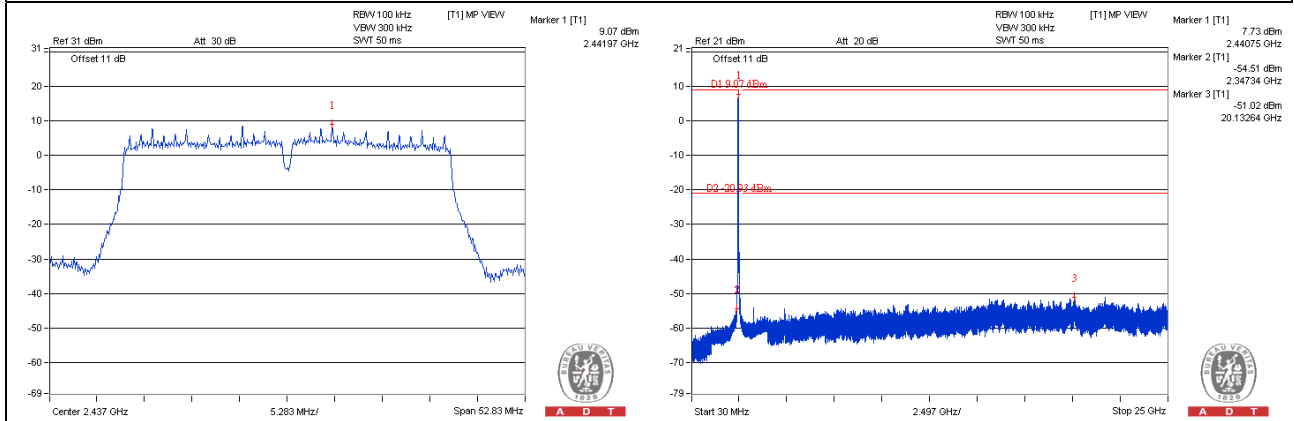

CH 9

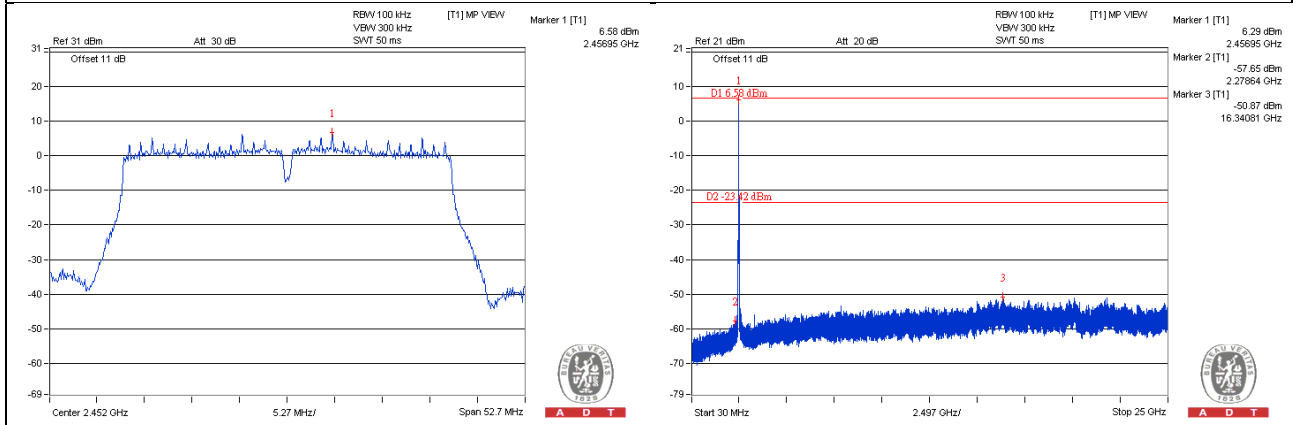



A D T

802.11n (40MHz)_Chain 3

CH 3

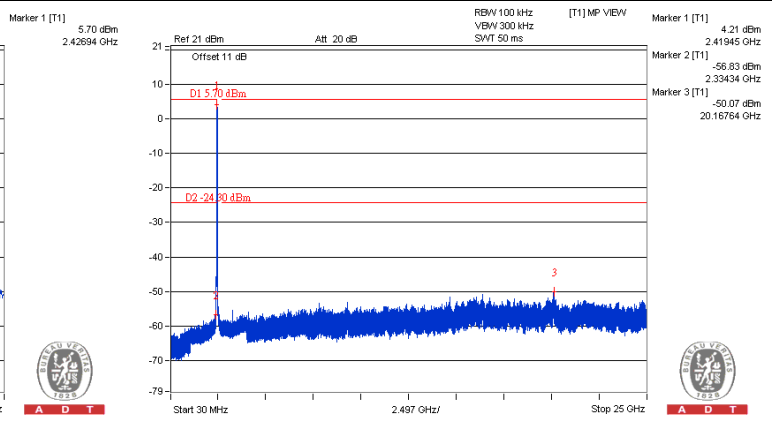
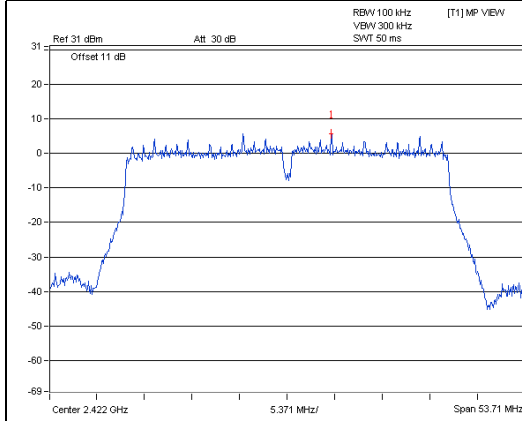

CH 6

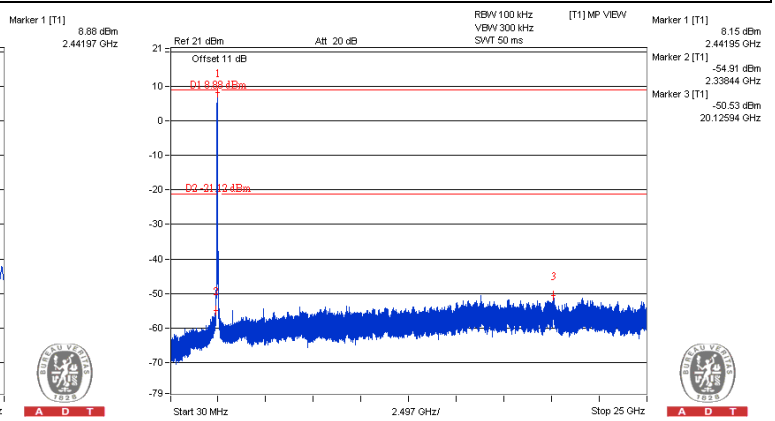
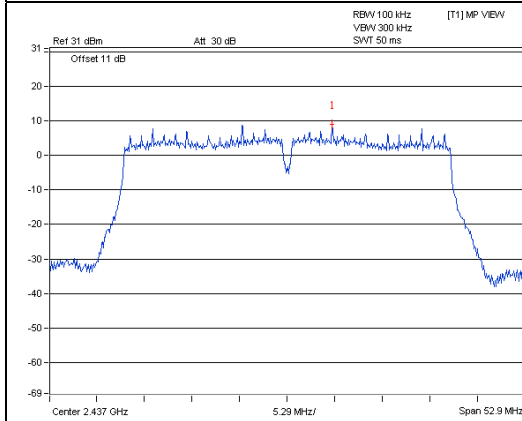

CH 9

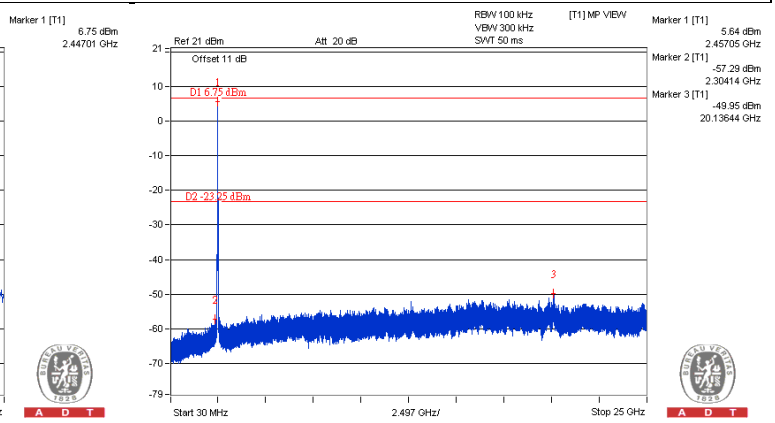
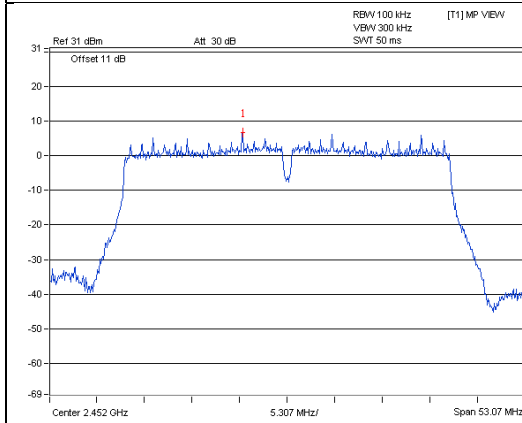

Beamforming_NSS2 Mode 802.11n (20MHz)_Chain 0

CH 1

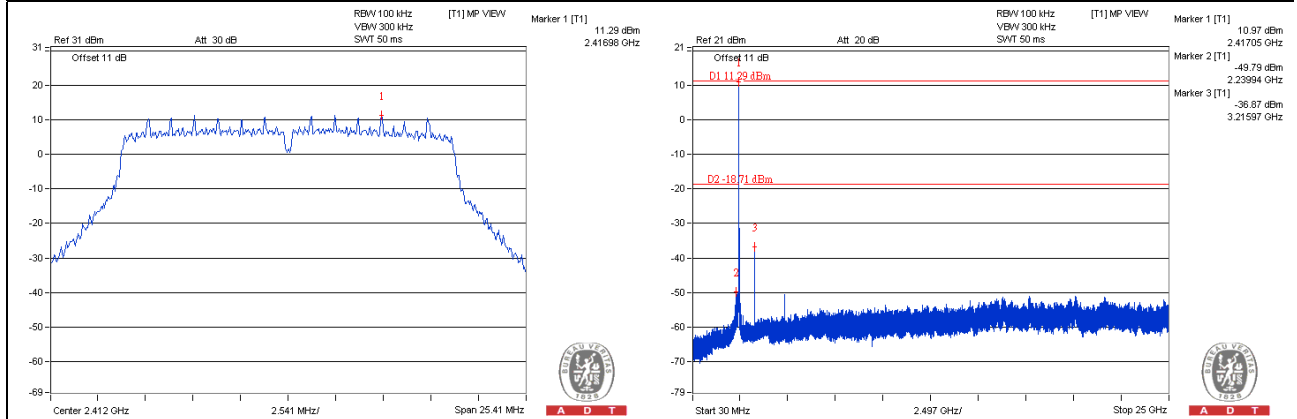

CH 6

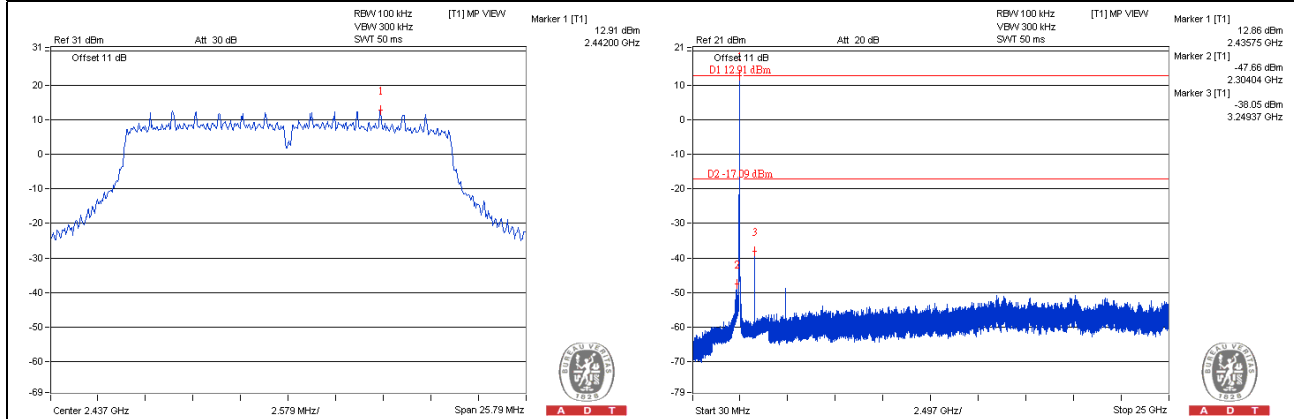

CH 11

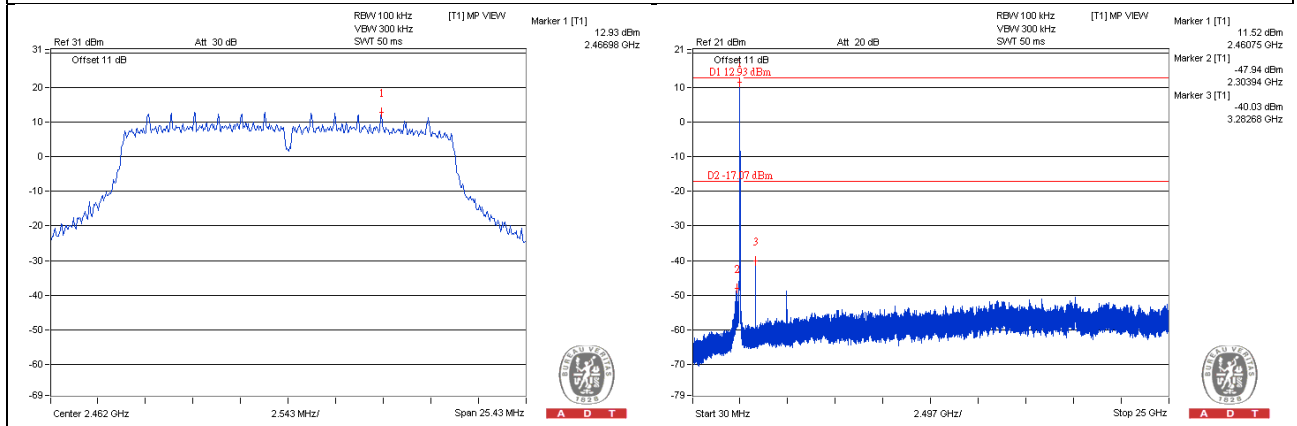

802.11n (20MHz)_Chain 1

CH 1

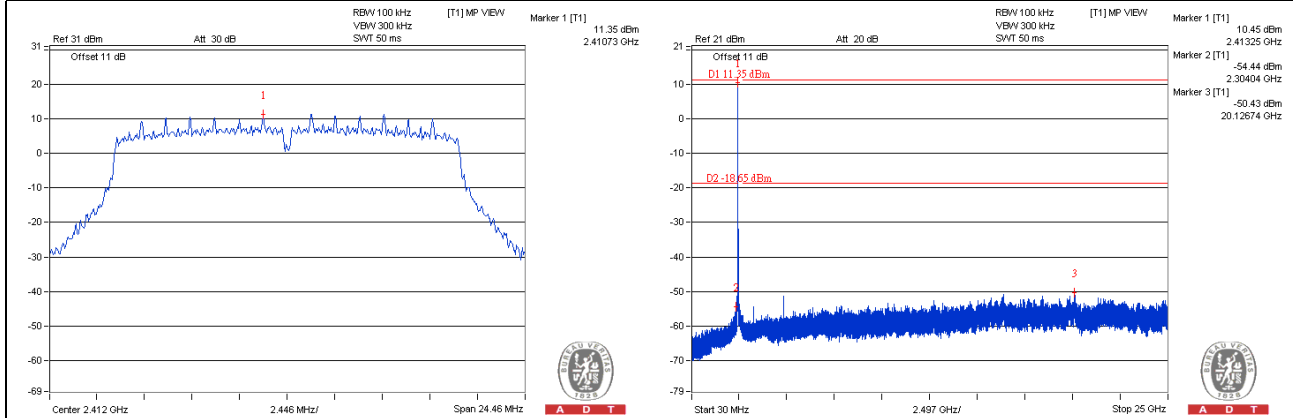

CH 6

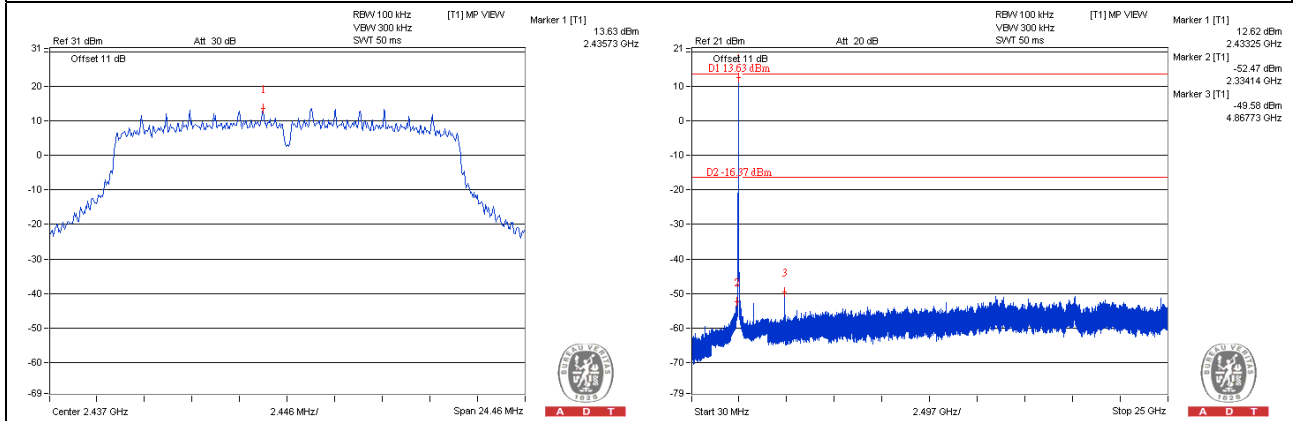

CH 11

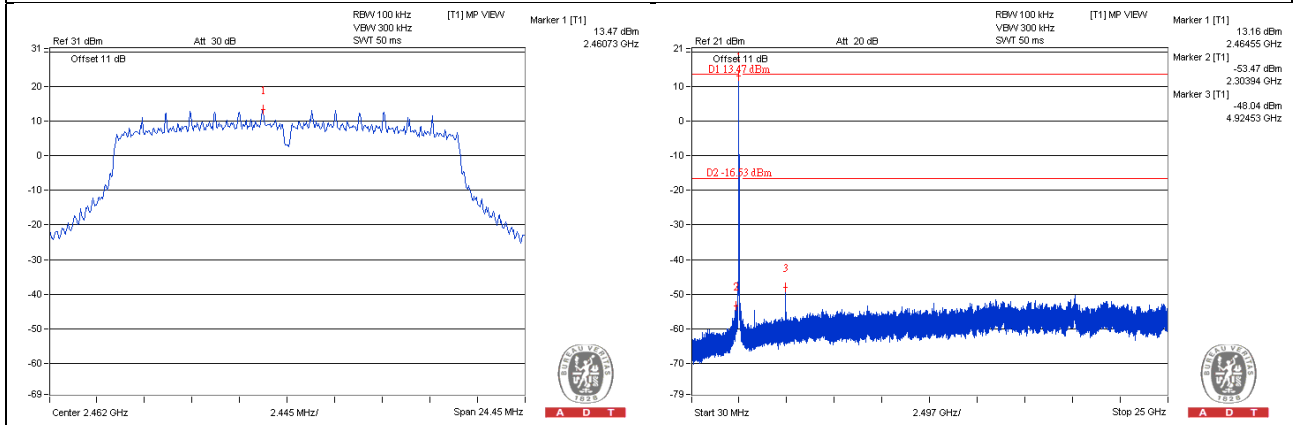

802.11n (20MHz)_Chain 2

CH 1

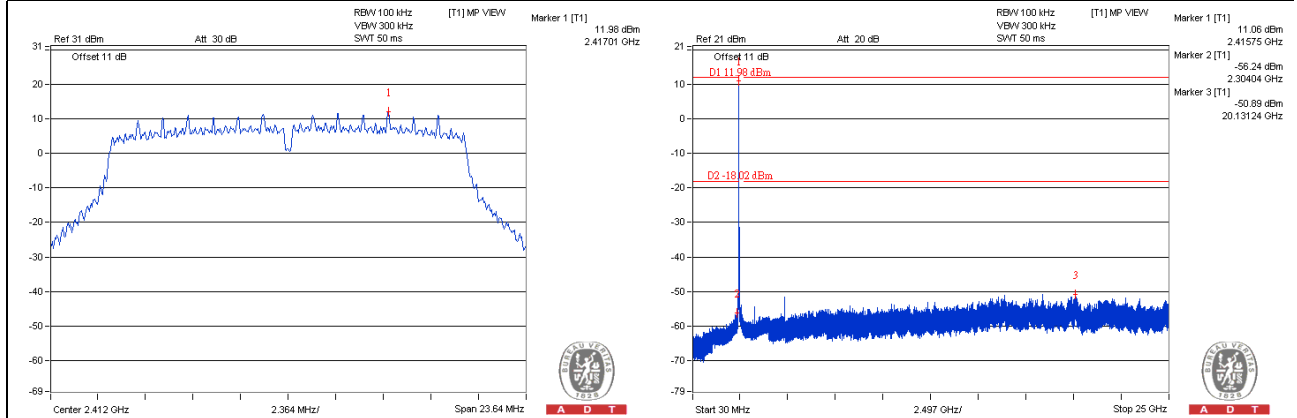

CH 6

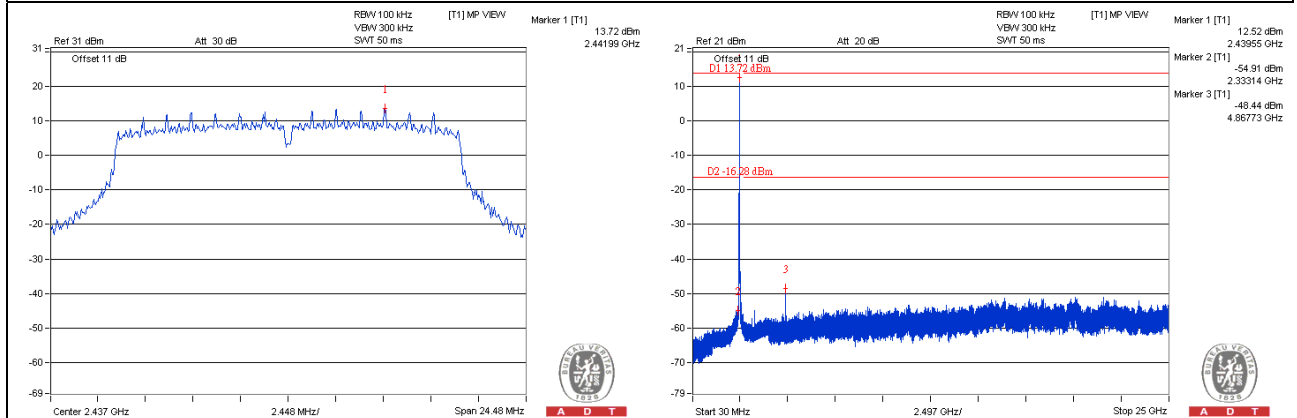

CH 11

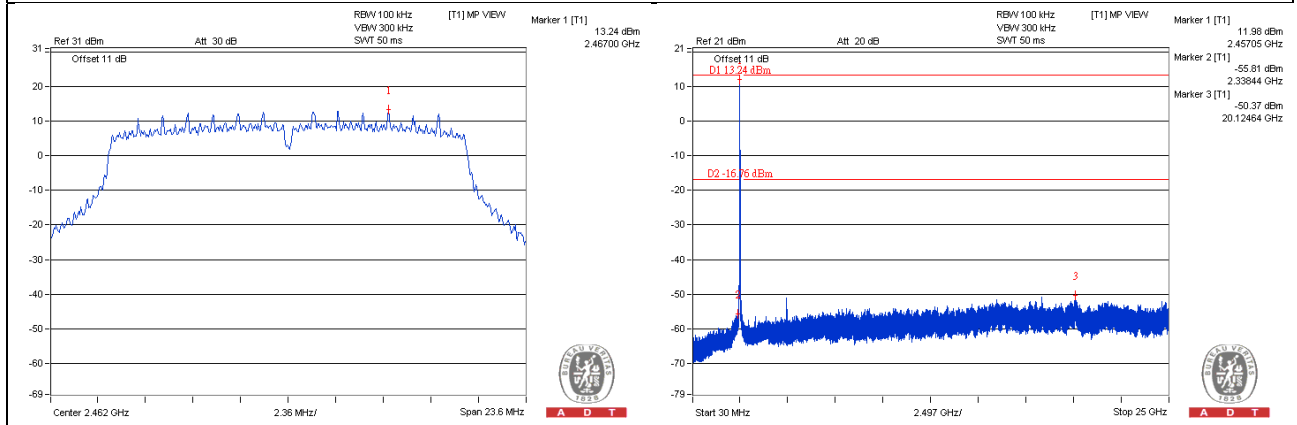

802.11n (20MHz)_Chain 3

CH 1

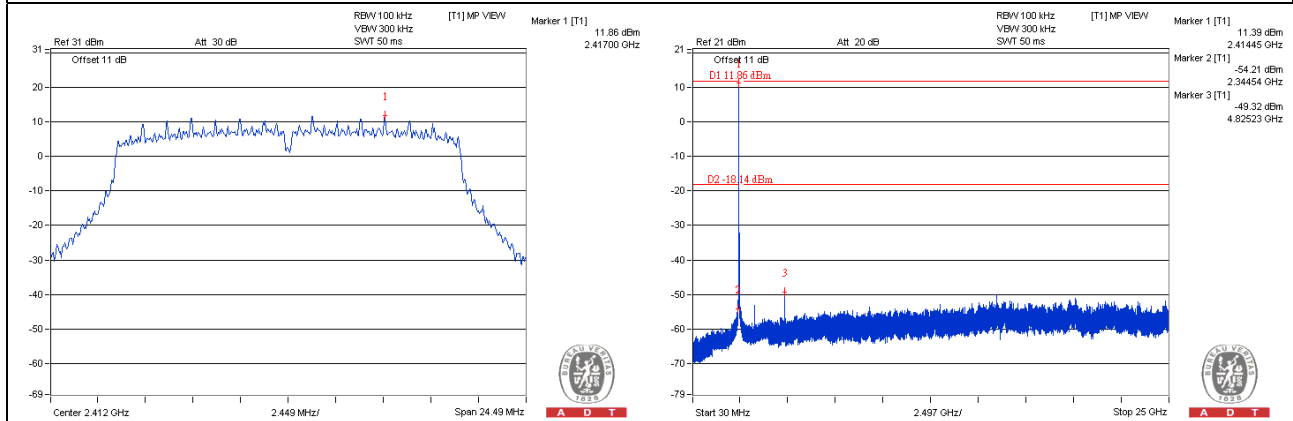

CH 6

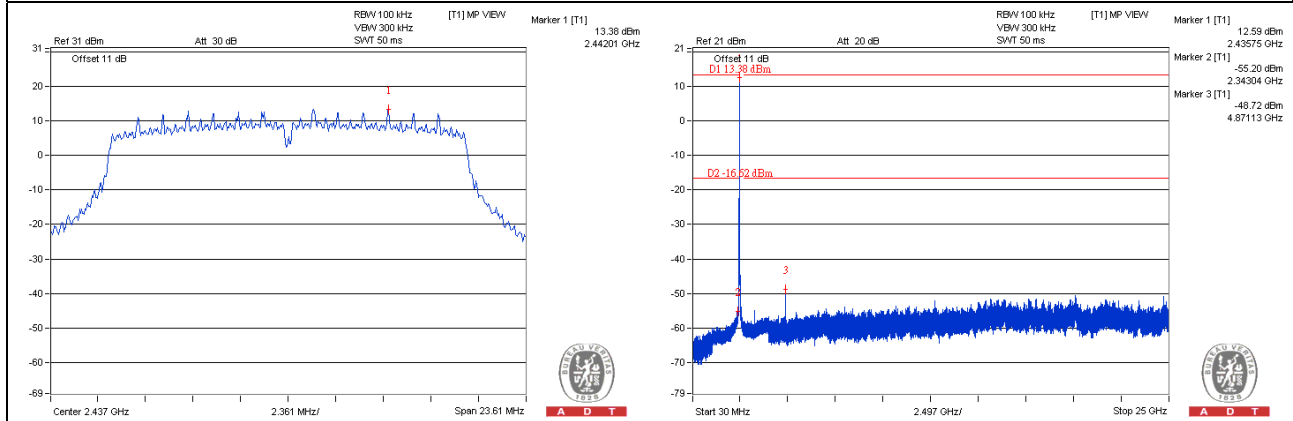

CH 11

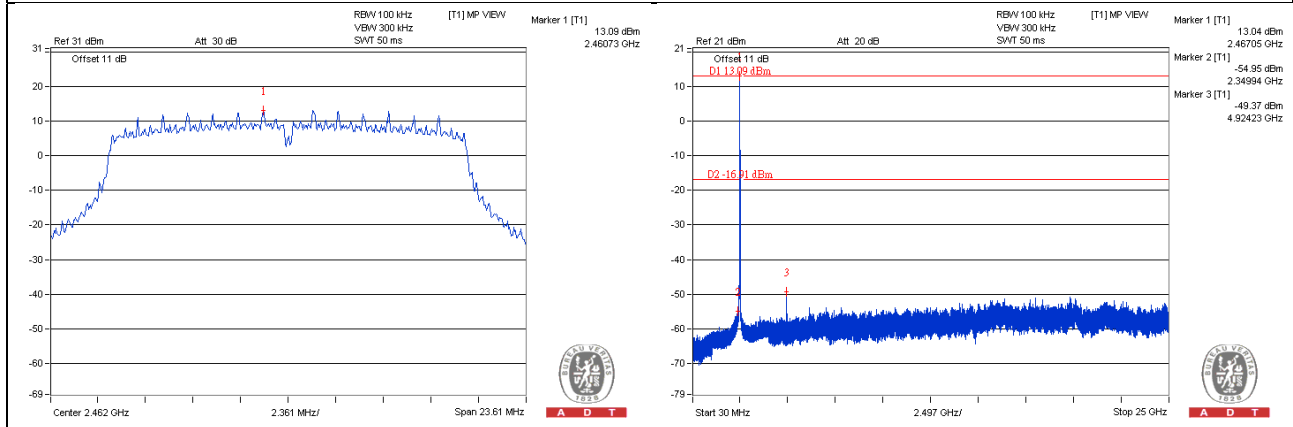

802.11n (40MHz)_Chain 0

CH 3

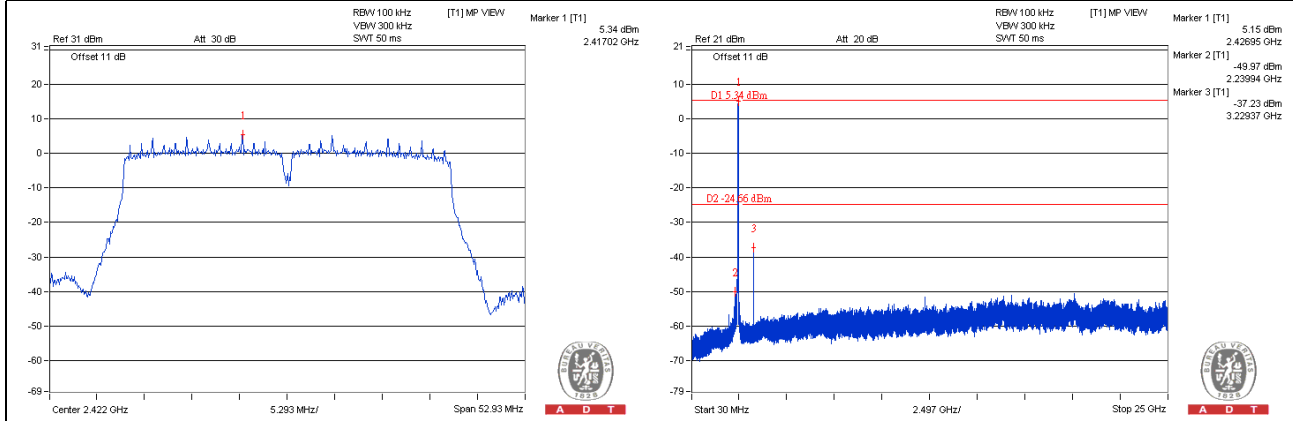

CH 6

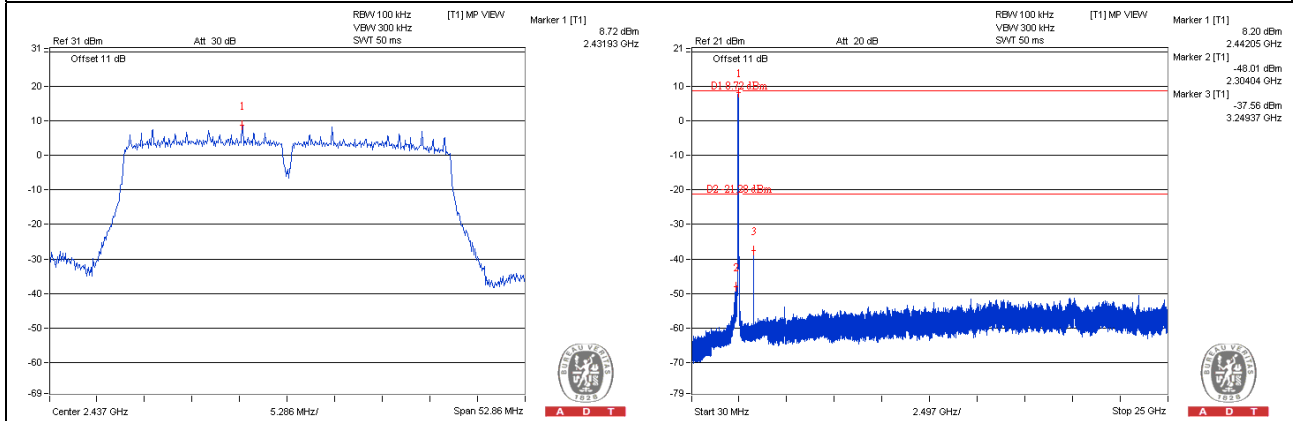

CH 9

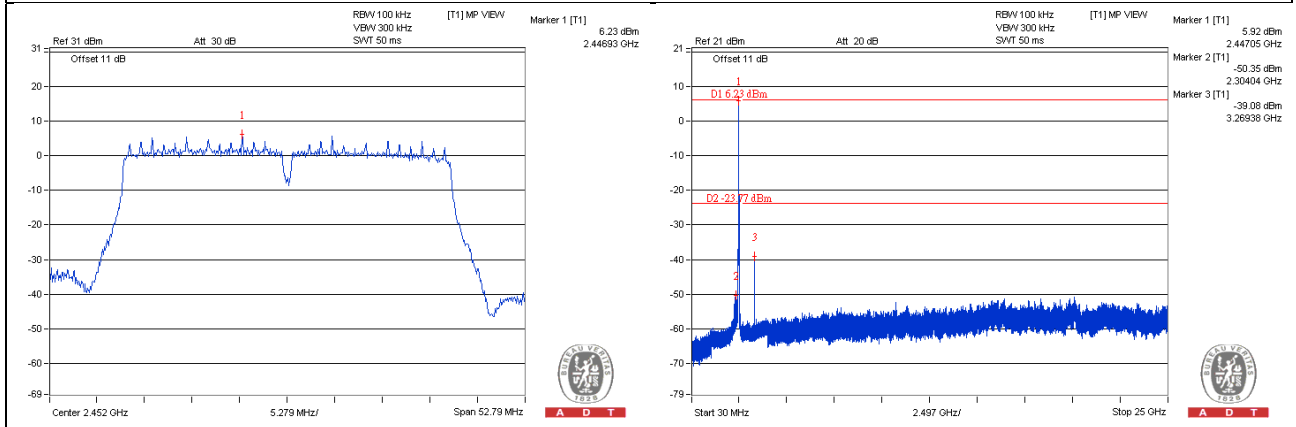

802.11n (40MHz)_Chain 1

CH 3

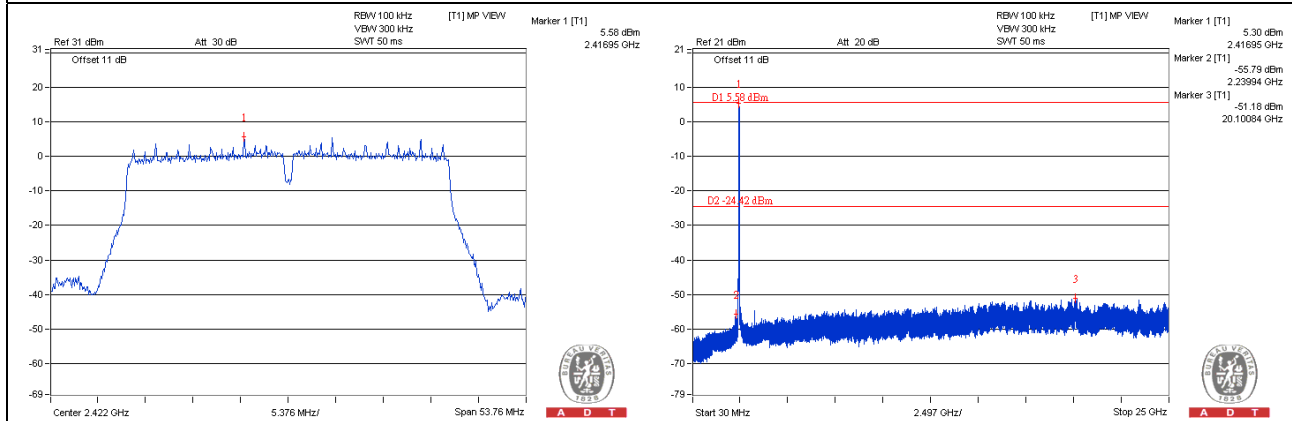

CH 6

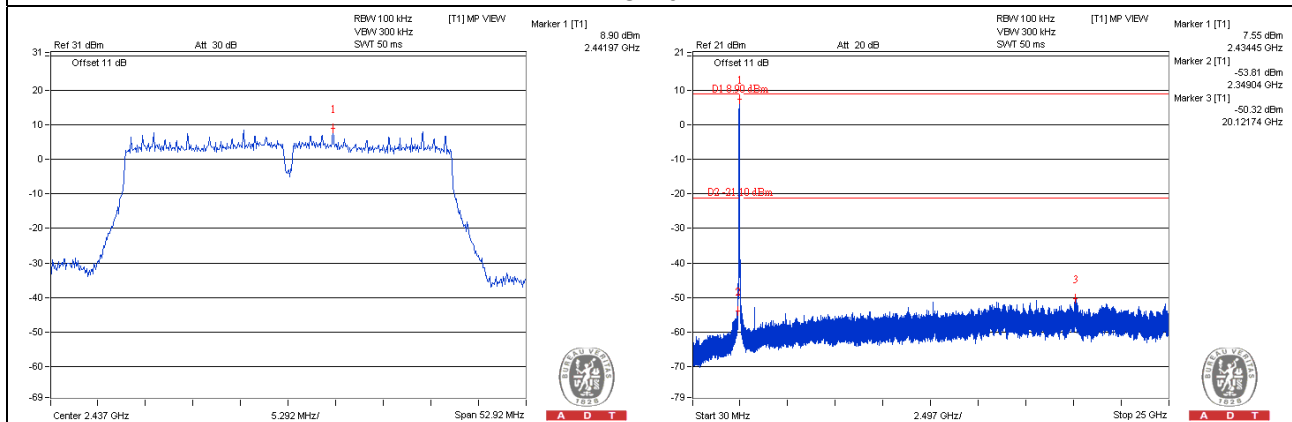

CH 9

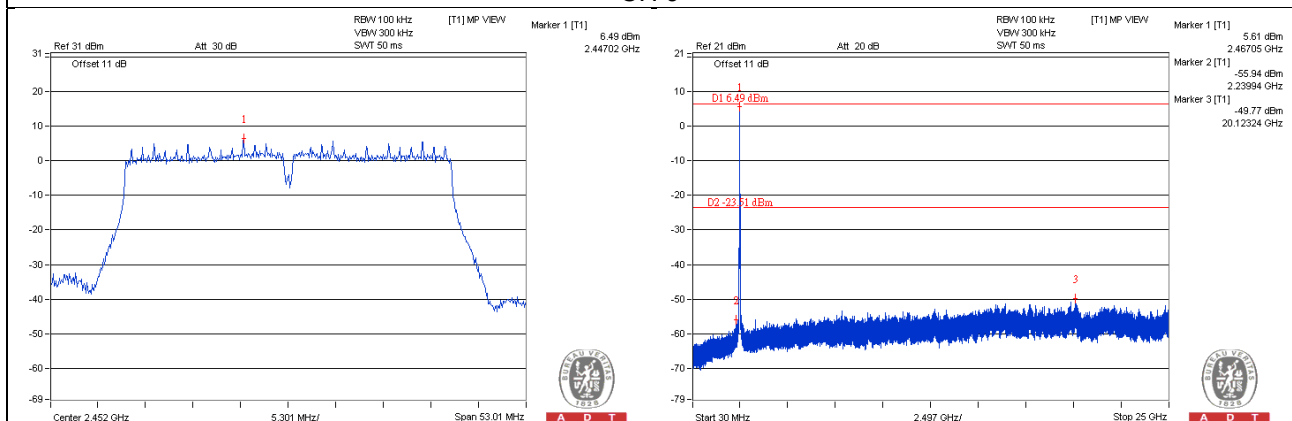

802.11n (40MHz)_Chain 2

CH 3

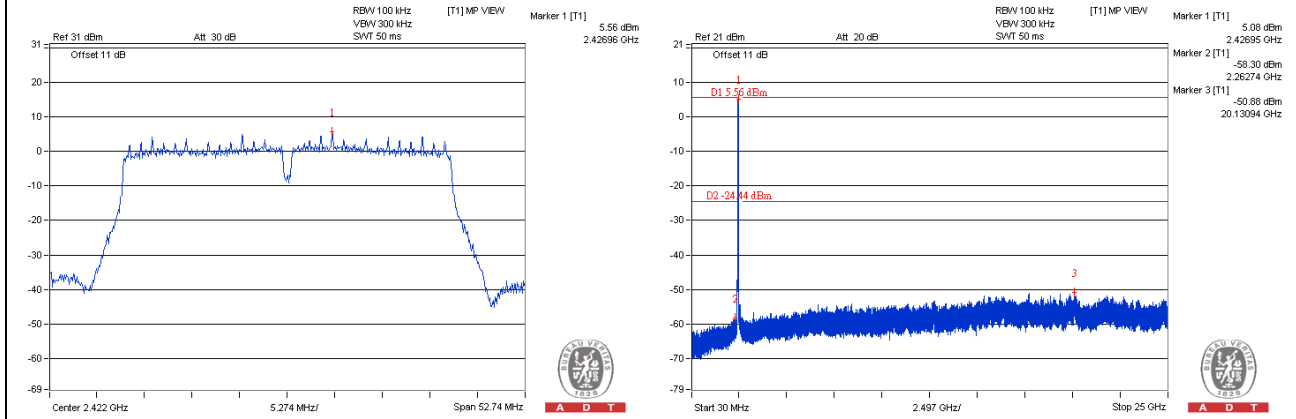

CH 6

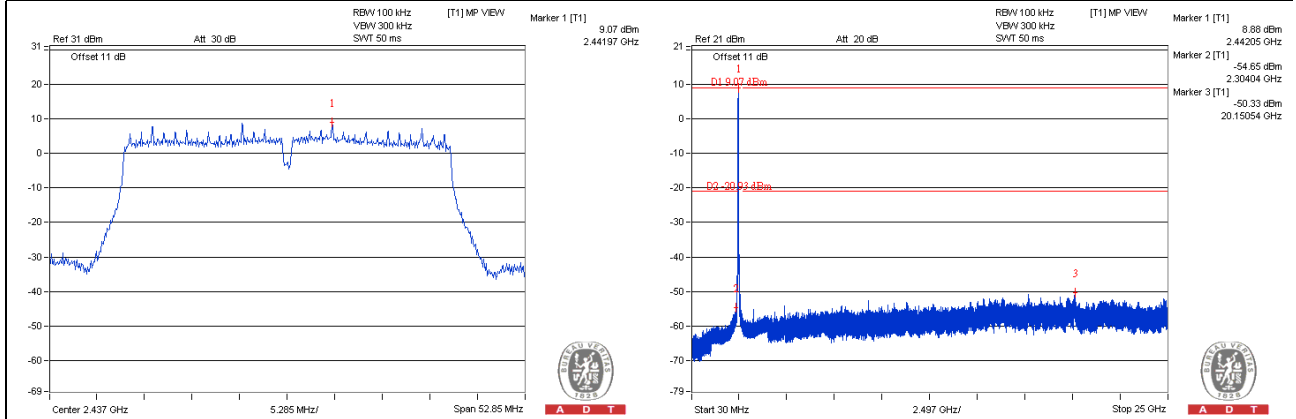

CH 9

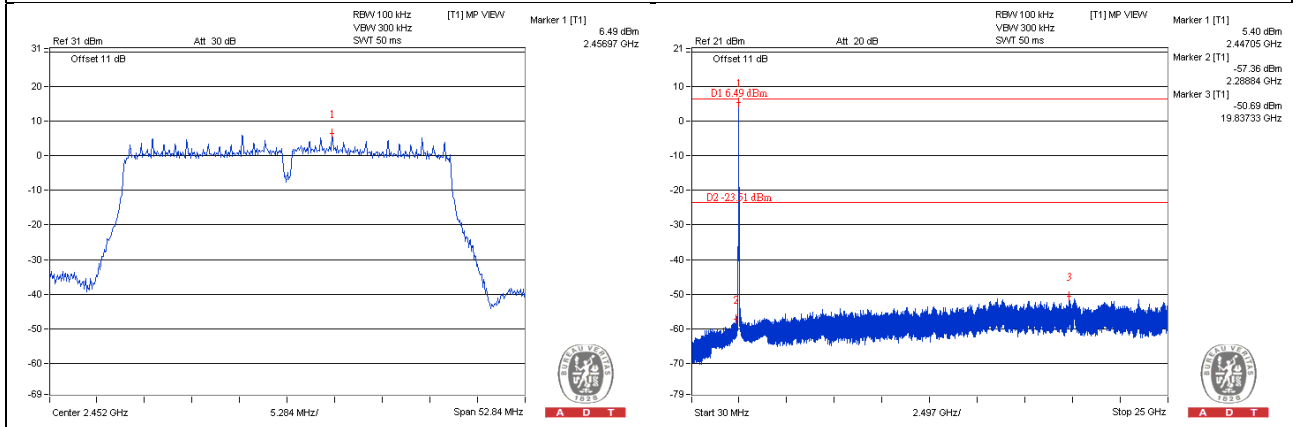

802.11n (40MHz)_Chain 3

CH 3

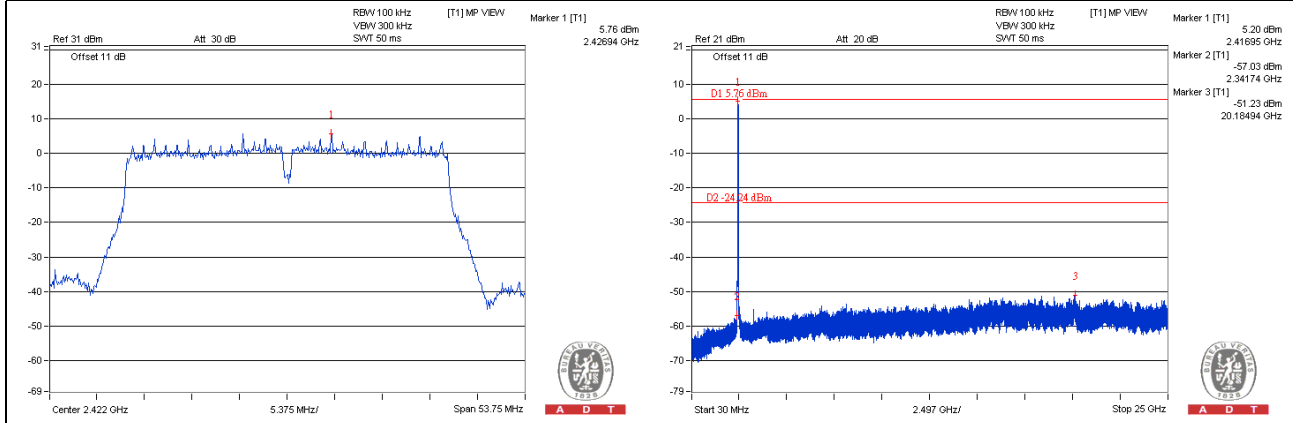

CH 6

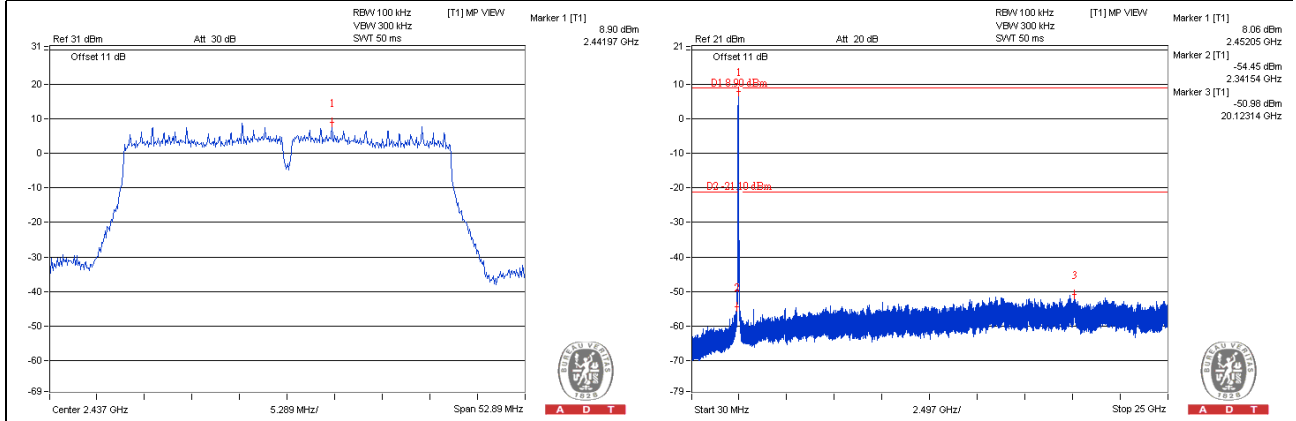

CH 9

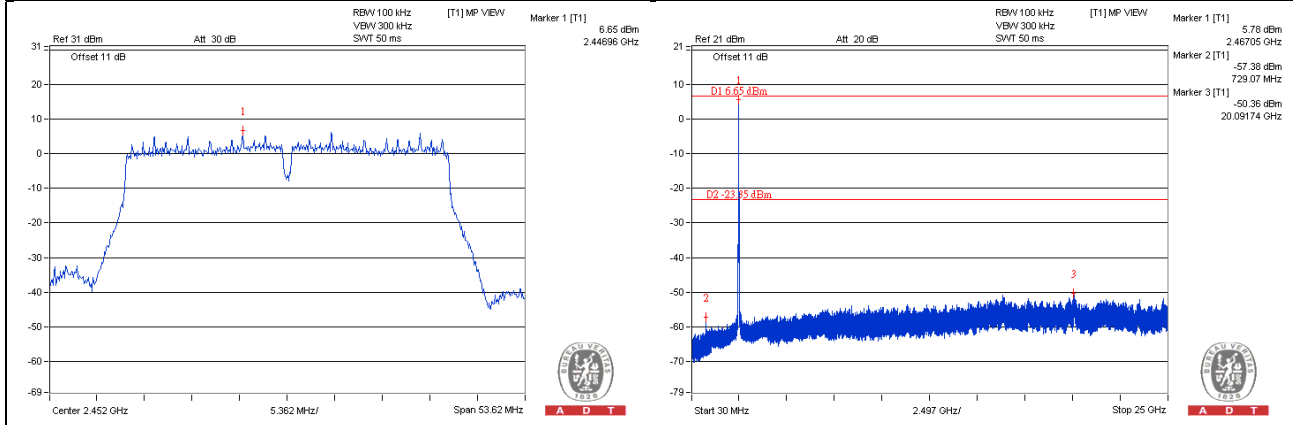

5 Test Types and Results (For 5.0GHz Band)

5.1 Radiated Emission and Bandedge Measurement

5.1.1 Limits of Radiated Emission and Bandedge Measurement

Radiated emissions which fall in the restricted bands must comply with the radiated emission limits specified as below table. Other emissions shall be at least 30dB below the highest level of the desired power:

Frequencies (MHz)	Field Strength (microvolts/meter)	Measurement Distance (meters)
0.009 ~ 0.490	2400/F(kHz)	300
0.490 ~ 1.705	24000/F(kHz)	30
1.705 ~ 30.0	30	30
30 ~ 88	100	3
88 ~ 216	150	3
216 ~ 960	200	3
Above 960	500	3

Note:

1. The lower limit shall apply at the transition frequencies.
2. Emission level (dBuV/m) = 20 log Emission level (uV/m).
3. For frequencies above 1000MHz, the field strength limits are based on average detector, however, the peak field strength of any emission shall not exceed the maximum permitted average limits, specified above by more than 30dB under any condition of modulation.

5.1.2 Test Instruments

Same as item 4.1.2.

5.1.3 Test Procedures

Same as item 4.1.3.

5.1.4 Deviation from Test Standard

No deviation.

5.1.5 Test Setup

Same as item 4.1.5.

5.1.6 EUT Operating Conditions

Same as item 4.1.6.

5.1.7 Test Results

Above 1GHz Data:

802.11a

CHANNEL	TX Channel 149	DETECTOR FUNCTION	Peak (PK)
FREQUENCY RANGE	1GHz ~ 40GHz		Average (AV)

ANTENNA POLARITY & TEST DISTANCE: HORIZONTAL AT 3 M								
NO.	FREQ. (MHz)	EMISSION LEVEL (dBuV/m)	LIMIT (dBuV/m)	MARGIN (dB)	ANTENNA HEIGHT (m)	TABLE ANGLE (Degree)	RAW VALUE (dBuV)	CORRECTION FACTOR (dB/m)
1	#5725.00	70.9 PK	79.1	-8.2	1.00 H	130	64.80	6.10
2	#5725.00	61.1 AV	69.3	-8.2	1.00 H	130	55.00	6.10
3	*5745.00	109.1 PK			1.00 H	130	68.80	40.30
4	*5745.00	99.3 AV			1.00 H	130	59.00	40.30
5	11490.00	57.5 PK	74.0	-16.5	1.06 H	31	39.90	17.60
6	11490.00	46.6 AV	54.0	-7.4	1.06 H	31	29.00	17.60
ANTENNA POLARITY & TEST DISTANCE: VERTICAL AT 3 M								
NO.	FREQ. (MHz)	EMISSION LEVEL (dBuV/m)	LIMIT (dBuV/m)	MARGIN (dB)	ANTENNA HEIGHT (m)	TABLE ANGLE (Degree)	RAW VALUE (dBuV)	CORRECTION FACTOR (dB/m)
1	#5725.00	88.4 PK	96.6	-8.2	1.84 V	173	82.30	6.10
2	#5725.00	77.5 AV	85.7	-8.2	1.84 V	173	71.40	6.10
3	*5745.00	126.6 PK			1.84 V	173	86.30	40.30
4	*5745.00	115.7 AV			1.84 V	173	75.40	40.30
5	11490.00	59.9 PK	74.0	-14.1	1.00 V	336	42.30	17.60
6	11490.00	47.9 AV	54.0	-6.1	1.00 V	336	30.30	17.60

REMARKS:

1. Emission Level(dBuV/m) = Raw Value(dBuV) + Correction Factor(dB/m)
2. Correction Factor(dB/m) = Antenna Factor(dB/m) + Cable Factor(dB)
– Pre-Amplifier Factor(dB)
3. The other emission levels were very low against the limit.
4. Margin value = Emission Level – Limit value
5. " * ": Fundamental frequency.
6. " # ": The radiated frequency is out of the restricted band.
7. The limit value is defined as per 15.247.

CHANNEL	TX Channel 157	DETECTOR FUNCTION	Peak (PK)
FREQUENCY RANGE	1GHz ~ 40GHz		Average (AV)

ANTENNA POLARITY & TEST DISTANCE: HORIZONTAL AT 3 M

NO.	FREQ. (MHz)	EMISSION LEVEL (dBuV/m)	LIMIT (dBuV/m)	MARGIN (dB)	ANTENNA HEIGHT (m)	TABLE ANGLE (Degree)	RAW VALUE (dBuV)	CORRECTION FACTOR (dB/m)
1	*5785.00	110.2 PK			1.11 H	132	69.90	40.30
2	*5785.00	99.5 AV			1.11 H	132	59.20	40.30
3	11570.00	56.3 PK	74.0	-17.7	1.26 H	74	38.80	17.50
4	11570.00	45.9 AV	54.0	-8.1	1.26 H	74	28.40	17.50

ANTENNA POLARITY & TEST DISTANCE: VERTICAL AT 3 M

NO.	FREQ. (MHz)	EMISSION LEVEL (dBuV/m)	LIMIT (dBuV/m)	MARGIN (dB)	ANTENNA HEIGHT (m)	TABLE ANGLE (Degree)	RAW VALUE (dBuV)	CORRECTION FACTOR (dB/m)
1	*5785.00	127.6 PK			1.96 V	174	87.30	40.30
2	*5785.00	116.7 AV			1.96 V	174	76.40	40.30
3	11570.00	60.3 PK	74.0	-13.7	1.00 V	348	42.80	17.50
4	11570.00	48.0 AV	54.0	-6.0	1.00 V	348	30.50	17.50

REMARKS:

1. Emission Level(dBuV/m) = Raw Value(dBuV) + Correction Factor(dB/m)
2. Correction Factor(dB/m) = Antenna Factor(dB/m) + Cable Factor(dB)
– Pre-Amplifier Factor(dB)
3. The other emission levels were very low against the limit.
4. Margin value = Emission Level – Limit value
5. " * ": Fundamental frequency.
6. The limit value is defined as per 15.247.

CHANNEL	TX Channel 165	DETECTOR FUNCTION	Peak (PK)
FREQUENCY RANGE	1GHz ~ 40GHz		Average (AV)

ANTENNA POLARITY & TEST DISTANCE: HORIZONTAL AT 3 M

NO.	FREQ. (MHz)	EMISSION LEVEL (dBuV/m)	LIMIT (dBuV/m)	MARGIN (dB)	ANTENNA HEIGHT (m)	TABLE ANGLE (Degree)	RAW VALUE (dBuV)	CORRECTION FACTOR (dB/m)
1	*5825.00	109.3 PK			1.01 H	144	68.90	40.40
2	*5825.00	98.8 AV			1.01 H	144	58.40	40.40
3	#5850.00	61.3 PK	79.3	-18.0	1.01 H	144	54.90	6.40
4	#5850.00	50.8 AV	68.8	-18.0	1.01 H	144	44.40	6.40
5	11650.00	56.3 PK	74.0	-17.7	1.13 H	64	39.00	17.30
6	11650.00	46.0 AV	54.0	-8.0	1.13 H	64	28.70	17.30

ANTENNA POLARITY & TEST DISTANCE: VERTICAL AT 3 M

NO.	FREQ. (MHz)	EMISSION LEVEL (dBuV/m)	LIMIT (dBuV/m)	MARGIN (dB)	ANTENNA HEIGHT (m)	TABLE ANGLE (Degree)	RAW VALUE (dBuV)	CORRECTION FACTOR (dB/m)
1	*5825.00	127.2 PK			2.04 V	201	86.80	40.40
2	*5825.00	116.6 AV			2.04 V	201	76.20	40.40
3	#5850.00	79.2 PK	97.2	-18.0	2.04 V	201	72.80	6.40
4	#5850.00	68.6 AV	86.6	-18.0	2.04 V	201	62.20	6.40
5	11650.00	60.4 PK	74.0	-13.6	1.00 V	353	43.10	17.30
6	11650.00	48.2 AV	54.0	-5.8	1.00 V	353	30.90	17.30

REMARKS:

1. Emission Level(dBuV/m) = Raw Value(dBuV) + Correction Factor(dB/m)
2. Correction Factor(dB/m) = Antenna Factor(dB/m) + Cable Factor(dB)
- Pre-Amplifier Factor(dB)
3. The other emission levels were very low against the limit.
4. Margin value = Emission Level – Limit value
5. " * ": Fundamental frequency.
6. " # ": The radiated frequency is out of the restricted band.
7. The limit value is defined as per 15.247.

802.11n (20MHz)

CHANNEL	TX Channel 149	DETECTOR FUNCTION	Peak (PK)
FREQUENCY RANGE	1GHz ~ 40GHz		Average (AV)

ANTENNA POLARITY & TEST DISTANCE: HORIZONTAL AT 3 M								
NO.	FREQ. (MHz)	EMISSION LEVEL (dBuV/m)	LIMIT (dBuV/m)	MARGIN (dB)	ANTENNA HEIGHT (m)	TABLE ANGLE (Degree)	RAW VALUE (dBuV)	CORRECTION FACTOR (dB/m)
1	#5725.00	68.1 PK	79.0	-10.9	2.07 H	130	62.00	6.10
2	#5725.00	58.3 AV	69.2	-10.9	2.07 H	130	52.20	6.10
3	*5745.00	109.0 PK			2.07 H	130	68.70	40.30
4	*5745.00	99.2 AV			2.07 H	130	58.90	40.30
5	11490.00	56.5 PK	74.0	-17.5	1.36 H	97	38.90	17.60
6	11490.00	46.1 AV	54.0	-7.9	1.36 H	97	28.50	17.60

ANTENNA POLARITY & TEST DISTANCE: VERTICAL AT 3 M								
NO.	FREQ. (MHz)	EMISSION LEVEL (dBuV/m)	LIMIT (dBuV/m)	MARGIN (dB)	ANTENNA HEIGHT (m)	TABLE ANGLE (Degree)	RAW VALUE (dBuV)	CORRECTION FACTOR (dB/m)
1	#5725.00	84.8 PK	95.7	-10.9	1.92 V	173	78.70	6.10
2	#5725.00	74.0 AV	84.9	-10.9	1.92 V	173	67.90	6.10
3	*5745.00	125.7 PK			1.92 V	173	85.40	40.30
4	*5745.00	114.9 AV			1.92 V	173	74.60	40.30
5	11490.00	60.1 PK	74.0	-13.9	1.00 V	341	42.50	17.60
6	11490.00	48.3 AV	54.0	-5.7	1.00 V	341	30.70	17.60

REMARKS:

1. Emission Level(dBuV/m) = Raw Value(dBuV) + Correction Factor(dB/m)
2. Correction Factor(dB/m) = Antenna Factor(dB/m) + Cable Factor(dB)
– Pre-Amplifier Factor(dB)
3. The other emission levels were very low against the limit.
4. Margin value = Emission Level – Limit value
5. " * ": Fundamental frequency.
6. " # ": The radiated frequency is out of the restricted band.
7. The limit value is defined as per 15.247.

CHANNEL	TX Channel 157	DETECTOR FUNCTION	Peak (PK)
FREQUENCY RANGE	1GHz ~ 40GHz		Average (AV)

ANTENNA POLARITY & TEST DISTANCE: HORIZONTAL AT 3 M

NO.	FREQ. (MHz)	EMISSION LEVEL (dBuV/m)	LIMIT (dBuV/m)	MARGIN (dB)	ANTENNA HEIGHT (m)	TABLE ANGLE (Degree)	RAW VALUE (dBuV)	CORRECTION FACTOR (dB/m)
1	*5785.00	110.0 PK			1.10 H	133	69.70	40.30
2	*5785.00	100.0 AV			1.10 H	133	59.70	40.30
3	11570.00	56.2 PK	74.0	-17.8	1.38 H	77	38.70	17.50
4	11570.00	46.2 AV	54.0	-7.8	1.38 H	77	28.70	17.50

ANTENNA POLARITY & TEST DISTANCE: VERTICAL AT 3 M

NO.	FREQ. (MHz)	EMISSION LEVEL (dBuV/m)	LIMIT (dBuV/m)	MARGIN (dB)	ANTENNA HEIGHT (m)	TABLE ANGLE (Degree)	RAW VALUE (dBuV)	CORRECTION FACTOR (dB/m)
1	*5785.00	126.0 PK			1.90 V	172	85.70	40.30
2	*5785.00	115.0 AV			1.90 V	172	74.70	40.30
3	11570.00	60.6 PK	74.0	-13.4	1.00 V	342	43.10	17.50
4	11570.00	48.5 AV	54.0	-5.5	1.00 V	342	31.00	17.50

REMARKS:

1. Emission Level(dBuV/m) = Raw Value(dBuV) + Correction Factor(dB/m)
2. Correction Factor(dB/m) = Antenna Factor(dB/m) + Cable Factor(dB)
– Pre-Amplifier Factor(dB)
3. The other emission levels were very low against the limit.
4. Margin value = Emission Level – Limit value
5. " * ": Fundamental frequency.
6. The limit value is defined as per 15.247.

CHANNEL	TX Channel 165	DETECTOR FUNCTION	Peak (PK)
FREQUENCY RANGE	1GHz ~ 40GHz		Average (AV)

ANTENNA POLARITY & TEST DISTANCE: HORIZONTAL AT 3 M

NO.	FREQ. (MHz)	EMISSION LEVEL (dBuV/m)	LIMIT (dBuV/m)	MARGIN (dB)	ANTENNA HEIGHT (m)	TABLE ANGLE (Degree)	RAW VALUE (dBuV)	CORRECTION FACTOR (dB/m)
1	*5825.00	109.1 PK			1.01 H	143	68.70	40.40
2	*5825.00	99.1 AV			1.01 H	143	58.70	40.40
3	#5850.00	62.5 PK	79.1	-16.6	1.01 H	143	56.10	6.40
4	#5850.00	52.5 AV	69.1	-16.6	1.01 H	143	46.10	6.40
5	11650.00	56.0 PK	74.0	-18.0	1.23 H	64	38.70	17.30
6	11650.00	45.8 AV	54.0	-8.2	1.23 H	64	28.50	17.30

ANTENNA POLARITY & TEST DISTANCE: VERTICAL AT 3 M

NO.	FREQ. (MHz)	EMISSION LEVEL (dBuV/m)	LIMIT (dBuV/m)	MARGIN (dB)	ANTENNA HEIGHT (m)	TABLE ANGLE (Degree)	RAW VALUE (dBuV)	CORRECTION FACTOR (dB/m)
1	*5825.00	126.1 PK			2.11 V	202	85.70	40.40
2	*5825.00	115.4 AV			2.11 V	202	75.00	40.40
3	#5850.00	79.5 PK	96.1	-16.6	2.11 V	202	73.10	6.40
4	#5850.00	68.8 AV	85.4	-16.6	2.11 V	202	62.40	6.40
5	11650.00	60.7 PK	74.0	-13.3	1.00 V	27	43.40	17.30
6	11650.00	48.4 AV	54.0	-5.6	1.00 V	27	31.10	17.30

REMARKS:

1. Emission Level(dBuV/m) = Raw Value(dBuV) + Correction Factor(dB/m)
2. Correction Factor(dB/m) = Antenna Factor(dB/m) + Cable Factor(dB)
- Pre-Amplifier Factor(dB)
3. The other emission levels were very low against the limit.
4. Margin value = Emission Level – Limit value
5. " * ": Fundamental frequency.
6. " # ": The radiated frequency is out of the restricted band.
7. The limit value is defined as per 15.247.

802.11n (40MHz)

CHANNEL	TX Channel 151	DETECTOR FUNCTION	Peak (PK)
FREQUENCY RANGE	1GHz ~ 40GHz		Average (AV)

ANTENNA POLARITY & TEST DISTANCE: HORIZONTAL AT 3 M								
NO.	FREQ. (MHz)	EMISSION LEVEL (dBuV/m)	LIMIT (dBuV/m)	MARGIN (dB)	ANTENNA HEIGHT (m)	TABLE ANGLE (Degree)	RAW VALUE (dBuV)	CORRECTION FACTOR (dB/m)
1	#5725.00	75.6 PK	75.8	-0.2	1.04 H	129	69.50	6.10
2	#5725.00	65.2 AV	65.4	-0.2	1.04 H	129	59.10	6.10
3	*5755.00	105.8 PK			1.04 H	129	65.50	40.30
4	*5755.00	95.4 AV			1.04 H	129	55.10	40.30
5	11510.00	56.1 PK	74.0	-17.9	1.18 H	74	38.70	17.40
6	11510.00	46.1 AV	54.0	-7.9	1.18 H	74	28.70	17.40

ANTENNA POLARITY & TEST DISTANCE: VERTICAL AT 3 M								
NO.	FREQ. (MHz)	EMISSION LEVEL (dBuV/m)	LIMIT (dBuV/m)	MARGIN (dB)	ANTENNA HEIGHT (m)	TABLE ANGLE (Degree)	RAW VALUE (dBuV)	CORRECTION FACTOR (dB/m)
1	#5725.00	92.7 PK	92.9	-0.2	1.98 V	152	86.60	6.10
2	#5725.00	82.5 AV	82.7	-0.2	1.98 V	152	76.40	6.10
3	*5755.00	122.9 PK			1.98 V	152	82.60	40.30
4	*5755.00	112.7 AV			1.98 V	152	72.40	40.30
5	11510.00	59.5 PK	74.0	-14.5	1.00 V	20	42.10	17.40
6	11510.00	47.6 AV	54.0	-6.4	1.00 V	20	30.20	17.40

REMARKS:

1. Emission Level(dBuV/m) = Raw Value(dBuV) + Correction Factor(dB/m)
2. Correction Factor(dB/m) = Antenna Factor(dB/m) + Cable Factor(dB)
– Pre-Amplifier Factor(dB)
3. The other emission levels were very low against the limit.
4. Margin value = Emission Level – Limit value
5. " * ": Fundamental frequency.
6. " # ": The radiated frequency is out of the restricted band.
7. The limit value is defined as per 15.247.

CHANNEL	TX Channel 159	DETECTOR FUNCTION	Peak (PK)
FREQUENCY RANGE	1GHz ~ 40GHz		Average (AV)

ANTENNA POLARITY & TEST DISTANCE: HORIZONTAL AT 3 M

NO.	FREQ. (MHz)	EMISSION LEVEL (dBuV/m)	LIMIT (dBuV/m)	MARGIN (dB)	ANTENNA HEIGHT (m)	TABLE ANGLE (Degree)	RAW VALUE (dBuV)	CORRECTION FACTOR (dB/m)
1	*5795.00	108.4 PK			1.21 H	147	68.10	40.30
2	*5795.00	98.6 AV			1.21 H	147	58.30	40.30
3	#5850.00	63.7 PK	78.4	-14.7	1.21 H	147	57.30	6.40
4	#5850.00	53.9 AV	68.6	-14.7	1.21 H	147	47.50	6.40
5	11590.00	55.9 PK	74.0	-18.1	1.33 H	225	38.60	17.30
6	11590.00	45.7 AV	54.0	-8.3	1.33 H	225	28.40	17.30

ANTENNA POLARITY & TEST DISTANCE: VERTICAL AT 3 M

NO.	FREQ. (MHz)	EMISSION LEVEL (dBuV/m)	LIMIT (dBuV/m)	MARGIN (dB)	ANTENNA HEIGHT (m)	TABLE ANGLE (Degree)	RAW VALUE (dBuV)	CORRECTION FACTOR (dB/m)
1	*5795.00	123.4 PK			2.04 V	173	83.10	40.30
2	*5795.00	113.0 AV			2.04 V	173	72.70	40.30
3	#5850.00	78.7 PK	93.4	-14.7	2.04 V	173	72.30	6.40
4	#5850.00	68.3 AV	83.0	-14.7	2.04 V	173	61.90	6.40
5	11590.00	59.7 PK	74.0	-14.3	1.00 V	21	42.40	17.30
6	11590.00	47.9 AV	54.0	-6.1	1.00 V	21	30.60	17.30

REMARKS:

1. Emission Level(dBuV/m) = Raw Value(dBuV) + Correction Factor(dB/m)
2. Correction Factor(dB/m) = Antenna Factor(dB/m) + Cable Factor(dB)
– Pre-Amplifier Factor(dB)
3. The other emission levels were very low against the limit.
4. Margin value = Emission Level – Limit value
5. " * ": Fundamental frequency.
6. " # ": The radiated frequency is out of the restricted band.
7. The limit value is defined as per 15.247.

802.11ac (80MHz)

CHANNEL	TX Channel 155	DETECTOR FUNCTION	Peak (PK)
FREQUENCY RANGE	1GHz ~ 40GHz		Average (AV)

ANTENNA POLARITY & TEST DISTANCE: HORIZONTAL AT 3 M

NO.	FREQ. (MHz)	EMISSION LEVEL (dBuV/m)	LIMIT (dBuV/m)	MARGIN (dB)	ANTENNA HEIGHT (m)	TABLE ANGLE (Degree)	RAW VALUE (dBuV)	CORRECTION FACTOR (dB/m)
1	#5725.00	71.3 PK	71.6	-0.3	1.32 H	146	65.20	6.10
2	#5725.00	61.3 AV	61.6	-0.3	1.32 H	146	55.20	6.10
3	*5775.00	101.6 PK			1.32 H	146	61.30	40.30
4	*5775.00	91.6 AV			1.32 H	146	51.30	40.30
5	11550.00	56.2 PK	74.0	-17.8	1.39 H	74	38.80	17.40
6	11550.00	45.8 AV	54.0	-8.2	1.39 H	74	28.40	17.40

ANTENNA POLARITY & TEST DISTANCE: VERTICAL AT 3 M

NO.	FREQ. (MHz)	EMISSION LEVEL (dBuV/m)	LIMIT (dBuV/m)	MARGIN (dB)	ANTENNA HEIGHT (m)	TABLE ANGLE (Degree)	RAW VALUE (dBuV)	CORRECTION FACTOR (dB/m)
1	#5725.00	87.0 PK	87.3	-0.3	2.12 V	152	80.90	6.10
2	#5725.00	77.1 AV	77.4	-0.3	2.12 V	152	71.00	6.10
3	*5775.00	117.3 PK			2.12 V	152	77.00	40.30
4	*5775.00	107.4 AV			2.12 V	152	67.10	40.30
5	11550.00	59.3 PK	74.0	-14.7	1.00 V	27	41.90	17.40
6	11550.00	47.1 AV	54.0	-6.9	1.00 V	27	29.70	17.40

REMARKS:

1. Emission Level(dBuV/m) = Raw Value(dBuV) + Correction Factor(dB/m)
2. Correction Factor(dB/m) = Antenna Factor(dB/m) + Cable Factor(dB)
– Pre-Amplifier Factor(dB)
3. The other emission levels were very low against the limit.
4. Margin value = Emission Level – Limit value
5. " * ": Fundamental frequency.
6. " # ": The radiated frequency is out of the restricted band.
7. The limit value is defined as per 15.247.

802.11ac (80MHz+80MHz)

CHANNEL	TX Channel 155	DETECTOR FUNCTION	Peak (PK)
FREQUENCY RANGE	1GHz ~ 40GHz		Average (AV)

ANTENNA POLARITY & TEST DISTANCE: HORIZONTAL AT 3 M								
NO.	FREQ. (MHz)	EMISSION LEVEL (dBuV/m)	LIMIT (dBuV/m)	MARGIN (dB)	ANTENNA HEIGHT (m)	TABLE ANGLE (Degree)	RAW VALUE (dBuV)	CORRECTION FACTOR (dB/m)
1	#5725.00	61.7 PK	64.8	-3.1	1.09 H	129	55.60	6.10
2	#5725.00	51.6 AV	54.7	-3.1	1.09 H	129	45.50	6.10
3	*5775.00	94.8 PK			1.09 H	129	54.50	40.30
4	*5775.00	84.7 AV			1.09 H	129	44.40	40.30
5	11550.00	56.4 PK	74.0	-17.6	1.15 H	123	39.00	17.40
6	11550.00	46.4 AV	54.0	-7.6	1.15 H	123	29.00	17.40
ANTENNA POLARITY & TEST DISTANCE: VERTICAL AT 3 M								
NO.	FREQ. (MHz)	EMISSION LEVEL (dBuV/m)	LIMIT (dBuV/m)	MARGIN (dB)	ANTENNA HEIGHT (m)	TABLE ANGLE (Degree)	RAW VALUE (dBuV)	CORRECTION FACTOR (dB/m)
1	#5725.00	75.3 PK	78.4	-3.1	2.47 V	198	69.20	6.10
2	#5725.00	65.7 AV	68.8	-3.1	2.47 V	198	59.60	6.10
3	*5775.00	108.4 PK			2.47 V	198	68.10	40.30
4	*5775.00	98.8 AV			2.47 V	198	58.50	40.30
5	11550.00	60.2 PK	74.0	-13.8	1.26 V	302	42.80	17.40
6	11550.00	47.6 AV	54.0	-6.4	1.26 V	302	30.20	17.40

REMARKS:

- Emission Level(dBuV/m) = Raw Value(dBuV) + Correction Factor(dB/m)
- Correction Factor(dB/m) = Antenna Factor(dB/m) + Cable Factor(dB)
– Pre-Amplifier Factor(dB)
- The other emission levels were very low against the limit.
- Margin value = Emission Level – Limit value
- " * ": Fundamental frequency.
- " # ": The radiated frequency is out of the restricted band.
- The limit value is defined as per 15.247.

Below 1GHz Data:

802.11n (20MHz)

CHANNEL	TX Channel 165	DETECTOR FUNCTION	Quasi-Peak (QP)
FREQUENCY RANGE	30MHz ~ 1GHz		

ANTENNA POLARITY & TEST DISTANCE: HORIZONTAL AT 3 M								
NO.	FREQ. (MHz)	EMISSION LEVEL (dBuV/m)	LIMIT (dBuV/m)	MARGIN (dB)	ANTENNA HEIGHT (m)	TABLE ANGLE (Degree)	RAW VALUE (dBuV)	CORRECTION FACTOR (dB/m)
1	41.57	36.7 QP	40.0	-3.3	1.99 H	69	51.00	-14.30
2	62.95	35.2 QP	40.0	-4.8	1.99 H	260	50.10	-14.90
3	158.22	34.7 QP	43.5	-8.8	1.49 H	251	48.30	-13.60
4	243.77	34.5 QP	46.0	-11.5	1.00 H	168	49.30	-14.80
5	412.92	38.6 QP	46.0	-7.4	1.99 H	13	49.50	-10.90
6	875.67	31.3 QP	46.0	-14.7	1.00 H	234	33.40	-2.10
ANTENNA POLARITY & TEST DISTANCE: VERTICAL AT 3 M								
NO.	FREQ. (MHz)	EMISSION LEVEL (dBuV/m)	LIMIT (dBuV/m)	MARGIN (dB)	ANTENNA HEIGHT (m)	TABLE ANGLE (Degree)	RAW VALUE (dBuV)	CORRECTION FACTOR (dB/m)
1	45.45	36.9 QP	40.0	-3.1	1.24 V	12	51.00	-14.10
2	62.95	38.2 QP	40.0	-1.8	1.00 V	124	53.10	-14.90
3	375.98	37.0 QP	46.0	-9.0	1.00 V	119	48.40	-11.40
4	407.09	35.6 QP	46.0	-10.4	1.00 V	145	46.60	-11.00
5	624.85	32.4 QP	46.0	-13.6	1.00 V	153	38.90	-6.50
6	875.67	34.4 QP	46.0	-11.6	1.24 V	168	36.50	-2.10

Remarks:

1. Emission Level(dBuV/m) = Raw Value(dBuV) + Correction Factor(dB/m)
2. Correction Factor(dB/m) = Antenna Factor(dB/m) + Cable Factor(dB)
3. The other emission levels were very low against the limit.
4. Margin value = Emission Level – Limit value

5.2 Conducted Emission Measurement

5.2.1 Limits of Conducted Emission Measurement

Frequency (MHz)	Conducted Limit (dBuV)	
	Quasi-peak	Average
0.15 - 0.5	66 - 56	56 - 46
0.50 - 5.0	56	46
5.0 - 30.0	60	50

Note: 1. The lower limit shall apply at the transition frequencies.
2. The limit decreases in line with the logarithm of the frequency in the range of 0.15 to 0.50MHz.

5.2.2 Test Instruments

Same as item 4.2.2.

5.2.3 Test Procedures

Same as item 4.2.3.

5.2.4 Deviation from Test Standard

No deviation.

5.2.5 Test Setup

Same as item 4.2.5.

5.2.6 EUT Operating Conditions

Same as 4.1.6.

5.2.7 Test Results

Phase	Line (L)	Detector Function	Quasi-Peak (QP) / Average (AV)
-------	----------	-------------------	--------------------------------

No	Freq. [MHz]	Corr. Factor (dB)	Reading Value [dB (uV)]		Emission Level [dB (uV)]		Limit [dB (uV)]		Margin (dB)	
			Q.P.	AV.	Q.P.	AV.	Q.P.	AV.	Q.P.	AV.
			1	0.15782	9.85	31.94	18.72	41.79	28.57	65.58
2	0.16955	9.88	29.84	15.19	39.72	25.07	64.98	54.98	-25.27	-29.92
3	0.51754	9.93	29.20	21.82	39.13	31.75	56.00	46.00	-16.87	-14.25
4	0.96328	10.02	19.93	12.58	29.95	22.60	56.00	46.00	-26.05	-23.40
5	3.47112	10.17	21.88	13.57	32.05	23.74	56.00	46.00	-23.95	-22.26
6	11.64302	10.64	29.58	22.41	40.22	33.05	60.00	50.00	-19.78	-16.95

Remarks:

1. Q.P. and AV. are abbreviations of quasi-peak and average individually.
2. The emission levels of other frequencies were very low against the limit.
3. Margin value = Emission level - Limit value
4. Correction factor = Insertion loss + Cable loss
5. Emission Level = Correction Factor + Reading Value.

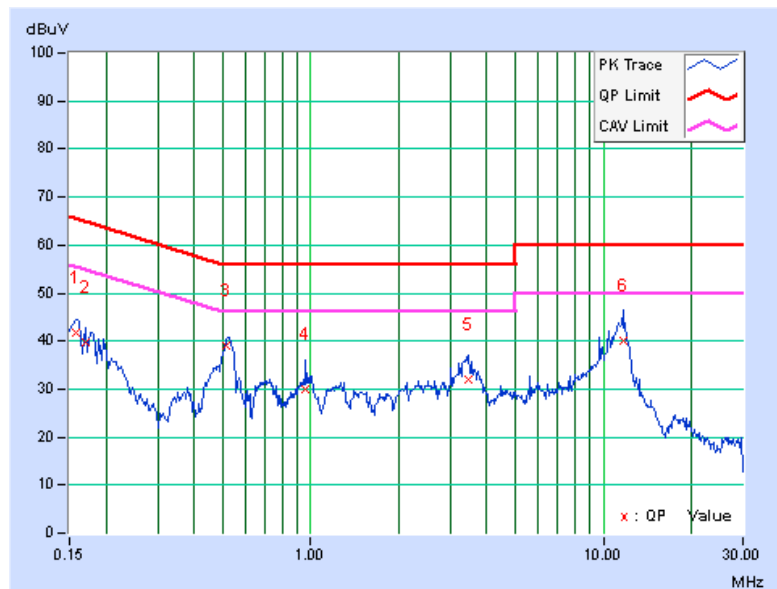

Phase	Neutral (N)	Detector Function	Quasi-Peak (QP) / Average (AV)
-------	-------------	-------------------	--------------------------------

No	Freq. [MHz]	Corr. Factor (dB)	Reading Value		Emission Level		Limit		Margin	
			[dB (uV)]		[dB (uV)]		[dB (uV)]		(dB)	
			Q.P.	AV.	Q.P.	AV.	Q.P.	AV.	Q.P.	AV.
1	0.15391	9.90	31.65	21.82	41.55	31.72	65.79	55.79	-24.24	-24.07
2	0.16564	9.93	28.37	14.74	38.30	24.67	65.18	55.18	-26.87	-30.50
3	0.17737	9.97	28.45	17.28	38.42	27.25	64.61	54.61	-26.19	-27.36
4	0.51363	10.00	28.30	21.43	38.30	31.43	56.00	46.00	-17.70	-14.57
5	3.47894	10.27	23.19	14.27	33.46	24.54	56.00	46.00	-22.54	-21.46
6	11.82679	10.68	27.83	20.83	38.51	31.51	60.00	50.00	-21.49	-18.49

Remarks:

1. Q.P. and AV. are abbreviations of quasi-peak and average individually.
2. The emission levels of other frequencies were very low against the limit.
3. Margin value = Emission level - Limit value
4. Correction factor = Insertion loss + Cable loss
5. Emission Level = Correction Factor + Reading Value.

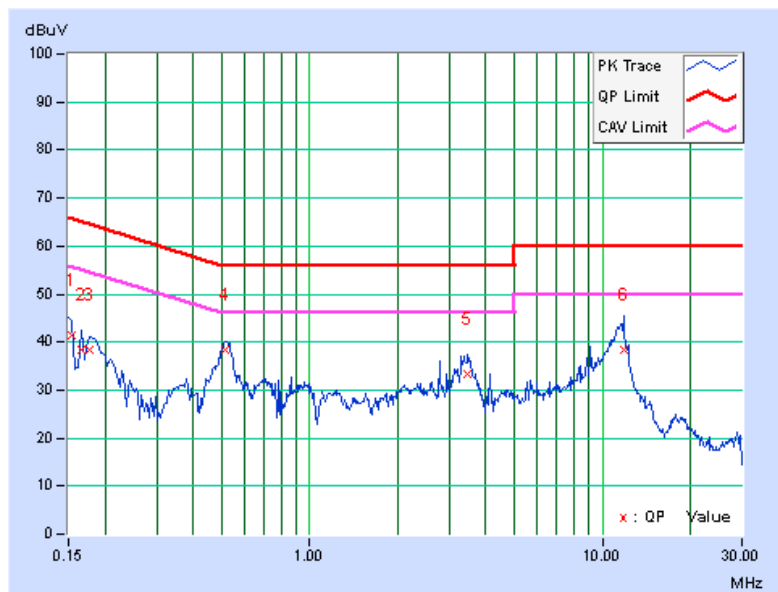

5.3 6dB Bandwidth Measurement

5.3.1 Limits of 6dB Bandwidth Measurement

The minimum of 6dB Bandwidth Measurement is 0.5 MHz.

5.3.2 Test Setup

Same as item 4.3.2.

5.3.3 Test Instruments

Same as item 4.3.3.

5.3.4 Test Procedure

Same as item 4.3.4.

5.3.5 Deviation from Test Standard

No deviation.

5.3.6 EUT Operating Conditions

Same as item 4.3.3.

5.3.7 Test Result

CDD Mode

802.11a

Channel	Frequency (MHz)	6dB Bandwidth (MHz)				Minimum Limit (MHz)	Pass / Fail
		Chain 0	Chain 1	Chain 2	Chain 3		
149	5745	16.36	16.39	16.37	16.39	0.5	PASS
157	5785	16.39	16.38	16.38	16.39	0.5	PASS
165	5825	16.38	16.38	16.39	16.38	0.5	PASS

802.11n (20MHz)

Channel	Frequency (MHz)	6dB Bandwidth (MHz)				Minimum Limit (MHz)	Pass / Fail
		Chain 0	Chain 1	Chain 2	Chain 3		
149	5745	17.60	17.63	17.63	17.62	0.5	PASS
157	5785	17.60	17.61	17.57	17.61	0.5	PASS
165	5825	17.61	17.62	17.63	17.60	0.5	PASS

802.11n (40MHz)

Channel	Frequency (MHz)	6dB Bandwidth (MHz)				Minimum Limit (MHz)	Pass / Fail
		Chain 0	Chain 1	Chain 2	Chain 3		
151	5755	36.42	36.07	36.36	35.87	0.5	PASS
159	5795	36.35	35.48	36.36	36.44	0.5	PASS

802.11ac (80MHz)

Channel	Frequency (MHz)	6dB Bandwidth (MHz)				Minimum Limit (MHz)	Pass / Fail
		Chain 0	Chain 1	Chain 2	Chain 3		
155	5775	76.45	76.43	76.48	76.13	0.5	PASS

802.11ac (80MHz+80MHz)

Channel	Frequency (MHz)	6dB Bandwidth (MHz)		Minimum Limit (MHz)	Pass / Fail
		Chain 2	Chain 3		
155	5775	75.96	75.93	0.5	PASS

Spectrum Plot of Worst Value

802.11a

802.11n (20MHz)

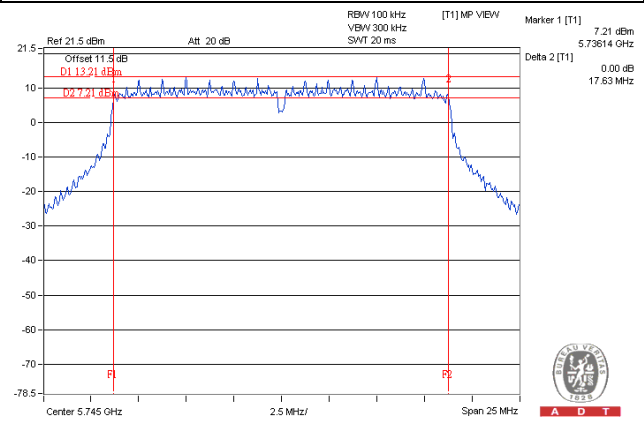
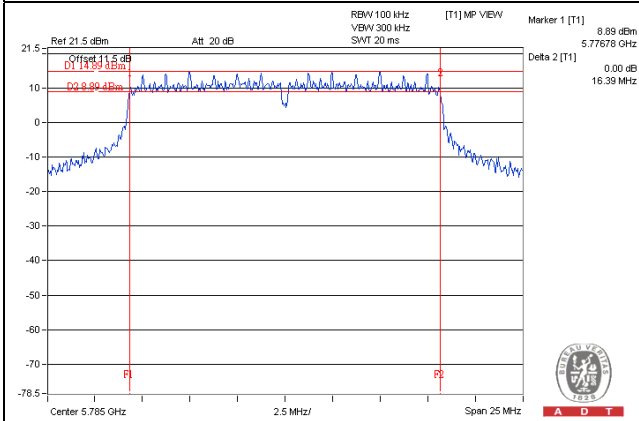

802.11n (40MHz)

802.11ac (80MHz)

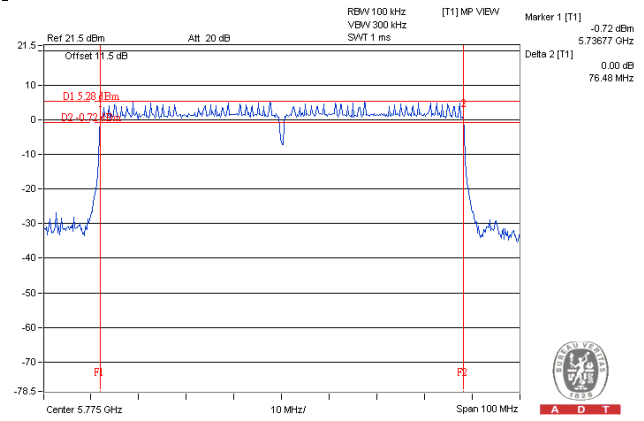
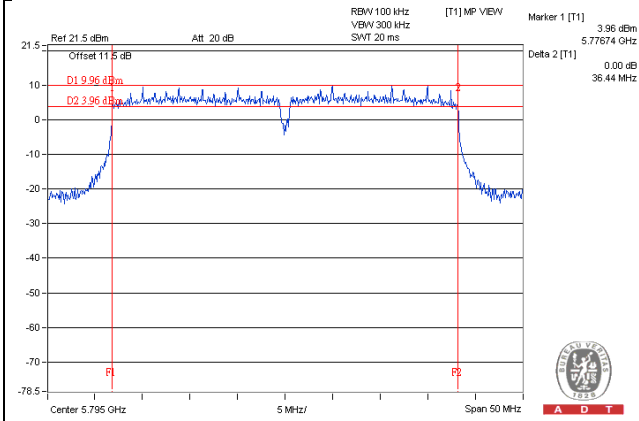

802.11ac (80MHz+80MHz)

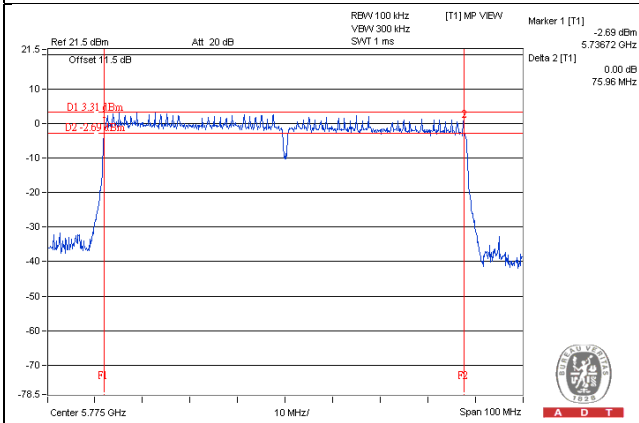

Beamforming_NSS1 Mode

802.11n (20MHz)

Channel	Frequency (MHz)	6dB Bandwidth (MHz)				Minimum Limit (MHz)	Pass / Fail
		Chain 0	Chain 1	Chain 2	Chain 3		
149	5745	17.60	17.61	17.58	17.61	0.5	PASS
157	5785	17.59	17.63	17.61	17.62	0.5	PASS
165	5825	17.61	17.60	17.62	17.60	0.5	PASS

802.11n (40MHz)

Channel	Frequency (MHz)	6dB Bandwidth (MHz)				Minimum Limit (MHz)	Pass / Fail
		Chain 0	Chain 1	Chain 2	Chain 3		
151	5755	36.34	35.88	36.36	35.92	0.5	PASS
159	5795	36.40	36.38	36.36	36.08	0.5	PASS

802.11ac (80MHz)

Channel	Frequency (MHz)	6dB Bandwidth (MHz)				Minimum Limit (MHz)	Pass / Fail
		Chain 0	Chain 1	Chain 2	Chain 3		
155	5775	76.46	76.14	76.47	76.45	0.5	PASS

802.11ac (80MHz+80MHz)

Channel	Frequency (MHz)	6dB Bandwidth (MHz)		Minimum Limit (MHz)	Pass / Fail
		Chain 2	Chain 3		
155	5775	75.96	75.93	0.5	PASS

Spectrum Plot of Worst Value

802.11n (20MHz)

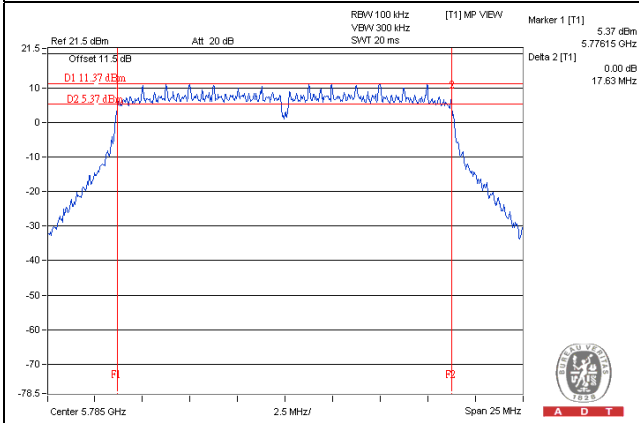

802.11n (40MHz)

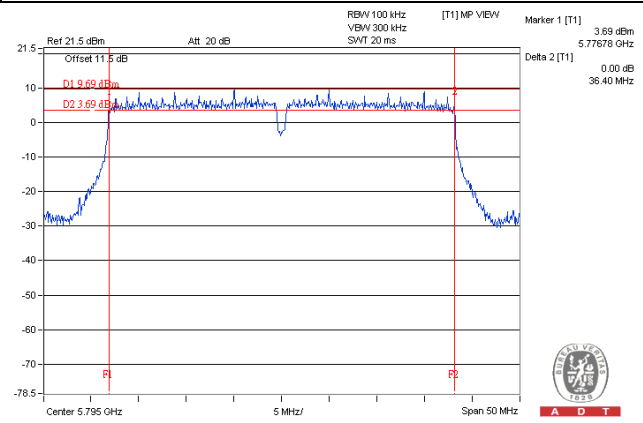

802.11ac (80MHz)

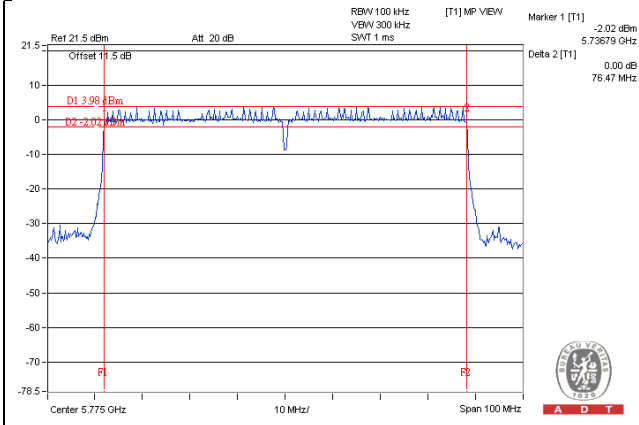

802.11ac (80MHz+80MHz)

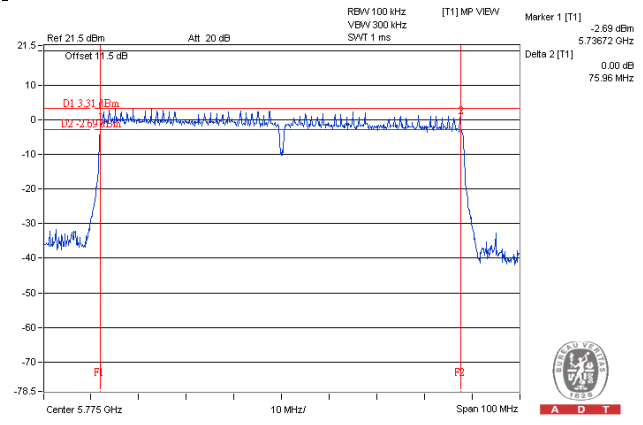

Beamforming_NSS2 Mode

802.11n (20MHz)

Channel	Frequency (MHz)	6dB Bandwidth (MHz)				Minimum Limit (MHz)	Pass / Fail
		Chain 0	Chain 1	Chain 2	Chain 3		
149	5745	17.57	17.67	17.63	17.60	0.5	PASS
157	5785	17.60	17.69	17.65	17.61	0.5	PASS
165	5825	17.60	17.70	17.64	17.59	0.5	PASS

802.11n (40MHz)

Channel	Frequency (MHz)	6dB Bandwidth (MHz)				Minimum Limit (MHz)	Pass / Fail
		Chain 0	Chain 1	Chain 2	Chain 3		
151	5755	36.41	36.18	35.98	36.18	0.5	PASS
159	5795	36.38	35.98	36.02	36.17	0.5	PASS

802.11ac (80MHz)

Channel	Frequency (MHz)	6dB Bandwidth (MHz)				Minimum Limit (MHz)	Pass / Fail
		Chain 0	Chain 1	Chain 2	Chain 3		
155	5775	76.44	76.38	76.48	76.33	0.5	PASS

Spectrum Plot of Worst Value

802.11n (20MHz)

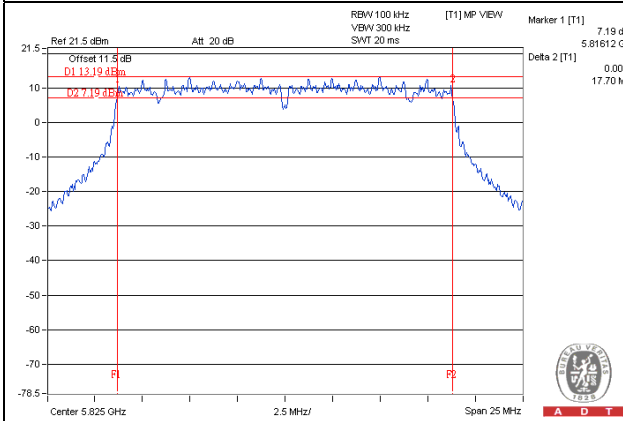

802.11n (40MHz)

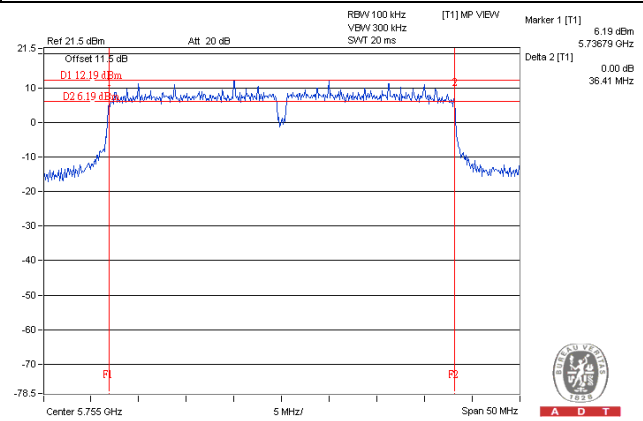

802.11ac (80MHz)

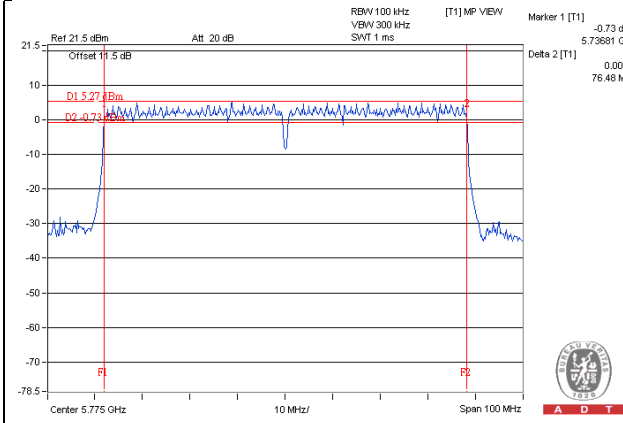

5.4 Conducted Output Power Measurement

5.4.1 Limits of Conducted Output Power Measurement

For systems using digital modulation in the 2400–2483.5 MHz bands: 1 Watt (30dBm)

Per KDB 662911 D01 Multiple Transmitter Output Method of conducted output power measurement on IEEE 802.11 devices,

Array Gain = 0 dB (i.e., no array gain) for $N_{ANT} \leq 4$;

Array Gain = 0 dB (i.e., no array gain) for channel widths ≥ 40 MHz for any N_{ANT} ;

Array Gain = $5 \log(N_{ANT}/N_{SS})$ dB or 3 dB, whichever is less for 20-MHz channel widths with $N_{ANT} \geq 5$.

For power measurements on all other devices: Array Gain = $10 \log(N_{ANT}/N_{SS})$ dB.

5.4.2 Test Setup

Same as item 4.4.2.

5.4.3 Test Instruments

Same as item 4.4.3.

5.4.4 Test Procedures

Same as item 4.4.4.

5.4.5 Deviation from Test Standard

No deviation.

5.4.6 EUT Operating Conditions

Same as item 4.4.6.

5.4.7 Test Results

CDD Mode

802.11a

Chan.	Chan. Freq. (MHz)	AVG. Power (dBm)				Total Power (mW)	Total Power (dBm)	Limit (dBm)	Pass / Fail
		Chain 0	Chain 1	Chain 2	Chain 3				
149	5745	24.34	23.06	23.75	23.76	948.767	29.77	30	Pass
157	5785	23.98	23.15	24.03	23.78	948.284	29.77	30	Pass
165	5825	23.96	23.40	24.31	23.70	971.859	29.88	30	Pass

802.11n (20MHz)

Chan.	Chan. Freq. (MHz)	AVG. Power (dBm)				Total Power (mW)	Total Power (dBm)	Limit (dBm)	Pass / Fail
		Chain 0	Chain 1	Chain 2	Chain 3				
149	5745	24.60	23.31	23.79	23.67	974.833	29.89	30	Pass
157	5785	24.13	23.39	24.18	23.98	988.947	29.95	30	Pass
165	5825	24.14	23.57	24.31	23.84	998.805	29.99	30	Pass

802.11n (40MHz)

Chan.	Chan. Freq. (MHz)	AVG. Power (dBm)				Total Power (mW)	Total Power (dBm)	Limit (dBm)	Pass / Fail
		Chain 0	Chain 1	Chain 2	Chain 3				
151	5755	23.85	23.59	23.86	23.85	957.102	29.81	30	Pass
159	5795	24.09	23.83	23.81	24.12	996.656	29.99	30	Pass

802.11ac (80MHz)

Chan.	Chan. Freq. (MHz)	AVG. Power (dBm)				Total Power (mW)	Total Power (dBm)	Limit (dBm)	Pass / Fail
		Chain 0	Chain 1	Chain 2	Chain 3				
155	5775	22.75	21.69	22.66	22.51	698.676	28.44	30	Pass

802.11ac (80MHz+80MHz)

Chan.	Chan. Freq. (MHz)	AVG. Power (dBm)		Total Power (mW)	Total Power (dBm)	Limit (dBm)	Pass / Fail
		Chain 2	Chain 3				
155	5775	20.47	20.48	223.115	23.49	30	Pass

Beamforming_NSS1 Mode

802.11n (20MHz)

Chan.	Chan. Freq. (MHz)	AVG. Power (dBm)				Total Power (mW)	Total Power (dBm)	Limit (dBm)	Pass / Fail
		Chain 0	Chain 1	Chain 2	Chain 3				
149	5745	23.01	21.84	22.26	22.13	684.315	28.35	28.37	Pass
157	5785	22.73	21.82	22.63	22.47	699.389	28.45	28.47	Pass
165	5825	22.45	22.02	22.51	22.32	683.859	28.35	28.37	Pass

Note:

5745MHz: Directional gain = $1.61\text{dBi} + 10\log(4) = 7.63\text{dBi} > 6\text{dBi}$, so the power limit shall be reduced to $30 - (7.63 - 6) = 28.37\text{dBm}$.

5785MHz: Directional gain = $1.51\text{dBi} + 10\log(4) = 7.53\text{dBi} > 6\text{dBi}$, so the power limit shall be reduced to $30 - (7.53 - 6) = 28.47\text{dBm}$.

5825MHz: Directional gain = $1.61\text{dBi} + 10\log(4) = 7.63\text{dBi} > 6\text{dBi}$, so the power limit shall be reduced to $30 - (7.63 - 6) = 28.37\text{dBm}$.

802.11n (40MHz)

Chan.	Chan. Freq. (MHz)	AVG. Power (dBm)				Total Power (mW)	Total Power (dBm)	Limit (dBm)	Pass / Fail
		Chain 0	Chain 1	Chain 2	Chain 3				
151	5755	21.98	21.37	21.87	21.96	605.700	27.82	28.47	Pass
159	5795	22.89	22.16	22.02	22.21	684.535	28.35	28.37	Pass

Note:

5755MHz: Directional gain = $1.51\text{dBi} + 10\log(4) = 7.53\text{dBi} > 6\text{dBi}$, so the power limit shall be reduced to $30 - (7.53 - 6) = 28.47\text{dBm}$.

5795MHz: Directional gain = $1.61\text{dBi} + 10\log(4) = 7.63\text{dBi} > 6\text{dBi}$, so the power limit shall be reduced to $30 - (7.63 - 6) = 28.37\text{dBm}$.

802.11ac (80MHz)

Chan.	Chan. Freq. (MHz)	AVG. Power (dBm)				Total Power (mW)	Total Power (dBm)	Limit (dBm)	Pass / Fail
		Chain 0	Chain 1	Chain 2	Chain 3				
155	5775	21.46	21.28	21.34	21.39	548.100	27.39	28.47	Pass

Note:

5775MHz: Directional gain = $1.51\text{dBi} + 10\log(4) = 7.53\text{dBi} > 6\text{dBi}$, so the power limit shall be reduced to $30 - (7.53 - 6) = 28.47\text{dBm}$.

802.11ac (80MHz+80MHz)

Chan.	Chan. Freq. (MHz)	AVG. Power (dBm)		Total Power (mW)	Total Power (dBm)	Limit (dBm)	Pass / Fail
		Chain 2	Chain 3				
155	5775	20.47	20.45	222.346	23.47	28.47	Pass

Note:

5775MHz: Directional gain = $1.51\text{dBi} + 10\log(4) = 7.53\text{dBi} > 6\text{dBi}$, so the power limit shall be reduced to $30 - (7.53 - 6) = 28.47\text{dBm}$.

Beamforming_NSS2 Mode

802.11n (20MHz)

Chan.	Chan. Freq. (MHz)	AVG. Power (dBm)				Total Power (mW)	Total Power (dBm)	Limit (dBm)	Pass / Fail
		Chain 0	Chain 1	Chain 2	Chain 3				
149	5745	24.62	23.25	23.75	23.64	969.426	29.87	30	Pass
157	5785	24.30	23.31	24.26	23.95	998.441	29.99	30	Pass
165	5825	24.09	23.55	24.35	23.76	992.866	29.97	30	Pass

Note:

5745MHz: Directional gain = $1.61\text{dBi} + 10\log(4/2) = 4.62\text{dBi} < 6\text{dBi}$, so the power limit no need to reduced.

5785MHz: Directional gain = $1.51\text{dBi} + 10\log(4/2) = 4.52\text{dBi} < 6\text{dBi}$, so the power limit no need to reduced.

5825MHz: Directional gain = $1.61\text{dBi} + 10\log(4/2) = 4.62\text{dBi} < 6\text{dBi}$, so the power limit no need to reduced.

802.11n (40MHz)

Chan.	Chan. Freq. (MHz)	AVG. Power (dBm)				Total Power (mW)	Total Power (dBm)	Limit (dBm)	Pass / Fail
		Chain 0	Chain 1	Chain 2	Chain 3				
151	5755	23.82	23.41	23.55	23.52	911.640	29.60	30	Pass
159	5795	24.03	23.85	23.94	24.02	995.681	29.98	30	Pass

Note:

5755MHz: Directional gain = $1.51\text{dBi} + 10\log(4/2) = 4.52\text{dBi} < 6\text{dBi}$, so the power limit no need to reduced.

5795MHz: Directional gain = $1.61\text{dBi} + 10\log(4/2) = 4.62\text{dBi} < 6\text{dBi}$, so the power limit no need to reduced.

802.11ac (80MHz)

Chan.	Chan. Freq. (MHz)	AVG. Power (dBm)				Total Power (mW)	Total Power (dBm)	Limit (dBm)	Pass / Fail
		Chain 0	Chain 1	Chain 2	Chain 3				
155	5775	22.20	21.54	21.85	22.02	620.850	27.93	30	Pass

Note:

5775MHz: Directional gain = $1.51\text{dBi} + 10\log(4/2) = 4.52\text{dBi} < 6\text{dBi}$, so the power limit no need to reduced.

5.5 Power Spectral Density Measurement

5.5.1 Limits of Power Spectral Density Measurement

The Maximum of Power Spectral Density Measurement is 8dBm.

5.5.2 Test Setup

Same as Item 4.5.2

5.5.3 Test Instruments

Same as Item 4.5.3

5.5.4 Test Procedure

Same as Item 4.5.4

5.5.5 Deviation from Test Standard

No deviation.

5.5.6 EUT Operating Condition

Same as Item 4.3.6

5.5.7 Test Results

CDD Mode

802.11a

TX chain	Channel	Freq. (MHz)	PSD (dBm)	10 log (N=4) dB	Total PSD w/o duty factor (dBm)	Duty factor	Total PSD (dBm)	Limit (dBm)	PASS /FAIL
0	149	5745	-5.16	6.02	0.86	0.24	1.10	6.37	Pass
	157	5785	-4.93	6.02	1.09	0.24	1.33	6.47	Pass
	165	5825	-5.61	6.02	0.41	0.24	0.65	6.37	Pass
1	149	5745	-6.64	6.02	-0.62	0.24	-0.38	6.37	Pass
	157	5785	-6.62	6.02	-0.60	0.24	-0.36	6.47	Pass
	165	5825	-6.98	6.02	-0.96	0.24	-0.72	6.37	Pass
2	149	5745	-7.00	6.02	-0.98	0.24	-0.74	6.37	Pass
	157	5785	-6.68	6.02	-0.66	0.24	-0.42	6.47	Pass
	165	5825	-7.19	6.02	-1.17	0.24	-0.93	6.37	Pass
3	149	5745	-6.66	6.02	-0.64	0.24	-0.40	6.37	Pass
	157	5785	-6.49	6.02	-0.47	0.24	-0.23	6.47	Pass
	165	5825	-6.95	6.02	-0.93	0.24	-0.69	6.37	Pass

Note:

- Method 1 of power density measurement of KDB 662911 is using for calculating total power density. Total power density is summing entire spectra across corresponding frequency bins on the various outputs by computer.
- 5745MHz: Directional gain = $1.61\text{dBi} + 10\log(4) = 7.63\text{dBi} > 6\text{dBi}$, so the power density limit shall be reduced to $8-(7.63-6) = 6.37\text{dBm}$.
 5785MHz: Directional gain = $1.51\text{dBi} + 10\log(4) = 7.53\text{dBi} > 6\text{dBi}$, so the power density limit shall be reduced to $8-(7.53-6) = 6.47\text{dBm}$.
 5825MHz: Directional gain = $1.61\text{dBi} + 10\log(4) = 7.63\text{dBi} > 6\text{dBi}$, so the power density limit shall be reduced to $8-(7.63-6) = 6.37\text{dBm}$.
- Refer to section 3.3 for duty cycle spectrum plot.

802.11n (20MHz)

TX chain	Channel	Freq. (MHz)	PSD (dBm)	10 log (N=4) dB	Total PSD w/o duty factor (dBm)	Duty factor	Total PSD (dBm)	Limit (dBm)	PASS /FAIL
0	149	5745	-5.97	6.02	0.05	0.10	0.15	6.37	Pass
	157	5785	-6.11	6.02	-0.09	0.10	0.01	6.47	Pass
	165	5825	-5.98	6.02	0.04	0.10	0.14	6.37	Pass
1	149	5745	-7.39	6.02	-1.37	0.10	-1.27	6.37	Pass
	157	5785	-7.52	6.02	-1.50	0.10	-1.40	6.47	Pass
	165	5825	-7.39	6.02	-1.37	0.10	-1.27	6.37	Pass
2	149	5745	-8.35	6.02	-2.33	0.10	-2.23	6.37	Pass
	157	5785	-7.95	6.02	-1.93	0.10	-1.83	6.47	Pass
	165	5825	-7.53	6.02	-1.51	0.10	-1.41	6.37	Pass
3	149	5745	-7.54	6.02	-1.52	0.10	-1.42	6.37	Pass
	157	5785	-7.38	6.02	-1.36	0.10	-1.26	6.47	Pass
	165	5825	-7.49	6.02	-1.47	0.10	-1.37	6.37	Pass

Note:

- Method 1 of power density measurement of KDB 662911 is using for calculating total power density. Total power density is summing entire spectra across corresponding frequency bins on the various outputs by computer.
- 5745MHz: Directional gain = $1.61\text{dBi} + 10\log(4) = 7.63\text{dBi} > 6\text{dBi}$, so the power density limit shall be reduced to $8-(7.63-6) = 6.37\text{dBm}$.
 5785MHz: Directional gain = $1.51\text{dBi} + 10\log(4) = 7.53\text{dBi} > 6\text{dBi}$, so the power density limit shall be reduced to $8-(7.53-6) = 6.47\text{dBm}$.
 5825MHz: Directional gain = $1.61\text{dBi} + 10\log(4) = 7.63\text{dBi} > 6\text{dBi}$, so the power density limit shall be reduced to $8-(7.63-6) = 6.37\text{dBm}$.
- Refer to section 3.3 for duty cycle spectrum plot.

802.11n (40MHz)

TX chain	Channel	Freq. (MHz)	PSD (dBm)	10 log (N=4) dB	Total PSD w/o duty factor (dBm)	Duty factor	Total PSD (dBm)	Limit (dBm)	PASS /FAIL
0	151	5755	-8.50	6.02	-2.48	0.18	-2.30	6.47	Pass
	159	5795	-8.80	6.02	-2.78	0.18	-2.60	6.37	Pass
1	151	5755	-10.18	6.02	-4.16	0.18	-3.98	6.47	Pass
	159	5795	-10.22	6.02	-4.20	0.18	-4.02	6.37	Pass
2	151	5755	-10.59	6.02	-4.57	0.18	-4.39	6.47	Pass
	159	5795	-10.28	6.02	-4.26	0.18	-4.08	6.37	Pass
3	151	5755	-10.39	6.02	-4.37	0.18	-4.19	6.47	Pass
	159	5795	-10.13	6.02	-4.11	0.18	-3.93	6.37	Pass

Note:

- Method 1 of power density measurement of KDB 662911 is using for calculating total power density. Total power density is summing entire spectra across corresponding frequency bins on the various outputs by computer.
- 5755MHz: Directional gain = 1.51dBi + 10log(4) = 7.53dBi > 6dBi, so the power density limit shall be reduced to 8-(7.53-6) = 6.47dBm.
5795MHz: Directional gain = 1.61dBi + 10log(4) = 7.63dBi > 6dBi, so the power density limit shall be reduced to 8-(7.63-6) = 6.37dBm.
- Refer to section 3.3 for duty cycle spectrum plot.

802.11ac (80MHz)

TX chain	Channel	Freq. (MHz)	PSD (dBm)	10 log (N=4) dB	Total PSD w/o duty factor (dBm)	Duty factor	Total PSD (dBm)	Limit (dBm)	PASS /FAIL
0	155	5775	-13.21	6.02	-7.19	0.66	-6.53	6.47	Pass
1	155	5775	-15.09	6.02	-9.07	0.66	-8.41	6.47	Pass
2	155	5775	-15.38	6.02	-9.36	0.66	-8.70	6.47	Pass
3	155	5775	-15.21	6.02	-9.19	0.66	-8.53	6.47	Pass

Note:

- Method 1 of power density measurement of KDB 662911 is using for calculating total power density. Total power density is summing entire spectra across corresponding frequency bins on the various outputs by computer.
- 5775MHz: Directional gain = 1.51dBi + 10log(4) = 7.53dBi > 6dBi, so the power density limit shall be reduced to 8-(7.53-6) = 6.47dBm.
- Refer to section 3.3 for duty cycle spectrum plot.

802.11ac (80MHz+80MHz)

TX chain	Channel	Freq. (MHz)	PSD (dBm)	10 log (N=2) dB	Total PSD (dBm)	Limit (dBm)	PASS /FAIL
2	155	5775	-10.98	3.01	-7.97	8.00	Pass
3	155	5775	-12.30	3.01	-9.29	8.00	Pass

Note:

1. Method 1 of power density measurement of KDB 662911 is using for calculating total power density. Total power density is summing entire spectra across corresponding frequency bins on the various outputs by computer.
2. 5775MHz: Directional gain = $1.51\text{dBi} + 10\log(2) = 4.52\text{dBi} < 6\text{dBi}$, so the power density limit no need to reduced.

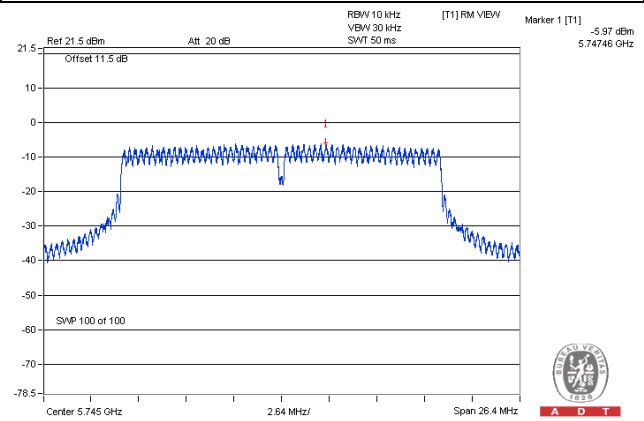
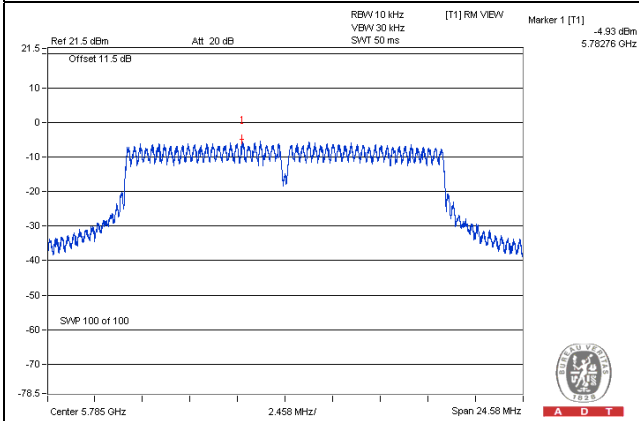
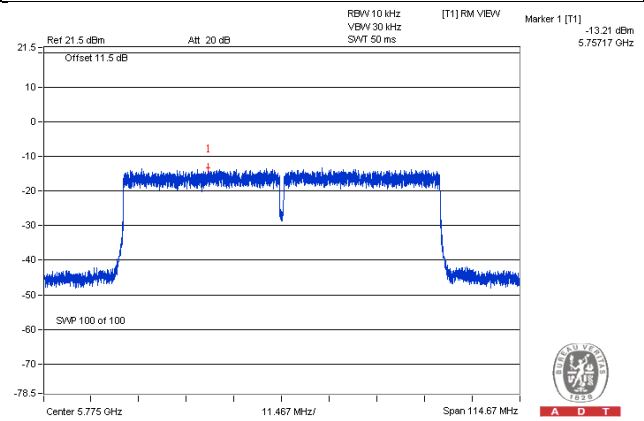
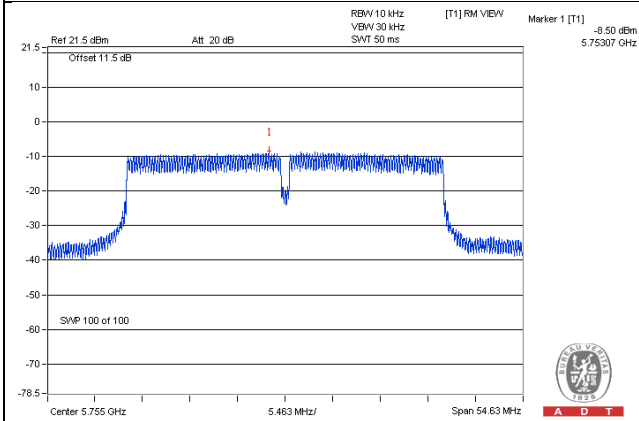
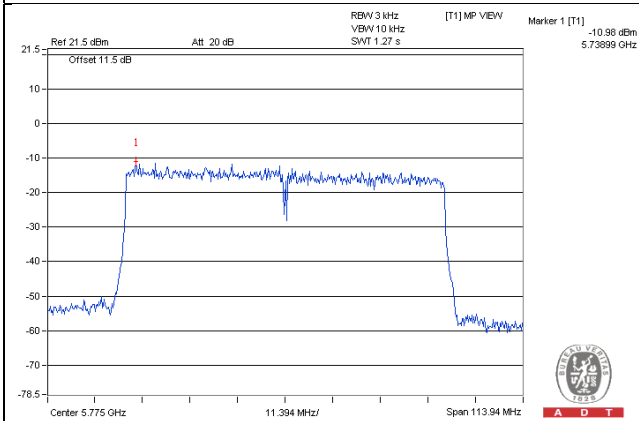
Spectrum Plot of Worst Value**802.11a****802.11n (20MHz)****802.11n (40MHz)****802.11ac (80MHz)****802.11ac (80MHz+80MHz)**

Beamforming_NSS1 Mode

802.11n (20MHz)

TX chain	Channel	Freq. (MHz)	PSD (dBm)	10 log (N=4) dB	Total PSD (dBm)	Limit (dBm)	PASS /FAIL
0	149	5745	-6.93	6.02	-0.91	6.37	Pass
	157	5785	-6.94	6.02	-0.92	6.47	Pass
	165	5825	-7.04	6.02	-1.02	6.37	Pass
1	149	5745	-9.02	6.02	-3.00	6.37	Pass
	157	5785	-9.13	6.02	-3.11	6.47	Pass
	165	5825	-9.14	6.02	-3.12	6.37	Pass
2	149	5745	-9.45	6.02	-3.43	6.37	Pass
	157	5785	-9.27	6.02	-3.25	6.47	Pass
	165	5825	-8.77	6.02	-2.75	6.37	Pass
3	149	5745	-9.15	6.02	-3.13	6.37	Pass
	157	5785	-9.06	6.02	-3.04	6.47	Pass
	165	5825	-8.71	6.02	-2.69	6.37	Pass

Note:

- Method 1 of power density measurement of KDB 662911 is using for calculating total power density. Total power density is summing entire spectra across corresponding frequency bins on the various outputs by computer.
- 5745MHz: Directional gain = $1.61\text{dBi} + 10\log(4) = 7.63\text{dBi} > 6\text{dBi}$, so the power density limit shall be reduced to $8-(7.63-6) = 6.37\text{dBm}$.
 5785MHz: Directional gain = $1.51\text{dBi} + 10\log(4) = 7.53\text{dBi} > 6\text{dBi}$, so the power density limit shall be reduced to $8-(7.53-6) = 6.47\text{dBm}$.
 5825MHz: Directional gain = $1.61\text{dBi} + 10\log(4) = 7.63\text{dBi} > 6\text{dBi}$, so the power density limit shall be reduced to $8-(7.63-6) = 6.37\text{dBm}$.

802.11n (40MHz)

TX chain	Channel	Freq. (MHz)	PSD (dBm)	10 log (N=4) dB	Total PSD w/o duty factor (dBm)	Duty factor	Total PSD (dBm)	Limit (dBm)	PASS /FAIL
0	151	5755	-10.38	6.02	-4.36	0.25	-4.11	6.47	Pass
	159	5795	-10.93	6.02	-4.91	0.25	-4.66	6.37	Pass
1	151	5755	-12.15	6.02	-6.13	0.25	-5.88	6.47	Pass
	159	5795	-11.62	6.02	-5.60	0.25	-5.35	6.37	Pass
2	151	5755	-12.43	6.02	-6.41	0.25	-6.16	6.47	Pass
	159	5795	-12.40	6.02	-6.38	0.25	-6.13	6.37	Pass
3	151	5755	-12.10	6.02	-6.08	0.25	-5.83	6.47	Pass
	159	5795	-12.08	6.02	-6.06	0.25	-5.81	6.37	Pass

Note:

- Method 1 of power density measurement of KDB 662911 is using for calculating total power density. Total power density is summing entire spectra across corresponding frequency bins on the various outputs by computer.
- 5755MHz: Directional gain = $1.51\text{dBi} + 10\log(4) = 7.53\text{dBi} > 6\text{dBi}$, so the power density limit shall be reduced to $8-(7.53-6) = 6.47\text{dBm}$.
5795MHz: Directional gain = $1.61\text{dBi} + 10\log(4) = 7.63\text{dBi} > 6\text{dBi}$, so the power density limit shall be reduced to $8-(7.63-6) = 6.37\text{dBm}$.
- Refer to section 3.3 for duty cycle spectrum plot.

802.11ac (80MHz)

TX chain	Channel	Freq. (MHz)	PSD (dBm)	10 log (N=4) dB	Total PSD w/o duty factor (dBm)	Duty factor	Total PSD (dBm)	Limit (dBm)	PASS /FAIL
0	155	5775	-14.91	6.02	-8.89	0.56	-8.33	6.47	Pass
1	155	5775	-16.62	6.02	-10.60	0.56	-10.04	6.47	Pass
2	155	5775	-16.41	6.02	-10.39	0.56	-9.83	6.47	Pass
3	155	5775	-16.04	6.02	-10.02	0.56	-9.46	6.47	Pass

Note:

- Method 1 of power density measurement of KDB 662911 is using for calculating total power density. Total power density is summing entire spectra across corresponding frequency bins on the various outputs by computer.
- 5775MHz: Directional gain = $1.51\text{dBi} + 10\log(4) = 7.53\text{dBi} > 6\text{dBi}$, so the power density limit shall be reduced to $8-(7.53-6) = 6.47\text{dBm}$.
- Refer to section 3.3 for duty cycle spectrum plot.

802.11ac (80MHz+80MHz)

TX chain	Channel	Freq. (MHz)	PSD (dBm)	10 log (N=2) dB	Total PSD (dBm)	Limit (dBm)	PASS /FAIL
2	155	5775	-10.98	3.01	-7.97	8.00	Pass
3	155	5775	-12.30	3.01	-9.29	8.00	Pass

Note:

1. Method 1 of power density measurement of KDB 662911 is using for calculating total power density. Total power density is summing entire spectra across corresponding frequency bins on the various outputs by computer.
2. 5775MHz: Directional gain = $1.51\text{dBi} + 10\log(2) = 4.52\text{dBi} < 6\text{dBi}$, so the power density limit no need to reduced.

Spectrum Plot of Worst Value

802.11n (20MHz)

802.11n (40MHz)

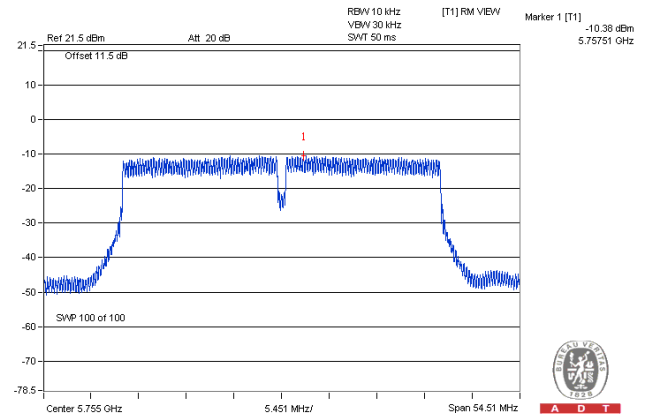
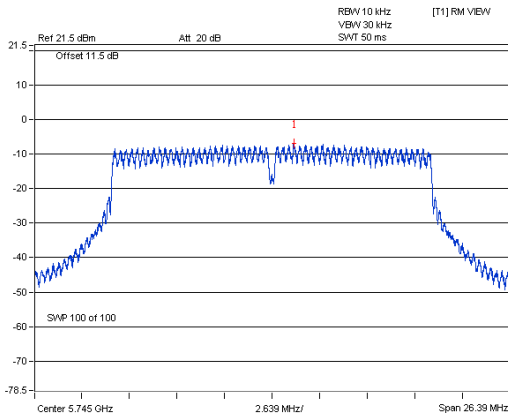

802.11ac (80MHz)

802.11ac (80MHz+80MHz)

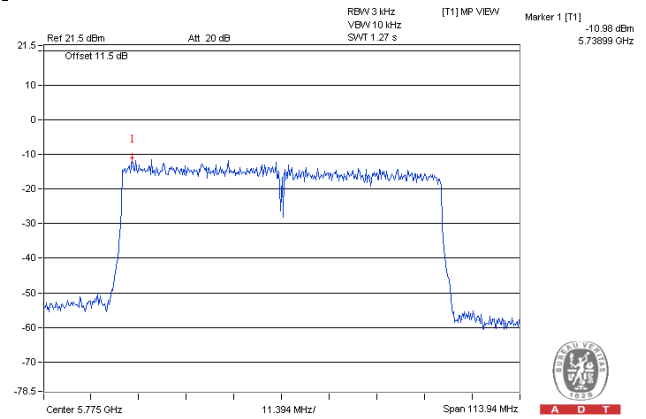
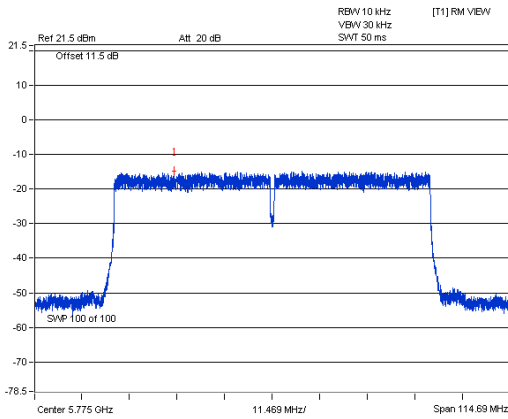

Beamforming_NSS2 Mode

802.11n (20MHz)

TX chain	Channel	Freq. (MHz)	PSD (dBm)	10 log (N=4) dB	Total PSD w/o duty factor (dBm)	Duty factor	Total PSD (dBm)	Limit (dBm)	PASS /FAIL
0	149	5745	-6.10	6.02	-0.08	0.10	0.02	8.00	Pass
	157	5785	-6.15	6.02	-0.13	0.10	-0.03	8.00	Pass
	165	5825	-6.09	6.02	-0.07	0.10	0.03	8.00	Pass
1	149	5745	-5.48	6.02	0.54	0.10	0.64	8.00	Pass
	157	5785	-6.01	6.02	0.01	0.10	0.11	8.00	Pass
	165	5825	-5.72	6.02	0.30	0.10	0.40	8.00	Pass
2	149	5745	-6.21	6.02	-0.19	0.10	-0.09	8.00	Pass
	157	5785	-6.06	6.02	-0.04	0.10	0.06	8.00	Pass
	165	5825	-6.55	6.02	-0.53	0.10	-0.43	8.00	Pass
3	149	5745	-7.73	6.02	-1.71	0.10	-1.61	8.00	Pass
	157	5785	-7.38	6.02	-1.36	0.10	-1.26	8.00	Pass
	165	5825	-7.54	6.02	-1.52	0.10	-1.42	8.00	Pass

Note:

- Method 1 of power density measurement of KDB 662911 is using for calculating total power density. Total power density is summing entire spectra across corresponding frequency bins on the various outputs by computer.
- 5745MHz: Directional gain = $1.61\text{dBi} + 10\log(4/2) = 4.62\text{dBi} < 6\text{dBi}$, so the power density limit no need to reduced.
5785MHz: Directional gain = $1.51\text{dBi} + 10\log(4/2) = 4.52\text{dBi} < 6\text{dBi}$, so the power density limit no need to reduced.
5825MHz: Directional gain = $1.61\text{dBi} + 10\log(4/2) = 4.62\text{dBi} < 6\text{dBi}$, so the power density limit no need to reduced.
- Refer to section 3.3 for duty cycle spectrum plot.

802.11n (40MHz)

TX chain	Channel	Freq. (MHz)	PSD (dBm)	10 log (N=4) dB	Total PSD w/o duty factor (dBm)	Duty factor	Total PSD (dBm)	Limit (dBm)	PASS /FAIL
0	151	5755	-8.04	6.02	-2.02	0.22	-1.80	8.00	Pass
	159	5795	-8.76	6.02	-2.74	0.22	-2.52	8.00	Pass
1	151	5755	-8.12	6.02	-2.10	0.22	-1.88	8.00	Pass
	159	5795	-8.83	6.02	-2.81	0.22	-2.59	8.00	Pass
2	151	5755	-8.93	6.02	-2.91	0.22	-2.69	8.00	Pass
	159	5795	-9.04	6.02	-3.02	0.22	-2.80	8.00	Pass
3	151	5755	-8.02	6.02	-2.00	0.22	-1.78	8.00	Pass
	159	5795	-8.89	6.02	-2.87	0.22	-2.65	8.00	Pass

Note:

- Method 1 of power density measurement of KDB 662911 is using for calculating total power density. Total power density is summing entire spectra across corresponding frequency bins on the various outputs by computer.
- 5755MHz: Directional gain = $1.51\text{dBi} + 10\log(4/2) = 4.52\text{dBi} < 6\text{dBi}$, so the power density limit no need to reduced.
5795MHz: Directional gain = $1.61\text{dBi} + 10\log(4/2) = 4.62\text{dBi} < 6\text{dBi}$, so the power density limit no need to reduced.
- Refer to section 3.3 for duty cycle spectrum plot.

802.11ac (80MHz)

TX chain	Channel	Freq. (MHz)	PSD (dBm)	10 log (N=4) dB	Total PSD w/o duty factor (dBm)	Duty factor	Total PSD (dBm)	Limit (dBm)	PASS /FAIL
0	155	5775	-13.55	6.02	-7.53	0.43	-7.10	8.00	Pass
1	155	5775	-14.50	6.02	-8.48	0.43	-8.05	8.00	Pass
2	155	5775	-15.70	6.02	-9.68	0.43	-9.25	8.00	Pass
3	155	5775	-14.52	6.02	-8.50	0.43	-8.07	8.00	Pass

Note:

- Method 1 of power density measurement of KDB 662911 is using for calculating total power density. Total power density is summing entire spectra across corresponding frequency bins on the various outputs by computer.
- 5775MHz: Directional gain = $1.51\text{dBi} + 10\log(4/2) = 4.52\text{dBi} < 6\text{dBi}$, so the power density limit no need to reduced.
- Refer to section 3.3 for duty cycle spectrum plot.

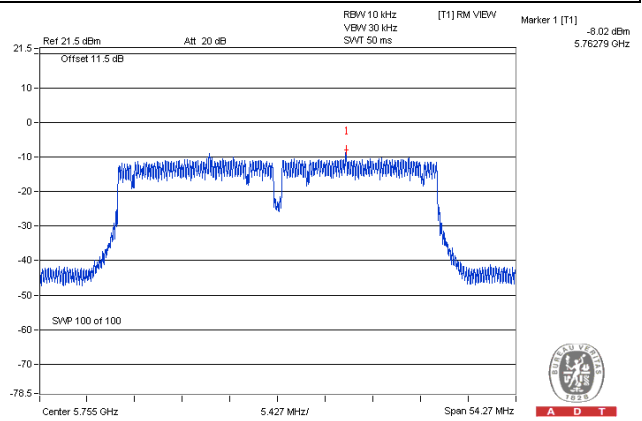
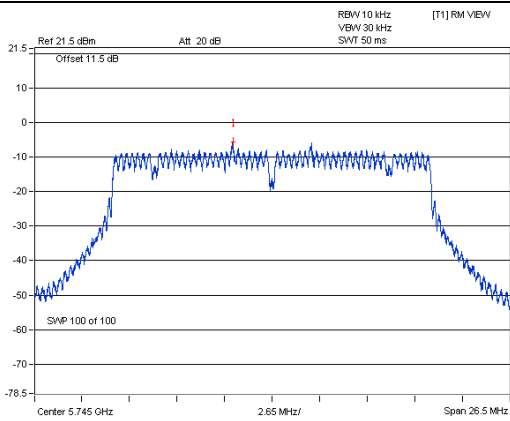
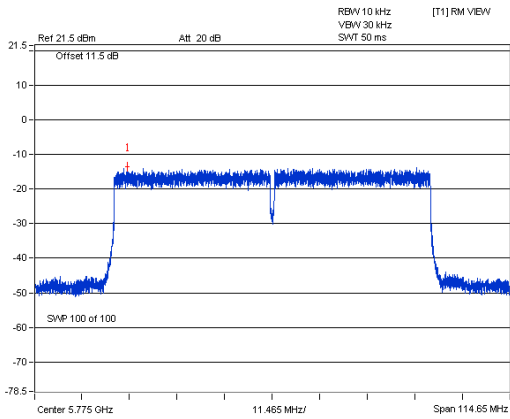
Spectrum Plot of Worst Value**802.11n (20MHz)****802.11n (40MHz)****802.11ac (80MHz)**

5.6 Conducted Out of Band Emission Measurement

5.6.1 Limits of Conducted Out of Band Emission Measurement

Below -30dB of the highest emission level of operating band (in 100kHz Resolution Bandwidth).

5.6.2 Test Setup

Same as Item 4.6.2

5.6.3 Test Instruments

Same as Item 4.6.3

5.6.4 Test Procedure

Same as Item 4.6.4

5.6.5 Deviation from Test Standard

No deviation.

5.6.6 EUT Operating Condition

Same as Item 4.3.6

5.6.7 Test Results

The spectrum plots are attached on the following pages. D1 line indicates the highest level, and D2 line indicates the 30dB offset below D1. It shows compliance with the requirement.

CDD Mode
802.11a_Chain 0

CH 149

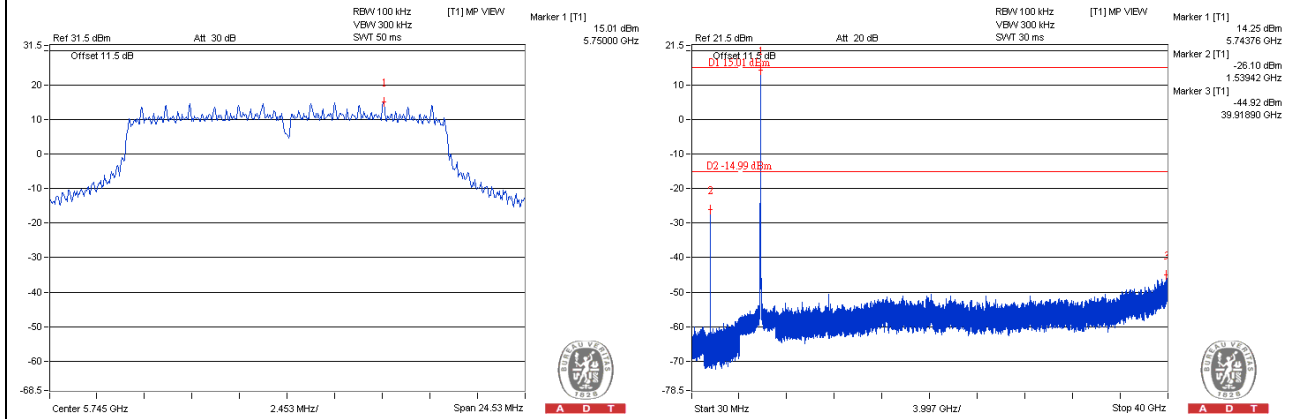

CH 157

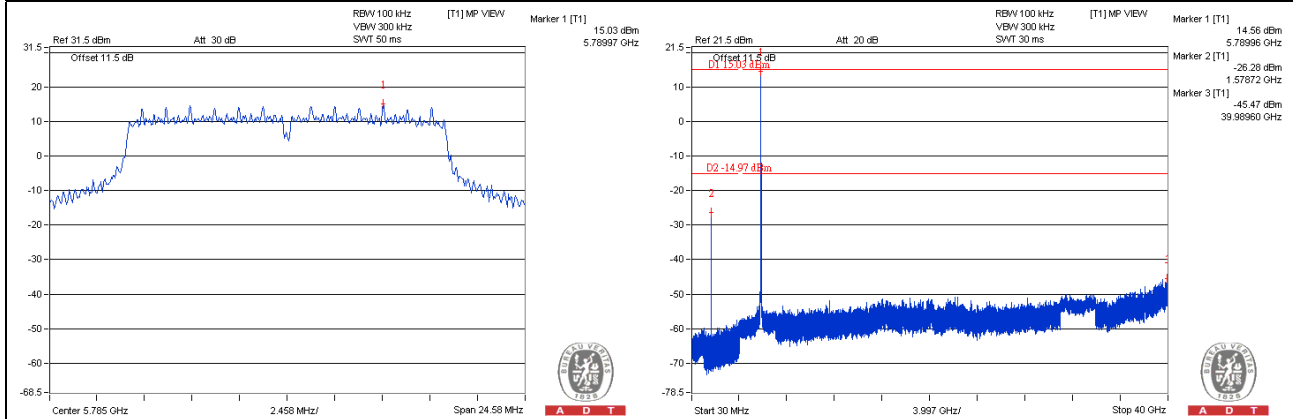

CH 165

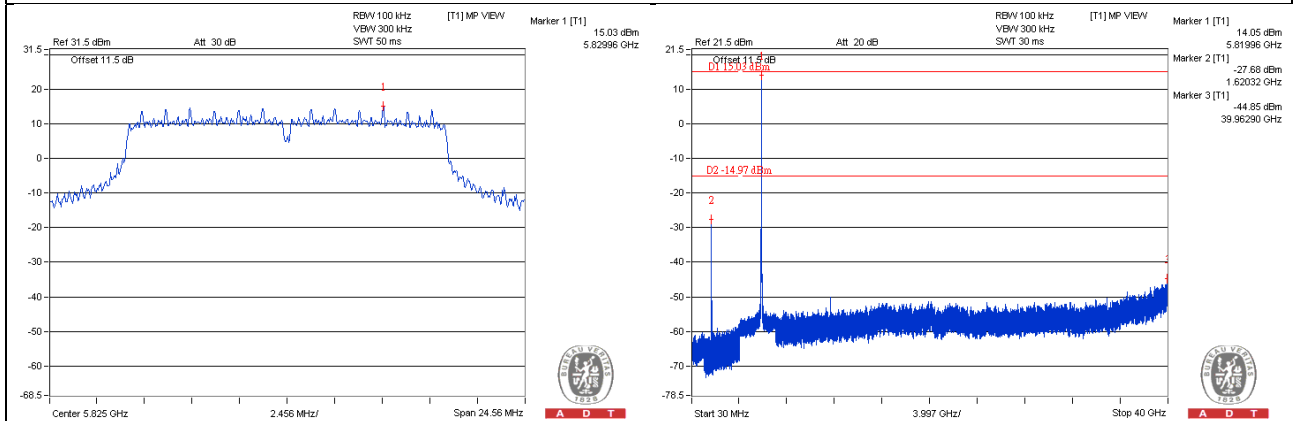

802.11a_Chain 1

CH 149

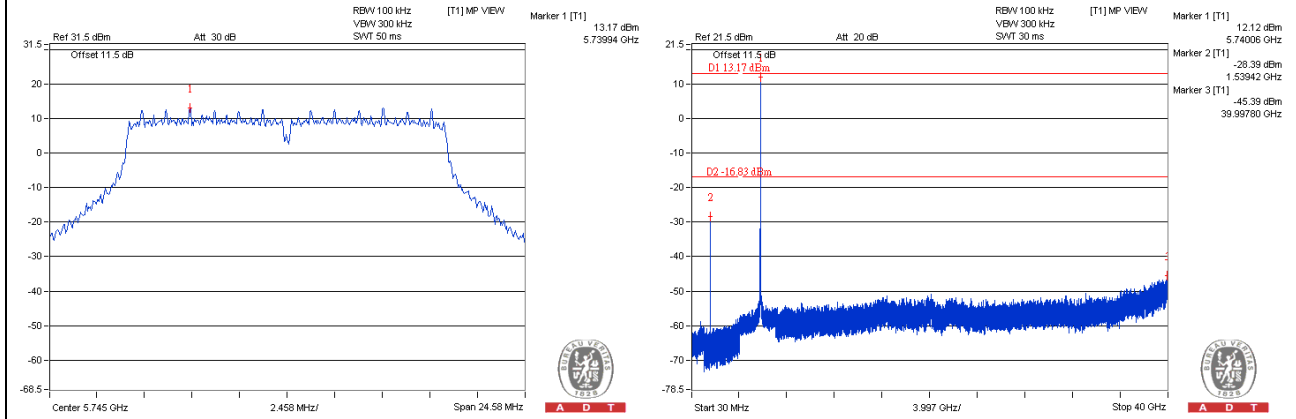

CH 157

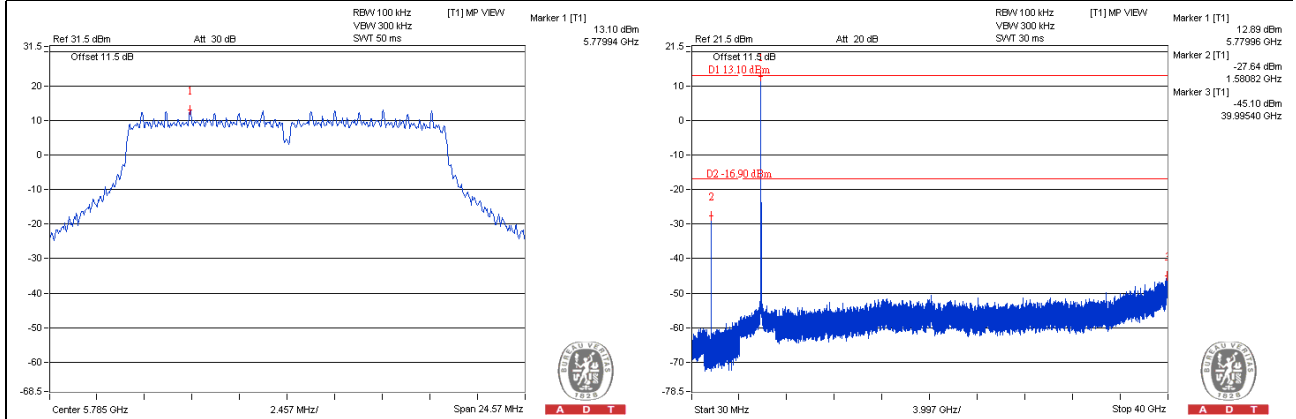

CH 165

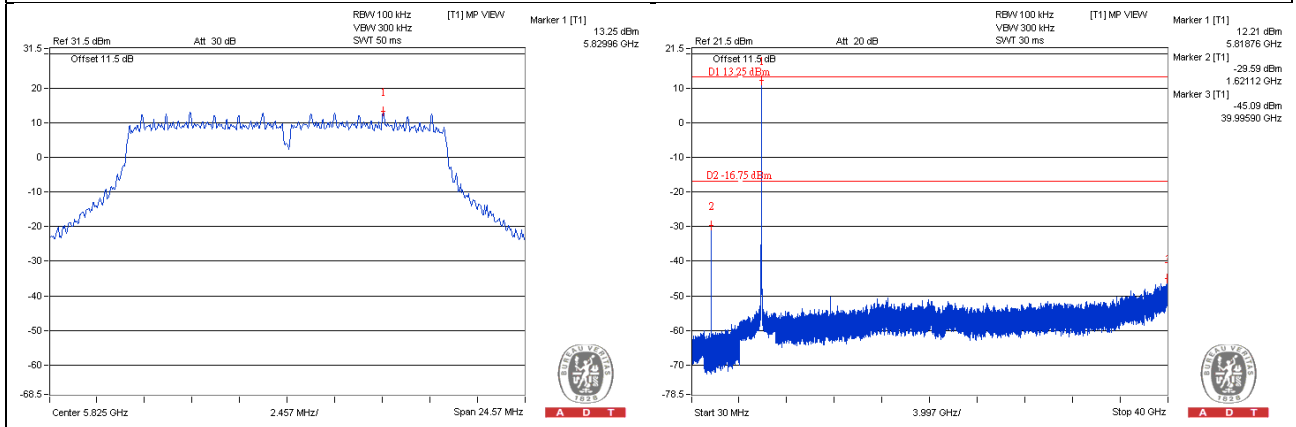

802.11a_Chain 2

CH 149

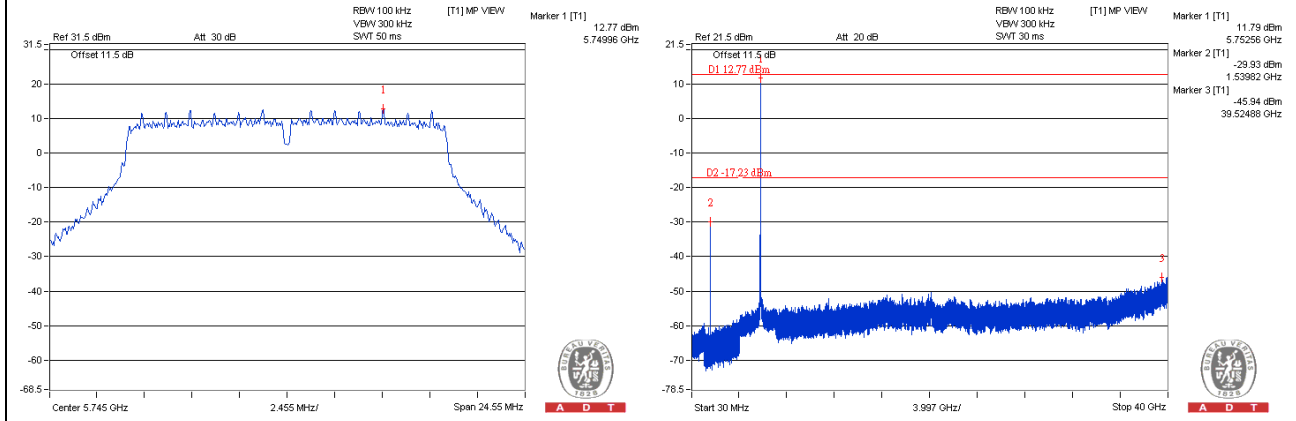

CH 157

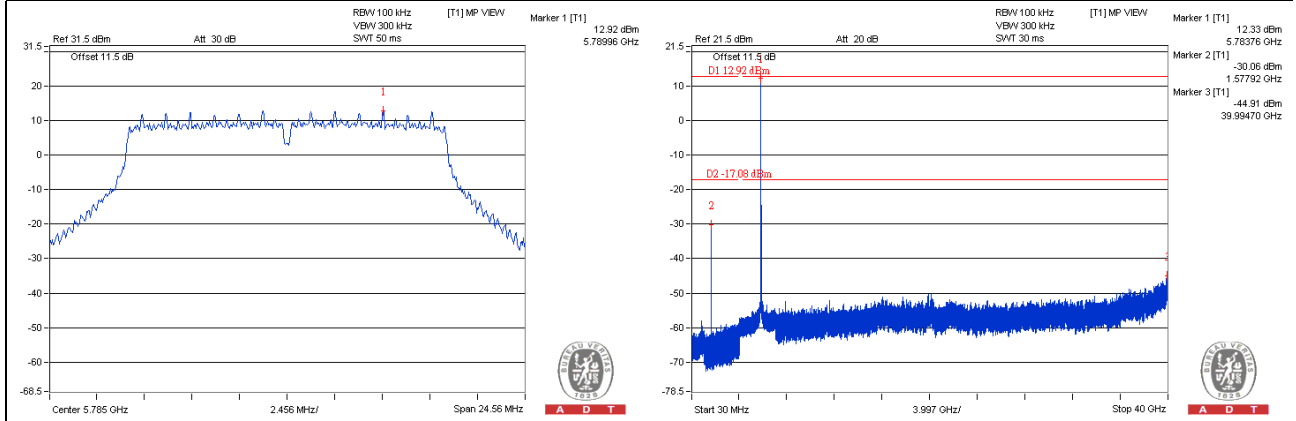

CH 165

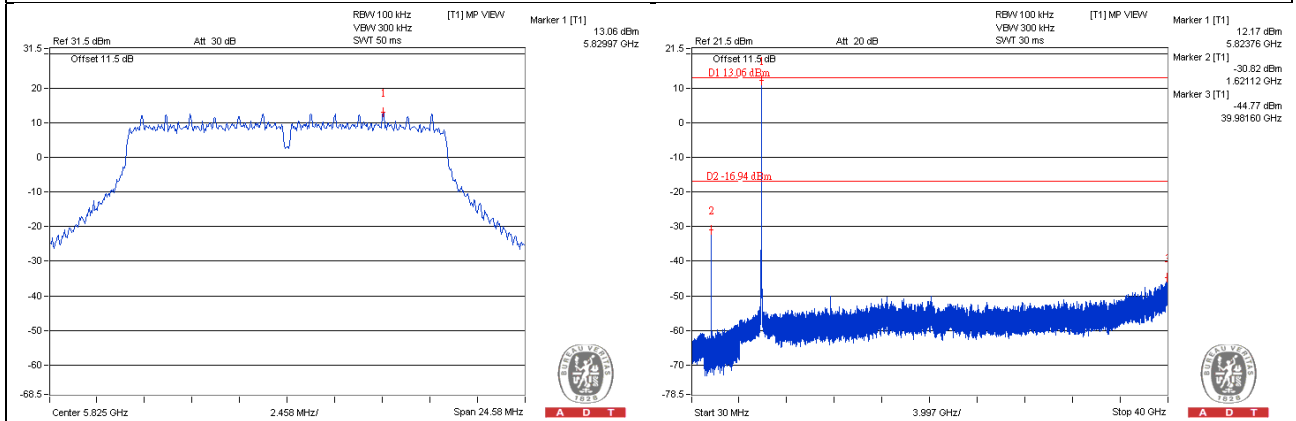

802.11a_Chain 3

CH 149

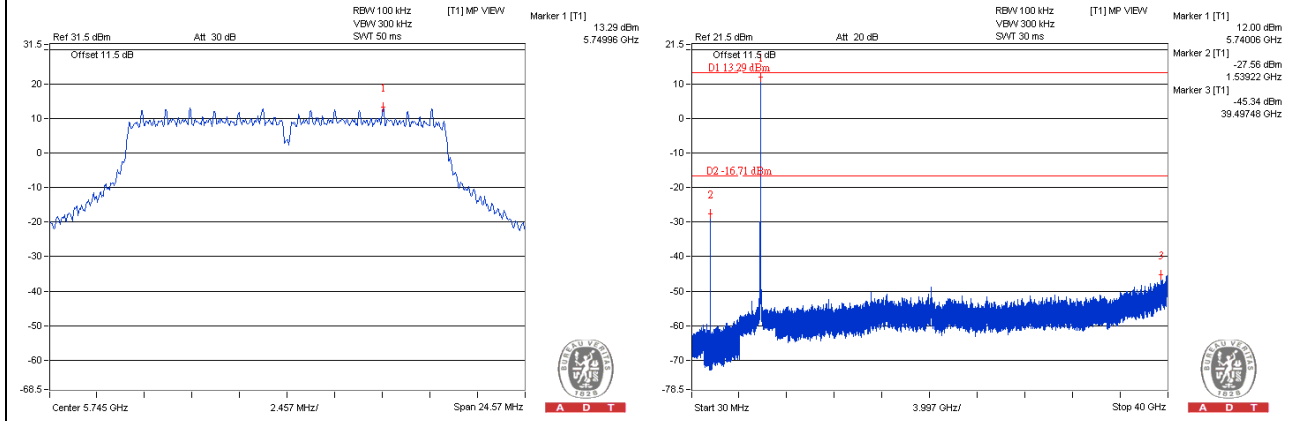

CH 157

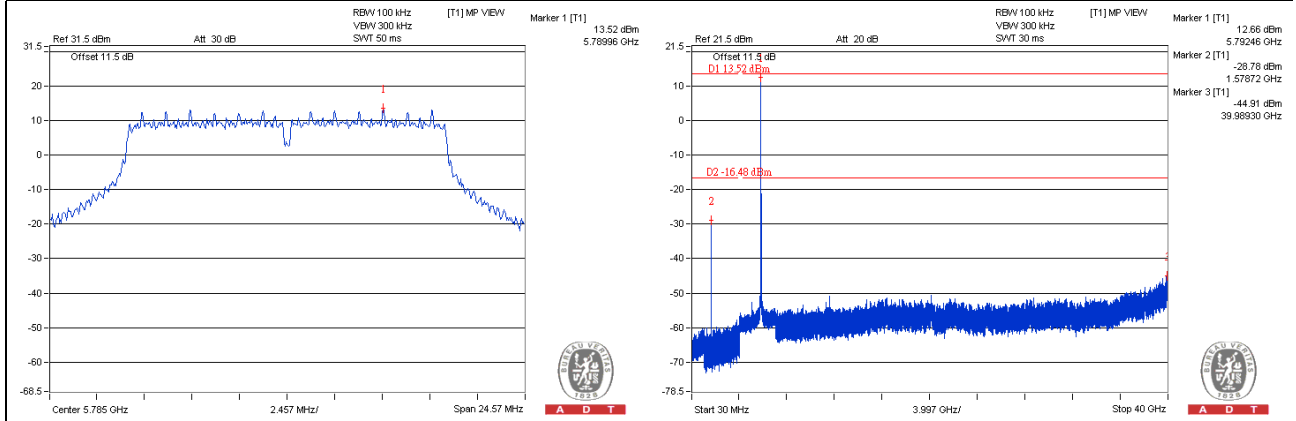

CH 165

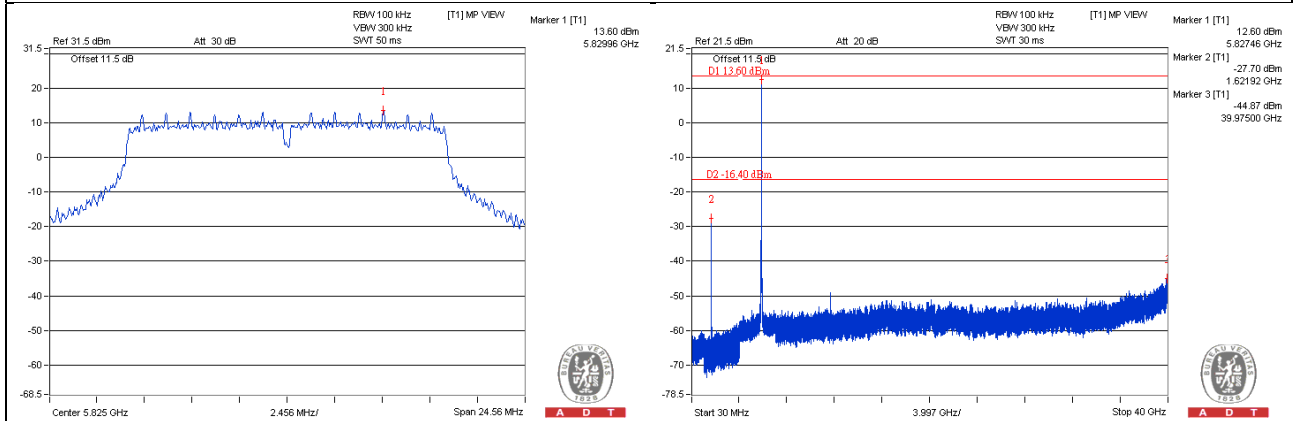



A D T

802.11n (20MHz)_Chain 0

CH 149

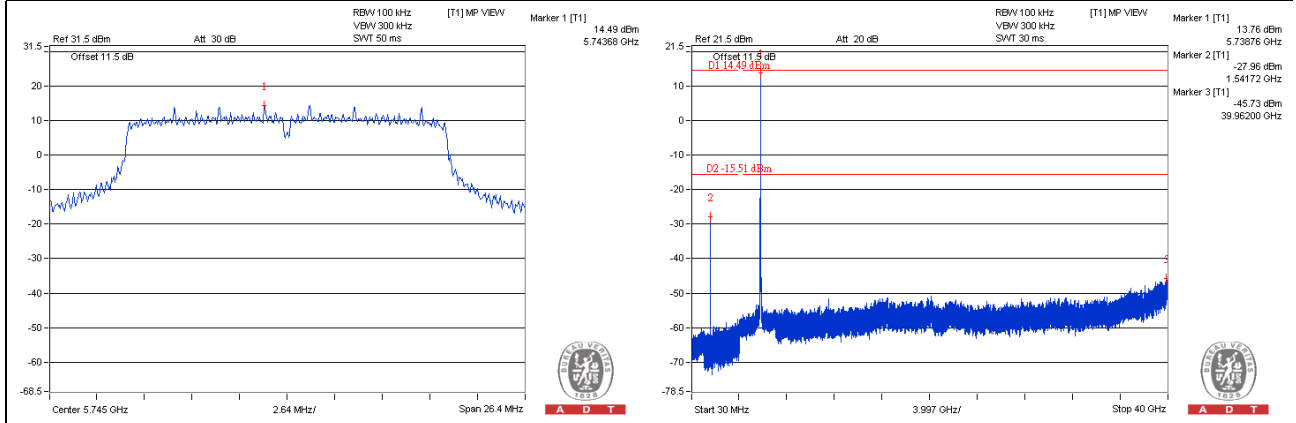

CH 157

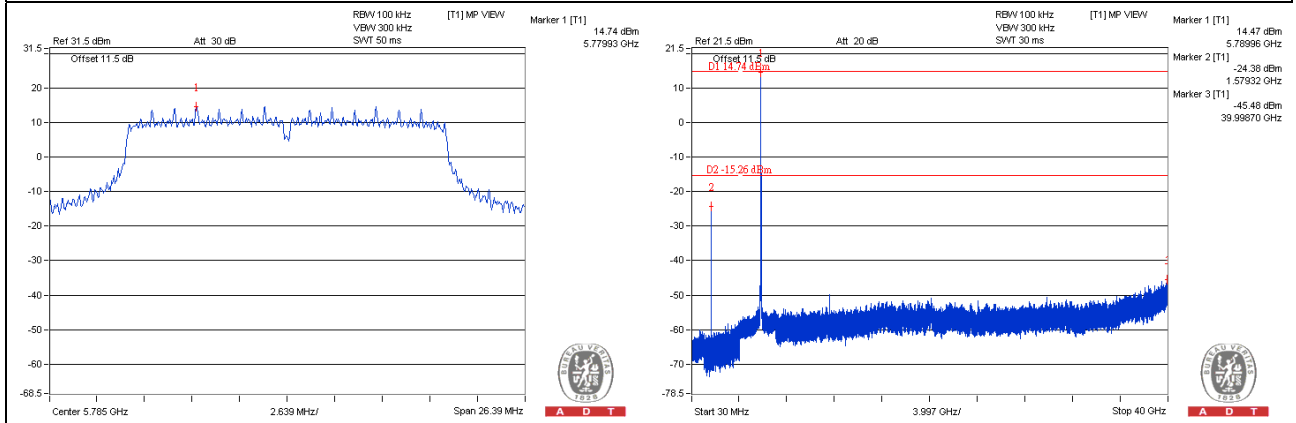

CH 165

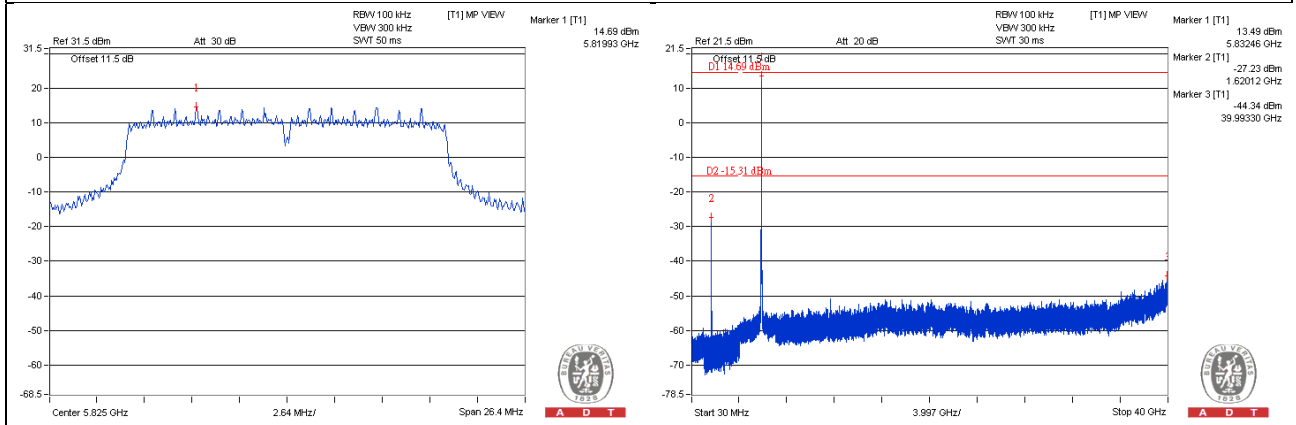

802.11n (20MHz)_Chain 1

CH 149

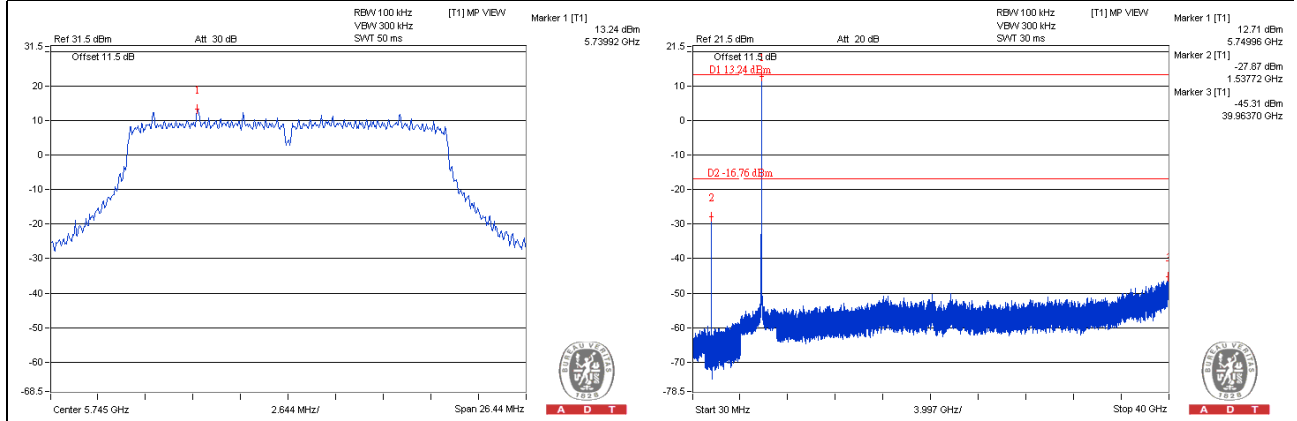

CH 157

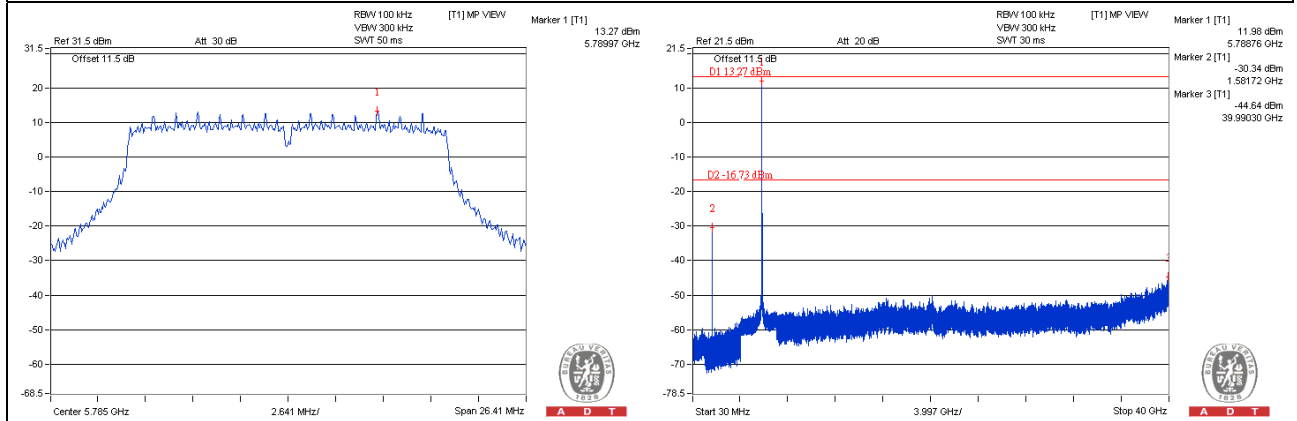

CH 165

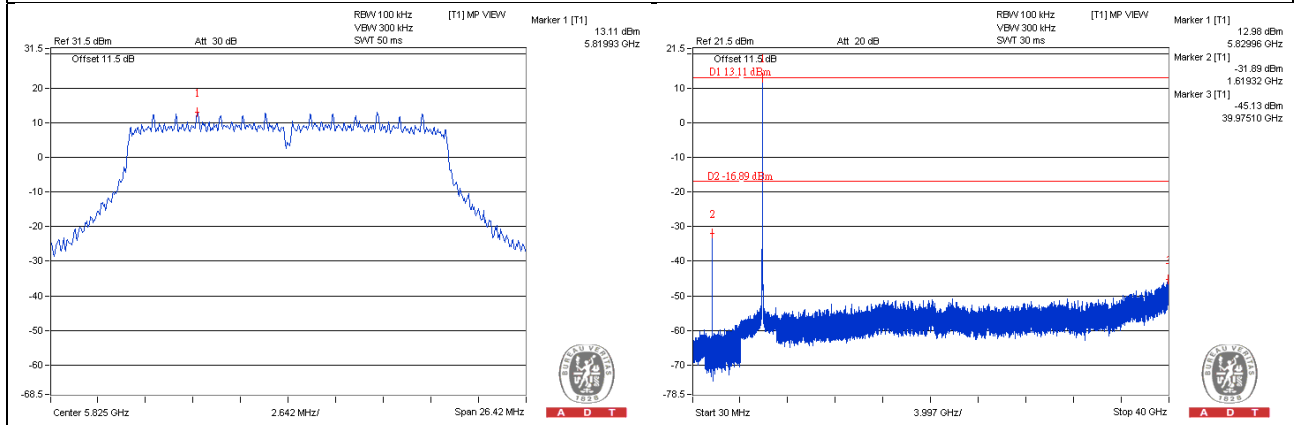

802.11n (20MHz)_Chain 2

CH 149

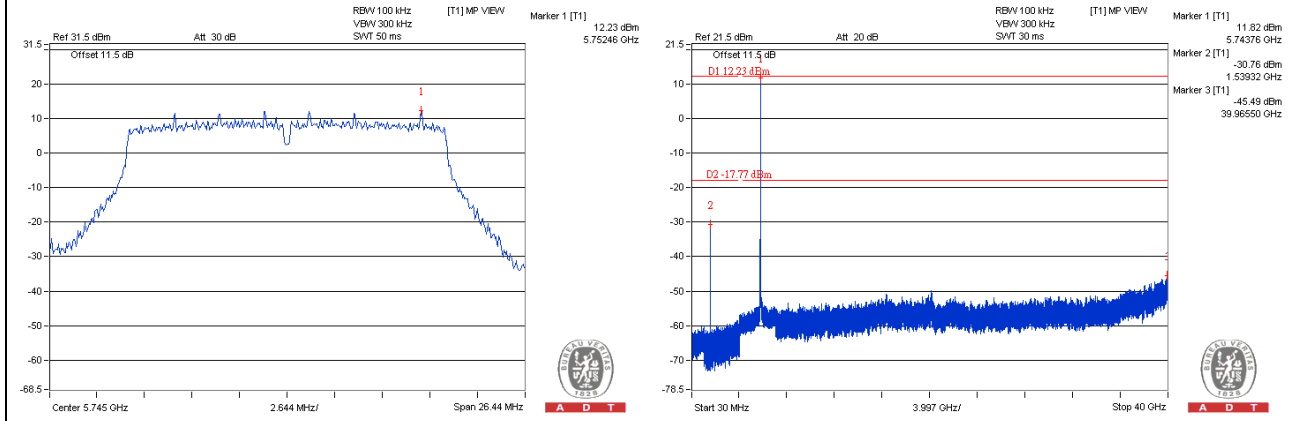

CH 157

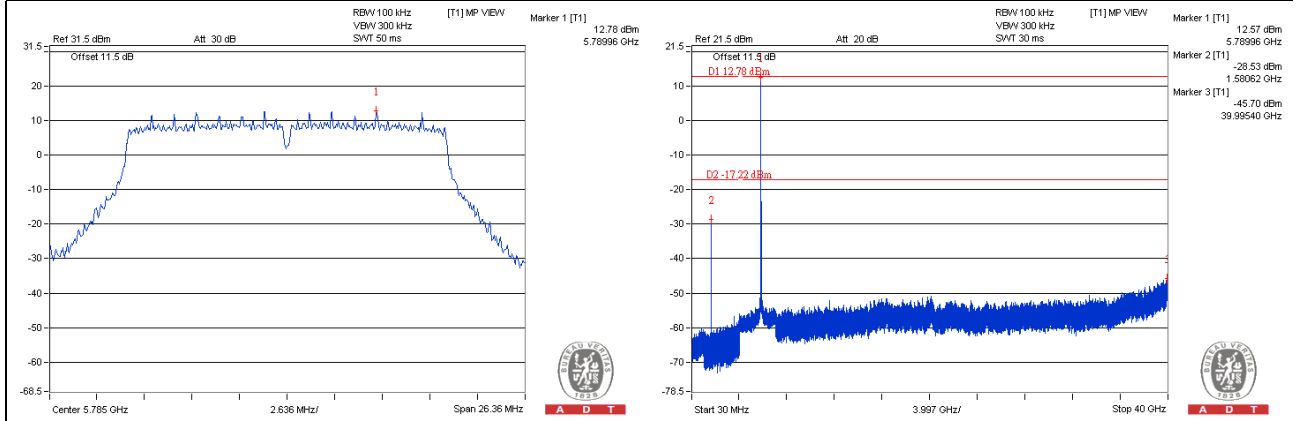

CH 165

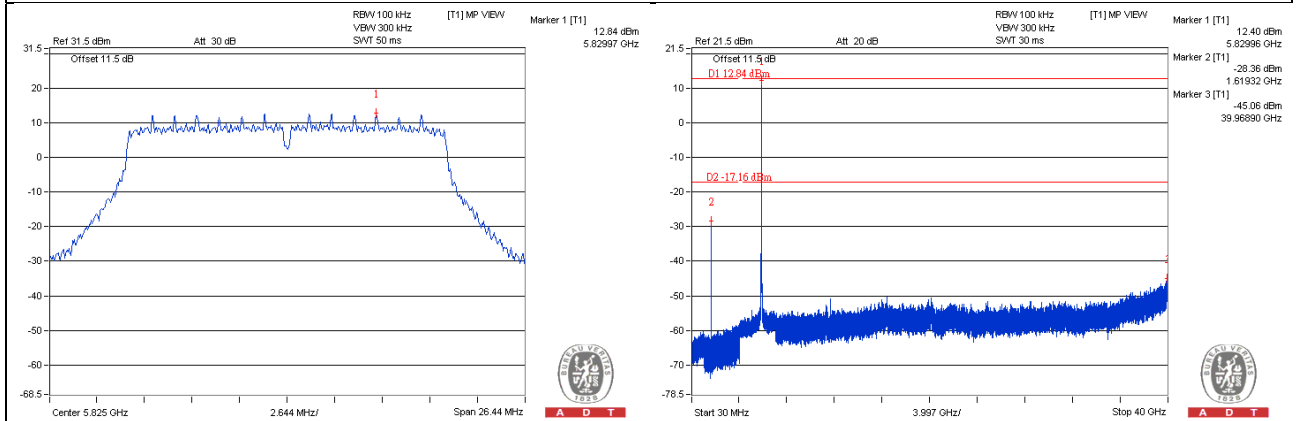

802.11n (20MHz)_Chain 3

CH 149

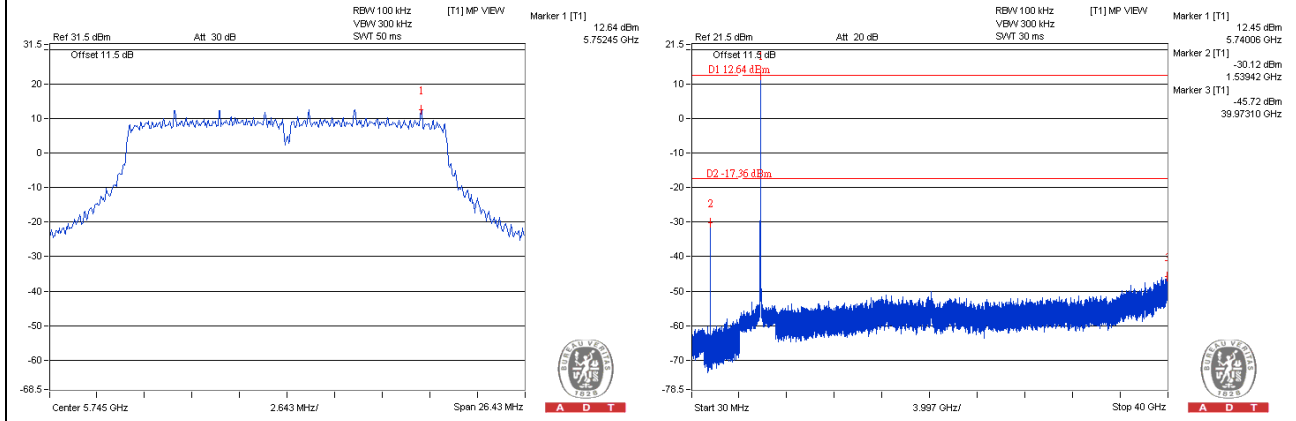

CH 157

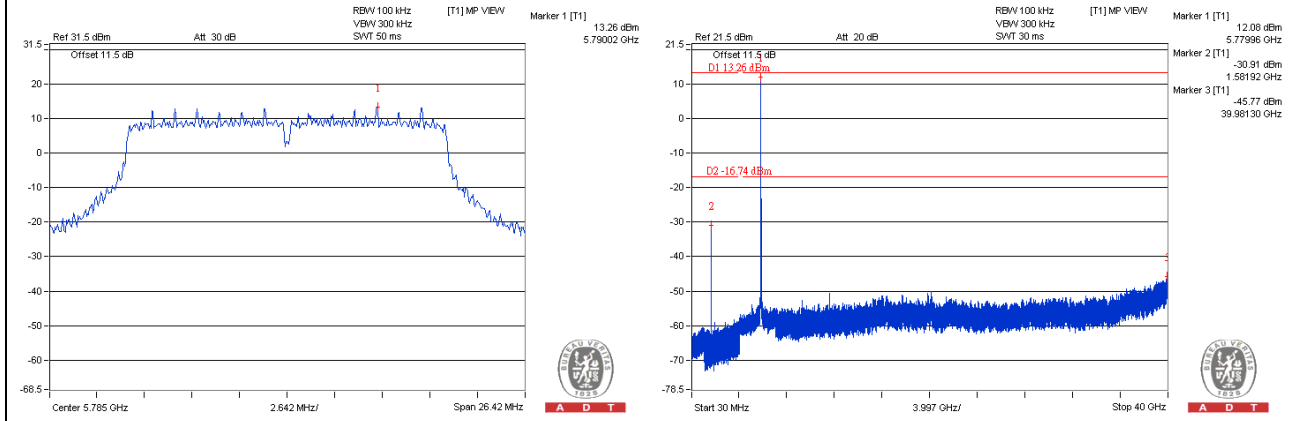

CH 165

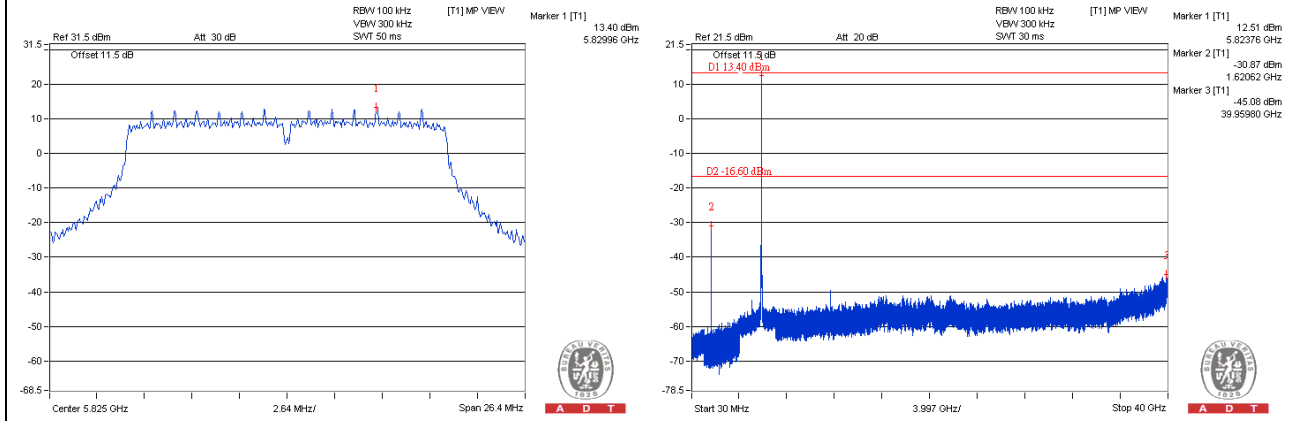

802.11n (40MHz)_Chain 0

CH 151

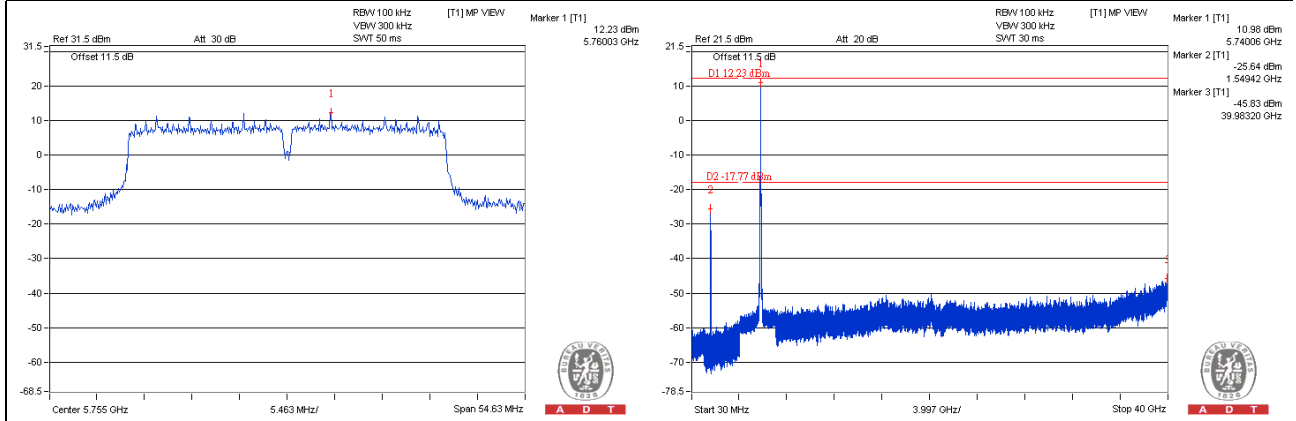

CH 159

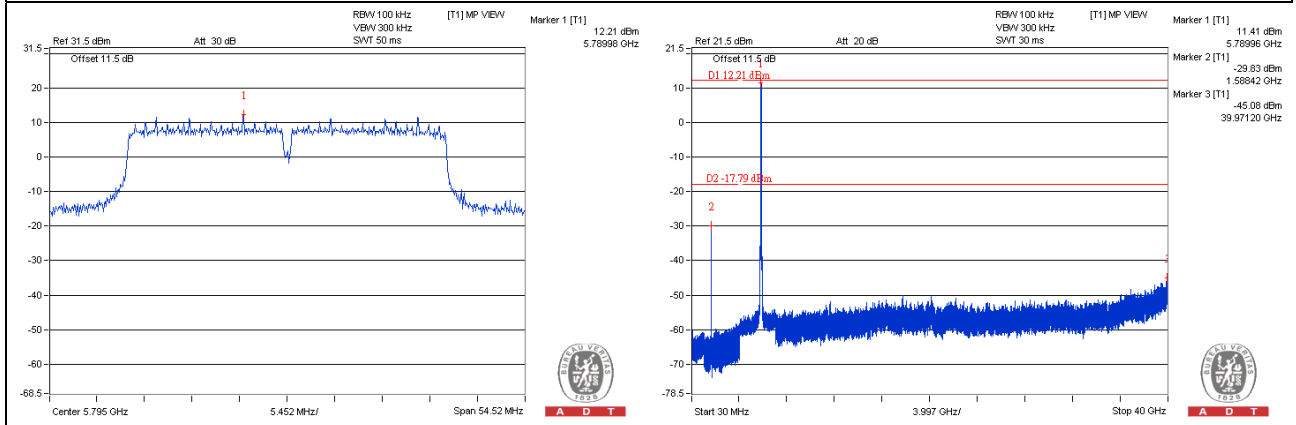

802.11n (40MHz) Chain 1

CH 151

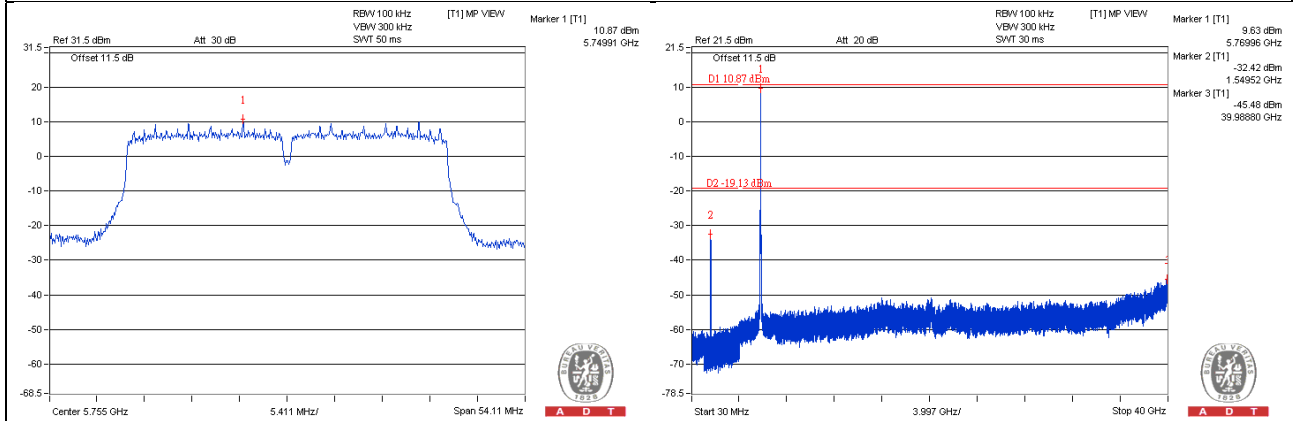

CH 159

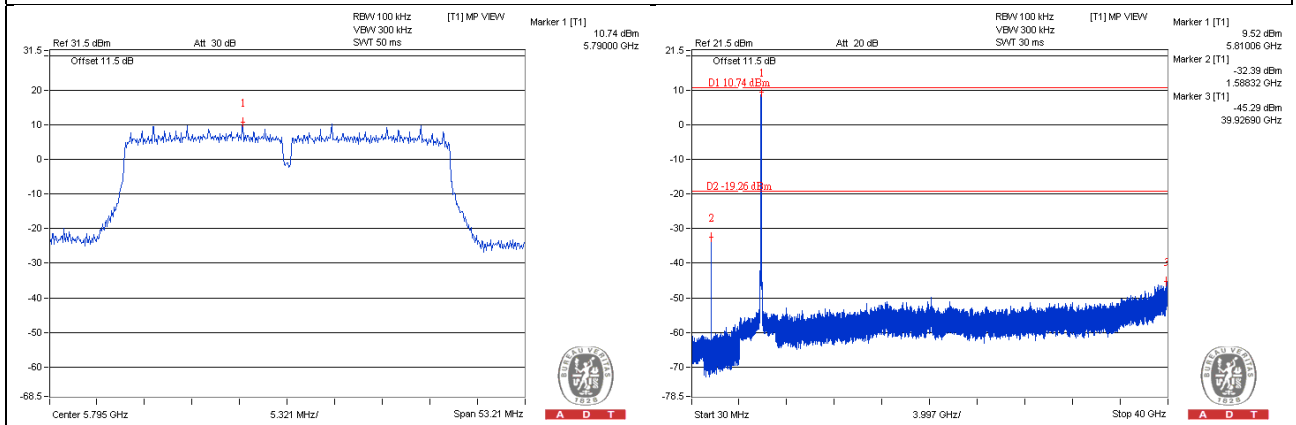

802.11n (40MHz)_Chain 2

CH 151

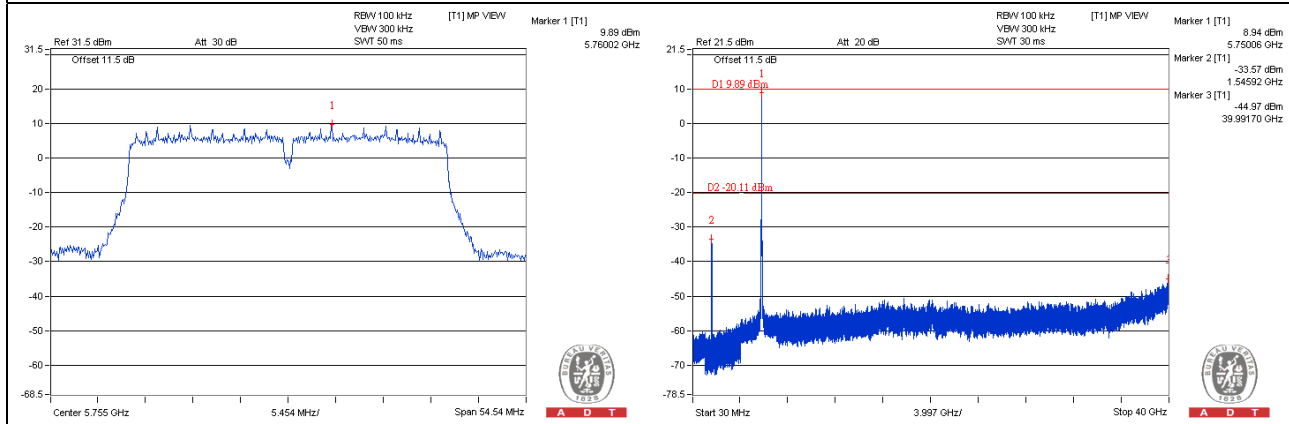

CH 159

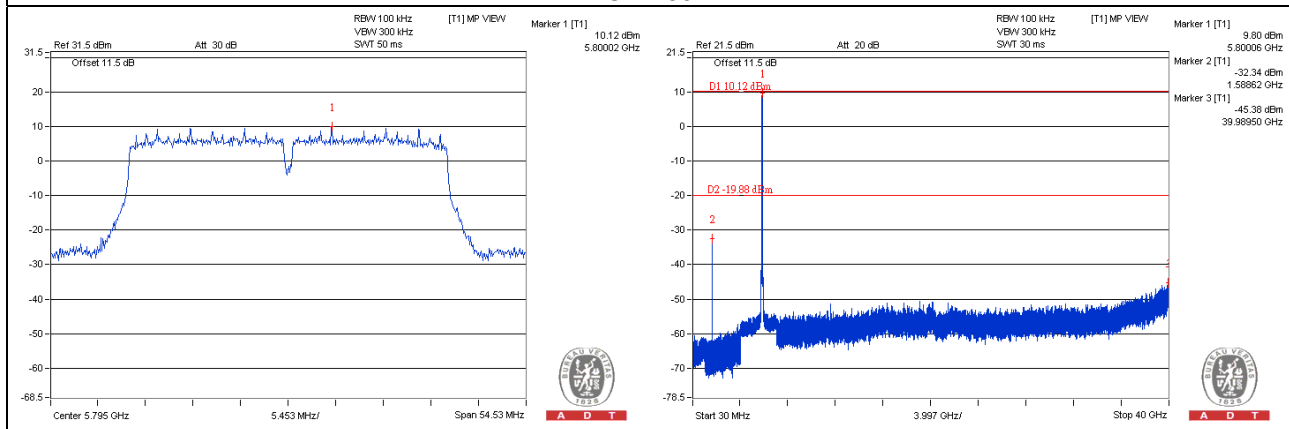

802.11n (40MHz)_Chain 3

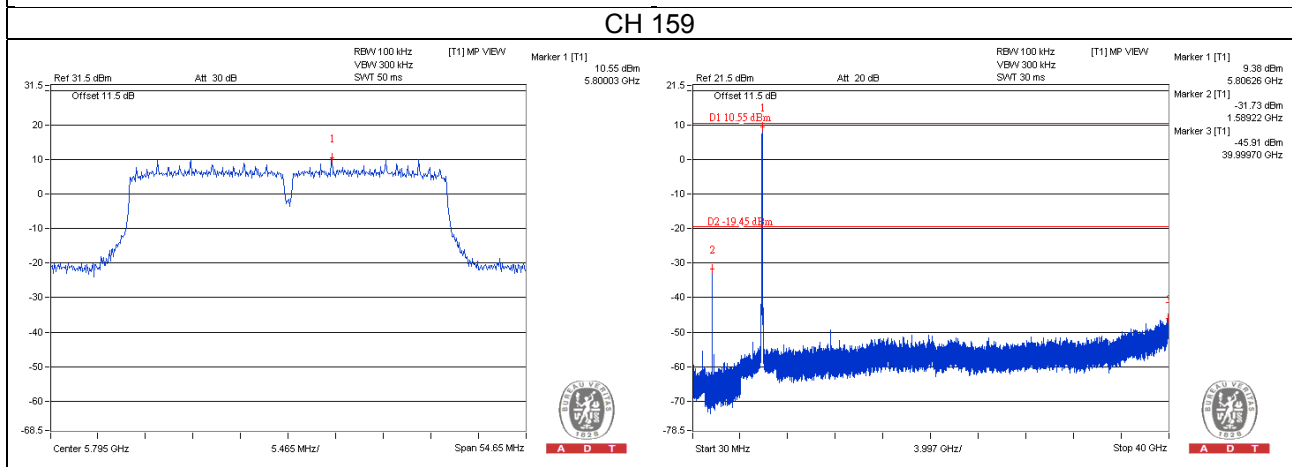
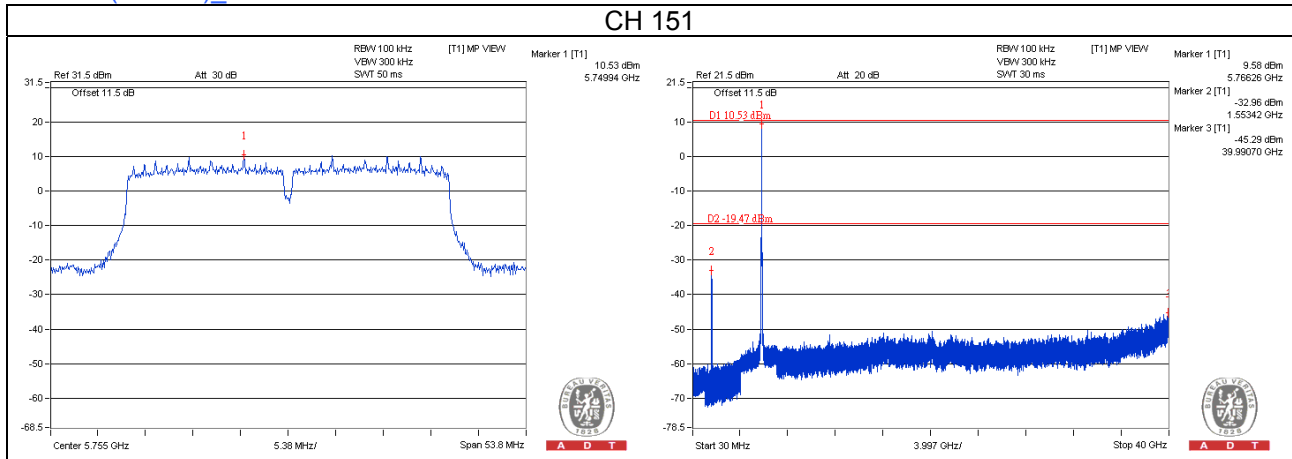

802.11ac (80MHz)_Chain 0

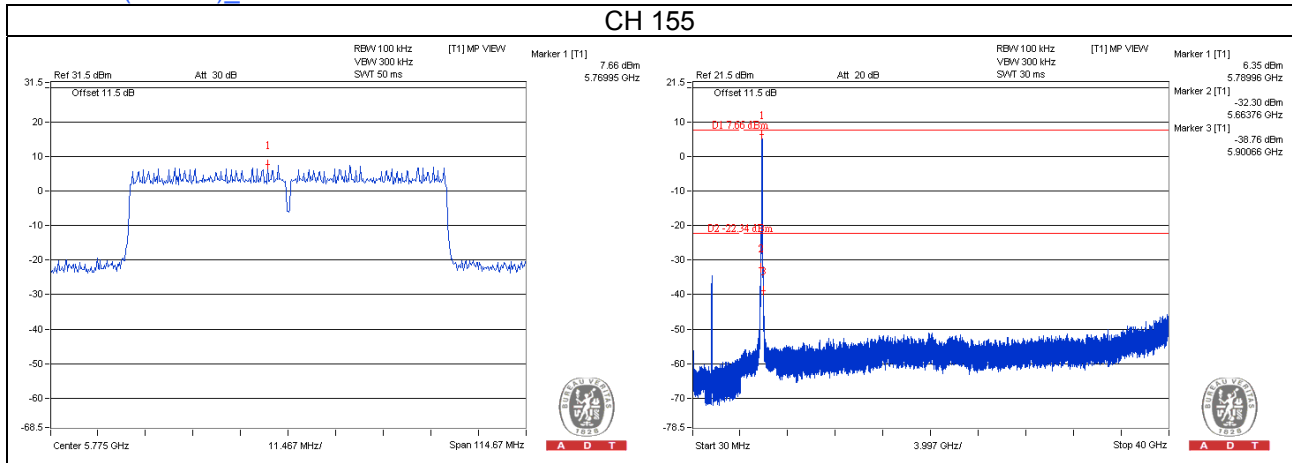

802.11ac (80MHz)_Chain 1

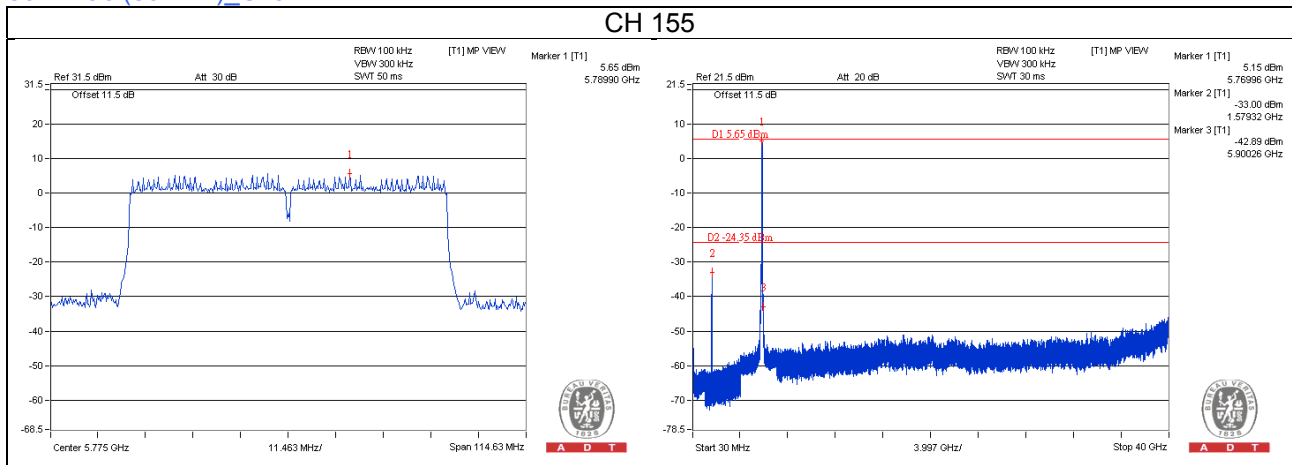

802.11ac (80MHz)_Chain 2

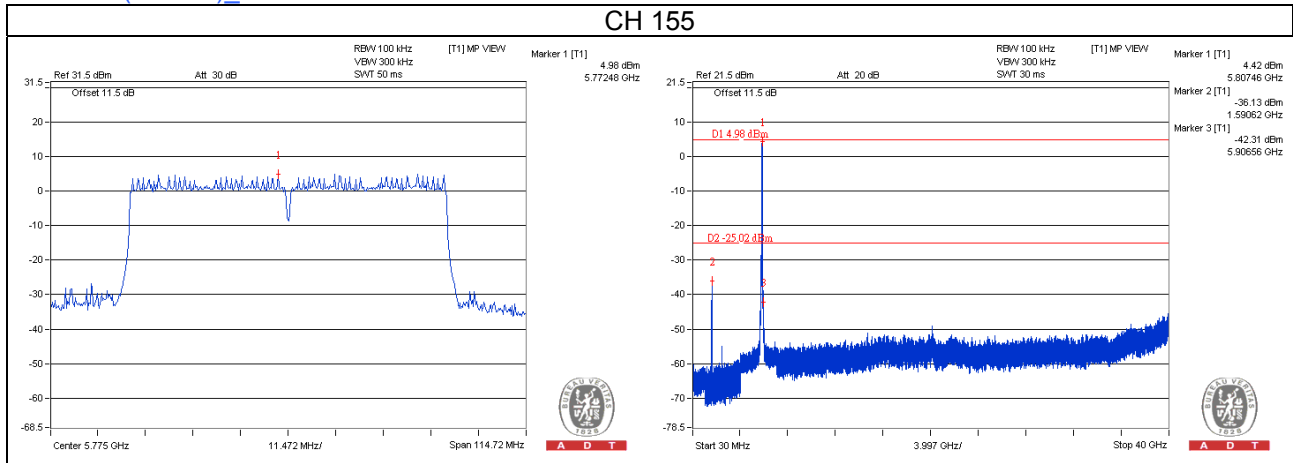

802.11ac (80MHz)_Chain 3

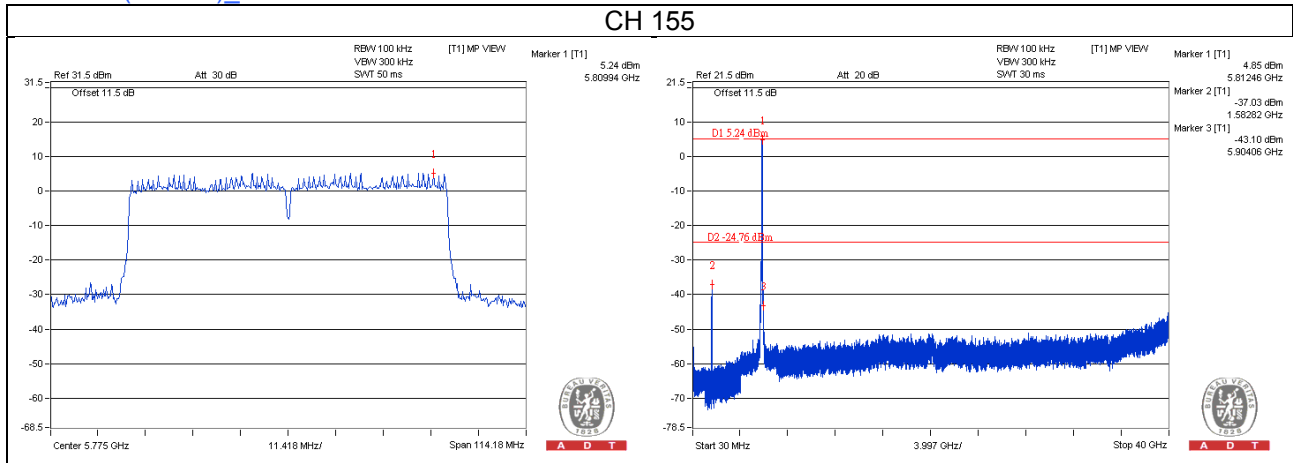

802.11ac (80MHz+80MHz)_Chain 2

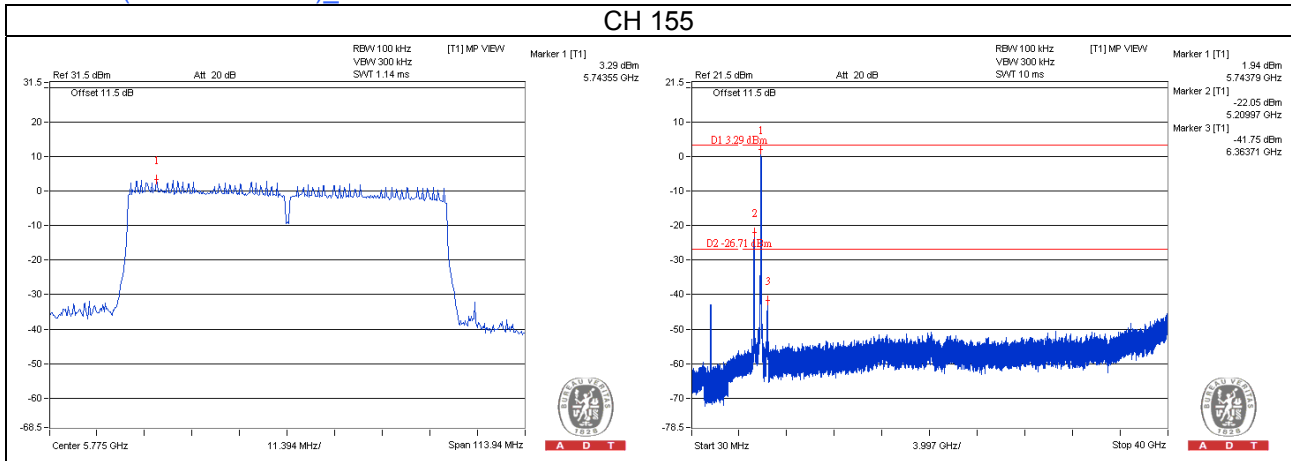

*Marker 2 which higher than D2 was CH42 fundamental frequency should be ignored in this test item.

802.11ac (80MHz+80MHz)_Chain 3

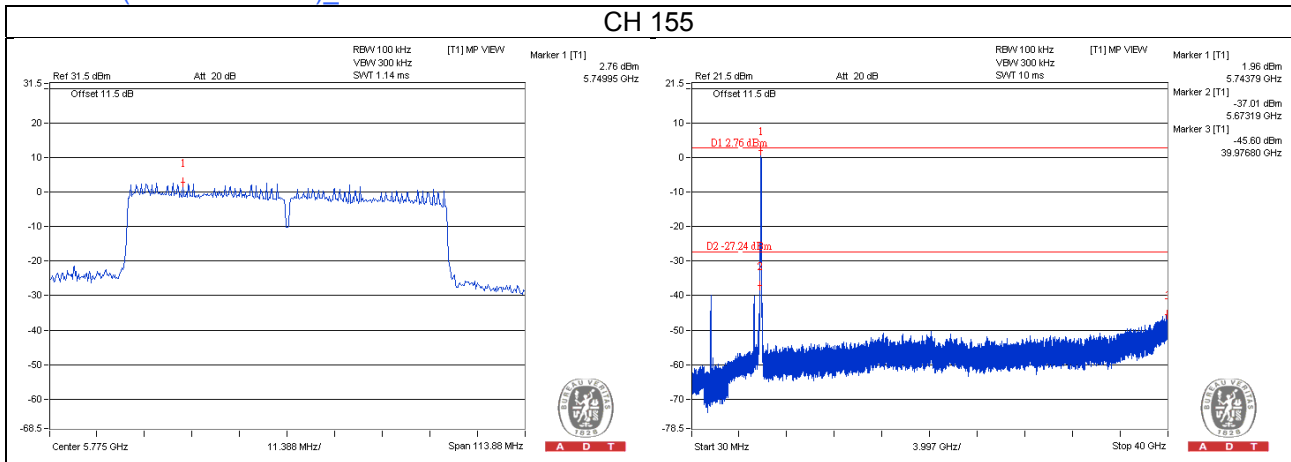

Beamforming_NSS1 Mode 802.11n (20MHz)_Chain 0

CH 149

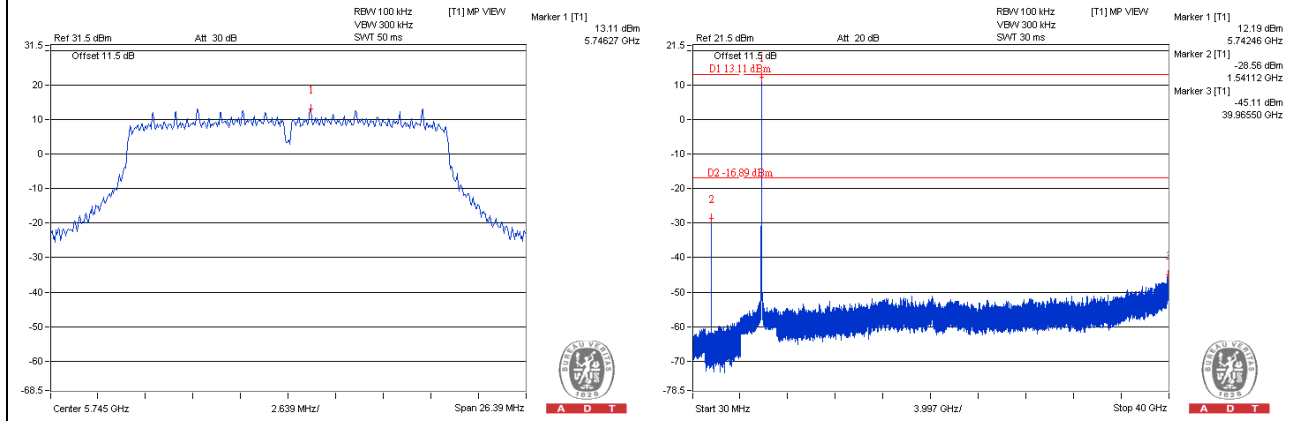

CH 157

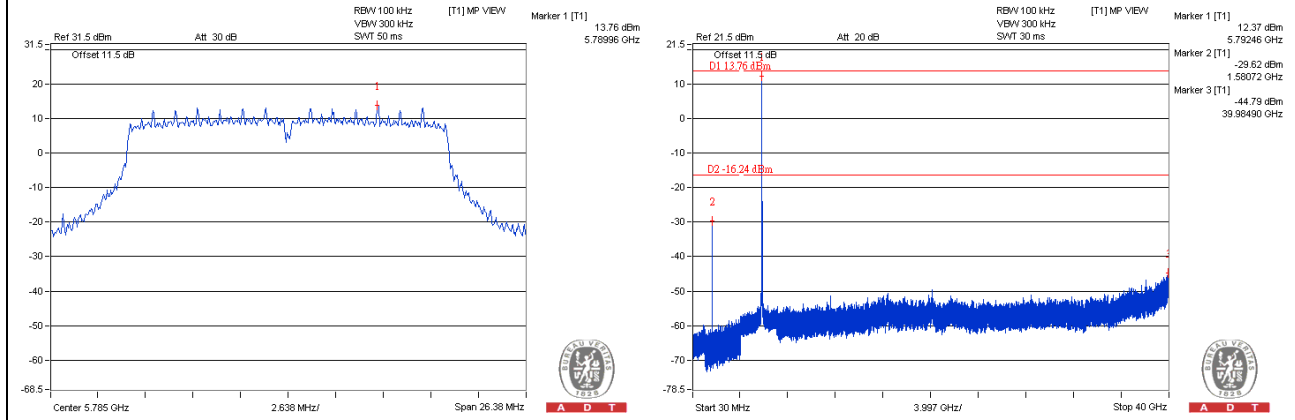

CH 165

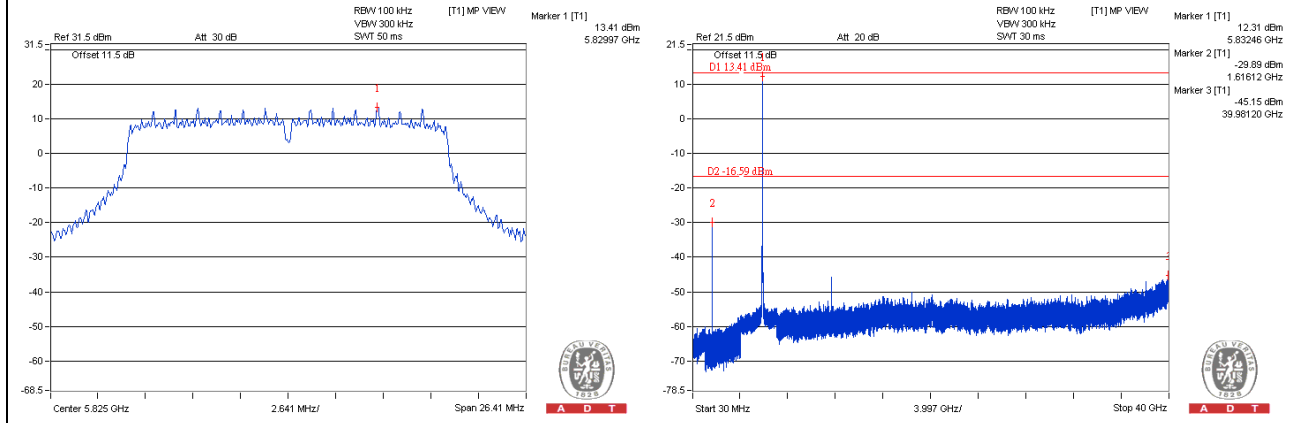

802.11n (20MHz)_Chain 1

CH 149

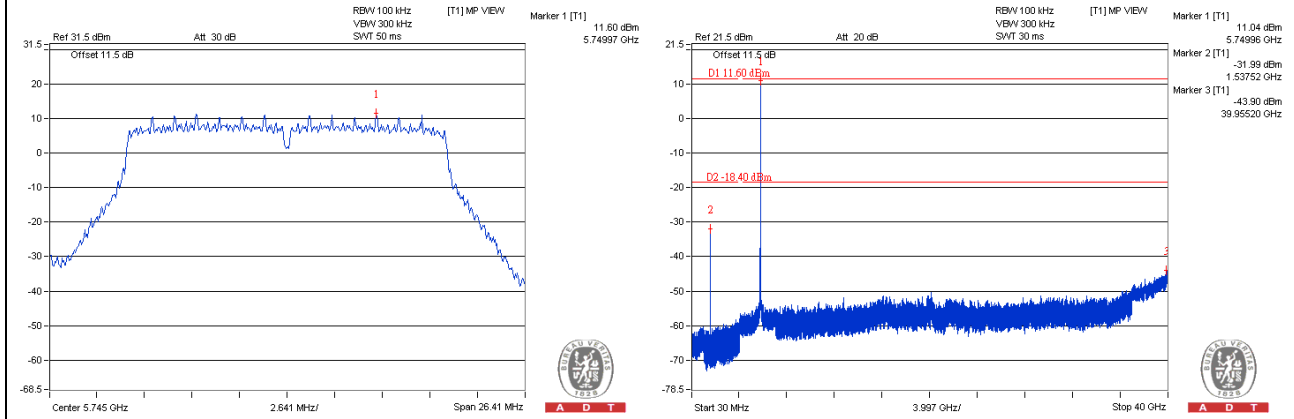

CH 157

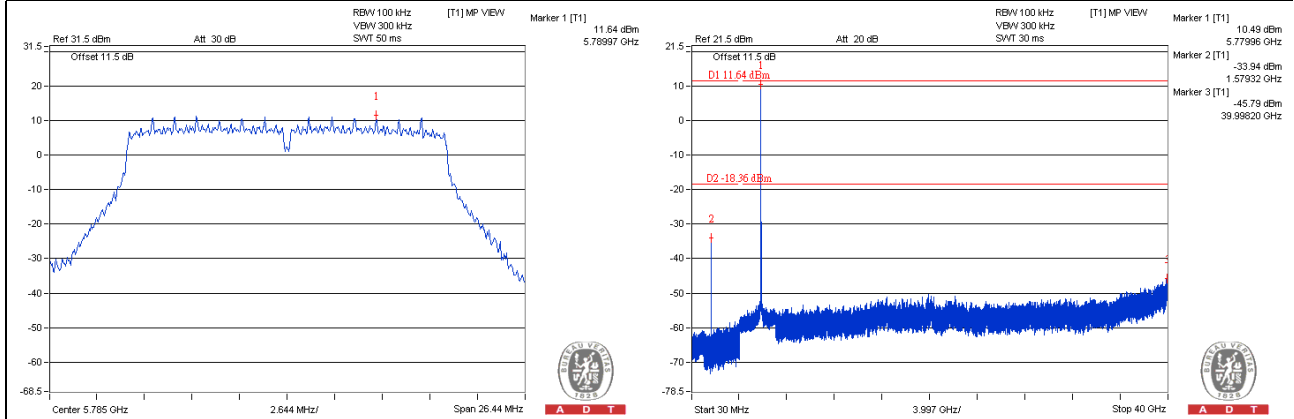

CH 165

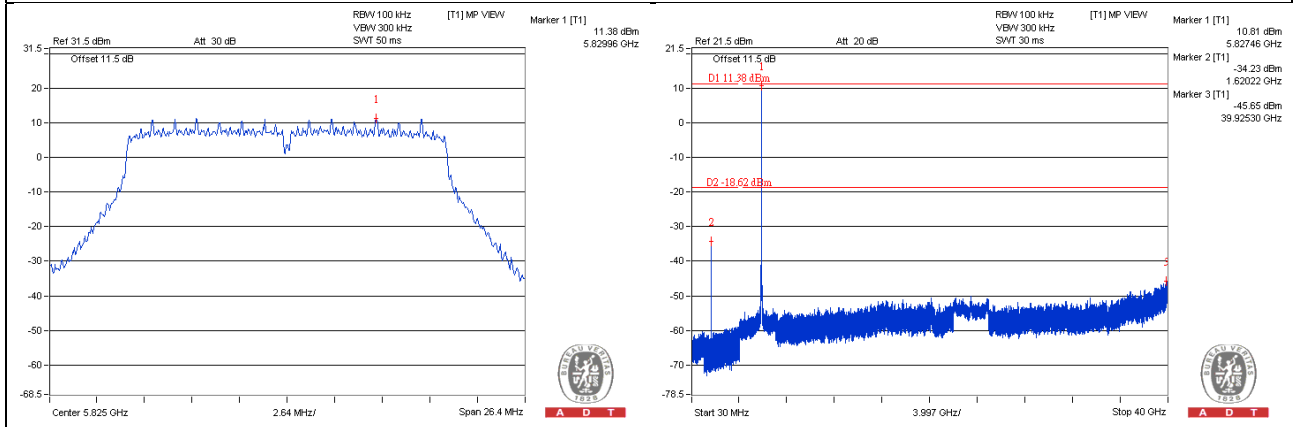

802.11n (20MHz)_Chain 2

CH 149

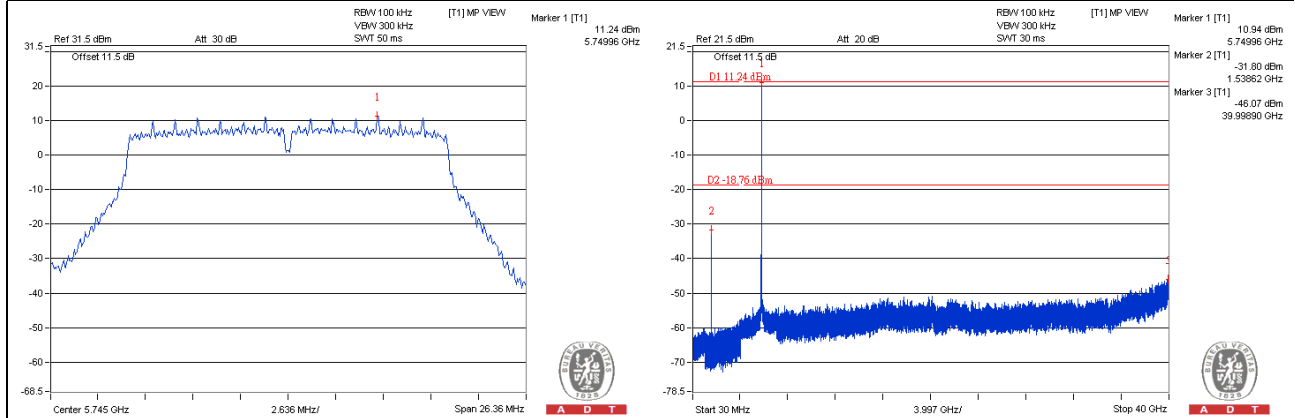

CH 157

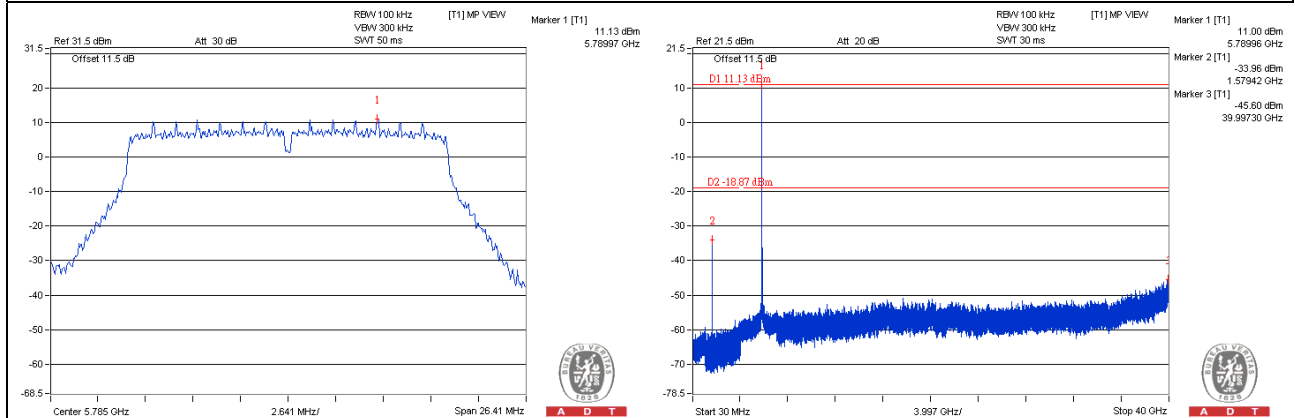

CH 165

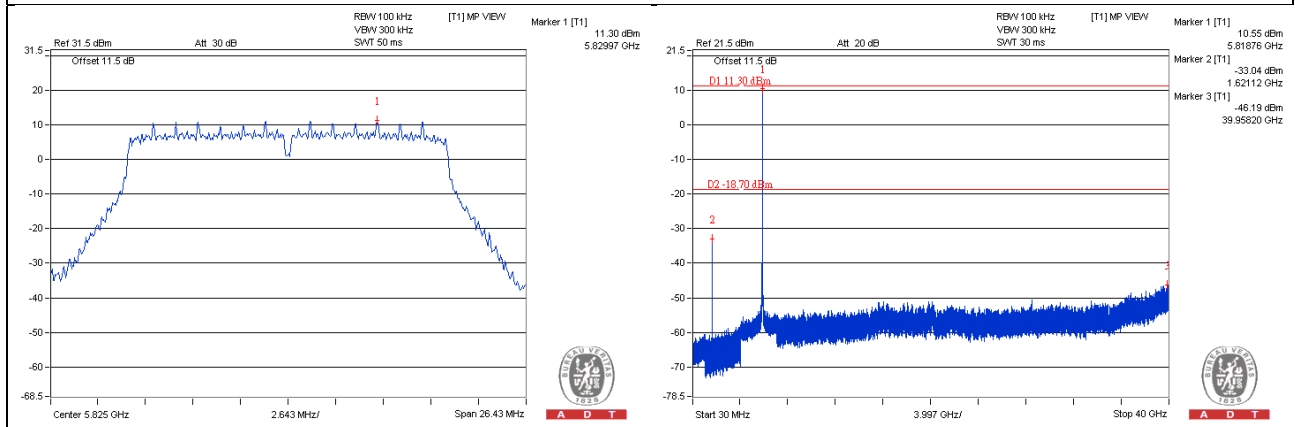

802.11n (20MHz)_Chain 3

CH 149

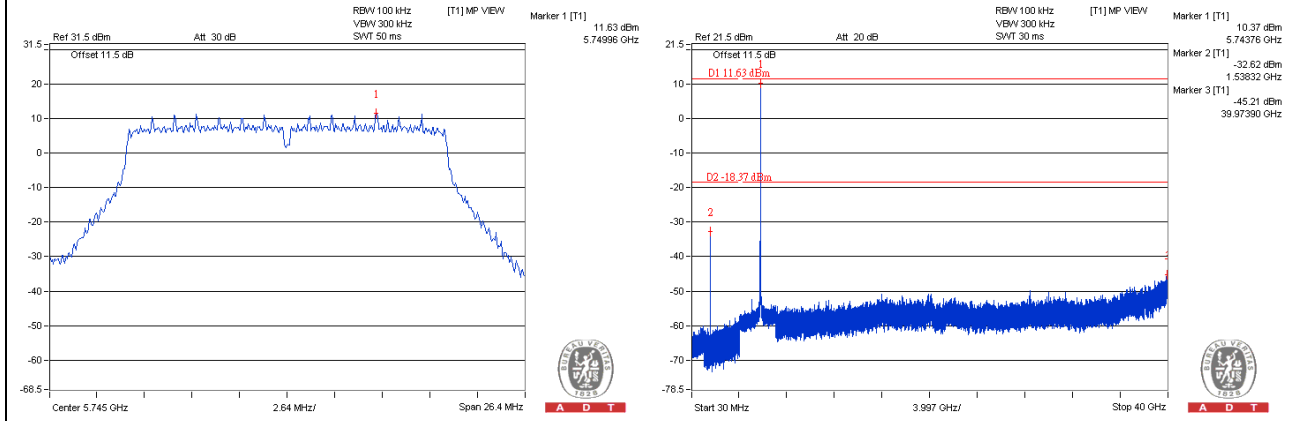

CH 157

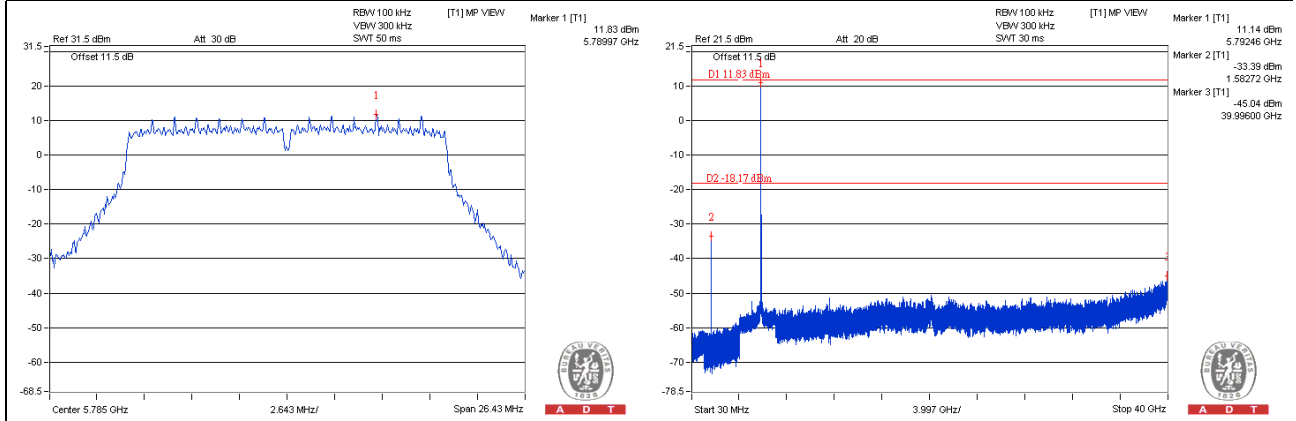

CH 165

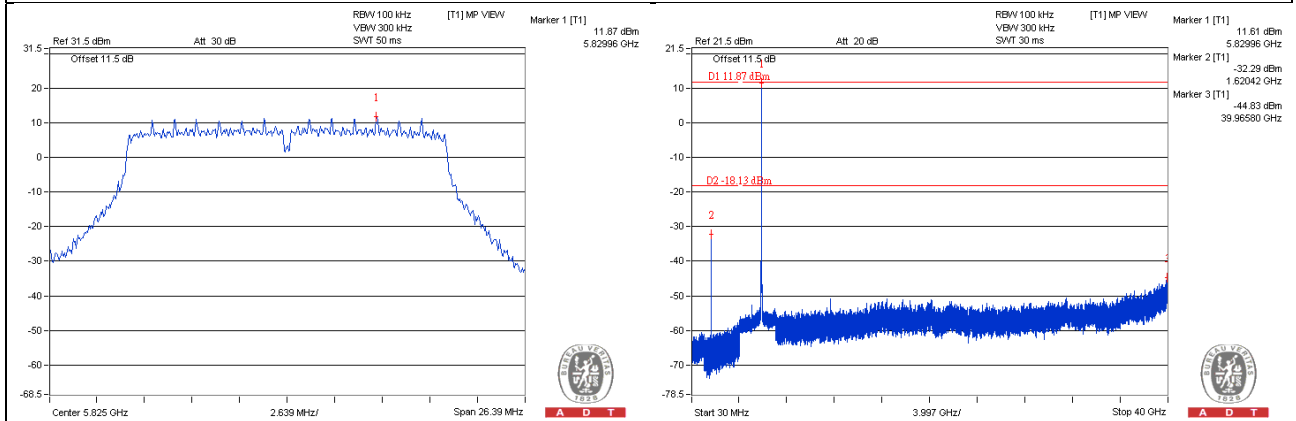

802.11n (40MHz)_Chain 0

CH 151

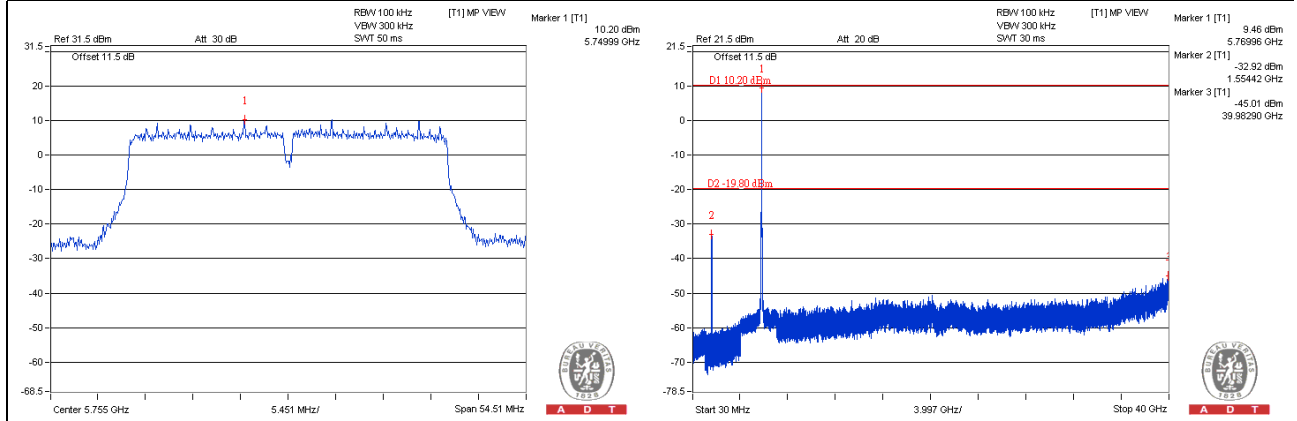

CH 159

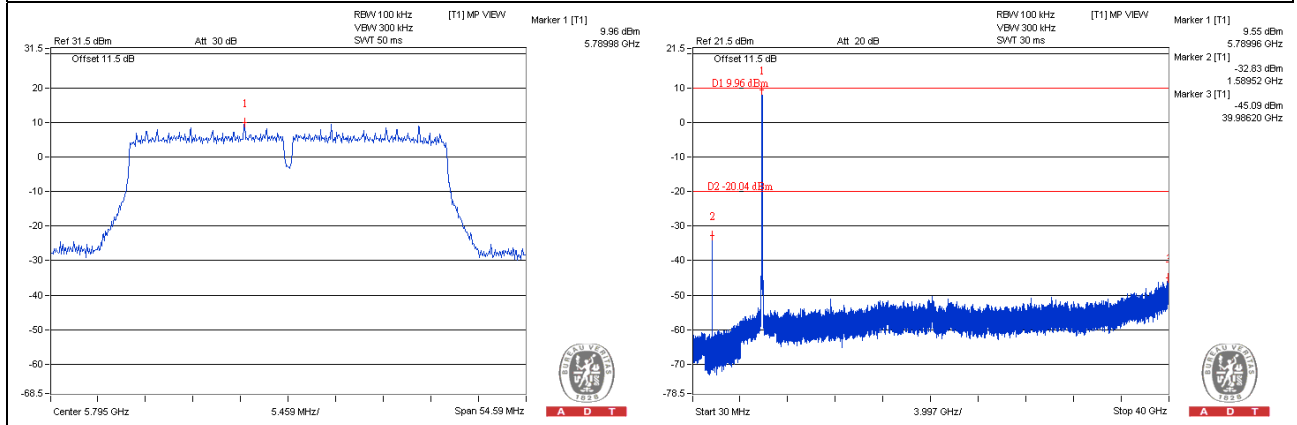

802.11n (40MHz)_Chain 1

CH 151

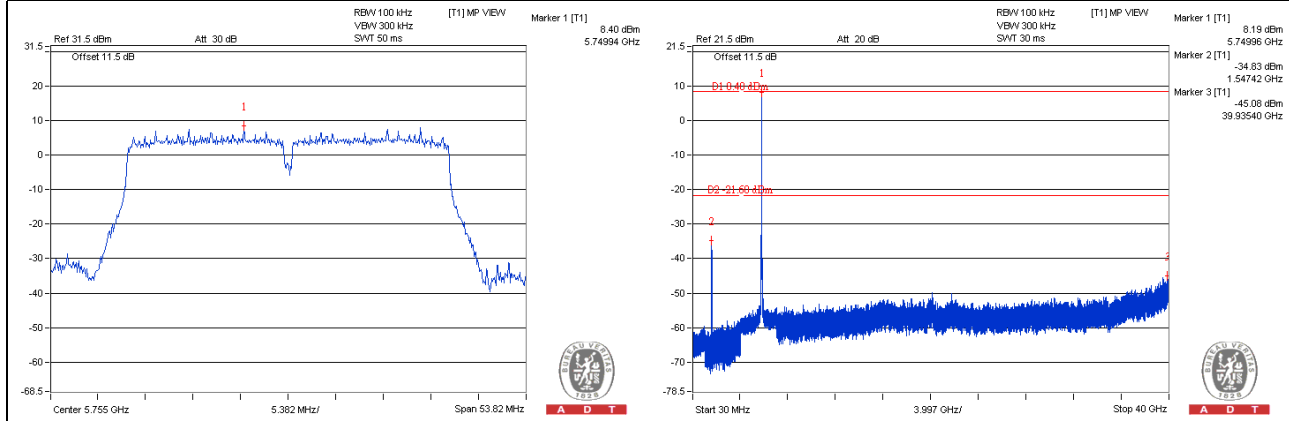

CH 159

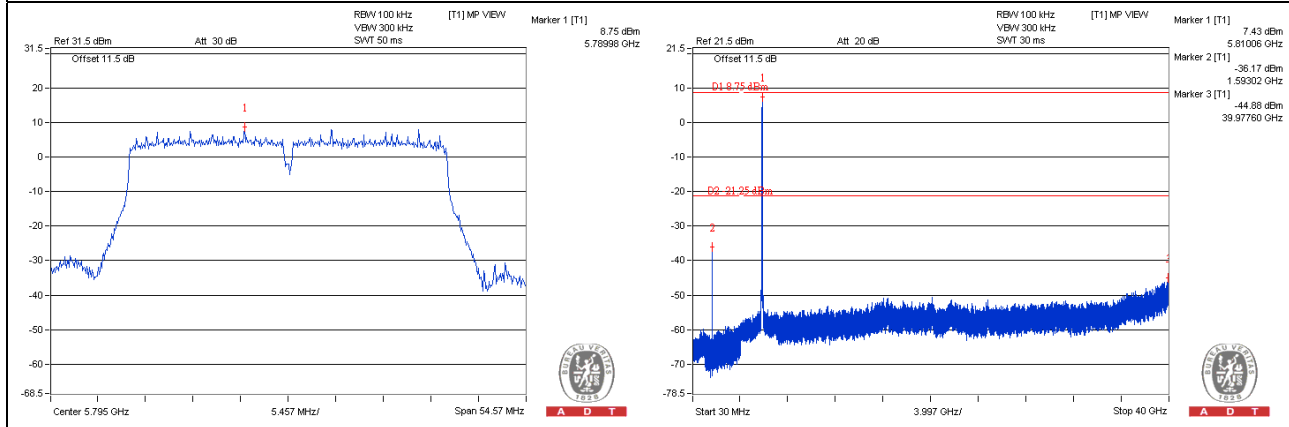

802.11n (40MHz)_Chain 2

CH 151

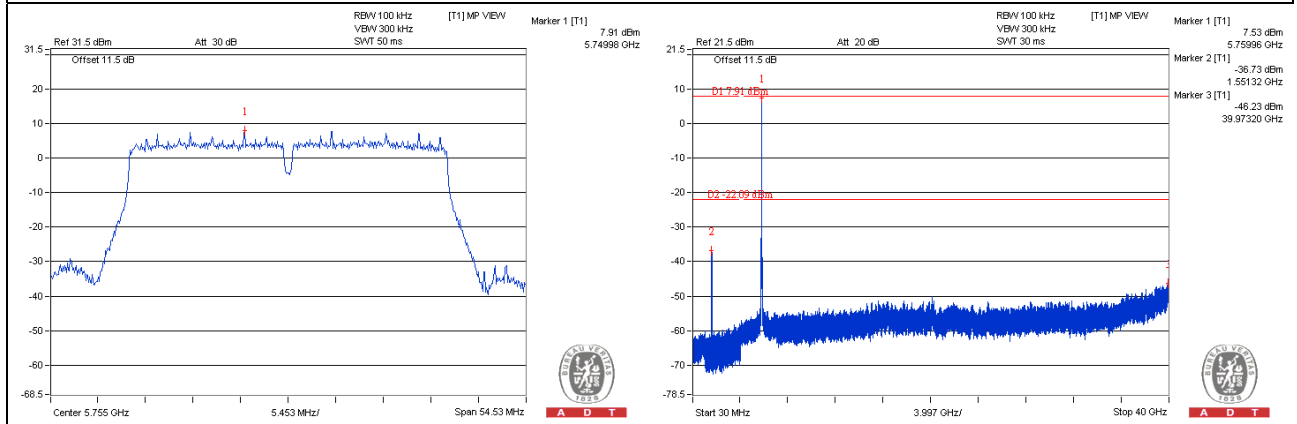

CH 159

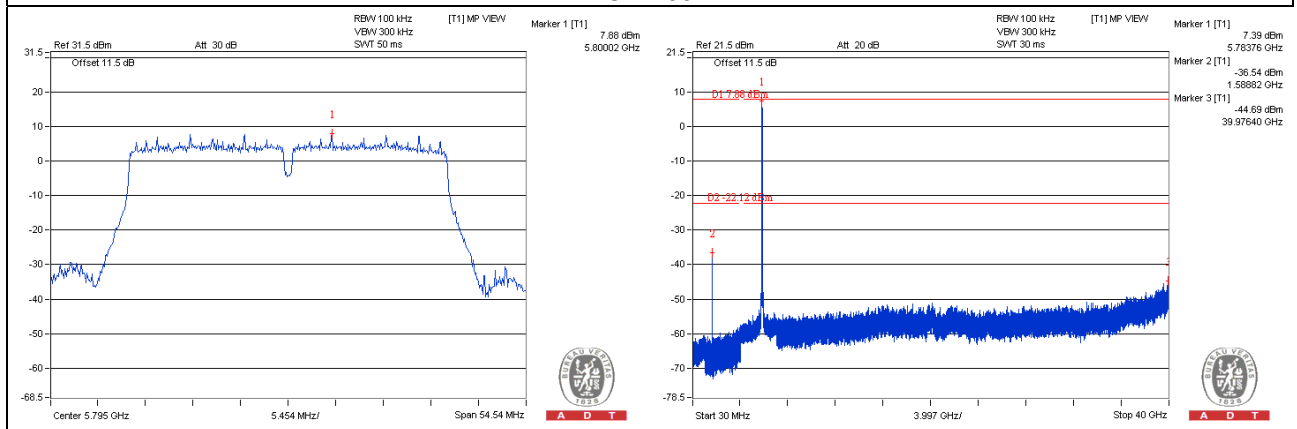

802.11n (40MHz)_Chain 3

CH 151

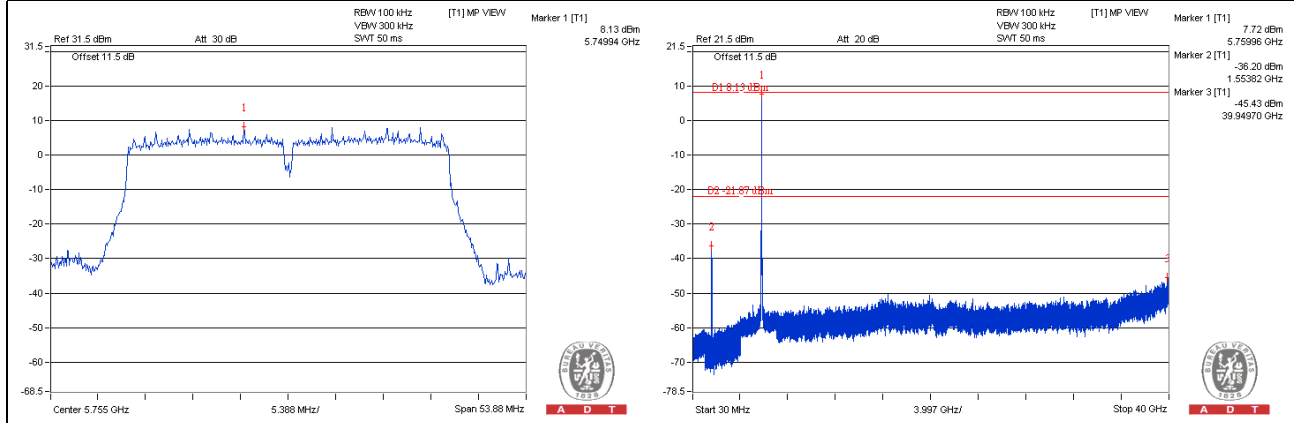

CH 159

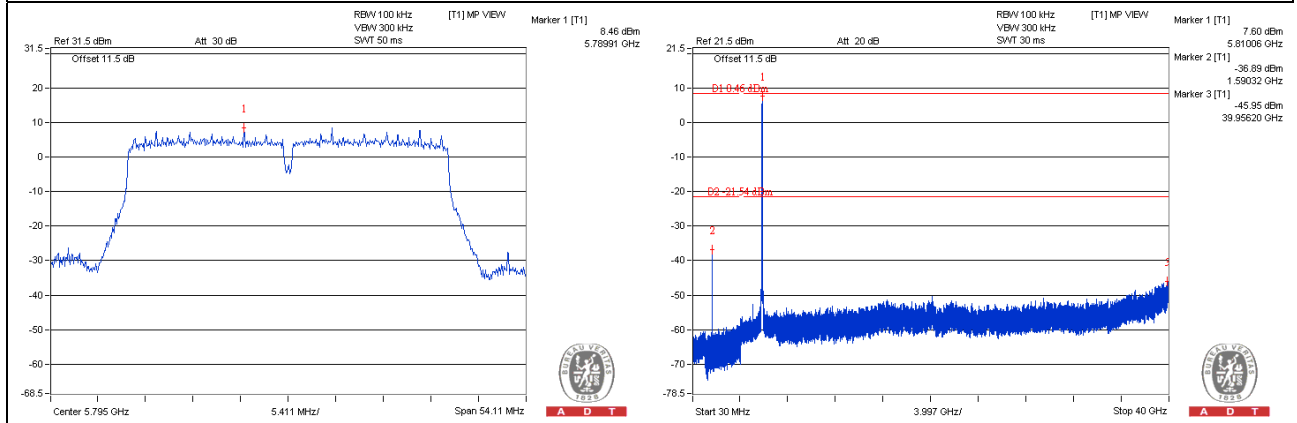

802.11ac (80MHz)_Chain 0

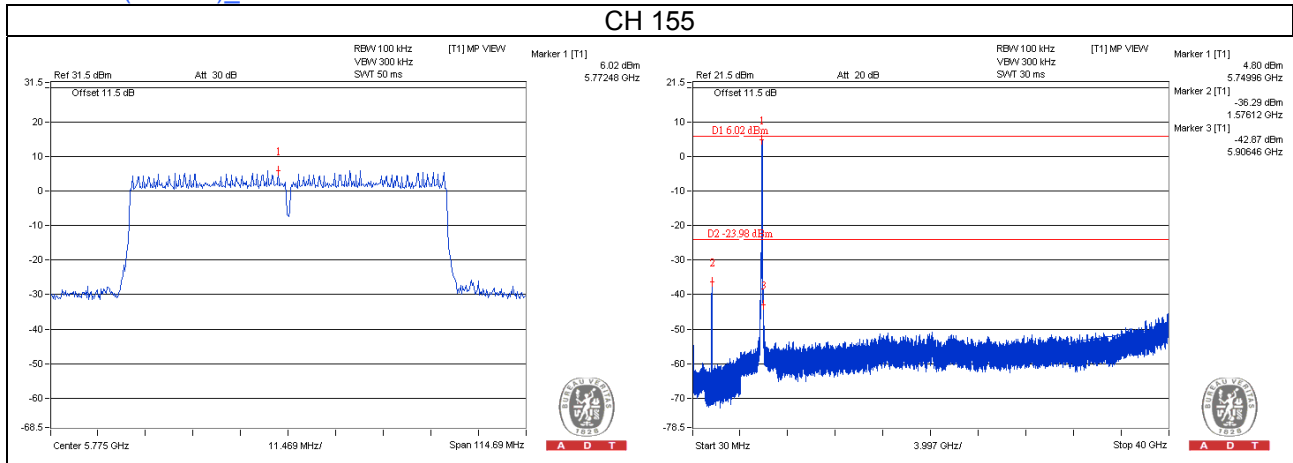

802.11ac (80MHz)_Chain 1

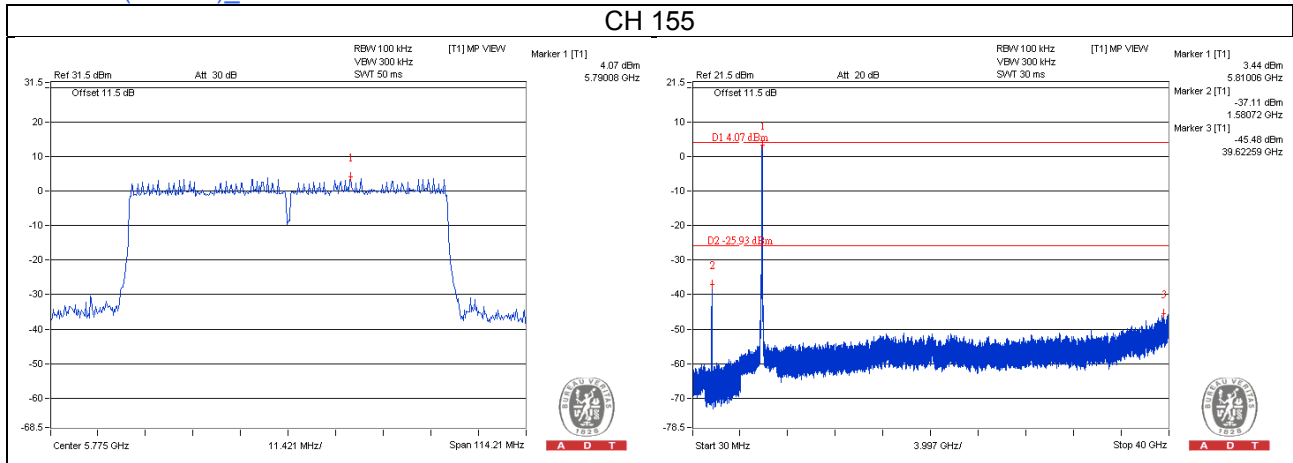

802.11ac (80MHz)_Chain 2

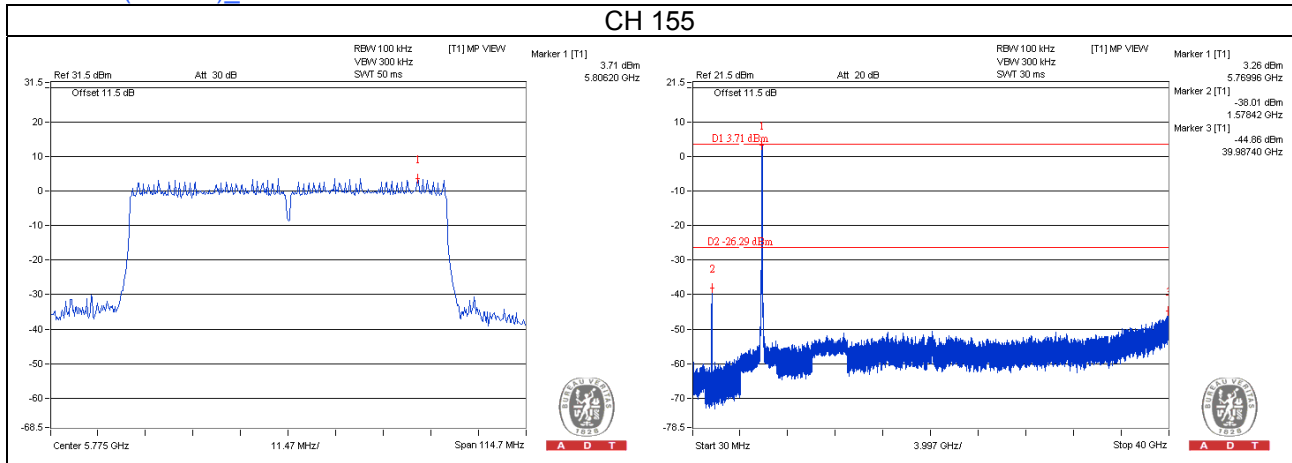

802.11ac (80MHz)_Chain 3

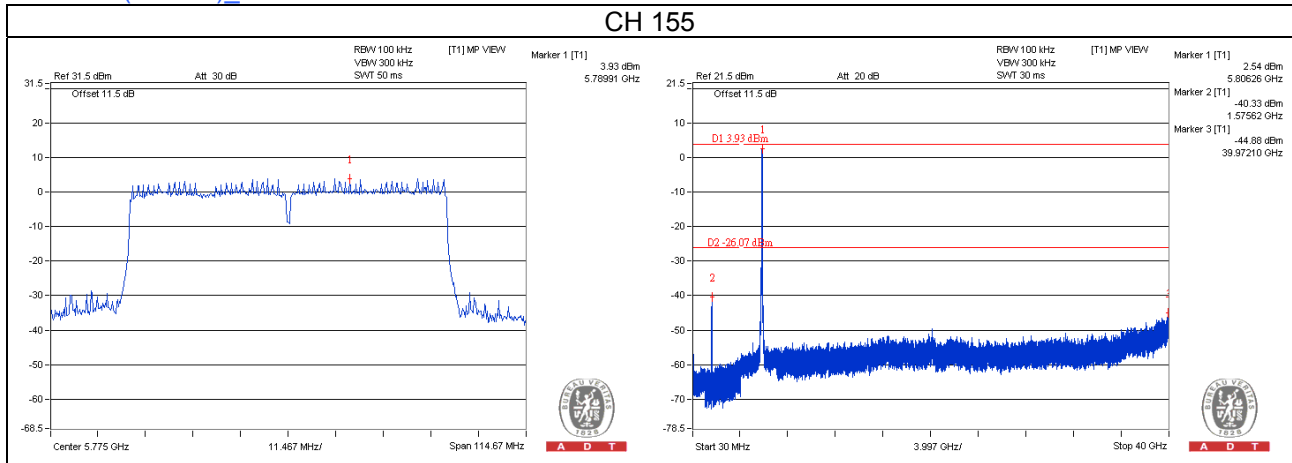

802.11ac (80MHz+80MHz)_Chain 2

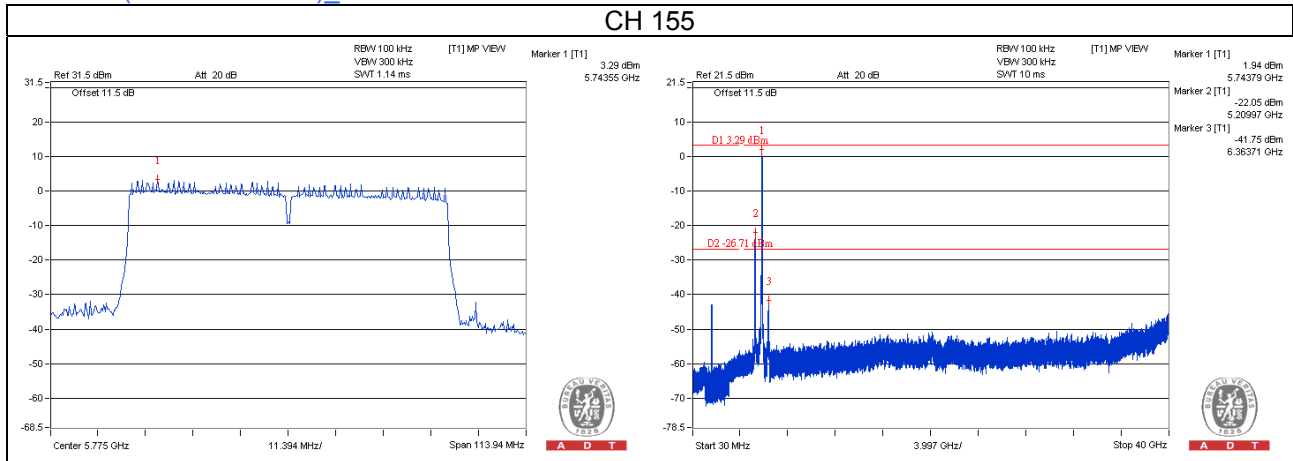

*Marker 2 which higher than D2 was CH42 fundamental frequency should be ignored in this test item.

802.11ac (80MHz+80MHz)_Chain 3

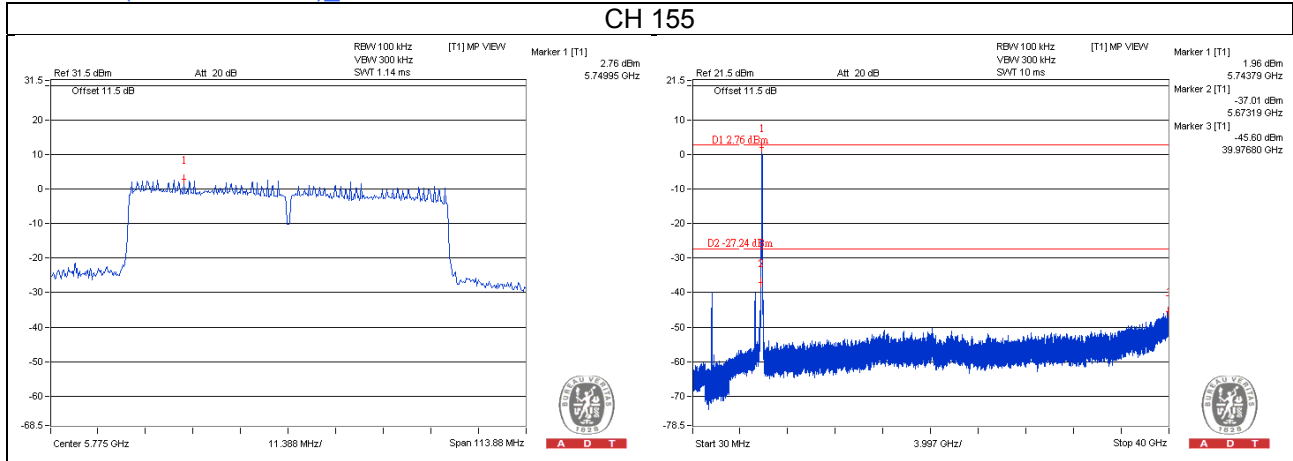

Beamforming_NSS2 Mode 802.11n (20MHz)_Chain 0

CH 149

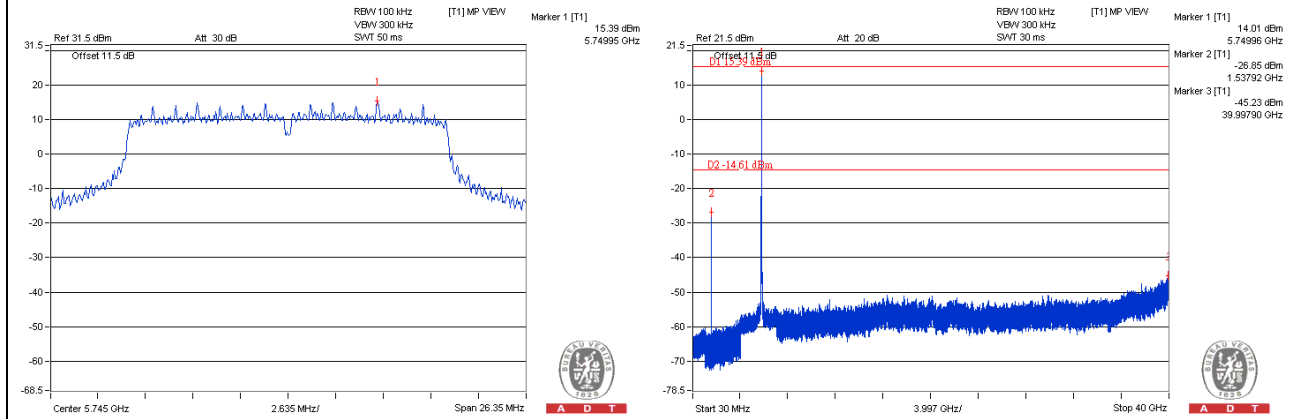

CH 157

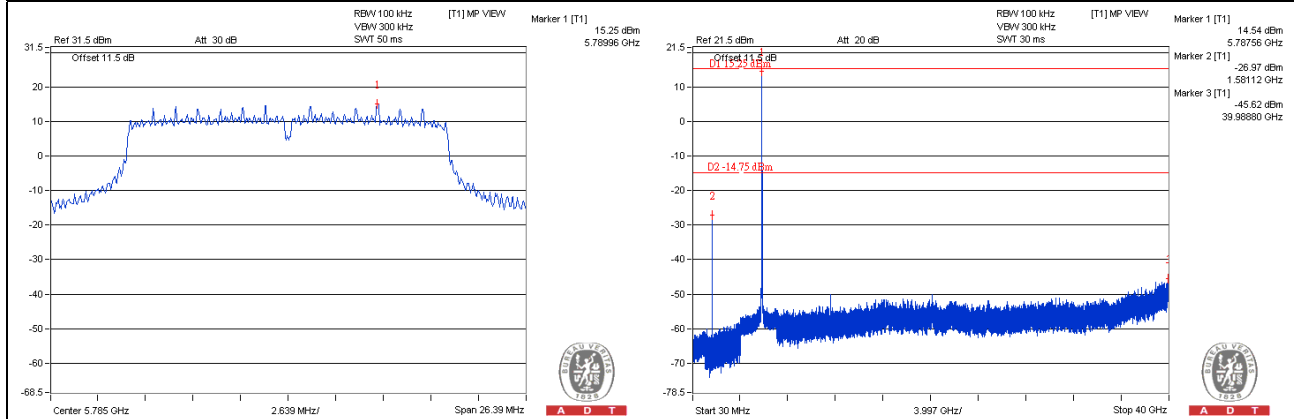

CH 165

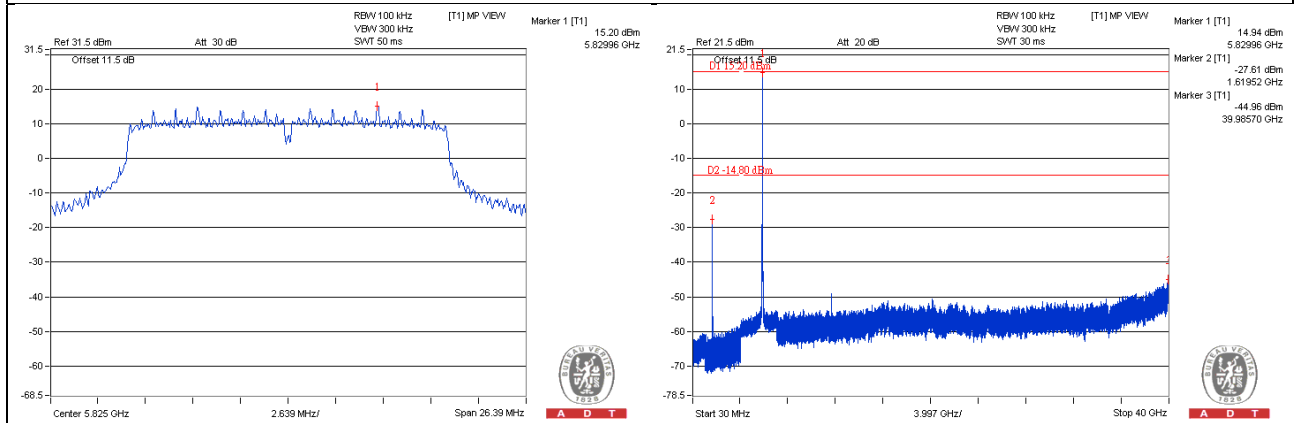

802.11n (20MHz)_Chain 1

CH 149

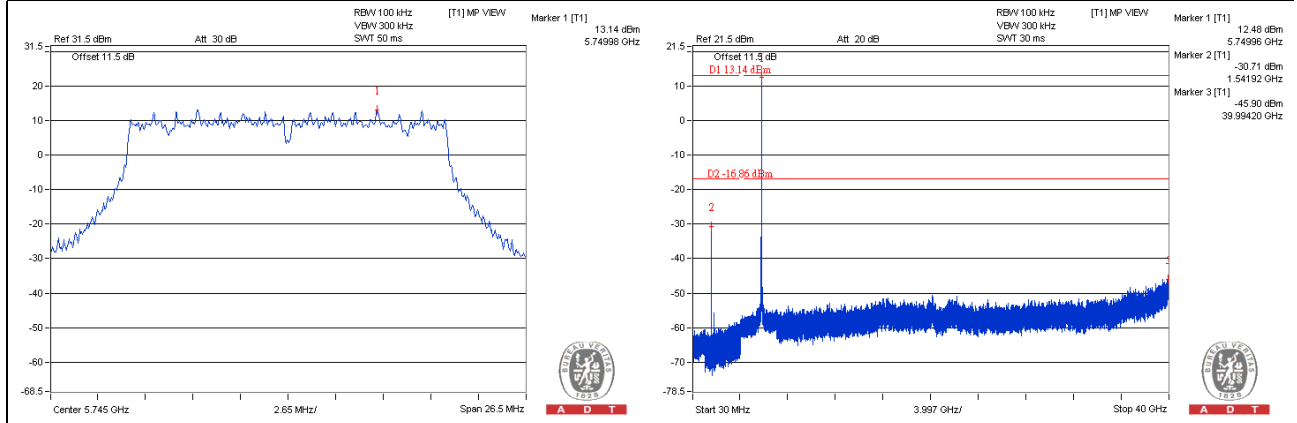

CH 157

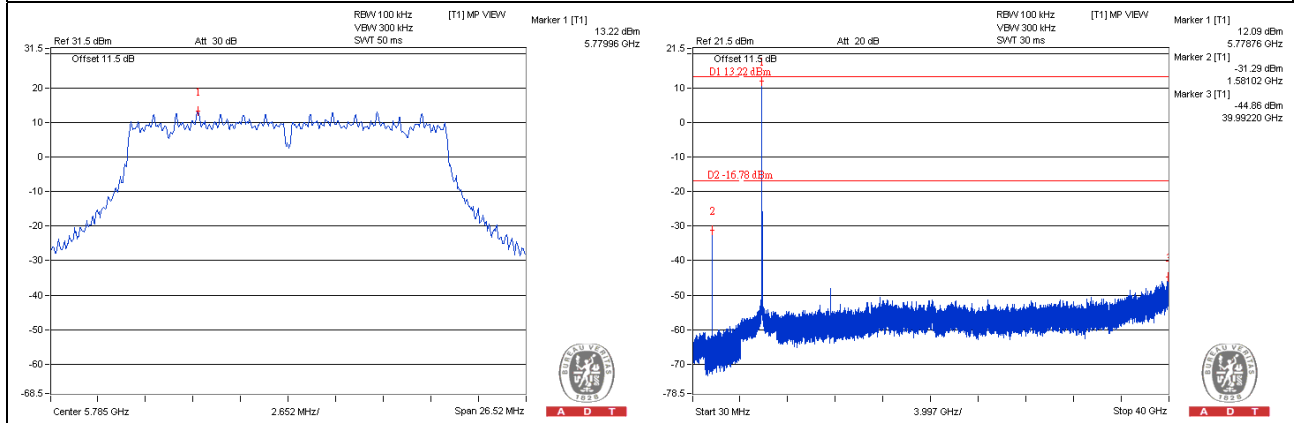

CH 165

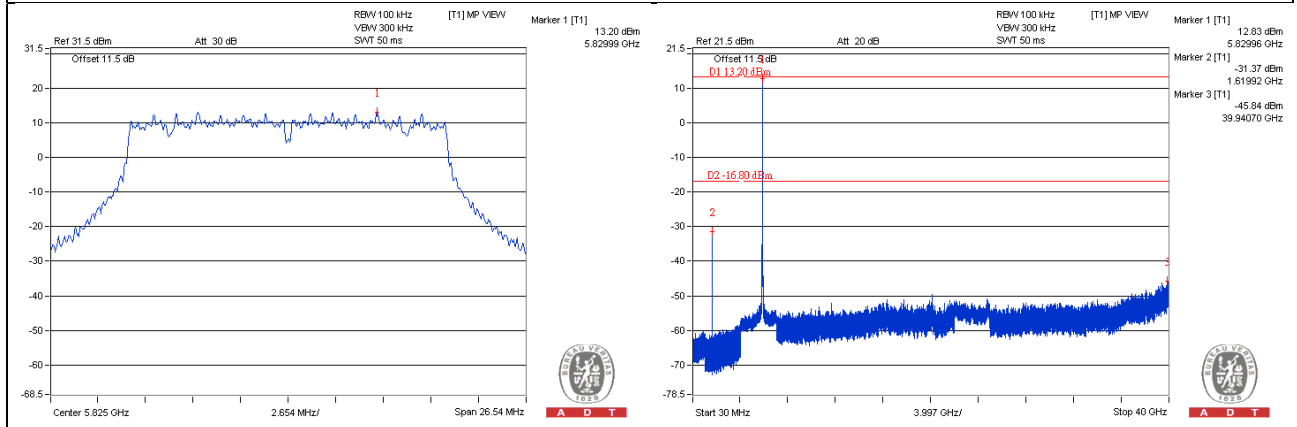

802.11n (20MHz)_Chain 2

CH 149

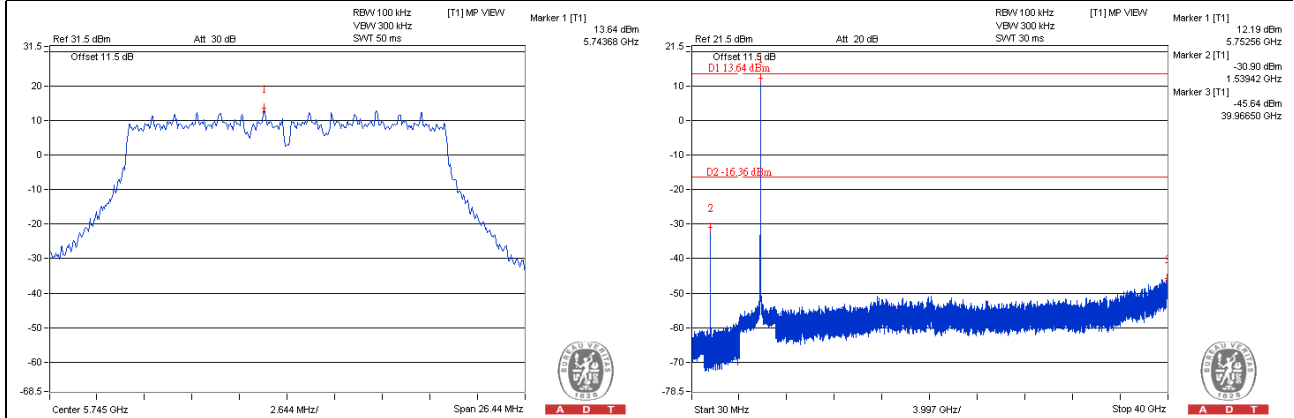

CH 157

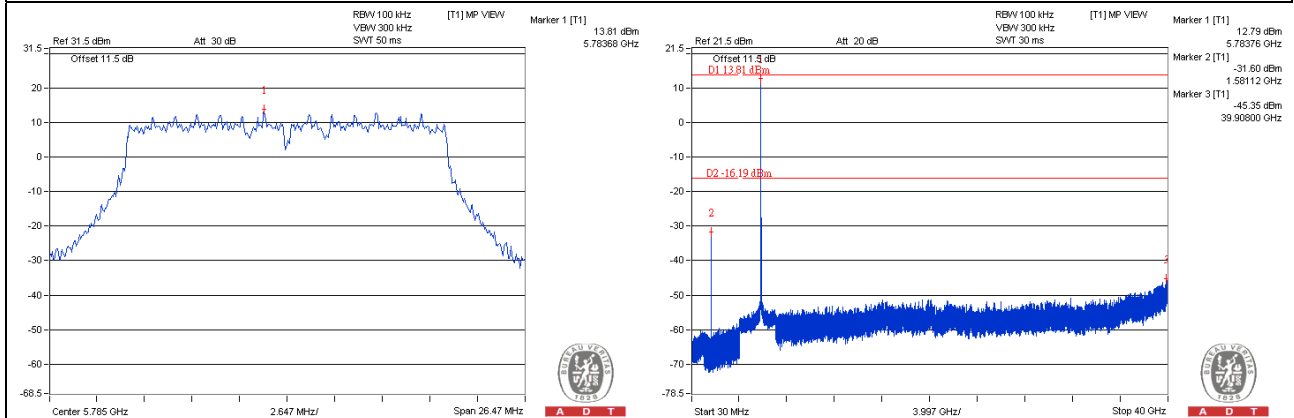

CH 165

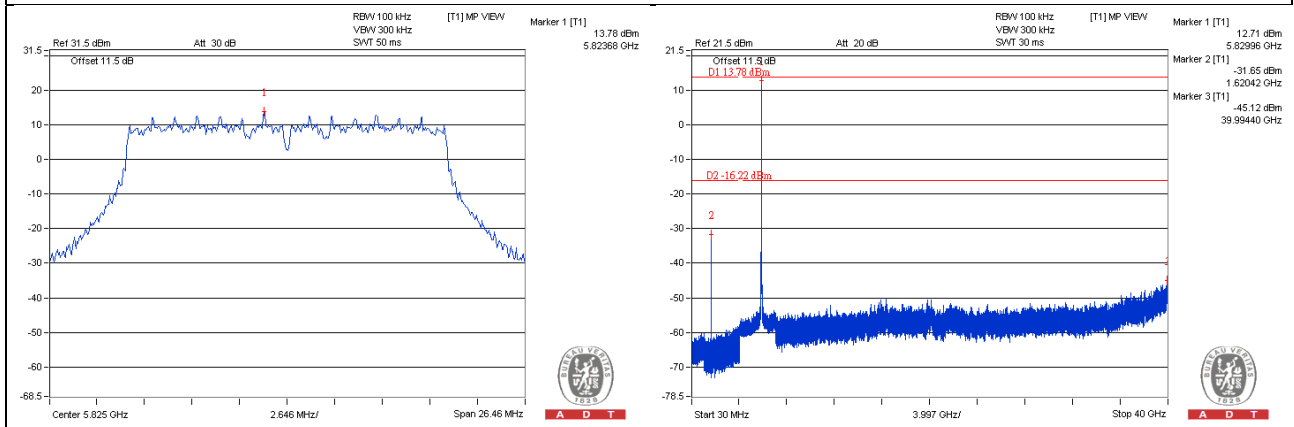



A D T

802.11n (20MHz)_Chain 3

CH 149

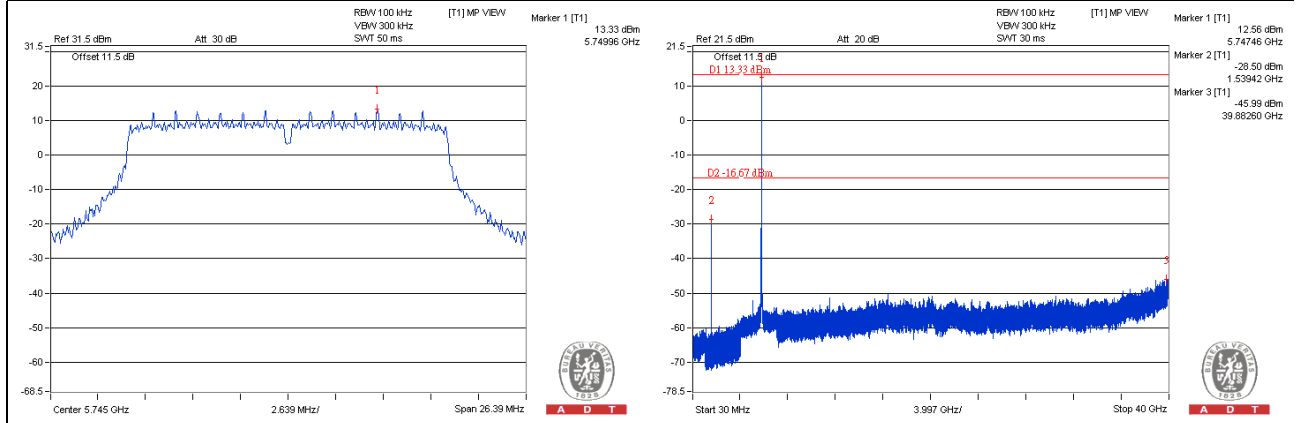

CH 157

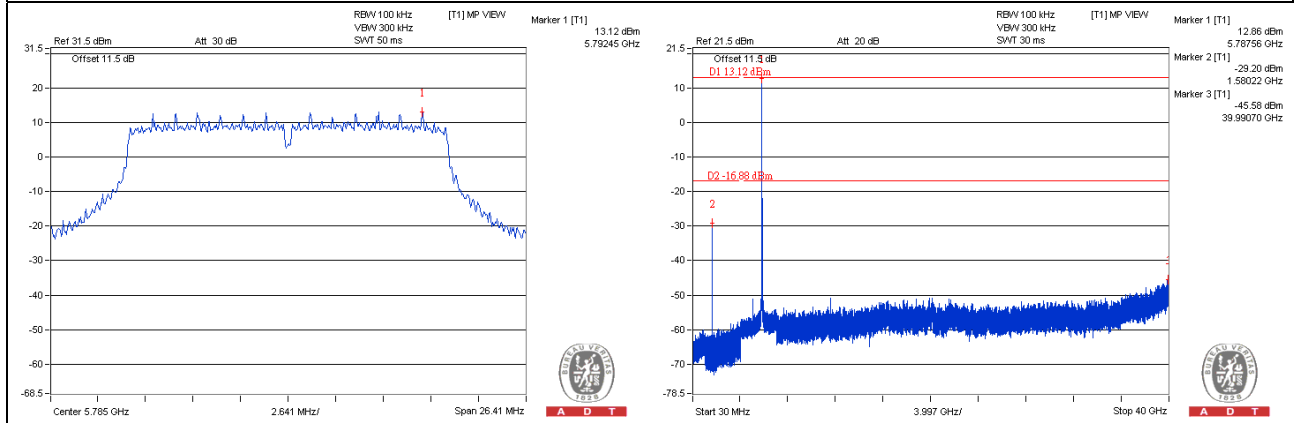

CH 165

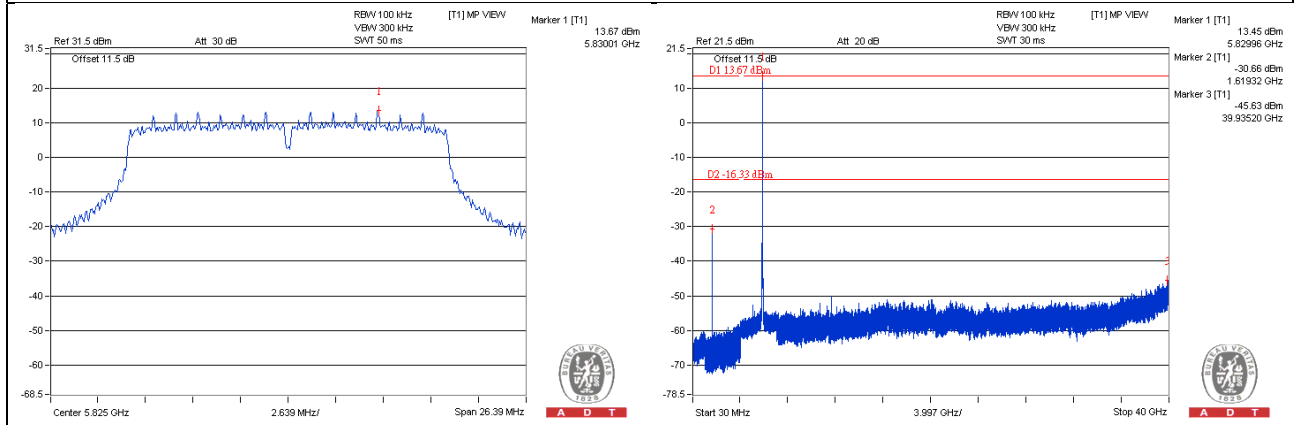



A D T

802.11n (40MHz)_Chain 0

CH 151

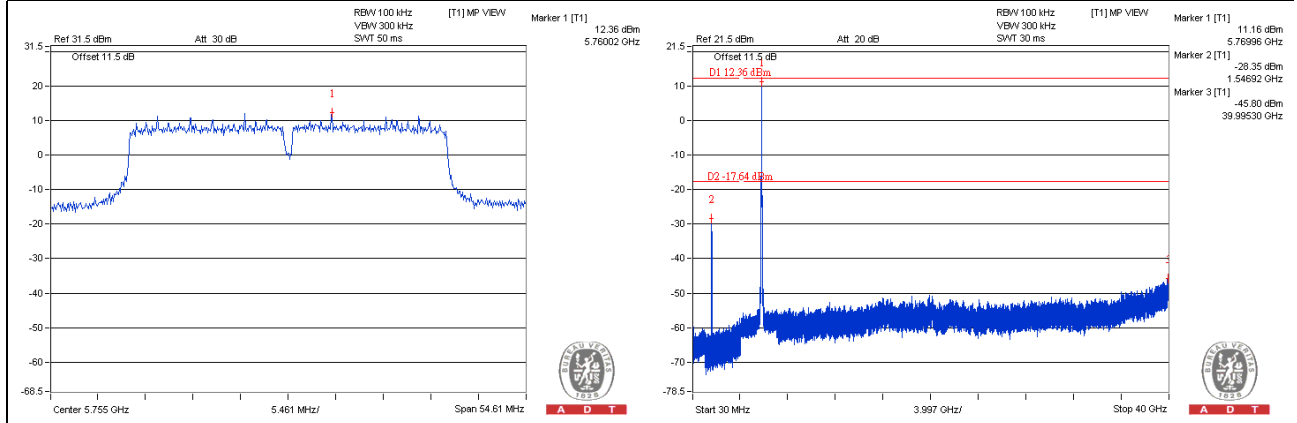

CH 159

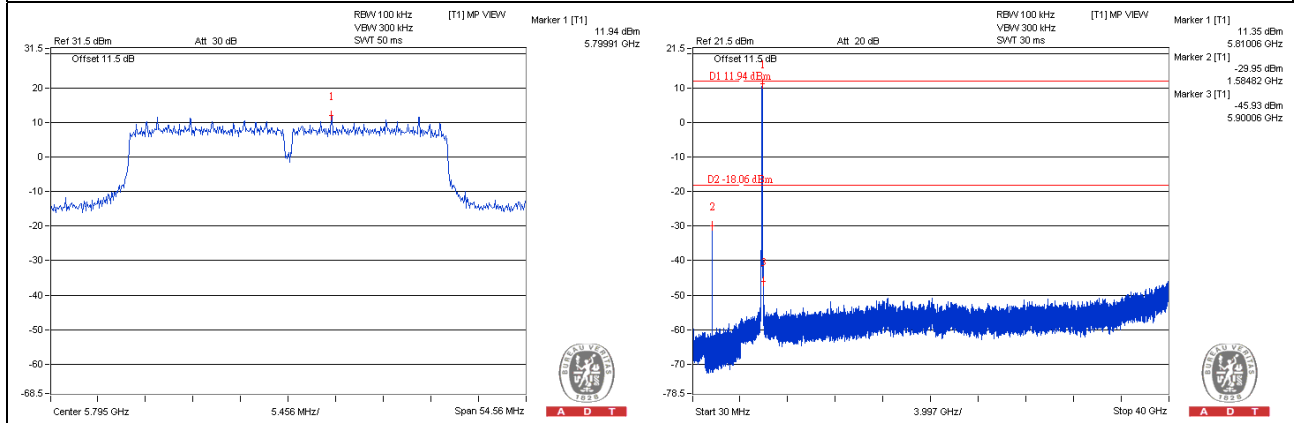

802.11n (40MHz)_Chain 1

CH 151

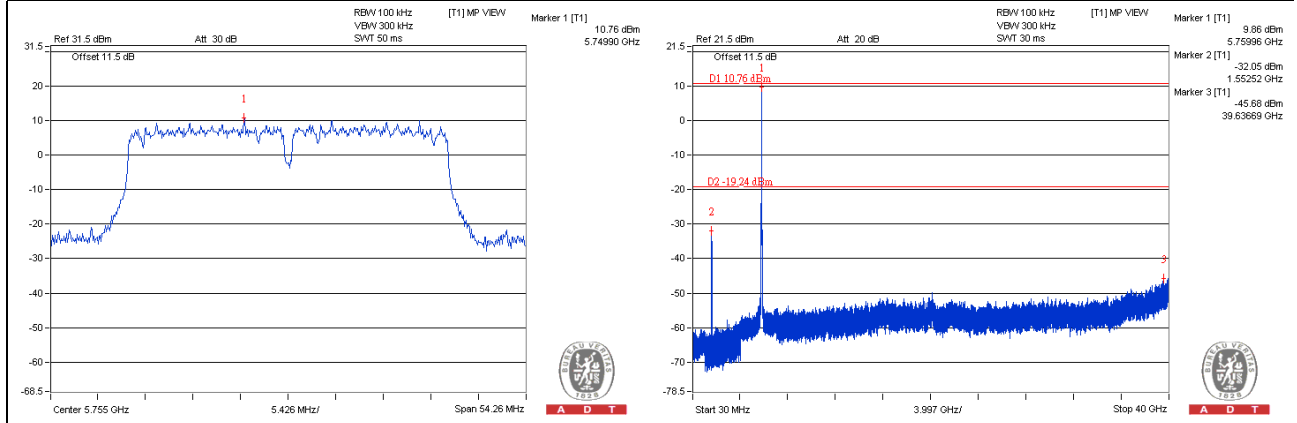

CH 159

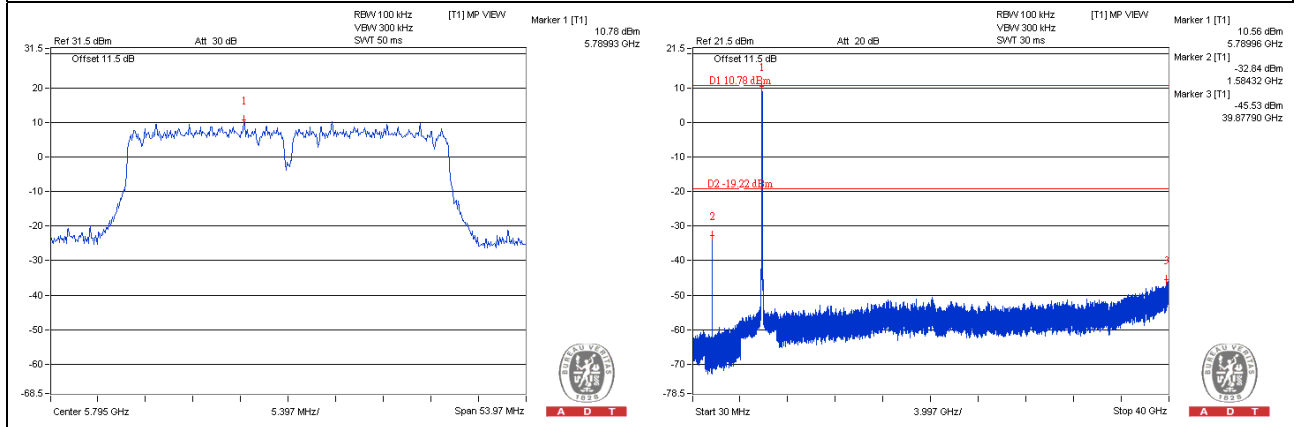

802.11n (40MHz)_Chain 2

CH 151

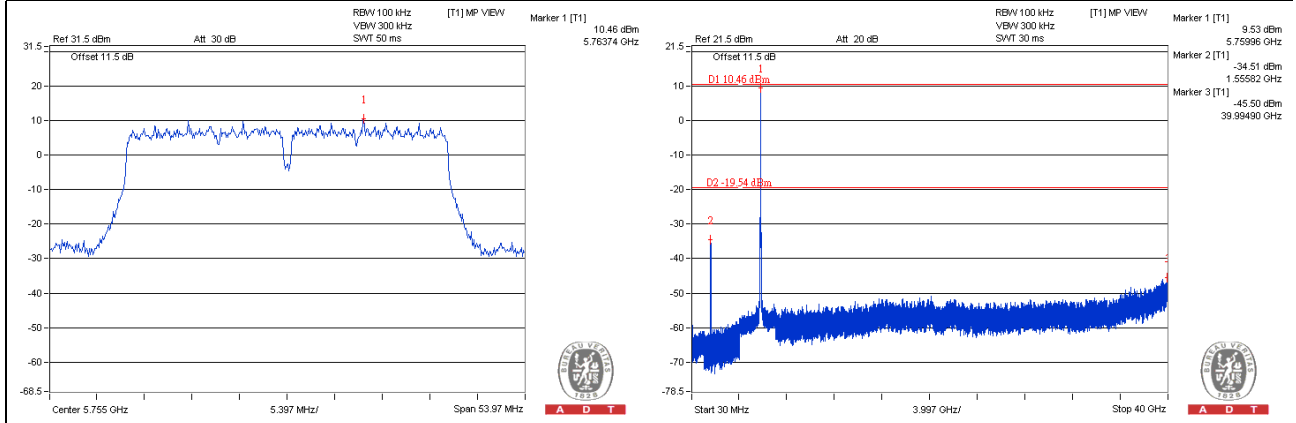

CH 159

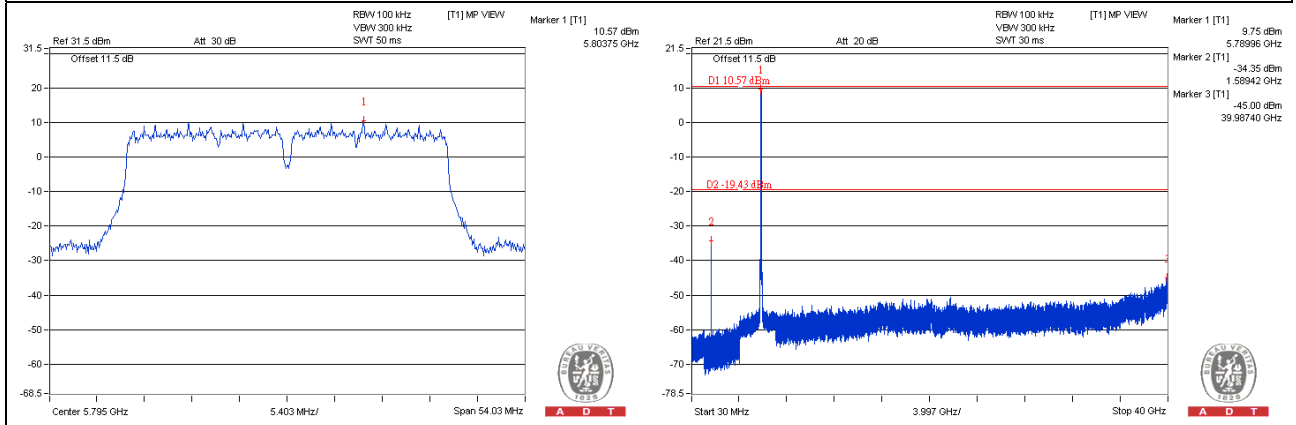

802.11n (40MHz)_Chain 3

CH 151

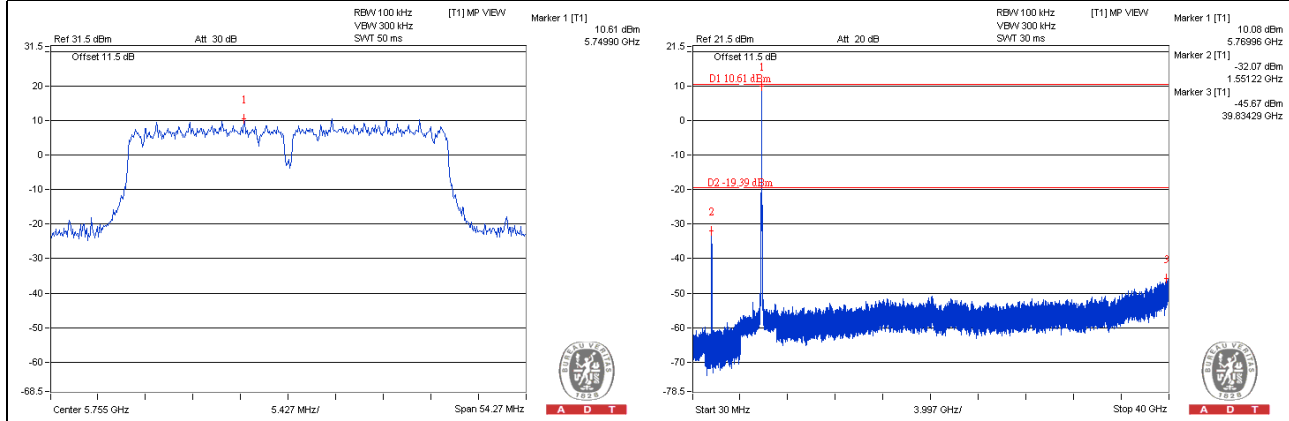

CH 159

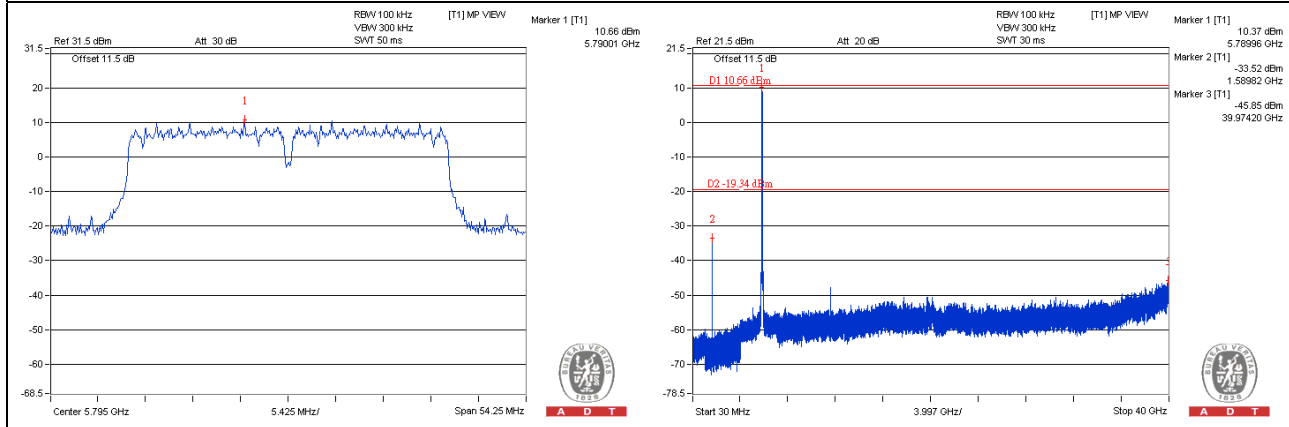

802.11ac (80MHz)_Chain 0

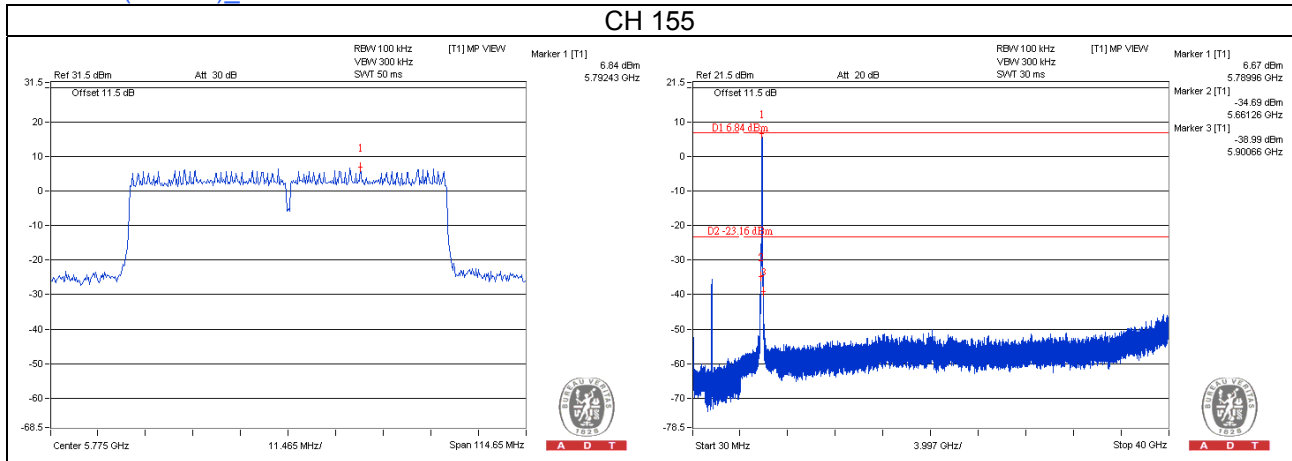

802.11ac (80MHz)_Chain 1

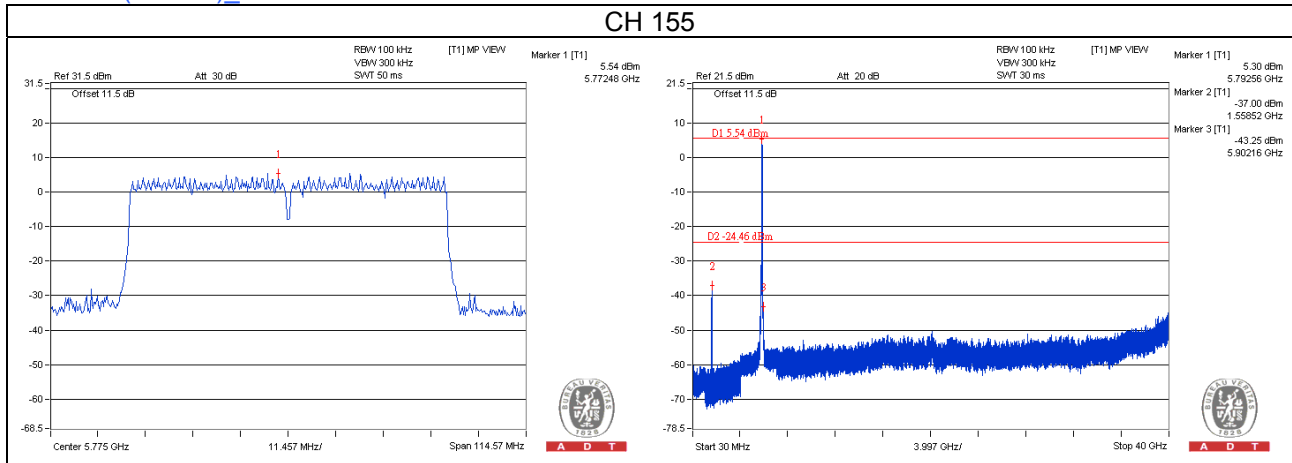

802.11ac (80MHz)_Chain 2

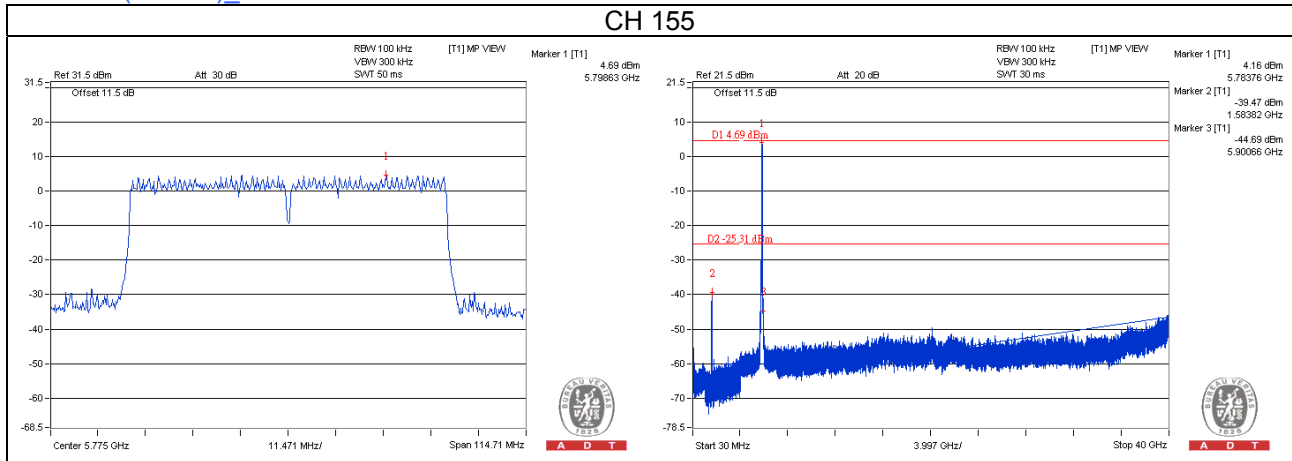

802.11ac (80MHz)_Chain 3

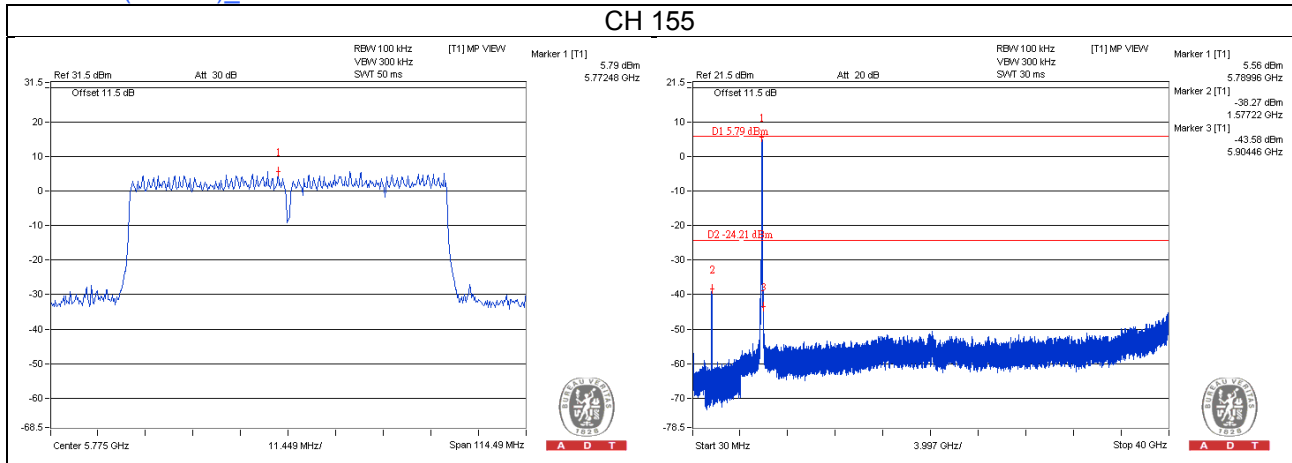



6 Pictures of Test Arrangements

Please refer to the attached file (Test Setup Photo).



Appendix – Information on the Testing Laboratories

We, Bureau Veritas Consumer Products Services (H.K.) Ltd., Taoyuan Branch, were founded in 1988 to provide our best service in EMC, Radio, Telecom and Safety consultation. Our laboratories are accredited and approved according to ISO/IEC 17025.

If you have any comments, please feel free to contact us at the following:

Linko EMC/RF Lab

Tel: 886-2-26052180

Fax: 886-2-26051924

Hsin Chu EMC/RF/Telecom Lab

Tel: 886-3-5935343

Fax: 886-3-5935342

Hwa Ya EMC/RF/Safety Lab

Tel: 886-3-3183232

Fax: 886-3-3270892

Email: service.adt@tw.bureauveritas.com

Web Site: www.bureauveritas-adt.com

The address and road map of all our labs can be found in our web site also.

--- END ---