



SPORTON International Inc.

No. 52, Hwa Ya 1st Rd., Hwa Ya Technology Park, Kwei-Shan Hsiang, Tao Yuan Hsien, Taiwan, R.O.C.
Ph: 886-3-327-3456 / FAX: 886-3-327-0973 / www.sporton.com.tw

FCC Dynamic Frequency Selection Test Report

| | |
|---------------------|--|
| Applicant's company | NETGEAR, Inc. |
| Applicant Address | 350 East Plumeria Drive, San Jose, California 95134, USA |
| FCC ID | PY314300288 |

| | |
|-------------------|---------------------------------------|
| Product Name | AC2350 Smart WiFi Router |
| Brand Name | NETGEAR |
| Model No. | R7500 |
| Test Rule Part(s) | 47 CFR FCC Part 15 Subpart E § 15.407 |
| Test Freq. Range | 5250~5350 / 5470~5725 MHz |
| Received Date | Mar. 30, 2014 |
| Final Test Date | Oct. 17, 2014 |
| Submission Type | Class II Change |
| Operating Mode | Master |

Statement

The test result in this report refers exclusively to the presented test model / sample.

Without written approval of SPORTON International Inc., the test report shall not be reproduced except in full.

The measurements and test results shown in this test report were made in accordance with the procedures and found in compliance with the limit given in **FCC OET Order 06-96A (2006)**,

47 CFR FCC Part 15 Subpart E and **KDB905462 D01 v01** .

The test equipment used to perform the test is calibrated and traceable to NML/ROC.



Table of Contents

| | |
|---|----------------|
| 1. CERTIFICATE OF COMPLIANCE | 1 |
| 2. SUMMARY OF THE TEST RESULT | 2 |
| 3. GENERAL INFORMATION | 3 |
| 3.1. Standard Requirement | 3 |
| 3.2. Product Specification Table..... | 3 |
| 3.3. Accessories..... | 7 |
| 3.4. Manufacturer Statement..... | 7 |
| 3.5. Table for DFS Band Carrier Frequencies | 8 |
| 3.6. Table for Filed Antenna..... | 8 |
| 3.7. Testing Location Information..... | 9 |
| 3.8. Table for Class II Change | 9 |
| 4. DFS DETECTION THRESHOLDS AND RADAR TEST WAVEFORMS | 10 |
| 4.1. Interference Threshold values, Master or Client incorporating In-Service Monitoring..... | 10 |
| 4.2. DFS Response requirement values..... | 11 |
| 4.3. Radar Test Waveforms Minimum Step..... | 11 |
| 4.4. Short Pulse Radar Test Waveforms | 12 |
| 4.5. Long Pulse Radar Test Waveform..... | 13 |
| 4.6. Frequency Hopping Radar Test Waveform..... | 16 |
| 4.7. Radiated Calibration Setup..... | 18 |
| 4.8. Radar Waveform Calibration Procedure | 18 |
| 4.9. Calibration Deviation..... | 18 |
| 4.10. Radar Waveform Calibration Result | 19 |
| 5. TEST SETUP AND TEST RESULT..... | 28 |
| 5.1. Test setup | 28 |
| 5.2. UNII Detection Bandwidth Measurement | 36 |
| 5.3. Initial Channel Availability Check Time Measurement | 43 |
| 5.4. Radar Burst at the Beginning of the Channel Availability Check Time Measurement | 47 |
| 5.5. Radar Burst at the End of the Channel Availability Check Time Measurement | 50 |
| 5.6. In-Service Monitoring for Channel Move Time, Channel Closing Transmission Time and Non-Occupancy Period Measurement...53 | 53 |
| 5.7. Statistical Performance Check Measurement | 67 |
| 6. LIST OF MEASURING EQUIPMENTS | 86 |
| 7. MEASUREMENT UNCERTAINTY..... | 87 |
| APPENDIX A. TEST PHOTOS | A1 ~ A2 |



History of This Test Report

| REPORT NO. | VERSION | DESCRIPTION | ISSUED DATE |
|-------------|---------|-------------------------|---------------|
| FZ433001-05 | Rev. 01 | Initial issue of report | Nov. 05, 2014 |
| | | | |
| | | | |
| | | | |
| | | | |
| | | | |
| | | | |
| | | | |
| | | | |
| | | | |
| | | | |
| | | | |
| | | | |
| | | | |
| | | | |



1. CERTIFICATE OF COMPLIANCE

Product Name : AC2350 Smart WiFi Router
Brand Name : NETGEAR
Model No. : R7500
Applicant : NETGEAR, Inc.
Test Rule Part(s) : 47 CFR FCC Part 15 Subpart E § 15.407

Sporton International as requested by the applicant to evaluate the EMC performance of the product sample received on Mar. 30, 2014 would like to declare that the tested sample has been evaluated and found to be in compliance with the tested rule parts. The data recorded as well as the test configuration specified is true and accurate for showing the sample's EMC nature.

Sam Chen
SPORTON INTERNATIONAL INC.

2. SUMMARY OF THE TEST RESULT

| Applied Standard: OET Order 06-96A (2006) | | | |
|---|----------|---|----------|
| Part | Appendix | Description of Test | Result |
| 5.2 | 7.8.1 | UNII Detection Bandwidth Measurement | Complies |
| 5.3 | 7.8.2.1 | Initial Channel Availability Check Time | Complies |
| 5.4 | 7.8.2.2 | Radar Burst at the Beginning of the Channel Availability Check Time | Complies |
| 5.5 | 7.8.2.3 | Radar Burst at the End of the Channel Availability Check Time | Complies |
| 5.6 | 7.8.3 | In-Service Monitoring for Channel Move Time, Channel Closing Transmission Time and Non-Occupancy Period | Complies |
| 5.7 | 7.4 | Statistical Performance Check | Complies |

3. GENERAL INFORMATION

3.1. Standard Requirement

47 CFR FCC Part 15 Subpart E § 15.407: U-NII devices operating in the 5250~5350 / 5470~5725 MHz shall employ a TPC mechanism. The U-NII device is required to have the capability to operate at least 6 dB below the mean EIRP value of 30 dBm. A TPC mechanism is not required for systems with an e.i.r.p. of less than 500 mW.

U-NII devices operating in the 5250~5350 / 5470~5725 MHz shall employ a DFS radar detection mechanism to detect the presence of radar systems and to avoid co-channel operation with radar systems.

3.2. Product Specification Table

| Specification Items | Description |
|-----------------------------|---|
| Product Type | WLAN (4TX, 4RX) |
| Radio Type | Intentional Transceiver |
| Power Type | From power adapter |
| Modulation | see the below table for 802.11n/ac OFDM (BPSK / QPSK / 16QAM / 64QAM) for IEEE 802.11a |
| Data Rate (Mbps) | see the below table for 802.11n/ac OFDM (6/9/12/18/24/36/48/54) for IEEE 802.11a |
| Test Frequency Range | 5250~5350 / 5470~5725 MHz |
| Channel Bandwidth | 20/40/80 MHz operating channel bandwidth |
| DFS Function | 5260~5320 MHz ; 5500~5700 MHz |
| TPC Function | <input checked="" type="checkbox"/> Yes / <input type="checkbox"/> No |
| Weather Band (5600~5650MHz) | <input type="checkbox"/> Yes / <input checked="" type="checkbox"/> No |
| Max. Con. Power (DFS band) | For non-beamforming mode: 11ac: Band 2: 802.11ac MCS0/Nss1 (VHT20): 21.98 dBm ; 802.11ac MCS0/Nss1 (VHT40): 23.91 dBm ; 802.11ac MCS0/Nss1 (VHT80): 21.65 dBm Band 3: 802.11ac MCS0/Nss1 (VHT20): 21.57 dBm ; 802.11ac MCS0/Nss1 (VHT40): 23.67 dBm ; 802.11ac MCS0/Nss1 (VHT80): 21.36 dBm 11a: Band 2: 21.91 dBm ; Band 3: 21.46 dBm |

| | |
|-----------------------------------|---|
| | <p>For beamforming mode:</p> <p>11ac:</p> <p>Band 2:</p> <p>802.11ac MCS0/Nss2 (VHT20): 23.70 dBm ;</p> <p>802.11ac MCS0/Nss2 (VHT40): 23.81 dBm ;</p> <p>802.11ac MCS0/Nss2 (VHT80): 20.34 dBm</p> <p>Band 3:</p> <p>802.11ac MCS0/Nss2 (VHT20): 23.39 dBm ;</p> <p>802.11ac MCS0/Nss2 (VHT40): 23.46 dBm ;</p> <p>802.11ac MCS0/Nss2 (VHT80): 21.16 dBm</p> |
| <p>Min. Con. Power (DFS band)</p> | <p>For non-beamforming mode:</p> <p>11ac:</p> <p>Band 2:</p> <p>802.11ac MCS0/Nss1 (VHT20): 15.98 dBm ;</p> <p>802.11ac MCS0/Nss1 (VHT40): 17.91 dBm ;</p> <p>802.11ac MCS0/Nss1 (VHT80): 15.65 dBm</p> <p>Band 3:</p> <p>802.11ac MCS0/Nss1 (VHT20): 15.57 dBm ;</p> <p>802.11ac MCS0/Nss1 (VHT40): 17.67 dBm ;</p> <p>802.11ac MCS0/Nss1 (VHT80): 15.36 dBm</p> <p>11a:</p> <p>Band 2: 15.91 dBm ;</p> <p>Band 3: 15.46 dBm</p> <p>For beamforming mode:</p> <p>11ac:</p> <p>Band 2:</p> <p>802.11ac MCS0/Nss2 (VHT20): 17.70 dBm ;</p> <p>802.11ac MCS0/Nss2 (VHT40): 17.81 dBm ;</p> <p>802.11ac MCS0/Nss2 (VHT80): 14.34 dBm</p> <p>Band 3:</p> <p>802.11ac MCS0/Nss2 (VHT20): 17.39 dBm ;</p> <p>802.11ac MCS0/Nss2 (VHT40): 17.46 dBm ;</p> <p>802.11ac MCS0/Nss2 (VHT80): 15.16 dBm</p> |

| | |
|-----------------------------------|---|
| <p>Max. EIRP Power (DFS band)</p> | <p>For non-beamforming mode:</p> <p>11ac:</p> <p>Band 2:</p> <p>802.11ac MCS0/Nss1 (VHT20): 24.48 dBm ; 802.11ac MCS0/Nss1 (VHT40): 26.41 dBm ; 802.11ac MCS0/Nss1 (VHT80): 24.15 dBm</p> <p>Band 3:</p> <p>802.11ac MCS0/Nss1 (VHT20): 24.57 dBm ; 802.11ac MCS0/Nss1 (VHT40): 26.67 dBm ; 802.11ac MCS0/Nss1 (VHT80): 24.36 dBm</p> <p>11a:</p> <p>Band 2: 24.41 dBm ; Band 3: 24.46 dBm</p> <p>For beamforming mode:</p> <p>11ac:</p> <p>Band 2:</p> <p>802.11ac MCS0/Nss2 (VHT20): 26.20 dBm ; 802.11ac MCS0/Nss2 (VHT40): 26.31 dBm ; 802.11ac MCS0/Nss2 (VHT80): 22.84 dBm</p> <p>Band 3:</p> <p>802.11ac MCS0/Nss2 (VHT20): 26.39 dBm ; 802.11ac MCS0/Nss2 (VHT40): 26.46 dBm ; 802.11ac MCS0/Nss2 (VHT80): 24.16 dBm</p> |
| <p>Min. EIRP Power (DFS band)</p> | <p>For non-beamforming mode:</p> <p>11ac:</p> <p>Band 2:</p> <p>802.11ac MCS0/Nss1 (VHT20): 18.48 dBm ; 802.11ac MCS0/Nss1 (VHT40): 20.41 dBm ; 802.11ac MCS0/Nss1 (VHT80): 18.15 dBm</p> <p>Band 3:</p> <p>802.11ac MCS0/Nss1 (VHT20): 18.57 dBm ; 802.11ac MCS0/Nss1 (VHT40): 20.67 dBm ; 802.11ac MCS0/Nss1 (VHT80): 18.36 dBm</p> <p>11a:</p> <p>Band 2: 18.41 dBm ; Band 3: 18.46 dBm</p> |

| | |
|---------------------|---|
| | For beamforming mode: 11ac: Band 2: 802.11ac MCS0/Nss2 (VHT20): 20.20 dBm ; 802.11ac MCS0/Nss2 (VHT40): 20.31 dBm ; 802.11ac MCS0/Nss2 (VHT80): 16.84 dBm Band 3: 802.11ac MCS0/Nss2 (VHT20): 20.39 dBm ; 802.11ac MCS0/Nss2 (VHT40): 20.46 dBm ; 802.11ac MCS0/Nss2 (VHT80): 18.16 dBm |
| Operating Mode | Master |
| Communication Mode | IP based system |
| Power-on cycle | 20MHz: Requires 131.3 seconds to complete its power-on cycle. 40MHz: Requires 132.3 seconds to complete its power-on cycle. 80MHz: Requires 130.6 seconds to complete its power-on cycle. |
| Uniform Spreading | For the 5250~5350 / 5470~5725 MHz, the Master device provides, on aggregate, uniform loading of the spectrum across all devices by selecting an operating channel among the available channels using a random algorithm. |
| Firmware Version | V1.0.0.57 |
| Carrier Frequencies | Please refer to section 3.5 |
| Antenna | Please refer to section 3.6 |

Antenna & Band width

| Antenna | Four (TX) | | |
|-----------------|-----------|--------|--------|
| | 20 MHz | 40 MHz | 80 MHz |
| Band width Mode | | | |
| IEEE 802.11a | V | X | X |
| IEEE 802.11n | V | V | X |
| IEEE 802.11ac | V | V | V |

IEEE 11n/ac Spec.

| Protocol | Number of Transmit Chains (NTX) | Data Rate / MCS |
|--|---------------------------------|-----------------|
| For Non-Beamforming Mode | | |
| 802.11n (HT20) | 4 | MCS 0-31 |
| 802.11n (HT40) | 4 | MCS 0-31 |
| 802.11ac (VHT20) | 4 | MCS 0-9/Nss1-4 |
| 802.11ac (VHT40) | 4 | MCS 0-9/Nss1-4 |
| 802.11ac (VHT80) | 4 | MCS 0-9/Nss1-4 |
| For Beamforming Mode | | |
| 802.11ac (VHT20) | 4 | MCS 0-9/Nss2-4 |
| 802.11ac (VHT40) | 4 | MCS 0-9/Nss2-4 |
| 802.11ac (VHT80) | 4 | MCS 0-9/Nss2-4 |
| Note 1: IEEE Std. 802.11n modulation consists of HT20 and HT40 (HT: High Throughput). Then EUT support HT20 and HT40. Note 2: IEEE Std. 802.11ac modulation consists of VHT20, VHT40, VHT80 and VHT160 (VHT: Very High Throughput). Then EUT support VHT20, VHT40 and VHT80. Note 3: Modulation modes consist of below configuration: 11a: IEEE 802.11a, HT20/HT40: IEEE 802.11n, VHT20/VHT40/VHT80: IEEE 802.11ac | | |

3.3. Accessories

| Power | Brand | Model No. | P/N | Rating |
|-----------|---------|-----------------|--------------|---|
| Adapter 1 | NETGEAR | AD898F20 | 332-10613-01 | Input: 100-240Vac, 50/60Hz, 1.0A Output: 12Vdc, 3.5A |
| Adapter 2 | LEI | MU42-1120350-A1 | 332-10728-01 | Input: 100-240Vac, 50/60Hz, 1.5A Output: 12Vdc, 3.5A |

3.4. Manufacturer Statement

Manufacturer statement confirming that information regarding the parameters of the detected *Radar Waveforms* are not available to the end user.

3.5. Table for DFS Band Carrier Frequencies

There are three bandwidth systems.

For 20MHz bandwidth systems, use Channel 52, 56, 60, 64, 100, 104, 108, 112, 116, 132, 136, 140.

For 40MHz bandwidth systems, use Channel 54, 62, 102, 110, 134.

For 80MHz bandwidth systems, use Channel 58, 106.

| Frequency Band | Channel No. | Frequency | Channel No. | Frequency |
|-------------------------|-------------|-----------|-------------|-----------|
| 5250~5350 MHz Band 2 | 52 | 5260 MHz | 60 | 5300 MHz |
| | 54 | 5270 MHz | 62 | 5310 MHz |
| | 56 | 5280 MHz | 64 | 5320 MHz |
| | 58 | 5290 MHz | - | - |
| 5470~5725 MHz Band 3 | 100 | 5500 MHz | 112 | 5560 MHz |
| | 102 | 5510 MHz | 116 | 5580 MHz |
| | 104 | 5520 MHz | 132 | 5660 MHz |
| | 106 | 5530 MHz | 134 | 5670 MHz |
| | 108 | 5540 MHz | 136 | 5680 MHz |
| | 110 | 5550 MHz | 140 | 5700 MHz |

3.6. Table for Filed Antenna

| Ant. | Brand | Model No. | Antenna Type | Connector |
|------|---------|-----------|----------------|--------------|
| 1 | NETGEAR | R7500 | Dipole Antenna | Reversed-SMA |

Note: The EUT has four external antennas.

| 2.4GHz Band | | | |
|-------------|------------|-----------|------------|
| Frequency | Gain (dBi) | Frequency | Gain (dBi) |
| 2412 MHz | 0.9 | 2452 MHz | 0.9 |
| 2422 MHz | 1.1 | 2462 MHz | 0.8 |
| 2437 MHz | 1.1 | - | - |

| 5GHz Band 2 | | 5GHz Band 3 | |
|-------------|------------|-------------|------------|
| Frequency | Gain (dBi) | Frequency | Gain (dBi) |
| 5260 MHz | 2.3 | 5500 MHz | 2.9 |
| 5270 MHz | 2.4 | 5510 MHz | 3.0 |
| 5290 MHz | 2.5 | 5530 MHz | 3.0 |
| 5300 MHz | 2.5 | 5550 MHz | 3.0 |
| 5310 MHz | 2.5 | 5580 MHz | 2.9 |
| 5320 MHz | 2.5 | 5670 MHz | 3.0 |
| - | - | 5700 MHz | 2.9 |

Note:

For 2.4GHz Band (3TX/3RX)

Chain 2, Chain 3 and Chain 4 could transmit/receive simultaneously.

For 5GHz Band (4TX/4RX)

Chain 1, Chain 2, Chain 3 and Chain 4 could transmit/receive simultaneously.

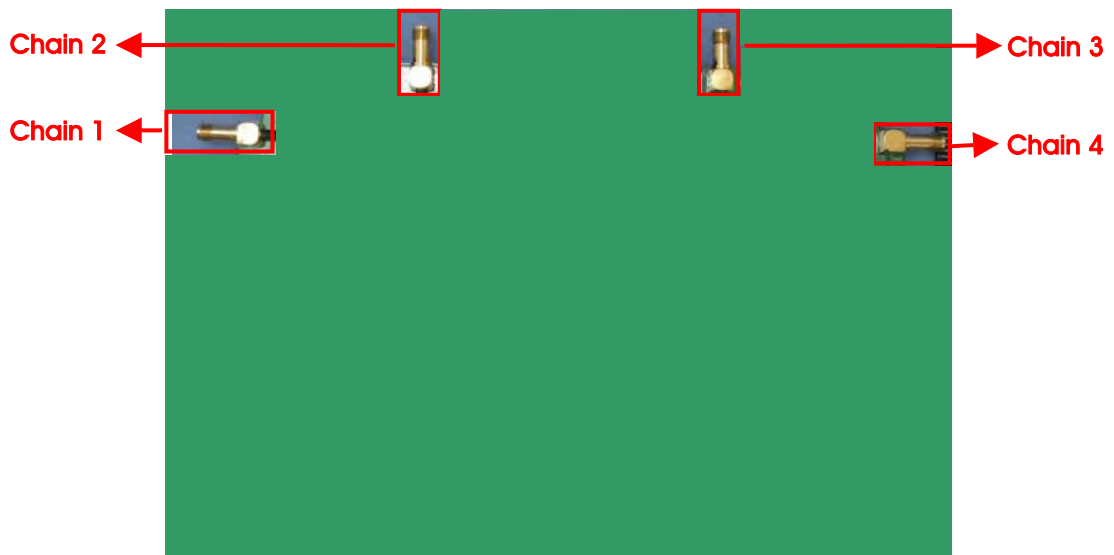

3.7. Testing Location Information

| Testing Location | | | | |
|-------------------------------------|---------------|--|----------------------|------------------------|
| <input type="checkbox"/> | HWA YA | ADD : No. 52, Hwa Ya 1st Rd., Kwei-Shan Hsiang, Tao Yuan Hsien, Taiwan, R.O.C. | TEL : 886-3-327-3456 | FAX : 886-3-327-0973 |
| <input checked="" type="checkbox"/> | JHUBEI | ADD : No.8, Lane 724, Bo-ai St., Jhubei City, HsinChu County 302, Taiwan, R.O.C. | TEL : 886-3-656-9065 | FAX : 886-3-656-9085 |
| Test Condition | Test Site No. | Test Engineer | Test Environment | Test Date |
| DFS Site | DF01-CB | Cliff Chang | 23°C / 63% | 2014/9/29 ~ 2014/10/17 |

3.8. Table for Class II Change

This product is an extension of original one reported under Sporton project number: 433001-03

Below is the table for the change of the product with respect to the original one.

| Modifications | Performance Checking |
|---|------------------------------------|
| Adding 5GHz Band 2 and Band 3 (5250~5350 MHz, 5470~5725 MHz) for this device. | 1. It was performed for all tests. |

4. DFS DETECTION THRESHOLDS AND RADAR TEST WAVEFORMS

4.1. Interference Threshold values, Master or Client incorporating In-Service Monitoring

| Maximum Transmit Power | Value (see note) |
|------------------------|------------------|
| ≥ 200 milliwatt | -64 dBm |
| < 200 milliwatt | -62 dBm |

Note 1: This is the level at the input of the receiver assuming a 0 dBi receive antenna.

Note 2: Throughout these test procedures an additional 1 dB has been added to the amplitude of the test transmission waveforms to account for variations in measurement equipment. This will ensure that the test signal is at or above the detection threshold level to trigger a DFS response.

The radar *Detection Threshold*, lowest antenna gain is the parameter of Interference *radar DFS detection threshold*, The Interference ***Detection Threshold*** is the $-64 \text{ dBm} + 0 \text{ [dBi]} + 1 \text{ dB} = -63 \text{ dBm}$.

4.2. DFS Response requirement values

| Parameter | Value |
|--|--|
| <i>Non-occupancy period</i> | Minimum 30 minutes |
| <i>Channel Availability Check Time</i> | 60 seconds |
| <i>Channel Move Time</i> | 10 seconds See Note 1. |
| <i>Channel Closing Transmission Time</i> | 200 milliseconds + an aggregate of 60 milliseconds over remaining 10 second period. See Notes 1 and 2. |
| <i>U-NII Detection Bandwidth</i> | Minimum 80% of the 99% power bandwidth See Note 3. |

Note 1: The instant that the *Channel Move Time* and the *Channel Closing Transmission Time* begins is as follows:

- For the Short pulse radar Test Signals this instant is the end of the *Burst*.
- For the Frequency Hopping radar Test Signal, this instant is the end of the last radar *Burst* generated.
- For the Long Pulse radar Test Signal this instant is the end of the 12 second period defining the radar transmission.

Note 2: The *Channel Closing Transmission Time* is comprised of 200 milliseconds starting at the beginning of the *Channel Move Time* plus any additional intermittent control signals required to facilitate *Channel* changes (an aggregate of 60 milliseconds) during the remainder of the 10 second period. The aggregate duration of control signals will not count quiet periods in between transmissions.

Note 3: During the *U-NII Detection Bandwidth* detection test, radar type 1 is used and for each frequency step the minimum percentage of detection is 90%. Measurements are performed with no data traffic.

4.3. Radar Test Waveforms Minimum Step

Step intervals of 0.1 microsecond for Pulse Width, 1 microsecond for PRI, 1 MHz for chirp width and 1 for the number of pulses will be utilized for the random determination of specific test waveforms.

4.4. Short Pulse Radar Test Waveforms

| Radar Type | Pulse Width (μsec) | PRI (μsec) | Number of Pulses | Minimum Percentage of Successful Detection | Minimum Trials |
|-----------------------------|---------------------------------|-------------------------|------------------|--|----------------|
| 1 | 1 | 1428 | 18 | 60% | 30 |
| 2 | 1-5 | 150-230 | 23-29 | 60% | 30 |
| 3 | 6-10 | 200-500 | 16-18 | 60% | 30 |
| 4 | 11-20 | 200-500 | 12-16 | 60% | 30 |
| Aggregate (Radar Types 1-4) | | | | 80% | 120 |

A minimum of 30 unique waveforms are required for each of the short pulse radar types 2 through 4. For short pulse radar type 1, the same waveform is used a minimum of 30 times. If more than 30 waveforms are used for short pulse radar types 2 through 4, then each additional waveform must also be unique and not repeated from the previous waveforms. The aggregate is the average of the percentage of successful detections of short pulse radar types 1-4.

Radar Types (1~4) System Diagram

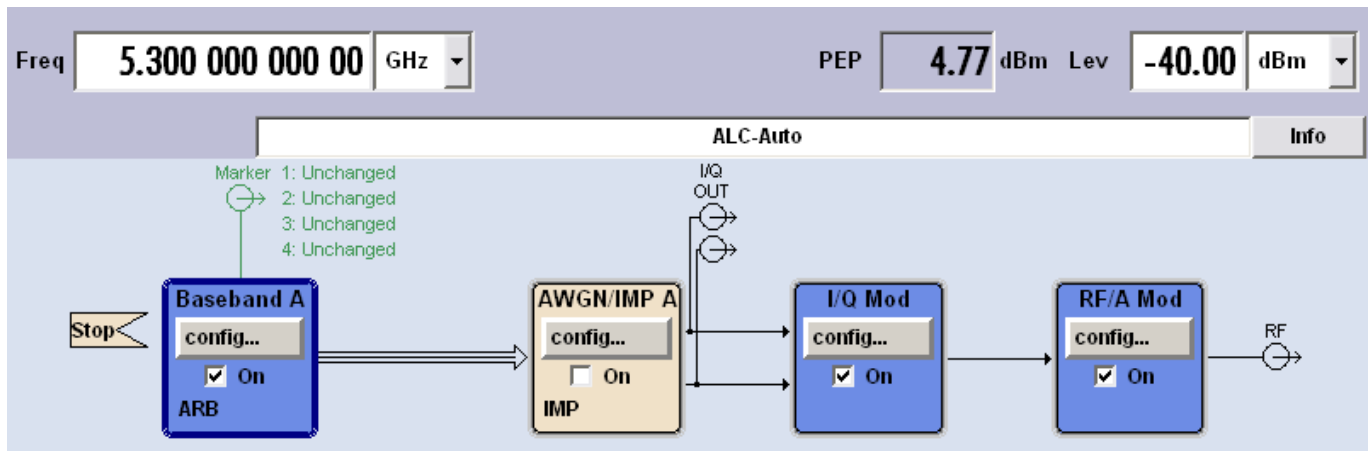

Used R&S SMU200A (Vector SG with one ARB) or SG + ARB

B11: Base-band Generator with ARB (16 M samples) and Digital Modulation

B13: Base-band Main Module

B106: frequency range (100 kHz to 6 GHz)

For selecting the waveform parameters from within the bounds of the signal type, system were random selection using uniform distribution.

4.5. Long Pulse Radar Test Waveform

| Radar Type | Pulse Width (μsec) | Chirp Width (MHz) | PRI (μsec) | Number of Pulses per Burst | Number of Bursts | Minimum Percentage of Successful Detection | Minimum Trials |
|------------|---------------------------------|-------------------|-------------------------|----------------------------|------------------|--|----------------|
| 5 | 50-100 | 5-20 | 1000-2000 | 1-3 | 8-20 | 80% | 30 |

The parameters for this waveform are randomly chosen. Thirty unique waveforms are required for the Long Pulse radar test signal. If more than 30 waveforms are used for the Long Pulse radar test signal, then each additional waveform must also be unique and not repeated from the previous waveforms. Each waveform is defined as follows:

- (1) The transmission period for the Long Pulse Radar test signal is 12 seconds.
- (2) There are a total of 8 to 20 Bursts in the 12 second period, with the number of Bursts being randomly chosen. This number is Burst_Count.
- (3) Each Burst consists of 1 to 3 pulses, with the number of pulses being randomly chosen. Each Burst within the 12 second sequence may have a different number of pulses.
- (4) The pulse width is between 50 and 100 microseconds, with the pulse width being randomly chosen. Each pulse within a Burst will have the same pulse width. Pulses in different Bursts may have different pulse widths.
- (5) Each pulse has a linear FM chirp between 5 and 20 MHz, with the chirp width being randomly chosen. Each pulse within a Burst will have the same chirp width. Pulses in different Bursts may have different chirp widths. The chirp is centered on the pulse. For example, with a radar frequency of 5300 MHz and a 20 MHz chirped signal, the chirp starts at 5290 MHz and ends at 5310 MHz.
- (6) If more than one pulse is present in a Burst, the time between the pulses will be between 1000 and 2000 microseconds, with the time being randomly chosen. If three pulses are present in a Burst, the time between the first and second pulses is chosen independently of the time between the second and third pulses.
- (7) The 12 second transmission period is divided into even intervals. The number of intervals is equal to Burst_Count. Each interval is of length $(12,000,000 / \text{Burst_Count})$ microseconds. Each interval contains one Burst. The start time for the Burst, relative to the beginning of the interval, is between 1 and $[(12,000,000 / \text{Burst_Count}) - (\text{Total Burst Length}) + (\text{One Random PRI Interval})]$ microseconds, with the start time being randomly chosen. The step interval for the start time is 1 microsecond. The start time for each Burst is chosen independently.

A representative example of a Long Pulse radar test waveform:

- (1) The total test signal length is 12 seconds.
- (2) 8 Bursts are randomly generated for the Burst_Count.
- (3) Burst 1 has 2 randomly generated pulses.
- (4) The pulse width (for both pulses) is randomly selected to be 75 microseconds.
- (5) The PRI is randomly selected to be at 1213 microseconds.

- (6) Bursts 2 through 8 are generated using steps 3 – 5.
- (7) Each Burst is contained in even intervals of 1,500,000 microseconds. The starting location for Pulse 1, Burst 1 is randomly generated (1 to 1,500,000 minus the total Burst 1 length + 1 random PRI interval) at the 325,001 microsecond step. Bursts 2 through 8 randomly fall in successive 1,500,000 microsecond intervals (i.e. Burst 2 falls in the 1,500,001 – 3,000,000 microsecond range).

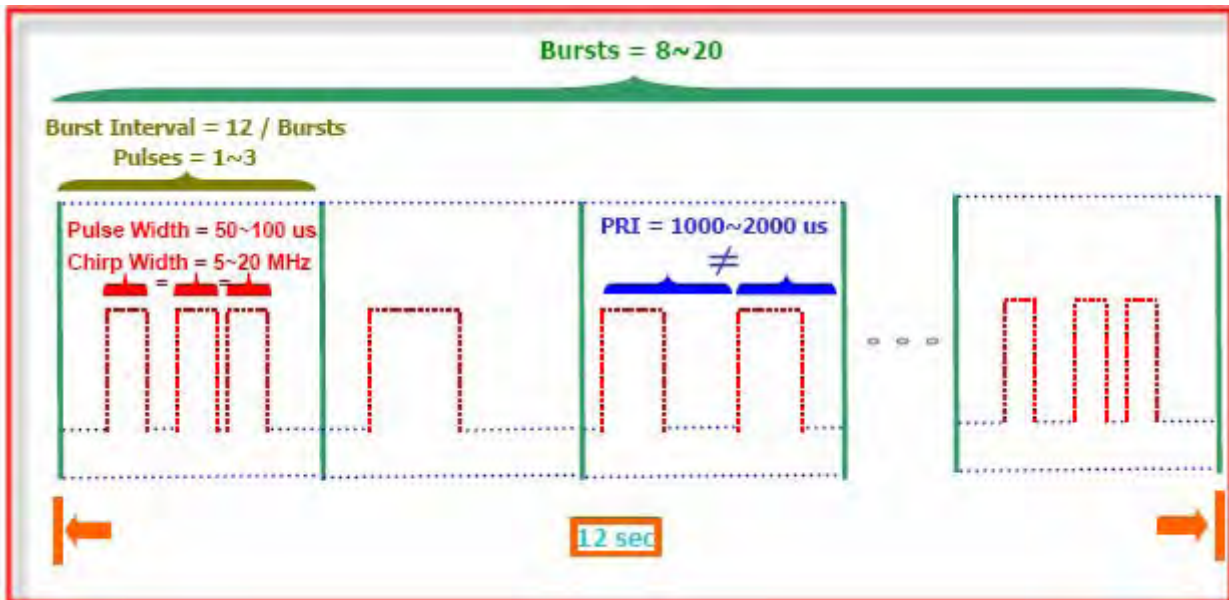

Radar Types (5) System Diagram

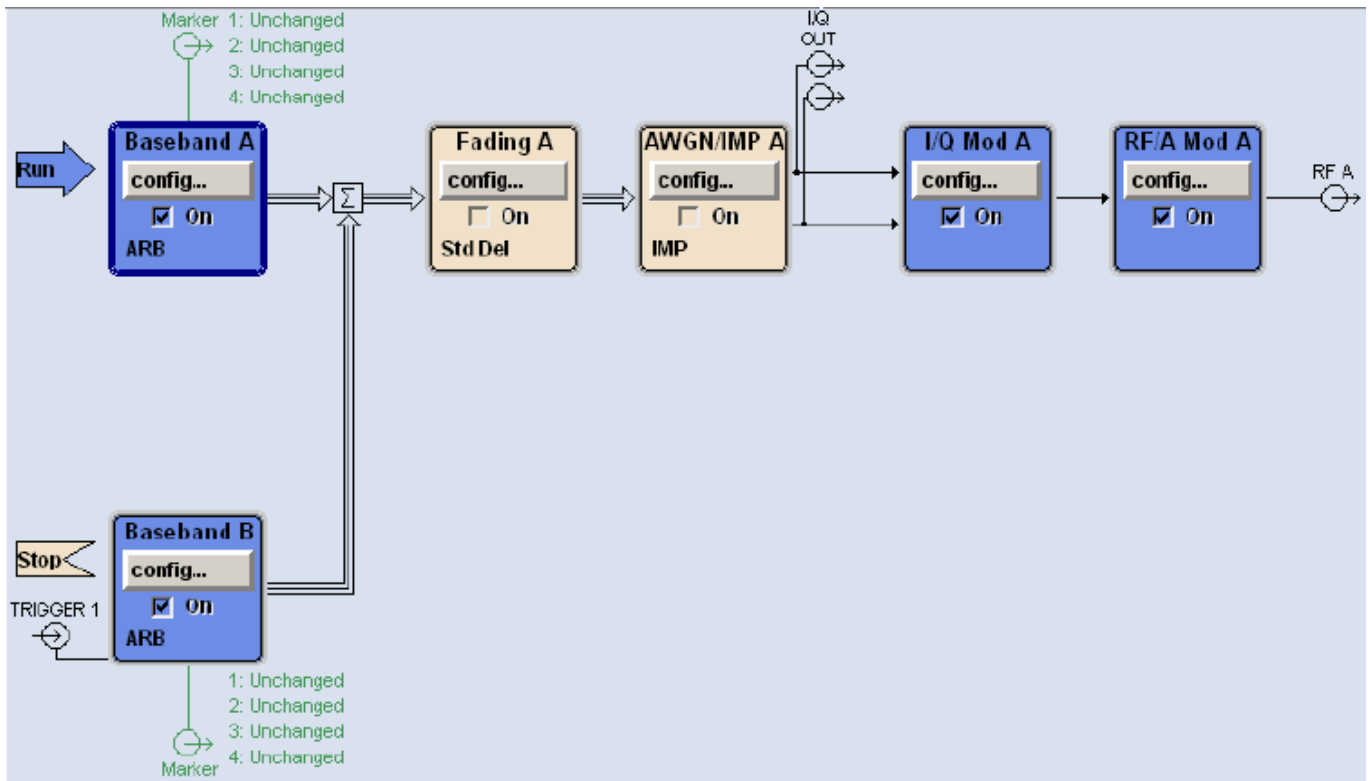

Used R&S SMU200A (Vector SG with two ARB)

Path A / Path B Two B11: Base-band Generator with ARB (16 M samples) and Digital Modulation

B13: Base-band Main Module

B106: frequency range (100 kHz to 6 GHz)

For selecting the waveform parameters from within the bounds of the signal type, system was random selection using uniform distribution.

4.6. Frequency Hopping Radar Test Waveform

| Radar Type | Pulse Width (μsec) | PRI (μsec) | Pulses per Hop | Hopping Rate (kHz) | Hopping Sequence Length (msec) | Minimum Percentage of Successful Detection | Minimum Trials |
|------------|---------------------------------|-------------------------|----------------|--------------------|--------------------------------|--|----------------|
| 6 | 1 | 333 | 9 | 0.333 | 300 | 70% | 30 |

For the Frequency Hopping Radar Type, the same Burst parameters are used for each waveform. The hopping sequence is different for each waveform and a 100-length segment is selected from the hopping sequence defined by the following algorithm:

The first frequency in a hopping sequence is selected randomly from the group of 475 integer frequencies from 5250 – 5724 MHz. Next, the frequency that was just chosen is removed from the group and a frequency is randomly selected from the remaining 474 frequencies in the group. This process continues until all 475 frequencies are chosen for the set. For selection of a random frequency, the frequencies remaining within the group are always treated as equally likely.

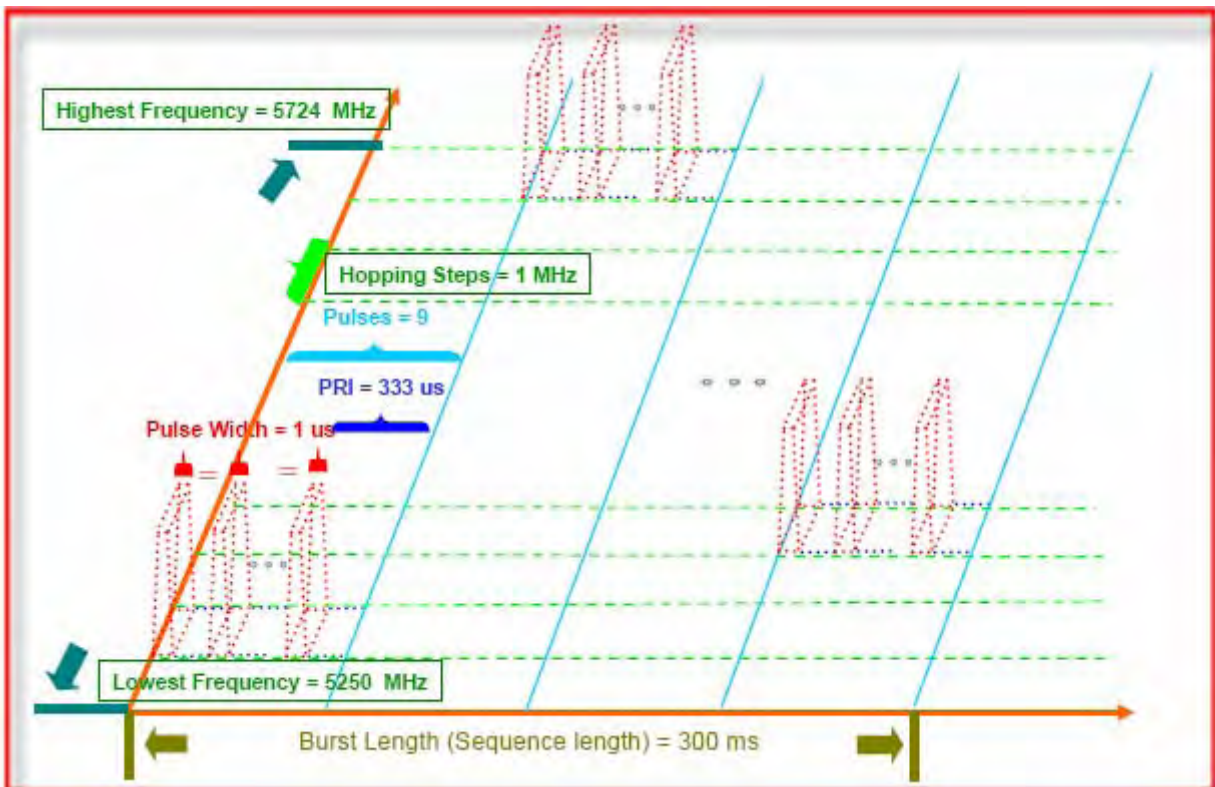

Radar Types (6) System Diagram

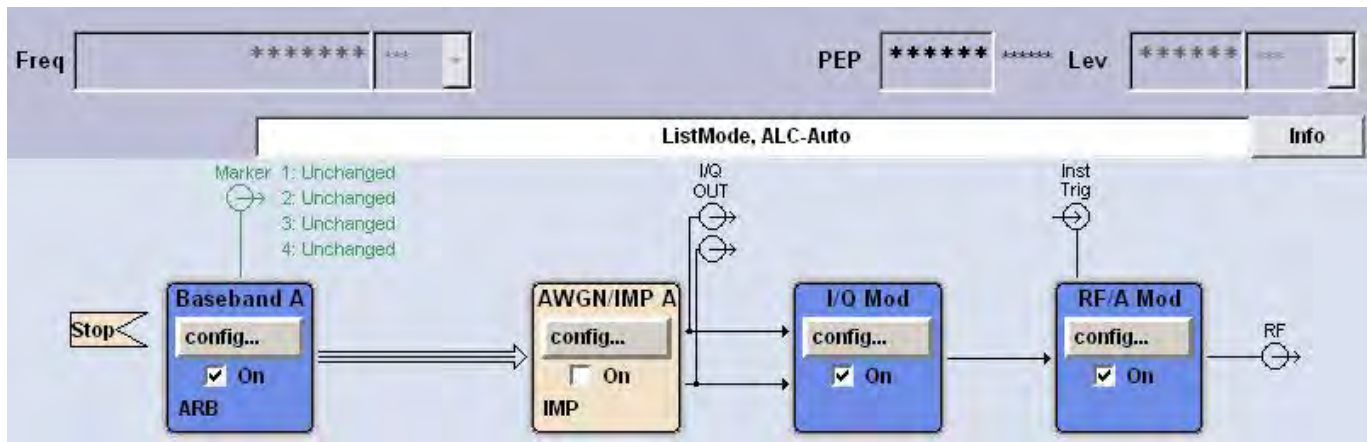

Used R&S SMU200A (Vector SG with one ARB)

B11: Base-band Generator with ARB (16 M samples) and Digital Modulation

B13: Base-band Main Module

B106: frequency range (100 kHz to 6 GHz)

For selecting the waveform parameters from within the bounds of the signal type, system were random selection using uniform distribution.

4.7. Radiated Calibration Setup

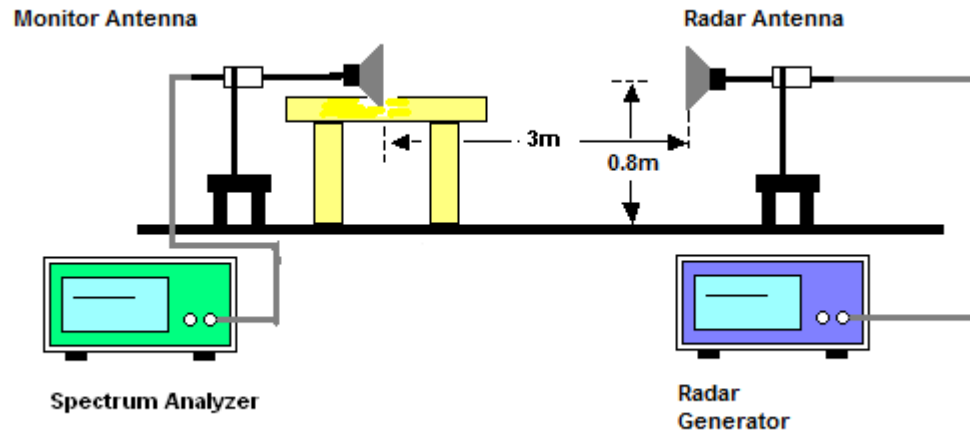

4.8. Radar Waveform Calibration Procedure

The Interference Radar Detection Threshold Level is $-64 \text{ dBm} + 0 [\text{dBi}] + 1 \text{ dB} = -63 \text{ dBm}$ that had been taken into account the output power range and antenna gain. The above equipment setup was used to calibrate the conducted Radar Waveform. A vector signal generator was utilized to establish the test signal level for each radar type. During this process there were replace 50ohm terminal form Master and Client device and no transmissions by either the Master or Client Device. The spectrum analyzer was switched to the zero span (Time Domain) at the frequency of the Radar Waveform generator. Peak detection was used. The spectrum analyzer resolution bandwidth (RBW) and video bandwidth (VBW) were set to at least 3 MHz. The vector signal generator amplitude was set so that the power level measured at the spectrum analyzer was $-64 \text{ dBm} + 0 [\text{dBi}] + 1 \text{ dB} = -63 \text{ dBm}$. Capture the spectrum analyzer plots on short pulse radar types, long pulse radar type and hopping radar waveform.

4.9. Calibration Deviation

There is no deviation with the original standard.

4.10. Radar Waveform Calibration Result

<For 20MHz>

Radar #1 DFS detection threshold level and the burst of pulses on the Channel frequency

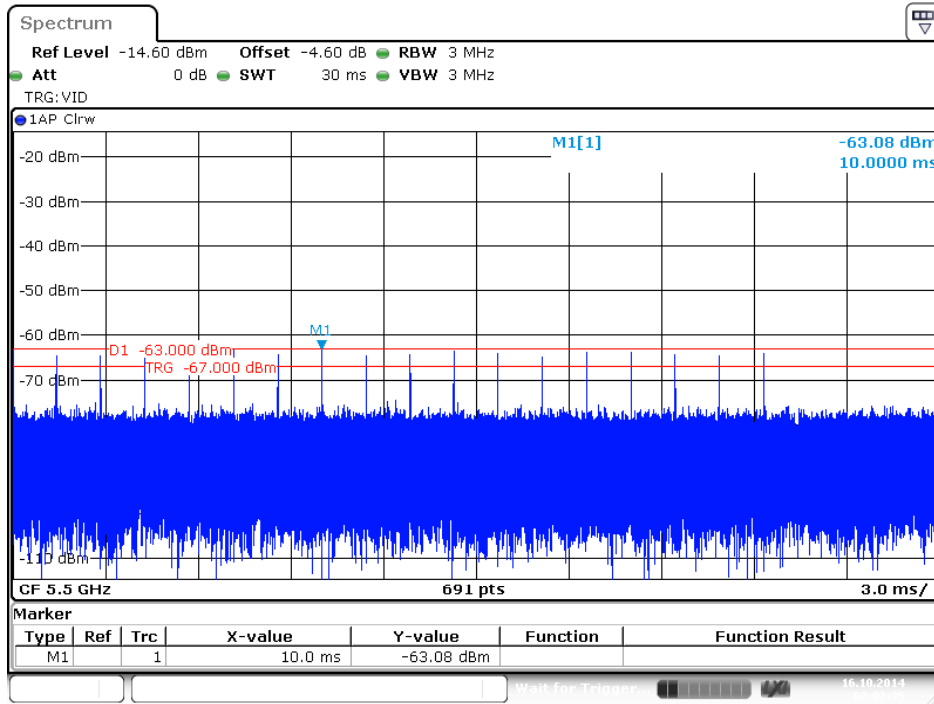

Date: 16.OCT.2014 02:02:35

Radar #2 DFS detection threshold level and the burst of pulses on the Channel frequency

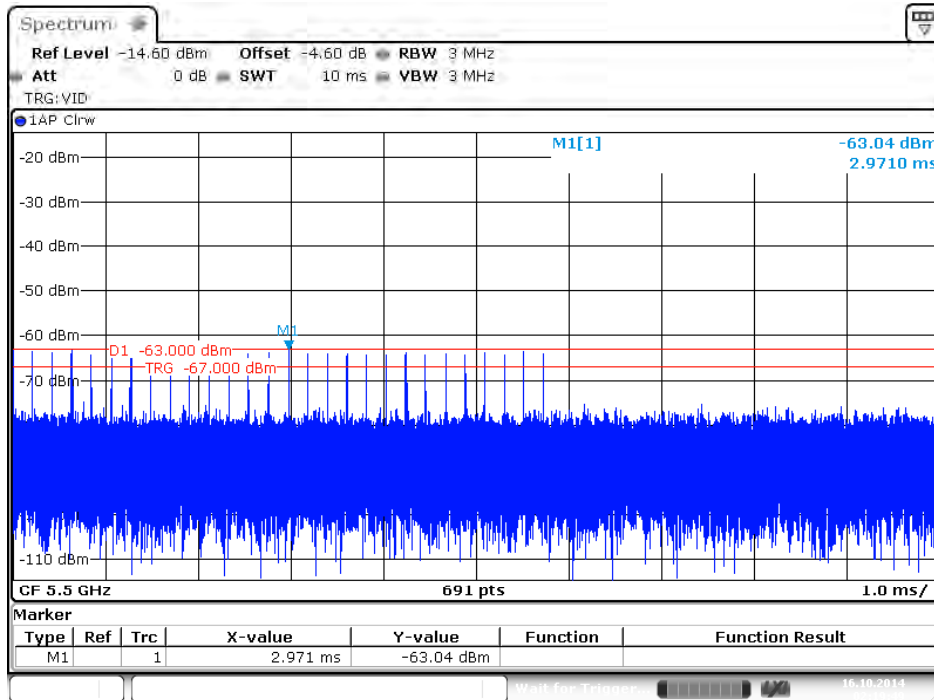

Date: 16.OCT.2014 02:19:49

Radar #3 DFS detection threshold level and the burst of pulses on the Channel frequency

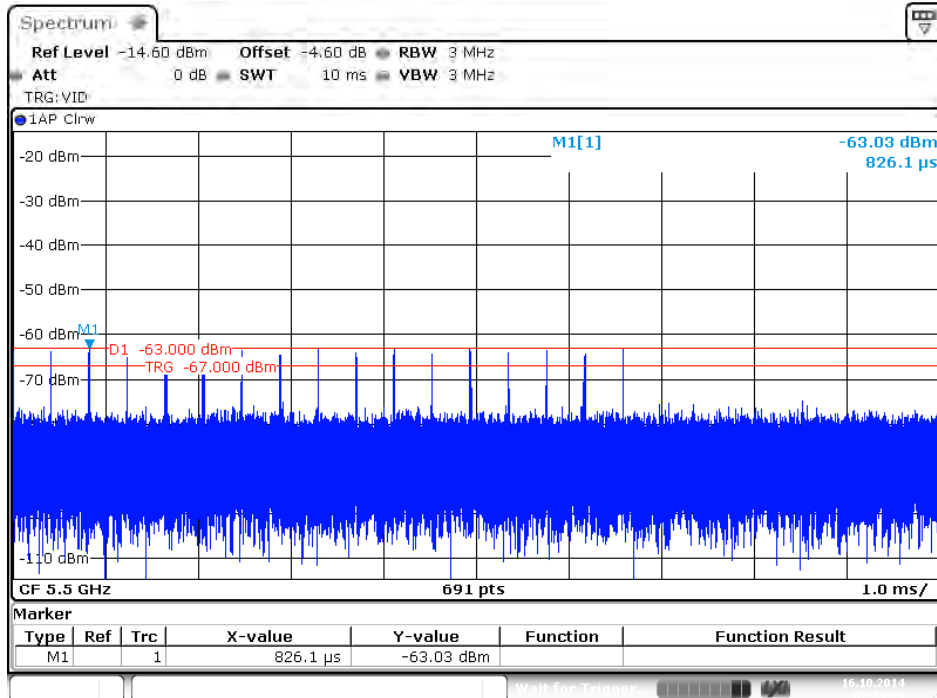

Date: 16.0 CT.2014 02:23:28

Radar #4 DFS detection threshold level and the burst of pulses on the Channel frequency

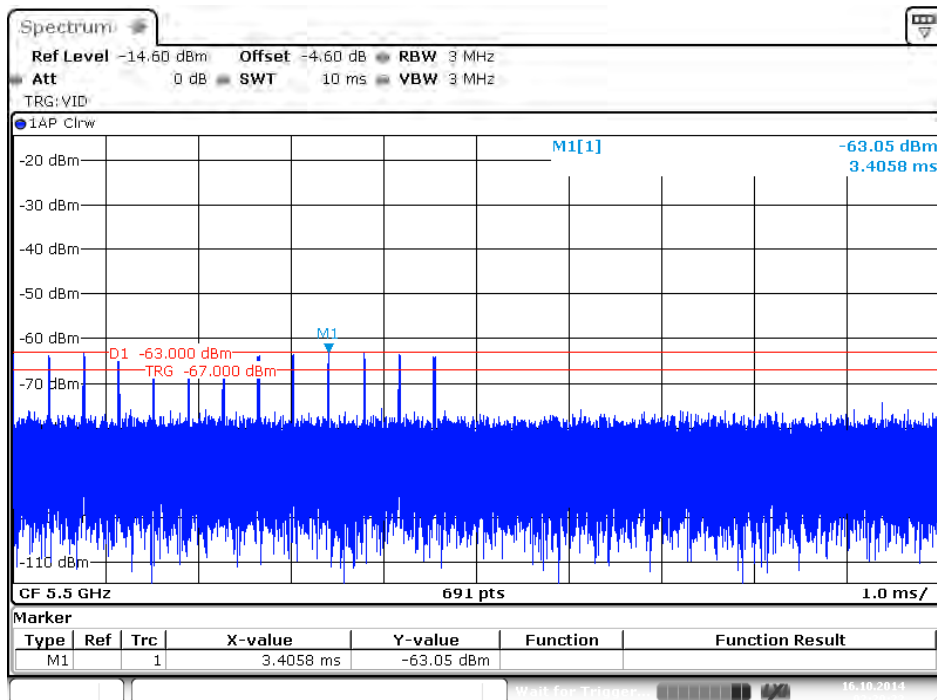

Date: 16.0 CT.2014 02:29:22

Radar #5 DFS detection threshold level and 12sec long burst on the Channel frequency

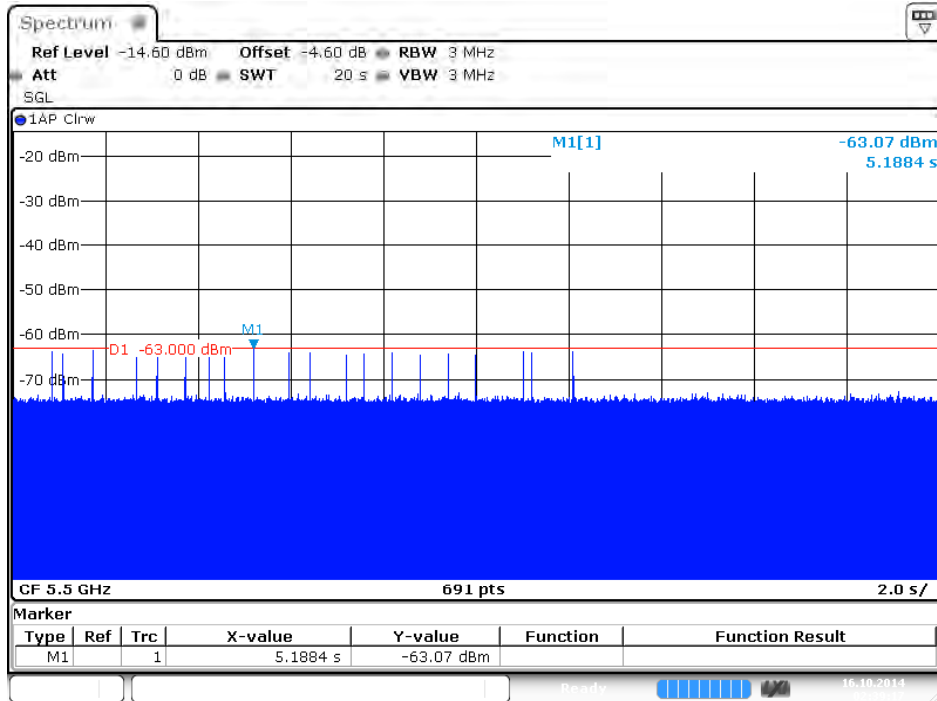

Date: 16.0 CT.2014 02:39:18

Radar #6 DFS detection threshold level and a single hop (9 pulses) on the Channel frequency within UNII detection bandwidth.

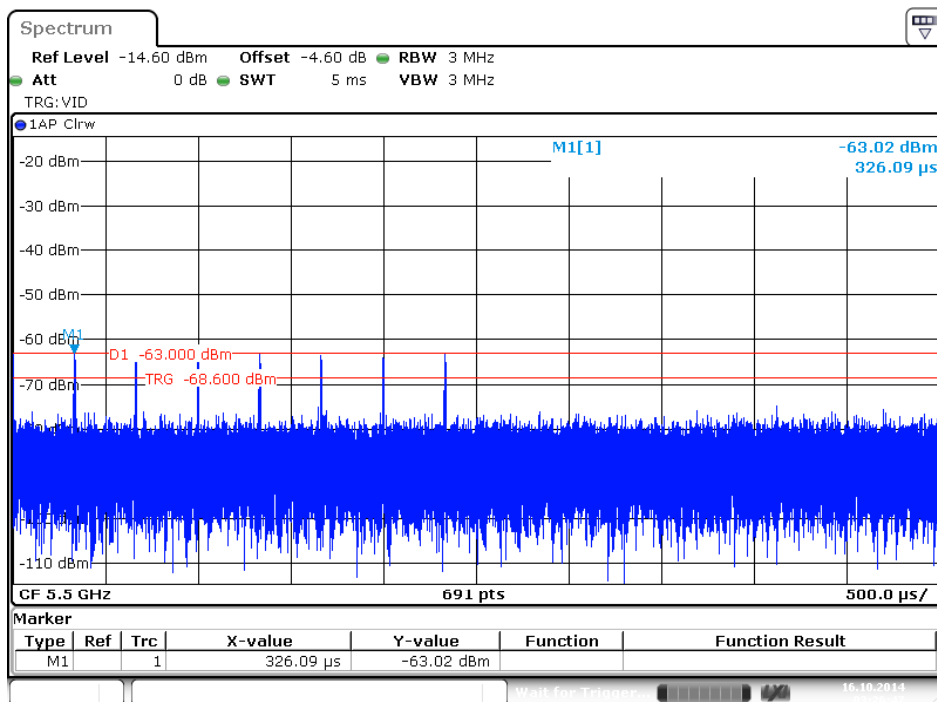

Date: 16.0 CT.2014 03:26:47

<For 40MHz>

Radar #1 DFS detection threshold level and the burst of pulses on the Channel frequency

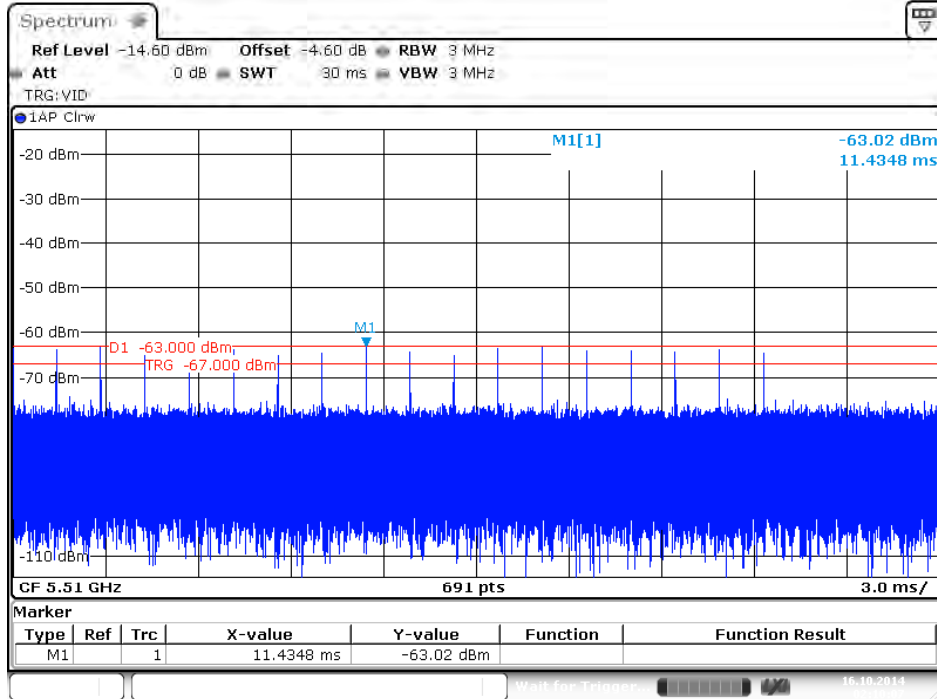

Date: 16 OCT 2014 02:10:07

Radar #2 DFS detection threshold level and the burst of pulses on the Channel frequency

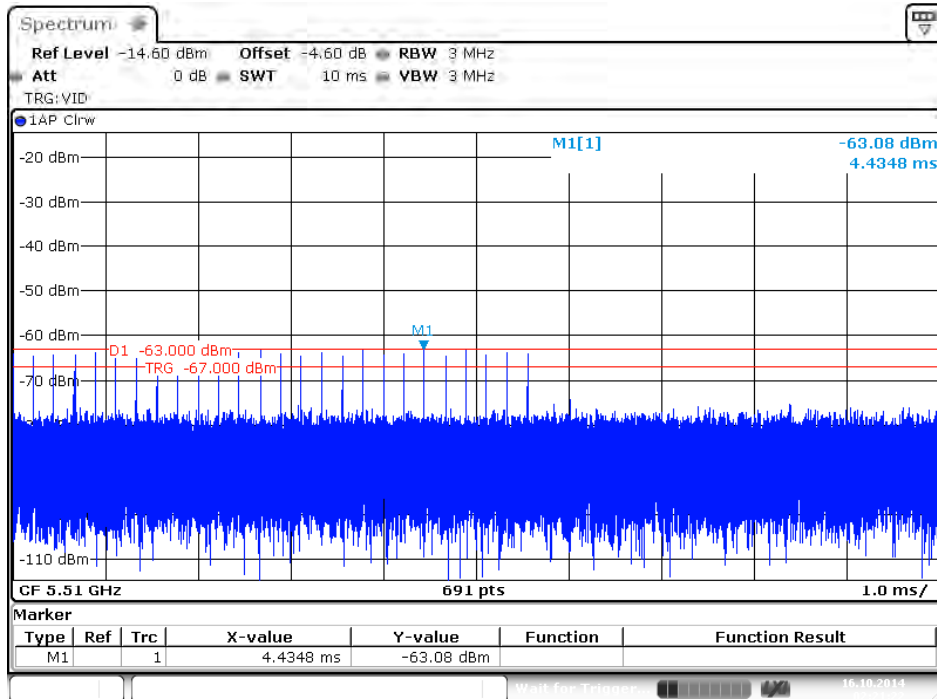

Date: 16 OCT 2014 02:21:22

Radar #3 DFS detection threshold level and the burst of pulses on the Channel frequency

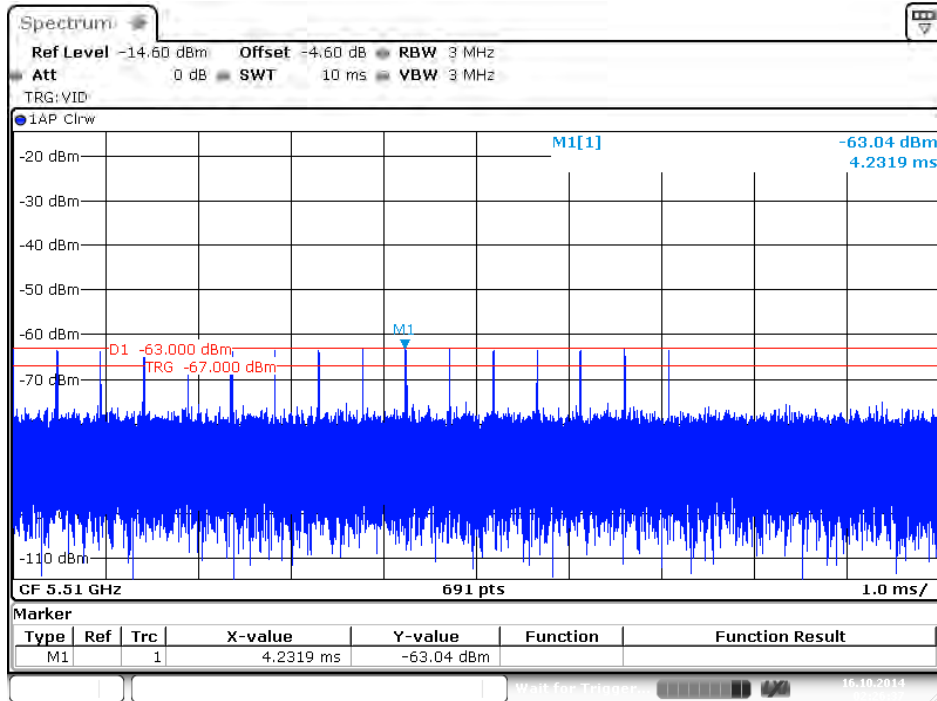

Date: 16.OCT.2014 02:26:38

Radar #4 DFS detection threshold level and the burst of pulses on the Channel frequency

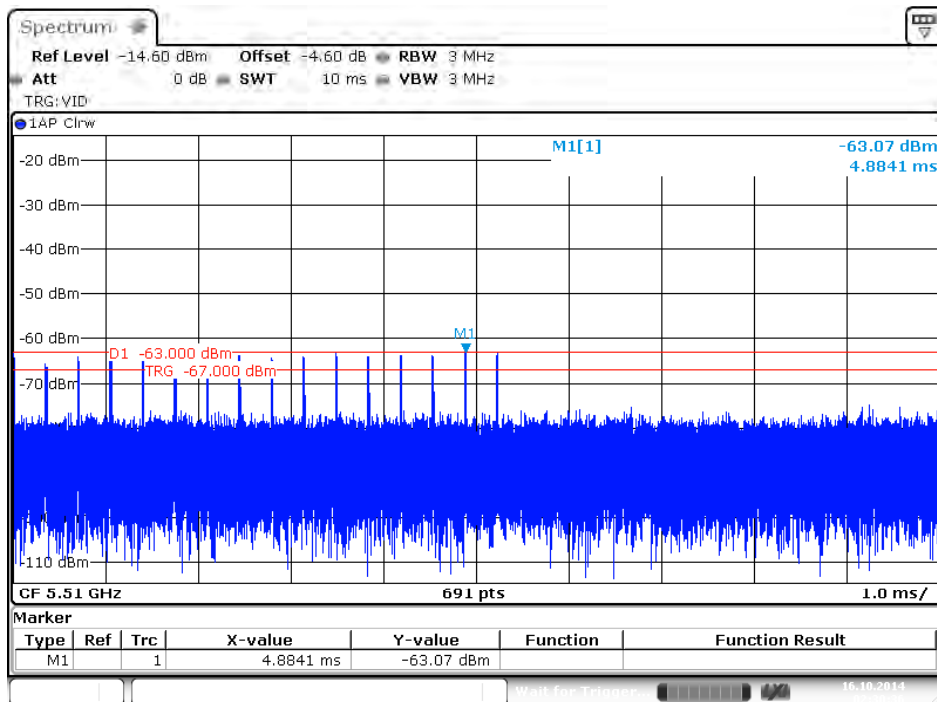

Date: 16.OCT.2014 02:30:36

Radar #5 DFS detection threshold level and 12sec long burst on the Channel frequency

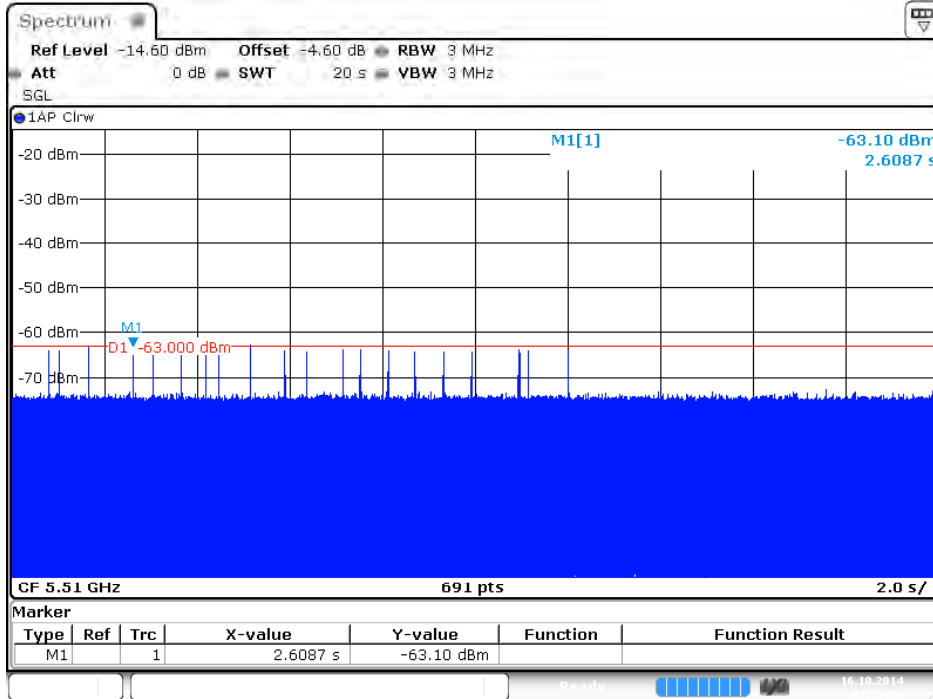

Date: 16.OCT.2014 02:55:04

Radar #6 DFS detection threshold level and a single hop (9 pulses) on the Channel frequency within UNII detection bandwidth.

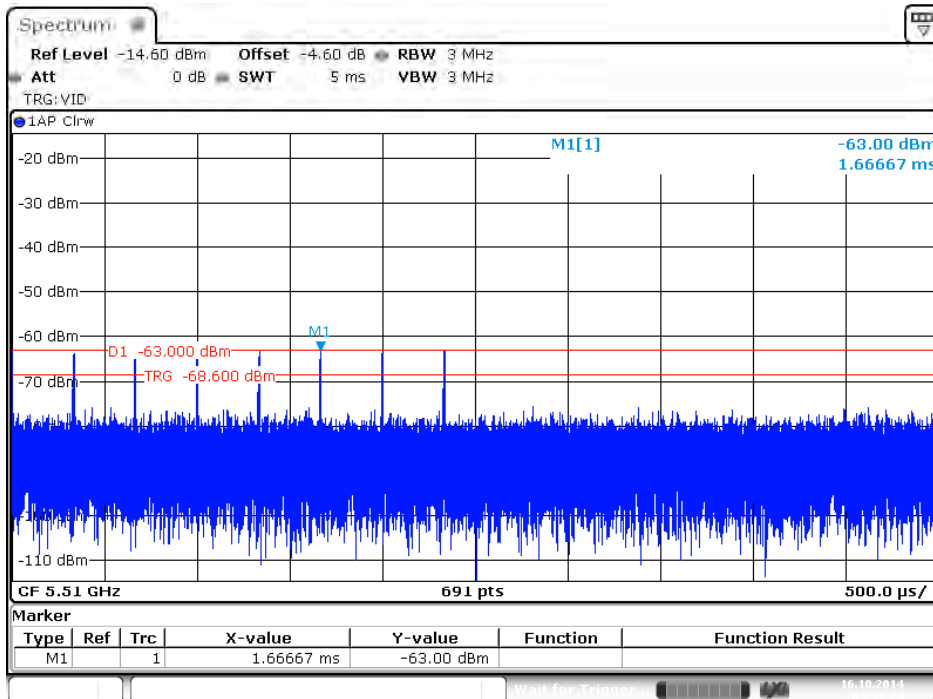

Date: 16.OCT.2014 03:31:24

<For 80MHz>

Radar #1 DFS detection threshold level and the burst of pulses on the Channel frequency

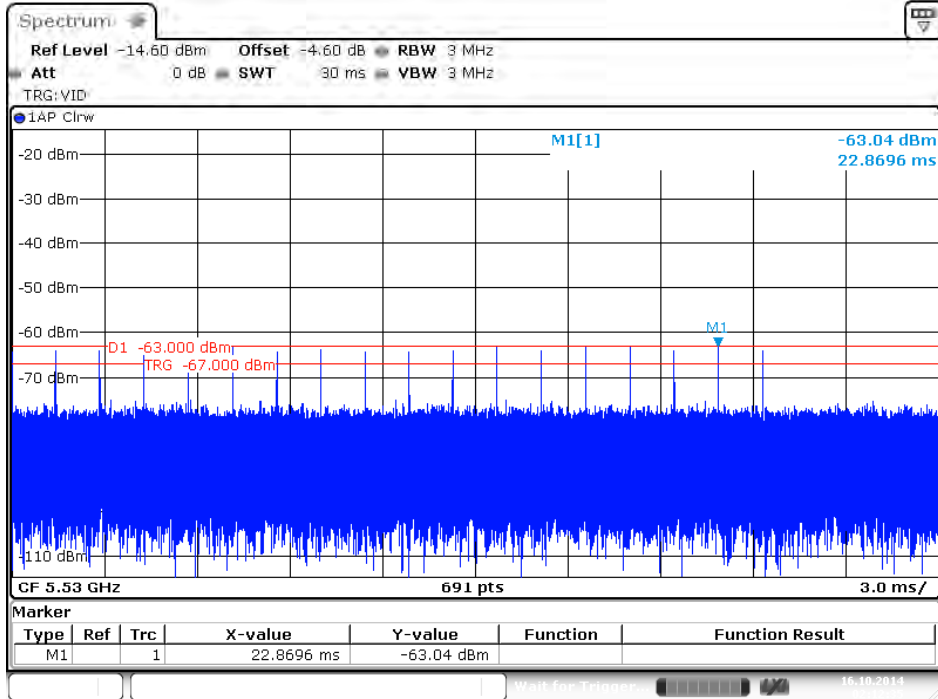

Date: 16.0 CT.2014 02:12:35

Radar #2 DFS detection threshold level and the burst of pulses on the Channel frequency

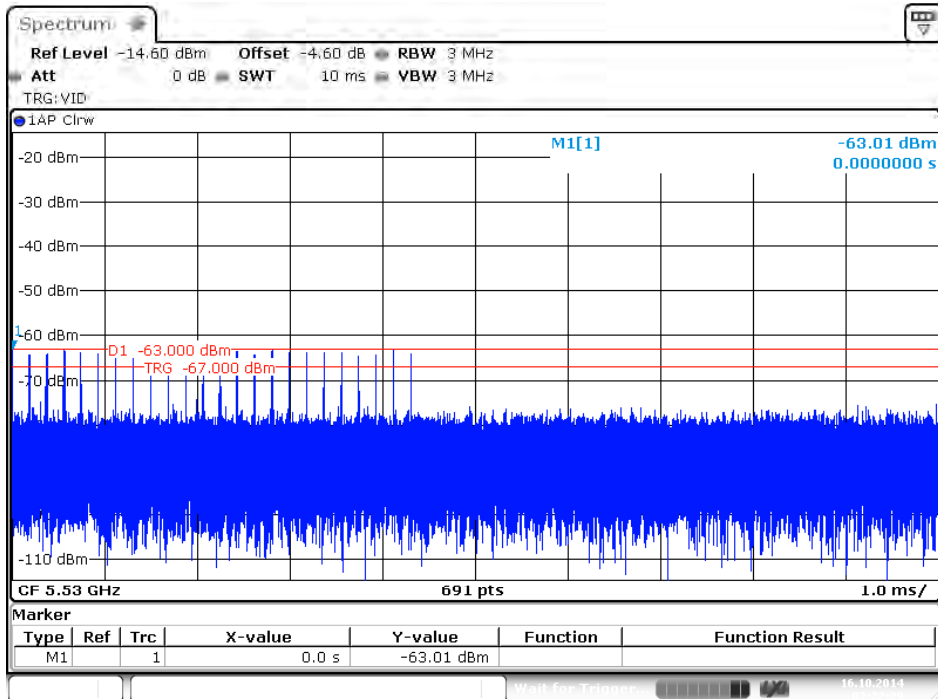

Date: 16.0 CT.2014 02:22:29

Radar #3 DFS detection threshold level and the burst of pulses on the Channel frequency

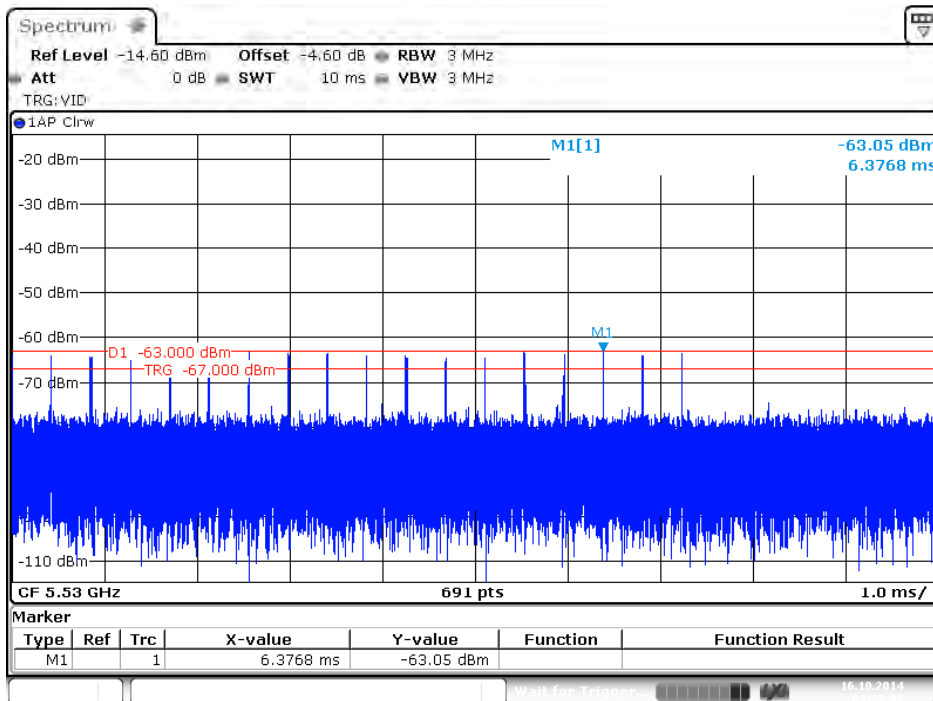

Date: 16.0 CT.2014 02:28:07

Radar #4 DFS detection threshold level and the burst of pulses on the Channel frequency

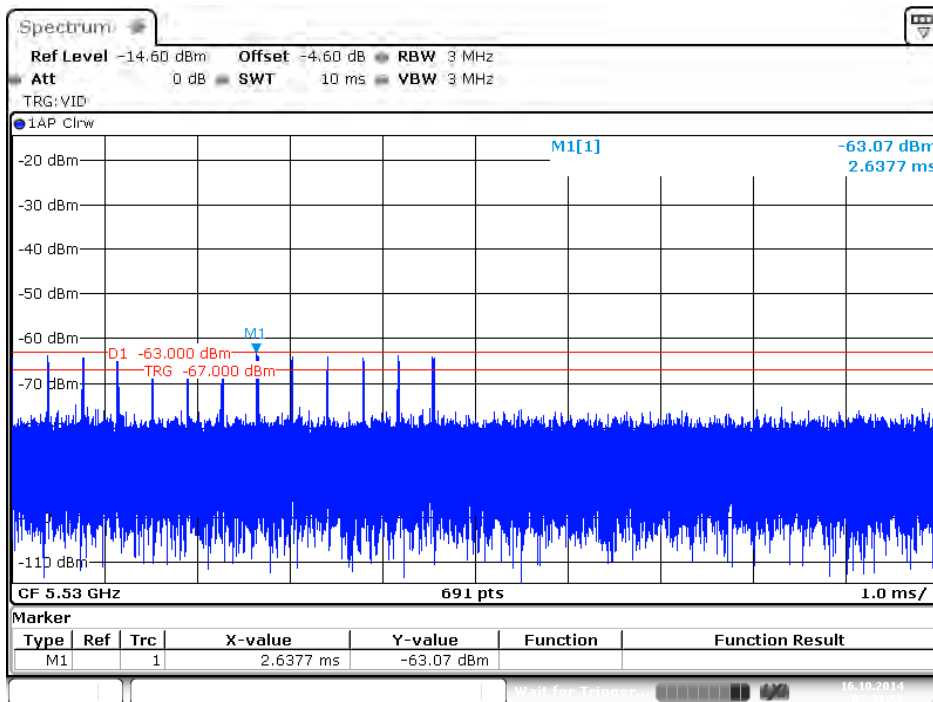

Date: 16.0 CT.2014 02:31:57

Radar #5 DFS detection threshold level and 12sec long burst on the Channel frequency

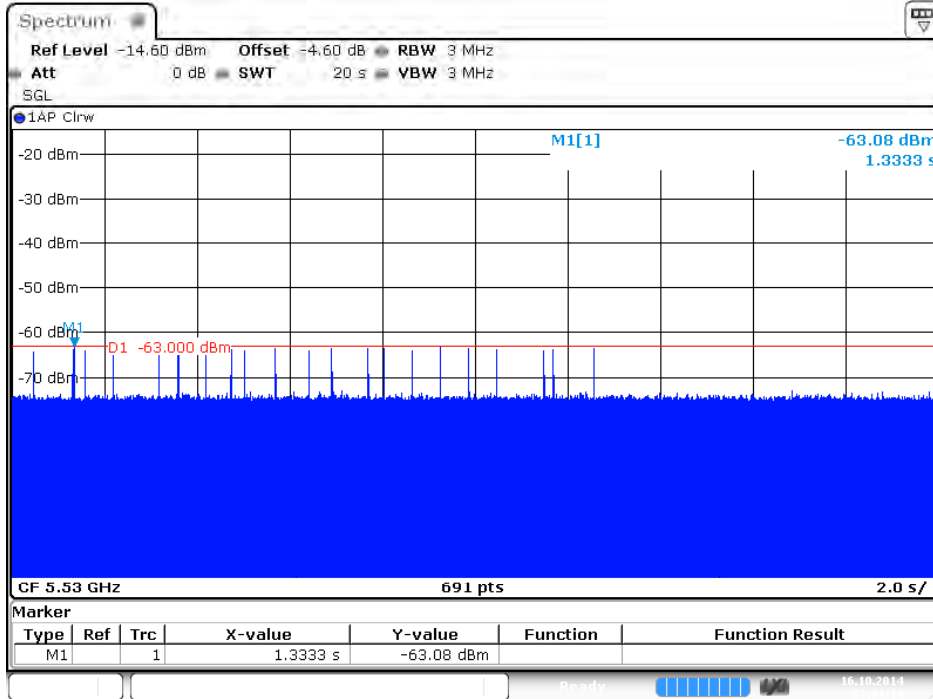

Date: 16.0 CT.2014 03:01:14

Radar #6 DFS detection threshold level and a single hop (9 pulses) on the Channel frequency within UNII detection bandwidth.

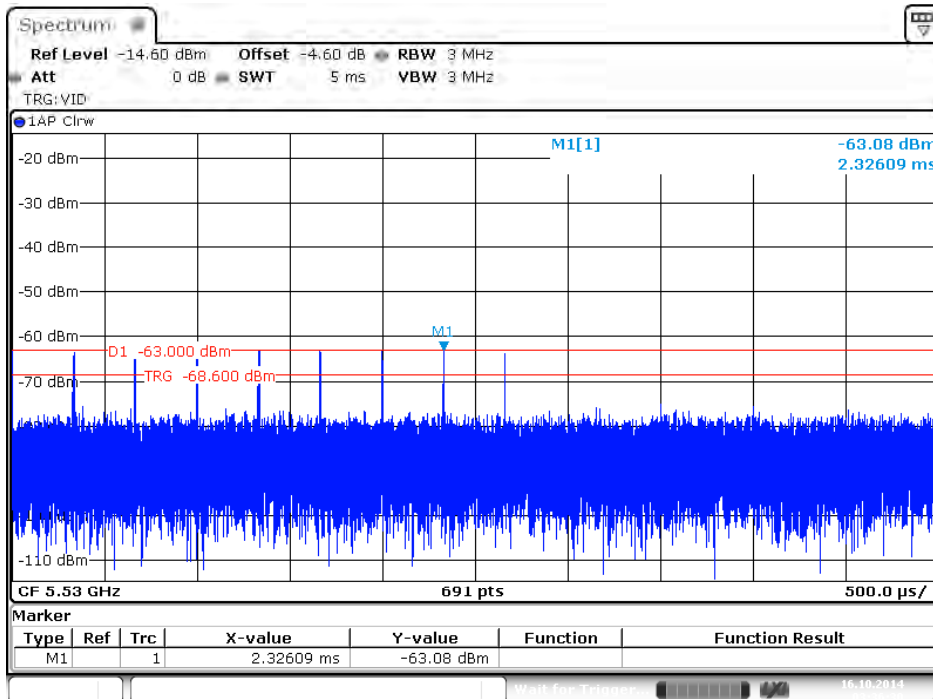

Date: 16.0 CT.2014 03:36:31

5. TEST SETUP AND TEST RESULT

5.1. Test setup

5.1.1. Test Setup Diagram

Following is the test setup for generate the radar waveforms and used to monitor UNII device.

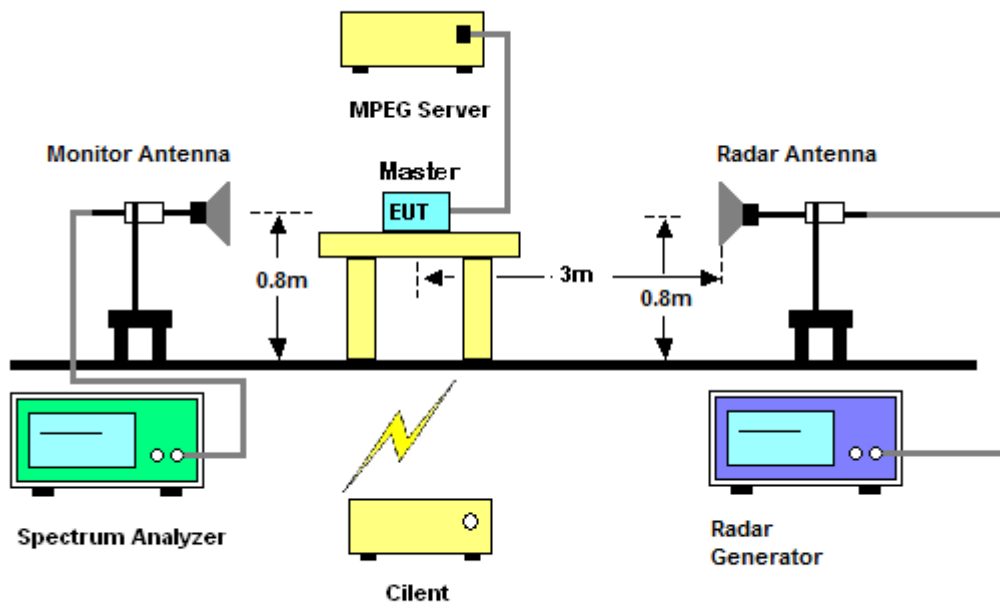

EUT (Master) Data Traffic Plot (20 MHz)

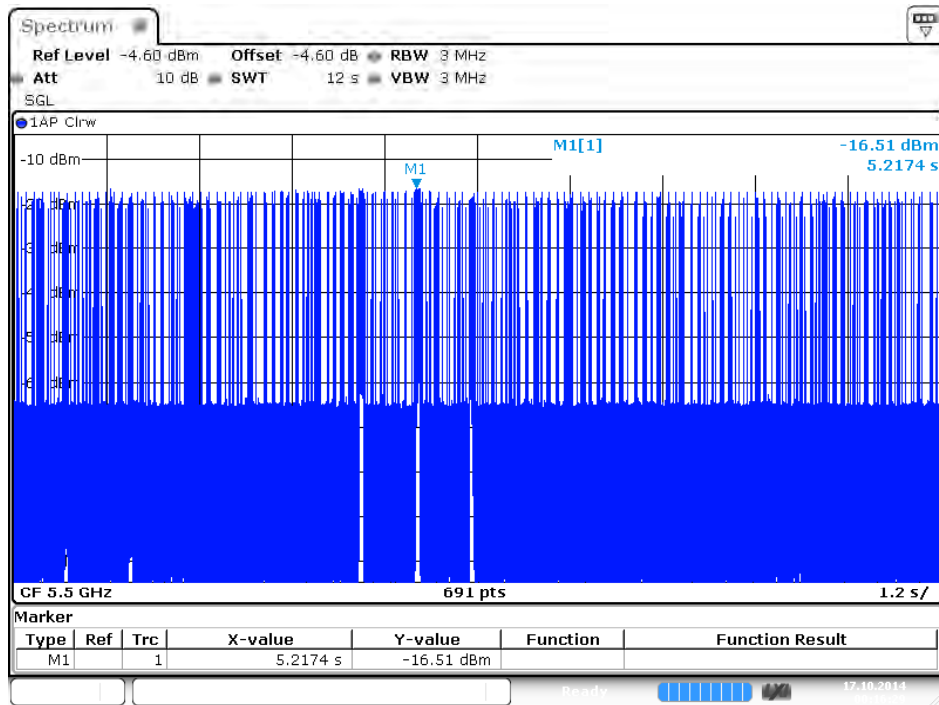

Date: 17.OCT.2014 00:16:29

EUT (Master) Data Traffic Plot (40 MHz)

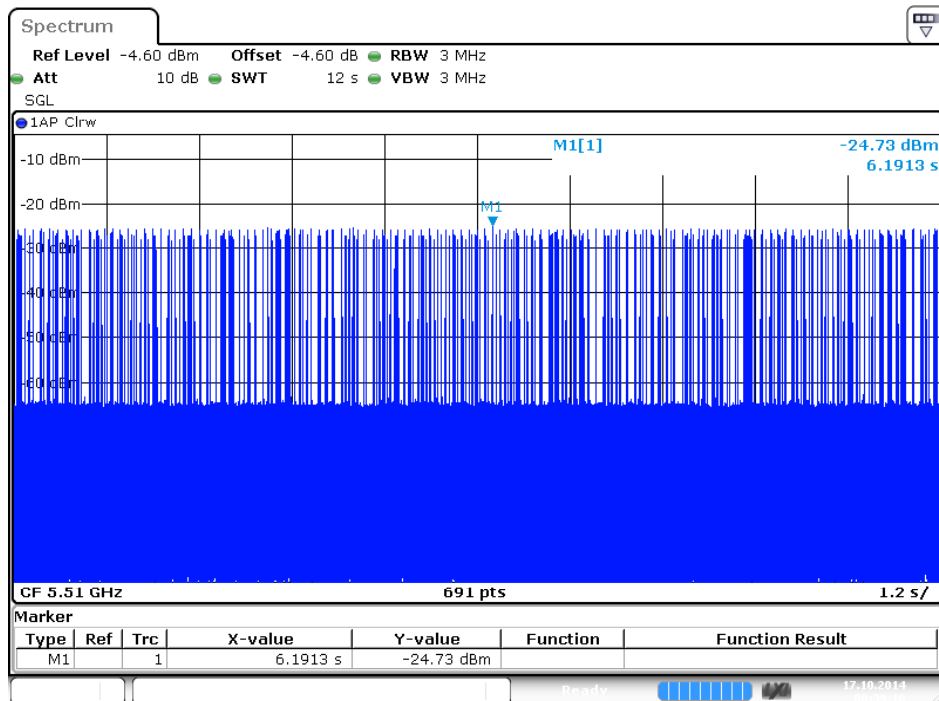

Date: 17.OCT.2014 00:39:16

EUT (Master) Data Traffic Plot (80 MHz)

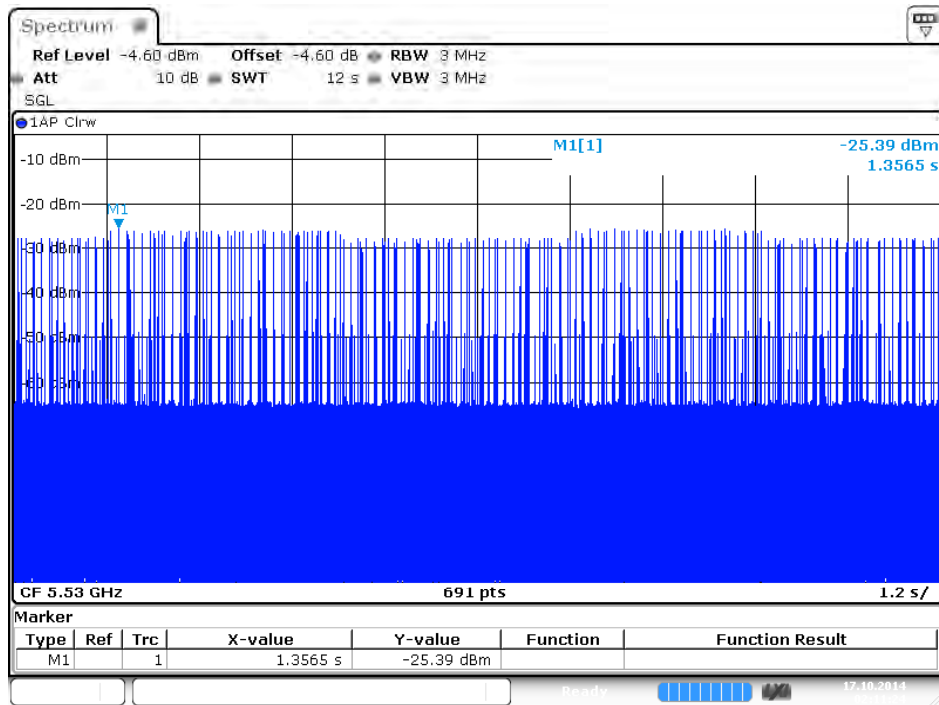

Date: 17.OCT.2014 02:11:25

Slave Data Traffic Plot (20MHz)

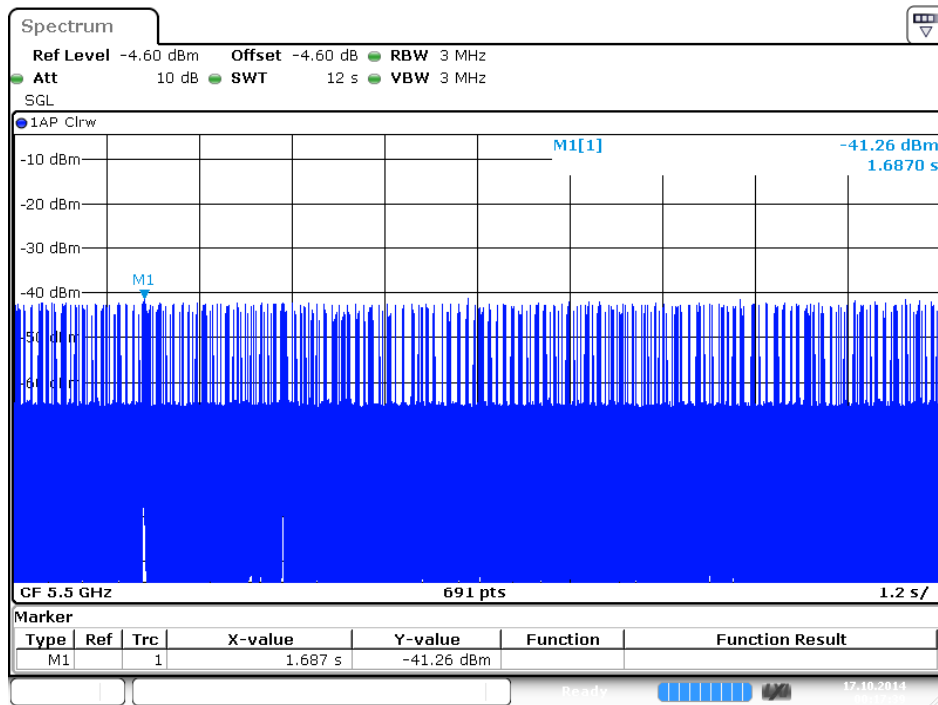

Date: 17.OCT.2014 00:17:39

Slave Data Traffic Plot (40MHz)

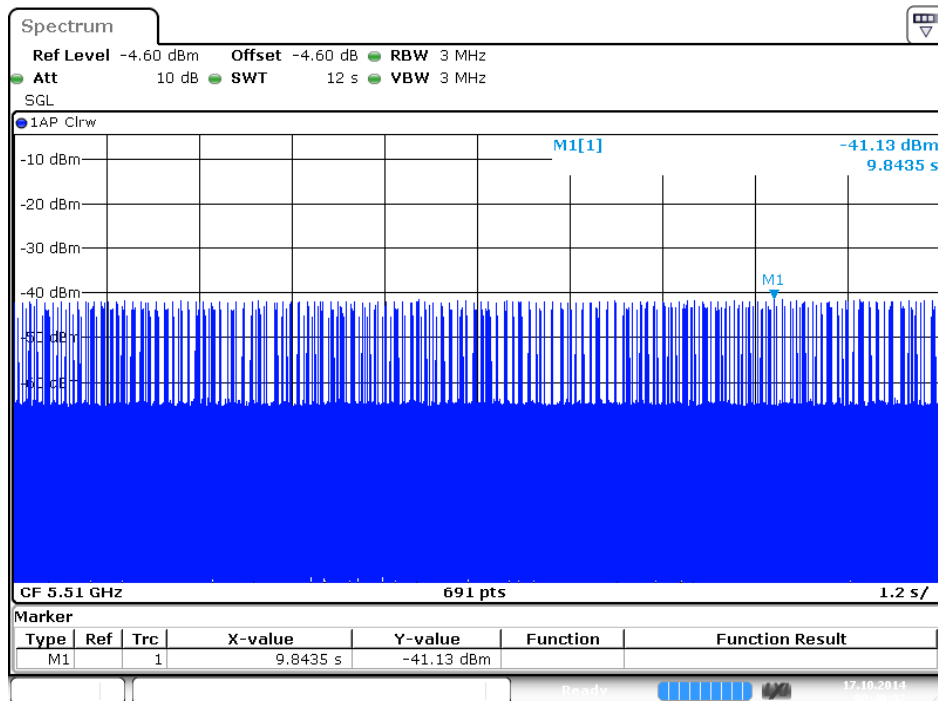

Date: 17.OCT.2014 00:40:03

Slave Data Traffic Plot (80MHz)

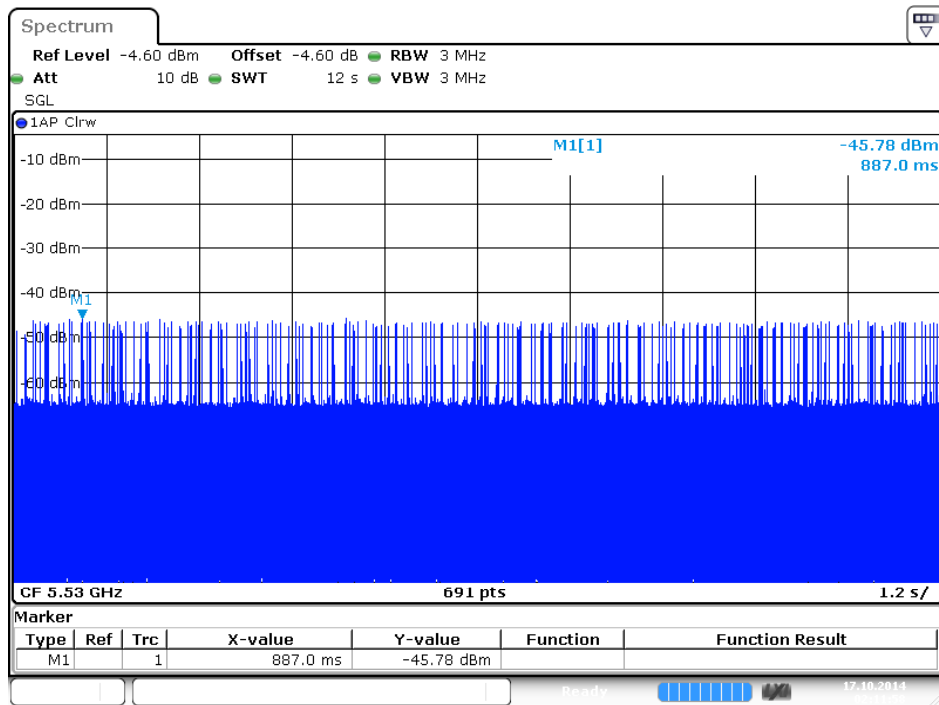

Date: 17.OCT.2014 02:11:58

Without Data Traffic Plot (Noise Plot) (20MHz)

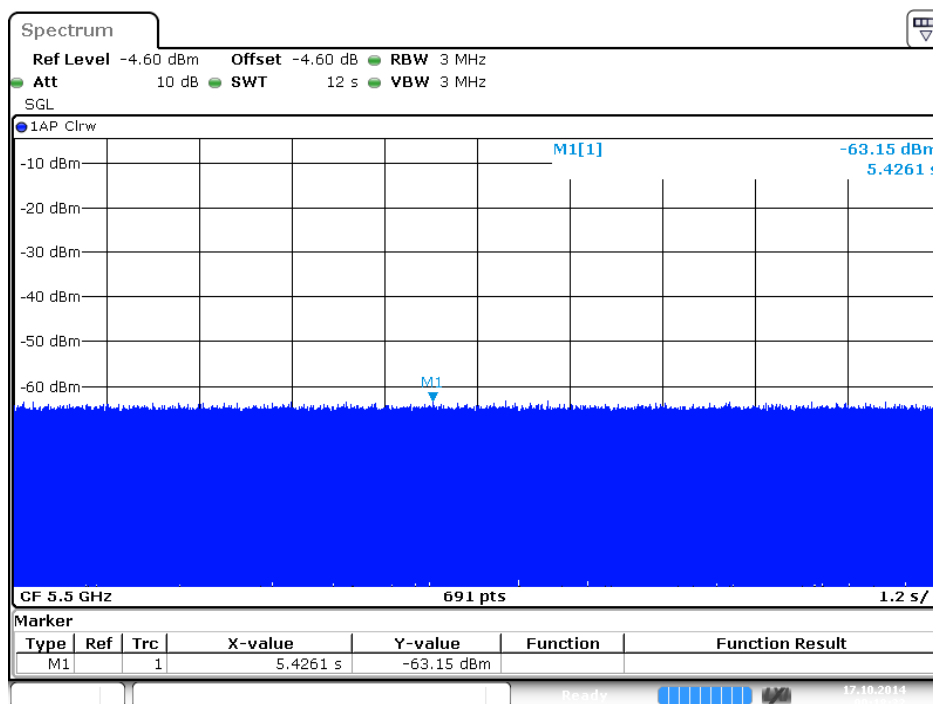

Date: 17.OCT.2014 00:18:33

Without Data Traffic Plot (Noise Plot) (40MHz)

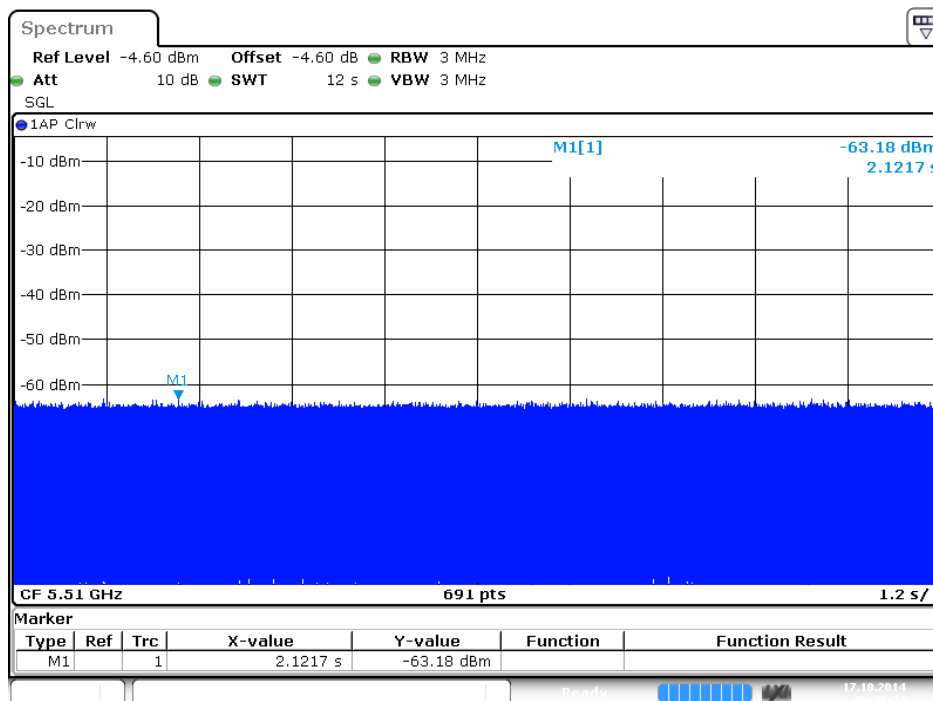

Date: 17.OCT.2014 00:40:23

Without Data Traffic Plot (Noise Plot) (80MHz)

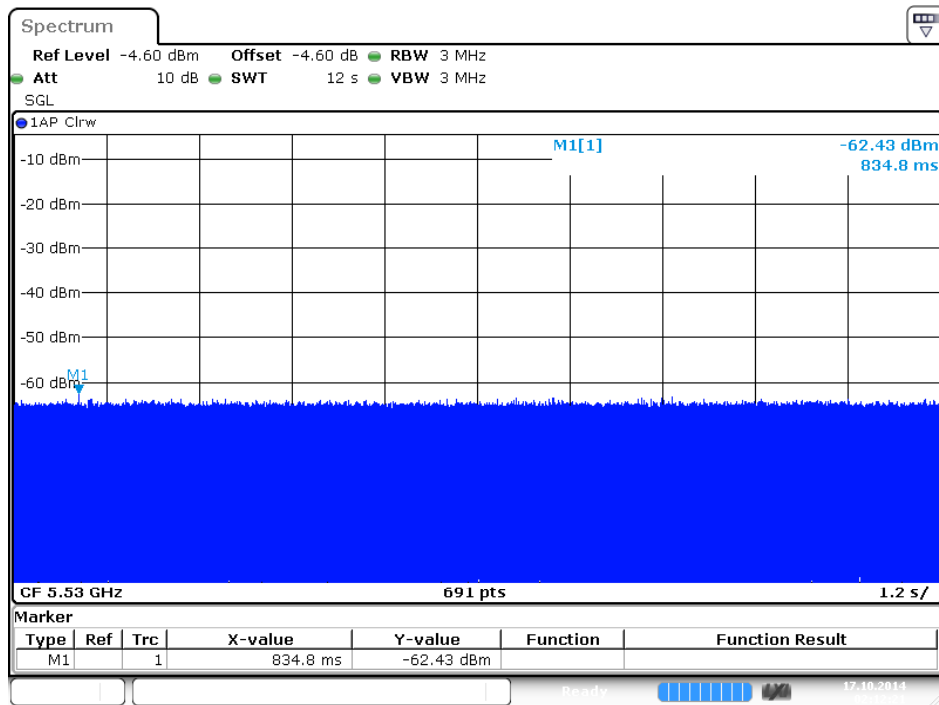

Date: 17.OCT.2014 02:12:21

5.1.2. Supporting Units

| Support Units | Brand | Model No. | Serial No. | FCC ID | Software Version |
|-------------------------|-------|-----------|------------|--------------|------------------|
| Notebook | DELL | D520 | NB-B | E2KWM3945ABG | Win XP |
| Notebook | DELL | D400 | NB-C | E2K24GBRL | Win XP |
| Wireless-AC USB Adapter | Cisco | AE6000 | DO-1 | Q87-AE6000 | 5.0.7.0 |

5.1.3. Test Setup Operation

System testing was performed with the designated MPEG test file that streams full motion video from the Access Point to the Client in full motion video mode using the media player with the V2.61 Codec package. This file is used by IP and Frame based systems for loading the test channel during the In-service compliance testing of the U-NII device.

The waveform parameters from within the bounds of the signal type are selected randomly using uniform distribution.

A spectrum analyzer is used as a monitor to verify that the EUT has vacated the Channel within the (Channel Closing Transmission Time and Channel Move Time, and does not transmit on a Channel during the Non-Occupancy Period after the detection and Channel move. It is also used to monitor EUT transmissions during the Channel Availability Check Time.

5.2. UNII Detection Bandwidth Measurement

5.2.1. Limit

Minimum 80% of the UNII 99% transmission power bandwidth. During the *U-NII Detection Bandwidth* detection test, radar type 1 is used and for each frequency step the minimum percentage of detection is 90 percent. Measurements are performed with no data traffic.

5.2.2. Test Procedures

1. Adjust the equipment to produce a single Burst of the Short Pulse Radar Type 1 at the center frequency of the EUT Operating Channel at the specified DFS Detection Threshold level.
2. The generating equipment is configured as shown in the Conducted Test Setup above section 5.1.1.
3. The EUT is set up as a stand-alone device (no associated Client and no traffic). Frame based systems will be set to a talk/listen ratio of 0%/100% during this test.
4. Generate single radar Burst, and note the response of the EUT. Repeat for a minimum of 10 trials. The EUT must detect the Radar Waveform using the specified U-NII Detection Bandwidth criterion.
5. Starting at the center frequency of the EUT operating Channel, increase the radar frequency in 1 MHz steps, repeating the above item 4 test sequence, until the detection rate falls below the U-NII Detection Bandwidth criterion. Record the highest frequency (denote as FH) at which detection is greater than or equal to the U-NII Detection Bandwidth criterion. Recording the detection rate at frequencies above FH is not required to demonstrate compliance.
6. Starting at the center frequency of the EUT operating Channel, decrease the radar frequency in 1 MHz steps, repeating the above item 4 test sequence, until the detection rate falls below the U-NII Detection Bandwidth criterion. Record the lowest frequency (denote as FL) at which detection is greater than or equal to the U-NII Detection Bandwidth criterion. Recording the detection rate at frequencies below FL is not required to demonstrate compliance.
7. The U-NII Detection Bandwidth is calculated as follows: $U\text{-NII Detection Bandwidth} = FH - FL$
8. The U-NII Detection Bandwidth must be at least 80% of the EUT transmitter 99% power, otherwise, the EUT does not comply with DFS requirements.

5.2.3. Test Deviation

There is no deviation with the original standard.

5.2.4. Test Result for UNII Detection Bandwidth

For 20MHz

| EUT Frequency=5500 MHz | | | | | | | | | | | |
|--|---|---|---|---|---|---|---|---|---|----|--------------------|
| Radar Frequency (MHz) | DFS Detection Trials (1=Detection, 0= No Detection) | | | | | | | | | | Detection Rate (%) |
| | 1 | 2 | 3 | 4 | 5 | 6 | 7 | 8 | 9 | 10 | |
| 5489 | 0 | 0 | 0 | 0 | 0 | 0 | 0 | 0 | 0 | 0 | 0% |
| 5490 | 0 | 0 | 0 | 0 | 0 | 0 | 0 | 0 | 0 | 0 | 0% |
| 5491 | 0 | 0 | 0 | 0 | 0 | 0 | 0 | 0 | 0 | 0 | 0% |
| 5492(FL) | 1 | 1 | 1 | 1 | 1 | 1 | 1 | 1 | 1 | 1 | 100% |
| 5493 | 1 | 1 | 1 | 1 | 1 | 1 | 1 | 1 | 1 | 1 | 100% |
| 5494 | 1 | 1 | 1 | 1 | 1 | 1 | 1 | 1 | 1 | 1 | 100% |
| 5495 | 1 | 1 | 1 | 1 | 1 | 1 | 1 | 1 | 1 | 1 | 100% |
| 5496 | 1 | 1 | 1 | 1 | 1 | 1 | 1 | 1 | 1 | 1 | 100% |
| 5497 | 1 | 1 | 1 | 1 | 1 | 1 | 1 | 1 | 1 | 1 | 100% |
| 5498 | 1 | 1 | 1 | 1 | 1 | 1 | 1 | 1 | 1 | 1 | 100% |
| 5499 | 1 | 1 | 1 | 1 | 1 | 1 | 1 | 1 | 1 | 1 | 100% |
| 5500 | 1 | 1 | 1 | 1 | 1 | 1 | 1 | 1 | 1 | 1 | 100% |
| 5501 | 1 | 1 | 1 | 1 | 1 | 1 | 1 | 1 | 1 | 1 | 100% |
| 5502 | 1 | 1 | 1 | 1 | 1 | 1 | 1 | 1 | 1 | 1 | 100% |
| 5503 | 1 | 1 | 1 | 1 | 1 | 1 | 1 | 1 | 1 | 1 | 100% |
| 5504 | 1 | 1 | 1 | 1 | 1 | 1 | 1 | 1 | 1 | 1 | 100% |
| 5505 | 1 | 1 | 1 | 1 | 1 | 1 | 1 | 1 | 1 | 1 | 100% |
| 5506 | 1 | 1 | 1 | 1 | 1 | 1 | 1 | 1 | 1 | 1 | 100% |
| 5507 | 1 | 1 | 1 | 1 | 1 | 1 | 1 | 1 | 1 | 1 | 100% |
| 5508 | 1 | 1 | 1 | 1 | 1 | 1 | 1 | 1 | 1 | 1 | 100% |
| 5509(FH) | 1 | 1 | 1 | 1 | 1 | 1 | 1 | 1 | 1 | 1 | 100% |
| 5510 | 0 | 0 | 0 | 0 | 0 | 0 | 0 | 0 | 0 | 0 | 0% |
| 5511 | 0 | 0 | 0 | 0 | 0 | 0 | 0 | 0 | 0 | 0 | 0% |
| Detection Bandwidth = (FH-FL)+1 = (5509MHz-5492MHz)+1 = 18MHz | | | | | | | | | | | |
| EUT 99% Bandwidth = 20MHz (see note) | | | | | | | | | | | |
| UNII Detection Bandwidth Min. Limit (MHz): 20MHz x 80% = 16MHz | | | | | | | | | | | |

Note: All UNII channels for this device have identical Channel bandwidths. Therefore, all DFS testing was done at 5500 MHz. The 99% channel bandwidth is 20MHz. (See the 99% BW section of the RF report for further measurement details).

For 40MHz

| EUT Frequency=5510 MHz | | | | | | | | | | | |
|------------------------|---|---|---|---|---|---|---|---|---|----|--------------------|
| Radar Frequency (MHz) | DFS Detection Trials (1=Detection, 0= No Detection) | | | | | | | | | | Detection Rate (%) |
| | 1 | 2 | 3 | 4 | 5 | 6 | 7 | 8 | 9 | 10 | |
| 5490 | 0 | 0 | 0 | 0 | 0 | 0 | 0 | 0 | 0 | 0 | 0% |
| 5491 | 0 | 0 | 0 | 0 | 0 | 0 | 0 | 0 | 0 | 0 | 0% |
| 5492 | 0 | 0 | 0 | 0 | 0 | 0 | 0 | 0 | 0 | 0 | 0% |
| 5493 | 0 | 0 | 0 | 0 | 0 | 0 | 0 | 0 | 0 | 0 | 0% |
| 5494(FL) | 1 | 1 | 1 | 1 | 1 | 1 | 1 | 1 | 1 | 1 | 100% |
| 5495 | 1 | 1 | 1 | 1 | 1 | 1 | 1 | 1 | 1 | 1 | 100% |
| 5496 | 1 | 1 | 1 | 1 | 1 | 1 | 1 | 1 | 1 | 1 | 100% |
| 5497 | 1 | 1 | 1 | 1 | 1 | 1 | 1 | 1 | 1 | 1 | 100% |
| 5498 | 1 | 1 | 1 | 1 | 1 | 1 | 1 | 1 | 1 | 1 | 100% |
| 5499 | 1 | 1 | 1 | 1 | 1 | 1 | 1 | 1 | 1 | 1 | 100% |
| 5500 | 1 | 1 | 1 | 1 | 1 | 1 | 1 | 1 | 1 | 1 | 100% |
| 5501 | 1 | 1 | 1 | 1 | 1 | 1 | 1 | 1 | 1 | 1 | 100% |
| 5502 | 1 | 1 | 1 | 1 | 1 | 1 | 1 | 1 | 1 | 1 | 100% |
| 5503 | 1 | 1 | 1 | 1 | 1 | 1 | 1 | 1 | 1 | 1 | 100% |
| 5504 | 1 | 1 | 1 | 1 | 1 | 1 | 1 | 1 | 1 | 1 | 100% |
| 5505 | 1 | 1 | 1 | 1 | 1 | 1 | 1 | 1 | 1 | 1 | 100% |
| 5506 | 1 | 1 | 1 | 1 | 1 | 1 | 1 | 1 | 1 | 1 | 100% |
| 5507 | 1 | 1 | 1 | 1 | 1 | 1 | 1 | 1 | 1 | 1 | 100% |
| 5508 | 1 | 1 | 1 | 1 | 1 | 1 | 1 | 1 | 1 | 1 | 100% |
| 5509 | 1 | 1 | 1 | 1 | 1 | 1 | 1 | 1 | 1 | 1 | 100% |
| 5510 | 1 | 1 | 1 | 1 | 1 | 1 | 1 | 1 | 1 | 1 | 100% |
| 5511 | 1 | 1 | 1 | 1 | 1 | 1 | 1 | 1 | 1 | 1 | 100% |
| 5512 | 1 | 1 | 1 | 1 | 1 | 1 | 1 | 1 | 1 | 1 | 100% |
| 5513 | 1 | 1 | 1 | 1 | 1 | 1 | 1 | 1 | 1 | 1 | 100% |
| 5514 | 1 | 1 | 1 | 1 | 1 | 1 | 1 | 1 | 1 | 1 | 100% |
| 5515 | 1 | 1 | 1 | 1 | 1 | 1 | 1 | 1 | 1 | 1 | 100% |
| 5516 | 1 | 1 | 1 | 1 | 1 | 1 | 1 | 1 | 1 | 1 | 100% |
| 5517 | 1 | 1 | 1 | 1 | 1 | 1 | 1 | 1 | 1 | 1 | 100% |
| 5518 | 1 | 1 | 1 | 1 | 1 | 1 | 1 | 1 | 1 | 1 | 100% |
| 5519 | 1 | 1 | 1 | 1 | 1 | 1 | 1 | 1 | 1 | 1 | 100% |
| 5520 | 1 | 1 | 1 | 1 | 1 | 1 | 1 | 1 | 1 | 1 | 100% |
| 5521 | 1 | 1 | 1 | 1 | 1 | 1 | 1 | 1 | 1 | 1 | 100% |

| | | | | | | | | | | | |
|--|---|---|---|---|---|---|---|---|---|---|------|
| 5522 | 1 | 1 | 1 | 1 | 1 | 1 | 1 | 1 | 1 | 1 | 100% |
| 5523 | 1 | 1 | 1 | 1 | 1 | 1 | 1 | 1 | 1 | 1 | 100% |
| 5524 | 1 | 1 | 1 | 1 | 1 | 1 | 1 | 1 | 1 | 1 | 100% |
| 5525 | 1 | 1 | 1 | 1 | 1 | 1 | 1 | 1 | 1 | 1 | 100% |
| 5526 | 1 | 1 | 1 | 1 | 1 | 1 | 1 | 1 | 1 | 1 | 100% |
| 5527 | 1 | 1 | 1 | 1 | 1 | 1 | 1 | 1 | 1 | 1 | 100% |
| 5528(FH) | 1 | 1 | 1 | 1 | 1 | 1 | 1 | 1 | 1 | 1 | 100% |
| 5529 | 0 | 0 | 0 | 0 | 0 | 0 | 0 | 0 | 0 | 0 | 0% |
| 5530 | 0 | 0 | 0 | 0 | 0 | 0 | 0 | 0 | 0 | 0 | 0% |
| Detection Bandwidth = (FH-FL)+1 = (5528MHz-5494MHz)+1 = 35MHz | | | | | | | | | | | |
| EUT 99% Bandwidth = 40MHz (see note) | | | | | | | | | | | |
| UNII Detection Bandwidth Min. Limit (MHz): 40MHz x 80% = 32MHz | | | | | | | | | | | |

Note: All UNII channels for this device have identical Channel bandwidths. Therefore, all DFS testing was done at 5510 MHz. The 99% channel bandwidth is 40MHz. (See the 99% BW section of the RF report for further measurement details).



For 80MHz

| EUT Frequency=5530 MHz | | | | | | | | | | | |
|------------------------|---|---|---|---|---|---|---|---|---|----|--------------------|
| Radar Frequency (MHz) | DFS Detection Trials (1=Detection, 0= No Detection) | | | | | | | | | | Detection Rate (%) |
| | 1 | 2 | 3 | 4 | 5 | 6 | 7 | 8 | 9 | 10 | |
| 5490 | 0 | 0 | 0 | 0 | 0 | 0 | 0 | 0 | 0 | 0 | 0% |
| 5491 | 0 | 0 | 0 | 0 | 0 | 0 | 0 | 0 | 0 | 0 | 0% |
| 5492 | 0 | 0 | 0 | 0 | 0 | 0 | 0 | 0 | 0 | 0 | 0% |
| 5493 | 0 | 0 | 0 | 0 | 0 | 0 | 0 | 0 | 0 | 0 | 0% |
| 5494 | 0 | 0 | 0 | 0 | 0 | 0 | 0 | 0 | 0 | 0 | 0% |
| 5495 | 0 | 0 | 0 | 0 | 0 | 0 | 0 | 0 | 0 | 0 | 0% |
| 5496(FL) | 1 | 1 | 1 | 1 | 1 | 1 | 1 | 1 | 1 | 1 | 100% |
| 5497 | 1 | 1 | 1 | 1 | 1 | 1 | 1 | 1 | 1 | 1 | 100% |
| 5498 | 1 | 1 | 1 | 1 | 1 | 1 | 1 | 1 | 1 | 1 | 100% |
| 5499 | 1 | 1 | 1 | 1 | 1 | 1 | 1 | 1 | 1 | 1 | 100% |
| 5500 | 1 | 1 | 1 | 1 | 1 | 1 | 1 | 1 | 1 | 1 | 100% |
| 5501 | 1 | 1 | 1 | 1 | 1 | 1 | 1 | 1 | 1 | 1 | 100% |
| 5502 | 1 | 1 | 1 | 1 | 1 | 1 | 1 | 1 | 1 | 1 | 100% |
| 5503 | 1 | 1 | 1 | 1 | 1 | 1 | 1 | 1 | 1 | 1 | 100% |
| 5504 | 1 | 1 | 1 | 1 | 1 | 1 | 1 | 1 | 1 | 1 | 100% |
| 5505 | 1 | 1 | 1 | 1 | 1 | 1 | 1 | 1 | 1 | 1 | 100% |
| 5506 | 1 | 1 | 1 | 1 | 1 | 1 | 1 | 1 | 1 | 1 | 100% |
| 5507 | 1 | 1 | 1 | 1 | 1 | 1 | 1 | 1 | 1 | 1 | 100% |
| 5508 | 1 | 1 | 1 | 1 | 1 | 1 | 1 | 1 | 1 | 1 | 100% |
| 5509 | 1 | 1 | 1 | 1 | 1 | 1 | 1 | 1 | 1 | 1 | 100% |
| 5510 | 1 | 1 | 1 | 1 | 1 | 1 | 1 | 1 | 1 | 1 | 100% |
| 5511 | 1 | 1 | 1 | 1 | 1 | 1 | 1 | 1 | 1 | 1 | 100% |
| 5512 | 1 | 1 | 1 | 1 | 1 | 1 | 1 | 1 | 1 | 1 | 100% |
| 5513 | 1 | 1 | 1 | 1 | 1 | 1 | 1 | 1 | 1 | 1 | 100% |
| 5514 | 1 | 1 | 1 | 1 | 1 | 1 | 1 | 1 | 1 | 1 | 100% |
| 5515 | 1 | 1 | 1 | 1 | 1 | 1 | 1 | 1 | 1 | 1 | 100% |
| 5516 | 1 | 1 | 1 | 1 | 1 | 1 | 1 | 1 | 1 | 1 | 100% |
| 5517 | 1 | 1 | 1 | 1 | 1 | 1 | 1 | 1 | 1 | 1 | 100% |
| 5518 | 1 | 1 | 1 | 1 | 1 | 1 | 1 | 1 | 1 | 1 | 100% |
| 5519 | 1 | 1 | 1 | 1 | 1 | 1 | 1 | 1 | 1 | 1 | 100% |
| 5520 | 1 | 1 | 1 | 1 | 1 | 1 | 1 | 1 | 1 | 1 | 100% |
| 5521 | 1 | 1 | 1 | 1 | 1 | 1 | 1 | 1 | 1 | 1 | 100% |



| | | | | | | | | | | | |
|------|---|---|---|---|---|---|---|---|---|---|------|
| 5522 | 1 | 1 | 1 | 1 | 1 | 1 | 1 | 1 | 1 | 1 | 100% |
| 5523 | 1 | 1 | 1 | 1 | 1 | 1 | 1 | 1 | 1 | 1 | 100% |
| 5524 | 1 | 1 | 1 | 1 | 1 | 1 | 1 | 1 | 1 | 1 | 100% |
| 5525 | 1 | 1 | 1 | 1 | 1 | 1 | 1 | 1 | 1 | 1 | 100% |
| 5526 | 1 | 1 | 1 | 1 | 1 | 1 | 1 | 1 | 1 | 1 | 100% |
| 5527 | 1 | 1 | 1 | 1 | 1 | 1 | 1 | 1 | 1 | 1 | 100% |
| 5528 | 1 | 1 | 1 | 1 | 1 | 1 | 1 | 1 | 1 | 1 | 100% |
| 5529 | 1 | 1 | 1 | 1 | 1 | 1 | 1 | 1 | 1 | 1 | 100% |
| 5530 | 1 | 1 | 1 | 1 | 1 | 1 | 1 | 1 | 1 | 1 | 100% |
| 5531 | 1 | 1 | 1 | 1 | 1 | 1 | 1 | 1 | 1 | 1 | 100% |
| 5532 | 1 | 1 | 1 | 1 | 1 | 1 | 1 | 1 | 1 | 1 | 100% |
| 5533 | 1 | 1 | 1 | 1 | 1 | 1 | 1 | 1 | 1 | 1 | 100% |
| 5534 | 1 | 1 | 1 | 1 | 1 | 1 | 1 | 1 | 1 | 1 | 100% |
| 5535 | 1 | 1 | 1 | 1 | 1 | 1 | 1 | 1 | 1 | 1 | 100% |
| 5536 | 1 | 1 | 1 | 1 | 1 | 1 | 1 | 1 | 1 | 1 | 100% |
| 5537 | 1 | 1 | 1 | 1 | 1 | 1 | 1 | 1 | 1 | 1 | 100% |
| 5538 | 1 | 1 | 1 | 1 | 1 | 1 | 1 | 1 | 1 | 1 | 100% |
| 5539 | 1 | 1 | 1 | 1 | 1 | 1 | 1 | 1 | 1 | 1 | 100% |
| 5540 | 1 | 1 | 1 | 1 | 1 | 1 | 1 | 1 | 1 | 1 | 100% |
| 5541 | 1 | 1 | 1 | 1 | 1 | 1 | 1 | 1 | 1 | 1 | 100% |
| 5542 | 1 | 1 | 1 | 1 | 1 | 1 | 1 | 1 | 1 | 1 | 100% |
| 5543 | 1 | 1 | 1 | 1 | 1 | 1 | 1 | 1 | 1 | 1 | 100% |
| 5544 | 1 | 1 | 1 | 1 | 1 | 1 | 1 | 1 | 1 | 1 | 100% |
| 5545 | 1 | 1 | 1 | 1 | 1 | 1 | 1 | 1 | 1 | 1 | 100% |
| 5546 | 1 | 1 | 1 | 1 | 1 | 1 | 1 | 1 | 1 | 1 | 100% |
| 5547 | 1 | 1 | 1 | 1 | 1 | 1 | 1 | 1 | 1 | 1 | 100% |
| 5548 | 1 | 1 | 1 | 1 | 1 | 1 | 1 | 1 | 1 | 1 | 100% |
| 5549 | 1 | 1 | 1 | 1 | 1 | 1 | 1 | 1 | 1 | 1 | 100% |
| 5550 | 1 | 1 | 1 | 1 | 1 | 1 | 1 | 1 | 1 | 1 | 100% |
| 5551 | 1 | 1 | 1 | 1 | 1 | 1 | 1 | 1 | 1 | 1 | 100% |
| 5552 | 1 | 1 | 1 | 1 | 1 | 1 | 1 | 1 | 1 | 1 | 100% |
| 5553 | 1 | 1 | 1 | 1 | 1 | 1 | 1 | 1 | 1 | 1 | 100% |
| 5554 | 1 | 1 | 1 | 1 | 1 | 1 | 1 | 1 | 1 | 1 | 100% |
| 5555 | 1 | 1 | 1 | 1 | 1 | 1 | 1 | 1 | 1 | 1 | 100% |
| 5556 | 1 | 1 | 1 | 1 | 1 | 1 | 1 | 1 | 1 | 1 | 100% |
| 5557 | 1 | 1 | 1 | 1 | 1 | 1 | 1 | 1 | 1 | 1 | 100% |
| 5558 | 1 | 1 | 1 | 1 | 1 | 1 | 1 | 1 | 1 | 1 | 100% |

| | | | | | | | | | | | |
|----------|---|---|---|---|---|---|---|---|---|---|------|
| 5559 | 1 | 1 | 1 | 1 | 1 | 1 | 1 | 1 | 1 | 1 | 100% |
| 5560 | 1 | 1 | 1 | 1 | 1 | 1 | 1 | 1 | 1 | 1 | 100% |
| 5561 | 1 | 1 | 1 | 1 | 1 | 1 | 1 | 1 | 1 | 1 | 100% |
| 5562(FH) | 1 | 1 | 1 | 1 | 1 | 1 | 1 | 1 | 1 | 1 | 100% |
| 5563 | 0 | 0 | 0 | 0 | 0 | 0 | 0 | 0 | 0 | 0 | 0% |
| 5564 | 0 | 0 | 0 | 0 | 0 | 0 | 0 | 0 | 0 | 0 | 0% |
| 5565 | 0 | 0 | 0 | 0 | 0 | 0 | 0 | 0 | 0 | 0 | 0% |

Detection Bandwidth = (FH-FL)+1 = (5562MHz-5496MHz)+1 = 67MHz

EUT 99% Bandwidth = 80MHz (see note)

UNII Detection Bandwidth Min. Limit (MHz): 80MHz x 80% = 64MHz

Note: All UNII channels for this device have identical Channel bandwidths. Therefore, all DFS testing was done at 5530 MHz. The 99% channel bandwidth is 80MHz. (See the 99% BW section of the RF report for further measurement details).

5.3. Initial Channel Availability Check Time Measurement

5.3.1. Limit

The EUT shall perform a Channel Availability Check to ensure that there is no radar operating on the channel. After power-up sequence, receive at least 1 minute on the intended operating frequency.

5.3.2. Test Procedures

1. The U-NII devices will be powered on and be instructed to operate on the appropriate 5500 MHz (for 20MHz), 5510 MHz (for 40MHz), 5530 MHz (for 80MHz). The spectrum analyzer will be set to zero span mode with a 3 MHz RBW and 3 MHz VBW on the *Channel* occupied by the radar (Ch_r) with a 300 seconds sweep time. The spectrum analyzer's sweep will be started at the same time power is applied to the U-NII device.
2. The EUT should not transmit any beacon or data transmissions until at least 1 minute after the completion of the power-on cycle. Measurement system showing its nominal noise floor is marker 1.

5.3.3. Test Deviation

There is no deviation with the original standard.

5.3.4. Test Result for Initial Channel Availability Check Time

For 20MHz

The EUT does not transmit any beacon or data transmissions until at least 1 minute after the completion of the power-on cycle (131.3 sec). The initial power up time of the EUT is indicated by marker 1 (131.3 sec). Initial beacons/data transmissions are indicated by marker 2 (191.3 sec).

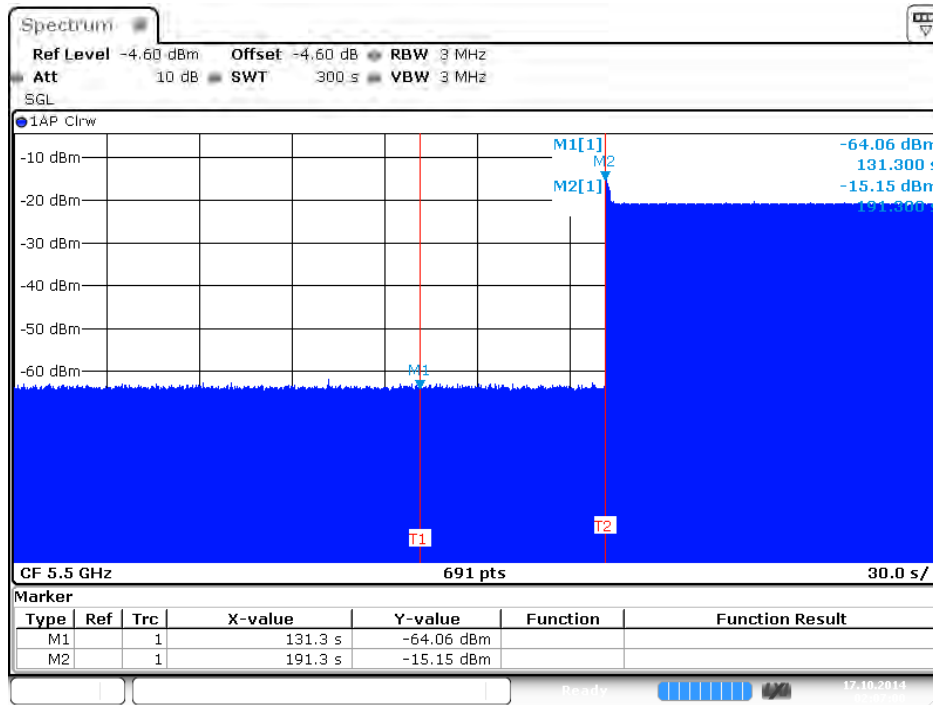

Date: 17.OCT.2014 02:07:01

For 40MHz

The EUT does not transmit any beacon or data transmissions until at least 1 minute after the completion of the power-on cycle (132.3 sec). The initial power up time of the EUT is indicated by marker 1 (132.3 sec). Initial beacons/data transmissions are indicated by marker 2 (192.3 sec).

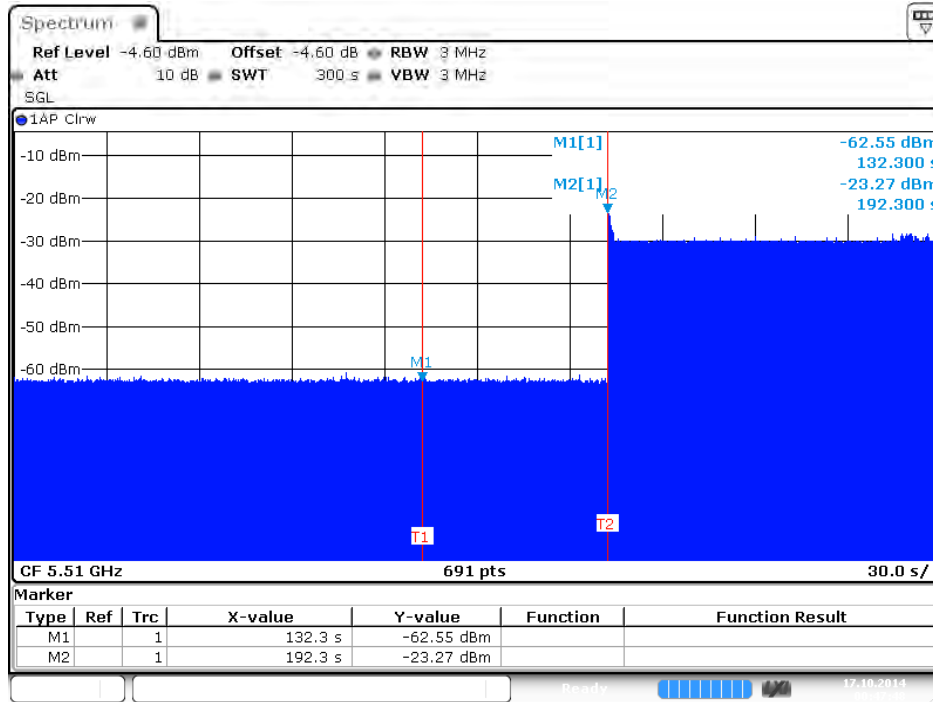

Date: 17.OCT.2014 00:47:48

For 80MHz

The EUT does not transmit any beacon or data transmissions until at least 1 minute after the completion of the power-on cycle (130.6 sec). The initial power up time of the EUT is indicated by marker 1 (130.6 sec). Initial beacons/data transmissions are indicated by marker 2 (190.6 sec).

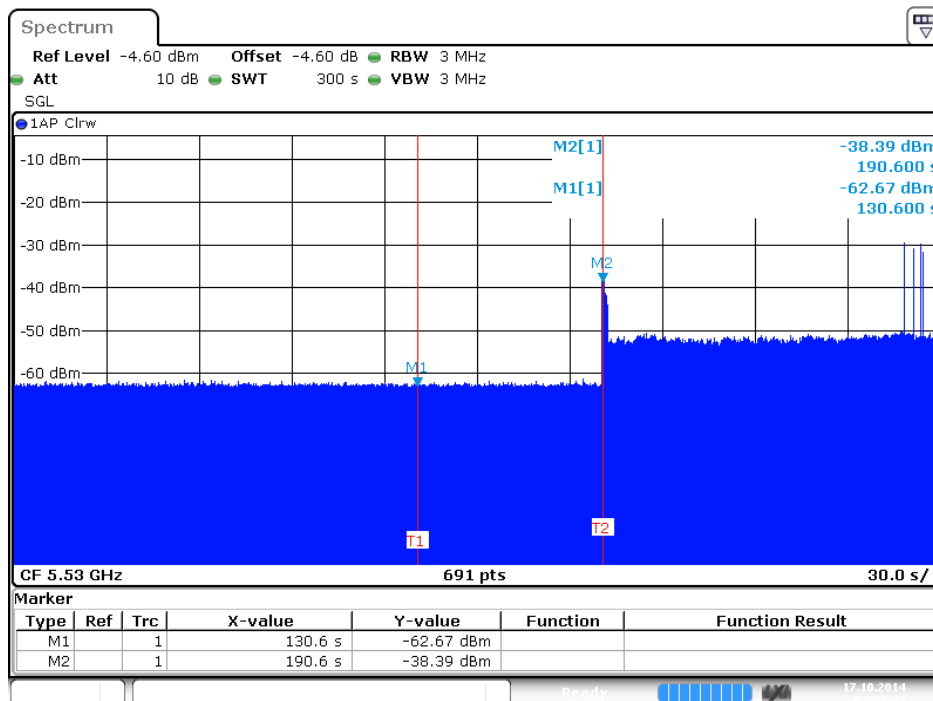

Date: 17.OCT.2014 02:20:07

5.4. Radar Burst at the Beginning of the Channel Availability Check Time Measurement

5.4.1. Limit

In beginning of the Channel Availability Check (CAC) Time, radar is detected on this channel, select another intended channel and perform a CAC on that channel.

5.4.2. Test Procedures

1. The steps below define the procedure to verify successful radar detection on the selected Channel during a period equal to the Channel Availability Check Time and avoidance of operation on that Channel when a radar Burst with a level equal to the DFS Detection Threshold + 1 dB occurs at the beginning of the Channel Availability Check Time.
2. The EUT is in completion power-up cycle (from T0 to T1). T1 denotes the instant when the EUT has completed its power-up sequence. The Channel Availability Check Time commences at instant T1 and will end no sooner than $T1 + 60$ seconds. A single Burst of short pulse of radar type 1 at DFS Detection Threshold + 1 dB will commence within a 6 second window starting at T1.
3. Visual indication on the EUT of successful detection of the radar Burst will be recorded and reported. Observation of emissions at 5500 MHz (for 20MHz), 5510 MHz (for 40MHz), 5530 MHz (for 80MHz) will continue for 163.91 seconds (for 20MHz), 164.00 seconds (for 40MHz), 164.40 seconds (for 80MHz) after the radar Burst has been generated. Verify that during the 300 seconds measurement window no EUT transmissions occurred at 5500 MHz (for 20MHz), 5510 MHz (for 40MHz), 5530 MHz (for 80MHz).

5.4.3. Test Deviation

There is no deviation with the original standard.

5.4.4. Results of Radar Burst at the Beginning of the Channel Availability Check Time

For 20MHz

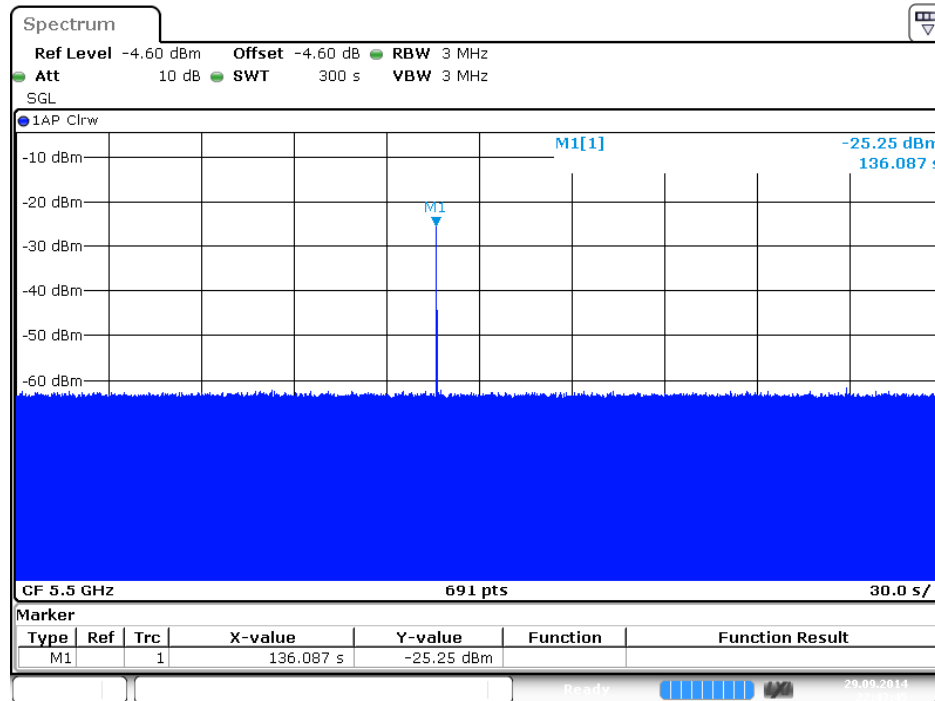

Date: 29.SEP.2014 22:43:45

For 40MHz

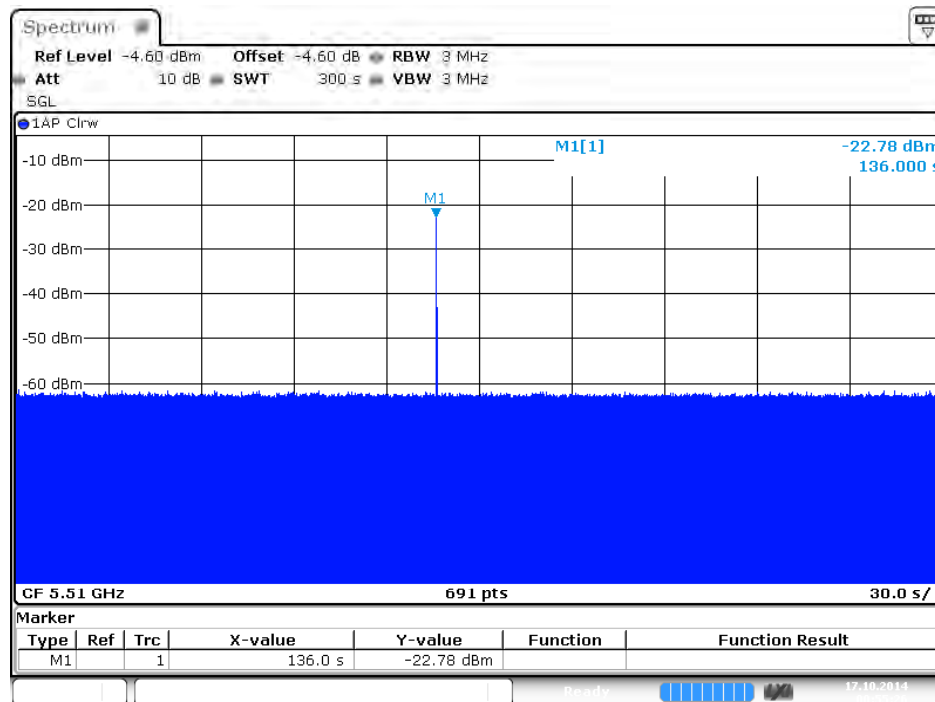

Date: 17.OCT.2014 00:55:26

For 80MHz

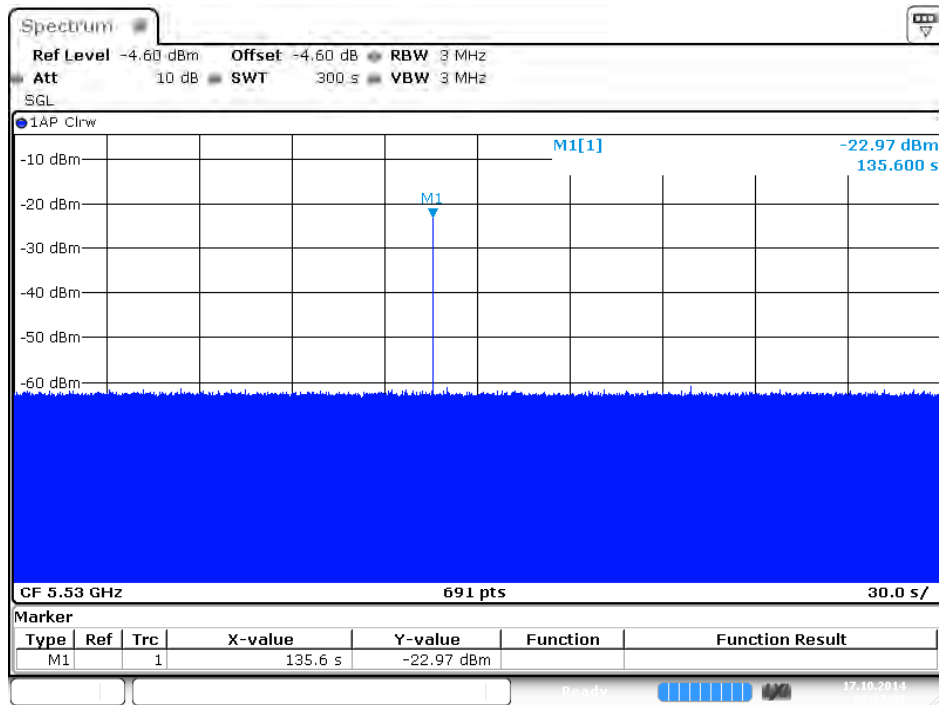

Date: 17.OCT.2014 02:27:08

5.5. Radar Burst at the End of the Channel Availability Check Time Measurement

5.5.1. Limit

In the end of Channel Availability Check (CAC) Time, radar is detected on this channel, select another intended channel and perform a CAC on that channel.

5.5.2. Test Procedures

1. The steps below define the procedure to verify successful radar detection on the selected Channel during a period equal to the Channel Availability Check Time and avoidance of operation on that Channel when a radar Burst with a level equal to the DFS Detection Threshold + 1 dB occurs at the end of the Channel Availability Check Time.
2. The EUT is powered on at T0. T1 denotes the instant when the EUT has completed its power-up sequence. The Channel Availability Check Time commences at instant T1 and will end no sooner than $T1 + 60$ seconds. A single Burst of short pulse of radar type 1 at DFS Detection Threshold + 1 dB will commence within a 6 second window starting at $T1 + 54$ seconds.
3. Visual indication on the EUT of successful detection of the radar Burst will be recorded and reported. Observation of emissions at 5500 MHz (for 20MHz), 5510 MHz (for 40MHz), 5530 MHz (for 80MHz) will continue for 111.70 seconds (for 20MHz), 110.00 seconds (for 40MHz), 110.60 seconds (for 80MHz) after the radar Burst has been generated. Verify that during the 300 seconds measurement window no EUT transmissions occurred at 5500 MHz (for 20MHz), 5510 MHz (for 40MHz), 5530 MHz (for 80MHz).

5.5.3. Test Deviation

There is no deviation with the original standard.

5.5.4. Results of Radar Burst at the end of the Channel Availability Check Time

For 20MHz

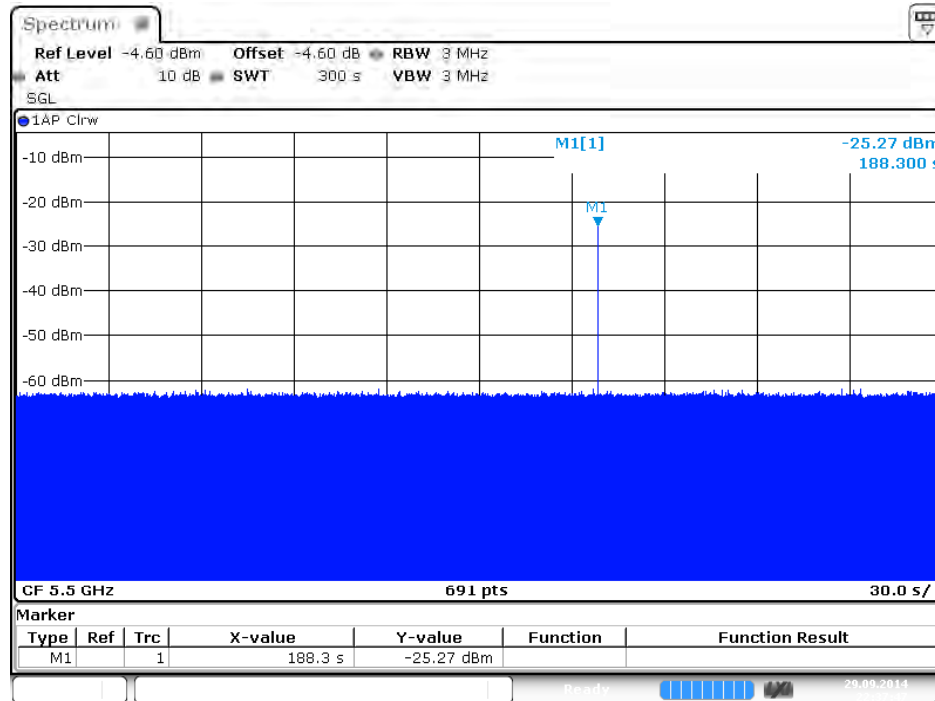

Date: 29.SEP.2014 22:37:47

For 40MHz

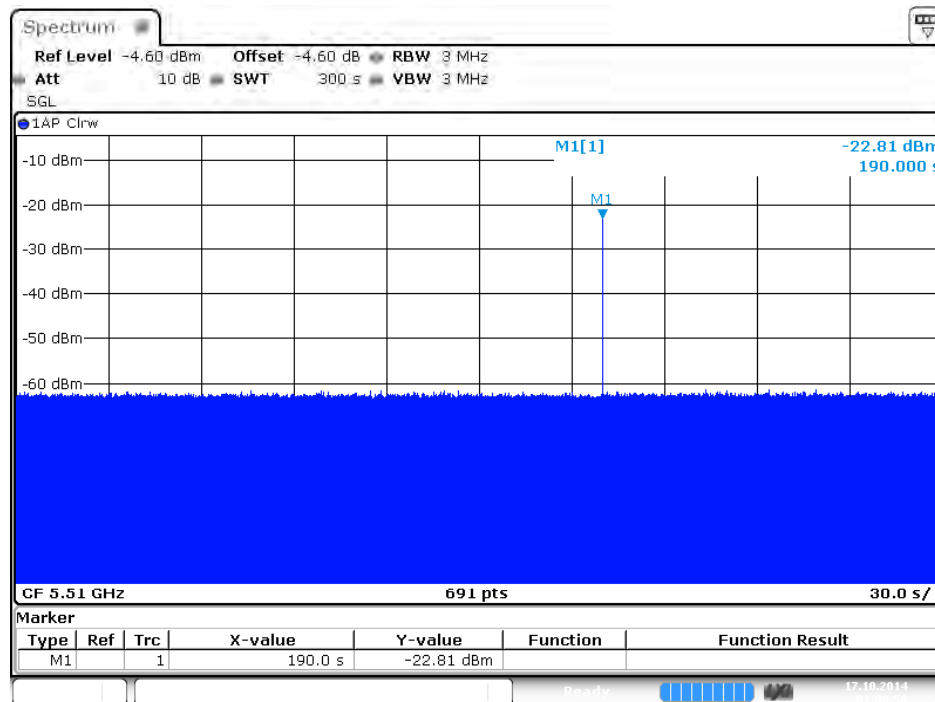

Date: 17.OCT.2014 01:00:56

For 80MHz

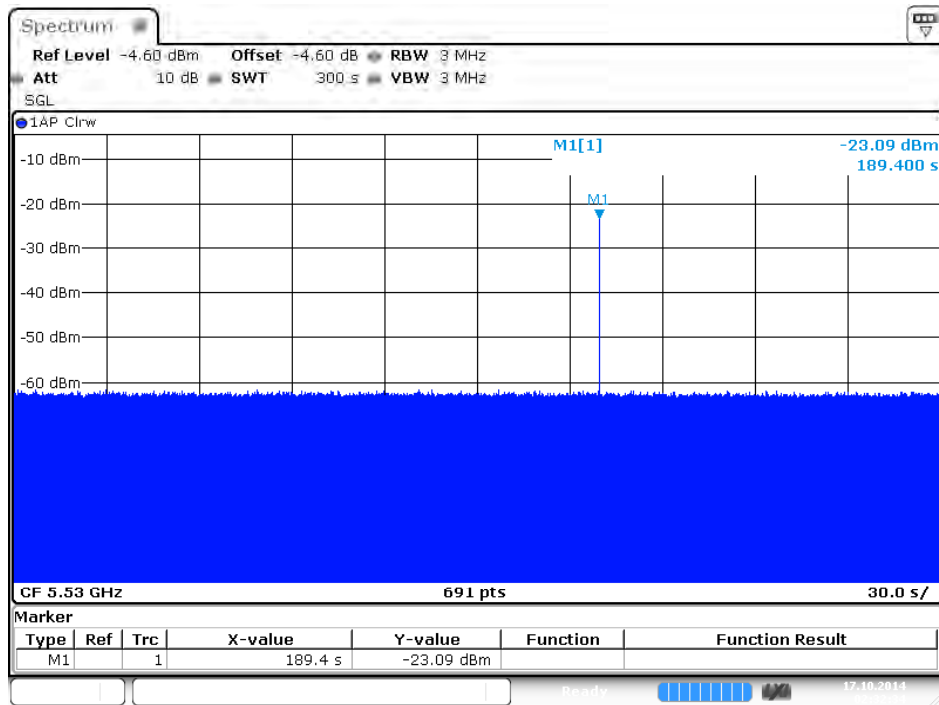

Date: 17.OCT.2014 02:32:35

5.6. In-Service Monitoring for Channel Move Time, Channel Closing Transmission Time and Non-Occupancy Period Measurement

5.6.1. Limit

The EUT has In-Service Monitoring function to continuously monitor the radar signals, If radar is detected, must leave the channel (Shutdown). The Channel Move Time to cease all transmissions on the current Channel upon detection of a Radar Waveform above the DFS Detection Threshold within 10 sec. The total duration of Channel Closing Transmission Time is 260ms, consisting of data signals and the aggregate of control signals, by a U-NII device during the Channel Move Time. The Non-Occupancy Period time is 30 minute during which a Channel will not be utilized after a Radar Waveform is detected on that Channel.

5.6.2. Test Procedures

1. When a radar Burst with a level equal to the DFS Detection Threshold + 1dB is generated on the Operating Channel of the U-NII device. A U-NII device operating as a Client Device will associate with the Master at Channel. Stream the MPEG test file from the Master Device to the Client Device on the selected Channel for the entire period of the test. At time T₀ the Radar Waveform generator sends a Burst of pulses for each of the radar types at Detection Threshold + 1dB.
2. Observe the transmissions of the EUT at the end of the radar Burst on the Operating Channel. Measure and record the transmissions from the EUT during the observation time (Channel Move Time). One 12 second plot been reported for the Short Pulse Radar Types 1 and one for the Long Pulse Radar Type test in a 22 second plot. The plot for the Short Pulse Radar Types start at the end of the radar burst. The *Channel Move Time* will be calculated based on the plot of the Short Pulse Radar Type. The Short Pulse Radar Type plot show the device ceased transmissions within the 10 second window after detection has occurred. The plot for the Long Pulse Radar Type should start at the beginning of the 12 second waveform.
3. Measurement of the aggregate duration of the Channel Closing Transmission Time method. With the spectrum analyzer set to zero span tuned to the center frequency of the EUT operating channel at the radar simulated frequency, peak detection, and max hold, the dwell time per bin is given by: $Dwell = S / B$; where **Dwell** is the dwell time per spectrum analyzer sampling bin, **S** is the sweep time and **B** is the number of spectrum analyzer sampling bins. An upper bound of the aggregate duration of the intermittent control signals of *Channel Closing Transmission Time* is calculated by: $C = N \times Dwell$; where **C** is the Closing Time, **N** is the number of spectrum analyzer sampling bins (intermittent control signals) showing a U-NII transmission and **Dwell** is the dwell time per bin.
4. Measure the EUT for more than 30 minutes following the channel close/move time to verify that the EUT does not resume any transmissions on this Channel.

5.6.3. Test Deviation

There is no deviation with the original standard.

5.6.4. Result of Channel Move Time, Channel Closing Transmission Time and Non-Occupancy Period

For 20MHz

| Parameter | Test Result | | Limit |
|---|-------------|----------|---------------|
| | Type 1 | Type 5 | |
| Test Channel (MHz) | 5500 MHz | 5500 MHz | - |
| Channel Move Time (sec.) | 0.1217 | 0 | < 10s |
| Channel Closing Transmission Time (ms) (Note) | 0 | 0 | < 60ms |
| Non-Occupancy Period (min.) | ≥ 30 | - | ≥ 30 min |

Note: The Channel Closing Transmission Time is comprised of 200 milliseconds starting at the beginning of the Channel Move Time plus any additional intermittent control signals required to facilitate a Channel move (an aggregate of 60 milliseconds) during the remainder of the 10 seconds period. The aggregate duration of control signals will not count quiet periods in between transmissions.

For 40MHz

| Parameter | Test Result | | Limit |
|---|-------------|----------|---------------|
| | Type 1 | Type 5 | |
| Test Channel (MHz) | 5510 MHz | 5510 MHz | - |
| Channel Move Time (sec.) | 0.0870 | 0 | < 10s |
| Channel Closing Transmission Time (ms) (Note) | 0 | 0 | < 60ms |
| Non-Occupancy Period (min.) | ≥ 30 | - | ≥ 30 min |

Note: The Channel Closing Transmission Time is comprised of 200 milliseconds starting at the beginning of the Channel Move Time plus any additional intermittent control signals required to facilitate a Channel move (an aggregate of 60 milliseconds) during the remainder of the 10 seconds period. The aggregate duration of control signals will not count quiet periods in between transmissions.

For 80MHz

| Parameter | Test Result | | Limit |
|---|-------------|----------|---------------|
| | Type 1 | Type 5 | |
| Test Channel (MHz) | 5530 MHz | 5530 MHz | - |
| Channel Move Time (sec.) | 0.1043 | 0 | < 10s |
| Channel Closing Transmission Time (ms) (Note) | 0 | 0 | < 60ms |
| Non-Occupancy Period (min.) | ≥ 30 | - | ≥ 30 min |

Note: The Channel Closing Transmission Time is comprised of 200 milliseconds starting at the beginning of the Channel Move Time plus any additional intermittent control signals required to facilitate a Channel move (an aggregate of 60 milliseconds) during the remainder of the 10 seconds period. The aggregate duration of control signals will not count quiet periods in between transmissions.

5.6.5. Channel Move Time Plot

For 20MHz

Radar #1 Channel Move Time

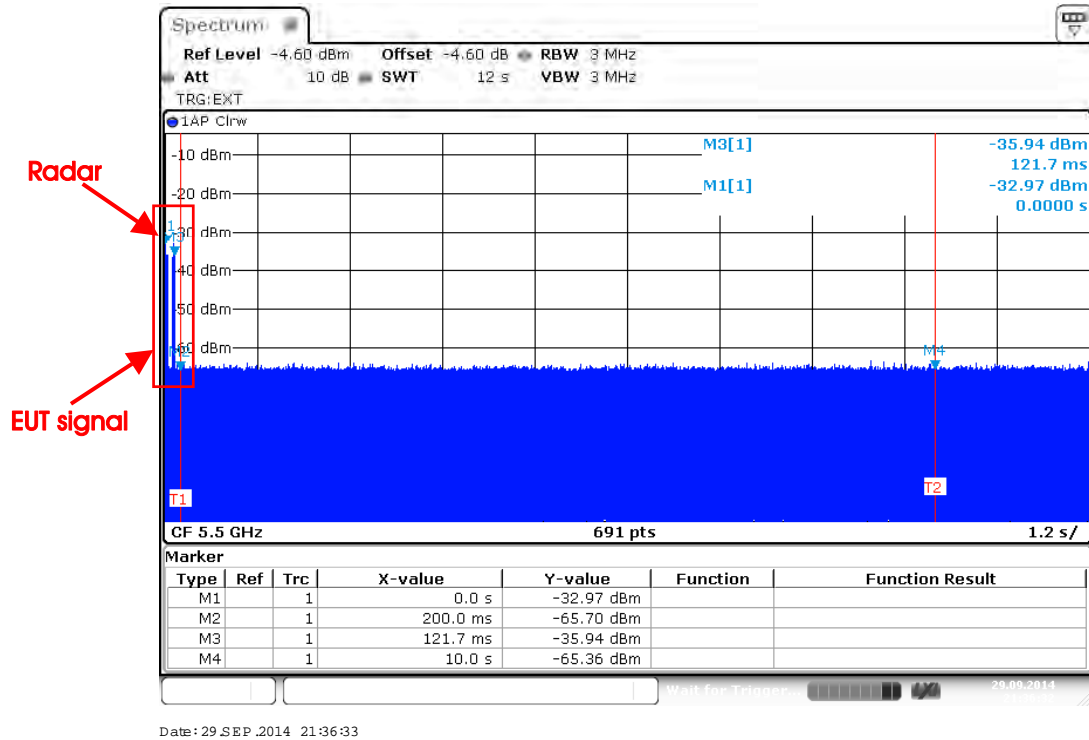

Radar #5 Channel Move Time

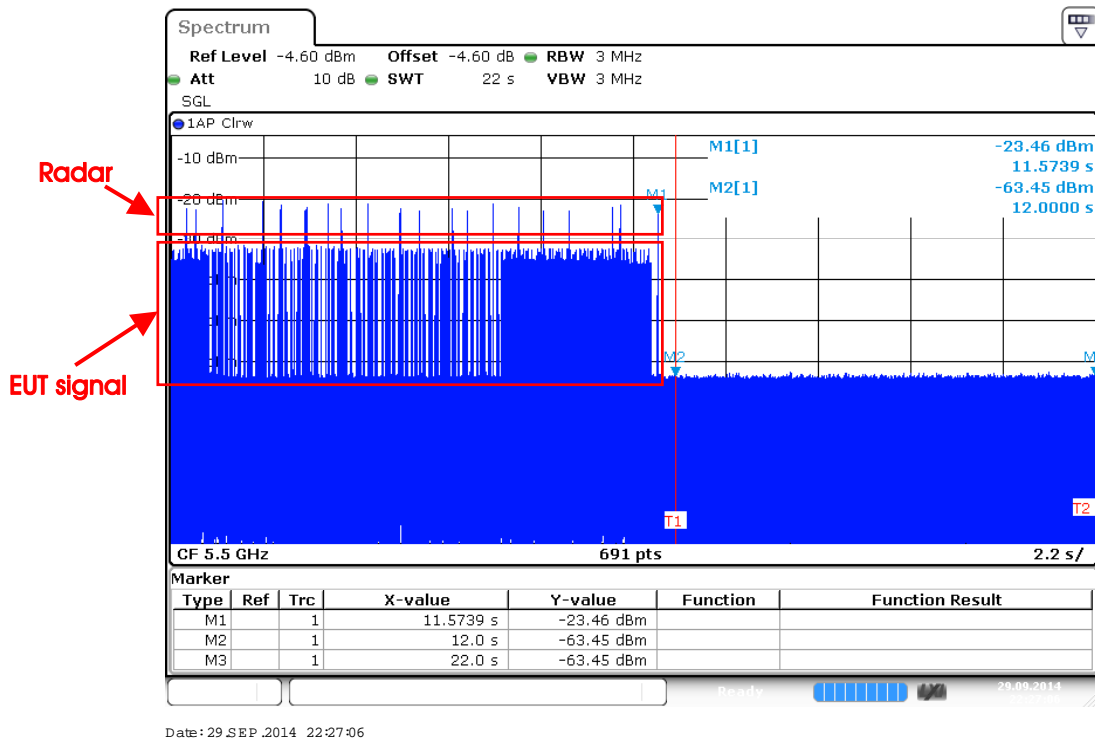

For 40MHz

Radar #1 Channel Move Time

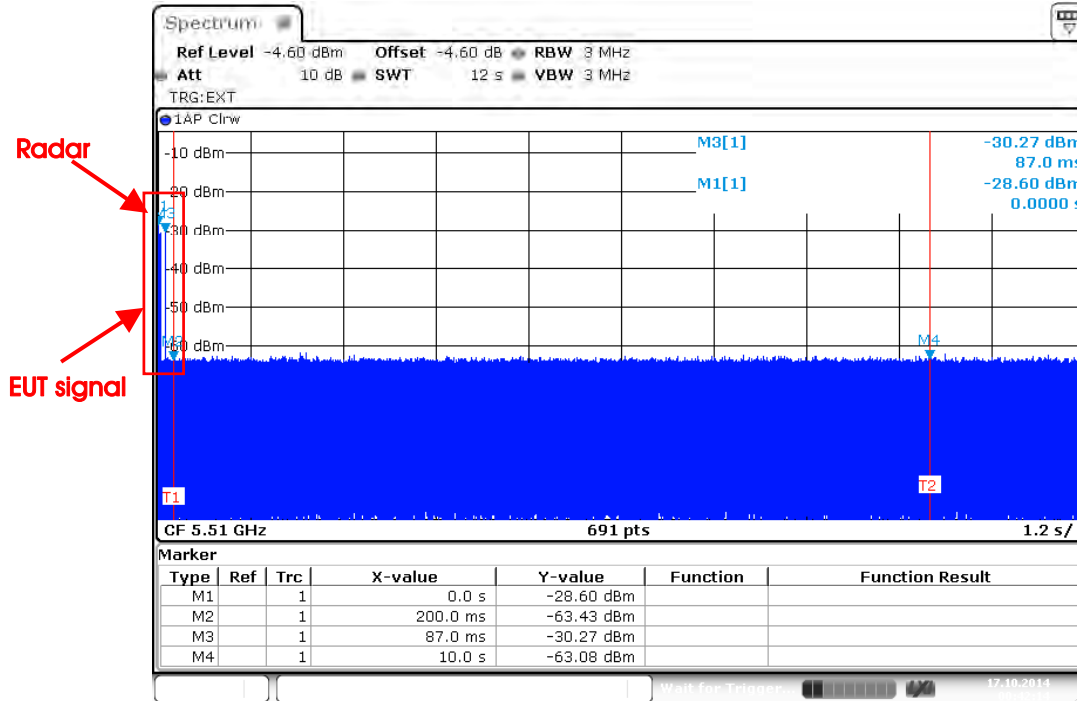

Date: 17.OCT.2014 00:42:14

Radar #5 Channel Move Time

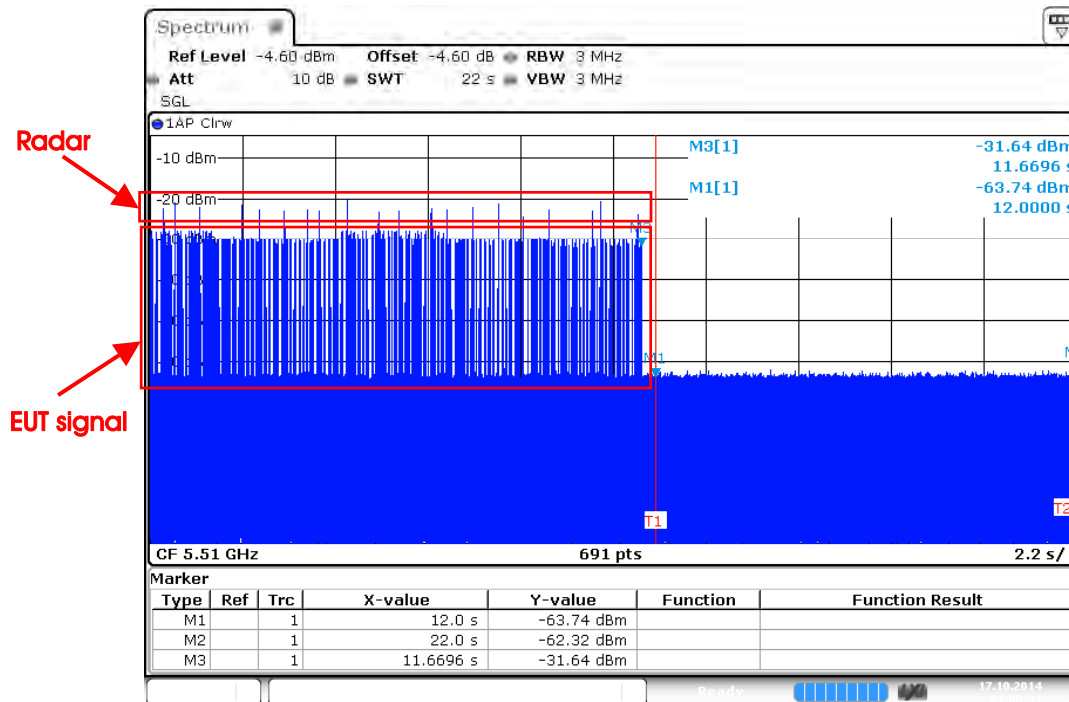

Date: 17.OCT.2014 01:06:32

For 80MHz

Radar #1 Channel Move Time

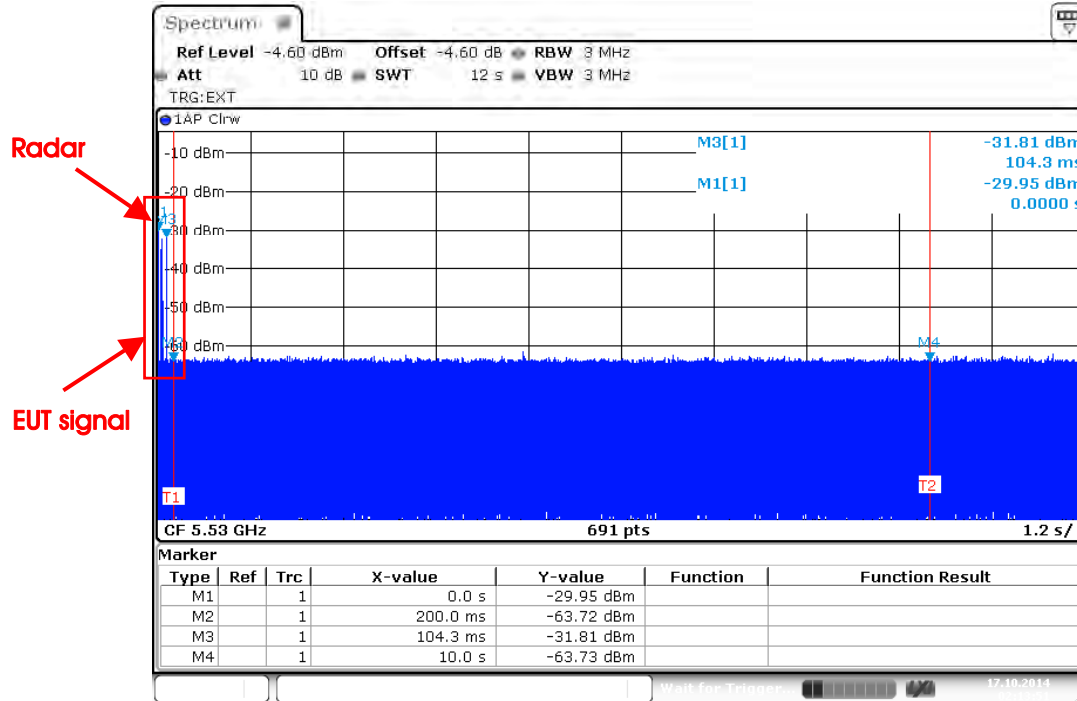

Date: 17.OCT.2014 02:13:51

Radar #5 Channel Move Time

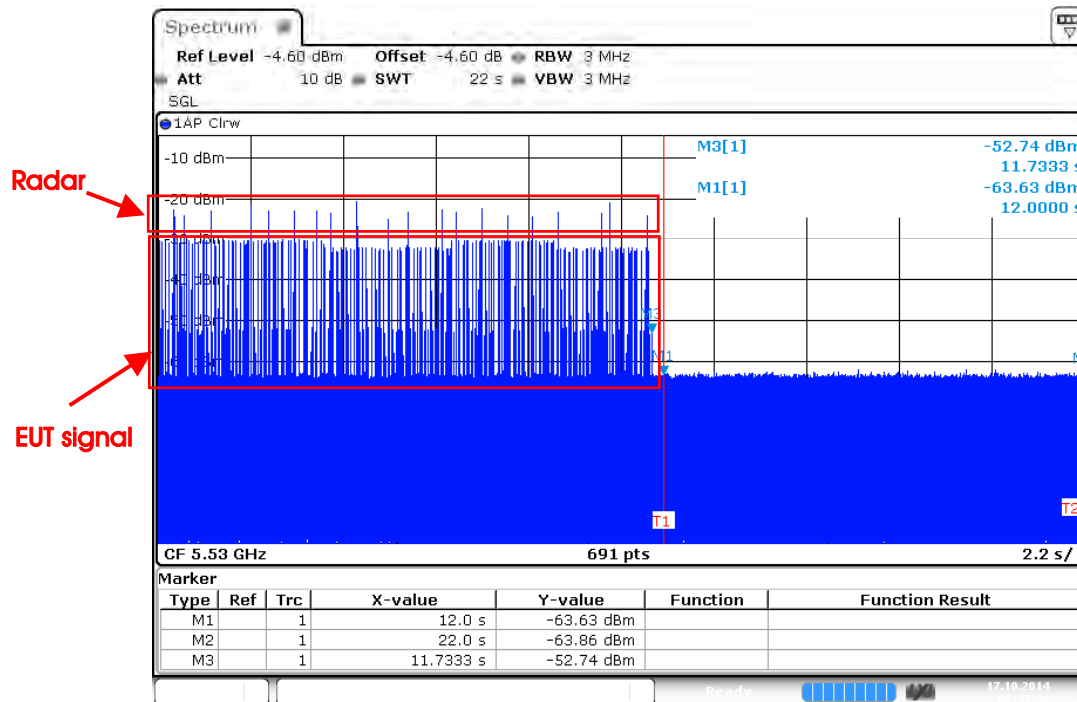

Date: 17.OCT.2014 02:37:30

5.6.6. Channel Closing Transmission Time Plot

For 20MHz

Radar #1 Channel Closing Transmission Time is comprised of 200 ms starting at the beginning of the Channel Move Time plus 60ms additional intermittent control signals

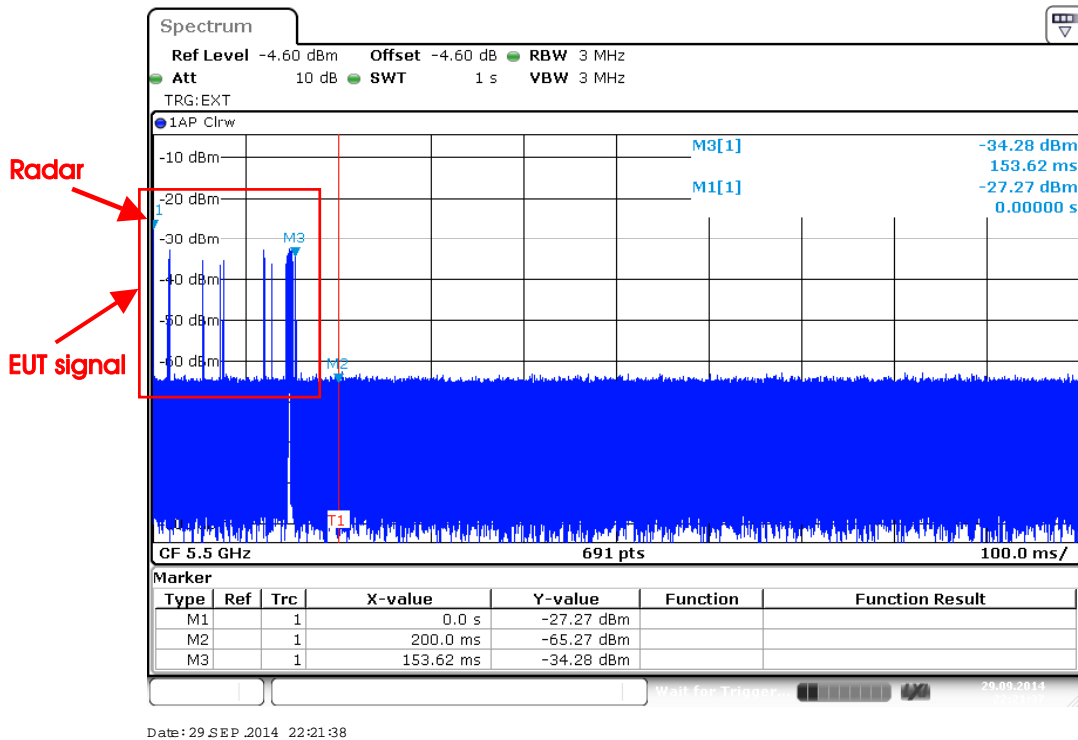

Dwell is the dwell time per spectrum analyzer sampling bin.

S is the sweep time

B is the number of spectrum analyzer sampling bins

C is the intermittent control signals of Channel Closing Transmission Time

N is the number of spectrum analyzer sampling bins (intermittent control signals) showing a U-NII transmission

$$\text{Dwell (1.4493 ms)} = S (1000 \text{ ms}) / B (690)$$

$$C (0 \text{ ms}) = N (0) \times \text{Dwell (1.4493 ms)}$$

Radar #5 Channel Closing Transmission Time is comprised of 200 ms starting at the beginning of the Channel Move Time plus 60ms additional intermittent control signals

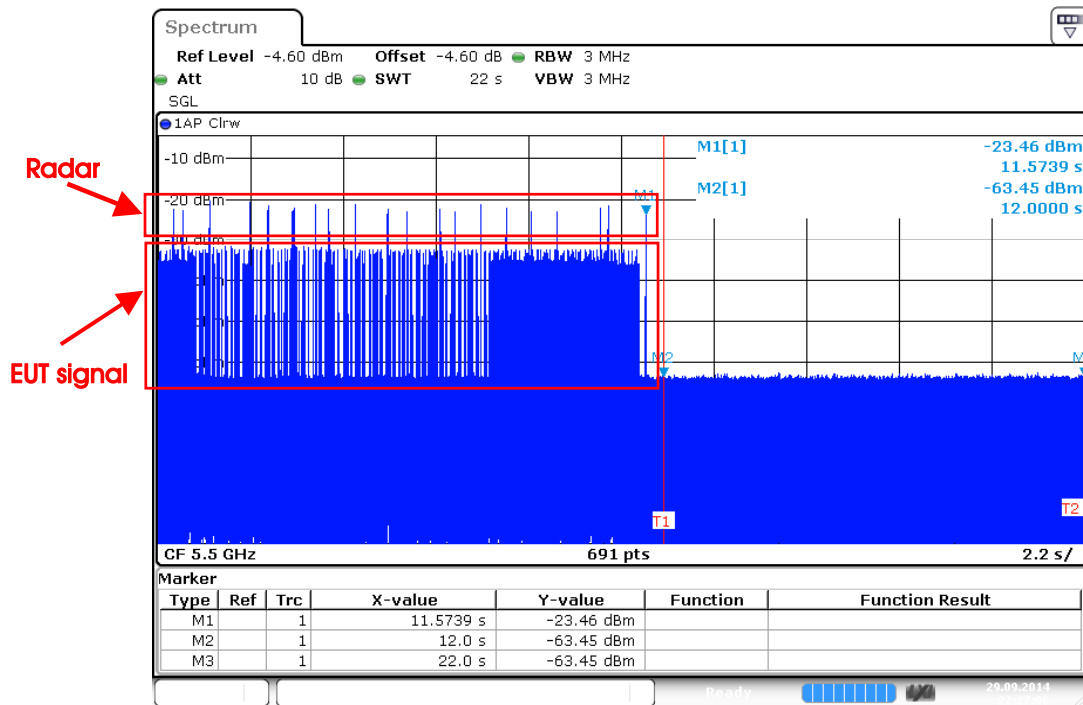

Date: 29 SEP 2014 22:27:06

Dwell is the dwell time per spectrum analyzer sampling bin.

S is the sweep time

B is the number of spectrum analyzer sampling bins

C is the intermittent control signals of Channel Closing Transmission Time

N is the number of spectrum analyzer sampling bins (intermittent control signals) showing a U-NII transmission

$$\text{Dwell (31.8841 ms)} = S (22000 \text{ ms}) / B (690)$$

$$C (0 \text{ ms}) = N (0) \times \text{Dwell (31.8841 ms)}$$

For 40MHz

Radar #1 Channel Closing Transmission Time is comprised of 200 ms starting at the beginning of the Channel Move Time plus 60ms additional intermittent control signals

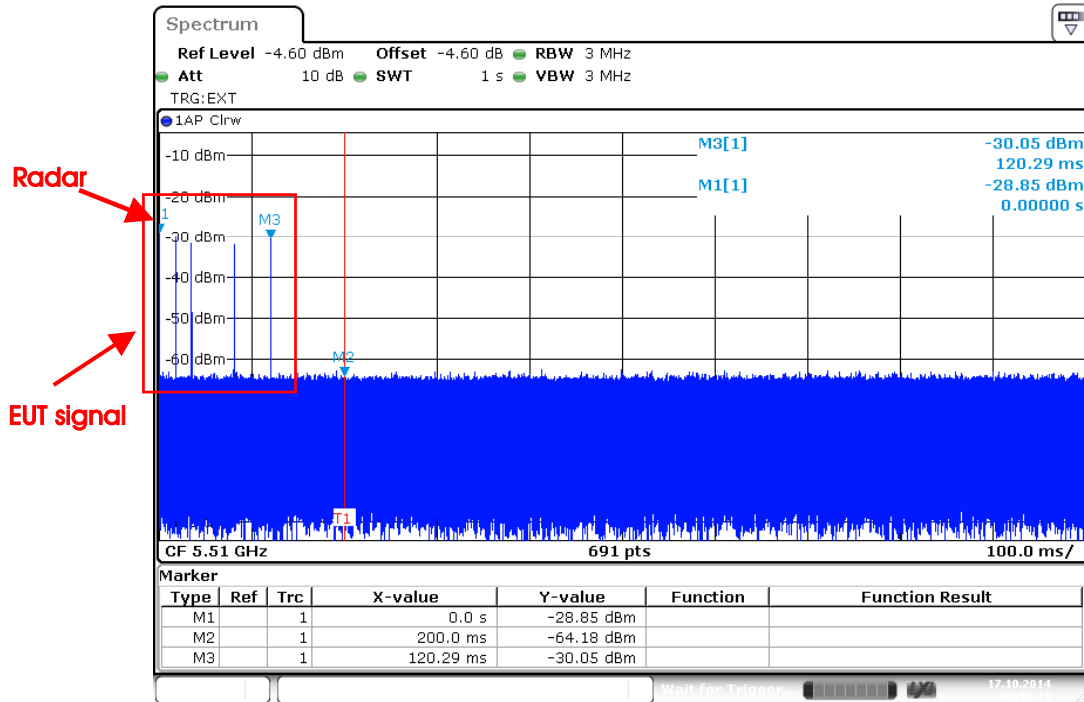

Date: 17 OCT 2014 00:49:14

Dwell is the dwell time per spectrum analyzer sampling bin.

S is the sweep time

B is the number of spectrum analyzer sampling bins

C is the intermittent control signals of Channel Closing Transmission Time

N is the number of spectrum analyzer sampling bins (intermittent control signals) showing a U-NII transmission

$$\text{Dwell (1.4493 ms)} = S (1000 \text{ ms}) / B (690)$$

$$C (0 \text{ ms}) = N (0) \times \text{Dwell (1.4493 ms)}$$

Radar #5 Channel Closing Transmission Time is comprised of 200 ms starting at the beginning of the Channel Move Time plus 60ms additional intermittent control signals

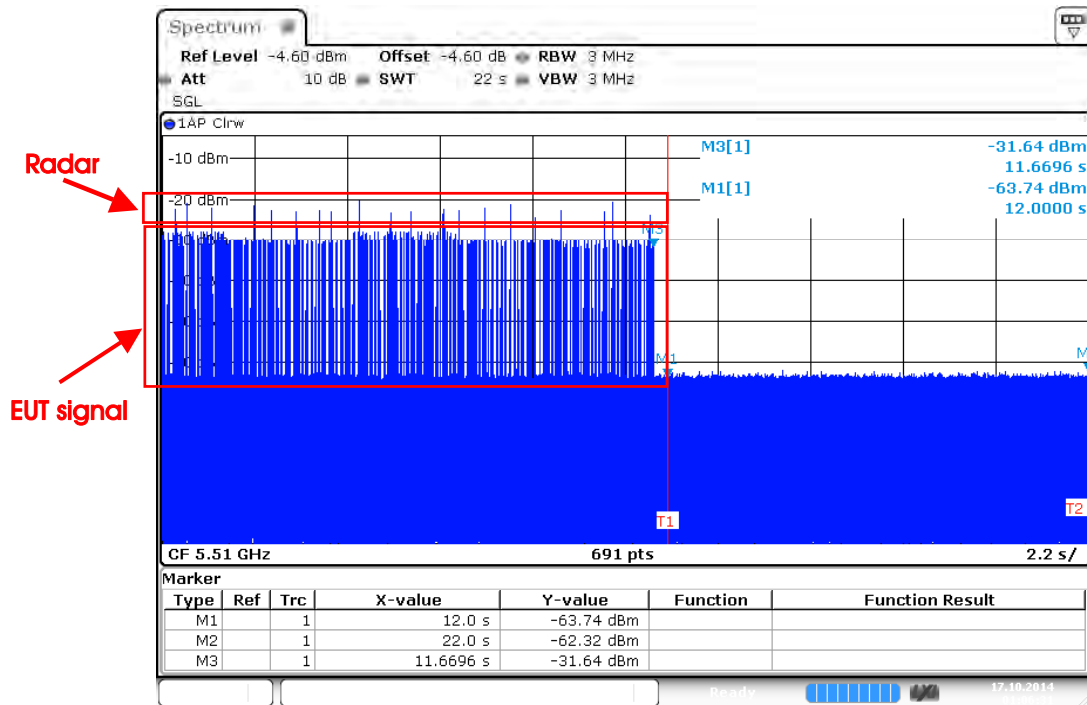

Date: 17 OCT 2014 01:06:32

Dwell is the dwell time per spectrum analyzer sampling bin.

S is the sweep time

B is the number of spectrum analyzer sampling bins

C is the intermittent control signals of Channel Closing Transmission Time

N is the number of spectrum analyzer sampling bins (intermittent control signals) showing a U-NII transmission

$$\text{Dwell (31.8841 ms)} = S (22000 \text{ ms}) / B (690)$$

$$C (0 \text{ ms}) = N (0) \times \text{Dwell (31.8841 ms)}$$

For 80MHz

Radar #1 Channel Closing Transmission Time is comprised of 200 ms starting at the beginning of the Channel Move Time plus 60ms additional intermittent control signals

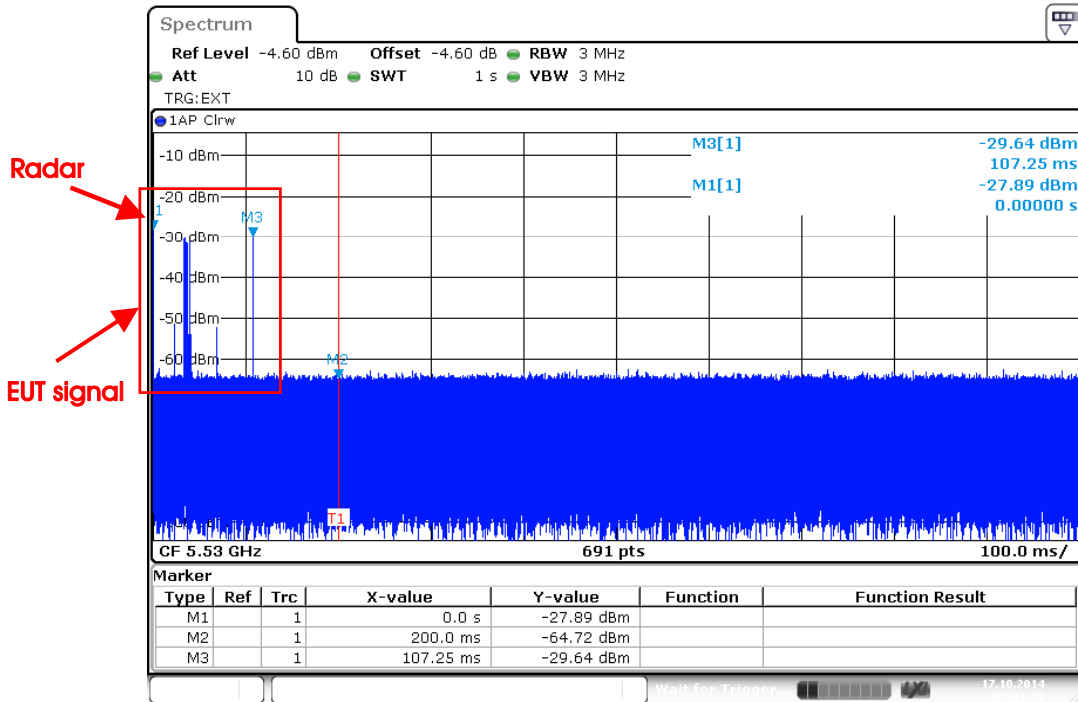

Date: 17 OCT. 2014 02:21:15

Dwell is the dwell time per spectrum analyzer sampling bin.

S is the sweep time

B is the number of spectrum analyzer sampling bins

C is the intermittent control signals of Channel Closing Transmission Time

N is the number of spectrum analyzer sampling bins (intermittent control signals) showing a U-NII transmission

$$\text{Dwell (1.4493 ms)} = S (1000 \text{ ms}) / B (690)$$

$$C (0 \text{ ms}) = N (0) \times \text{Dwell (1.4493 ms)}$$

Radar #5 Channel Closing Transmission Time is comprised of 200 ms starting at the beginning of the Channel Move Time plus 60ms additional intermittent control signals

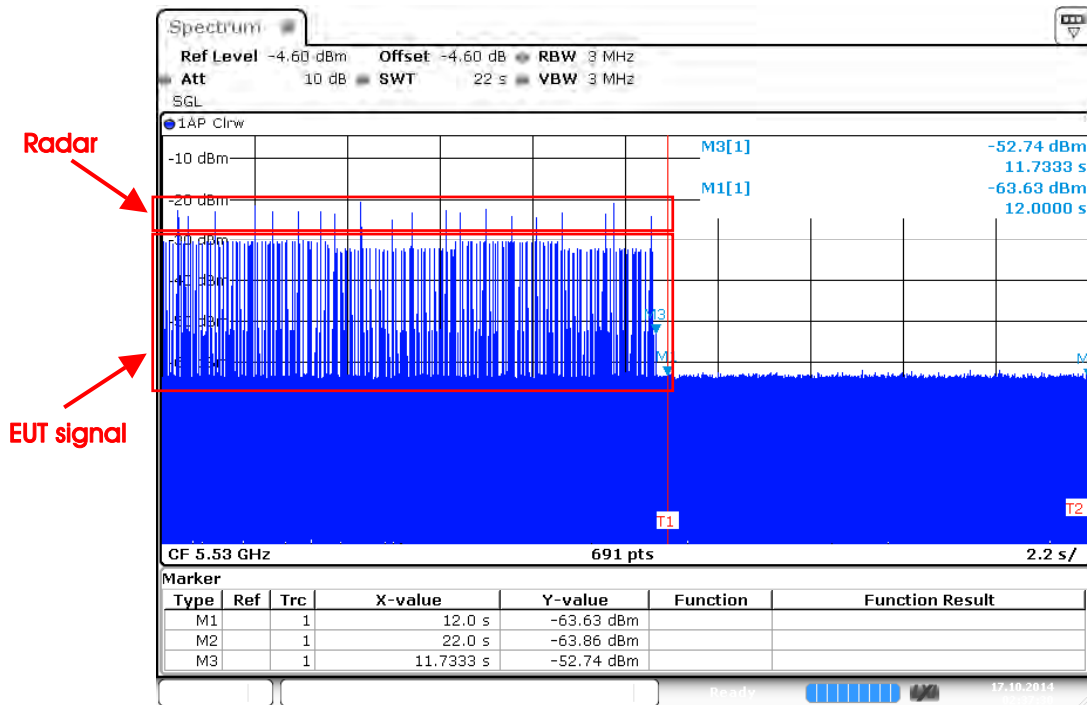

Date: 17 OCT 2014 02:37:30

Dwell is the dwell time per spectrum analyzer sampling bin.

S is the sweep time

B is the number of spectrum analyzer sampling bins

C is the intermittent control signals of Channel Closing Transmission Time

N is the number of spectrum analyzer sampling bins (intermittent control signals) showing a U-NII transmission

$$\text{Dwell (31.8841 ms)} = S (22000 \text{ ms}) / B (690)$$

$$C (0 \text{ ms}) = N (0) \times \text{Dwell (31.8841 ms)}$$

5.6.7. Non-Occupancy Period Plot

For 20MHz

Non-Occupancy Period

During the 30 minutes observation time, UUT did not make any transmissions on a channel after a radar signal was detected on that channel by either the Channel Availability Check or the In-Service Monitoring.

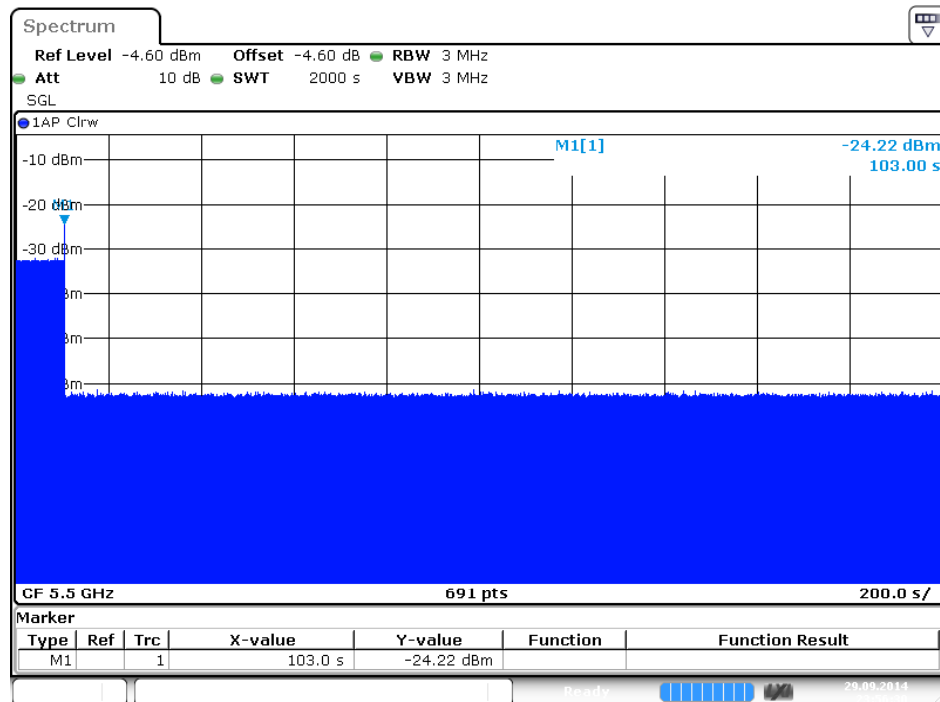

Date: 29.SEP.2014 23:56:30

For 40MHz

Non-Occupancy Period

During the 30 minutes observation time, UUT did not make any transmissions on a channel after a radar signal was detected on that channel by either the Channel Availability Check or the In-Service Monitoring.

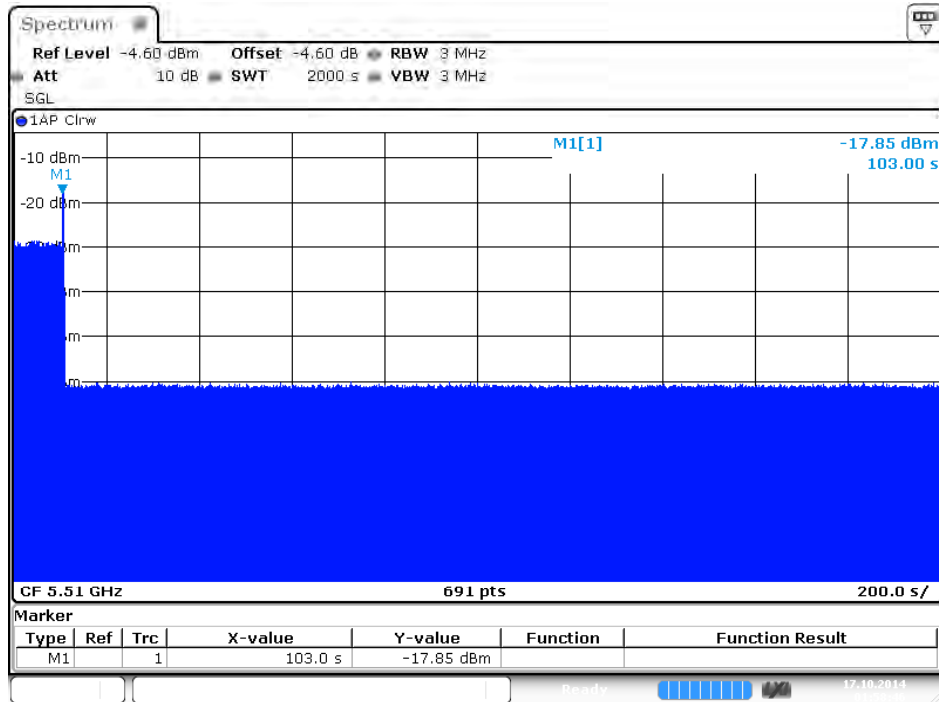

Date: 17.OCT.2014 01:58:46

For 80MHz

Non-Occupancy Period

During the 30 minutes observation time, UUT did not make any transmissions on a channel after a radar signal was detected on that channel by either the Channel Availability Check or the In-Service Monitoring.

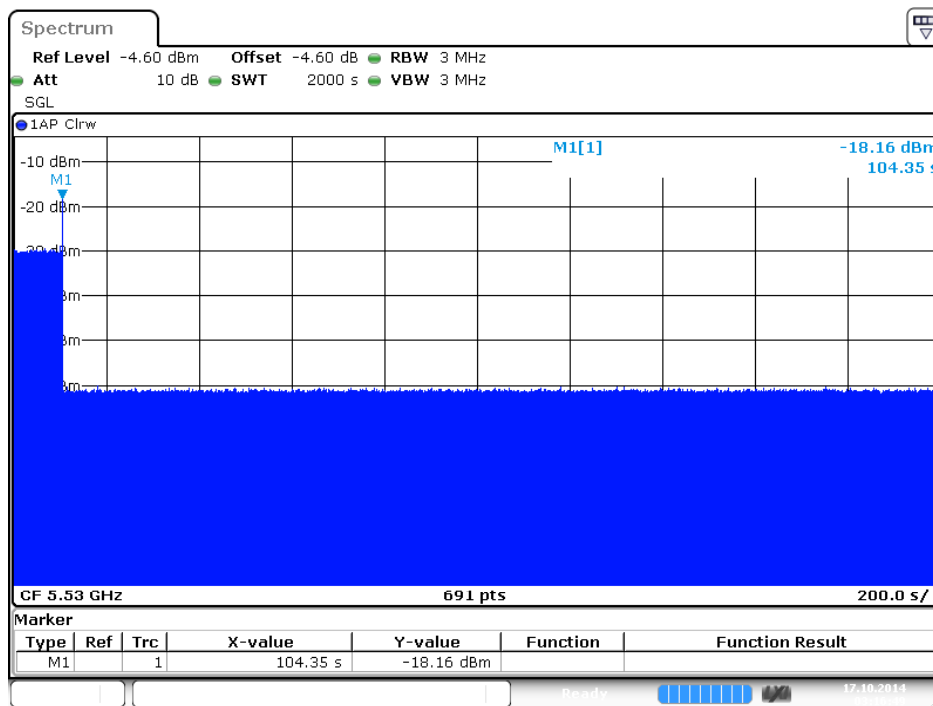

Date: 17.OCT.2014 03:16:49

5.7. Statistical Performance Check Measurement

5.7.1. Limit

The minimum percentage of successful detection requirements found in below table when a radar burst with a level equal to the DFS Detection Threshold + 1 dB is generated on the Operating Channel of the U-NII device (In- Service Monitoring).

| Radar Type | Minimum Number of Trails | Detection Probability |
|-----------------------------|--------------------------|-----------------------|
| 1 | 30 | Pd > 60% |
| 2 | 30 | Pd > 60% |
| 3 | 30 | Pd > 60% |
| 4 | 30 | Pd > 60% |
| Aggregate (Radar Types 1-4) | 120 | Pd > 80% |
| 5 | 30 | Pd > 80% |
| 6 | 30 | Pd > 70% |

The percentage of successful detection is calculated by:

$$\frac{\text{TotalWaveformDetections}}{\text{TotalWaveformTrails}} \times 100 = \text{Probability of Detection Radar Waveform}$$

In addition an aggregate

minimum percentage of successful detection across all Short Pulse Radar Types 1-4 is required and is

calculated as follows:
$$\frac{Pd1 + Pd2 + Pd3 + Pd4}{4}$$

5.7.2. Test Procedures

1. Stream the MPEG test file from the Master Device to the Client Device on the test Channel for the entire period of the test.
2. At time T0 the Radar Waveform generator sends the individual waveform for each of the Radar Types 1-6, at levels equal to the DFS Detection Threshold + 1 dB, on the Operating Channel.
3. Observe the transmissions of the EUT at the end of the Burst on the Operating Channel for duration greater than 10 seconds for Short Pulse Radar Types 1-4 and 6 to ensure detection occurs.
4. Observe the transmissions of the EUT at the end of the Burst on the Operating Channel for duration greater than 22 seconds for Long Pulse Radar Type 5 to ensure detection occurs.
5. The device can utilize a test mode to demonstrate when detection occurs to prevent the need to reset the device between trial runs.
6. The Minimum number of trails, minimum percentage of successful detection and the average minimum percentage of successful detection are found in below table.

5.7.3. Test Deviation

There is no deviation with the original standard.

5.7.4. Test Result of Statistical Performance Check

For 20MHz

Type 1 Radar Statistical Performance

| Trail # | Test Freq. (MHz) | Pulse Width (us) | PRI (us) | Pulses / Burst | 1 = Detection 0 = No Detection |
|--------------------------|------------------|------------------|----------|----------------|-----------------------------------|
| 1 | 5493 | 1 | 1428 | 18 | 1 |
| 2 | 5494 | 1 | 1428 | 18 | 1 |
| 3 | 5495 | 1 | 1428 | 18 | 1 |
| 4 | 5496 | 1 | 1428 | 18 | 1 |
| 5 | 5497 | 1 | 1428 | 18 | 1 |
| 6 | 5498 | 1 | 1428 | 18 | 1 |
| 7 | 5499 | 1 | 1428 | 18 | 1 |
| 8 | 5500 | 1 | 1428 | 18 | 1 |
| 9 | 5501 | 1 | 1428 | 18 | 1 |
| 10 | 5502 | 1 | 1428 | 18 | 1 |
| 11 | 5503 | 1 | 1428 | 18 | 1 |
| 12 | 5504 | 1 | 1428 | 18 | 1 |
| 13 | 5505 | 1 | 1428 | 18 | 1 |
| 14 | 5506 | 1 | 1428 | 18 | 1 |
| 15 | 5507 | 1 | 1428 | 18 | 1 |
| 16 | 5506 | 1 | 1428 | 18 | 1 |
| 17 | 5505 | 1 | 1428 | 18 | 1 |
| 18 | 5504 | 1 | 1428 | 18 | 1 |
| 19 | 5503 | 1 | 1428 | 18 | 1 |
| 20 | 5502 | 1 | 1428 | 18 | 1 |
| 21 | 5501 | 1 | 1428 | 18 | 1 |
| 22 | 5500 | 1 | 1428 | 18 | 1 |
| 23 | 5499 | 1 | 1428 | 18 | 1 |
| 24 | 5498 | 1 | 1428 | 18 | 1 |
| 25 | 5497 | 1 | 1428 | 18 | 1 |
| 26 | 5496 | 1 | 1428 | 18 | 1 |
| 27 | 5495 | 1 | 1428 | 18 | 1 |
| 28 | 5494 | 1 | 1428 | 18 | 1 |
| 29 | 5493 | 1 | 1428 | 18 | 1 |
| 30 | 5494 | 1 | 1428 | 18 | 1 |
| Detection Percentage (%) | | | | | 100.00 |



Type 2 Radar Statistical Performance

| Trail # | Test Freq. (MHz) | Pulse Width (us) | PRI (us) | Pulses / Burst | 1 =Detection 0=No Detection |
|--------------------------|------------------|------------------|----------|----------------|--------------------------------|
| 1 | 5493 | 2.6 | 221 | 23 | 1 |
| 2 | 5494 | 4.6 | 198 | 27 | 1 |
| 3 | 5495 | 1.1 | 184 | 29 | 1 |
| 4 | 5496 | 4.8 | 203 | 24 | 1 |
| 5 | 5497 | 2.4 | 162 | 25 | 1 |
| 6 | 5498 | 3.4 | 204 | 28 | 1 |
| 7 | 5499 | 2.3 | 170 | 27 | 1 |
| 8 | 5500 | 3.5 | 184 | 23 | 1 |
| 9 | 5501 | 4.9 | 150 | 27 | 1 |
| 10 | 5502 | 4.6 | 211 | 29 | 1 |
| 11 | 5503 | 2.9 | 158 | 23 | 1 |
| 12 | 5504 | 2.6 | 226 | 27 | 1 |
| 13 | 5505 | 1.6 | 204 | 26 | 1 |
| 14 | 5506 | 3.9 | 181 | 25 | 1 |
| 15 | 5507 | 4.6 | 202 | 24 | 0 |
| 16 | 5506 | 4.1 | 194 | 27 | 1 |
| 17 | 5505 | 2.3 | 193 | 28 | 1 |
| 18 | 5504 | 3.9 | 173 | 29 | 1 |
| 19 | 5503 | 4.3 | 188 | 23 | 1 |
| 20 | 5502 | 1.5 | 215 | 26 | 1 |
| 21 | 5501 | 4.9 | 227 | 27 | 1 |
| 22 | 5500 | 1.1 | 199 | 23 | 1 |
| 23 | 5499 | 4.5 | 155 | 29 | 1 |
| 24 | 5498 | 4.0 | 190 | 27 | 0 |
| 25 | 5497 | 2.4 | 151 | 23 | 1 |
| 26 | 5496 | 2.5 | 180 | 28 | 1 |
| 27 | 5495 | 2.5 | 228 | 23 | 1 |
| 28 | 5494 | 2.5 | 203 | 25 | 1 |
| 29 | 5493 | 1.5 | 188 | 25 | 1 |
| 30 | 5494 | 1.9 | 217 | 24 | 1 |
| Detection Percentage (%) | | | | | 93.33 |



Type 3 Radar Statistical Performance

| Trail # | Test Freq. (MHz) | Pulse Width (us) | PRI (us) | Pulses / Burst | 1=Detection ; 0=No Detection |
|--------------------------|------------------|------------------|----------|----------------|---------------------------------|
| 1 | 5493 | 8.0 | 205 | 16 | 1 |
| 2 | 5494 | 6.7 | 382 | 18 | 1 |
| 3 | 5495 | 8.6 | 418 | 16 | 1 |
| 4 | 5496 | 9.4 | 351 | 17 | 1 |
| 5 | 5497 | 7.4 | 383 | 18 | 1 |
| 6 | 5498 | 9.8 | 232 | 16 | 1 |
| 7 | 5499 | 9.1 | 377 | 17 | 1 |
| 8 | 5500 | 9.6 | 457 | 16 | 1 |
| 9 | 5501 | 8.0 | 471 | 18 | 1 |
| 10 | 5502 | 9.0 | 304 | 18 | 1 |
| 11 | 5503 | 8.0 | 316 | 17 | 1 |
| 12 | 5504 | 9.8 | 325 | 16 | 1 |
| 13 | 5505 | 8.0 | 409 | 17 | 1 |
| 14 | 5506 | 9.9 | 200 | 17 | 1 |
| 15 | 5507 | 8.8 | 458 | 16 | 1 |
| 16 | 5506 | 8.0 | 232 | 18 | 1 |
| 17 | 5505 | 8.3 | 250 | 16 | 1 |
| 18 | 5504 | 8.7 | 270 | 16 | 1 |
| 19 | 5503 | 7.7 | 350 | 17 | 0 |
| 20 | 5502 | 7.1 | 230 | 16 | 1 |
| 21 | 5501 | 7.3 | 416 | 18 | 1 |
| 22 | 5500 | 7.6 | 498 | 18 | 1 |
| 23 | 5499 | 7.3 | 286 | 17 | 1 |
| 24 | 5498 | 7.3 | 287 | 16 | 1 |
| 25 | 5497 | 7.5 | 462 | 17 | 0 |
| 26 | 5496 | 6.2 | 300 | 17 | 1 |
| 27 | 5495 | 6.4 | 323 | 18 | 1 |
| 28 | 5494 | 7.1 | 420 | 16 | 1 |
| 29 | 5493 | 7.2 | 395 | 18 | 1 |
| 30 | 5494 | 8.4 | 377 | 16 | 1 |
| Detection Percentage (%) | | | | | 93.33 |



Type 4 Radar Statistical Performance

| Trail # | Test Freq. (MHz) | Pulse Width (us) | PRI (us) | Pulses / Burst | 1=Detection 0=No Detection |
|---------------------------------|-------------------------|-------------------------|-----------------|-----------------------|---------------------------------------|
| 1 | 5493 | 18.0 | 242 | 15 | 1 |
| 2 | 5494 | 19.9 | 279 | 12 | 1 |
| 3 | 5495 | 12.9 | 487 | 14 | 1 |
| 4 | 5496 | 15.0 | 452 | 13 | 1 |
| 5 | 5497 | 16.3 | 230 | 12 | 1 |
| 6 | 5498 | 19.8 | 238 | 13 | 1 |
| 7 | 5499 | 18.2 | 420 | 16 | 1 |
| 8 | 5500 | 16.3 | 452 | 15 | 1 |
| 9 | 5501 | 14.2 | 495 | 12 | 1 |
| 10 | 5502 | 17.8 | 228 | 16 | 0 |
| 11 | 5503 | 19.1 | 211 | 16 | 1 |
| 12 | 5504 | 18.4 | 283 | 15 | 1 |
| 13 | 5505 | 11.8 | 411 | 12 | 1 |
| 14 | 5506 | 14.2 | 284 | 13 | 0 |
| 15 | 5507 | 13.9 | 202 | 12 | 1 |
| 16 | 5506 | 17.8 | 340 | 14 | 1 |
| 17 | 5505 | 15.6 | 290 | 16 | 1 |
| 18 | 5504 | 14.6 | 250 | 16 | 1 |
| 19 | 5503 | 14.4 | 484 | 15 | 1 |
| 20 | 5502 | 18.9 | 387 | 13 | 1 |
| 21 | 5501 | 11.1 | 348 | 15 | 1 |
| 22 | 5500 | 13.8 | 291 | 16 | 1 |
| 23 | 5499 | 14.3 | 295 | 12 | 1 |
| 24 | 5498 | 12.5 | 300 | 12 | 1 |
| 25 | 5497 | 12.5 | 322 | 14 | 1 |
| 26 | 5496 | 12.5 | 383 | 13 | 0 |
| 27 | 5495 | 15.7 | 322 | 16 | 1 |
| 28 | 5494 | 19.8 | 469 | 13 | 1 |
| 29 | 5493 | 18.6 | 406 | 15 | 1 |
| 30 | 5494 | 15.9 | 238 | 14 | 1 |
| Detection Percentage (%) | | | | | 90.00 |

Total Type 1~4 Radar Statistical Performance

| Radar Type # | Detection Percentage (%) |
|--------------|--------------------------|
| 1 | 100.00 |
| 2 | 93.33 |
| 3 | 93.33 |
| 4 | 90.00 |
| Total 1~4 | 94.17 |

Type 5 Radar Statistical Performance

| Trail # | 1=Detection 0=No Detection | Trail # | 1=Detection 0=No Detection | Trail # | 1=Detection 0=No Detection |
|--------------------------|-------------------------------|---------|-------------------------------|---------|-------------------------------|
| 1 | 0 | 11 | 1 | 21 | 1 |
| 2 | 1 | 12 | 1 | 22 | 1 |
| 3 | 1 | 13 | 1 | 23 | 1 |
| 4 | 1 | 14 | 1 | 24 | 1 |
| 5 | 0 | 15 | 1 | 25 | 1 |
| 6 | 1 | 16 | 0 | 26 | 1 |
| 7 | 1 | 17 | 1 | 27 | 1 |
| 8 | 1 | 18 | 1 | 28 | 0 |
| 9 | 1 | 19 | 1 | 29 | 1 |
| 10 | 1 | 20 | 1 | 30 | 1 |
| Detection Percentage (%) | | | | | 86.67 |



Type 6 Radar Statistical Performance

| Trail # | Test Freq. (MHz) | Pulses / Hop | Pulse Width (us) | PRI (us) | 1 = Detection 0 = No Detection |
|--------------------------|------------------|--------------|------------------|----------|-----------------------------------|
| 1 | 5500 | 9 | 1 | 333 | 1 |
| 2 | 5500 | 9 | 1 | 333 | 1 |
| 3 | 5500 | 9 | 1 | 333 | 1 |
| 4 | 5500 | 9 | 1 | 333 | 1 |
| 5 | 5500 | 9 | 1 | 333 | 1 |
| 6 | 5500 | 9 | 1 | 333 | 1 |
| 7 | 5500 | 9 | 1 | 333 | 1 |
| 8 | 5500 | 9 | 1 | 333 | 1 |
| 9 | 5500 | 9 | 1 | 333 | 1 |
| 10 | 5500 | 9 | 1 | 333 | 1 |
| 11 | 5500 | 9 | 1 | 333 | 1 |
| 12 | 5500 | 9 | 1 | 333 | 1 |
| 13 | 5500 | 9 | 1 | 333 | 1 |
| 14 | 5500 | 9 | 1 | 333 | 1 |
| 15 | 5500 | 9 | 1 | 333 | 1 |
| 16 | 5500 | 9 | 1 | 333 | 1 |
| 17 | 5500 | 9 | 1 | 333 | 1 |
| 18 | 5500 | 9 | 1 | 333 | 1 |
| 19 | 5500 | 9 | 1 | 333 | 1 |
| 20 | 5500 | 9 | 1 | 333 | 1 |
| 21 | 5500 | 9 | 1 | 333 | 1 |
| 22 | 5500 | 9 | 1 | 333 | 1 |
| 23 | 5500 | 9 | 1 | 333 | 1 |
| 24 | 5500 | 9 | 1 | 333 | 1 |
| 25 | 5500 | 9 | 1 | 333 | 1 |
| 26 | 5500 | 9 | 1 | 333 | 1 |
| 27 | 5500 | 9 | 1 | 333 | 1 |
| 28 | 5500 | 9 | 1 | 333 | 1 |
| 29 | 5500 | 9 | 1 | 333 | 1 |
| 30 | 5500 | 9 | 1 | 333 | 1 |
| Detection Percentage (%) | | | | | 100.00 |



For 40MHz

Type 1 Radar Statistical Performance

| Trail # | Test Freq. (MHz) | Pulse Width (us) | PRI (us) | Pulses / Burst | 1=Detection 0=No Detection |
|--------------------------|------------------|------------------|----------|----------------|-------------------------------|
| 1 | 5496 | 1 | 1428 | 18 | 1 |
| 2 | 5497 | 1 | 1428 | 18 | 1 |
| 3 | 5498 | 1 | 1428 | 18 | 1 |
| 4 | 5499 | 1 | 1428 | 18 | 1 |
| 5 | 5500 | 1 | 1428 | 18 | 1 |
| 6 | 5501 | 1 | 1428 | 18 | 1 |
| 7 | 5502 | 1 | 1428 | 18 | 1 |
| 8 | 5503 | 1 | 1428 | 18 | 1 |
| 9 | 5504 | 1 | 1428 | 18 | 1 |
| 10 | 5505 | 1 | 1428 | 18 | 1 |
| 11 | 5506 | 1 | 1428 | 18 | 1 |
| 12 | 5507 | 1 | 1428 | 18 | 1 |
| 13 | 5508 | 1 | 1428 | 18 | 1 |
| 14 | 5509 | 1 | 1428 | 18 | 1 |
| 15 | 5510 | 1 | 1428 | 18 | 1 |
| 16 | 5511 | 1 | 1428 | 18 | 1 |
| 17 | 5512 | 1 | 1428 | 18 | 1 |
| 18 | 5513 | 1 | 1428 | 18 | 1 |
| 19 | 5514 | 1 | 1428 | 18 | 1 |
| 20 | 5515 | 1 | 1428 | 18 | 1 |
| 21 | 5516 | 1 | 1428 | 18 | 1 |
| 22 | 5517 | 1 | 1428 | 18 | 1 |
| 23 | 5518 | 1 | 1428 | 18 | 1 |
| 24 | 5519 | 1 | 1428 | 18 | 1 |
| 25 | 5520 | 1 | 1428 | 18 | 1 |
| 26 | 5521 | 1 | 1428 | 18 | 1 |
| 27 | 5522 | 1 | 1428 | 18 | 1 |
| 28 | 5523 | 1 | 1428 | 18 | 1 |
| 29 | 5524 | 1 | 1428 | 18 | 1 |
| 30 | 5525 | 1 | 1428 | 18 | 1 |
| Detection Percentage (%) | | | | | 100.00 |



Type 2 Radar Statistical Performance

| Trail # | Test Freq. (MHz) | Pulse Width (us) | PRI (us) | Pulses / Burst | 1=Detection 0=No Detection |
|--------------------------|------------------|------------------|----------|----------------|-------------------------------|
| 1 | 5496 | 2.6 | 221 | 23 | 1 |
| 2 | 5497 | 4.6 | 198 | 27 | 1 |
| 3 | 5498 | 1.1 | 184 | 29 | 1 |
| 4 | 5499 | 4.8 | 203 | 24 | 1 |
| 5 | 5500 | 2.4 | 162 | 25 | 1 |
| 6 | 5501 | 3.4 | 204 | 28 | 1 |
| 7 | 5502 | 2.3 | 170 | 27 | 1 |
| 8 | 5503 | 3.5 | 184 | 23 | 1 |
| 9 | 5504 | 4.9 | 150 | 27 | 1 |
| 10 | 5505 | 4.6 | 211 | 29 | 0 |
| 11 | 5506 | 2.9 | 158 | 23 | 1 |
| 12 | 5507 | 2.6 | 226 | 27 | 1 |
| 13 | 5508 | 1.6 | 204 | 26 | 1 |
| 14 | 5509 | 3.9 | 181 | 25 | 1 |
| 15 | 5510 | 4.6 | 202 | 24 | 1 |
| 16 | 5511 | 4.1 | 194 | 27 | 1 |
| 17 | 5512 | 2.3 | 193 | 28 | 1 |
| 18 | 5513 | 3.9 | 173 | 29 | 1 |
| 19 | 5514 | 4.3 | 188 | 23 | 1 |
| 20 | 5515 | 1.5 | 215 | 26 | 1 |
| 21 | 5516 | 4.9 | 227 | 27 | 1 |
| 22 | 5517 | 1.1 | 199 | 23 | 1 |
| 23 | 5518 | 4.5 | 155 | 29 | 1 |
| 24 | 5519 | 4.0 | 190 | 27 | 1 |
| 25 | 5520 | 2.4 | 151 | 23 | 1 |
| 26 | 5521 | 2.5 | 180 | 28 | 1 |
| 27 | 5522 | 2.5 | 228 | 23 | 1 |
| 28 | 5523 | 2.5 | 203 | 25 | 1 |
| 29 | 5524 | 1.5 | 188 | 25 | 1 |
| 30 | 5525 | 1.9 | 217 | 24 | 1 |
| Detection Percentage (%) | | | | | 96.67 |



Type 3 Radar Statistical Performance

| Trail # | Test Freq. (MHz) | Pulse Width (us) | PRI (us) | Pulses / Burst | 1=Detection 0=No Detection |
|--------------------------|------------------|------------------|----------|----------------|-------------------------------|
| 1 | 5496 | 8.0 | 205 | 16 | 1 |
| 2 | 5497 | 6.7 | 382 | 18 | 1 |
| 3 | 5498 | 8.6 | 418 | 16 | 1 |
| 4 | 5499 | 9.4 | 351 | 17 | 1 |
| 5 | 5500 | 7.4 | 383 | 18 | 1 |
| 6 | 5501 | 9.8 | 232 | 16 | 1 |
| 7 | 5502 | 9.1 | 377 | 17 | 1 |
| 8 | 5503 | 9.6 | 457 | 16 | 1 |
| 9 | 5504 | 8.0 | 471 | 18 | 1 |
| 10 | 5505 | 9.0 | 304 | 18 | 1 |
| 11 | 5506 | 8.0 | 316 | 17 | 1 |
| 12 | 5507 | 9.8 | 325 | 16 | 1 |
| 13 | 5508 | 8.0 | 409 | 17 | 1 |
| 14 | 5509 | 9.9 | 200 | 17 | 1 |
| 15 | 5510 | 8.8 | 458 | 16 | 1 |
| 16 | 5511 | 8.0 | 232 | 18 | 1 |
| 17 | 5512 | 8.3 | 250 | 16 | 1 |
| 18 | 5513 | 8.7 | 270 | 16 | 1 |
| 19 | 5514 | 7.7 | 350 | 17 | 1 |
| 20 | 5515 | 7.1 | 230 | 16 | 1 |
| 21 | 5516 | 7.3 | 416 | 18 | 1 |
| 22 | 5517 | 7.6 | 498 | 18 | 1 |
| 23 | 5518 | 7.3 | 286 | 17 | 1 |
| 24 | 5519 | 7.3 | 287 | 16 | 1 |
| 25 | 5520 | 7.5 | 462 | 17 | 1 |
| 26 | 5521 | 6.2 | 300 | 17 | 1 |
| 27 | 5522 | 6.4 | 323 | 18 | 1 |
| 28 | 5523 | 7.1 | 420 | 16 | 1 |
| 29 | 5524 | 7.2 | 395 | 18 | 1 |
| 30 | 5525 | 8.4 | 377 | 16 | 1 |
| Detection Percentage (%) | | | | | 100.00 |



Type 4 Radar Statistical Performance

| Trail # | Test Freq. (MHz) | Pulse Width (us) | PRI (us) | Pulses / Burst | 1=Detection 0=No Detection |
|---------------------------------|-------------------------|-------------------------|-----------------|-----------------------|---------------------------------------|
| 1 | 5496 | 18.0 | 242 | 15 | 0 |
| 2 | 5497 | 19.9 | 279 | 12 | 1 |
| 3 | 5498 | 12.9 | 487 | 14 | 1 |
| 4 | 5499 | 15.0 | 452 | 13 | 1 |
| 5 | 5500 | 16.3 | 230 | 12 | 1 |
| 6 | 5501 | 19.8 | 238 | 13 | 1 |
| 7 | 5502 | 18.2 | 420 | 16 | 1 |
| 8 | 5503 | 16.3 | 452 | 15 | 1 |
| 9 | 5504 | 14.2 | 495 | 12 | 1 |
| 10 | 5505 | 17.8 | 228 | 16 | 1 |
| 11 | 5506 | 19.1 | 211 | 16 | 1 |
| 12 | 5507 | 18.4 | 283 | 15 | 1 |
| 13 | 5508 | 11.8 | 411 | 12 | 1 |
| 14 | 5509 | 14.2 | 284 | 13 | 1 |
| 15 | 5510 | 13.9 | 202 | 12 | 1 |
| 16 | 5511 | 17.8 | 340 | 14 | 1 |
| 17 | 5512 | 15.6 | 290 | 16 | 1 |
| 18 | 5513 | 14.6 | 250 | 16 | 1 |
| 19 | 5514 | 14.4 | 484 | 15 | 1 |
| 20 | 5515 | 18.9 | 387 | 13 | 0 |
| 21 | 5516 | 11.1 | 348 | 15 | 1 |
| 22 | 5517 | 13.8 | 291 | 16 | 1 |
| 23 | 5518 | 14.3 | 295 | 12 | 1 |
| 24 | 5519 | 12.5 | 300 | 12 | 1 |
| 25 | 5520 | 12.5 | 322 | 14 | 1 |
| 26 | 5521 | 12.5 | 383 | 13 | 1 |
| 27 | 5522 | 15.7 | 322 | 16 | 1 |
| 28 | 5523 | 19.8 | 469 | 13 | 1 |
| 29 | 5524 | 18.6 | 406 | 15 | 1 |
| 30 | 5525 | 15.9 | 238 | 14 | 1 |
| Detection Percentage (%) | | | | | 93.33 |

Total Type 1~4 Radar Statistical Performance

| Radar Type # | Detection Percentage (%) |
|--------------|--------------------------|
| 1 | 100.00 |
| 2 | 96.67 |
| 3 | 100.00 |
| 4 | 93.33 |
| Total 1~4 | 97.50 |

Type 5 Radar Statistical Performance

| Trail # | 1=Detection 0=No Detection | Trail # | 1=Detection 0=No Detection | Trail # | 1=Detection 0=No Detection |
|--------------------------|-------------------------------|---------|-------------------------------|---------|-------------------------------|
| 1 | 1 | 11 | 1 | 21 | 1 |
| 2 | 1 | 12 | 1 | 22 | 0 |
| 3 | 0 | 13 | 1 | 23 | 1 |
| 4 | 1 | 14 | 1 | 24 | 1 |
| 5 | 1 | 15 | 1 | 25 | 1 |
| 6 | 1 | 16 | 1 | 26 | 1 |
| 7 | 1 | 17 | 1 | 27 | 1 |
| 8 | 1 | 18 | 1 | 28 | 1 |
| 9 | 1 | 19 | 1 | 29 | 1 |
| 10 | 1 | 20 | 1 | 30 | 0 |
| Detection Percentage (%) | | | | | 90.00 |



Type 6 Radar Statistical Performance

| Trail # | Test Freq. (MHz) | Pulses / Hop | Pulse Width (us) | PRI (us) | 1=Detection 0=No Detection |
|--------------------------|------------------|--------------|------------------|----------|-------------------------------|
| 1 | 5510 | 9 | 1 | 333 | 1 |
| 2 | 5510 | 9 | 1 | 333 | 1 |
| 3 | 5510 | 9 | 1 | 333 | 1 |
| 4 | 5510 | 9 | 1 | 333 | 1 |
| 5 | 5510 | 9 | 1 | 333 | 1 |
| 6 | 5510 | 9 | 1 | 333 | 1 |
| 7 | 5510 | 9 | 1 | 333 | 1 |
| 8 | 5510 | 9 | 1 | 333 | 1 |
| 9 | 5510 | 9 | 1 | 333 | 1 |
| 10 | 5510 | 9 | 1 | 333 | 1 |
| 11 | 5510 | 9 | 1 | 333 | 1 |
| 12 | 5510 | 9 | 1 | 333 | 1 |
| 13 | 5510 | 9 | 1 | 333 | 1 |
| 14 | 5510 | 9 | 1 | 333 | 1 |
| 15 | 5510 | 9 | 1 | 333 | 1 |
| 16 | 5510 | 9 | 1 | 333 | 1 |
| 17 | 5510 | 9 | 1 | 333 | 1 |
| 18 | 5510 | 9 | 1 | 333 | 1 |
| 19 | 5510 | 9 | 1 | 333 | 1 |
| 20 | 5510 | 9 | 1 | 333 | 1 |
| 21 | 5510 | 9 | 1 | 333 | 1 |
| 22 | 5510 | 9 | 1 | 333 | 1 |
| 23 | 5510 | 9 | 1 | 333 | 1 |
| 24 | 5510 | 9 | 1 | 333 | 1 |
| 25 | 5510 | 9 | 1 | 333 | 1 |
| 26 | 5510 | 9 | 1 | 333 | 1 |
| 27 | 5510 | 9 | 1 | 333 | 1 |
| 28 | 5510 | 9 | 1 | 333 | 1 |
| 29 | 5510 | 9 | 1 | 333 | 1 |
| 30 | 5510 | 9 | 1 | 333 | 1 |
| Detection Percentage (%) | | | | | 100.00 |



For 80MHz

Type 1 Radar Statistical Performance

| Trail # | Test Freq. (MHz) | Pulse Width (us) | PRI (us) | Pulses / Burst | 1=Detection 0=No Detection |
|--------------------------|------------------|------------------|----------|----------------|-------------------------------|
| 1 | 5516 | 1 | 1428 | 18 | 1 |
| 2 | 5517 | 1 | 1428 | 18 | 1 |
| 3 | 5518 | 1 | 1428 | 18 | 1 |
| 4 | 5519 | 1 | 1428 | 18 | 1 |
| 5 | 5520 | 1 | 1428 | 18 | 1 |
| 6 | 5521 | 1 | 1428 | 18 | 1 |
| 7 | 5522 | 1 | 1428 | 18 | 1 |
| 8 | 5523 | 1 | 1428 | 18 | 1 |
| 9 | 5524 | 1 | 1428 | 18 | 1 |
| 10 | 5525 | 1 | 1428 | 18 | 1 |
| 11 | 5526 | 1 | 1428 | 18 | 1 |
| 12 | 5527 | 1 | 1428 | 18 | 1 |
| 13 | 5528 | 1 | 1428 | 18 | 1 |
| 14 | 5529 | 1 | 1428 | 18 | 1 |
| 15 | 5530 | 1 | 1428 | 18 | 1 |
| 16 | 5531 | 1 | 1428 | 18 | 1 |
| 17 | 5532 | 1 | 1428 | 18 | 1 |
| 18 | 5533 | 1 | 1428 | 18 | 1 |
| 19 | 5534 | 1 | 1428 | 18 | 1 |
| 20 | 5535 | 1 | 1428 | 18 | 1 |
| 21 | 5536 | 1 | 1428 | 18 | 1 |
| 22 | 5537 | 1 | 1428 | 18 | 1 |
| 23 | 5538 | 1 | 1428 | 18 | 1 |
| 24 | 5539 | 1 | 1428 | 18 | 1 |
| 25 | 5540 | 1 | 1428 | 18 | 1 |
| 26 | 5541 | 1 | 1428 | 18 | 1 |
| 27 | 5542 | 1 | 1428 | 18 | 1 |
| 28 | 5543 | 1 | 1428 | 18 | 1 |
| 29 | 5544 | 1 | 1428 | 18 | 1 |
| 30 | 5545 | 1 | 1428 | 18 | 1 |
| Detection Percentage (%) | | | | | 100.00 |



Type 2 Radar Statistical Performance

| Trail # | Test Freq. (MHz) | Pulse Width (us) | PRI (us) | Pulses / Burst | 1=Detection 0=No Detection |
|--------------------------|------------------|------------------|----------|----------------|-------------------------------|
| 1 | 5516 | 2.6 | 221 | 23 | 1 |
| 2 | 5517 | 4.6 | 198 | 27 | 1 |
| 3 | 5518 | 1.1 | 184 | 29 | 1 |
| 4 | 5519 | 4.8 | 203 | 24 | 1 |
| 5 | 5520 | 2.4 | 162 | 25 | 1 |
| 6 | 5521 | 3.4 | 204 | 28 | 1 |
| 7 | 5522 | 2.3 | 170 | 27 | 1 |
| 8 | 5523 | 3.5 | 184 | 23 | 1 |
| 9 | 5524 | 4.9 | 150 | 27 | 0 |
| 10 | 5525 | 4.6 | 211 | 29 | 1 |
| 11 | 5526 | 2.9 | 158 | 23 | 1 |
| 12 | 5527 | 2.6 | 226 | 27 | 1 |
| 13 | 5528 | 1.6 | 204 | 26 | 1 |
| 14 | 5529 | 3.9 | 181 | 25 | 1 |
| 15 | 5530 | 4.6 | 202 | 24 | 1 |
| 16 | 5531 | 4.1 | 194 | 27 | 1 |
| 17 | 5532 | 2.3 | 193 | 28 | 1 |
| 18 | 5533 | 3.9 | 173 | 29 | 1 |
| 19 | 5534 | 4.3 | 188 | 23 | 1 |
| 20 | 5535 | 1.5 | 215 | 26 | 1 |
| 21 | 5536 | 4.9 | 227 | 27 | 1 |
| 22 | 5537 | 1.1 | 199 | 23 | 1 |
| 23 | 5538 | 4.5 | 155 | 29 | 1 |
| 24 | 5539 | 4.0 | 190 | 27 | 1 |
| 25 | 5540 | 2.4 | 151 | 23 | 1 |
| 26 | 5541 | 2.5 | 180 | 28 | 1 |
| 27 | 5542 | 2.5 | 228 | 23 | 1 |
| 28 | 5543 | 2.5 | 203 | 25 | 1 |
| 29 | 5544 | 1.5 | 188 | 25 | 1 |
| 30 | 5545 | 1.9 | 217 | 24 | 1 |
| Detection Percentage (%) | | | | | 96.67 |



Type 3 Radar Statistical Performance

| Trail # | Test Freq. (MHz) | Pulse Width (us) | PRI (us) | Pulses / Burst | 1=Detection 0=No Detection |
|--------------------------|------------------|------------------|----------|----------------|-------------------------------|
| 1 | 5516 | 8.0 | 205 | 16 | 1 |
| 2 | 5517 | 6.7 | 382 | 18 | 1 |
| 3 | 5518 | 8.6 | 418 | 16 | 1 |
| 4 | 5519 | 9.4 | 351 | 17 | 1 |
| 5 | 5520 | 7.4 | 383 | 18 | 1 |
| 6 | 5521 | 9.8 | 232 | 16 | 1 |
| 7 | 5522 | 9.1 | 377 | 17 | 1 |
| 8 | 5523 | 9.6 | 457 | 16 | 1 |
| 9 | 5524 | 8.0 | 471 | 18 | 1 |
| 10 | 5525 | 9.0 | 304 | 18 | 1 |
| 11 | 5526 | 8.0 | 316 | 17 | 1 |
| 12 | 5527 | 9.8 | 325 | 16 | 1 |
| 13 | 5528 | 8.0 | 409 | 17 | 1 |
| 14 | 5529 | 9.9 | 200 | 17 | 1 |
| 15 | 5530 | 8.8 | 458 | 16 | 1 |
| 16 | 5531 | 8.0 | 232 | 18 | 1 |
| 17 | 5532 | 8.3 | 250 | 16 | 1 |
| 18 | 5533 | 8.7 | 270 | 16 | 1 |
| 19 | 5534 | 7.7 | 350 | 17 | 1 |
| 20 | 5535 | 7.1 | 230 | 16 | 1 |
| 21 | 5536 | 7.3 | 416 | 18 | 1 |
| 22 | 5537 | 7.6 | 498 | 18 | 1 |
| 23 | 5538 | 7.3 | 286 | 17 | 1 |
| 24 | 5539 | 7.3 | 287 | 16 | 1 |
| 25 | 5540 | 7.5 | 462 | 17 | 1 |
| 26 | 5541 | 6.2 | 300 | 17 | 1 |
| 27 | 5542 | 6.4 | 323 | 18 | 1 |
| 28 | 5543 | 7.1 | 420 | 16 | 1 |
| 29 | 5544 | 7.2 | 395 | 18 | 0 |
| 30 | 5545 | 8.4 | 377 | 16 | 1 |
| Detection Percentage (%) | | | | | 96.67 |



Type 4 Radar Statistical Performance

| Trail # | Test Freq. (MHz) | Pulse Width (us) | PRI (us) | Pulses / Burst | 1=Detection 0=No Detection |
|---------------------------------|-------------------------|-------------------------|-----------------|-----------------------|---------------------------------------|
| 1 | 5516 | 18.0 | 242 | 15 | 1 |
| 2 | 5517 | 19.9 | 279 | 12 | 1 |
| 3 | 5518 | 12.9 | 487 | 14 | 1 |
| 4 | 5519 | 15.0 | 452 | 13 | 1 |
| 5 | 5520 | 16.3 | 230 | 12 | 1 |
| 6 | 5521 | 19.8 | 238 | 13 | 1 |
| 7 | 5522 | 18.2 | 420 | 16 | 1 |
| 8 | 5523 | 16.3 | 452 | 15 | 1 |
| 9 | 5524 | 14.2 | 495 | 12 | 1 |
| 10 | 5525 | 17.8 | 228 | 16 | 1 |
| 11 | 5526 | 19.1 | 211 | 16 | 1 |
| 12 | 5527 | 18.4 | 283 | 15 | 1 |
| 13 | 5528 | 11.8 | 411 | 12 | 1 |
| 14 | 5529 | 14.2 | 284 | 13 | 1 |
| 15 | 5530 | 13.9 | 202 | 12 | 1 |
| 16 | 5531 | 17.8 | 340 | 14 | 0 |
| 17 | 5532 | 15.6 | 290 | 16 | 1 |
| 18 | 5533 | 14.6 | 250 | 16 | 1 |
| 19 | 5534 | 14.4 | 484 | 15 | 1 |
| 20 | 5535 | 18.9 | 387 | 13 | 1 |
| 21 | 5536 | 11.1 | 348 | 15 | 1 |
| 22 | 5537 | 13.8 | 291 | 16 | 1 |
| 23 | 5538 | 14.3 | 295 | 12 | 0 |
| 24 | 5539 | 12.5 | 300 | 12 | 1 |
| 25 | 5540 | 12.5 | 322 | 14 | 1 |
| 26 | 5541 | 12.5 | 383 | 13 | 1 |
| 27 | 5542 | 15.7 | 322 | 16 | 1 |
| 28 | 5543 | 19.8 | 469 | 13 | 1 |
| 29 | 5544 | 18.6 | 406 | 15 | 1 |
| 30 | 5545 | 15.9 | 238 | 14 | 1 |
| Detection Percentage (%) | | | | | 93.33 |

Total Type 1~4 Radar Statistical Performance

| Radar Type # | Detection Percentage (%) |
|--------------|--------------------------|
| 1 | 100.00 |
| 2 | 96.67 |
| 3 | 96.67 |
| 4 | 93.33 |
| Total 1~4 | 96.67 |

Type 5 Radar Statistical Performance

| Trail # | 1=Detection 0=No Detection | Trail # | 1=Detection 0=No Detection | Trail # | 1=Detection 0=No Detection |
|--------------------------|-------------------------------|---------|-------------------------------|---------|-------------------------------|
| 1 | 0 | 11 | 1 | 21 | 1 |
| 2 | 1 | 12 | 1 | 22 | 1 |
| 3 | 1 | 13 | 1 | 23 | 1 |
| 4 | 1 | 14 | 1 | 24 | 1 |
| 5 | 1 | 15 | 0 | 25 | 1 |
| 6 | 1 | 16 | 1 | 26 | 1 |
| 7 | 1 | 17 | 1 | 27 | 1 |
| 8 | 0 | 18 | 1 | 28 | 0 |
| 9 | 1 | 19 | 1 | 29 | 1 |
| 10 | 1 | 20 | 1 | 30 | 1 |
| Detection Percentage (%) | | | | | 86.67 |



Type 6 Radar Statistical Performance

| Trail # | Test Freq. (MHz) | Pulses / Hop | Pulse Width (us) | PRI (us) | 1=Detection 0=No Detection |
|--------------------------|------------------|--------------|------------------|----------|-------------------------------|
| 1 | 5530 | 9 | 1 | 333 | 1 |
| 2 | 5530 | 9 | 1 | 333 | 1 |
| 3 | 5530 | 9 | 1 | 333 | 1 |
| 4 | 5530 | 9 | 1 | 333 | 1 |
| 5 | 5530 | 9 | 1 | 333 | 1 |
| 6 | 5530 | 9 | 1 | 333 | 1 |
| 7 | 5530 | 9 | 1 | 333 | 1 |
| 8 | 5530 | 9 | 1 | 333 | 1 |
| 9 | 5530 | 9 | 1 | 333 | 1 |
| 10 | 5530 | 9 | 1 | 333 | 1 |
| 11 | 5530 | 9 | 1 | 333 | 1 |
| 12 | 5530 | 9 | 1 | 333 | 1 |
| 13 | 5530 | 9 | 1 | 333 | 1 |
| 14 | 5530 | 9 | 1 | 333 | 1 |
| 15 | 5530 | 9 | 1 | 333 | 1 |
| 16 | 5530 | 9 | 1 | 333 | 1 |
| 17 | 5530 | 9 | 1 | 333 | 1 |
| 18 | 5530 | 9 | 1 | 333 | 1 |
| 19 | 5530 | 9 | 1 | 333 | 1 |
| 20 | 5530 | 9 | 1 | 333 | 1 |
| 21 | 5530 | 9 | 1 | 333 | 1 |
| 22 | 5530 | 9 | 1 | 333 | 1 |
| 23 | 5530 | 9 | 1 | 333 | 1 |
| 24 | 5530 | 9 | 1 | 333 | 1 |
| 25 | 5530 | 9 | 1 | 333 | 1 |
| 26 | 5530 | 9 | 1 | 333 | 1 |
| 27 | 5530 | 9 | 1 | 333 | 1 |
| 28 | 5530 | 9 | 1 | 333 | 1 |
| 29 | 5530 | 9 | 1 | 333 | 1 |
| 30 | 5530 | 9 | 1 | 333 | 1 |
| Detection Percentage (%) | | | | | 100.00 |

6. LIST OF MEASURING EQUIPMENTS

| Instrument | Manufacturer | Model No. | Serial No. | Characteristics | Calibration Date | Remark |
|------------------|--------------|---------------|----------------|------------------|------------------|---------------------|
| Signal analyzer | R&S | FSV40 | 100979 | 9kHz~40GHz | Nov. 29, 2013 | Radiation (TH01-CB) |
| Signal Generator | R&S | SMR40 | 100302 | 10MHz-40GHz | Dec. 02, 2013 | Radiation (TH01-CB) |
| RF Power Divider | Woken | 2 Way | 0120A02056002D | 2GHz ~ 18GHz | Nov. 17, 2013 | Radiation (TH01-CB) |
| RF Power Divider | Woken | 3 Way | MDC2366 | 2GHz ~ 18GHz | Nov. 17, 2013 | Radiation (TH01-CB) |
| RF Power Divider | Woken | 4 Way | 0120A04056002D | 2GHz ~ 18GHz | Nov. 17, 2013 | Radiation (TH01-CB) |
| Signal generator | R&S | SMU200A | 102782 | 25MHz-6GHz | Nov. 15, 2013 | Radiation (TH01-CB) |
| Horn Antenna | COM-POWER | AH-118 | 071187 | 1GHz – 18GHz | Aug. 26, 2014 | Radiation (TH01-CB) |
| Horn Antenna | COM-POWER | AH-118 | 071042 | 1GHz – 18GHz | Nov. 20, 2013 | Radiation (TH01-CB) |
| RF Cable-high | Woken | High Cable-7 | - | 1 GHz – 26.5 GHz | Nov. 17, 2013 | Radiation (TH01-CB) |
| RF Cable-high | Woken | High Cable-8 | - | 1 GHz – 26.5 GHz | Nov. 17, 2013 | Radiation (TH01-CB) |
| RF Cable-high | Woken | High Cable-9 | - | 1 GHz – 26.5 GHz | Nov. 17, 2013 | Radiation (TH01-CB) |
| RF Cable-high | Woken | High Cable-10 | - | 1 GHz – 26.5 GHz | Nov. 17, 2013 | Radiation (TH01-CB) |
| RF Cable-high | Woken | High Cable-11 | - | 1 GHz – 26.5 GHz | Nov. 17, 2013 | Radiation (TH01-CB) |

Note: Calibration Interval of instruments listed above is one year.

7. MEASUREMENT UNCERTAINTY

| Test Items | Uncertainty | Remark |
|-------------------|-------------|--------------------------|
| Radiated Emission | 2.9 dB | Confidence levels of 95% |