

FCC Test Report

FCC ID : PY314300286
Equipment : Wireless AC750 DSL Modem Router
Model No. : D6000, D6010 (for marketing purpose only.)
Brand Name : NETGEAR
Applicant : NETGEAR, Inc.
Address : 350 East Plumeria Drive, San Jose, California
95134, USA
Standard : 47 CFR FCC Part 15.247
Received Date : Jun. 17, 2014
Tested Date : Jun. 19 ~ Jul. 30, 2014

We, International Certification Corp., would like to declare that the tested sample has been evaluated and in compliance with the requirement of the above standards. The test results contained in this report refer exclusively to the product. It may be duplicated completely for legal use with the approval of the applicant. It shall not be reproduced except in full without the written approval of our laboratory.

Approved & Reviewed by:

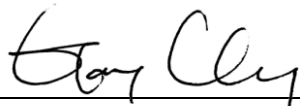

Gary Chang / Manager



Table of Contents

1	GENERAL DESCRIPTION	5
1.1	Information.....	5
1.2	Local Support Equipment List	8
1.3	Test Setup Chart	8
1.4	The Equipment List	9
1.5	Test Standards	10
1.6	Measurement Uncertainty	10
2	TEST CONFIGURATION	11
2.1	Testing Condition	11
2.2	The Worst Test Modes and Channel Details	11
3	TRANSMITTER TEST RESULTS.....	12
3.1	Conducted Emissions.....	12
3.2	6dB and Occupied Bandwidth	15
3.3	RF Output Power	18
3.4	Power Spectral Density	22
3.5	Unwanted Emissions into Restricted Frequency Bands	24
3.6	Unwanted Emissions into Non-Restricted Frequency Bands	46
4	TEST LABORATORY INFORMATION	56

Release Record

Report No.	Version	Description	Issued Date
FR462301AI	Rev. 01	Initial issue	Aug. 21, 2014

Summary of Test Results

FCC Rules	Test Items	Measured	Result
15.207	Conducted Emissions	[dBuV]: 0.396MHz 41.94 (Margin -6.01dB) - AV	Pass
15.247(d) 15.209	Radiated Emissions	[dBuV/m at 3m]: 11490.00MHz 53.89 (Margin -0.11dB) – AV [dBuV/m at 3m]: 11650.00MHz 53.89 (Margin -0.11dB) - AV	Pass
15.247(b)(3)	Fundamental Emission Output Power	Max Power [dBm]: 27.22	Pass
15.247(a)(2)	6dB Bandwidth	Meet the requirement of limit	Pass
15.247(e)	Power Spectral Density	Meet the requirement of limit	Pass
15.203	Antenna Requirement	Meet the requirement of limit	Pass

1 General Description

1.1 Information

1.1.1 Specification of the Equipment under Test (EUT)

RF General Information					
Frequency Range (MHz)	IEEE Std. 802.11	Ch. Freq. (MHz)	Channel Number	Transmit Chains (N _{TX})	Data Rate / MCS
5725-5850	a	5745-5825	149-165 [5]	1	6-54 Mbps
5725-5850	n (HT20)	5745-5825	149-165 [5]	1	MCS 0-7
5725-5850	n (HT40)	5755-5795	151-159 [2]	1	MCS 0-7
5725-5850	ac (VHT20)	5745-5825	149-165 [5]	1	MCS 0-8
5725-5850	ac (VHT40)	5755-5795	151-159 [2]	1	MCS 0-9
5725-5850	ac (VHT80)	5775	155 [1]	1	MCS 0-9

Note 1: RF output power specifies that Maximum Peak Conducted Output Power..
 Note 2: 802.11a/n/ac uses a combination of OFDM-BPSK, QPSK, 16QAM, 64QAM, 256QAM modulation.

1.1.2 Antenna Details

Ant. No.	Model	Type	Connector	Gain (dBi)
1	90VEAA15 G06	dipole	I-PEX	4.23

1.1.3 Power Supply Type of Equipment under Test (EUT)

Power Supply Type	12Vdc from AC adapter
--------------------------	-----------------------

1.1.4 Accessories

Accessories		
No.	Equipment	Description
1	AC Adapter 1	Brand Name: NETGEAR Model Name: ML18-7120150-A1 P/N: 332-10653-01 Power Rating: I/P: 120Vac, 60Hz, 0.5A O/P: 12Vdc, 1.5A Power Line: 1.85m non-shielded cable w/o core
2	AC Adapter 2	Brand Name: NETGEAR Model Name: AD817F10 P/N: 332-10301-02 Power Rating: I/P: 100-120Vac, 50-60Hz, 0.56A O/P: 12Vdc, 1.5A Power Line: 1.85m non-shielded cable w/o core

1.1.5 Channel List

Frequency band (MHz)		5725~5850	
802.11 a / HT20 / VHT20		HT40 / VHT40	
Channel	Frequency(MHz)	Channel	Frequency(MHz)
149	5745	151	5755
153	5765	159	5795
157	5785	VHT80	
161	5805	155	5775
165	5825	---	---

1.1.6 Test Tool and Duty Cycle

Test Tool	MT76xx, Version 2.0.10.9		
Duty Cycle and Duty Factor	Mode	Duty cycle (%)	Duty factor (dB)
	11a	88.60%	0.53
	VHT20	88.43%	0.53
	VHT40	77.89%	1.09
	VHT80	61.98%	2.08

1.1.7 Power Setting

Modulation Mode	Test Frequency (MHz)	Power Set
11a	5745	0A
11a	5785	07
11a	5825	07
HT20	5745	0B
HT20	5785	08
HT20	5825	08
HT40	5755	0F
HT40	5795	0C
VHT20	5745	0B
VHT20	5785	08
VHT20	5825	08
VHT40	5755	0F
VHT40	5795	0C
VHT80	5775	11

1.2 Local Support Equipment List

Support Equipment List						
No.	Equipment	Brand	Model	S/N	FCC ID	Signal cable / Length (m)
1	Notebook	DELL	E6430	---	DoC	RJ45, 8m non-shielded cable w/o core.

1.3 Test Setup Chart

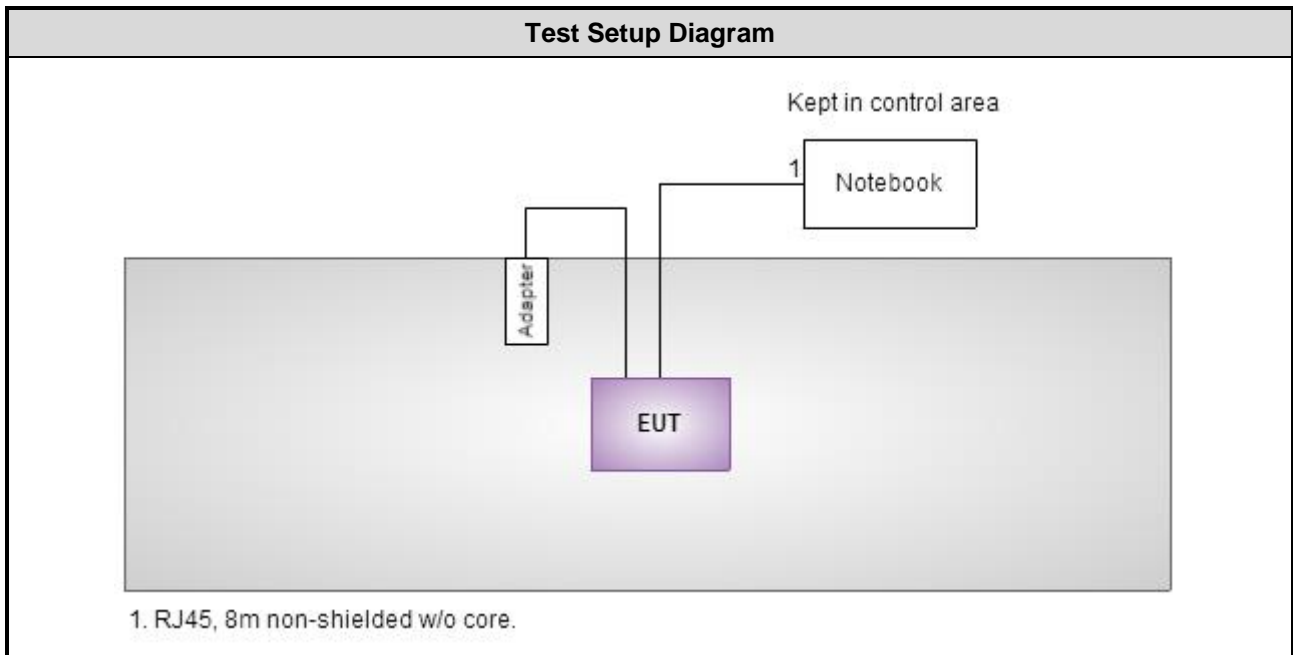

1.4 The Equipment List

Test Item	Conducted Emission				
Test Site	Conduction room 1 / (CO01-WS)				
Instrument	Manufacturer	Model No.	Serial No.	Calibration Date	Calibration Until
EMC Receiver	R&S	ESCS 30	100169	Oct. 15, 2013	Oct. 14, 2014
LISN	SCHWARZBECK	Schwarzbeck 8127	8127-667	Nov. 23, 2013	Nov. 22, 2014
LISN (Support Unit)	SCHWARZBECK	Schwarzbeck 8127	8127-666	Dec. 04, 2013	Dec. 03, 2014
RF Cable-CON	Woken	CFD200-NL	CFD200-NL-001	Apr. 23, 2014	Apr. 22, 2015
50 ohm terminal (Support Unit)	NA	50	04	Apr. 18, 2014	Apr. 17, 2015

Note: Calibration Interval of instruments listed above is one year.

Test Item	Radiated Emission				
Test Site	966 chamber 2 / (03CH02-WS)				
Instrument	Manufacturer	Model No.	Serial No.	Calibration Date	Calibration Until
Spectrum Analyzer	R&S	FSV40	101499	Feb. 08, 2014	Feb. 07, 2015
Receiver	R&S	ESR3	101657	Jan. 18, 2014	Jan. 17, 2015
Bilog Antenna	SCHWARZBECK	VULB9168	VULB9168-524	Jan. 08, 2014	Jan. 07, 2015
Horn Antenna 1G-18G	SCHWARZBECK	BBHA 9120 D	BBHA 9120 D 1095	Jan. 07, 2014	Jan. 06, 2015
Horn Antenna 18G-40G	SCHWARZBECK	BBHA 9170	BBHA 9170517	Dec. 27, 2013	Dec. 26, 2014
Preamplifier	Burgeon	BPA-530	100218	Dec. 09, 2013	Dec. 08, 2014
Preamplifier	Agilent	83017A	MY39501309	Dec. 09, 2013	Dec. 08, 2014
Preamplifier	WM	TF-130N-R1	923365	Oct. 23, 2013	Oct. 22, 2014
RF Cable	HUBER+SUHNER	SUCOFLEX104	MY16140/4	Dec. 17, 2013	Dec. 16, 2014
RF Cable	HUBER+SUHNER	SUCOFLEX104	MY16018/4	Dec. 17, 2013	Dec. 16, 2014
RF Cable	HUBER+SUHNER	SUCOFLEX104	MY16015/4	Dec. 17, 2013	Dec. 16, 2014
LF cable 3M	Woken	CFD400NL-LW	CFD400NL-003	Dec. 17, 2013	Dec. 16, 2014
LF cable 10M	Woken	CFD400NL-LW	CFD400NL-004	Dec. 17, 2013	Dec. 16, 2014

Note: Calibration Interval of instruments listed above is one year.

Loop Antenna	R&S	HFH2-Z2	100330	Nov. 15, 2012	Nov. 14, 2014
--------------	-----	---------	--------	---------------	---------------

Note: Calibration Interval of instruments listed above is two year.

Test Item	RF Conducted				
Test Site	(TH01-WS)				
Instrument	Manufacturer	Model No.	Serial No.	Calibration Date	Calibration Until
Spectrum Analyzer	R&S	FSV40	101063	Feb. 17, 2014	Feb. 16, 2015
Power Meter	Anritsu	ML2495A	1241002	Oct. 24, 2013	Oct. 23, 2014
Power Sensor	Anritsu	MA2411B	1207366	Oct. 24, 2013	Oct. 23, 2014
Spectrum Analyzer	Agilent	N9030A	MY52350930	Oct. 19, 2013	Oct. 18, 2014

Note: Calibration Interval of instruments listed above is one year.

1.5 Test Standards

According to the specification of EUT, the EUT must comply with following standards and KDB documents.

47 CFR FCC Part 15.247

ANSI C63.10-2009

FCC KDB 558074 D01 DTS Meas Guidance v03r02

FCC KDB 644545 D01 Guidance for IEEE 802 11ac v01r02

FCC KDB 644545 D02 Alternative Guidance for 802 11ac v01

Note: The EUT has been tested and complied with FCC part 15B requirement. FCC Part 15B test results are issued to another report.

1.6 Measurement Uncertainty

ISO/IEC 17025 requires that an estimate of the measurement uncertainties associated with the emissions test results be included in the report. The measurement uncertainties given below are based on a 95% confidence level (based on a coverage factor (k=2))

Measurement Uncertainty	
Parameters	Uncertainty
Bandwidth	±34.134 Hz
Conducted power	±0.808 dB
Frequency error	±34.134 Hz
Temperature	±0.6 °C
Conducted emission	±2.670 dB
AC conducted emission	±2.92 dB
Radiated emission ≤ 1GHz	±3.26 dB
Radiated emission > 1GHz	±4.94 dB

2 Test Configuration

2.1 Testing Condition

Test Item	Test Site	Ambient Condition	Tested By
AC Conduction	CO01-WS	21°C / 63%	Skys Huang
Radiated Emissions	03CH02-WS	25-26°C / 65%	York Lin
RF Conducted	TH01-WS	22°C / 64%	Felix Sung

- FCC site registration No.: 657002
- IC site registration No.: 10807A-2

2.2 The Worst Test Modes and Channel Details

Test item	Modulation Mode	Test Frequency (MHz)	Data Rate (Mbps) / MCS	Test Configuration
Conducted Emissions	VHT20	5785	MCS 0	1
Radiated Emissions ≤1GHz	VHT20	5785	MCS 0	2
RF Output Power	11a	5745 / 5785 / 5825	6 Mbps	2
	HT20	5745 / 5785 / 5825	MCS 0	
	HT40	5755 / 5795	MCS 0	
	VHT20	5745 / 5785 / 5825	MCS 0	
	VHT40	5755 / 5795	MCS 0	
	VHT80	5775	MCS 0	
Radiated Emissions >1GHz 6dB bandwidth Power spectral density	11a	5745 / 5785 / 5825	6 Mbps	2
	VHT20	5745 / 5785 / 5825	MCS 0	
	VHT40	5755 / 5795	MCS 0	
	VHT80	5775	MCS 0	

NOTE:

1. Adapter 1 & 2 had been covered during the pretest, and was selected as below configuration for final testing.
2. Test configurations are listed as below:
 - 1) Configuration 1: Adapter 1 (Model: ML18-7120150-A1)
 - 2) Configuration 2: Adapter 2 (Model: AD817F10)

3 Transmitter Test Results

3.1 Conducted Emissions

3.1.1 Limit of Conducted Emissions

Conducted Emissions Limit		
Frequency Emission (MHz)	Quasi-Peak	Average
0.15-0.5	66 - 56 *	56 - 46 *
0.5-5	56	46
5-30	60	50

Note 1: * Decreases with the logarithm of the frequency.

3.1.2 Test Procedures

1. The device is placed on a test table, raised 80 cm above the reference ground plane. The vertical conducting plane is located 40 cm to the rear of the device.
2. The device is connected to line impedance stabilization network (LISN) and other accessories are connected to other LISN. Measured levels of AC power line conducted emission are across the 50 Ω LISN port.
3. AC conducted emission measurements is made over frequency range from 150 kHz to 30 MHz.
4. This measurement was performed with AC 120V / 60Hz.

3.1.3 Test Setup

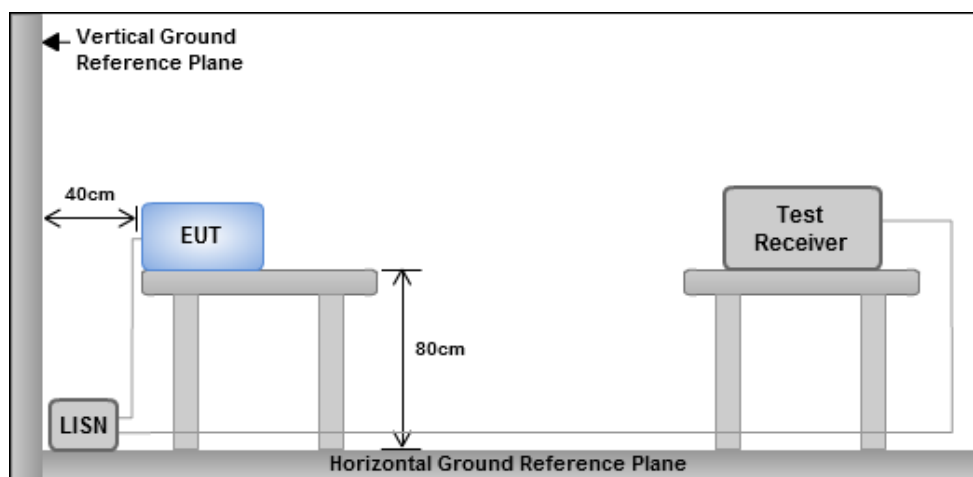

- Note: 1. Support units were connected to second LISN.
 2. Both of LISNs (AMN) are 80 cm from EUT and at least 80 cm from other units and other metal planes

3.1.4 Test Result of Conducted Emissions

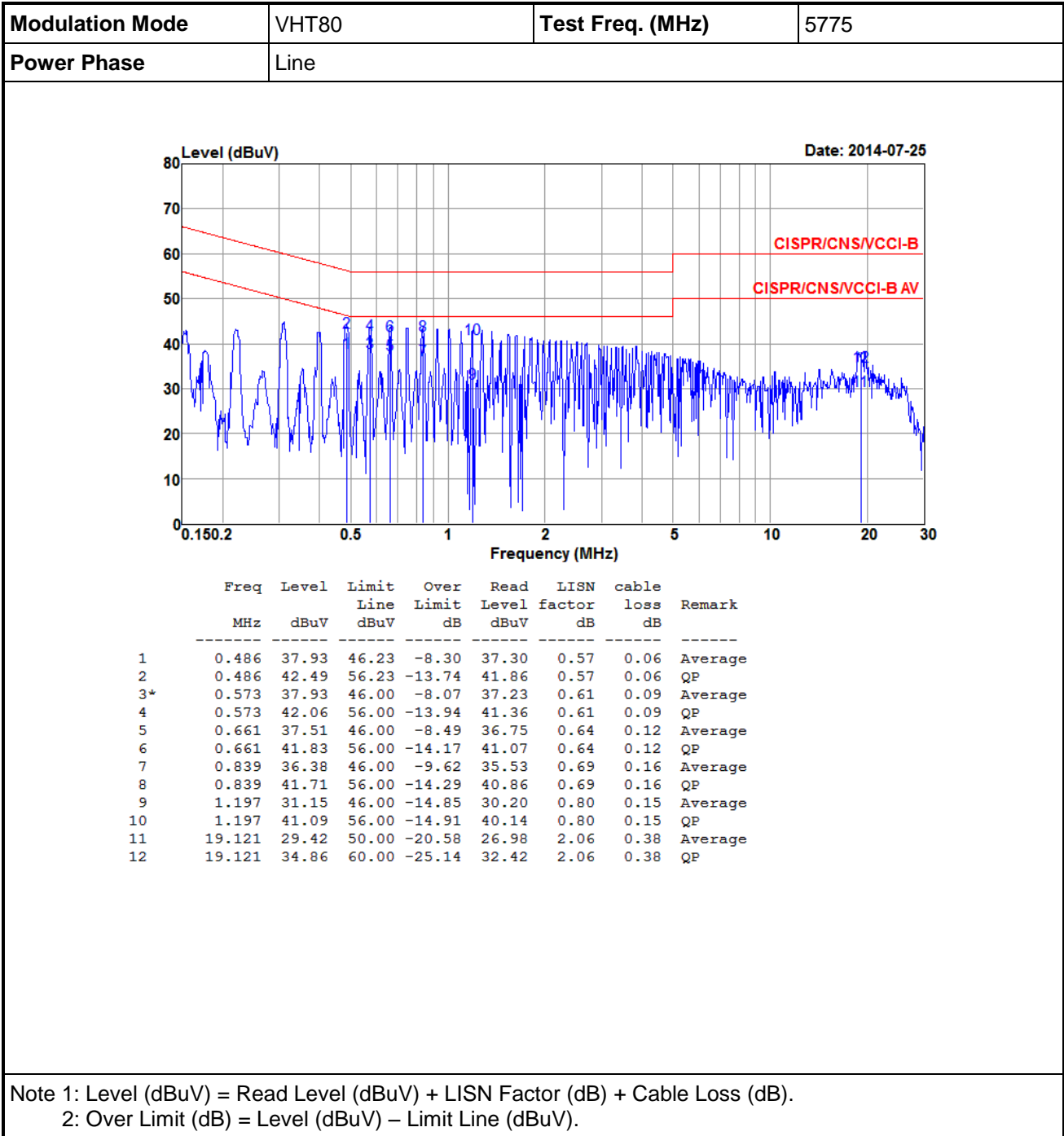

Modulation Mode	VHT80	Test Freq. (MHz)	5755
Power Phase	Neutral		

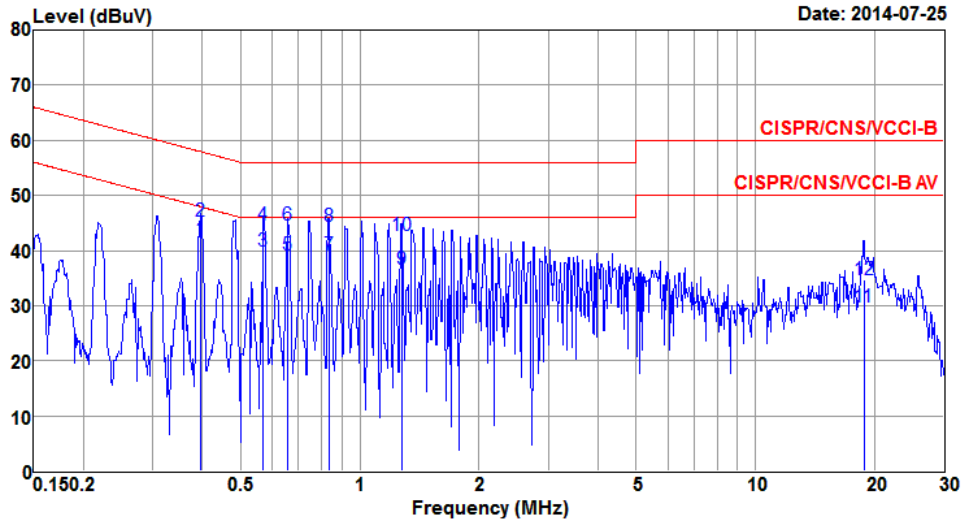

	Freq MHz	Level dBuV	Limit Line dBuV	Over Limit dB	Read Level dBuV	LISN factor dB	cable loss dB	Remark
1*	0.396	41.94	47.95	-6.01	41.31	0.61	0.02	Average
2	0.396	45.24	57.95	-12.71	44.61	0.61	0.02	QP
3	0.570	39.85	46.00	-6.15	39.08	0.68	0.09	Average
4	0.570	44.61	56.00	-11.39	43.84	0.68	0.09	QP
5	0.658	39.19	46.00	-6.81	38.36	0.71	0.12	Average
6	0.658	44.50	56.00	-11.50	43.67	0.71	0.12	QP
7	0.835	39.13	46.00	-6.87	38.21	0.76	0.16	Average
8	0.835	44.30	56.00	-11.70	43.38	0.76	0.16	QP
9	1.276	36.53	46.00	-9.47	35.49	0.90	0.14	Average
10	1.276	42.72	56.00	-13.28	41.68	0.90	0.14	QP
11	18.820	29.67	50.00	-20.33	26.76	2.53	0.38	Average
12	18.820	34.75	60.00	-25.25	31.84	2.53	0.38	QP

Note 1: Level (dBuV) = Read Level (dBuV) + LISN Factor (dB) + Cable Loss (dB).
 2: Over Limit (dB) = Level (dBuV) – Limit Line (dBuV).

3.2 6dB and Occupied Bandwidth

3.2.1 Limit of 6dB Bandwidth

The minimum 6dB bandwidth shall be at least 500 kHz.

3.2.2 Test Procedures

1. Set resolution bandwidth (RBW) = 100 kHz, Video bandwidth = 300 kHz.
2. Detector = Peak, Trace mode = max hold.
3. Sweep = auto couple, Allow the trace to stabilize.
4. Measure the maximum width of the emission that is constrained by the frequencies associated with the two outermost amplitude points (upper and lower) that are attenuated by 6dB relative to the maximum level measured in the fundamental emission.

3.2.3 Test Setup

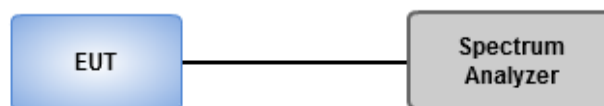

3.2.4 Test Result of 6dB and Occupied Bandwidth

Modulation Mode	N _{TX}	Freq. (MHz)	6dB Bandwidth (MHz)				Limit (kHz)
			Chain 0	Chain 1	Chain 2	Chain 3	
11a	1	5745	16.29	---	---	---	500
11a	1	5785	16.35	---	---	---	500
11a	1	5825	16.35	---	---	---	500
VHT20	1	5745	16.81	---	---	---	500
VHT20	1	5785	16.70	---	---	---	500
VHT20	1	5825	16.81	---	---	---	500
VHT40	1	5755	35.59	---	---	---	500
VHT40	1	5795	35.71	---	---	---	500
VHT80	1	5775	75.13	---	---	---	500

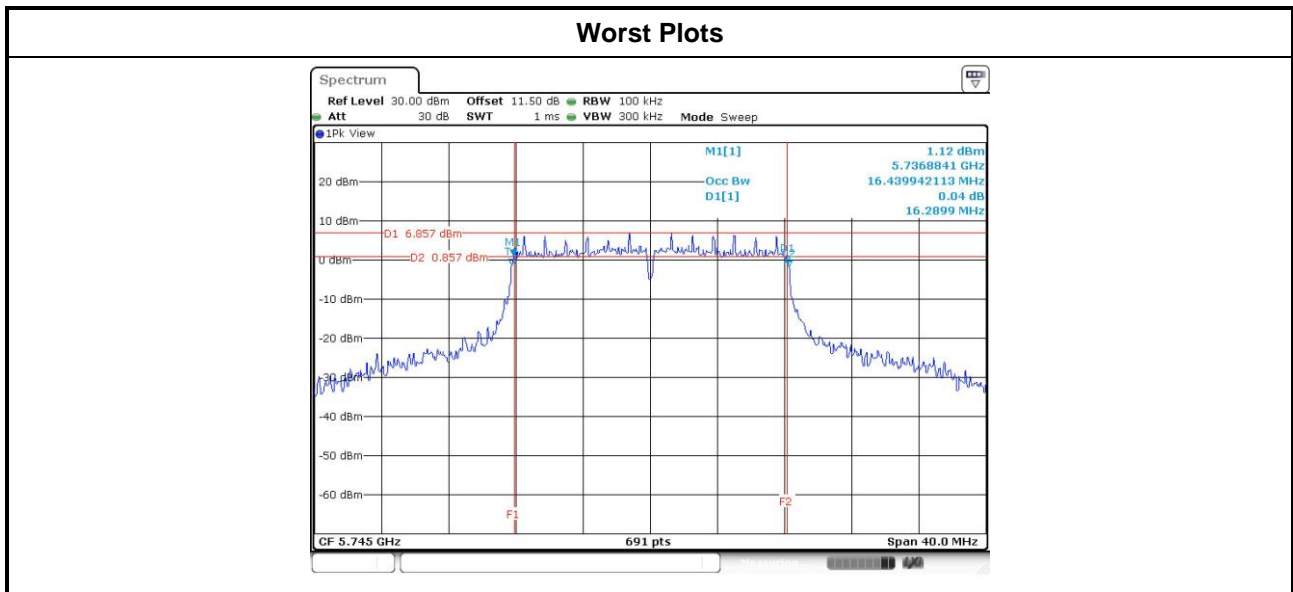

Modulation Mode	N _{TX}	Freq. (MHz)	99% Occupied Bandwidth (MHz)			
			Chain 0	Chain 1	Chain 2	Chain 3
11a	1	5745	16.90	---	---	---
11a	1	5785	16.86	---	---	---
11a	1	5825	16.79	---	---	---
VHT20	1	5745	17.69	---	---	---
VHT20	1	5785	17.62	---	---	---
VHT20	1	5825	17.62	---	---	---
VHT40	1	5755	36.73	---	---	---
VHT40	1	5795	36.47	---	---	---
VHT80	1	5775	75.65	---	---	---

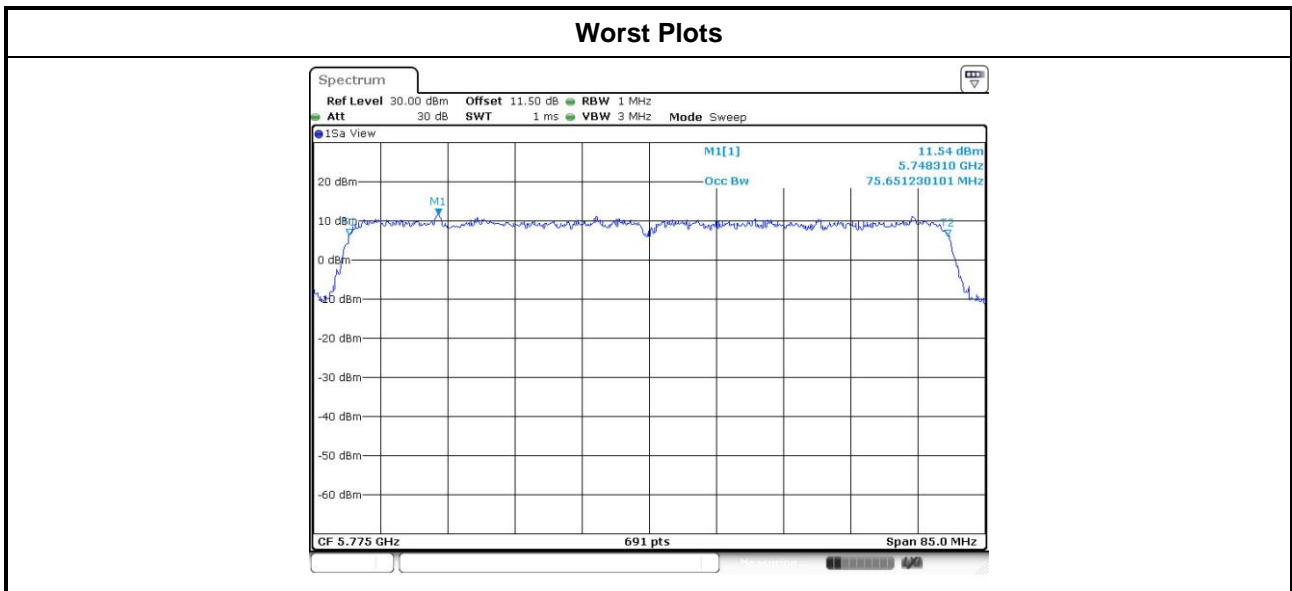

3.3 RF Output Power

3.3.1 Limit of RF Output Power

Conducted power shall not exceed 1Watt.

- Antenna gain \leq 6dBi, no any corresponding reduction is in output power limit.
- Antenna gain $>$ 6dBi
 - Non Fixed, point to point operations.
The conducted output power from the intentional radiator shall be reduced by the amount in dB that the directional gain of the antenna exceeds 6 dB
 - Fixed, point to point operations
Systems operating in the 2400–2483.5 MHz band that are used exclusively for fixed, point-to-point Operations, maximum peak output power of the intentional radiator is reduced by 1 dB for every 3 dB that the directional gain of the antenna exceeds 6 dBi.

Systems operating in the 5725–5850 MHz band that are used exclusively for fixed, point-to-point operations ,no any corresponding reduction is in transmitter peak output power

3.3.2 Test Procedures

- Maximum Peak Conducted Output Power
 - Spectrum analyzer** (For VHT80 mode)
 1. Select I/Q Analyzer mode
 2. Select IQ Waveform and set the analysis bandwidth = 80 MHz
 3. Measure the Peak power
 - Power meter** (For all modes except VHT80 mode)
 1. A broadband Peak RF power meter is used for output power measurement. The video bandwidth of power meter is greater than DTS bandwidth of EUT. If duty cycle of test signal is not 100 %, trigger and gating function of power meter will be enabled to capture transmission burst for measuring output power.
- Maximum Conducted Output Power (For reference only)
 - Power meter**
 1. A broadband Average RF power meter is used for output power measurement. The video bandwidth of power meter is greater than DTS bandwidth of EUT. If duty cycle of test signal is not 100 %, trigger and gating function of power meter will be enabled to capture transmission burst for measuring output power.

3.3.3 Test Setup

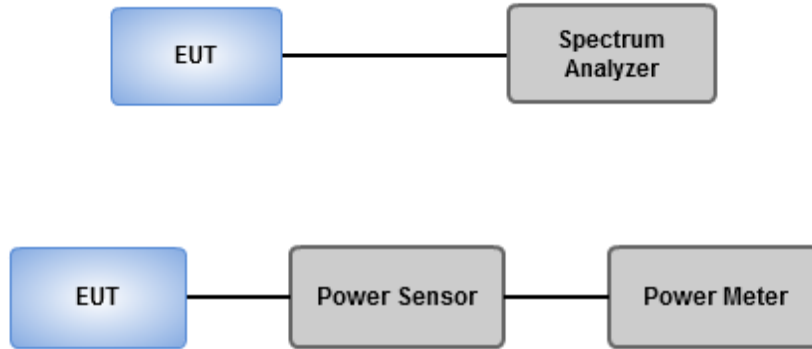

3.3.4 Test Result of Maximum Output Power

Modulation Mode	N _{TX}	Freq. (MHz)	Peak Conducted Output Power (dBm)				Total Power (mW)	Total Power (dBm)	Limit (dBm)
			Chain 0	Chain 1	Chain 2	Chain 3			
11a	1	5745	23.35	---	---	---	216.272	23.35	30.00
11a	1	5785	22.91	---	---	---	195.434	22.91	30.00
11a	1	5825	23.05	---	---	---	201.837	23.05	30.00
HT20	1	5745	23.31	---	---	---	214.289	23.31	30.00
HT20	1	5785	22.94	---	---	---	196.789	22.94	30.00
HT20	1	5825	23.05	---	---	---	201.837	23.05	30.00
HT40	1	5755	23.41	---	---	---	219.280	23.41	30.00
HT40	1	5795	23.26	---	---	---	211.836	23.26	30.00
VHT20	1	5745	23.42	---	---	---	219.786	23.42	30.00
VHT20	1	5785	23.04	---	---	---	201.372	23.04	30.00
VHT20	1	5825	23.11	---	---	---	204.644	23.11	30.00
VHT40	1	5755	23.52	---	---	---	224.905	23.52	30.00
VHT40	1	5795	23.37	---	---	---	217.270	23.37	30.00
VHT80	1	5775	27.22	---	---	---	527.230	27.22	30.00

Modulation Mode	N _{TX}	Freq. (MHz)	Conducted (Average) Output Power (dBm)				Total Power (mW)	Total Power (dBm)	Limit (dBm)
			Chain 0	Chain 1	Chain 2	Chain 3			
11a	1	5745	17.85	---	---	---	60.954	17.85	30.00
11a	1	5785	16.68	---	---	---	46.559	16.68	30.00
11a	1	5825	16.54	---	---	---	45.082	16.54	30.00
HT20	1	5745	17.94	---	---	---	62.230	17.94	30.00
HT20	1	5785	16.75	---	---	---	47.315	16.75	30.00
HT20	1	5825	16.69	---	---	---	46.666	16.69	30.00
HT40	1	5755	19.42	---	---	---	87.498	19.42	30.00
HT40	1	5795	18.31	---	---	---	67.764	18.31	30.00
VHT20	1	5745	18.02	---	---	---	63.387	18.02	30.00
VHT20	1	5785	16.89	---	---	---	48.865	16.89	30.00
VHT20	1	5825	16.81	---	---	---	47.973	16.81	30.00
VHT40	1	5755	19.54	---	---	---	89.950	19.54	30.00
VHT40	1	5795	18.48	---	---	---	70.469	18.48	30.00
VHT80	1	5775	19.79	---	---	---	95.280	19.79	30.00

Note: Conducted average output power is for reference only.

Worst Plots

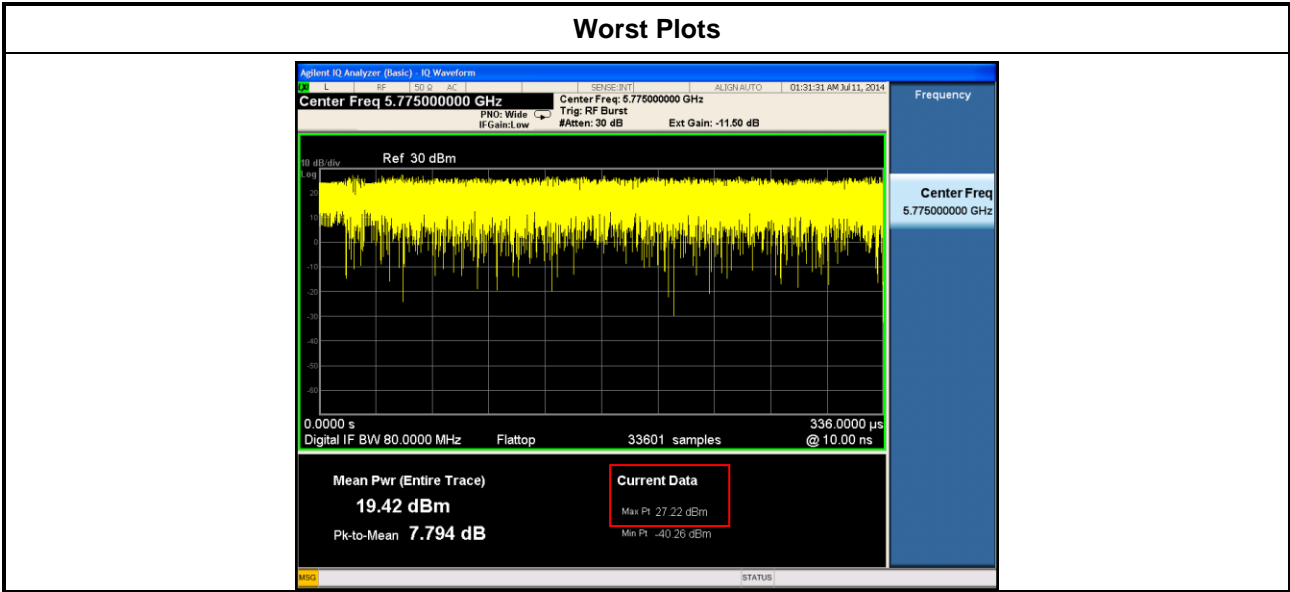

3.4 Power Spectral Density

3.4.1 Limit of Power Spectral Density

Power spectral density shall not be greater than 8 dBm in any 3 kHz band.

3.4.2 Test Procedures

- Maximum peak conducted output power was used to demonstrate compliance to the fundamental output power limit.
 1. Set the RBW = 3kHz, VBW = 10kHz.
 2. Detector = Peak, Sweep time = auto couple.
 3. Trace mode = max hold, allow trace to fully stabilize.
 4. Use the peak marker function to determine the maximum amplitude level.
- Maximum (average) conducted output power was used to demonstrate compliance to the fundamental output power limit.
 1. Set the RBW = 30kHz, VBW = 100 kHz.
 2. Detector = RMS, Sweep time = auto couple.
 3. Set the sweep time to: $\geq 10 \times (\text{number of measurement points in sweep}) \times (\text{maximum data rate per stream})$.
 4. Perform the measurement over a single sweep.
 5. Use the peak marker function to determine the maximum amplitude level.

3.4.3 Test Setup

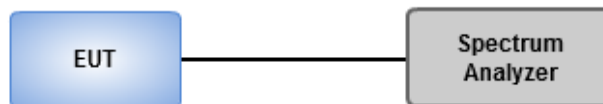

3.4.4 Test Result of Power Spectral Density

Condition			Peak Power Spectral Density (dBm)			
Mode	N _{TX}	Freq. (MHz)	PPSD w/o D.F (dBm)	Duty Factor (dB)	PPSD with D.F (dBm)	PPSD Limit (dBm)
11a	1	5745	-8.52	0.00	-8.52	8.00
11a	1	5785	-9.69	0.00	-9.69	8.00
11a	1	5825	-10.11	0.00	-10.11	8.00
VHT20	1	5745	-7.89	0.53	-7.36	8.00
VHT20	1	5785	-9.16	0.53	-8.63	8.00
VHT20	1	5825	-10.23	0.53	-9.70	8.00
VHT40	1	5755	-9.71	1.09	-8.62	8.00
VHT40	1	5795	-11.11	1.09	-10.02	8.00
VHT80	1	5775	-12.31	2.08	-10.23	8.00

Note: D.F is duty factor.

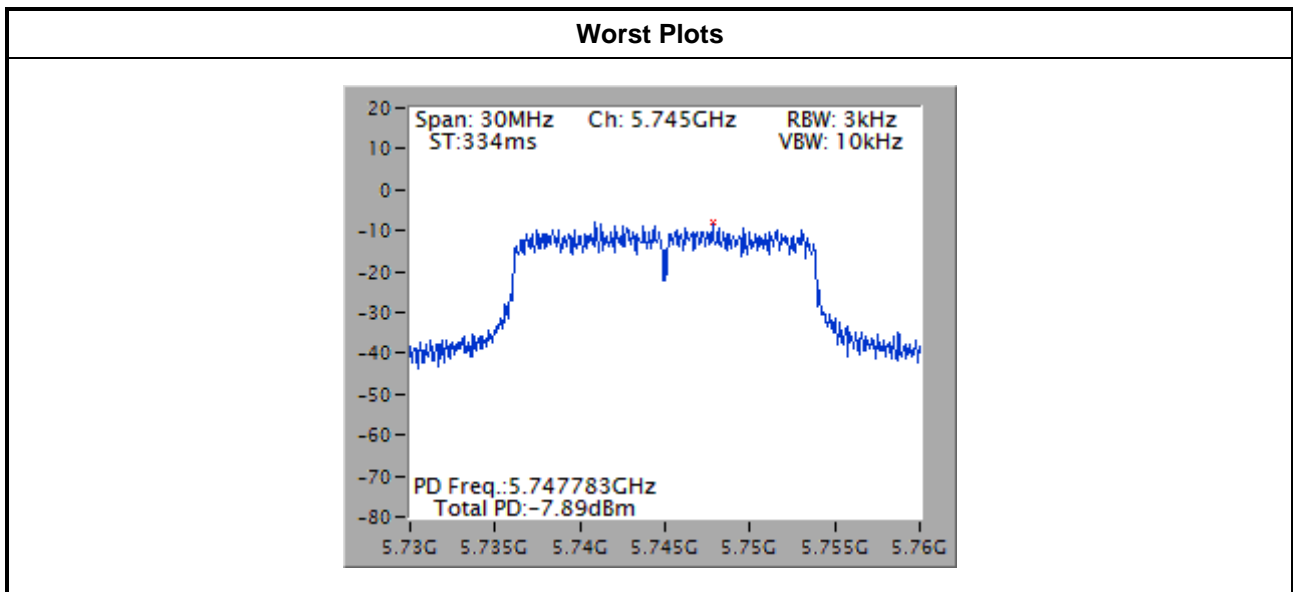

Note: Power density plot without duty factor

3.5 Unwanted Emissions into Restricted Frequency Bands

3.5.1 Limit of Unwanted Emissions into Restricted Frequency Bands

Restricted Band Emissions Limit			
Frequency Range (MHz)	Field Strength (uV/m)	Field Strength (dBuV/m)	Measure Distance (m)
0.009~0.490	2400/F(kHz)	48.5 - 13.8	300
0.490~1.705	24000/F(kHz)	33.8 - 23	30
1.705~30.0	30	29	30
30~88	100	40	3
88~216	150	43.5	3
216~960	200	46	3
Above 960	500	54	3

Note 1:
 Qusai-Peak value is measured for frequency below 1GHz except for 9–90 kHz, 110–490 kHz frequency band. Peak and average value are measured for frequency above 1GHz. The limit on average radio frequency emission is as above table. The limit on peak radio frequency emissions is 20 dB above the maximum permitted average emission limit

Note 2:
 Measurements may be performed at a distance other than what is specified provided. When performing measurements at a distance other than that specified, the results shall be extrapolated to the specified distance using an extrapolation factor as below, Frequency at or above 30 MHz: 20 dB/decade Frequency below 30 MHz: 40 dB/decade.

3.5.2 Test Procedures

1. Measurement is made at a semi-anechoic chamber that incorporates a turntable allowing a EUT rotation of 360°. A continuously-rotating, remotely-controlled turntable is installed at the test site to support the EUT and facilitate determination of the direction of maximum radiation for each EUT emission frequency. The EUT is placed at a height of 0.8 m test table above the ground plane.
2. Measurement is made with the antenna positioned in both the horizontal and vertical planes of polarization. The measurement antenna is varied in height (1m ~ 4m) above the reference ground plane to obtain the maximum signal strength. Distance between EUT and antenna is 3 m.
3. This investigation is performed with the EUT rotated 360°, the antenna height scanned between 1 m and 4 m, and the antenna rotated to repeat the measurements for both the horizontal and vertical antenna polarizations.

Note:

1. 120kHz measurement bandwidth of test receiver and Quasi-peak detector is for radiated emission below 1GHz.
2. RBW=1MHz, VBW=3MHz and Peak detector is for peak measured value of radiated emission above 1GHz.
3. RBW=1MHz, VBW=1/T and Peak detector is for average measured value of radiated emission above 1GHz.

3.5.3 Test Setup

Radiated Emissions below 1 GHz

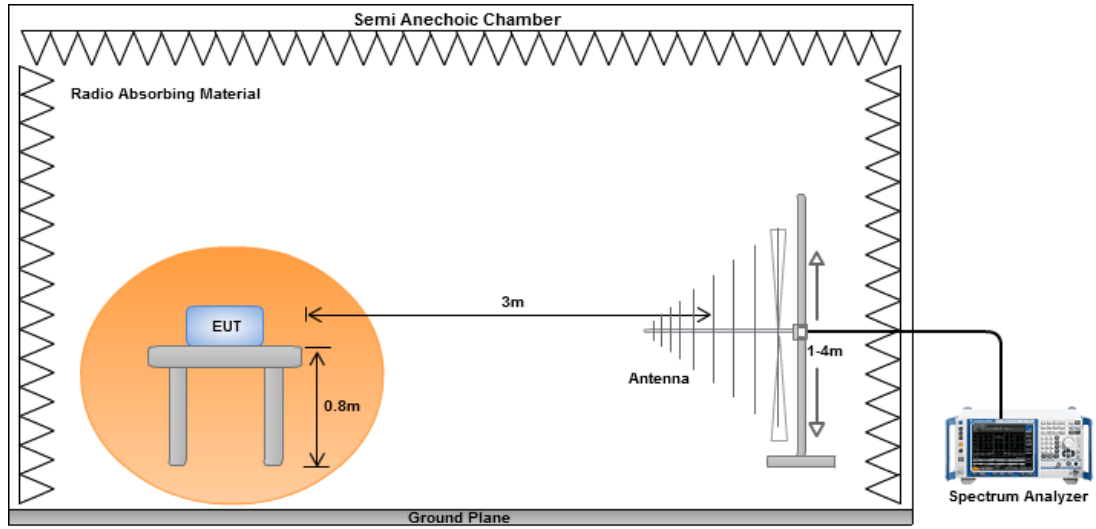

Radiated Emissions above 1 GHz

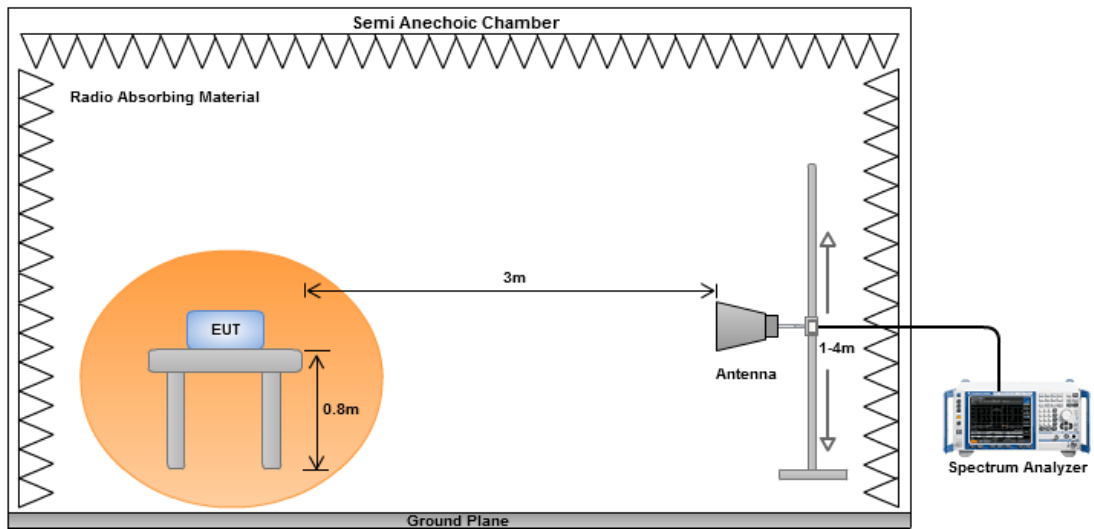

3.5.4 Transmitter Radiated Unwanted Emissions (Below 1GHz)

Modulation	VHT80	Test Freq. (MHz)	5775																																																																								
Polarization	Horizontal																																																																										
	<table border="1"> <thead> <tr> <th>Freq.</th> <th>Emission level</th> <th>Limit</th> <th>Margin</th> <th>SA reading</th> <th>Factor</th> <th>Remark</th> <th>ANT High cm</th> <th>Turn Table deg</th> </tr> <tr> <th>MHz</th> <th>dBuV/m</th> <th>dBuV/m</th> <th>dB</th> <th>dBuV</th> <th>dB</th> <th></th> <th></th> <th></th> </tr> </thead> <tbody> <tr> <td>1</td> <td>125.22</td> <td>31.12</td> <td>43.50</td> <td>-12.38</td> <td>49.78</td> <td>-18.66</td> <td>Peak</td> <td>---</td> </tr> <tr> <td>2</td> <td>375.43</td> <td>42.94</td> <td>46.00</td> <td>-3.06</td> <td>57.35</td> <td>-14.41</td> <td>Peak</td> <td>---</td> </tr> <tr> <td>3</td> <td>624.73</td> <td>41.74</td> <td>46.00</td> <td>-4.26</td> <td>51.05</td> <td>-9.31</td> <td>Peak</td> <td>---</td> </tr> <tr> <td>4</td> <td>700.25</td> <td>37.66</td> <td>46.00</td> <td>-8.34</td> <td>45.98</td> <td>-8.32</td> <td>Peak</td> <td>---</td> </tr> <tr> <td>5</td> <td>749.83</td> <td>33.48</td> <td>46.00</td> <td>-12.52</td> <td>40.89</td> <td>-7.41</td> <td>Peak</td> <td>---</td> </tr> <tr> <td>6</td> <td>874.76</td> <td>45.58</td> <td>46.00</td> <td>-0.42</td> <td>51.49</td> <td>-5.91</td> <td>QP</td> <td>---</td> </tr> </tbody> </table>	Freq.	Emission level	Limit	Margin	SA reading	Factor	Remark	ANT High cm	Turn Table deg	MHz	dBuV/m	dBuV/m	dB	dBuV	dB				1	125.22	31.12	43.50	-12.38	49.78	-18.66	Peak	---	2	375.43	42.94	46.00	-3.06	57.35	-14.41	Peak	---	3	624.73	41.74	46.00	-4.26	51.05	-9.31	Peak	---	4	700.25	37.66	46.00	-8.34	45.98	-8.32	Peak	---	5	749.83	33.48	46.00	-12.52	40.89	-7.41	Peak	---	6	874.76	45.58	46.00	-0.42	51.49	-5.91	QP	---		
Freq.	Emission level	Limit	Margin	SA reading	Factor	Remark	ANT High cm	Turn Table deg																																																																			
MHz	dBuV/m	dBuV/m	dB	dBuV	dB																																																																						
1	125.22	31.12	43.50	-12.38	49.78	-18.66	Peak	---																																																																			
2	375.43	42.94	46.00	-3.06	57.35	-14.41	Peak	---																																																																			
3	624.73	41.74	46.00	-4.26	51.05	-9.31	Peak	---																																																																			
4	700.25	37.66	46.00	-8.34	45.98	-8.32	Peak	---																																																																			
5	749.83	33.48	46.00	-12.52	40.89	-7.41	Peak	---																																																																			
6	874.76	45.58	46.00	-0.42	51.49	-5.91	QP	---																																																																			
<p>Note 1: Emission Level (dBuV/m) = SA Reading (dBuV/m) + Factor* (dB) *Factor includes antenna factor , cable loss and amplifier gain Note 2: Margin (dB) = Emission level (dBuV/m) – Limit (dBuV/m). Note 3: All spurious emissions below 30MHz are more than 20 dB below the limit.</p>																																																																											

Modulation	VHT80	Test Freq. (MHz)	5775
Polarization	Vertical		

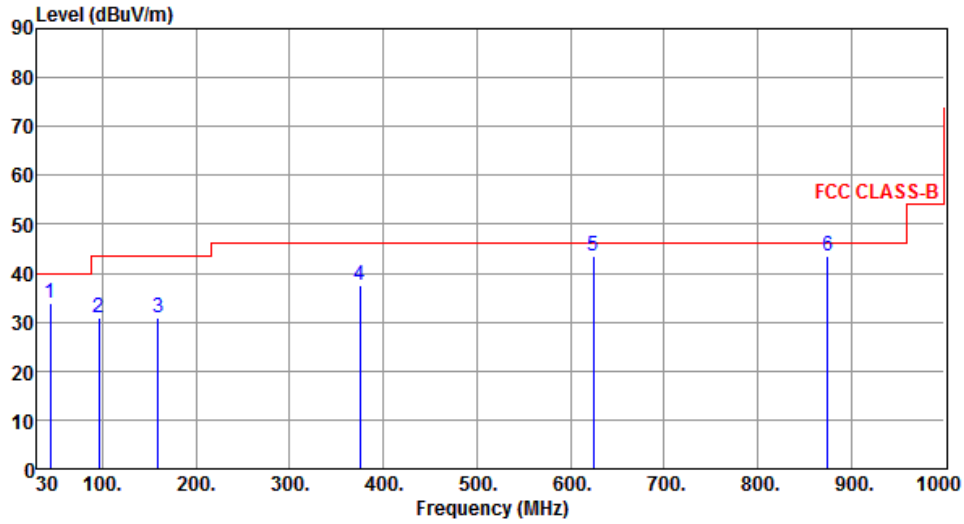

	Freq. MHz	Emission level dBuV/m	Limit dBuV/m	Margin dB	SA reading dBuV	Factor dB	Remark	ANT High cm	Turn Table deg
1	43.84	33.94	40.00	-6.06	50.71	-16.77	QP	---	---
2	95.89	30.89	43.50	-12.61	53.13	-22.24	Peak	---	---
3	159.12	30.76	43.50	-12.74	47.47	-16.71	Peak	---	---
4	375.45	37.55	46.00	-8.45	51.96	-14.41	Peak	---	---
5	624.65	43.43	46.00	-2.57	52.74	-9.31	QP	---	---
6	874.88	43.58	46.00	-2.42	49.49	-5.91	QP	---	---

Note 1: Emission Level (dBuV/m) = SA Reading (dBuV/m) + Factor* (dB)

*Factor includes antenna factor , cable loss and amplifier gain

Note 2: Margin (dB) = Emission level (dBuV/m) – Limit (dBuV/m).

Note 3: All spurious emissions below 30MHz are more than 20 dB below the limit.

3.5.5 Transmitter Radiated Unwanted Emissions (Above 1GHz) for 11a

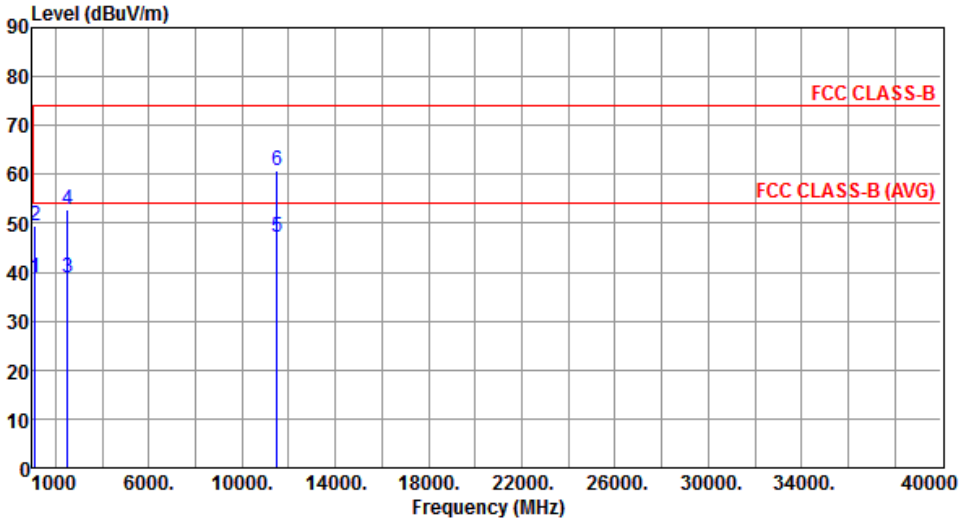
Modulation	11a	Test Freq. (MHz)	5745																																																																						
Polarization	Horizontal																																																																								
																																																																									
	<table border="1"> <thead> <tr> <th>Freq.</th> <th>Emission level</th> <th>Limit</th> <th>Margin</th> <th>SA reading</th> <th>Factor</th> <th>Remark</th> <th>ANT High</th> <th>Turn Table</th> </tr> <tr> <th>MHz</th> <th>dBuV/m</th> <th>dBuV/m</th> <th>dB</th> <th>dBuV</th> <th>dB</th> <th></th> <th>cm</th> <th>deg</th> </tr> </thead> <tbody> <tr> <td>1</td> <td>1125.00</td> <td>38.78</td> <td>54.00</td> <td>-15.22</td> <td>47.74</td> <td>-8.96</td> <td>Average</td> <td>---</td> </tr> <tr> <td>2</td> <td>1125.00</td> <td>49.56</td> <td>74.00</td> <td>-24.44</td> <td>58.52</td> <td>-8.96</td> <td>Peak</td> <td>---</td> </tr> <tr> <td>3</td> <td>2500.00</td> <td>39.00</td> <td>54.00</td> <td>-15.00</td> <td>41.31</td> <td>-2.31</td> <td>Average</td> <td>---</td> </tr> <tr> <td>4</td> <td>2500.00</td> <td>52.71</td> <td>74.00</td> <td>-21.29</td> <td>55.02</td> <td>-2.31</td> <td>Peak</td> <td>---</td> </tr> <tr> <td>5</td> <td>11490.00</td> <td>47.22</td> <td>54.00</td> <td>-6.78</td> <td>32.02</td> <td>15.20</td> <td>Average</td> <td>---</td> </tr> <tr> <td>6</td> <td>11490.00</td> <td>60.65</td> <td>74.00</td> <td>-13.35</td> <td>45.45</td> <td>15.20</td> <td>Peak</td> <td>---</td> </tr> </tbody> </table>	Freq.	Emission level	Limit	Margin	SA reading	Factor	Remark	ANT High	Turn Table	MHz	dBuV/m	dBuV/m	dB	dBuV	dB		cm	deg	1	1125.00	38.78	54.00	-15.22	47.74	-8.96	Average	---	2	1125.00	49.56	74.00	-24.44	58.52	-8.96	Peak	---	3	2500.00	39.00	54.00	-15.00	41.31	-2.31	Average	---	4	2500.00	52.71	74.00	-21.29	55.02	-2.31	Peak	---	5	11490.00	47.22	54.00	-6.78	32.02	15.20	Average	---	6	11490.00	60.65	74.00	-13.35	45.45	15.20	Peak	---
Freq.	Emission level	Limit	Margin	SA reading	Factor	Remark	ANT High	Turn Table																																																																	
MHz	dBuV/m	dBuV/m	dB	dBuV	dB		cm	deg																																																																	
1	1125.00	38.78	54.00	-15.22	47.74	-8.96	Average	---																																																																	
2	1125.00	49.56	74.00	-24.44	58.52	-8.96	Peak	---																																																																	
3	2500.00	39.00	54.00	-15.00	41.31	-2.31	Average	---																																																																	
4	2500.00	52.71	74.00	-21.29	55.02	-2.31	Peak	---																																																																	
5	11490.00	47.22	54.00	-6.78	32.02	15.20	Average	---																																																																	
6	11490.00	60.65	74.00	-13.35	45.45	15.20	Peak	---																																																																	
<p>Note 1: Emission Level (dBuV/m) = SA Reading (dBuV/m) + Factor* (dB) *Factor includes antenna factor , cable loss and amplifier gain Note 2: Margin (dB) = Emission level (dBuV/m) – Limit (dBuV/m).</p>																																																																									

Modulation	11a	Test Freq. (MHz)	5745
Polarization	Vertical		

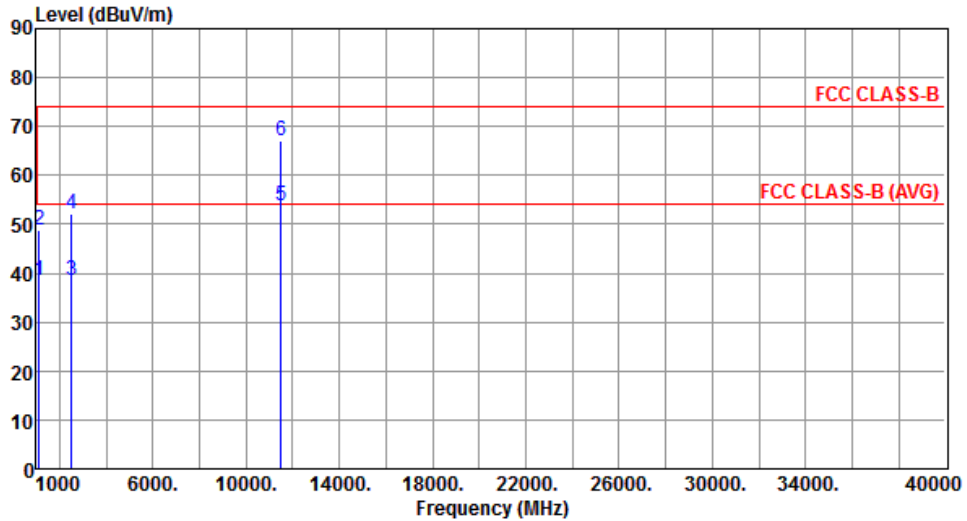

	Freq. MHz	Emission level dBuV/m	Limit dBuV/m	Margin dB	SA reading dBuV	Factor dB	Remark	ANT High cm	Turn Table deg
1	1125.00	38.38	54.00	-15.62	47.34	-8.96	Average	---	---
2	1125.00	48.88	74.00	-25.12	57.84	-8.96	Peak	---	---
3	2500.00	38.47	54.00	-15.53	40.78	-2.31	Average	---	---
4	2500.00	52.12	74.00	-21.88	54.43	-2.31	Peak	---	---
5	11490.00	53.89	54.00	-0.11	38.69	15.20	Average	---	---
6	11490.00	67.06	74.00	-6.94	51.86	15.20	Peak	---	---

Note 1: Emission Level (dBuV/m) = SA Reading (dBuV/m) + Factor* (dB)

*Factor includes antenna factor , cable loss and amplifier gain

Note 2: Margin (dB) = Emission level (dBuV/m) – Limit (dBuV/m).

Modulation	11a	Test Freq. (MHz)	5785
Polarization	Horizontal		

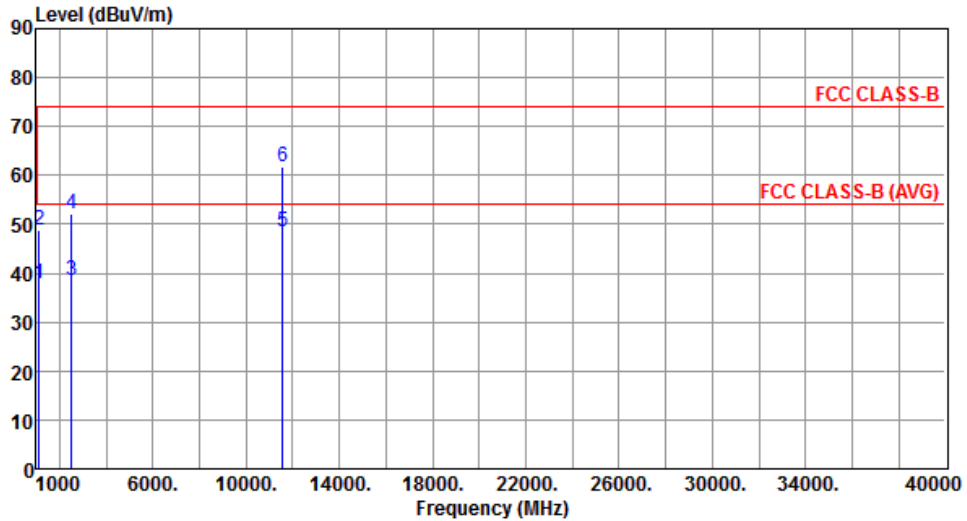

	Freq. MHz	Emission level dBuV/m	Limit dBuV/m	Margin dB	SA reading dBuV	Factor dB	Remark	ANT High cm	Turn Table deg
1	1125.00	37.85	54.00	-16.15	46.81	-8.96	Average	---	---
2	1125.00	48.97	74.00	-25.03	57.93	-8.96	Peak	---	---
3	2500.00	38.53	54.00	-15.47	40.84	-2.31	Average	---	---
4	2500.00	52.26	74.00	-21.74	54.57	-2.31	Peak	---	---
5	11570.00	48.63	54.00	-5.37	33.48	15.15	Average	---	---
6	11570.00	61.83	74.00	-12.17	46.68	15.15	Peak	---	---

Note 1: Emission Level (dBuV/m) = SA Reading (dBuV/m) + Factor* (dB)

*Factor includes antenna factor , cable loss and amplifier gain

Note 2: Margin (dB) = Emission level (dBuV/m) – Limit (dBuV/m).

Modulation	11a	Test Freq. (MHz)	5785
Polarization	Vertical		

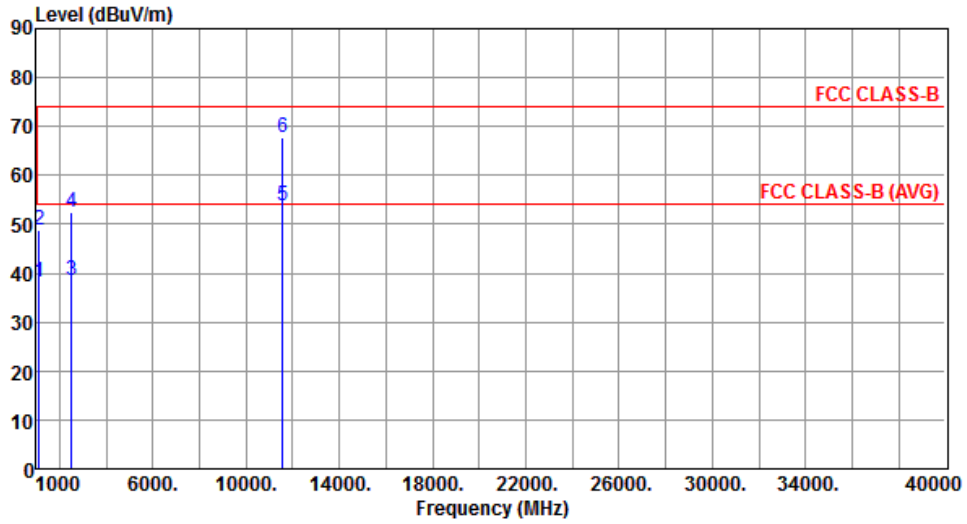

	Freq. MHz	Emission level dBuV/m	Limit dBuV/m	Margin dB	SA reading dBuV	Factor dB	Remark	ANT High cm	Turn Table deg
1	1125.00	38.29	54.00	-15.71	47.25	-8.96	Average	---	---
2	1125.00	48.86	74.00	-25.14	57.82	-8.96	Peak	---	---
3	2500.00	38.55	54.00	-15.45	40.86	-2.31	Average	---	---
4	2500.00	52.50	74.00	-21.50	54.81	-2.31	Peak	---	---
5	11570.00	53.86	54.00	-0.14	38.71	15.15	Average	---	---
6	11570.00	67.66	74.00	-6.34	52.51	15.15	Peak	---	---

Note 1: Emission Level (dBuV/m) = SA Reading (dBuV/m) + Factor* (dB)

*Factor includes antenna factor , cable loss and amplifier gain

Note 2: Margin (dB) = Emission level (dBuV/m) – Limit (dBuV/m).

Modulation	11a	Test Freq. (MHz)	5825
Polarization	Horizontal		

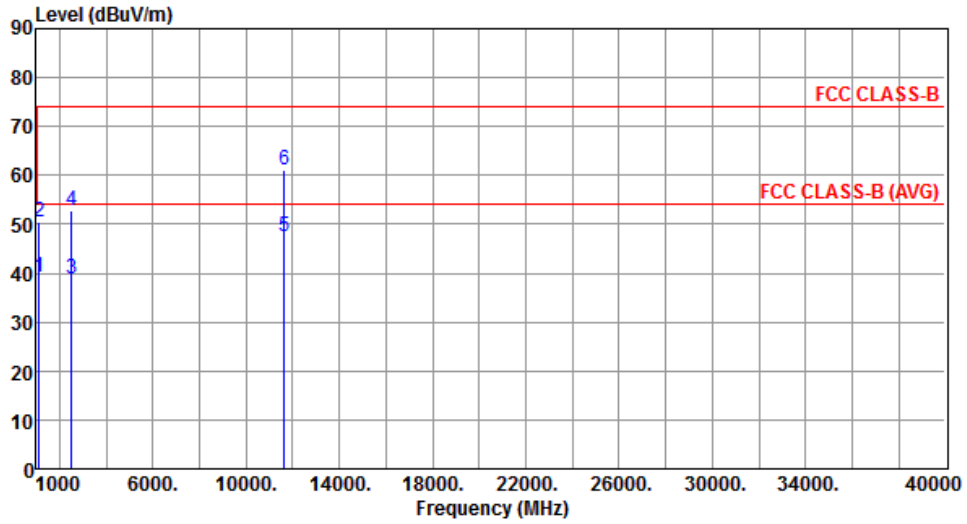

	Freq. MHz	Emission level dBuV/m	Limit dBuV/m	Margin dB	SA reading dBuV	Factor dB	Remark	ANT High cm	Turn Table deg
1	1125.00	39.05	54.00	-14.95	48.01	-8.96	Average	---	---
2	1125.00	50.42	74.00	-23.58	59.38	-8.96	Peak	---	---
3	2500.00	38.79	54.00	-15.21	41.10	-2.31	Average	---	---
4	2500.00	52.68	74.00	-21.32	54.99	-2.31	Peak	---	---
5	11650.00	47.58	54.00	-6.42	32.47	15.11	Average	---	---
6	11650.00	61.19	74.00	-12.81	46.08	15.11	Peak	---	---

Note 1: Emission Level (dBuV/m) = SA Reading (dBuV/m) + Factor* (dB)

*Factor includes antenna factor , cable loss and amplifier gain

Note 2: Margin (dB) = Emission level (dBuV/m) – Limit (dBuV/m).

Modulation	11a	Test Freq. (MHz)	5825
Polarization	Vertical		

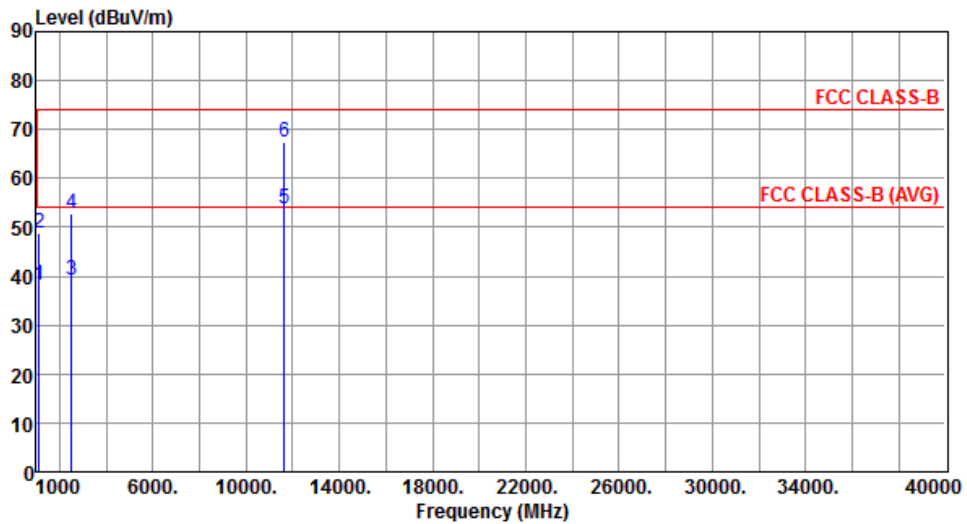

	Freq. MHz	Emission level dBuV/m	Limit dBuV/m	Margin dB	SA reading dBuV	Factor dB	Remark	ANT High cm	Turn Table deg
1	1125.00	38.20	54.00	-15.80	47.16	-8.96	Average	---	---
2	1125.00	48.83	74.00	-25.17	57.79	-8.96	Peak	---	---
3	2500.00	39.13	54.00	-14.87	41.44	-2.31	Average	---	---
4	2500.00	52.78	74.00	-21.22	55.09	-2.31	Peak	---	---
5	11650.00	53.83	54.00	-0.17	38.72	15.11	Average	---	---
6	11650.00	67.50	74.00	-6.50	52.39	15.11	Peak	---	---

Note 1: Emission Level (dBuV/m) = SA Reading (dBuV/m) + Factor* (dB)

*Factor includes antenna factor , cable loss and amplifier gain

Note 2: Margin (dB) = Emission level (dBuV/m) – Limit (dBuV/m).

3.5.6 Transmitter Radiated Unwanted Emissions (Above 1GHz) for VHT20

Modulation	VHT20	Test Freq. (MHz)	5745						
Polarization	Horizontal								
	Freq.	Emission level	Limit	Margin	SA reading	Factor	Remark	ANT High	Turn Table
	MHz	dBuV/m	dBuV/m	dB	dBuV	dB		cm	deg
1	1125.00	38.48	54.00	-15.52	47.44	-8.96	Average	---	---
2	1125.00	49.04	74.00	-24.96	58.00	-8.96	Peak	---	---
3	2500.00	38.92	54.00	-15.08	41.23	-2.31	Average	---	---
4	2500.00	52.50	74.00	-21.50	54.81	-2.31	Peak	---	---
5	11490.00	46.86	54.00	-7.14	31.66	15.20	Average	---	---
6	11490.00	60.36	74.00	-13.64	45.16	15.20	Peak	---	---
<p>Note 1: Emission Level (dBuV/m) = SA Reading (dBuV/m) + Factor* (dB) *Factor includes antenna factor , cable loss and amplifier gain Note 2: Margin (dB) = Emission level (dBuV/m) – Limit (dBuV/m).</p>									

Modulation	VHT20	Test Freq. (MHz)	5745
Polarization	Vertical		

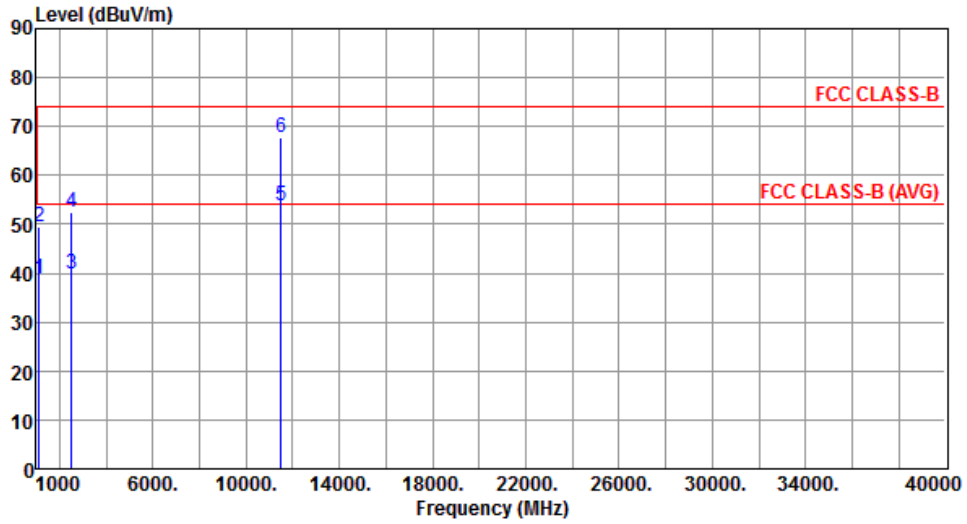

	Freq. MHz	Emission level dBuV/m	Limit dBuV/m	Margin dB	SA reading dBuV	Factor dB	Remark	ANT High cm	Turn Table deg
1	1125.00	38.98	54.00	-15.02	47.94	-8.96	Average	---	---
2	1125.00	49.54	74.00	-24.46	58.50	-8.96	Peak	---	---
3	2500.00	39.91	54.00	-14.09	42.22	-2.31	Average	---	---
4	2500.00	52.62	74.00	-21.38	54.93	-2.31	Peak	---	---
5	11490.00	53.71	54.00	-0.29	38.51	15.20	Average	---	---
6	11490.00	67.73	74.00	-6.27	52.53	15.20	Peak	---	---

Note 1: Emission Level (dBuV/m) = SA Reading (dBuV/m) + Factor* (dB)

*Factor includes antenna factor , cable loss and amplifier gain

Note 2: Margin (dB) = Emission level (dBuV/m) – Limit (dBuV/m).

Modulation	VHT20	Test Freq. (MHz)	5785
Polarization	Horizontal		

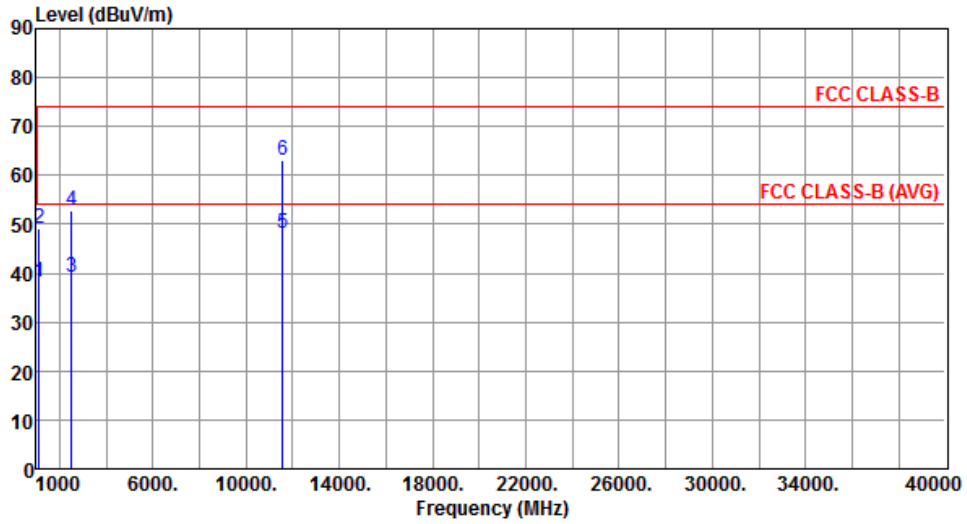

	Freq. MHz	Emission level dBuV/m	Limit dBuV/m	Margin dB	SA reading dBuV	Factor dB	Remark	ANT High cm	Turn Table deg
1	1125.00	38.06	54.00	-15.94	47.02	-8.96	Average	---	---
2	1125.00	49.07	74.00	-24.93	58.03	-8.96	Peak	---	---
3	2500.00	39.06	54.00	-14.94	41.37	-2.31	Average	---	---
4	2500.00	52.92	74.00	-21.08	55.23	-2.31	Peak	---	---
5	11570.00	48.00	54.00	-6.00	32.85	15.15	Average	---	---
6	11570.00	63.25	74.00	-10.75	48.10	15.15	Peak	---	---

Note 1: Emission Level (dBuV/m) = SA Reading (dBuV/m) + Factor* (dB)

*Factor includes antenna factor , cable loss and amplifier gain

Note 2: Margin (dB) = Emission level (dBuV/m) – Limit (dBuV/m).

Modulation	VHT20	Test Freq. (MHz)	5785
Polarization	Vertical		

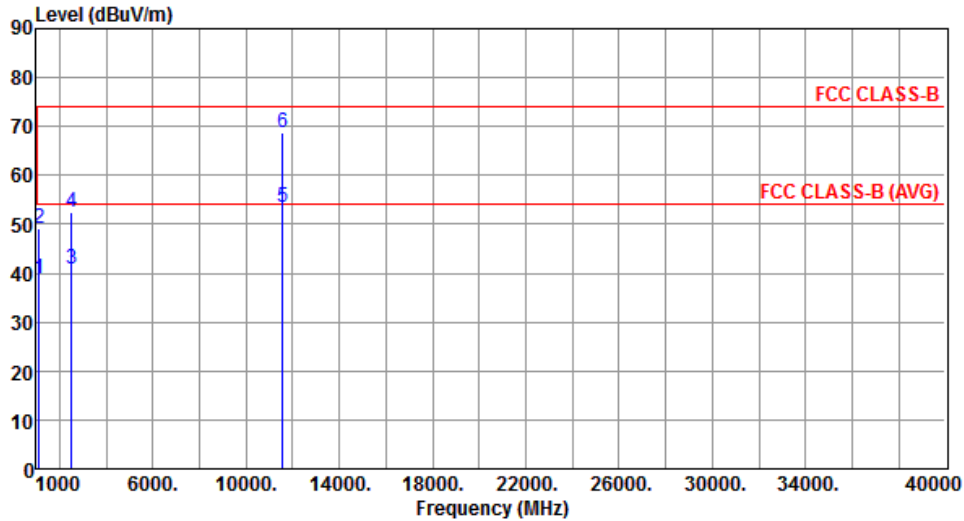

	Freq. MHz	Emission level dBuV/m	Limit dBuV/m	Margin dB	SA reading dBuV	Factor dB	Remark	ANT High cm	Turn Table deg
1	1125.00	38.83	54.00	-15.17	47.79	-8.96	Average	---	---
2	1125.00	49.29	74.00	-24.71	58.25	-8.96	Peak	---	---
3	2500.00	40.82	54.00	-13.18	43.13	-2.31	Average	---	---
4	2500.00	52.36	74.00	-21.64	54.67	-2.31	Peak	---	---
5	11570.00	53.61	54.00	-0.39	38.46	15.15	Average	---	---
6	11570.00	68.70	74.00	-5.30	53.55	15.15	Peak	---	---

Note 1: Emission Level (dBuV/m) = SA Reading (dBuV/m) + Factor* (dB)

*Factor includes antenna factor , cable loss and amplifier gain

Note 2: Margin (dB) = Emission level (dBuV/m) – Limit (dBuV/m).

Modulation	VHT20	Test Freq. (MHz)	5825
Polarization	Horizontal		

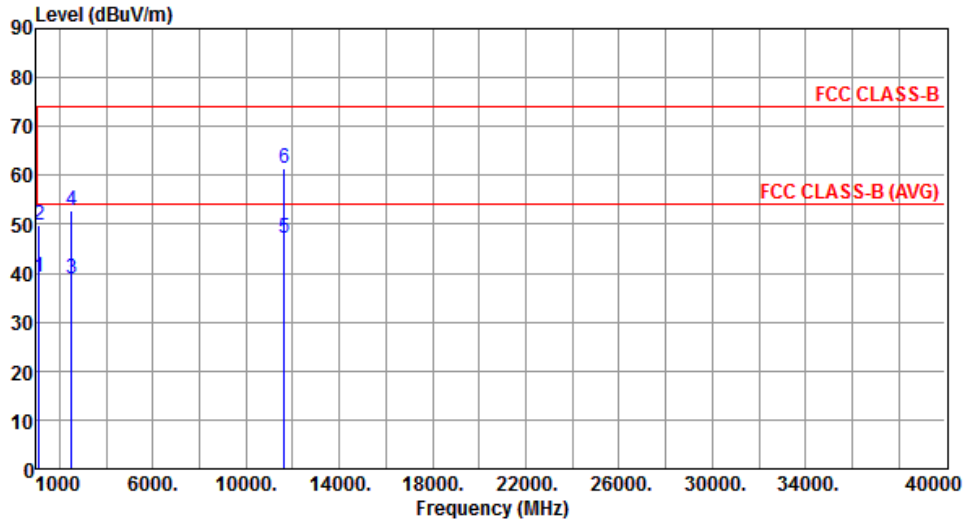

	Freq. MHz	Emission level dBuV/m	Limit dBuV/m	Margin dB	SA reading dBuV	Factor dB	Remark	ANT High cm	Turn Table deg
1	1125.00	39.17	54.00	-14.83	48.13	-8.96	Average	---	---
2	1125.00	49.81	74.00	-24.19	58.77	-8.96	Peak	---	---
3	2500.00	38.99	54.00	-15.01	41.30	-2.31	Average	---	---
4	2500.00	52.88	74.00	-21.12	55.19	-2.31	Peak	---	---
5	11650.00	47.06	54.00	-6.94	31.95	15.11	Average	---	---
6	11650.00	61.40	74.00	-12.60	46.29	15.11	Peak	---	---

Note 1: Emission Level (dBuV/m) = SA Reading (dBuV/m) + Factor* (dB)

*Factor includes antenna factor , cable loss and amplifier gain

Note 2: Margin (dB) = Emission level (dBuV/m) – Limit (dBuV/m).

Modulation	VHT20	Test Freq. (MHz)	5825
Polarization	Vertical		

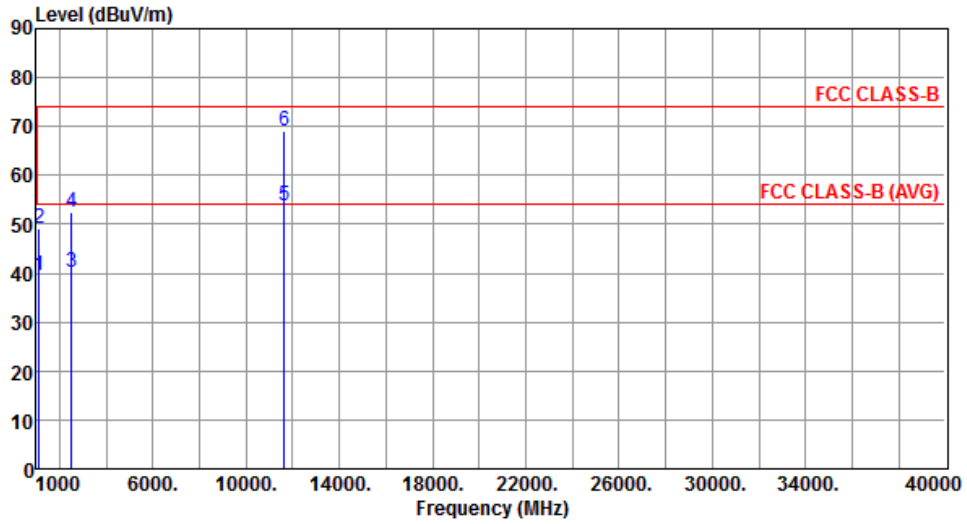

	Freq. MHz	Emission level dBuV/m	Limit dBuV/m	Margin dB	SA reading dBuV	Factor dB	Remark	ANT High cm	Turn Table deg
1	1125.00	39.58	54.00	-14.42	48.54	-8.96	Average	---	---
2	1125.00	49.25	74.00	-24.75	58.21	-8.96	Peak	---	---
3	2500.00	40.16	54.00	-13.84	42.47	-2.31	Average	---	---
4	2500.00	52.33	74.00	-21.67	54.64	-2.31	Peak	---	---
5	11650.00	53.89	54.00	-0.11	38.78	15.11	Average	---	---
6	11650.00	68.93	74.00	-5.07	53.82	15.11	Peak	---	---

Note 1: Emission Level (dBuV/m) = SA Reading (dBuV/m) + Factor* (dB)

*Factor includes antenna factor , cable loss and amplifier gain

Note 2: Margin (dB) = Emission level (dBuV/m) – Limit (dBuV/m).

3.5.7 Transmitter Radiated Unwanted Emissions (Above 1GHz) for VHT40

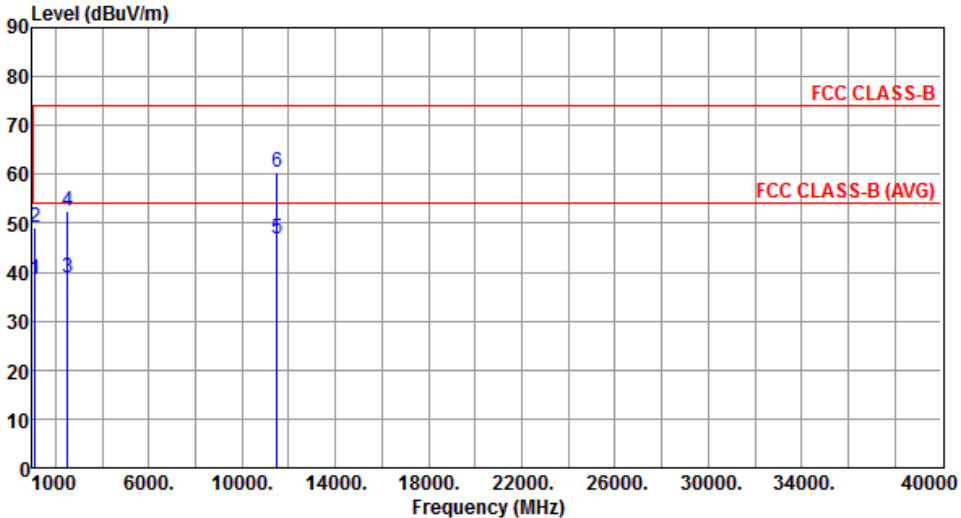
Modulation	VHT40	Test Freq. (MHz)	5755						
Polarization	Horizontal								
									
	Freq.	Emission level	Limit	Margin	SA reading	Factor	Remark	ANT High	Turn Table
	MHz	dBuV/m	dBuV/m	dB	dBuV	dB		cm	deg
1	1125.00	38.48	54.00	-15.52	47.44	-8.96	Average	---	---
2	1125.00	49.04	74.00	-24.96	58.00	-8.96	Peak	---	---
3	2500.00	38.92	54.00	-15.08	41.23	-2.31	Average	---	---
4	2500.00	52.50	74.00	-21.50	54.81	-2.31	Peak	---	---
5	11510.00	46.86	54.00	-7.14	31.68	15.18	Average	---	---
6	11510.00	60.36	74.00	-13.64	45.18	15.18	Peak	---	---
<p>Note 1: Emission Level (dBuV/m) = SA Reading (dBuV/m) + Factor* (dB) *Factor includes antenna factor , cable loss and amplifier gain Note 2: Margin (dB) = Emission level (dBuV/m) – Limit (dBuV/m).</p>									

Modulation	VHT40	Test Freq. (MHz)	5755
Polarization	Vertical		

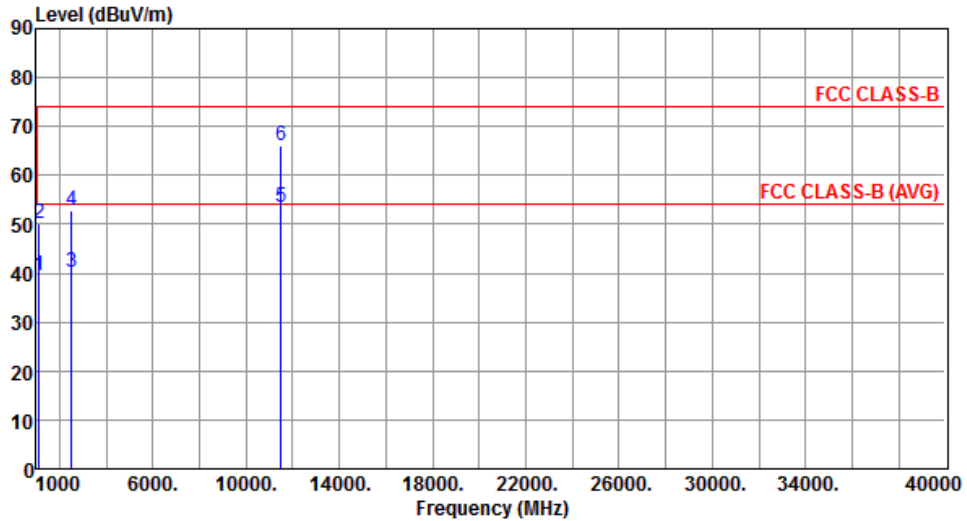

	Freq. MHz	Emission level dBuV/m	Limit dBuV/m	Margin dB	SA reading dBuV	Factor dB	Remark	ANT High cm	Turn Table deg
1	1125.00	39.43	54.00	-14.57	48.39	-8.96	Average	---	---
2	1125.00	50.12	74.00	-23.88	59.08	-8.96	Peak	---	---
3	2500.00	40.33	54.00	-13.67	42.64	-2.31	Average	---	---
4	2500.00	52.78	74.00	-21.22	55.09	-2.31	Peak	---	---
5	11510.00	53.51	54.00	-0.49	38.33	15.18	Average	---	---
6	11510.00	66.05	74.00	-7.95	50.87	15.18	Peak	---	---

Note 1: Emission Level (dBuV/m) = SA Reading (dBuV/m) + Factor* (dB)

*Factor includes antenna factor , cable loss and amplifier gain

Note 2: Margin (dB) = Emission level (dBuV/m) – Limit (dBuV/m).

Modulation	VHT40	Test Freq. (MHz)	5795
Polarization	Horizontal		

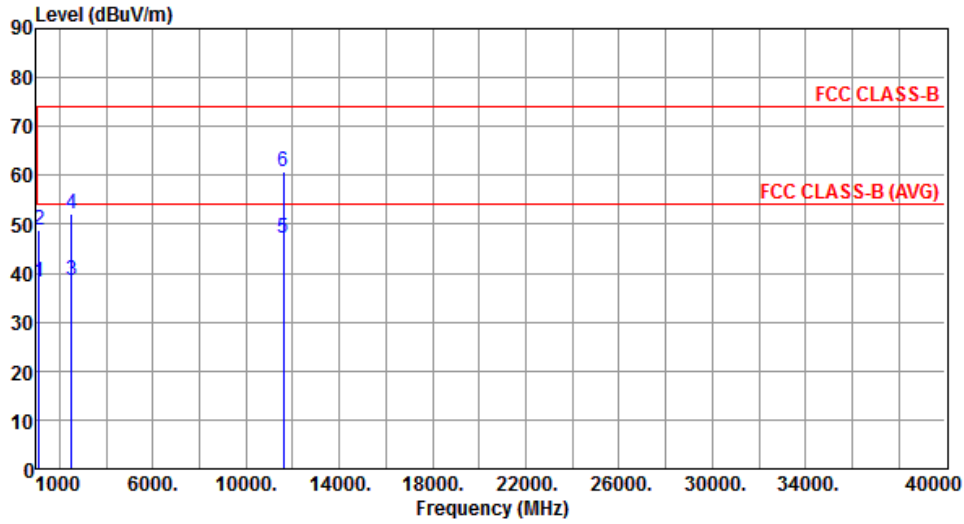

	Freq. MHz	Emission level dBuV/m	Limit dBuV/m	Margin dB	SA reading dBuV	Factor dB	Remark	ANT High cm	Turn Table deg
1	1125.00	38.19	54.00	-15.81	47.15	-8.96	Average	---	---
2	1125.00	48.73	74.00	-25.27	57.69	-8.96	Peak	---	---
3	2500.00	38.45	54.00	-15.55	40.76	-2.31	Average	---	---
4	2500.00	52.23	74.00	-21.77	54.54	-2.31	Peak	---	---
5	11590.00	47.12	54.00	-6.88	31.98	15.14	Average	---	---
6	11590.00	60.73	74.00	-13.27	45.59	15.14	Peak	---	---

Note 1: Emission Level (dBuV/m) = SA Reading (dBuV/m) + Factor* (dB)

*Factor includes antenna factor , cable loss and amplifier gain

Note 2: Margin (dB) = Emission level (dBuV/m) – Limit (dBuV/m).

Modulation	VHT40	Test Freq. (MHz)	5795
Polarization	Vertical		

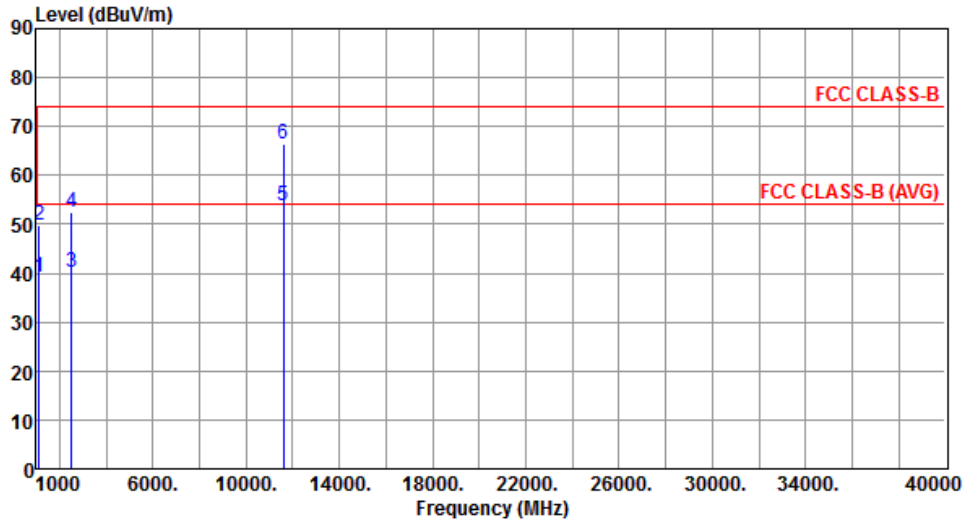

	Freq. MHz	Emission level dBuV/m	Limit dBuV/m	Margin dB	SA reading dBuV	Factor dB	Remark	ANT High cm	Turn Table deg
1	1125.00	39.12	54.00	-14.88	48.08	-8.96	Average	---	---
2	1125.00	49.87	74.00	-24.13	58.83	-8.96	Peak	---	---
3	2500.00	40.08	54.00	-13.92	42.39	-2.31	Average	---	---
4	2500.00	52.46	74.00	-21.54	54.77	-2.31	Peak	---	---
5	11590.00	53.68	54.00	-0.32	38.54	15.14	Average	---	---
6	11590.00	66.40	74.00	-7.60	51.26	15.14	Peak	---	---

Note 1: Emission Level (dBuV/m) = SA Reading (dBuV/m) + Factor* (dB)

*Factor includes antenna factor , cable loss and amplifier gain

Note 2: Margin (dB) = Emission level (dBuV/m) – Limit (dBuV/m).

3.5.8 Transmitter Radiated Unwanted Emissions (Above 1GHz) for VHT80

Modulation	VHT80	Test Freq. (MHz)	5775						
Polarization	Horizontal								
	Freq.	Emission level	Limit	Margin	SA reading	Factor	Remark	ANT High	Turn Table
	MHz	dBuV/m	dBuV/m	dB	dBuV	dB		cm	deg
1	1125.00	38.94	54.00	-15.06	47.90	-8.96	Average	---	---
2	1125.00	49.52	74.00	-24.48	58.48	-8.96	Peak	---	---
3	2500.00	39.36	54.00	-14.64	41.67	-2.31	Average	---	---
4	2500.00	52.82	74.00	-21.18	55.13	-2.31	Peak	---	---
5	11550.00	45.84	54.00	-8.16	30.68	15.16	Average	---	---
6	11550.00	55.81	74.00	-18.19	40.65	15.16	Peak	---	---
<p>Note 1: Emission Level (dBuV/m) = SA Reading (dBuV/m) + Factor* (dB) *Factor includes antenna factor , cable loss and amplifier gain Note 2: Margin (dB) = Emission level (dBuV/m) – Limit (dBuV/m).</p>									

Modulation	VHT80	Test Freq. (MHz)	5775
Polarization	Vertical		

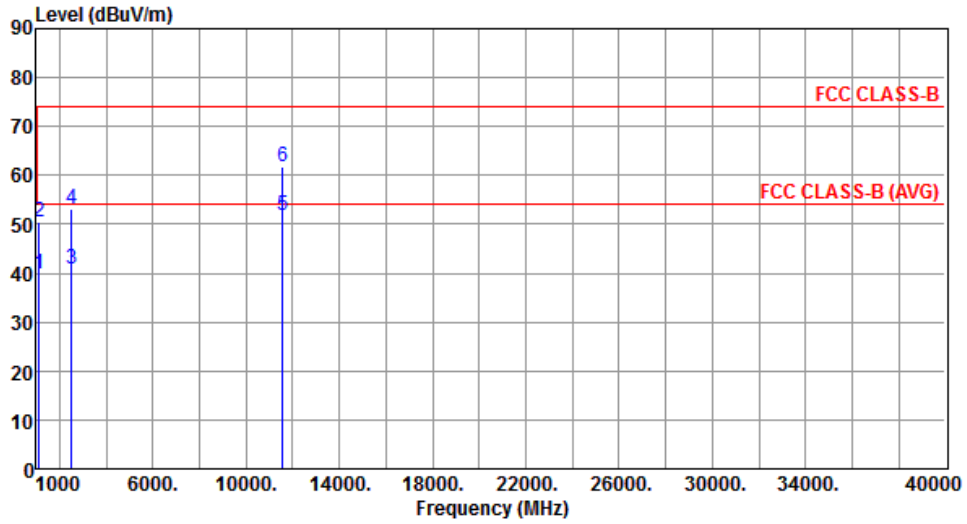

	Freq. MHz	Emission level dBuV/m	Limit dBuV/m	Margin dB	SA reading dBuV	Factor dB	Remark	ANT High cm	Turn Table deg
1	1125.00	39.88	54.00	-14.12	48.84	-8.96	Average	---	---
2	1125.00	50.54	74.00	-23.46	59.50	-8.96	Peak	---	---
3	2500.00	40.82	54.00	-13.18	43.13	-2.31	Average	---	---
4	2500.00	53.17	74.00	-20.83	55.48	-2.31	Peak	---	---
5	11550.00	51.83	54.00	-2.17	36.67	15.16	Average	---	---
6	11550.00	61.92	74.00	-12.08	46.76	15.16	Peak	---	---

Note 1: Emission Level (dBuV/m) = SA Reading (dBuV/m) + Factor* (dB)

*Factor includes antenna factor , cable loss and amplifier gain

Note 2: Margin (dB) = Emission level (dBuV/m) – Limit (dBuV/m).

3.6 Unwanted Emissions into Non-Restricted Frequency Bands

3.6.1 Limit of Unwanted Emissions into Non-Restricted Frequency Bands

The peak output power measured in any 100 kHz bandwidth outside of the authorized frequency band shall be attenuated by at least 20 dB relative to the maximum in-band peak PSD level in 100 kHz.

3.6.2 Test Procedures

Reference Level Measurement

1. Set the RBW = 100 kHz, VBW = 300 kHz, Detector = peak.
2. Set Sweep time = auto couple, Trace mode = max hold.
3. Allow trace to fully stabilize.
4. Use the peak marker function to determine the maximum amplitude level.

Unwanted Emissions Level Measurement

1. Set RBW = 100 kHz, VBW = 300 kHz, Detector = peak.
2. Trace Mode = max hold, Sweep = auto couple.
3. Allow the trace to stabilize.
4. Use peak marker function to determine maximum amplitude of all unwanted emissions within any 100 kHz bandwidth.

3.6.3 Test Setup

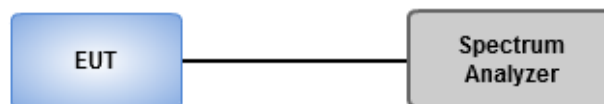

3.6.4 Unwanted Emissions into Non-Restricted Frequency Bands

802.11a

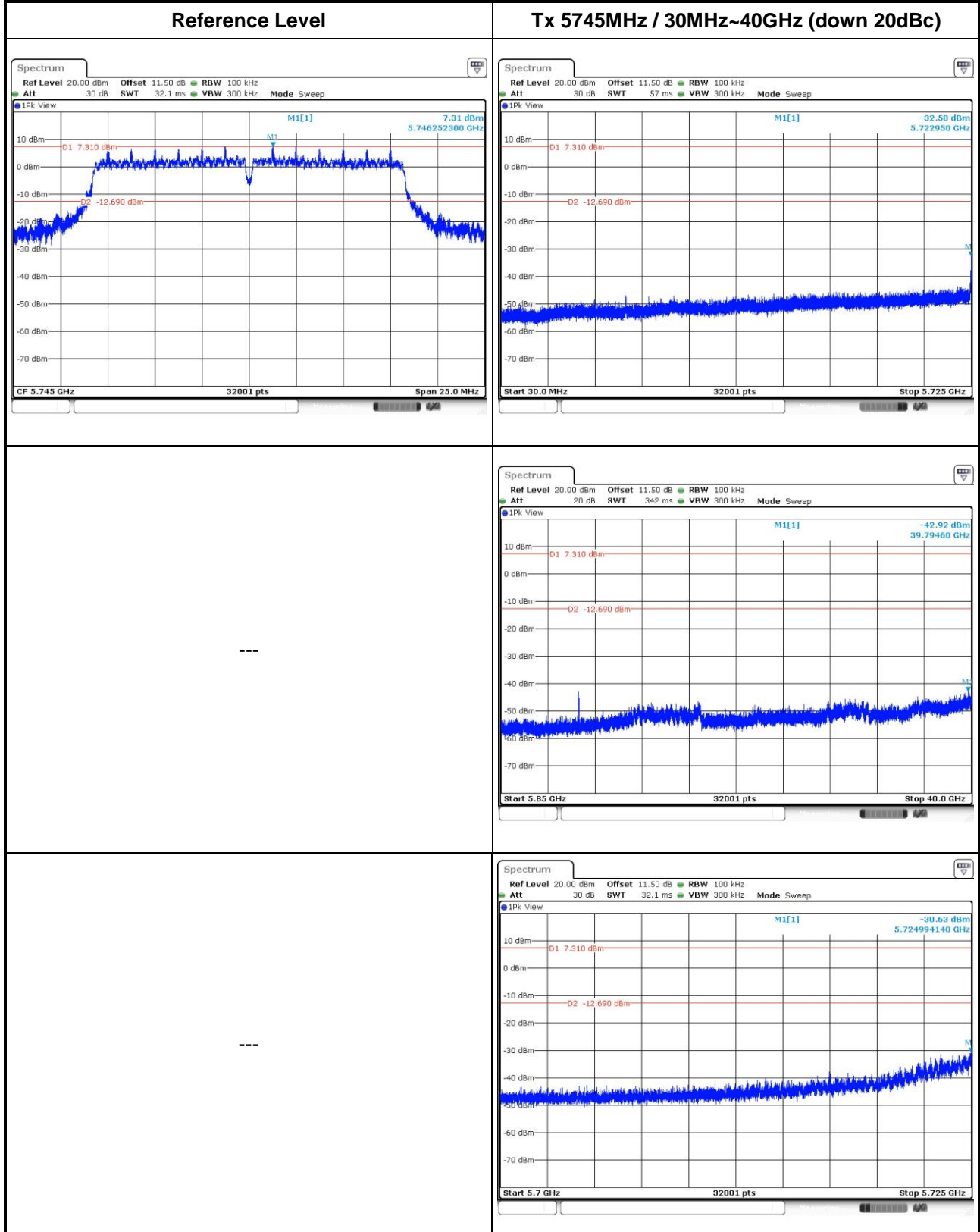

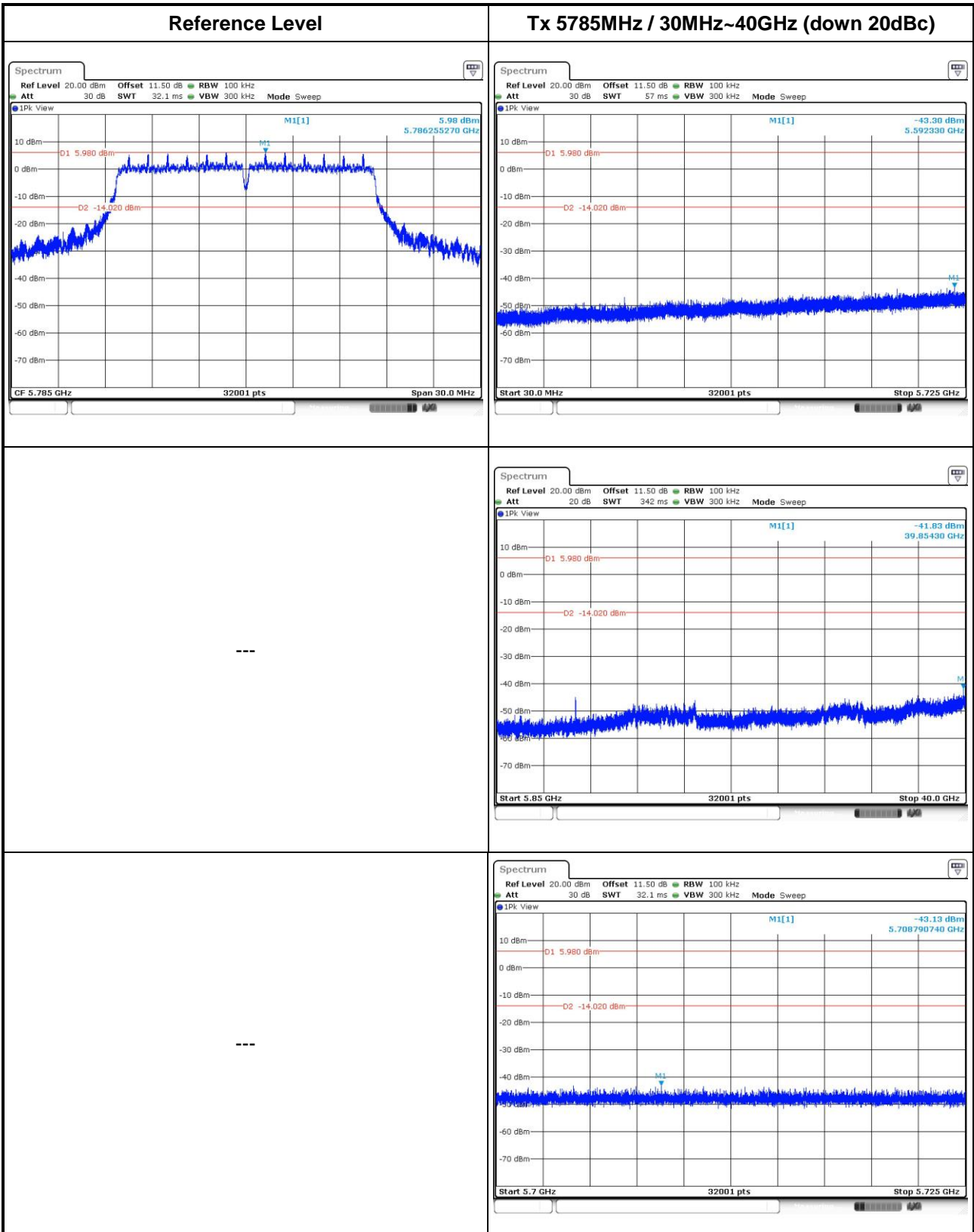

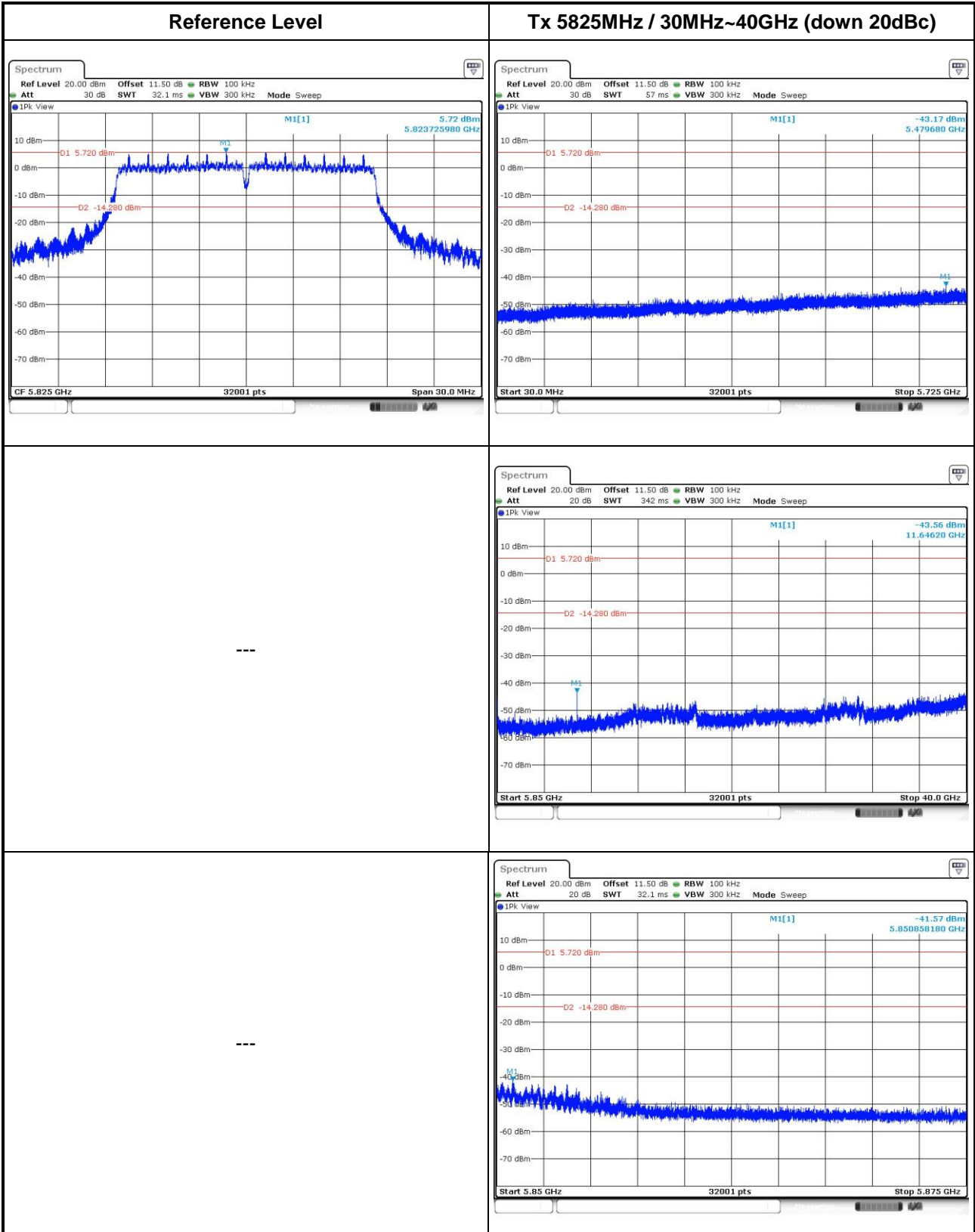

802.11n VHT20

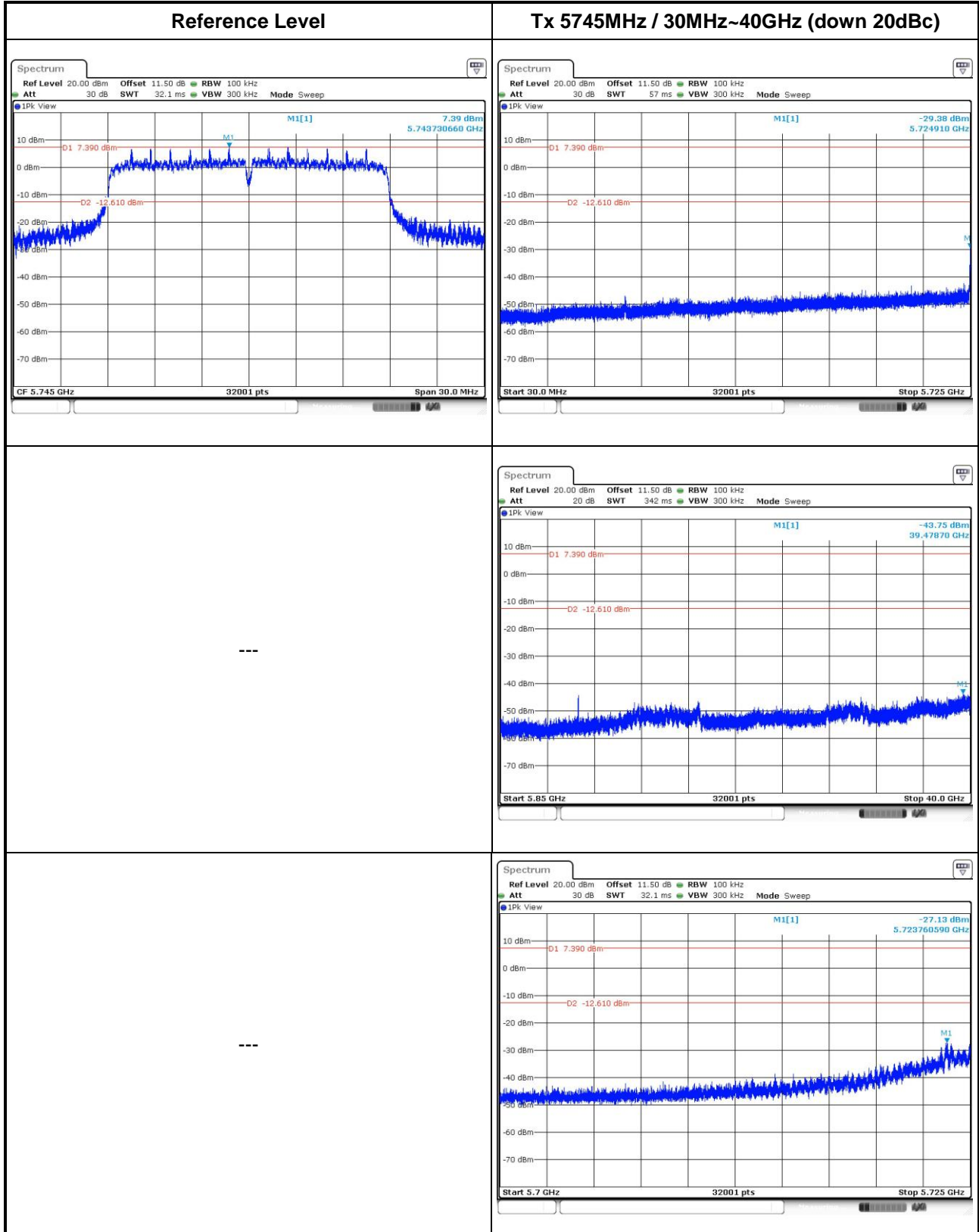

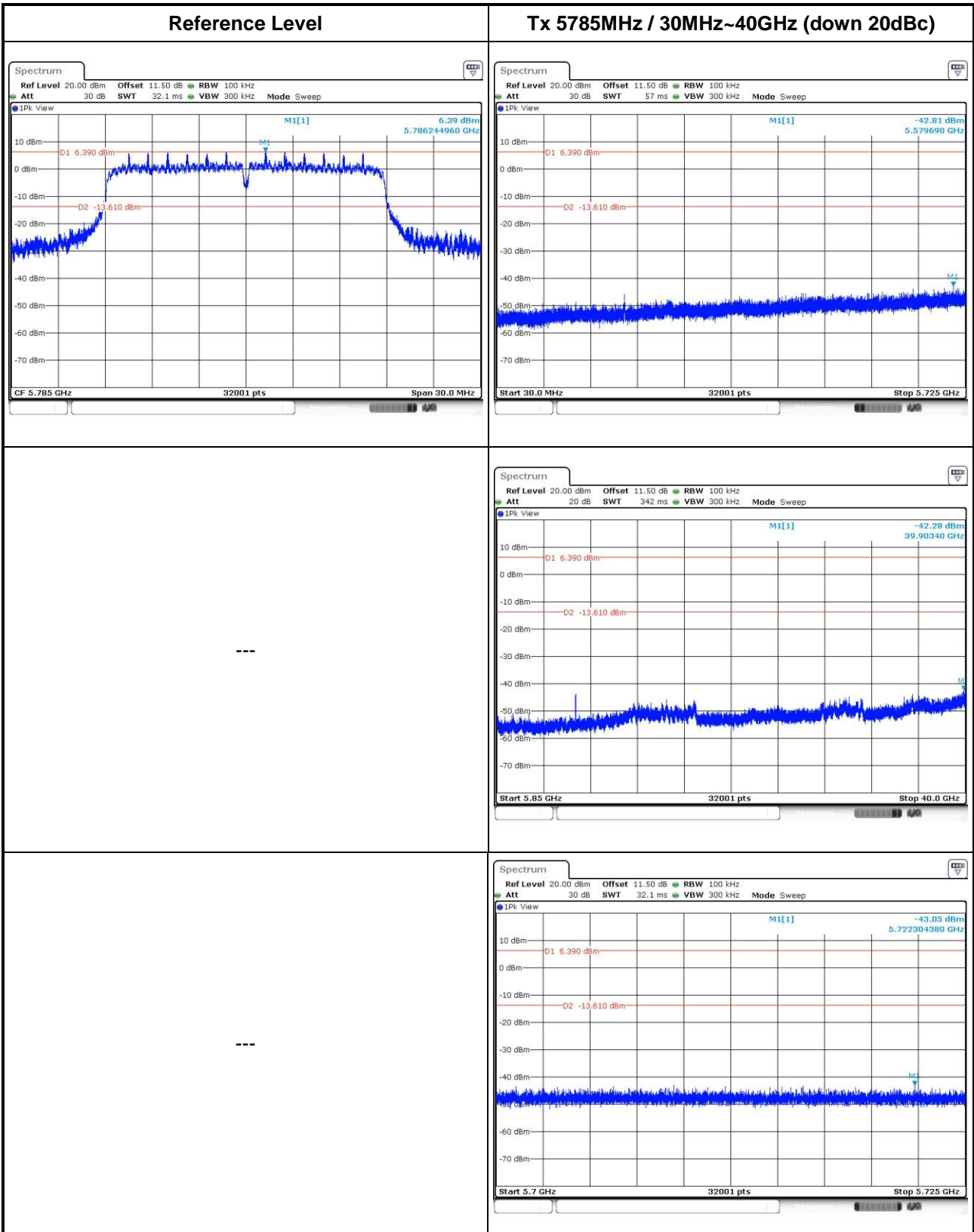

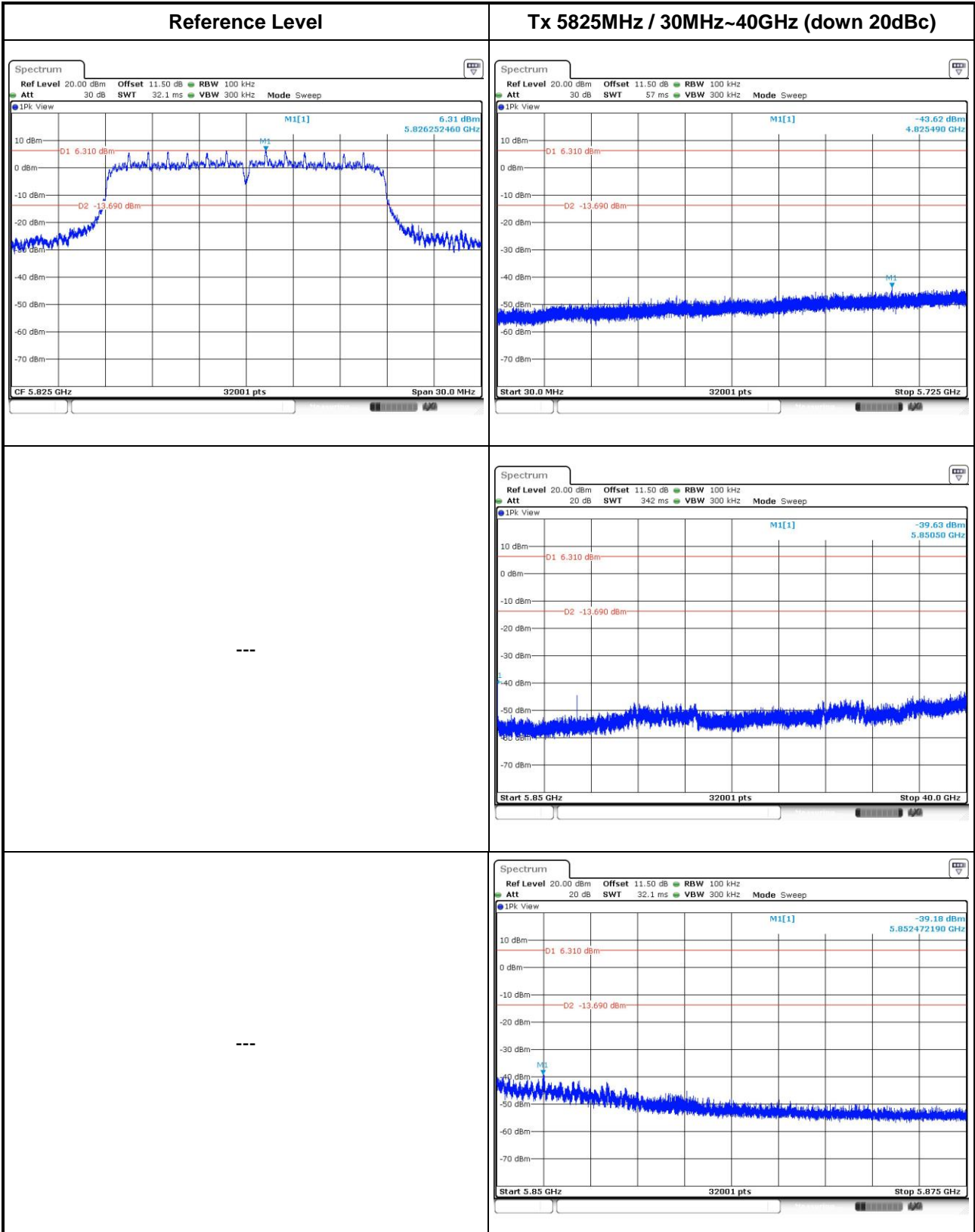

802.11n VHT40

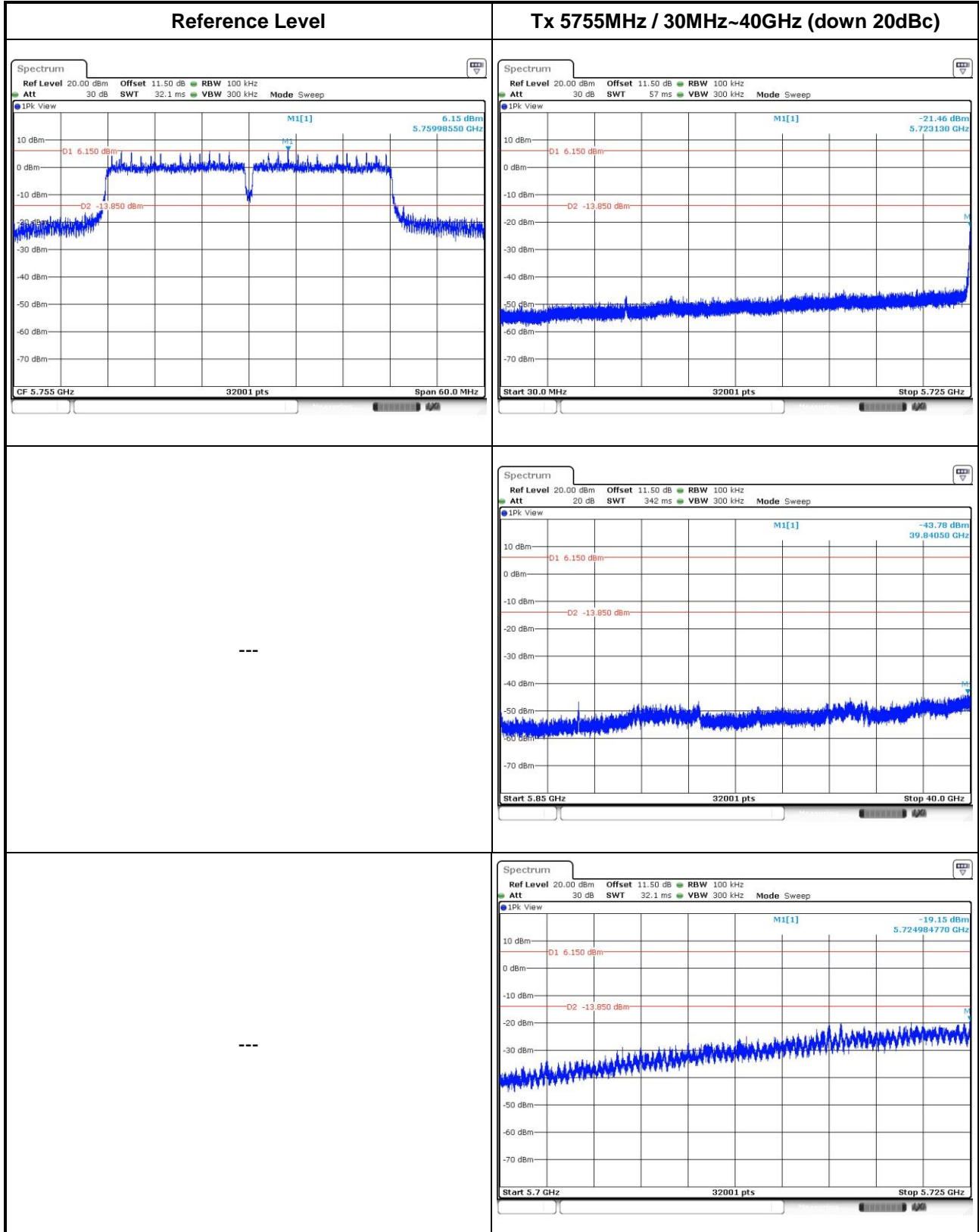

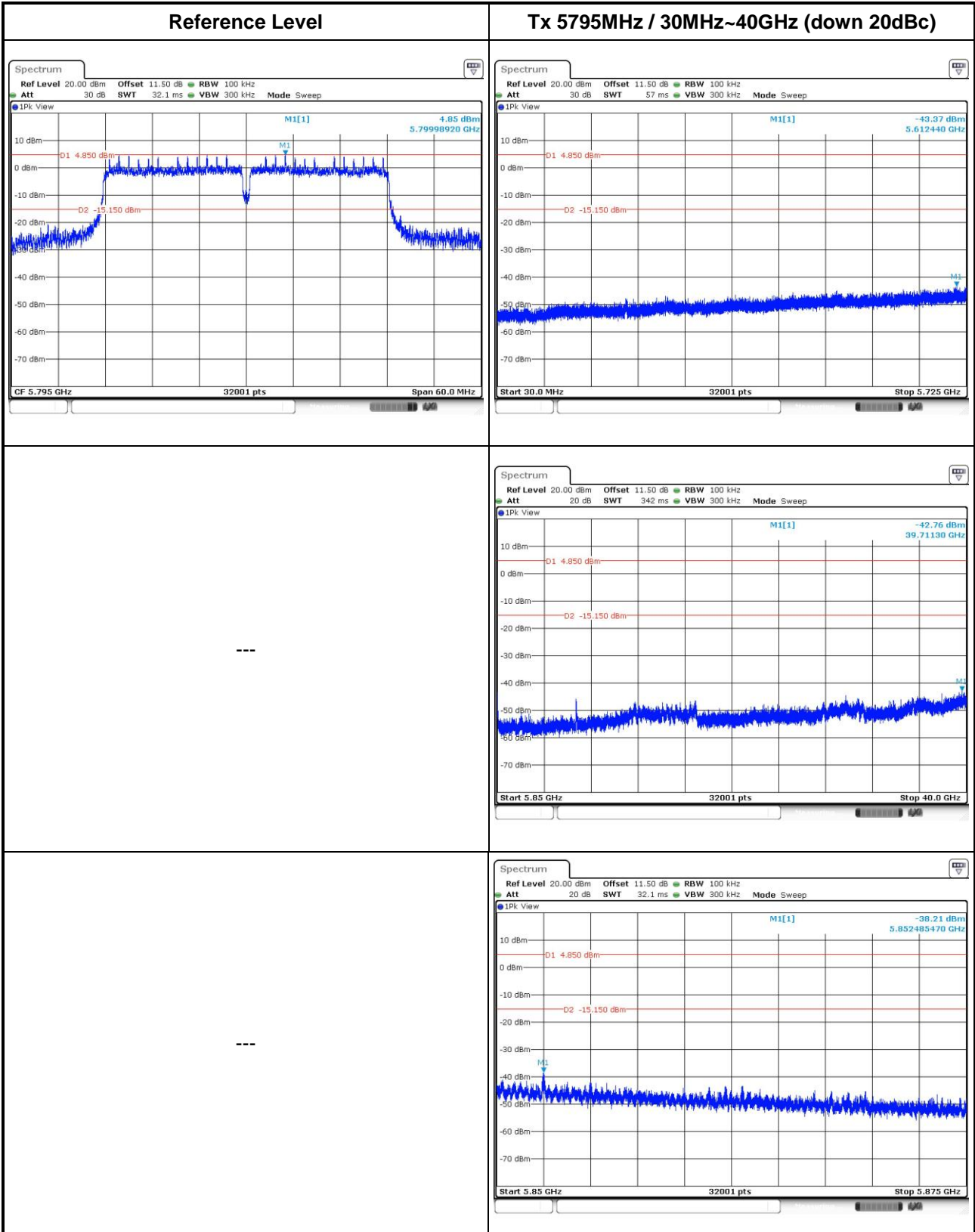

802.11n VHT80

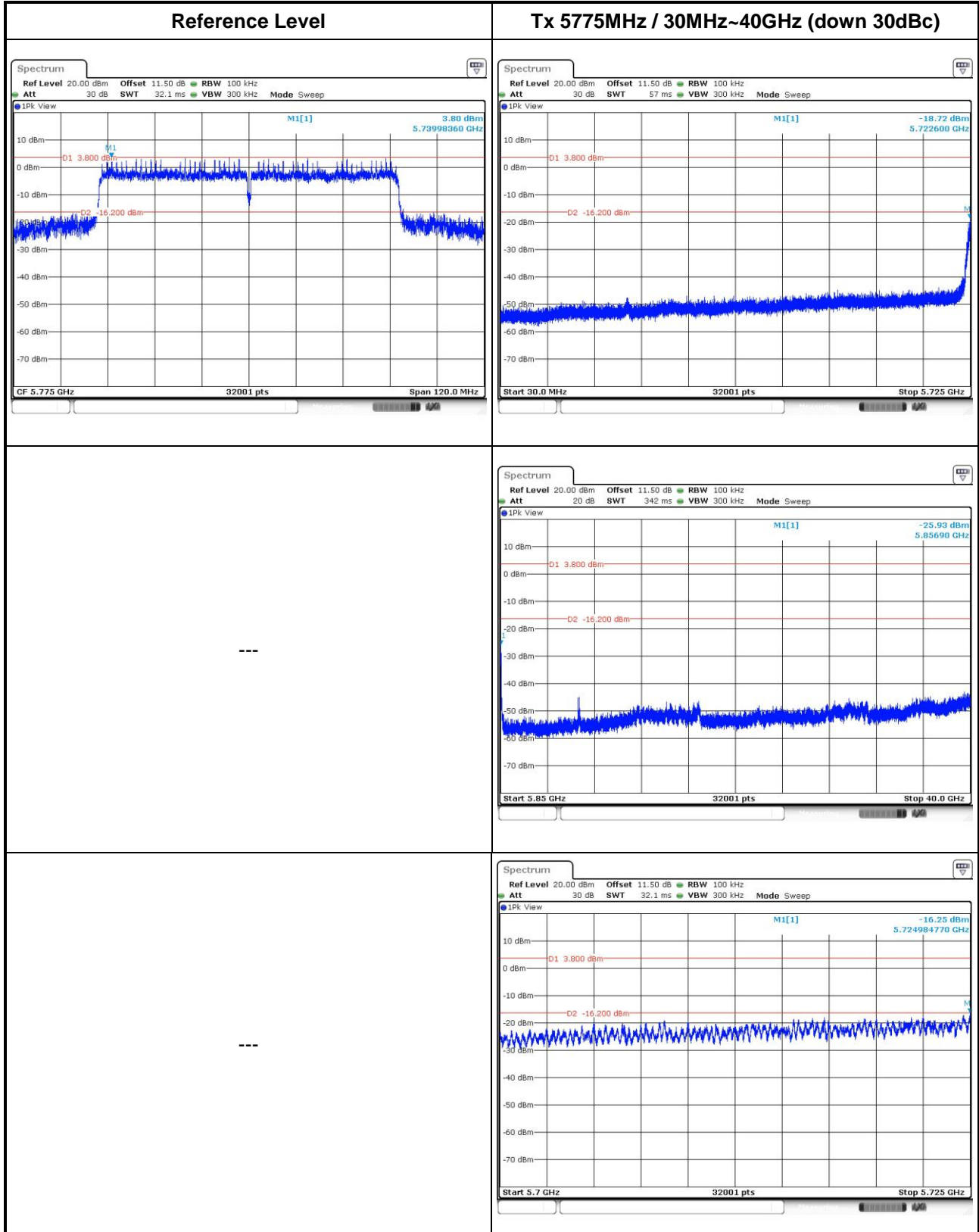

4 Test laboratory information

Established in 2012, ICC provides foremost EMC & RF Testing and advisory consultation services by our skilled engineers and technicians. Our services employ a wide variety of advanced edge test equipment and one of the widest certification extents in the business.

International Certification Corp, it is our definitive objective is to institute long term, trust-based associations with our clients. The expectation we set up with our clients is based on outstanding service, practical expertise and devotion to a certified value structure. Our passion is to grant our clients with best EMC / RF services by oriented knowledgeable and accommodating staff.

Our Test sites are located at Linkou District and Kwei Shan Hsiang. Location map can be found on our website <http://www.icertifi.com.tw>.

Linkou

Tel: 886-2-2601-1640

No. 30-2, Ding Fwu Tsuen, Lin
Kou District, New Taipei City,
Taiwan, R.O.C.

Kwei Shan

Tel: 886-3-271-8666

No. 3-1, Lane 6, Wen San 3rd St.,
Kwei Shan Hsiang, Tao Yuan
Hsien 333, Taiwan, R.O.C.

Kwei Shan Site II

Tel: 886-3-271-8640

No. 14-1, Lane 19, Wen San 3rd
St., Kwei Shan Hsiang, Tao Yuan
Hsien 333, Taiwan, R.O.C.

If you have any suggestion, please feel free to contact us as below information

Tel: 886-3-271-8666

Fax: 886-3-318-0155

Email: ICC_Service@icertifi.com.tw

==END==