

FCC Test Report

Report No.: RF141001C39G

FCC ID: PY314200276

Test Model: WNDR4300v2

Received Date: Jun. 25, 2015

Test Date: Jul. 01 ~ Sep. 18, 2015

Issued Date: Sep. 23, 2015

Applicant: NETGEAR INC.

Address: 350 East Plumeria Drive, San Jose, CA 95134, USA

Issued By: Bureau Veritas Consumer Products Services (H.K.) Ltd., Taoyuan Branch

Lab Address: No. 47-2, 14th Ling, Chia Pau Vil., Lin Kou Dist., New Taipei City, Taiwan, R.O.C.

Test Location: No. 19, Hwa Ya 2nd Rd., Wen Hwa Vil., Kwei Shan Dist., Taoyuan City 33383, TAIWAN (R.O.C.)



This report is for your exclusive use. Any copying or replication of this report to or for any other person or entity, or use of our name or trademark, is permitted only with our prior written permission. This report sets forth our findings solely with respect to the test samples identified herein. The results set forth in this report are not indicative or representative of the quality or characteristics of the lot from which a test sample was taken or any similar or identical product unless specifically and expressly noted. Our report includes all of the tests requested by you and the results thereof based upon the information that you provided to us. You have 60 days from date of issuance of this report to notify us of any material error or omission caused by our negligence, provided, however, that such notice shall be in writing and shall specifically address the issue you wish to raise. A failure to raise such issue within the prescribed time shall constitute your unqualified acceptance of the completeness of this report, the tests conducted and the correctness of the report contents. Unless specific mention, the uncertainty of measurement has been explicitly taken into account to declare the compliance or non-compliance to the specification. The report must not be used by the client to claim product certification, approval, or endorsement by TAF or any government agencies.



Table of Contents

Release Control Record	4
1 Certificate of Conformity	5
2 Summary of Test Results	6
2.1 Measurement Uncertainty	6
2.2 Modification Record	6
3 General Information	7
3.1 General Description of EUT	7
3.2 Description of Test Modes	9
3.2.1 Test Mode Applicability and Tested Channel Detail.....	10
3.3 Duty Cycle of Test Signal	12
3.4 Description of Support Units	13
3.4.1 Configuration of System under Test	13
3.5 General Description of Applied Standards	14
4 Test Types and Results	15
4.1 Radiated Emission and Bandedge Measurement.....	15
4.1.1 Limits of Radiated Emission and Bandedge Measurement	15
4.1.2 Test Instruments	16
4.1.3 Test Procedures.....	17
4.1.4 Deviation from Test Standard	17
4.1.5 Test Set Up	18
4.1.6 EUT Operating Conditions.....	18
4.1.7 Test Results	19
4.2 Conducted Emission Measurement	28
4.2.1 Limits of Conducted Emission Measurement	28
4.2.2 Test Instruments	28
4.2.3 Test Procedures.....	29
4.2.4 Deviation from Test Standard	29
4.2.5 Test Setup.....	29
4.2.6 EUT Operating Conditions.....	29
4.2.7 Test Results	30
4.3 Transmit Power Measurement	32
4.3.1 Limits of Transmit Power Measurement	32
4.3.2 Test Setup.....	32
4.3.3 Test Instruments	32
4.3.4 Test Procedure	33
4.3.5 Deviation from Test Standard	33
4.3.6 EUT Operating Conditions.....	33
4.3.7 Test Result.....	34
4.4 Peak Power Spectral Density Measurement	37
4.4.1 Limits of Peak Power Spectral Density Measurement	37
4.4.2 Test Setup.....	37
4.4.3 Test Instruments	37
4.4.4 Test Procedures.....	37
4.4.5 Deviation from Test Standard	37
4.4.6 EUT Operating Conditions.....	37
4.4.7 Test Results	38
4.5 Frequency Stability.....	40
4.5.1 Limits of Frequency Stability Measurement	40
4.5.2 Test Setup.....	40
4.5.3 Test Instruments	40
4.5.4 Test Procedure	40
4.5.5 Deviation from Test Standard	40
4.5.6 EUT Operating Condition	40



4.5.7 Test Results	41
4.6 6dB Bandwidth Measurement	42
4.6.1 Limits of 6dB Bandwidth Measurement	42
4.6.2 Test Setup	42
4.6.3 Test Instruments	42
4.6.4 Test Procedure	42
4.6.5 Deviation from Test Standard	42
4.6.6 EUT Operating Condition	42
4.6.7 Test Results	43
5 Pictures of Test Arrangements	45
Appendix – Information on the Testing Laboratories	46



Release Control Record

Issue No.	Description	Date Issued
RF141001C39G	Original release	Sep. 23, 2015

1 Certificate of Conformity

Product: N750 Wireless Dual Band Gigabit Router

Brand: NETGEAR

Test Model: WNDR4300v2

Sample Status: Engineering sample

Applicant: NETGEAR INC.

Test Date: Jul. 01 ~ Sep. 18, 2015

Standards: 47 CFR FCC Part 15, Subpart E (Section 15.407)
ANSI C63.10:2013

The above equipment has been tested by **Bureau Veritas Consumer Products Services (H.K.) Ltd., Taoyuan Branch**, and found compliance with the requirement of the above standards. The test record, data evaluation & Equipment Under Test (EUT) configurations represented herein are true and accurate accounts of the measurements of the sample's EMC characteristics under the conditions specified in this report.

Prepared by :  _____, **Date:** _____ Sep. 23, 2015
Pettie Chen / Senior Specialist

Approved by :  _____, **Date:** _____ Sep. 23, 2015
Ken Liu / Senior Manager

2 Summary of Test Results

47 CFR FCC Part 15, Subpart E (SECTION 15.407)			
FCC Clause	Test Item	Result	Remarks
15.407(b)(6)	AC Power Conducted Emissions	Pass	Meet the requirement of limit. Minimum passing margin is -26.15dB at 0.43028MHz.
15.407(b) (1/2/3/4/6)	Radiated Emissions & Band Edge Measurement	Pass	Meet the requirement of limit. Minimum passing margin is -0.1dB at 5000.00MHz.
15.407(a)(1/2/3)	Max Average Transmit Power	Pass	Meet the requirement of limit.
15.407(a)(1/2/3)	Peak Power Spectral Density	Pass	Meet the requirement of limit.
15.407(e)	6dB bandwidth	Pass	Meet the requirement of limit. (U-NII-3 Band only)
15.407(g)	Frequency Stability	Pass	Meet the requirement of limit.
15.203	Antenna Requirement	Pass	Antenna connector is I-PEX(MHF) not a standard connector.

2.1 Measurement Uncertainty

Where relevant, the following measurement uncertainty levels have been estimated for tests performed on the EUT as specified in CISPR 16-4-2:

Measurement	Frequency	Expanded Uncertainty (k=2) (\pm)
Conducted Emissions at mains ports	150kHz ~ 30MHz	2.44 dB
Radiated Emissions up to 1 GHz	30MHz ~ 200MHz	3.59 dB
	200MHz ~ 1000MHz	3.60 dB
Radiated Emissions above 1 GHz	1GHz ~ 18GHz	2.29 dB
	18GHz ~ 40GHz	2.29 dB

2.2 Modification Record

There were no modifications required for compliance.

3 General Information

3.1 General Description of EUT

Product	N750 Wireless Dual Band Gigabit Router
Brand	NETGEAR
Test Model	WNDR4300v2
Status of EUT	Engineering sample
Power Supply Rating	12Vdc (Adapter)
Modulation Type	64QAM, 16QAM, QPSK, BPSK
Modulation Technology	OFDM
Transfer Rate	802.11a: 54.0/ 48.0/ 36.0/ 24.0/ 18.0/ 12.0/ 9.0/ 6.0Mbps 802.11n: up to 450Mbps
Operating Frequency	5745 ~ 5825MHz
Number of Channel	5 for 802.11a, 802.11n (HT20) 2 for 802.11n (HT40)
Output Power	381.781mW
Antenna Type	Refer to Note
Antenna Connector	Refer to Note
Accessory Device	Adapter
Data Cable Supplied	1.5m non-shielded RJ45 cable without core

Note:

1. This report is prepared for FCC class II permissive change.
2. This report is issued as a supplementary report to the original BVADT report no.: RF141001C39-1. The difference compared with the original report is updating U-NII 3 band standard to new rule version. Due to devices where no increase in authorized power level in U-NII-1 band an attestation with description of software security must be provided, the EUT was tested for U-NII 3 band and presented in the test report.
3. The EUT incorporates a MIMO function. Physically, the EUT provides 3 completed transmitters and 3 receivers.

Modulation Mode	TX Function
802.11a	3TX
802.11n (HT20)	3TX
802.11n (HT40)	3TX

4. The EUT consumes power from the following adapter and PoE.

Adapter 1	
Brand	NETGEAR
Model	AD817F10 (PIE)
P/N	332-10301-02
Input Power	100-240Vac, 50/60Hz, 1.0A
Output Power	12Vdc, 1.5A
Power Line	1.8m cable without core attached on adapter

Adapter 2	
Brand	NETGEAR
Model	SAL018F1 NA (CWT)
P/N	332-10375-01
Input Power	100-120Vac, 47-63Hz, 0.6A
Output Power	12Vdc, 1.5A
Power Line	1.8m cable without core attached on adapter

Adapter 3	
Brand	NETGEAR
Model	MU18-D120150-A1 (LEI)
P/N	332-10268-01
Input Power	100-240Vac, 50/60Hz, 0.6A
Output Power	12Vdc, 1.5A
Power Line	1.85m cable without core attached on adapter

Adapter 4	
Brand	NETGEAR
Model	AD817F20 (PIE)
P/N	332-10307-02
Input Power	100-240Vac, 50/60Hz, 0.56A
Output Power	12Vdc, 1.5A
Power Line	1.85m cable without core attached on adapter

*Adapter 1 was the worst for the final report.

5. The following antennas were provided to the EUT.

Ant. NO.	Brand	Model	Ant. Type	Connecter Type	Antenna Gain(dBi) Including cable loss	
					2.4GHz	5.0GHz
1, 2	Master Wave Technology Co., Ltd.	98P2LPIPF000	PCB	i-pex(MHF)	3.37	3.03
3	Master Wave Technology Co., Ltd.	98P2LPIPF001	PCB	i-pex(MHF)	2.64	3.31

*Antenna 1, 2 for 2.4GHz band of EUT used only.

6. The above EUT information is declared by manufacturer and for more detailed features description, please refer to the manufacturer's specifications or user's manual.

3.2 Description of Test Modes

FOR 5745 ~ 5825MHz:

5 channels are provided for 802.11a, 802.11n (HT20):

Channel	Frequency	Channel	Frequency
149	5745MHz	161	5805MHz
153	5765MHz	165	5825MHz
157	5785MHz		

2 channels are provided for 802.11n (HT40):

Channel	Frequency	Channel	Frequency
151	5755MHz	159	5795MHz

3.2.1 Test Mode Applicability and Tested Channel Detail

EUT CONFIGURE MODE	APPLICABLE TO				DESCRIPTION
	RE≥1G	RE<1G	PLC	APCM	
-	√	√	√	√	-

Where **RE≥1G**: Radiated Emission above 1GHz & Bandedge Measurement
RE<1G: Radiated Emission below 1GHz
PLC: Power Line Conducted Emission
APCM: Antenna Port Conducted Measurement

NOTE: 1. The EUT had been pre-tested on the positioned of each 3 axis. The worst case was found when positioned on **Z-plane**.
 2. "-" means no effect.

Radiated Emission Test (Above 1GHz):

Pre-Scan has been conducted to determine the worst-case mode from all possible combinations between available modulations, data rates and antenna ports (if EUT with antenna diversity architecture).

Following channel(s) was (were) selected for the final test as listed below.

EUT CONFIGURE MODE	MODE	FREQ. BAND (MHz)	AVAILABLE CHANNEL	TESTED CHANNEL	MODULATION TECHNOLOGY	MODULATION TYPE	DATA RATE (Mbps)
-	802.11a	5745-5825	149 to 165	149, 157, 165	OFDM	BPSK	6.0
-	802.11n (HT20)		149 to 165	149, 157, 165	OFDM	BPSK	6.5
-	802.11n (HT40)		151 to 159	151, 159	OFDM	BPSK	13.5

Radiated Emission Test (Below 1GHz):

Pre-Scan has been conducted to determine the worst-case mode from all possible combinations between available modulations, data rates and antenna ports (if EUT with antenna diversity architecture).

Following channel(s) was (were) selected for the final test as listed below.

EUT CONFIGURE MODE	MODE	FREQ. BAND (MHz)	AVAILABLE CHANNEL	TESTED CHANNEL	MODULATION TECHNOLOGY	MODULATION TYPE	DATA RATE (Mbps)
-	802.11a	5745-5825	149 to 165	157	OFDM	BPSK	6.0

Power Line Conducted Emission Test:

Pre-Scan has been conducted to determine the worst-case mode from all possible combinations between available modulations, data rates and antenna ports (if EUT with antenna diversity architecture).

Following channel(s) was (were) selected for the final test as listed below.

EUT CONFIGURE MODE	MODE	FREQ. BAND (MHz)	AVAILABLE CHANNEL	TESTED CHANNEL	MODULATION TECHNOLOGY	MODULATION TYPE	DATA RATE (Mbps)
-	802.11a	5745-5825	149 to 165	157	OFDM	BPSK	6.0



Antenna Port Conducted Measurement:

- This item includes all test value of each mode, but only includes spectrum plot of worst value of each mode.
- Pre-Scan has been conducted to determine the worst-case mode from all possible combinations between available modulations, data rates and antenna ports (if EUT with antenna diversity architecture).
- Following channel(s) was (were) selected for the final test as listed below.

EUT CONFIGURE MODE	MODE	FREQ. BAND (MHz)	AVAILABLE CHANNEL	TESTED CHANNEL	MODULATION TECHNOLOGY	MODULATION TYPE	DATA RATE (Mbps)
-	802.11a	5745-5825	149 to 165	149, 157, 165	OFDM	BPSK	6.0
-	802.11n (HT20)		149 to 165	149, 157, 165	OFDM	BPSK	6.5
-	802.11n (HT40)		151 to 159	151, 159	OFDM	BPSK	13.5

Test Condition:

APPLICABLE TO	ENVIRONMENTAL CONDITIONS	INPUT POWER	TESTED BY
RE \geq 1G	24deg. C, 66%RH 25deg. C, 60%RH	120Vac, 60Hz	Chris Lin Alan Wu
RE<1G	25deg. C, 60%RH	120Vac, 60Hz	Alan Wu
PLC	26deg. C, 61%RH	120Vac, 60Hz	Alan Wu
APCM	25deg. C, 60%RH	120Vac, 60Hz	Leo Tsai

3.3 Duty Cycle of Test Signal

Duty cycle of test signal is < 98 %, duty factor is required

802.11a: Duty cycle = $2.014/2.072 = 0.972$, Duty factor = $10 * \log(1/0.972) = 0.12$

802.11n (HT20): Duty cycle = $1.882/1.94 = 0.97$, Duty factor = $10 * \log(1/0.97) = 0.13$

802.11n (HT40): Duty cycle = $0.924/0.957 = 0.966$, Duty factor = $10 * \log(1/0.966) = 0.15$



3.4 Description of Support Units

The EUT has been tested as an independent unit together with other necessary accessories or support units. The following support units or accessories were used to form a representative test configuration during the tests.

ID	Product	Brand	Model No.	Serial No.	FCC ID	Remarks
A.	Notebook	DELL	E5420	BPQ8MQ1	FCC DoC Approved	-
B.	Dongle	SANDISK	SDCZ6-1024	NA	NA	-
C.	Load	NA	NA	NA	NA	-

Note:

1. All power cords of the above support units are non-shielded (1.8m).
2. Items A acted as communication partners to transfer data.

ID	Descriptions	Qty.	Length (m)	Shielding (Yes/No)	Cores (Qty.)	Remarks
1.	LAN cable	1	10	N	0	-
2.	LAN cable	4	1.8	N	0	Accessory of EUT

Note: The core(s) is(are) originally attached to the cable(s).

3.4.1 Configuration of System under Test

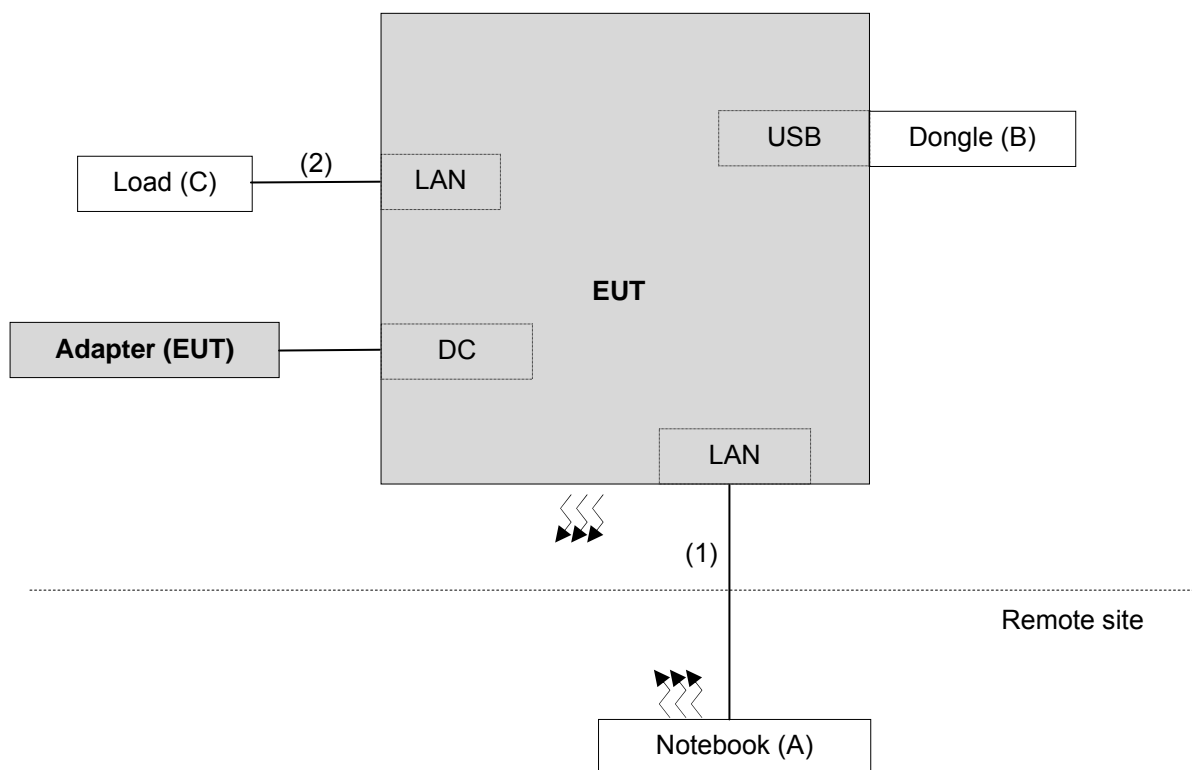

3.5 General Description of Applied Standards

The EUT is a RF Product. According to the specifications of the manufacturer, it must comply with the requirements of the following standards:

FCC Part 15, Subpart E (15.407)

789033 D02 General UNII Test Procedures New Rules v01

662911 D01 Multiple Transmitter Output v02r01

ANSI C63.10-2013

All test items have been performed and recorded as per the above standards.

NOTE: The EUT has been verified to comply with the requirements of FCC Part 15, Subpart B, Class B (DoC).
The test report has been issued separately.

4 Test Types and Results

4.1 Radiated Emission and Bandedge Measurement

4.1.1 Limits of Radiated Emission and Bandedge Measurement

Radiated emissions which fall in the restricted bands must comply with the radiated emission limits specified as below table. Other emissions shall be at least 20dB below the highest level of the desired power:

Frequencies (MHz)	Field Strength (microvolts/meter)	Measurement Distance (meters)
0.009 ~ 0.490	2400/F(kHz)	300
0.490 ~ 1.705	24000/F(kHz)	30
1.705 ~ 30.0	30	30
30 ~ 88	100	3
88 ~ 216	150	3
216 ~ 960	200	3
Above 960	500	3

NOTE:

1. The lower limit shall apply at the transition frequencies.
2. Emission level (dBuV/m) = 20 log Emission level (uV/m).
3. For frequencies above 1000MHz, the field strength limits are based on average detector, however, the peak field strength of any emission shall not exceed the maximum permitted average limits, specified above by more than 20dB under any condition of modulation.

LIMITS OF UNWANTED EMISSION OUT OF THE RESTRICTED BANDS

APPLICABLE TO	LIMIT	
789033 D02 General UNII Test Procedures New Rules v01	FIELD STRENGTH AT 3m	
	PK:74 (dBµV/m)	AV:54 (dBµV/m)
APPLICABLE TO	EIRP LIMIT	EQUIVALENT FIELD STRENGTH AT 3m
15.407(b)(1)	PK:-27 (dBm/MHz)	PK:68.2(dBµV/m)
15.407(b)(2)		
15.407(b)(3)		
15.407(b)(4)	PK:-27 (dBm/MHz) ^{*1} PK:-17 (dBm/MHz) ^{*2}	PK: 68.2(dBµV/m) ^{*1} PK:78.2 (dBµV/m) ^{*2}

NOTE: ^{*1} beyond 10MHz of the band edge ^{*2} within 10 MHz of band edge

The following formula is used to convert the equipment isotropic radiated power (eirp) to field strength:

$$E = \frac{1000000 \sqrt{30P}}{3} \mu\text{V/m, where P is the eirp (Watts).}$$

4.1.2 Test Instruments

Description & Manufacturer	Model No.	Serial No.	Date Of Calibration	Due Date Of Calibration
Test Receiver ROHDE & SCHWARZ	ESCI	100424	Oct. 06, 2014	Oct. 05, 2015
Spectrum Analyzer ROHDE & SCHWARZ	FSP40	100040	Jul. 25, 2014	Jul. 24, 2015
			Jul. 08, 2015	Jul. 07, 2016
BILOG Antenna SCHWARZBECK	VULB9168	9168-155	Feb. 06, 2015	Feb. 05, 2016
HORN Antenna SCHWARZBECK	BBHA 9120D	9120D-1170	Feb. 05, 2015	Feb. 04, 2016
HORN Antenna SCHWARZBECK	BBHA 9170	BBHA9170241	Feb. 09, 2015	Feb. 08, 2016
Preamplifier Agilent	8449B	3008A01911	Aug. 09, 2014	Aug. 08, 2015
			Aug. 09, 2015	Aug. 08, 2016
Preamplifier Agilent	8447D	2944A10631	Aug. 09, 2014	Aug. 08, 2015
			Aug. 09, 2015	Aug. 08, 2016
RF signal cable HUBER+SUHNNER	SUCOFLEX 104	309220/4	Aug. 09, 2014	Aug. 08, 2015
			Aug. 09, 2015	Aug. 08, 2016
RF signal cable HUBER+SUHNNER	SUCOFLEX 104	250724/4	Aug. 09, 2014	Aug. 08, 2015
			Aug. 09, 2015	Aug. 08, 2016
RF signal cable HUBER+SUHNNER	SUCOFLEX 104	295012/4	Aug. 09, 2014	Aug. 08, 2015
			Aug. 09, 2015	Aug. 08, 2016
Software BV ADT	ADT_Radiated_ V7.6.15.9.4	NA	NA	NA
Antenna Tower inn-co GmbH	MA 4000	010303	NA	NA
Antenna Tower Controller BV ADT	AT100	AT93021703	NA	NA
Turn Table BV ADT	TT100	TT93021703	NA	NA
Turn Table Controller BV ADT	SC100.	SC93021703	NA	NA
26GHz ~ 40GHz Amplifier	EM26400	815221	Oct. 18, 2014	Oct. 17, 2015
High Speed Peak Power Meter	ML2495A	0824011	Jul. 26, 2014	Jul. 25, 2015
			Jul. 09, 2015	Jul. 08, 2016
Power Sensor	MA2411B	0738171	Jul. 26, 2014	Jul. 25, 2015
			Jul. 09, 2015	Jul. 08, 2016

- NOTE:** 1. The calibration interval of the above test instruments is 12 months and the calibrations are traceable to NML/ROC and NIST/USA.
2. The test was performed in HwaYa Chamber 4.
3. The horn antenna and HP preamplifier (model: 8449B) are used only for the measurement of emission frequency above 1GHz if tested.
4. The FCC Site Registration No. is 460141.
5. The IC Site Registration No. is IC7450F-4.

4.1.3 Test Procedures

- a. The EUT was placed on the top of a rotating table 0.8 meters (for below 1GHz) / 1.5 meters (for above 1GHz) above the ground at 3 meter chamber room for test. The table was rotated 360 degrees to determine the position of the highest radiation.
- b. The EUT was set 3 meters away from the interference-receiving antenna, which was mounted on the top of a variable-height antenna tower.
- c. The height of antenna is varied from one meter to four meters above the ground to determine the maximum value of the field strength. Both horizontal and vertical polarizations of the antenna are set to make the measurement.
- d. For each suspected emission, the EUT was arranged to its worst case and then the antenna was tuned to heights from 1 meter to 4 meters and the rotatable table was turned from 0 degrees to 360 degrees to find the maximum reading.
- e. The test-receiver system was set to quasi-peak detect function and specified bandwidth with maximum hold mode when the test frequency is below 1 GHz.
- f. The test-receiver system was set to peak and average detect function and specified bandwidth with maximum hold mode when the test frequency is above 1 GHz. If the peak reading value also meets average limit, measurement with the average detector is unnecessary.

Note:

1. The resolution bandwidth and video bandwidth of test receiver/spectrum analyzer is 120kHz for Quasi-peak detection (QP) at frequency below 1GHz.
2. The resolution bandwidth of test receiver/spectrum analyzer is 1 MHz and the video bandwidth is 3 MHz for Peak detection (PK) at frequency above 1GHz.
3. The resolution bandwidth of test receiver/spectrum analyzer is 1MHz and the video bandwidth is 3MHz for RMS Average (Duty cycle < 98%) for Average detection (AV) at frequency above 1GHz, then the measurement results was added to a correction factor ($10 \log(1/\text{duty cycle})$).
4. The resolution bandwidth of test receiver/spectrum analyzer is 1MHz and the video bandwidth is 10Hz (Duty cycle $\geq 98\%$) for Average detection (AV) at frequency above 1GHz.
5. All modes of operation were investigated and the worst-case emissions are reported.

4.1.4 Deviation from Test Standard

No deviation.

4.1.5 Test Set Up

<Frequency Range below 1GHz>

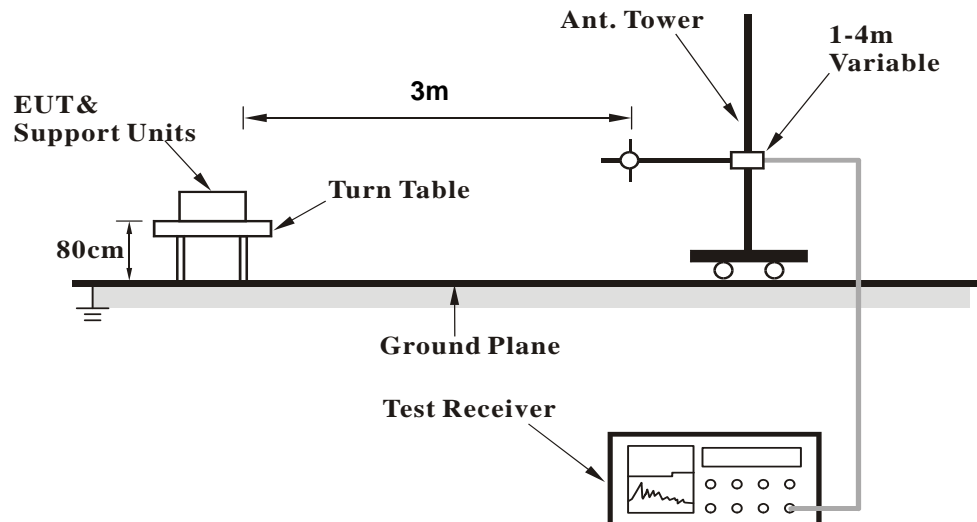

<Frequency Range above 1GHz>

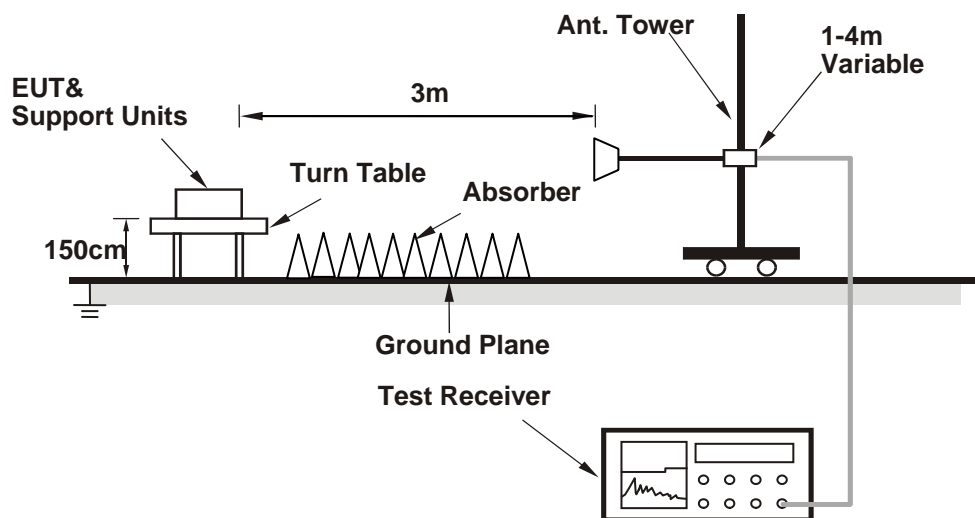

For the actual test configuration, please refer to the attached file (Test Setup Photo)

4.1.6 EUT Operating Conditions

- Placed the EUT on the testing table.
- Prepared a notebook to act as communication partner and placed it outside of testing area.
- The communication partner connected with EUT via a RJ45 cable and ran a test program (provided by manufacturer) to enable EUT under transmission condition continuously at specific channel frequency.
- The communication partner sent data to EUT by command "PING".
- The necessary accessories enabled the system in full functions.

4.1.7 Test Results

Above 1GHz data:

802.11a

CHANNEL	TX Channel 149	DETECTOR FUNCTION	Peak (PK)
FREQUENCY RANGE	1GHz ~ 40GHz		Average (AV)

ANTENNA POLARITY & TEST DISTANCE: HORIZONTAL AT 3 M								
NO.	FREQ. (MHz)	EMISSION LEVEL (dBuV/m)	LIMIT (dBuV/m)	MARGIN (dB)	ANTENNA HEIGHT (m)	TABLE ANGLE (Degree)	RAW VALUE (dBuV)	CORRECTION FACTOR (dB/m)
1	#5714.00	66.8 PK	74.0	-7.2	2.02 H	290	60.50	6.30
2	#5714.00	48.6 AV	54.0	-5.4	2.02 H	290	42.30	6.30
3	#5722.00	74.5 PK	78.2	-3.7	2.02 H	290	68.20	6.30
4	#5725.00	66.7 PK	78.2	-11.5	2.02 H	290	60.40	6.30
5	*5745.00	113.2 PK			2.02 H	290	72.90	40.30
6	*5745.00	102.8 AV			2.02 H	290	62.50	40.30
7	11490.00	59.1 PK	74.0	-14.9	1.08 H	305	41.90	17.20
8	11490.00	47.2 AV	54.0	-6.8	1.08 H	305	30.00	17.20

ANTENNA POLARITY & TEST DISTANCE: VERTICAL AT 3 M								
NO.	FREQ. (MHz)	EMISSION LEVEL (dBuV/m)	LIMIT (dBuV/m)	MARGIN (dB)	ANTENNA HEIGHT (m)	TABLE ANGLE (Degree)	RAW VALUE (dBuV)	CORRECTION FACTOR (dB/m)
1	#5714.00	69.9 PK	74.0	-4.1	1.49 V	282	63.60	6.30
2	#5714.00	51.4 AV	54.0	-2.6	1.49 V	282	45.10	6.30
3	#5722.00	78.0 PK	78.2	-0.2	1.49 V	282	71.70	6.30
4	#5725.00	68.3 PK	78.2	-9.9	1.49 V	282	62.00	6.30
5	*5745.00	116.5 PK			1.49 V	282	76.20	40.30
6	*5745.00	106.0 AV			1.49 V	282	65.70	40.30
7	11490.00	60.2 PK	74.0	-13.8	1.15 V	305	43.00	17.20
8	11490.00	46.2 AV	54.0	-7.8	1.15 V	305	29.00	17.20

REMARKS:

1. Emission Level(dBuV/m) = Raw Value(dBuV) + Correction Factor(dB/m)
2. Correction Factor(dB/m) = Antenna Factor(dB/m) + Cable Factor(dB)
3. The other emission levels were very low against the limit.
4. Margin value = Emission Level – Limit value
5. " * ": Fundamental frequency.
6. " # ": The radiated frequency is out of the restricted band.

CHANNEL	TX Channel 157	DETECTOR FUNCTION	Peak (PK)
FREQUENCY RANGE	1GHz ~ 40GHz		Average (AV)

ANTENNA POLARITY & TEST DISTANCE: HORIZONTAL AT 3 M

NO.	FREQ. (MHz)	EMISSION LEVEL (dBuV/m)	LIMIT (dBuV/m)	MARGIN (dB)	ANTENNA HEIGHT (m)	TABLE ANGLE (Degree)	RAW VALUE (dBuV)	CORRECTION FACTOR (dB/m)
1	5000.00	56.1 PK	74.0	-17.9	1.56 H	284	51.10	5.00
2	5000.00	42.8 AV	54.0	-11.2	1.56 H	284	37.80	5.00
3	*5785.00	115.6 PK			1.52 H	287	75.20	40.40
4	*5785.00	105.5 AV			1.52 H	287	65.10	40.40
5	11570.00	62.8 PK	74.0	-11.2	1.10 H	52	45.50	17.30
6	11570.00	47.6 AV	54.0	-6.4	1.10 H	52	30.30	17.30

ANTENNA POLARITY & TEST DISTANCE: VERTICAL AT 3 M

NO.	FREQ. (MHz)	EMISSION LEVEL (dBuV/m)	LIMIT (dBuV/m)	MARGIN (dB)	ANTENNA HEIGHT (m)	TABLE ANGLE (Degree)	RAW VALUE (dBuV)	CORRECTION FACTOR (dB/m)
1	5000.00	61.5 PK	74.0	-12.5	1.95 V	278	56.50	5.00
2	5000.00	53.9 AV	54.0	-0.1	1.95 V	278	48.90	5.00
3	*5785.00	118.4 PK			1.63 V	276	78.00	40.40
4	*5785.00	108.8 AV			1.63 V	276	68.40	40.40
5	11570.00	66.2 PK	74.0	-7.8	1.50 V	124	48.90	17.30
6	11570.00	51.2 AV	54.0	-2.8	1.50 V	124	33.90	17.30

REMARKS:

1. Emission Level(dBuV/m) = Raw Value(dBuV) + Correction Factor(dB/m)
2. Correction Factor(dB/m) = Antenna Factor(dB/m) + Cable Factor(dB)
3. The other emission levels were very low against the limit.
4. Margin value = Emission Level – Limit value
5. " * " : Fundamental frequency.



CHANNEL	TX Channel 165	DETECTOR FUNCTION	Peak (PK)
FREQUENCY RANGE	1GHz ~ 40GHz		Average (AV)

ANTENNA POLARITY & TEST DISTANCE: HORIZONTAL AT 3 M

NO.	FREQ. (MHz)	EMISSION LEVEL (dBuV/m)	LIMIT (dBuV/m)	MARGIN (dB)	ANTENNA HEIGHT (m)	TABLE ANGLE (Degree)	RAW VALUE (dBuV)	CORRECTION FACTOR (dB/m)
1	*5825.00	111.9 PK			1.80 H	69	71.40	40.50
2	*5825.00	101.3 AV			1.80 H	69	60.80	40.50
3	#5850.00	60.9 PK	78.2	-17.3	1.80 H	69	54.30	6.60
4	#5853.00	72.1 PK	78.2	-6.1	1.80 H	69	65.50	6.60
5	#5861.00	53.7 PK	74.0	-20.3	1.80 H	69	47.10	6.60
6	#5861.00	36.0 AV	54.0	-18.0	1.80 H	69	29.40	6.60
7	11650.00	60.3 PK	74.0	-13.7	1.47 H	123	42.60	17.70
8	11650.00	46.4 AV	54.0	-7.6	1.47 H	123	28.70	17.70

ANTENNA POLARITY & TEST DISTANCE: VERTICAL AT 3 M

NO.	FREQ. (MHz)	EMISSION LEVEL (dBuV/m)	LIMIT (dBuV/m)	MARGIN (dB)	ANTENNA HEIGHT (m)	TABLE ANGLE (Degree)	RAW VALUE (dBuV)	CORRECTION FACTOR (dB/m)
1	*5825.00	118.2 PK			1.75 V	273	77.70	40.50
2	*5825.00	108.6 AV			1.75 V	273	68.10	40.50
3	#5850.00	63.7 PK	78.2	-14.5	1.75 V	273	57.10	6.60
4	#5853.00	78.0 PK	78.2	-0.2	1.75 V	273	71.40	6.60
5	#5861.00	67.9 PK	74.0	-6.1	1.75 V	273	61.30	6.60
6	#5861.00	51.8 AV	54.0	-2.2	1.75 V	273	45.20	6.60
7	11650.00	60.3 PK	74.0	-13.7	1.47 V	87	42.60	17.70
8	11650.00	46.4 AV	54.0	-7.6	1.47 V	87	28.70	17.70

REMARKS:

1. Emission Level(dBuV/m) = Raw Value(dBuV) + Correction Factor(dB/m)
2. Correction Factor(dB/m) = Antenna Factor(dB/m) + Cable Factor(dB)
3. The other emission levels were very low against the limit.
4. Margin value = Emission Level – Limit value
5. " * ": Fundamental frequency.
6. " # ": The radiated frequency is out of the restricted band.

802.11n (HT20)

CHANNEL	TX Channel 149	DETECTOR FUNCTION	Peak (PK)
FREQUENCY RANGE	1GHz ~ 40GHz		Average (AV)

ANTENNA POLARITY & TEST DISTANCE: HORIZONTAL AT 3 M

NO.	FREQ. (MHz)	EMISSION LEVEL (dBuV/m)	LIMIT (dBuV/m)	MARGIN (dB)	ANTENNA HEIGHT (m)	TABLE ANGLE (Degree)	RAW VALUE (dBuV)	CORRECTION FACTOR (dB/m)
1	#5714.90	64.8 PK	74.0	-9.2	1.67 H	280	58.50	6.30
2	#5714.90	46.6 AV	54.0	-7.4	1.67 H	280	40.30	6.30
3	#5722.90	72.8 PK	78.2	-5.4	1.67 H	280	66.50	6.30
4	#5725.00	57.4 PK	78.2	-20.8	1.67 H	280	51.10	6.30
5	*5745.00	111.3 PK			1.67 H	280	71.00	40.30
6	*5745.00	101.4 AV			1.67 H	280	61.10	40.30
7	11490.00	60.4 PK	74.0	-13.6	1.00 H	68	43.20	17.20
8	11490.00	47.2 AV	54.0	-6.8	1.00 H	68	30.00	17.20

ANTENNA POLARITY & TEST DISTANCE: VERTICAL AT 3 M

NO.	FREQ. (MHz)	EMISSION LEVEL (dBuV/m)	LIMIT (dBuV/m)	MARGIN (dB)	ANTENNA HEIGHT (m)	TABLE ANGLE (Degree)	RAW VALUE (dBuV)	CORRECTION FACTOR (dB/m)
1	#5714.90	66.6 PK	74.0	-7.4	1.57 V	272	60.30	6.30
2	#5714.90	49.2 AV	54.0	-4.8	1.57 V	272	42.90	6.30
3	#5722.90	77.6 PK	78.2	-0.6	1.57 V	272	71.30	6.30
4	#5725.00	64.1 PK	78.2	-14.1	1.57 V	272	57.80	6.30
5	*5745.00	115.3 PK			1.57 V	272	75.00	40.30
6	*5745.00	105.3 AV			1.57 V	272	65.00	40.30
7	11490.00	62.5 PK	74.0	-11.5	1.53 V	135	45.30	17.20
8	11490.00	49.3 AV	54.0	-4.7	1.53 V	135	32.10	17.20

REMARKS:

1. Emission Level(dBuV/m) = Raw Value(dBuV) + Correction Factor(dB/m)
2. Correction Factor(dB/m) = Antenna Factor(dB/m) + Cable Factor(dB)
3. The other emission levels were very low against the limit.
4. Margin value = Emission Level – Limit value
5. " * ": Fundamental frequency.
6. " # ": The radiated frequency is out of the restricted band.

CHANNEL	TX Channel 157	DETECTOR FUNCTION	Peak (PK)
FREQUENCY RANGE	1GHz ~ 40GHz		Average (AV)

ANTENNA POLARITY & TEST DISTANCE: HORIZONTAL AT 3 M

NO.	FREQ. (MHz)	EMISSION LEVEL (dBuV/m)	LIMIT (dBuV/m)	MARGIN (dB)	ANTENNA HEIGHT (m)	TABLE ANGLE (Degree)	RAW VALUE (dBuV)	CORRECTION FACTOR (dB/m)
1	5000.00	56.6 PK	74.0	-17.4	1.74 H	272	51.60	5.00
2	5000.00	43.2 AV	54.0	-10.8	1.74 H	272	38.20	5.00
3	*5785.00	114.5 PK			1.73 H	278	74.10	40.40
4	*5785.00	104.4 AV			1.73 H	278	64.00	40.40
5	11570.00	61.9 PK	74.0	-12.1	1.00 H	62	44.60	17.30
6	11570.00	48.4 AV	54.0	-5.6	1.00 H	62	31.10	17.30

ANTENNA POLARITY & TEST DISTANCE: VERTICAL AT 3 M

NO.	FREQ. (MHz)	EMISSION LEVEL (dBuV/m)	LIMIT (dBuV/m)	MARGIN (dB)	ANTENNA HEIGHT (m)	TABLE ANGLE (Degree)	RAW VALUE (dBuV)	CORRECTION FACTOR (dB/m)
1	5000.00	63.3 PK	74.0	-10.7	1.53 V	272	58.30	5.00
2	5000.00	53.4 AV	54.0	-0.6	1.53 V	272	48.40	5.00
3	*5785.00	118.1 PK			1.54 V	268	77.70	40.40
4	*5785.00	108.0 AV			1.54 V	268	67.60	40.40
5	11570.00	63.8 PK	74.0	-10.2	1.53 V	133	46.50	17.30
6	11570.00	50.6 AV	54.0	-3.4	1.53 V	133	33.30	17.30

REMARKS:

1. Emission Level(dBuV/m) = Raw Value(dBuV) + Correction Factor(dB/m)
2. Correction Factor(dB/m) = Antenna Factor(dB/m) + Cable Factor(dB)
3. The other emission levels were very low against the limit.
4. Margin value = Emission Level – Limit value
5. " * ": Fundamental frequency.



CHANNEL	TX Channel 165	DETECTOR FUNCTION	Peak (PK)
FREQUENCY RANGE	1GHz ~ 40GHz		Average (AV)

ANTENNA POLARITY & TEST DISTANCE: HORIZONTAL AT 3 M

NO.	FREQ. (MHz)	EMISSION LEVEL (dBuV/m)	LIMIT (dBuV/m)	MARGIN (dB)	ANTENNA HEIGHT (m)	TABLE ANGLE (Degree)	RAW VALUE (dBuV)	CORRECTION FACTOR (dB/m)
1	*5825.00	113.6 PK			2.07 H	288	73.10	40.50
2	*5825.00	103.4 AV			2.07 H	288	62.90	40.50
3	#5850.00	54.5 PK	78.2	-23.7	2.07 H	288	47.90	6.60
4	#5852.10	75.5 PK	78.2	-2.7	2.07 H	288	68.90	6.60
5	#5860.10	67.7 PK	74.0	-6.3	2.07 H	288	61.10	6.60
6	#5860.10	48.6 AV	54.0	-5.4	2.07 H	288	42.00	6.60
7	11650.00	60.9 PK	74.0	-13.1	1.00 H	69	43.20	17.70
8	11650.00	47.7 AV	54.0	-6.3	1.00 H	69	30.00	17.70

ANTENNA POLARITY & TEST DISTANCE: VERTICAL AT 3 M

NO.	FREQ. (MHz)	EMISSION LEVEL (dBuV/m)	LIMIT (dBuV/m)	MARGIN (dB)	ANTENNA HEIGHT (m)	TABLE ANGLE (Degree)	RAW VALUE (dBuV)	CORRECTION FACTOR (dB/m)
1	*5825.00	119.1 PK			1.54 V	274	78.60	40.50
2	*5825.00	109.2 AV			1.54 V	274	68.70	40.50
3	#5850.00	58.0 PK	78.2	-20.2	1.54 V	274	51.40	6.60
4	#5852.10	77.7 PK	78.2	-0.5	1.54 V	274	71.10	6.60
5	#5860.10	71.9 PK	74.0	-2.1	1.54 V	274	65.30	6.60
6	#5860.10	52.7 AV	54.0	-1.3	1.54 V	274	46.10	6.60
7	11650.00	62.7 PK	74.0	-11.3	1.50 V	130	45.00	17.70
8	11650.00	49.9 AV	54.0	-4.1	1.50 V	130	32.20	17.70

REMARKS:

1. Emission Level(dBuV/m) = Raw Value(dBuV) + Correction Factor(dB/m)
2. Correction Factor(dB/m) = Antenna Factor(dB/m) + Cable Factor(dB)
3. The other emission levels were very low against the limit.
4. Margin value = Emission Level – Limit value
5. " * ": Fundamental frequency.
6. " # ": The radiated frequency is out of the restricted band.

802.11n (HT40)

CHANNEL	TX Channel 151	DETECTOR FUNCTION	Peak (PK)
FREQUENCY RANGE	1GHz ~ 40GHz		Average (AV)

ANTENNA POLARITY & TEST DISTANCE: HORIZONTAL AT 3 M

NO.	FREQ. (MHz)	EMISSION LEVEL (dBuV/m)	LIMIT (dBuV/m)	MARGIN (dB)	ANTENNA HEIGHT (m)	TABLE ANGLE (Degree)	RAW VALUE (dBuV)	CORRECTION FACTOR (dB/m)
1	#5714.90	65.4 PK	74.0	-8.6	1.68 H	286	59.10	6.30
2	#5714.90	47.8 AV	54.0	-6.2	1.68 H	286	41.50	6.30
3	#5722.90	72.8 PK	78.2	-5.4	1.68 H	286	66.50	6.30
4	#5725.00	49.1 PK	78.2	-29.1	1.68 H	286	42.80	6.30
5	*5755.00	105.2 PK			1.68 H	286	64.90	40.30
6	*5755.00	95.4 AV			1.68 H	286	55.10	40.30
7	11510.00	60.1 PK	74.0	-13.9	1.00 H	67	43.00	17.10
8	11510.00	46.9 AV	54.0	-7.1	1.00 H	67	29.80	17.10

ANTENNA POLARITY & TEST DISTANCE: VERTICAL AT 3 M

NO.	FREQ. (MHz)	EMISSION LEVEL (dBuV/m)	LIMIT (dBuV/m)	MARGIN (dB)	ANTENNA HEIGHT (m)	TABLE ANGLE (Degree)	RAW VALUE (dBuV)	CORRECTION FACTOR (dB/m)
1	#5714.90	72.4 PK	74.0	-1.6	1.48 V	269	66.10	6.30
2	#5714.90	53.4 AV	54.0	-0.6	1.48 V	269	47.10	6.30
3	#5722.90	75.3 PK	78.2	-2.9	1.48 V	269	69.00	6.30
4	#5725.00	53.2 PK	78.2	-25.0	1.48 V	269	46.90	6.30
5	*5755.00	109.5 PK			1.48 V	269	69.20	40.30
6	*5755.00	99.5 AV			1.48 V	269	59.20	40.30
7	11510.00	61.7 PK	74.0	-12.3	1.56 V	136	44.60	17.10
8	11510.00	48.1 AV	54.0	-5.9	1.56 V	136	31.00	17.10

REMARKS:

1. Emission Level(dBuV/m) = Raw Value(dBuV) + Correction Factor(dB/m)
2. Correction Factor(dB/m) = Antenna Factor(dB/m) + Cable Factor(dB)
3. The other emission levels were very low against the limit.
4. Margin value = Emission Level – Limit value
5. " * ": Fundamental frequency.
6. " # ": The radiated frequency is out of the restricted band.

CHANNEL	TX Channel 159	DETECTOR FUNCTION	Peak (PK)
FREQUENCY RANGE	1GHz ~ 40GHz		Average (AV)

ANTENNA POLARITY & TEST DISTANCE: HORIZONTAL AT 3 M

NO.	FREQ. (MHz)	EMISSION LEVEL (dBuV/m)	LIMIT (dBuV/m)	MARGIN (dB)	ANTENNA HEIGHT (m)	TABLE ANGLE (Degree)	RAW VALUE (dBuV)	CORRECTION FACTOR (dB/m)
1	*5795.00	111.7 PK			1.84 H	267	71.30	40.40
2	*5795.00	101.4 AV			1.84 H	267	61.00	40.40
3	#5850.00	48.9 PK	78.2	-29.3	1.84 H	267	42.30	6.60
4	#5852.10	64.9 PK	78.2	-13.3	1.84 H	267	58.30	6.60
5	#5860.10	67.9 PK	74.0	-6.1	1.84 H	267	61.30	6.60
6	#5860.10	48.1 AV	54.0	-5.9	1.84 H	267	41.50	6.60
7	11590.00	60.0 PK	74.0	-14.0	1.00 H	63	42.80	17.20
8	11590.00	47.1 AV	54.0	-6.9	1.00 H	63	29.90	17.20

ANTENNA POLARITY & TEST DISTANCE: VERTICAL AT 3 M

NO.	FREQ. (MHz)	EMISSION LEVEL (dBuV/m)	LIMIT (dBuV/m)	MARGIN (dB)	ANTENNA HEIGHT (m)	TABLE ANGLE (Degree)	RAW VALUE (dBuV)	CORRECTION FACTOR (dB/m)
1	*5795.00	115.5 PK			1.56 V	273	75.10	40.40
2	*5795.00	105.9 AV			1.56 V	273	65.50	40.40
3	#5850.00	51.7 PK	78.2	-26.5	1.56 V	273	45.10	6.60
4	#5852.10	75.0 PK	78.2	-3.2	1.56 V	273	68.40	6.60
5	#5860.10	73.2 PK	74.0	-0.8	1.56 V	273	66.60	6.60
6	#5860.10	53.3 AV	54.0	-0.7	1.56 V	273	46.70	6.60
7	11590.00	61.7 PK	74.0	-12.3	1.51 V	133	44.50	17.20
8	11590.00	48.6 AV	54.0	-5.4	1.51 V	133	31.40	17.20

REMARKS:

1. Emission Level(dBuV/m) = Raw Value(dBuV) + Correction Factor(dB/m)
2. Correction Factor(dB/m) = Antenna Factor(dB/m) + Cable Factor(dB)
3. The other emission levels were very low against the limit.
4. Margin value = Emission Level – Limit value
5. " * ": Fundamental frequency.
6. " # ": The radiated frequency is out of the restricted band.

Below 1GHz worst-case data:

802.11a

CHANNEL	TX Channel 157	DETECTOR FUNCTION	Quasi-Peak (QP)
FREQUENCY RANGE	30MHz ~ 1GHz		

ANTENNA POLARITY & TEST DISTANCE: HORIZONTAL AT 3 M								
NO.	FREQ. (MHz)	EMISSION LEVEL (dBuV/m)	LIMIT (dBuV/m)	MARGIN (dB)	ANTENNA HEIGHT (m)	TABLE ANGLE (Degree)	RAW VALUE (dBuV)	CORRECTION FACTOR (dB/m)
1	84.23	37.0 QP	40.0	-3.0	2.00 H	199	55.80	-18.80
2	212.30	31.9 QP	43.5	-11.6	1.25 H	55	48.50	-16.60
3	324.84	29.4 QP	46.0	-16.6	1.01 H	6	41.40	-12.00
4	499.48	32.4 QP	46.0	-13.6	1.51 H	130	41.70	-9.30
5	794.42	33.0 QP	46.0	-13.0	2.00 H	328	36.10	-3.10
6	879.80	27.8 QP	46.0	-18.2	1.51 H	113	29.80	-2.00
ANTENNA POLARITY & TEST DISTANCE: VERTICAL AT 3 M								
NO.	FREQ. (MHz)	EMISSION LEVEL (dBuV/m)	LIMIT (dBuV/m)	MARGIN (dB)	ANTENNA HEIGHT (m)	TABLE ANGLE (Degree)	RAW VALUE (dBuV)	CORRECTION FACTOR (dB/m)
1	51.24	36.8 QP	40.0	-3.2	1.49 V	71	50.70	-13.90
2	86.17	36.7 QP	40.0	-3.3	1.99 V	146	55.90	-19.20
3	189.01	31.9 QP	43.5	-11.6	1.00 V	80	48.00	-16.10
4	375.29	30.0 QP	46.0	-16.0	1.00 V	253	41.40	-11.40
5	499.48	41.7 QP	46.0	-4.3	1.00 V	258	51.00	-9.30
6	747.85	33.8 QP	46.0	-12.2	1.49 V	128	37.40	-3.60

REMARKS:

1. Emission Level(dBuV/m) = Raw Value(dBuV) + Correction Factor(dB/m)
2. Correction Factor(dB/m) = Antenna Factor(dB/m) + Cable Factor(dB)
3. The other emission levels were very low against the limit.
4. Margin value = Emission Level – Limit value

4.2 Conducted Emission Measurement

4.2.1 Limits of Conducted Emission Measurement

Frequency (MHz)	Conducted Limit (dBuV)	
	Quasi-peak	Average
0.15 - 0.5	66 - 56	56 - 46
0.50 - 5.0	56	46
5.0 - 30.0	60	50

- Note:** 1. The lower limit shall apply at the transition frequencies.
 2. The limit decreases in line with the logarithm of the frequency in the range of 0.15 to 0.50MHz.

4.2.2 Test Instruments

Description & Manufacturer	Model No.	Serial No.	Date Of Calibration	Due Date Of Calibration
Test Receiver ROHDE & SCHWARZ	ESCI	100613	Nov. 11, 2014	Nov. 10, 2015
RF signal cable (with 10dB PAD) Woken	5D-FB	Cable-cond1-01	Dec. 26, 2014	Dec. 25, 2015
LISN ROHDE & SCHWARZ (EUT)	ESH3-Z5	835239/001	Feb. 26, 2015	Feb. 25, 2016
LISN ROHDE & SCHWARZ (Peripheral)	ESH3-Z5	100311	Jul. 24, 2015	Jul. 23, 2016
Software ADT	BV ADT_Cond_ V7.3.7.3	NA	NA	NA

- NOTE:** 1. The calibration interval of the above test instruments is 12 months and the calibrations are traceable to NML/ROC and NIST/USA.
 2. The test was performed in HwaYa Shielded Room 1.
 3. The VCCI Site Registration No. is C-2040.

4.2.3 Test Procedures

- The EUT was placed 0.4 meters from the conducting wall of the shielded room with EUT being connected to the power mains through a line impedance stabilization network (LISN). Other support units were connected to the power mains through another LISN. The two LISNs provide 50 ohm/ 50uH of coupling impedance for the measuring instrument.
- Both lines of the power mains connected to the EUT were checked for maximum conducted interference.
- The frequency range from 150kHz to 30MHz was searched. Emission levels under (Limit - 20dB) was not recorded.

NOTE: The resolution bandwidth and video bandwidth of test receiver is 9kHz for quasi-peak detection (QP) and average detection (AV) at frequency 0.15MHz-30MHz.

4.2.4 Deviation from Test Standard

No deviation.

4.2.5 Test Setup

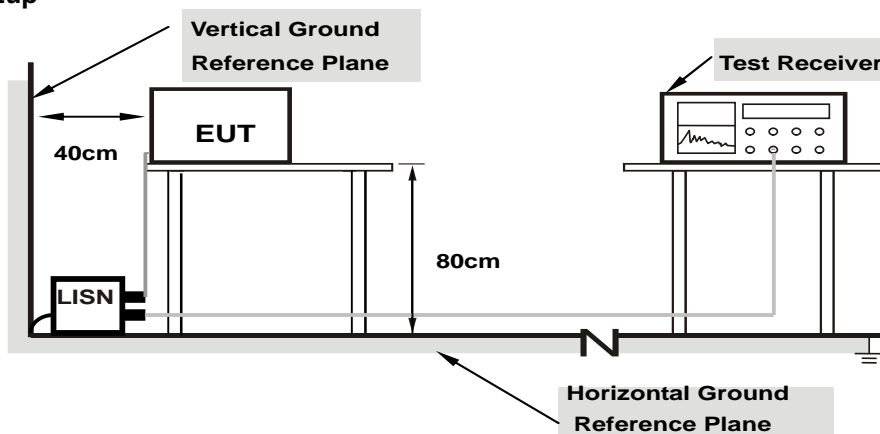

Note: 1.Support units were connected to second LISN.

For the actual test configuration, please refer to the attached file (Test Setup Photo).

4.2.6 EUT Operating Conditions

Same as 4.1.6.

4.2.7 Test Results

Phase	Line (L)	Detector Function	Quasi-Peak (QP) / Average (AV)
-------	----------	-------------------	--------------------------------

No	Freq. [MHz]	Corr. Factor (dB)	Reading Value [dB (uV)]		Emission Level [dB (uV)]		Limit [dB (uV)]		Margin (dB)	
			Q.P.	AV.	Q.P.	AV.	Q.P.	AV.	Q.P.	AV.
			1	0.16200	9.82	22.97	13.37	32.79	23.19	65.36
2	0.18600	9.83	20.00	10.02	29.83	19.85	64.21	54.21	-34.38	-34.36
3	0.23000	9.85	19.71	15.67	29.56	25.52	62.45	52.45	-32.89	-26.93
4	0.43028	9.88	18.77	11.21	28.65	21.09	57.25	47.25	-28.59	-26.15
5	5.75000	10.24	11.10	4.66	21.34	14.90	60.00	50.00	-38.66	-35.10
6	18.25800	10.99	9.99	3.14	20.98	14.13	60.00	50.00	-39.02	-35.87

REMARKS:

1. Q.P. and AV. are abbreviations of quasi-peak and average individually.
2. The emission levels of other frequencies were very low against the limit.
3. Margin value = Emission level - Limit value
4. Correction factor = Insertion loss + Cable loss
5. Emission Level = Correction Factor + Reading Value.

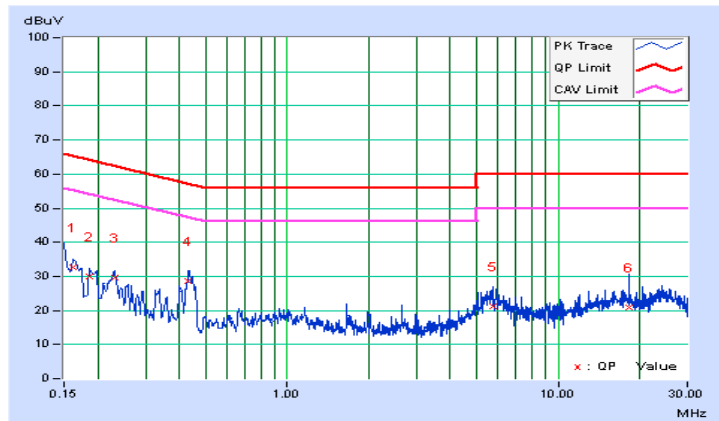

Phase	Neutral (N)	Detector Function	Quasi-Peak (QP) / Average (AV)
-------	-------------	-------------------	--------------------------------

No	Freq. [MHz]	Corr. Factor (dB)	Reading Value		Emission Level		Limit		Margin	
			[dB (uV)]		[dB (uV)]		[dB (uV)]		(dB)	
			Q.P.	AV.	Q.P.	AV.	Q.P.	AV.	Q.P.	AV.
1	0.16105	9.82	22.77	12.17	32.59	21.99	65.41	55.41	-32.82	-33.42
2	0.17000	9.82	21.49	10.59	31.31	20.41	64.96	54.96	-33.65	-34.55
3	0.23000	9.84	18.72	15.59	28.56	25.43	62.45	52.45	-33.89	-27.02
4	0.25742	9.84	13.81	3.77	23.65	13.61	61.51	51.51	-37.86	-37.90
5	0.44600	9.88	10.99	5.76	20.87	15.64	56.95	46.95	-36.08	-31.31
6	5.55800	10.22	11.02	3.35	21.24	13.57	60.00	50.00	-38.76	-36.43

REMARKS:

1. Q.P. and AV. are abbreviations of quasi-peak and average individually.
2. The emission levels of other frequencies were very low against the limit.
3. Margin value = Emission level - Limit value
4. Correction factor = Insertion loss + Cable loss
5. Emission Level = Correction Factor + Reading Value.

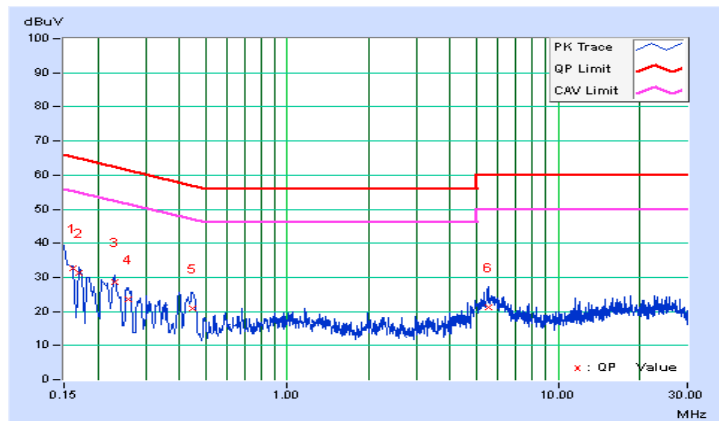

4.3 Transmit Power Measurement

4.3.1 Limits of Transmit Power Measurement

Operation Band	EUT Category	LIMIT
U-NII-1	Outdoor Access Point	1 Watt (30 dBm) (Max. e.i.r.p \leq 125mW(21 dBm) at any elevation angle above 30 degrees as measured from the horizon)
	Fixed point-to-point Access Point	1 Watt (30 dBm)
	Indoor Access Point	1 Watt (30 dBm)
	Mobile and Portable client device	250mW (24 dBm)
U-NII-2A		250mW (24 dBm) or 11 dBm+10 log B*
U-NII-2C		250mW (24 dBm) or 11 dBm+10 log B*
U-NII-3	√	1 Watt (30 dBm)

*B is the 26 dB emission bandwidth in megahertz

Per KDB 662911 Method of conducted output power measurement on IEEE 802.11 devices,

- Array Gain = 0 dB (i.e., no array gain) for $N_{ANT} \leq 4$;
- Array Gain = 0 dB (i.e., no array gain) for channel widths ≥ 40 MHz for any N_{ANT} ;
- Array Gain = $5 \log(N_{ANT}/N_{SS})$ dB or 3 dB, whichever is less for 20-MHz channel widths with $N_{ANT} \geq 5$.

For power measurements on all other devices: Array Gain = $10 \log(N_{ANT}/N_{SS})$ dB.

4.3.2 Test Setup

For Power Output Measurement

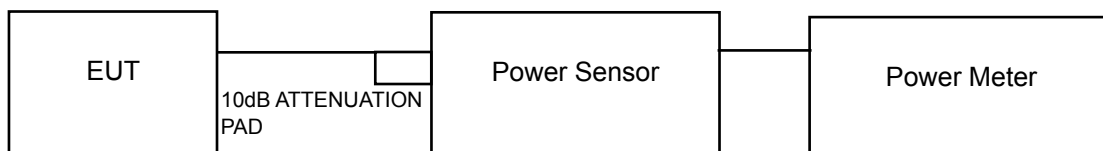

For Occupied Bandwidth

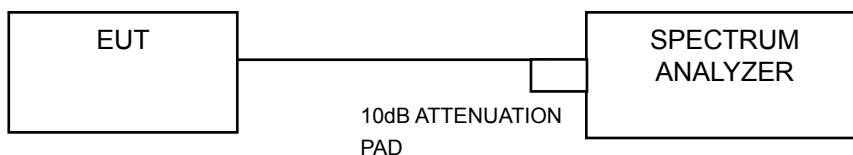

4.3.3 Test Instruments

Refer to section 4.1.2 to get information of above instrument.

4.3.4 Test Procedure

FOR AVERAGE POWER MEASUREMENT

For 802.11a, 802.11n (HT20), 802.11n (HT40)

Method PM is used to perform output power measurement, trigger and gating function of wide band power meter is enabled to measure max output power of TX on burst. Duty factor is not added to measured value.

4.3.5 Deviation from Test Standard

No deviation.

4.3.6 EUT Operating Conditions

The software provided by client to enable the EUT under transmission condition continuously at lowest, middle and highest channel frequencies individually.

4.3.7 Test Result

POWER OUTPUT:

802.11a

Chan.	Freq. (MHz)	Maximum Conducted Power (dBm)			Total Power (mW)	Total Power (dBm)	Power Limit (dBm)	Pass / Fail
		Chain 0	Chain 1	Chain 2				
149	5745	18.41	18.50	18.58	212.249	23.27	30.00	Pass
157	5785	20.84	21.02	21.27	381.781	25.82	30.00	Pass
165	5825	19.14	19.39	19.78	263.991	24.22	30.00	Pass

802.11n (HT20)

Chan.	Freq. (MHz)	Maximum Conducted Power (dBm)			Total Power (mW)	Total Power (dBm)	Power Limit (dBm)	Pass / Fail
		Chain 0	Chain 1	Chain 2				
149	5745	16.44	16.82	16.43	136.093	21.34	30.00	Pass
157	5785	20.83	21.05	21.10	377.235	25.77	30.00	Pass
165	5825	19.04	19.23	19.04	244.089	23.88	30.00	Pass

802.11n (HT40)

Chan.	Freq. (MHz)	Maximum Conducted Power (dBm)			Total Power (mW)	Total Power (dBm)	Power Limit (dBm)	Pass / Fail
		Chain 0	Chain 1	Chain 2				
151	5755	13.86	14.08	14.12	75.731	18.79	30.00	Pass
159	5795	19.59	19.57	19.86	278.392	24.45	30.00	Pass

OCCUPIED BANDWIDTH:

802.11a

Chan.	Freq. (MHz)	Occupied Bandwidth (MHz)		
		Chain 0	Chain 1	Chain 2
149	5745	17.30	16.87	16.96
157	5785	21.24	18.60	19.68
165	5825	17.88	17.40	17.40

802.11n (HT20)

Chan.	Freq. (MHz)	Occupied Bandwidth (MHz)		
		Chain 0	Chain 1	Chain 2
149	5745	18.12	17.76	17.76
157	5785	21.84	20.16	19.92
165	5825	18.48	18.00	18.24

802.11n (HT40)

Chan.	Freq. (MHz)	Occupied Bandwidth (MHz)		
		Chain 0	Chain 1	Chain 2
151	5755	37.32	37.08	36.96
159	5795	38.28	38.04	38.04

Spectrum Plot of Worst Value

802.11a

802.11n (HT20)

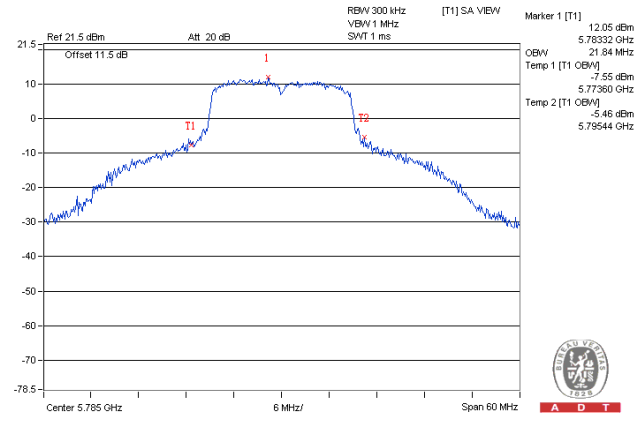
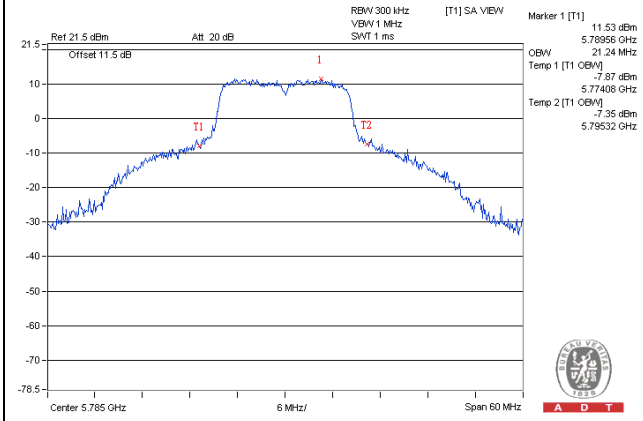

802.11n (HT40)

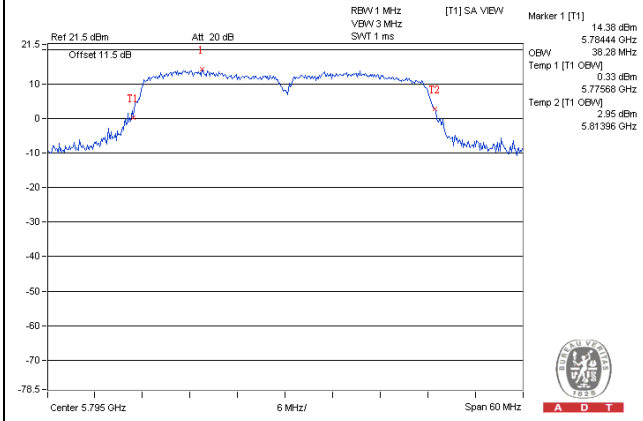

4.4 Peak Power Spectral Density Measurement

4.4.1 Limits of Peak Power Spectral Density Measurement

Operation Band	EUT Category		LIMIT
U-NII-1		Outdoor Access Point	17dBm/ MHz
		Fixed point-to-point Access Point	
		Indoor Access Point	
		Mobile and Portable client device	11dBm/ MHz
U-NII-2A			11dBm/ MHz
U-NII-2C			11dBm/ MHz
U-NII-3	√		30dBm/ 500kHz

4.4.2 Test Setup

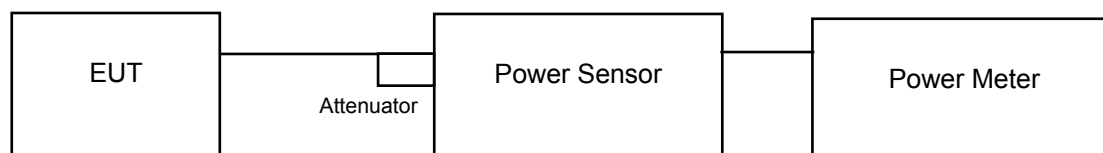

4.4.3 Test Instruments

Refer to section 4.1.2 to get information of above instrument.

4.4.4 Test Procedures

For U-NII-3 band:

- 1) Set span to encompass the entire emission bandwidth (EBW) of the signal.
- 2) Set RBW = 300 kHz, Set VBW ≥ 1 MHz, Detector = RMS
- 3) Use the peak marker function to determine the maximum power level in any 300 kHz band segment within the fundamental EBW.
- 4) Scale the observed power level to an equivalent value in 500 kHz by adjusting (reducing) the measured power by a bandwidth correction factor (BWCF) where $BWCF = 10\log(500\text{kHz}/300\text{kHz})$
- 5) Sweep time = auto, trigger set to “free run”.
- 6) Trace average at least 100 traces in power averaging mode.
- 7) Record the max value and add $10 \log (1/\text{duty cycle})$

4.4.5 Deviation from Test Standard

No deviation.

4.4.6 EUT Operating Conditions

Same as Item 4.3.6.

4.4.7 Test Results

For U-NII-3 Band

802.11a

TX chain	Chan.	Freq. (MHz)	PSD (dBm/300 kHz)	PSD (dBm/500 kHz)	10 log (N=3) dB	Duty factor	Total PSD (dBm/500 kHz)	Limit (dBm/500 kHz)	Pass / Fail
0	149	5745	-2.46	-0.24	4.77	0.12	4.65	28.10	Pass
	157	5785	-0.81	1.41	4.77	0.12	6.30	28.10	Pass
	165	5825	-1.88	0.34	4.77	0.12	5.23	28.10	Pass
1	149	5745	-2.48	-0.26	4.77	0.12	4.63	28.10	Pass
	157	5785	-0.43	1.79	4.77	0.12	6.68	28.10	Pass
	165	5825	-0.76	1.46	4.77	0.12	6.35	28.10	Pass
2	149	5745	-2.94	-0.72	4.77	0.12	4.17	28.10	Pass
	157	5785	-1.02	1.20	4.77	0.12	6.09	28.10	Pass
	165	5825	-1.65	0.57	4.77	0.12	5.46	28.10	Pass

Note:

- Method 1 of power density measurement of KDB 662911 is using for calculating total power density. Total power density is summing entire spectra across corresponding frequency bins on the various outputs by computer.
- Directional gain = $10 \log[(10^{G1/20} + 10^{G2/20} + \dots + 10^{GN/20})^2/3] = 7.9 \text{ dBi} > 6 \text{ dBi}$, so the power density limit shall be reduced to $30 - (7.9 - 6) = 28.10 \text{ dBm}$.
- Refer to section 3.3 for duty cycle spectrum plot.

802.11n (HT20)

TX chain	Chan.	Freq. (MHz)	PSD (dBm/300 kHz)	PSD (dBm/500 kHz)	10 log (N=3) dB	Duty factor	Total PSD (dBm/500 kHz)	Limit (dBm/500 kHz)	Pass / Fail
0	149	5745	-4.81	-2.59	4.77	0.13	2.31	28.10	Pass
	157	5785	-0.97	1.25	4.77	0.13	6.15	28.10	Pass
	165	5825	-2.43	-0.21	4.77	0.13	4.69	28.10	Pass
1	149	5745	-4.87	-2.65	4.77	0.13	2.25	28.10	Pass
	157	5785	-0.83	1.39	4.77	0.13	6.29	28.10	Pass
	165	5825	-1.14	1.08	4.77	0.13	5.98	28.10	Pass
2	149	5745	-5.32	-3.10	4.77	0.13	1.80	28.10	Pass
	157	5785	-0.78	1.44	4.77	0.13	6.34	28.10	Pass
	165	5825	-2.05	0.17	4.77	0.13	5.07	28.10	Pass

Note:

- Method 1 of power density measurement of KDB 662911 is using for calculating total power density. Total power density is summing entire spectra across corresponding frequency bins on the various outputs by computer.
- Directional gain = $10 \log[(10^{G1/20} + 10^{G2/20} + \dots + 10^{GN/20})^2/3] = 7.9 \text{ dBi} > 6 \text{ dBi}$, so the power density limit shall be reduced to $30 - (7.9 - 6) = 28.10 \text{ dBm}$.
- Refer to section 3.3 for duty cycle spectrum plot.

802.11n (HT40)

TX chain	Chan.	Freq. (MHz)	PSD (dBm/300 kHz)	PSD (dBm/500 kHz)	10 log (N=3) dB	Duty factor	Total PSD (dBm/500 kHz)	Limit (dBm/500 kHz)	Pass / Fail
0	151	5755	-11.55	-9.33	4.77	0.15	-4.41	28.10	Pass
	159	5795	-4.86	-2.64	4.77	0.15	2.28	28.10	Pass
1	151	5755	-11.44	-9.22	4.77	0.15	-4.30	28.10	Pass
	159	5795	-4.59	-2.37	4.77	0.15	2.55	28.10	Pass
2	151	5755	-12.15	-9.93	4.77	0.15	-5.01	28.10	Pass
	159	5795	-4.93	-2.71	4.77	0.15	2.21	28.10	Pass

Note:

- Method 1 of power density measurement of KDB 662911 is using for calculating total power density. Total power density is summing entire spectra across corresponding frequency bins on the various outputs by computer.
- Directional gain = $10 \log[(10^{G1/20} + 10^{G2/20} + \dots + 10^{GN/20})^2/3] = 7.9 \text{ dBi} > 6\text{dBi}$, so the power density limit shall be reduced to $30 - (7.9 - 6) = 28.10\text{dBm}$.
- Refer to section 3.3 for duty cycle spectrum plot.

Spectrum Plot of Worst Value

802.11a / Ch 157 / chain 1

802.11n (HT20) / Ch 157 / chain 2

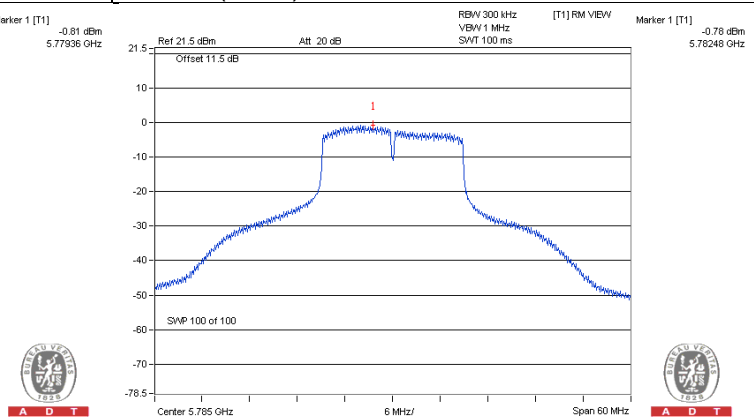
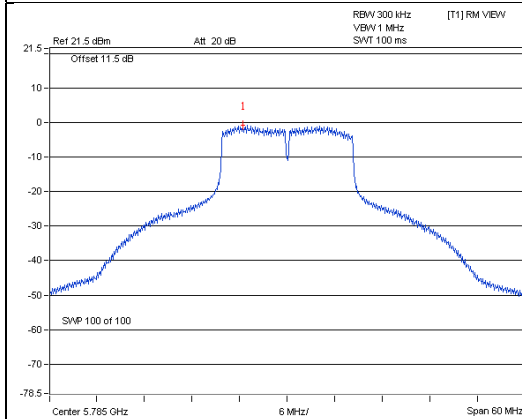

802.11n (HT40) / Ch 159 / chain 1

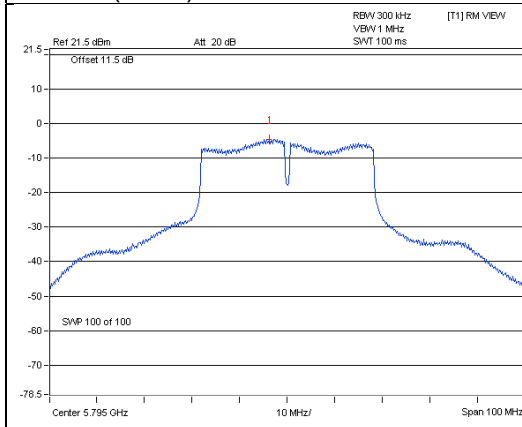

4.5 Frequency Stability

4.5.1 Limits of Frequency Stability Measurement

The frequency of the carrier signal shall be maintained within band of operation

4.5.2 Test Setup

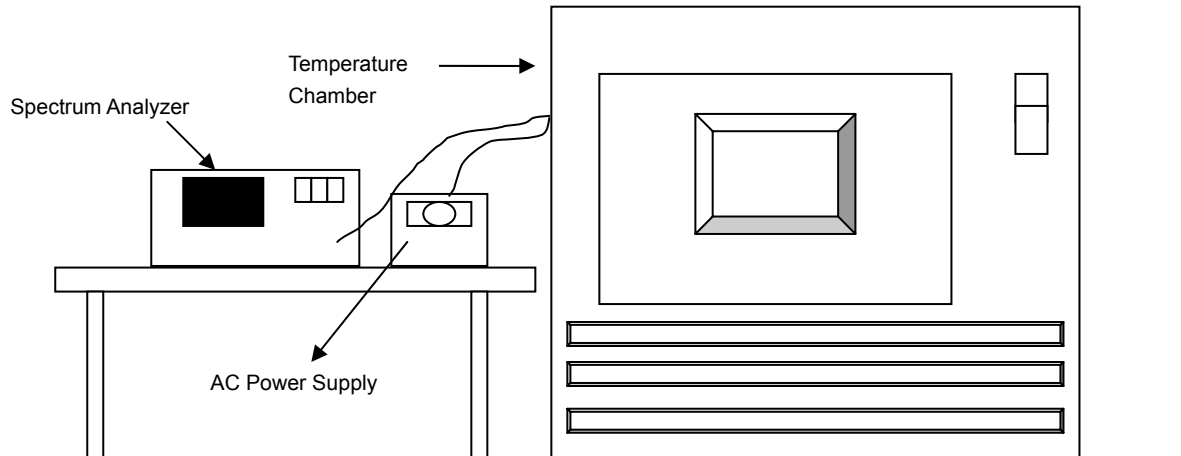

4.5.3 Test Instruments

Refer to section 4.1.2 to get information of above instrument.

4.5.4 Test Procedure

- a. The EUT was placed inside the environmental test chamber and powered by nominal AC voltage.
- b. Turn the EUT on and couple its output to a spectrum analyzer.
- c. Turn the EUT off and set the chamber to the highest temperature specified.
- d. Allow sufficient time (approximately 30 min) for the temperature of the chamber to stabilize, turn the EUT on and measure the operating frequency after 2, 5, and 10 minutes.
- e. Repeat step 2 and 3 with the temperature chamber set to the lowest temperature.
- f. The test chamber was allowed to stabilize at +20 degree C for a minimum of 30 minutes. The supply voltage was then adjusted on the EUT from 85% to 115% and the frequency record.

4.5.5 Deviation from Test Standard

No deviation.

4.5.6 EUT Operating Condition

Set the EUT transmit at un-modulation mode to test frequency stability.

4.5.7 Test Results

Frequency Stability Versus Temp.									
Operating Frequency: 5745MHz									
Temp. (°C)	Power Supply (Vac)	0 Minute		2 Minute		5 Minute		10 Minute	
		Measured Frequency (MHz)	Frequency Drift (%)	Measured Frequency (MHz)	Frequency Drift (%)	Measured Frequency (MHz)	Frequency Drift (%)	Measured Frequency (MHz)	Frequency Drift (%)
50	120	5744.9856	-0.00025	5744.9811	-0.00033	5744.9838	-0.00028	5744.9845	-0.00027
40	120	5744.9749	-0.00044	5744.9748	-0.00044	5744.9710	-0.00050	5744.9728	-0.00047
30	120	5745.0274	0.00048	5745.0287	0.00050	5745.0287	0.00050	5745.0305	0.00053
20	120	5745.0110	0.00019	5745.0095	0.00017	5745.0122	0.00021	5745.0132	0.00023
10	120	5744.9898	-0.00018	5744.9910	-0.00016	5744.9910	-0.00016	5744.9917	-0.00014
0	120	5745.0185	0.00032	5745.0164	0.00029	5745.0199	0.00035	5745.0188	0.00033
-10	120	5745.0251	0.00044	5745.0226	0.00039	5745.0239	0.00042	5745.0236	0.00041
-20	120	5744.9817	-0.00032	5744.9782	-0.00038	5744.9772	-0.00040	5744.9786	-0.00037
-30	120	5744.9879	-0.00021	5744.9901	-0.00017	5744.9868	-0.00023	5744.9869	-0.00023

Frequency Stability Versus Temp.									
Operating Frequency: 5745MHz									
Temp. (°C)	Power Supply (Vac)	0 Minute		2 Minute		5 Minute		10 Minute	
		Measured Frequency (MHz)	Frequency Drift (%)	Measured Frequency (MHz)	Frequency Drift (%)	Measured Frequency (MHz)	Frequency Drift (%)	Measured Frequency (MHz)	Frequency Drift (%)
20	138	5745.0107	0.00019	5745.0097	0.00017	5745.0126	0.00022	5745.0127	0.00022
	120	5745.0110	0.00019	5745.0095	0.00017	5745.0122	0.00021	5745.0132	0.00023
	102	5745.0104	0.00018	5745.0097	0.00017	5745.0127	0.00022	5745.0128	0.00022

4.6 6dB Bandwidth Measurement

4.6.1 Limits of 6dB Bandwidth Measurement

The minimum of 6dB Bandwidth Measurement is 0.5MHz.

4.6.2 Test Setup

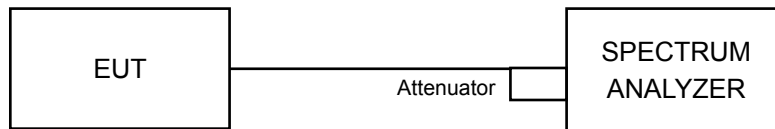

4.6.3 Test Instruments

Refer to section 4.1.2 to get information of above instrument.

4.6.4 Test Procedure

MEASUREMENT PROCEDURE REF

- Set resolution bandwidth (RBW) = 100kHz
- Set the video bandwidth (VBW) $\geq 3 \times$ RBW, Detector = Peak.
- Trace mode = max hold.
- Sweep = auto couple.
- Measure the maximum width of the emission that is constrained by the frequencies associated with the two amplitude points (upper and lower) that are attenuated by 6 dB relative to the maximum level measured in the fundamental emission

4.6.5 Deviation from Test Standard

No deviation.

4.6.6 EUT Operating Condition

The software provided by client to enable the EUT under transmission condition continuously at lowest, middle and highest channel frequencies individually.

4.6.7 Test Results

802.11a

Channel	Frequency (MHz)	6dB Bandwidth (MHz)			Minimum Limit (MHz)	Pass / Fail
		Chain 0	Chain 1	Chain 2		
149	5745	16.08	15.96	16.37	0.5	Pass
157	5785	16.35	16.32	15.79	0.5	Pass
165	5825	16.38	16.37	15.78	0.5	Pass

802.11n (HT20)

Channel	Frequency (MHz)	6dB Bandwidth (MHz)			Minimum Limit (MHz)	Pass / Fail
		Chain 0	Chain 1	Chain 2		
149	5745	16.98	16.70	16.97	0.5	Pass
157	5785	16.73	16.33	16.44	0.5	Pass
165	5825	17.27	15.20	16.40	0.5	Pass

802.11n (HT40)

Channel	Frequency (MHz)	6dB Bandwidth (MHz)			Minimum Limit (MHz)	Pass / Fail
		Chain 0	Chain 1	Chain 2		
151	5755	35.76	35.83	35.64	0.5	Pass
159	5795	35.88	35.87	35.32	0.5	Pass

Spectrum Plot of Worst Value

802.11a

802.11n (HT20)

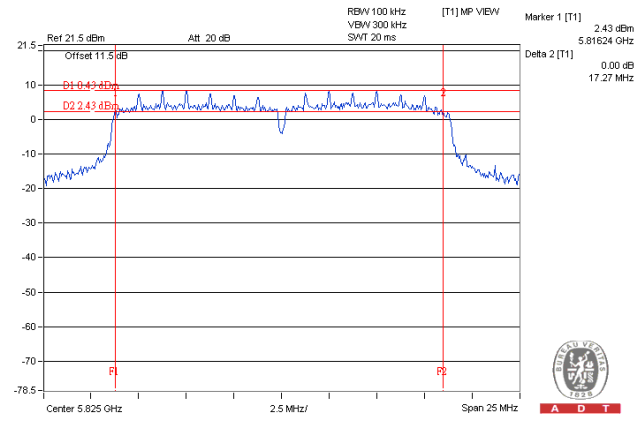
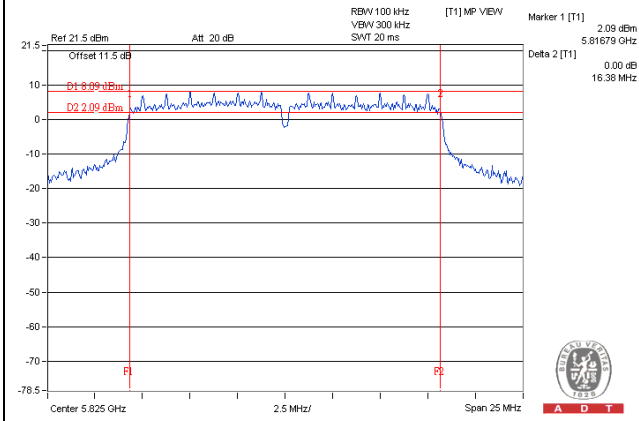

802.11n (HT40)

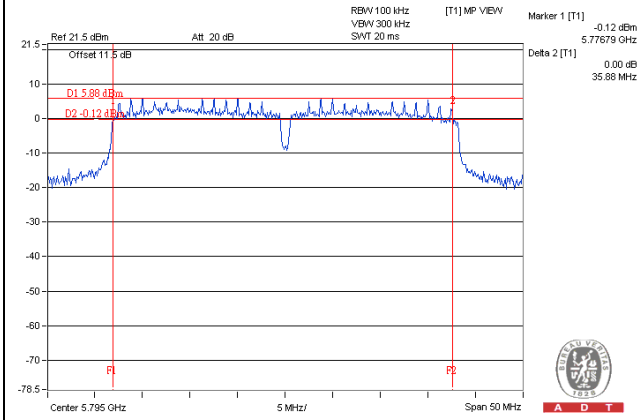

5 Pictures of Test Arrangements

Please refer to the attached file (Test Setup Photo).



Appendix – Information on the Testing Laboratories

We, Bureau Veritas Consumer Products Services (H.K.) Ltd., Taoyuan Branch, were founded in 1988 to provide our best service in EMC, Radio, Telecom and Safety consultation. Our laboratories are accredited and approved according to ISO/IEC 17025.

If you have any comments, please feel free to contact us at the following:

Linko EMC/RF Lab

Tel: 886-2-26052180

Fax: 886-2-26051924

Hsin Chu EMC/RF Lab/Telecom Lab

Tel: 886-3-5935343

Fax: 886-3-5935342

Hwa Ya EMC/RF/Safety

Tel: 886-3-3183232

Fax: 886-3-3270892

Email: service.adt@tw.bureauveritas.com

Web Site: www.bureauveritas-adt.com

The address and road map of all our labs can be found in our web site also.

--- END ---