

FCC Test Report

FCC ID : PY314200274
Equipment : AC1200 Smart WiFi Router with External Antennas
Model No. : R6220
Brand Name : NETGEAR
Applicant : NETGEAR, Inc.
Address : 350 East Plumeria Drive, San Jose, California 95134, USA
Standard : 47 CFR FCC Part 15.247
Received Date : Aug. 07, 2014
Tested Date : Aug. 27 ~ Sep. 09, 2014

We, International Certification Corp., would like to declare that the tested sample has been evaluated and in compliance with the requirement of the above standards. The test results contained in this report refer exclusively to the product. It may be duplicated completely for legal use with the approval of the applicant. It shall not be reproduced except in full without the written approval of our laboratory.

Approved & Reviewed by:



Gary Chang / Manager



Table of Contents

1	GENERAL DESCRIPTION	5
1.1	Information.....	5
1.2	Local Support Equipment List	8
1.3	Test Setup Chart	8
1.4	The Equipment List	9
1.5	Test Standards	10
1.6	Measurement Uncertainty	10
2	TEST CONFIGURATION	11
2.1	Testing Condition	11
2.2	The Worst Test Modes and Channel Details	11
3	TRANSMITTER TEST RESULTS.....	12
3.1	Conducted Emissions.....	12
3.2	6dB and Occupied Bandwidth	15
3.3	RF Output Power	18
3.4	Power Spectral Density	20
3.5	Unwanted Emissions into Restricted Frequency Bands	22
3.6	Emissions in Non-Restricted Frequency Bands	50
4	TEST LABORATORY INFORMATION	63

Release Record

Report No.	Version	Description	Issued Date
FR480702AC	Rev. 01	Initial issue	Sep. 22, 2014

Summary of Test Results

FCC Rules	Test Items	Measured	Result
15.207	Conducted Emissions	[dBuV]: 0.154MHz 51.33 (Margin -4.45dB) - AV	Pass
15.247(d) 15.209	Radiated Emissions	[dBuV/m at 3m]: 2483.50MHz 53.90 (Margin -0.10dB) - AV	Pass
15.247(b)(3)	Fundamental Emission Output Power	Max Power [dBm]: 24.39	Pass
15.247(a)(2)	6dB Bandwidth	Meet the requirement of limit	Pass
15.247(e)	Power Spectral Density	Meet the requirement of limit	Pass
15.203	Antenna Requirement	Meet the requirement of limit	Pass

1 General Description

1.1 Information

1.1.1 Specification of the Equipment under Test (EUT)

RF General Information					
Frequency Range (MHz)	IEEE Std. 802.11	Ch. Freq. (MHz)	Channel Number	Transmit Chains (N _{TX})	Data Rate / MCS
2400-2483.5	b	2412-2462	1-11 [11]	2	1-11 Mbps
2400-2483.5	g	2412-2462	1-11 [11]	2	6-54 Mbps
2400-2483.5	n (HT20)	2412-2462	1-11 [11]	2	MCS 0-15
2400-2483.5	n (HT40)	2422-2452	3-9 [7]	2	MCS 0-15

Note 1: RF output power specifies that Maximum Conducted (Average) Output Power.
 Note 2: 802.11b uses a combination of DSSS-DBPSK, DQPSK, CCK modulation.
 Note 3: 802.11g/n uses a combination of OFDM-BPSK, QPSK, 16QAM, 64QAM modulation.

1.1.2 Antenna Details

Ant. No.	Model	Type	Connector	Antenna Gain (dBi)		
				2400~2483.5MHz	5150~5250 MHz	5725~5850 MHz
1	R6220	Dipole	I-PEX	3.48	3.09	3.56

1.1.3 Power Supply Type of Equipment under Test (EUT)

Power Supply Type	12Vdc from AC adapter
--------------------------	-----------------------

1.1.4 Accessories

Accessories		
No.	Equipment	Description
1	AC Adapter 1	Brand Name: NETGEAR Model Name: AD817F10 Power Rating: I/P: 100-120Vac, 50-60Hz, 0.56A O/P: 12Vdc, 1.5A Power Line: 1.8m non-shielded cable w/o core
2	AC Adapter 2	Brand Name: NETGEAR Model Name: SAL018F1 NA Power Rating: I/P: 100-120Vac, 47-63Hz, 0.6A O/P: 12Vdc, 1.5A Power Line: 1.8m non-shielded cable w/o core
3	RJ45 cable 1	Brand Name: Nienyi Industrial Corporation Model Name: SMDR02GB0010 1.5m non-shielded w/o core.
4	RJ45 cable 2	Brand Name: D & S Model Name: NYA2667 1.5m non-shielded w/o core.

1.1.5 Channel List

Frequency band (MHz)		2400~2483.5	
802.11 b / g / n HT20		802.11n HT40	
Channel	Frequency(MHz)	Channel	Frequency(MHz)
1	2412	3	2422
2	2417	4	2427
3	2422	5	2432
4	2427	6	2437
5	2432	7	2442
6	2437	8	2447
7	2442	9	2452
8	2447	---	---
9	2452	---	---
10	2457	---	---
11	2462	---	---

1.1.6 Test Tool and Duty Cycle

Test Tool	MT7603QA, version0.0.0.50		
Duty Cycle and Duty Factor	Mode	Duty cycle (%)	Duty factor (dB)
	11b	100.00%	0.00
	11g	92.06%	0.36
	HT20	91.05%	0.41
	HT40	82.61%	0.83

1.1.7 Power Setting

Modulation Mode	Test Frequency (MHz)	Power Set
11b	2412	20
11b	2437	20
11b	2462	20
11g	2412	1A
11g	2437	25
11g	2462	1A
HT20	2412	19
HT20	2437	25
HT20	2462	19
HT40	2422	13
HT40	2437	1E
HT40	2452	14

1.2 Local Support Equipment List

Support Equipment List						
No.	Equipment	Brand	Model	S/N	FCC ID	Signal cable / Length (m)
1	Notebook	DELL	E6430	---	DoC	RJ45, 8m non-shielded w/o core.

1.3 Test Setup Chart

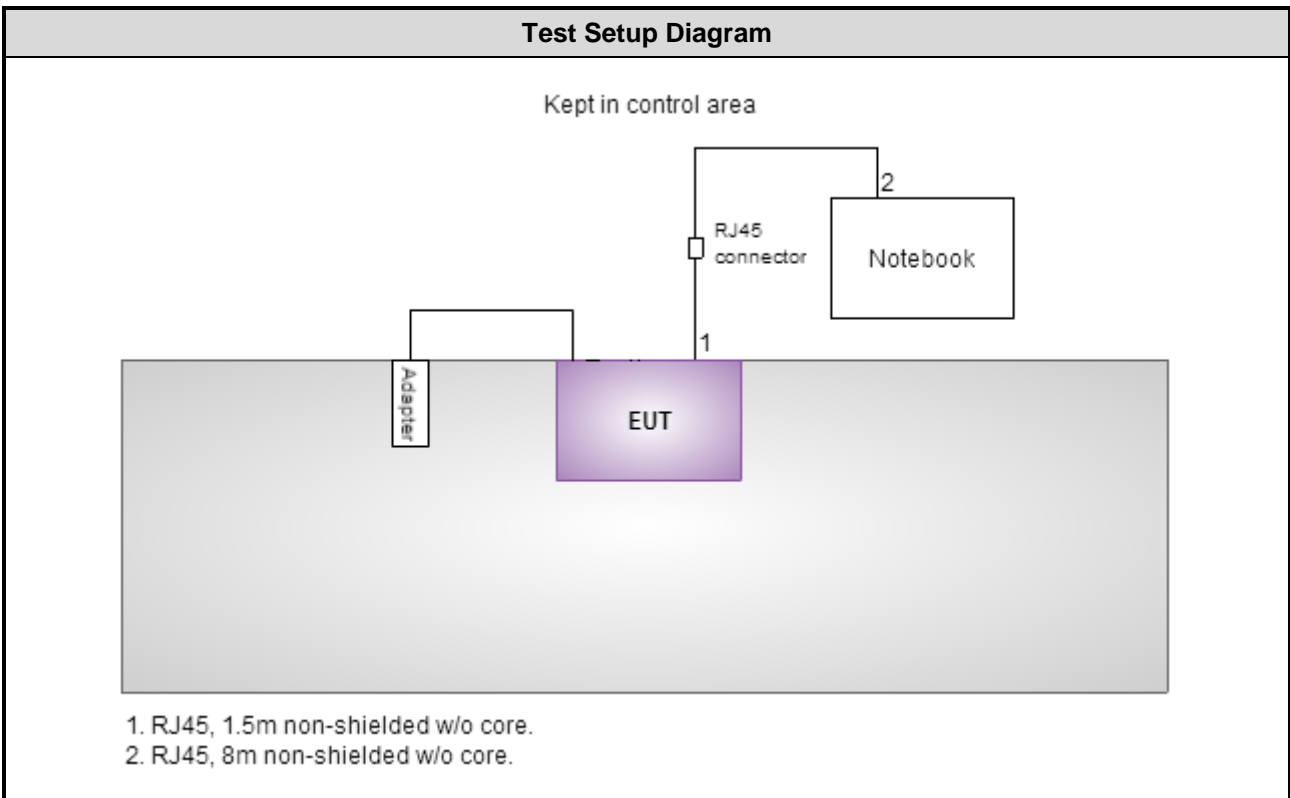

1.4 The Equipment List

Test Item	Conducted Emission				
Test Site	Conduction room 1 / (CO01-WS)				
Instrument	Manufacturer	Model No.	Serial No.	Calibration Date	Calibration Until
EMC Receiver	R&S	ESCS 30	100169	Oct. 15, 2013	Oct. 14, 2014
LISN	SCHWARZBECK	Schwarzbeck 8127	8127-667	Nov. 23, 2013	Nov. 22, 2014
LISN (Support Unit)	SCHWARZBECK	Schwarzbeck 8127	8127-666	Dec. 04, 2013	Dec. 03, 2014
RF Cable-CON	Woken	CFD200-NL	CFD200-NL-001	Apr. 23, 2014	Apr. 22, 2015
50 ohm terminal (Support Unit)	NA	50	04	Apr. 18, 2014	Apr. 17, 2015
Note: Calibration Interval of instruments listed above is one year.					

Test Item	Radiated Emission				
Test Site	966 chamber 3 / (03CH03-WS)				
Instrument	Manufacturer	Model No.	Serial No.	Calibration Date	Calibration Until
Spectrum Analyzer	Agilent	N9010A	MY53400091	Oct. 07, 2013	Oct. 06, 2014
Receiver	Agilent	N9038A	MY53290044	Jan. 08, 2014	Jan. 07, 2015
Bilog Antenna	SCHWARZBECK	VULB9168	VULB9168-562	Feb. 07, 2014	Feb. 06, 2015
Horn Antenna 1G-18G	SCHWARZBECK	BBHA 9120 D	BBHA 9120 D 1206	Feb. 20, 2014	Feb. 19, 2015
Horn Antenna 18G-40G	SCHWARZBECK	BBHA 9170	BBHA 9170517	Dec. 27, 2013	Dec. 26, 2014
Preamplifier	EMC	EMC02325	980187	Nov. 22, 2013	Nov. 21, 2014
Preamplifier	Agilent	83017A	MY53270014	Nov. 22, 2013	Nov. 21, 2014
Preamplifier	WM	TF-130N-R1	923365	Oct. 23, 2013	Oct. 22, 2014
RF cable-3M	HUBER+SUHNER	SUCOFLEX104	MY22620/4	Feb. 19, 2014	Feb. 18, 2015
RF cable-8M	HUBER+SUHNER	SUCOFLEX104	MY22601/4	Feb. 19, 2014	Feb. 18, 2015
RF cable-1M	HUBER+SUHNER	SUCOFLEX104	MY22624/4	Feb. 19, 2014	Feb. 18, 2015
LF cable-0.8M	EMC	EMC8D-NM-NM-800	EMC8D-NM-NM-800-001	Feb. 17, 2014	Feb. 16, 2015
LF cable-3M	EMC	EMC8D-NM-NM-3000	131103	Feb. 17, 2014	Feb. 16, 2015
LF cable-13M	EMC	EMC8D-NM-NM-13000	131104	Feb. 17, 2014	Feb. 16, 2015
Note: Calibration Interval of instruments listed above is one year.					

Loop Antenna	R&S	HFH2-Z2	100330	Nov. 15, 2012	Nov. 14, 2014
Note: Calibration Interval of instruments listed above is two year.					

Test Item	RF Conducted				
Test Site	(TH01-WS)				
Instrument	Manufacturer	Model No.	Serial No.	Calibration Date	Calibration Until
Spectrum Analyzer	R&S	FSV40	101063	Feb. 17, 2014	Feb. 16, 2015
Power Meter	Anritsu	ML2495A	1241002	Oct. 24, 2013	Oct. 23, 2014
Power Sensor	Anritsu	MA2411B	1207366	Oct. 24, 2013	Oct. 23, 2014
Note: Calibration Interval of instruments listed above is one year.					

1.5 Test Standards

According to the specification of EUT, the EUT must comply with following standards and KDB documents.

47 CFR FCC Part 15.247

ANSI C63.10-2009

FCC KDB 558074 D01 DTS Meas Guidance v03r02

FCC KDB 662911 D01 Multiple Transmitter Output v02r01

1.6 Measurement Uncertainty

ISO/IEC 17025 requires that an estimate of the measurement uncertainties associated with the emissions test results be included in the report. The measurement uncertainties given below are based on a 95% confidence level (based on a coverage factor (k=2))

Measurement Uncertainty	
Parameters	Uncertainty
Bandwidth	±34.134 Hz
Conducted power	±0.808 dB
Frequency error	±34.134 Hz
Temperature	±0.6 °C
Conducted emission	±2.670 dB
AC conducted emission	±2.92 dB
Radiated emission ≤ 1GHz	±3.26 dB
Radiated emission > 1GHz	±4.94 dB

2 Test Configuration

2.1 Testing Condition

Test Item	Test Site	Ambient Condition	Tested By
AC Conduction	CO01-WS	20°C / 60%	Skys Huang
Radiated Emissions	03CH03-WS	20-21°C / 61%	Anderson Hong Aska Huang
RF Conducted	TH01-WS	22°C / 62%	Brad Wu

➤ FCC site registration No.: 390588

➤ IC site registration No.: 10807C-1

2.2 The Worst Test Modes and Channel Details

Test item	Modulation Mode	Test Frequency (MHz)	Data Rate (Mbps) / MCS	Test Configuration
Conducted Emissions	11g	2437	6 Mbps	2
Radiated Emissions ≤1GHz	11g	2437	6 Mbps	1
Radiated Emissions >1GHz	11b	2412 / 2437 / 2462	1 Mbps	1
Fundamental Emission Output Power	11g	2412 / 2437 / 2462	6 Mbps	
6dB bandwidth	HT20	2412 / 2437 / 2462	MCS 0	
Power spectral density	HT40	2422 / 2437 / 2452	MCS 0	

NOTE:

- The EUT was pretested with 3 orientations placed on the table for the radiated emission measurement – X, Y, and Z-plane. The **Y-plane** result was found as the worst case and was shown in this report.
- 2 adapters are used for this device. Each adapter had been pretested and was selected for final test as below test configuration.
- RJ45 cable 1 (Model: SMDR02GB0010) and RJ45 cable 2 (Model: NYA2667) had been covered during the pretest. The worst RJ45 cable is **RJ45 cable 1 (Model: SMDR02GB0010)**, and only its data was record in this test report.
- Test configurations are listed as below:
 - Configuration 1: Adapter 1 (Model: AD817F10), RJ45 cable 1 (Model: SMDR02GB0010)
 - Configuration 2: Adapter 2 (Model: SAL018F1 NA), RJ45 cable 1 (Model: SMDR02GB0010)

3 Transmitter Test Results

3.1 Conducted Emissions

3.1.1 Limit of Conducted Emissions

Conducted Emissions Limit		
Frequency Emission (MHz)	Quasi-Peak	Average
0.15-0.5	66 - 56 *	56 - 46 *
0.5-5	56	46
5-30	60	50

Note 1: * Decreases with the logarithm of the frequency.

3.1.2 Test Procedures

1. The device is placed on a test table, raised 80 cm above the reference ground plane. The vertical conducting plane is located 40 cm to the rear of the device.
2. The device is connected to line impedance stabilization network (LISN) and other accessories are connected to other LISN. Measured levels of AC power line conducted emission are across the 50 Ω LISN port.
3. AC conducted emission measurements is made over frequency range from 150 kHz to 30 MHz.
4. This measurement was performed with AC 120V / 60Hz.

3.1.3 Test Setup

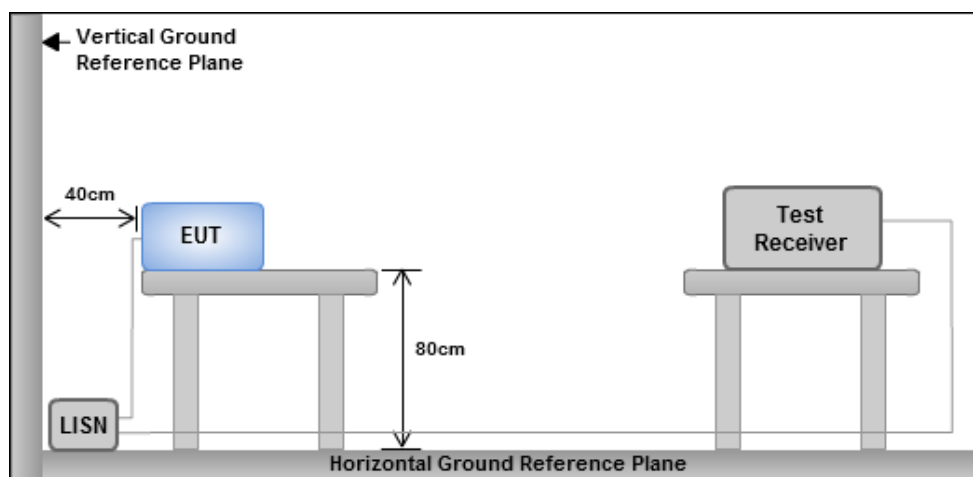

- Note: 1. Support units were connected to second LISN.
 2. Both of LISNs (AMN) are 80 cm from EUT and at least 80 cm from other units and other metal planes

3.1.4 Test Result of Conducted Emissions

Modulation	11g	Test Freq. (MHz)	2437
Power Phase	Line		

Date: 2014-09-09

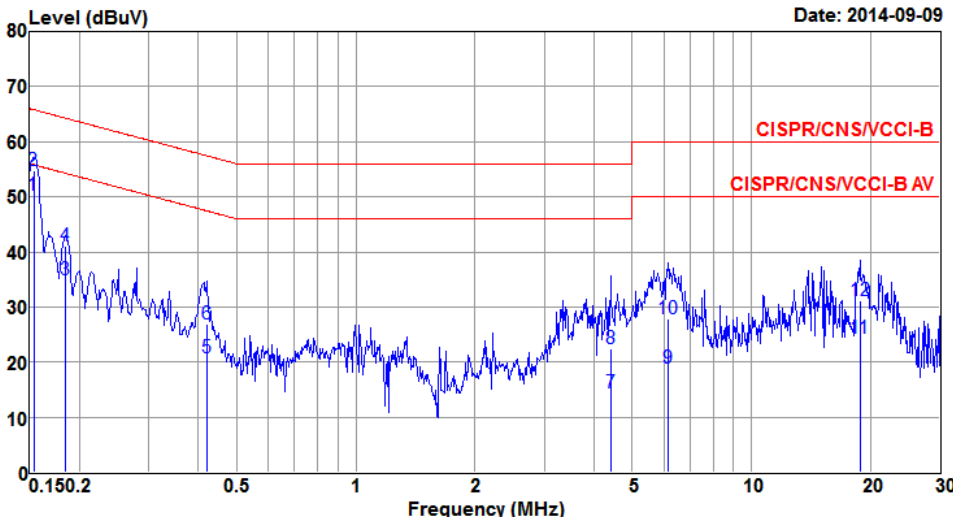

	Freq MHz	Level dBuV	Limit Line dBuV	Over Limit dB	Read Level dBuV	LISN factor dB	cable loss dB	Remark
1*	0.153	50.27	55.82	-5.55	49.84	0.41	0.02	Average
2	0.153	54.82	65.82	-11.00	54.39	0.41	0.02	QP
3	0.184	34.93	54.28	-19.35	34.50	0.42	0.01	Average
4	0.184	41.03	64.28	-23.25	40.60	0.42	0.01	QP
5	0.421	20.66	47.42	-26.76	20.09	0.54	0.03	Average
6	0.421	27.00	57.42	-30.42	26.43	0.54	0.03	QP
7	4.407	14.50	46.00	-31.50	13.20	1.14	0.16	Average
8	4.407	22.32	56.00	-33.68	21.02	1.14	0.16	QP
9	6.153	18.89	50.00	-31.11	17.32	1.37	0.20	Average
10	6.153	27.83	60.00	-32.17	26.26	1.37	0.20	QP
11	18.820	24.39	50.00	-25.61	21.95	2.06	0.38	Average
12	18.820	31.21	60.00	-28.79	28.77	2.06	0.38	QP

Note 1: Level (dBuV) = Read Level (dBuV) + LISN Factor (dB) + Cable Loss (dB).
 Note 2: Over Limit (dB) = Level (dBuV) – Limit Line (dBuV).

Modulation	11g	Test Freq. (MHz)	2437
Power Phase	Neutral		

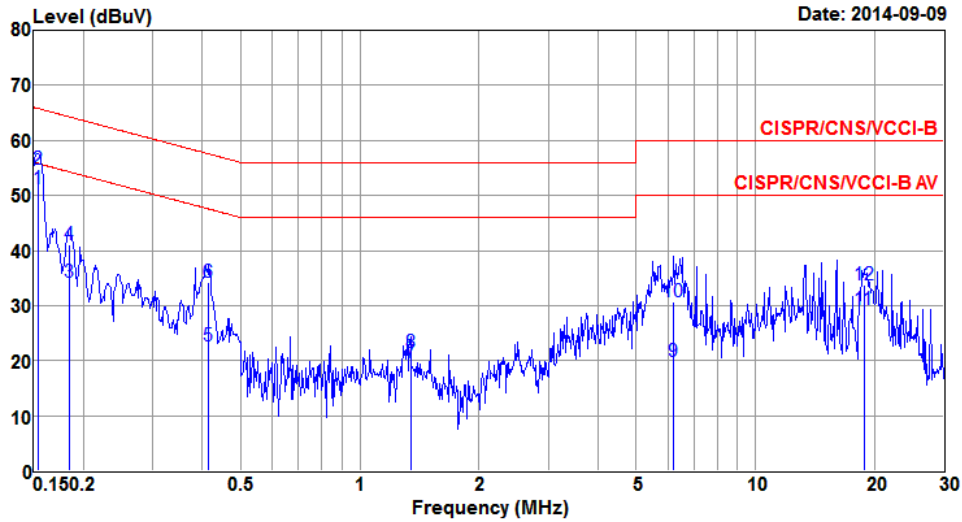

	Freq MHz	Level dBuV	Limit Line dBuV	Over Limit dB	Read Level dBuV	LISN factor dB	cable loss dB	Remark
1*	0.154	51.33	55.78	-4.45	50.82	0.49	0.02	Average
2	0.154	54.72	65.78	-11.06	54.21	0.49	0.02	QP
3	0.184	34.15	54.28	-20.13	33.64	0.50	0.01	Average
4	0.184	40.99	64.28	-23.29	40.48	0.50	0.01	QP
5	0.413	22.60	47.59	-24.99	21.95	0.62	0.03	Average
6	0.413	34.13	57.59	-23.46	33.48	0.62	0.03	QP
7	1.345	19.54	46.00	-26.46	18.50	0.92	0.12	Average
8	1.345	21.42	56.00	-34.58	20.38	0.92	0.12	QP
9	6.219	19.93	50.00	-30.07	18.32	1.41	0.20	Average
10	6.219	30.72	60.00	-29.28	29.11	1.41	0.20	QP
11	18.820	29.31	50.00	-20.69	26.40	2.53	0.38	Average
12	18.820	33.74	60.00	-26.26	30.83	2.53	0.38	QP

Note 1: Level (dBuV) = Read Level (dBuV) + LISN Factor (dB) + Cable Loss (dB).
 2: Over Limit (dB) = Level (dBuV) – Limit Line (dBuV).

3.2 6dB and Occupied Bandwidth

3.2.1 Limit of 6dB Bandwidth

The minimum 6dB bandwidth shall be at least 500 kHz.

3.2.2 Test Procedures

1. Set resolution bandwidth (RBW) = 100 kHz, Video bandwidth = 300 kHz.
2. Detector = Peak, Trace mode = max hold.
3. Sweep = auto couple, Allow the trace to stabilize.
4. Measure the maximum width of the emission that is constrained by the frequencies associated with the two outermost amplitude points (upper and lower) that are attenuated by 6dB relative to the maximum level measured in the fundamental emission.

3.2.3 Test Setup

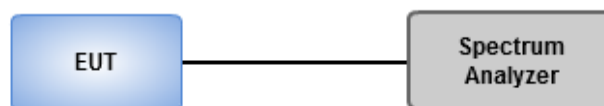

3.2.4 Test Result of 6dB and Occupied Bandwidth

Modulation Mode	N _{TX}	Freq. (MHz)	6dB Bandwidth (MHz)				Limit (kHz)
			Chain 0	Chain 1	Chain 2	Chain 3	
11b	2	2412	10.09	10.09	---	---	500
11b	2	2437	10.09	10.09	---	---	500
11b	2	2462	10.03	9.97	---	---	500
11g	2	2412	15.07	15.13	---	---	500
11g	2	2437	15.07	15.13	---	---	500
11g	2	2462	15.07	15.01	---	---	500
HT20	2	2412	15.13	15.07	---	---	500
HT20	2	2437	14.14	15.65	---	---	500
HT20	2	2462	15.07	15.65	---	---	500
HT40	2	2422	35.13	35.13	---	---	500
HT40	2	2437	35.13	35.13	---	---	500
HT40	2	2452	35.13	35.13	---	---	500

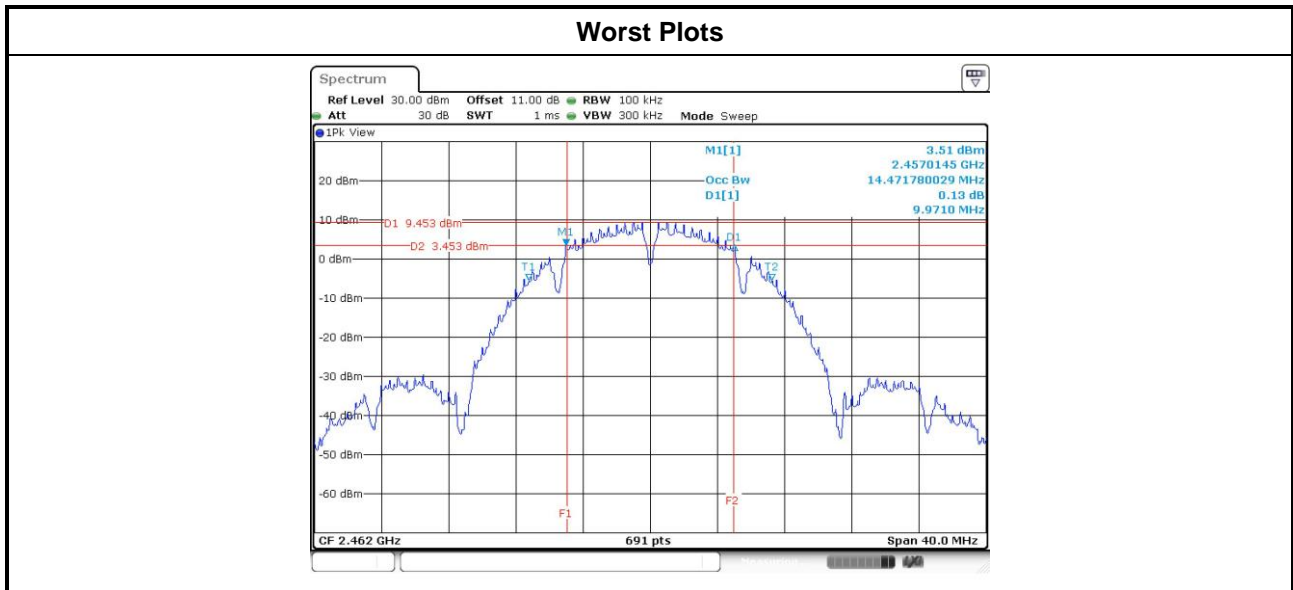

Modulation Mode	N _{TX}	Freq. (MHz)	99% Occupied Bandwidth (MHz)			
			Chain 0	Chain 1	Chain 2	Chain 3
11b	2	2412	14.73	14.55	---	---
11b	2	2437	14.73	14.54	---	---
11b	2	2462	14.69	14.51	---	---
11g	2	2412	16.73	16.43	---	---
11g	2	2437	18.45	17.57	---	---
11g	2	2462	16.72	16.43	---	---
HT20	2	2412	17.63	17.51	---	---
HT20	2	2437	19.10	18.49	---	---
HT20	2	2462	17.63	17.50	---	---
HT40	2	2422	35.94	36.20	---	---
HT40	2	2437	36.10	36.26	---	---
HT40	2	2452	35.92	36.16	---	---

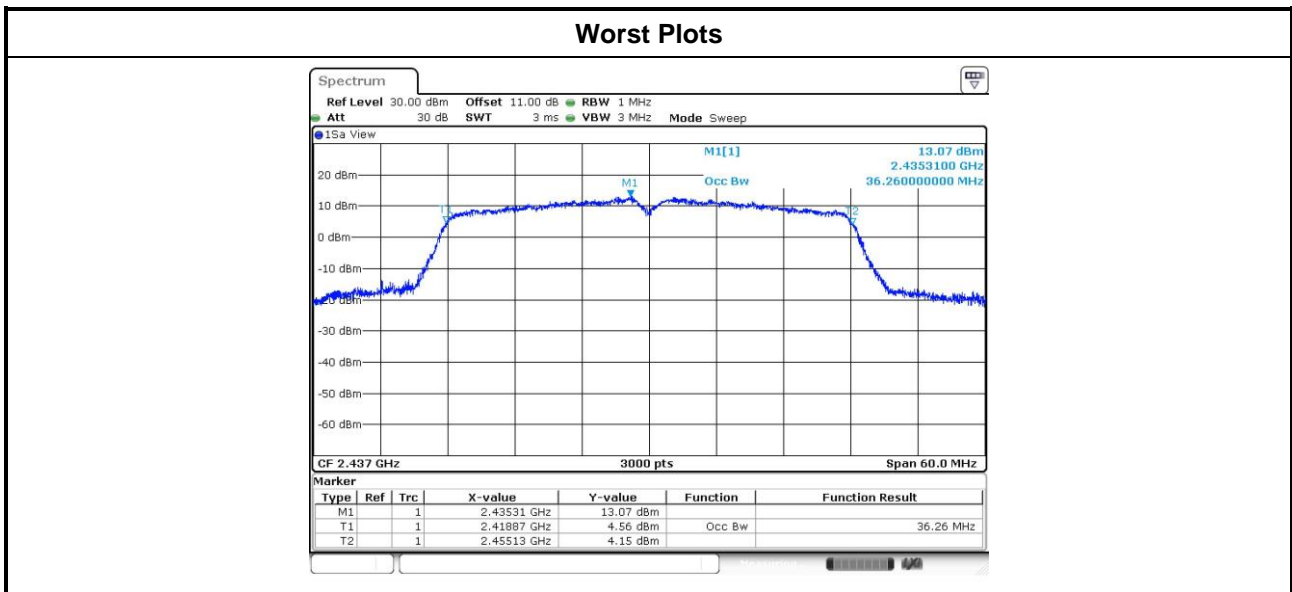

3.3 RF Output Power

3.3.1 Limit of RF Output Power

Conducted power shall not exceed 1Watt.

- Antenna gain \leq 6dBi, no any corresponding reduction is in output power limit.
- Antenna gain $>$ 6dBi
 - Non Fixed, point to point operations.
The conducted output power from the intentional radiator shall be reduced by the amount in dB that the directional gain of the antenna exceeds 6 dB
 - Fixed, point to point operations
Systems operating in the 2400–2483.5 MHz band that are used exclusively for fixed, point-to-point Operations, maximum peak output power of the intentional radiator is reduced by 1 dB for every 3 dB that the directional gain of the antenna exceeds 6 dBi.

Systems operating in the 5725–5850 MHz band that are used exclusively for fixed, point-to-point operations ,no any corresponding reduction is in transmitter peak output power

3.3.2 Test Procedures

- Maximum Peak Conducted Output Power
 - Power meter**
 1. A broadband Peak RF power meter is used for output power measurement. The video bandwidth of power meter is greater than DTS bandwidth of EUT. If duty cycle of test signal is not 100 %, trigger and gating function of power meter will be enabled to capture transmission burst for measuring output power.
- Maximum Conducted Output Power
 - Power meter**
 1. A broadband Average RF power meter is used for output power measurement. The video bandwidth of power meter is greater than DTS bandwidth of EUT. If duty cycle of test signal is not 100 %, trigger and gating function of power meter will be enabled to capture transmission burst for measuring output power.

3.3.3 Test Setup

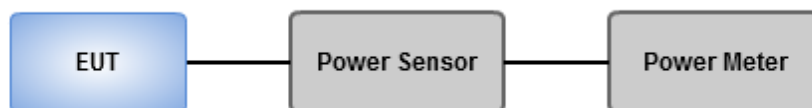

3.3.4 Test Result of Maximum Output Power

Modulation Mode	N _{TX}	Freq. (MHz)	Conducted (average) output power (dBm)				Total Power (mW)	Total Power (dBm)	Limit (dBm)
			Chain 0	Chain 1	Chain 2	Chain 3			
11b	2	2412	19.28	19.41	---	---	172.020	22.36	30.00
11b	2	2437	19.13	19.31	---	---	167.156	22.23	30.00
11b	2	2462	19.17	19.24	---	---	166.550	22.22	30.00
11g	2	2412	16.37	16.25	---	---	85.521	19.32	30.00
11g	2	2437	21.35	21.41	---	---	274.815	24.39	30.00
11g	2	2462	16.38	16.22	---	---	85.330	19.31	30.00
HT20	2	2412	15.48	15.53	---	---	71.046	18.52	30.00
HT20	2	2437	21.22	21.38	---	---	269.838	24.31	30.00
HT20	2	2462	15.43	15.63	---	---	71.474	18.54	30.00
HT40	2	2422	12.02	11.75	---	---	30.884	14.90	30.00
HT40	2	2437	16.53	16.82	---	---	93.062	19.69	30.00
HT40	2	2452	12.52	12.49	---	---	35.607	15.52	30.00

3.4 Power Spectral Density

3.4.1 Limit of Power Spectral Density

Power spectral density shall not be greater than 8 dBm in any 3 kHz band.

3.4.2 Test Procedures

- Maximum peak conducted output power was used to demonstrate compliance to the fundamental output power limit.
 1. Set the RBW = 30kHz, VBW = 100kHz.
 2. Detector = Peak, Sweep time = auto couple.
 3. Trace mode = max hold, allow trace to fully stabilize.
 4. Use the peak marker function to determine the maximum amplitude level.
- Maximum (average) conducted output power was used to demonstrate compliance to the fundamental output power limit.
 1. Set the RBW = 30kHz, VBW = 100 kHz.
 2. Detector = RMS, Sweep time = auto couple.
 3. Set the sweep time to: $\geq 10 \times (\text{number of measurement points in sweep}) \times (\text{maximum data rate per stream})$.
 4. Perform the measurement over a single sweep.
 5. Use the peak marker function to determine the maximum amplitude level.

3.4.3 Test Setup

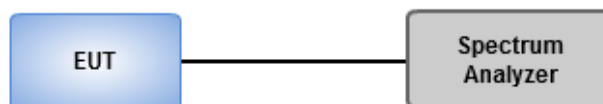

3.4.4 Test Result of Power Spectral Density

Modulation Mode	N _{TX}	Freq. (MHz)	Total Power Spectral Density (dBm/30kHz)	Limit (dBm/3kHz)
11b	2	2412	0.55	7.51
11b	2	2437	0.04	7.51
11b	2	2462	0.44	7.51
11g	2	2412	-4.26	7.51
11g	2	2437	0.85	7.51
11g	2	2462	-4.38	7.51
HT20	2	2412	-4.64	7.51
HT20	2	2437	0.94	7.51
HT20	2	2462	-4.63	7.51
HT40	2	2422	-11.42	7.51
HT40	2	2437	-5.81	7.51
HT40	2	2452	-10.84	7.51

Note:

1. Test result is bin-by-bin summing measured value of each TX port.
2. Directional gain = $3.48 + 10 * \log(2/1) = 6.49 \text{ dBi} > 6 \text{ dBi}$.
Limit shall be reduced to $8 \text{ dBm} - (6.49 \text{ dBi} - 6 \text{ dBi}) = 7.51 \text{ dBm}$.

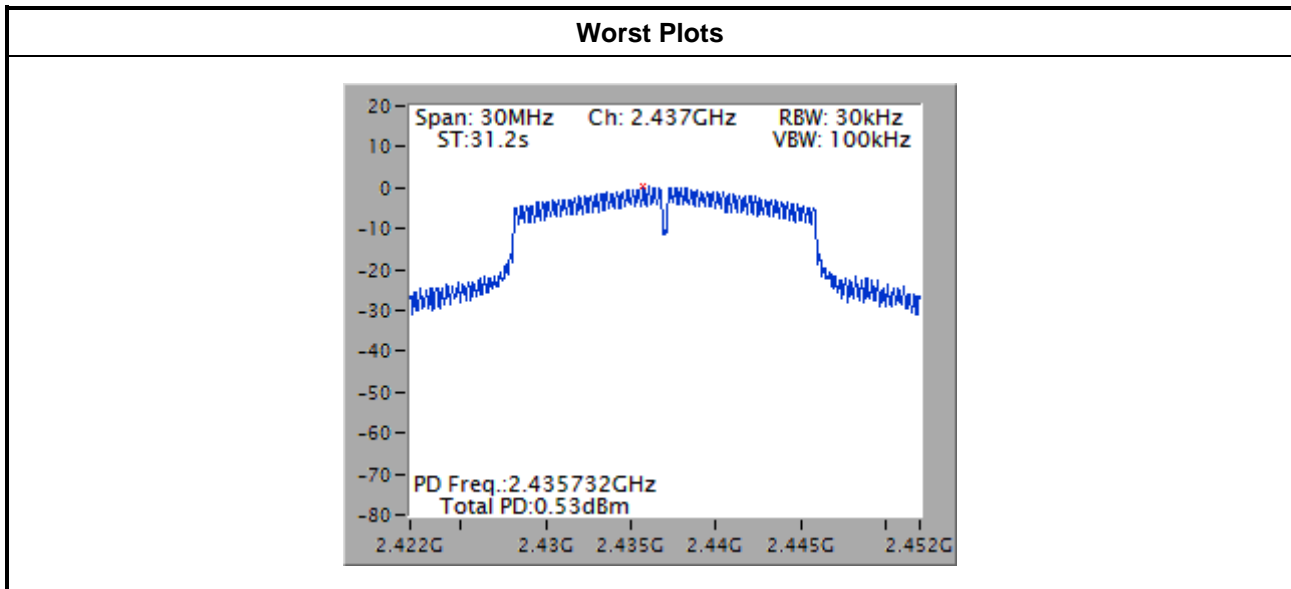

Note: The plot without duty factor.

3.5 Unwanted Emissions into Restricted Frequency Bands

3.5.1 Limit of Unwanted Emissions into Restricted Frequency Bands

Restricted Band Emissions Limit			
Frequency Range (MHz)	Field Strength (uV/m)	Field Strength (dBuV/m)	Measure Distance (m)
0.009~0.490	2400/F(kHz)	48.5 - 13.8	300
0.490~1.705	24000/F(kHz)	33.8 - 23	30
1.705~30.0	30	29	30
30~88	100	40	3
88~216	150	43.5	3
216~960	200	46	3
Above 960	500	54	3

Note 1:
Qusai-Peak value is measured for frequency below 1GHz except for 9–90 kHz, 110–490 kHz frequency band. Peak and average value are measured for frequency above 1GHz. The limit on average radio frequency emission is as above table. The limit on peak radio frequency emissions is 20 dB above the maximum permitted average emission limit

Note 2:
Measurements may be performed at a distance other than what is specified provided. When performing measurements at a distance other than that specified, the results shall be extrapolated to the specified distance using an extrapolation factor as below, Frequency at or above 30 MHz: 20 dB/decade Frequency below 30 MHz: 40 dB/decade.

3.5.2 Test Procedures

1. Measurement is made at a semi-anechoic chamber that incorporates a turntable allowing a EUT rotation of 360°. A continuously-rotating, remotely-controlled turntable is installed at the test site to support the EUT and facilitate determination of the direction of maximum radiation for each EUT emission frequency. The EUT is placed at a height of 0.8 m test table above the ground plane.
2. Measurement is made with the antenna positioned in both the horizontal and vertical planes of polarization. The measurement antenna is varied in height (1m ~ 4m) above the reference ground plane to obtain the maximum signal strength. Distance between EUT and antenna is 3 m.
3. This investigation is performed with the EUT rotated 360°, the antenna height scanned between 1 m and 4 m, and the antenna rotated to repeat the measurements for both the horizontal and vertical antenna polarizations.

Note:

1. 120kHz measurement bandwidth of test receiver and Quasi-peak detector is for radiated emission below 1GHz.
2. RBW=1MHz, VBW=3MHz and Peak detector is for peak measured value of radiated emission above 1GHz.
3. RBW=1MHz, VBW=1/T and Peak detector is for average measured value of radiated emission above 1GHz.

3.5.3 Test Setup

Radiated Emissions below 1 GHz

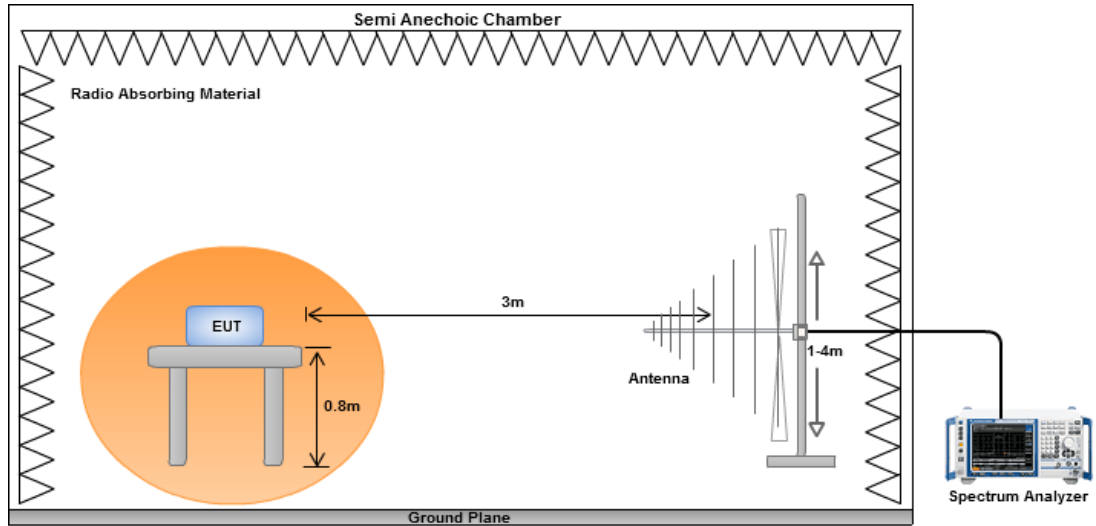

Radiated Emissions above 1 GHz

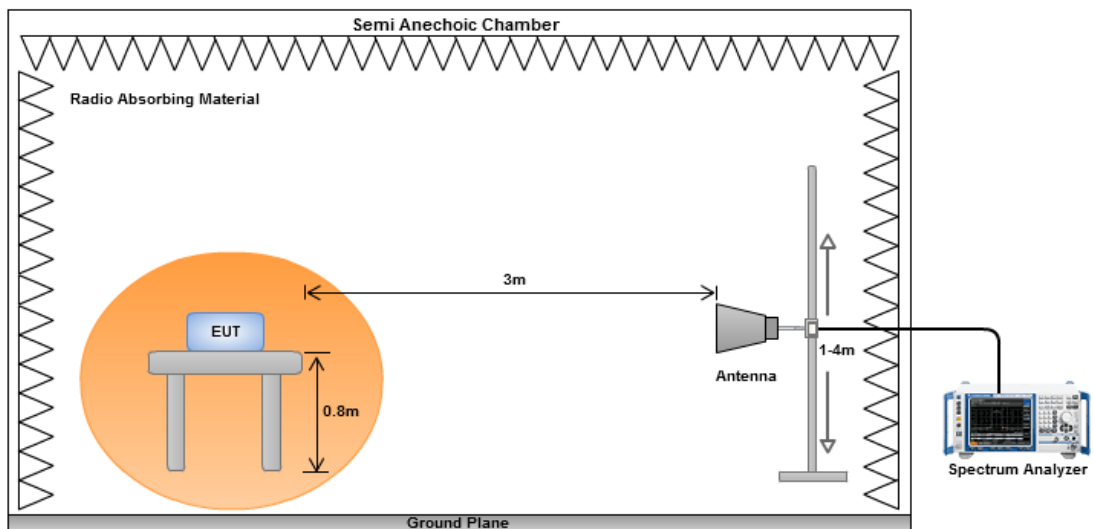

3.5.4 Transmitter Radiated Unwanted Emissions (Below 1GHz)

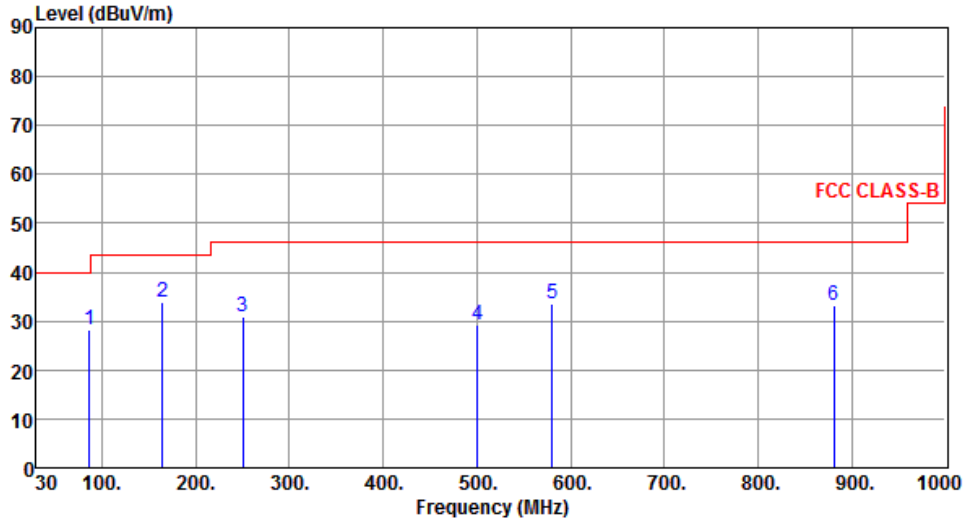
Modulation	11g	Test Freq. (MHz)	2437						
Polarization	Horizontal								
									
	Freq. MHz	Emission level dBuV/m	Limit dBuV/m	Margin dB	SA reading dBuV	Factor dB	Remark	ANT High cm	Turn Table deg
1	86.26	28.35	40.00	-11.65	47.04	-18.69	Peak	---	---
2	164.83	33.79	43.50	-9.71	47.47	-13.68	Peak	---	---
3	250.19	30.82	46.00	-15.18	45.32	-14.50	Peak	---	---
4	500.45	29.18	46.00	-16.82	37.23	-8.05	Peak	---	---
5	579.99	33.41	46.00	-12.59	39.65	-6.24	Peak	---	---
6	880.69	33.36	46.00	-12.64	34.49	-1.13	Peak	---	---

Note 1: Emission Level (dBuV/m) = SA Reading (dBuV/m) + Factor* (dB)
*Factor includes antenna factor , cable loss and amplifier gain
Note 2: Margin (dB) = Emission level (dBuV/m) – Limit (dBuV/m).
Note 3: All spurious emissions below 30MHz are more than 20 dB below the limit.

Modulation	11g	Test Freq. (MHz)	2437
Polarization	Vertical		

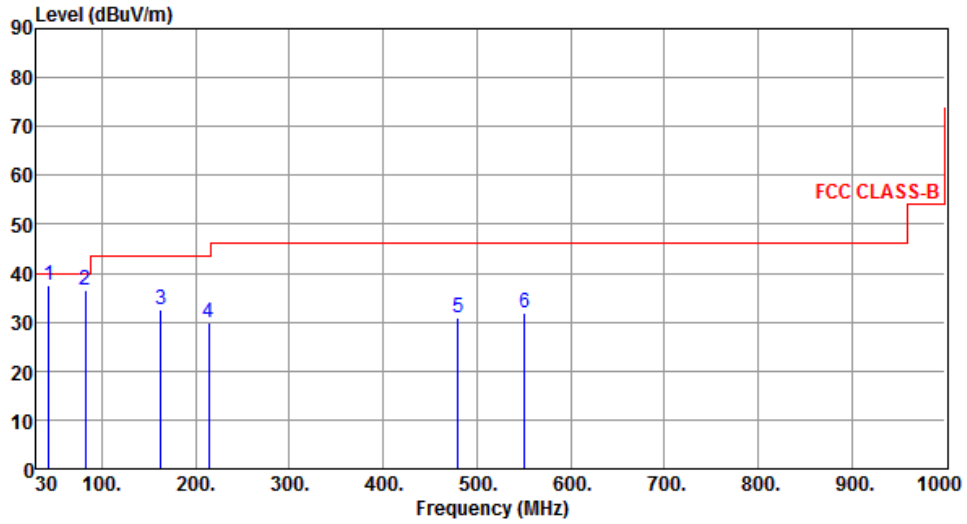

	Freq. MHz	Emission level dBuV/m	Limit dBuV/m	Margin dB	SA reading dBuV	Factor dB	Remark	ANT High cm	Turn Table deg
1	43.58	37.45	40.00	-2.55	50.77	-13.32	QP	---	---
2	82.38	36.66	40.00	-3.34	54.78	-18.12	Peak	---	---
3	162.89	32.51	43.50	-10.99	46.10	-13.59	Peak	---	---
4	214.30	29.80	43.50	-13.70	45.89	-16.09	Peak	---	---
5	480.08	30.86	46.00	-15.14	39.16	-8.30	Peak	---	---
6	550.89	31.81	46.00	-14.19	39.01	-7.20	Peak	---	---

Note 1: Emission Level (dBuV/m) = SA Reading (dBuV/m) + Factor* (dB)

*Factor includes antenna factor , cable loss and amplifier gain

Note 2: Margin (dB) = Emission level (dBuV/m) – Limit (dBuV/m).

Note 3: All spurious emissions below 30MHz are more than 20 dB below the limit.

3.5.5 Transmitter Radiated Unwanted Emissions (Above 1GHz) for 11b

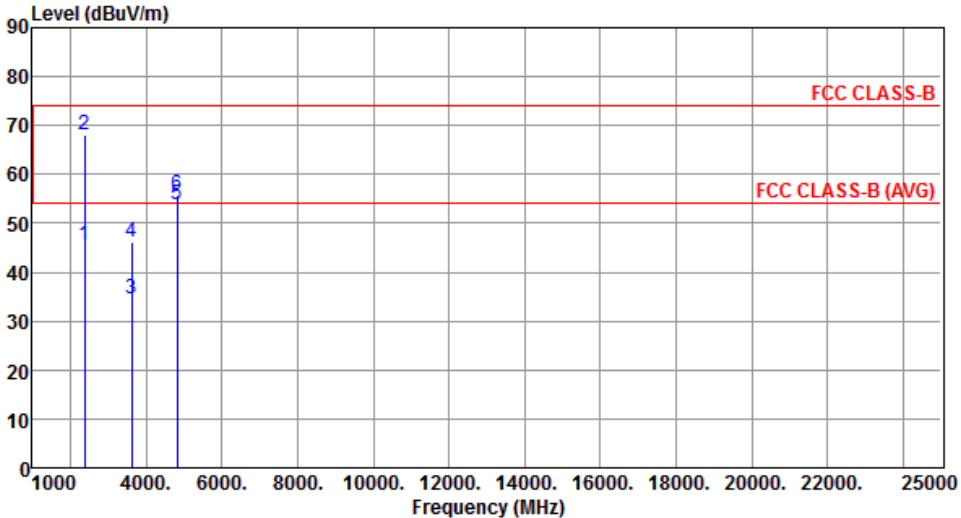
Modulation	11b	Test Freq. (MHz)	2412						
Polarization	Horizontal								
									
	Freq.	Emission level	Limit	Margin	SA reading	Factor	Remark	ANT High	Turn Table
	MHz	dBUV/m	dBUV/m	dB	dBUV	dB		cm	deg
1	2390.00	45.57	54.00	-8.43	47.31	-1.74	Average	---	---
2	2390.00	68.12	74.00	-5.88	69.86	-1.74	Peak	---	---
3	3618.00	34.46	54.00	-19.54	32.68	1.78	Average	---	---
4	3618.00	46.31	74.00	-27.69	44.53	1.78	Peak	---	---
5	4824.00	53.66	54.00	-0.34	48.27	5.39	Average	---	---
6	4824.00	55.88	74.00	-18.12	50.49	5.39	Peak	---	---
<p>Note 1: Emission Level (dBUV/m) = SA Reading (dBUV/m) + Factor* (dB) *Factor includes antenna factor , cable loss and amplifier gain Note 2: Margin (dB) = Emission level (dBUV/m) – Limit (dBUV/m).</p>									

Modulation	11b	Test Freq. (MHz)	2412
Polarization	Vertical		

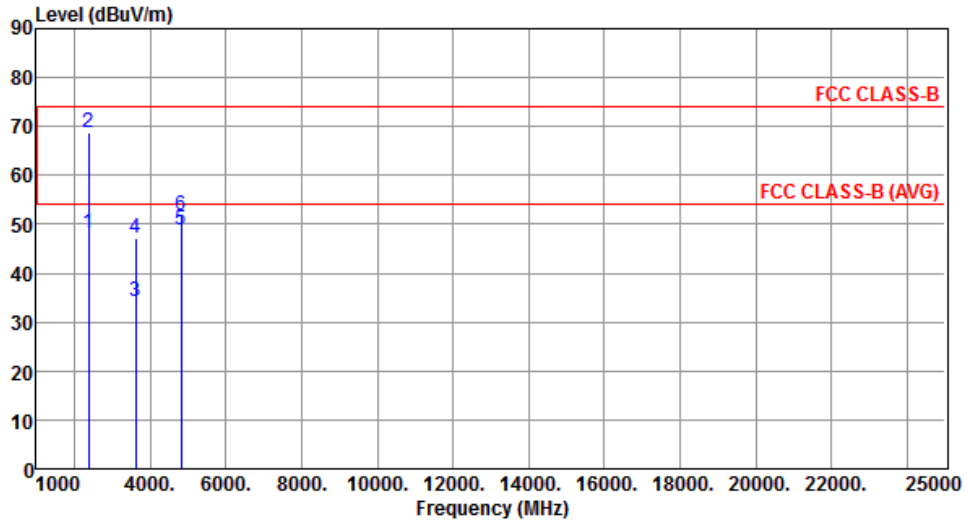

	Freq. MHz	Emission level dBuV/m	Limit dBuV/m	Margin dB	SA reading dBuV	Factor dB	Remark	ANT High cm	Turn Table deg
1	2390.00	48.27	54.00	-5.73	50.01	-1.74	Average	---	---
2	2390.00	68.61	74.00	-5.39	70.35	-1.74	Peak	---	---
3	3618.00	34.21	54.00	-19.79	32.43	1.78	Average	---	---
4	3618.00	47.05	74.00	-26.95	45.27	1.78	Peak	---	---
5	4824.00	48.73	54.00	-5.27	43.34	5.39	Average	---	---
6	4824.00	51.96	74.00	-22.04	46.57	5.39	Peak	---	---

Note 1: Emission Level (dBuV/m) = SA Reading (dBuV/m) + Factor* (dB)

*Factor includes antenna factor , cable loss and amplifier gain

Note 2: Margin (dB) = Emission level (dBuV/m) – Limit (dBuV/m).

Modulation	11b	Test Freq. (MHz)	2437
Polarization	Horizontal		

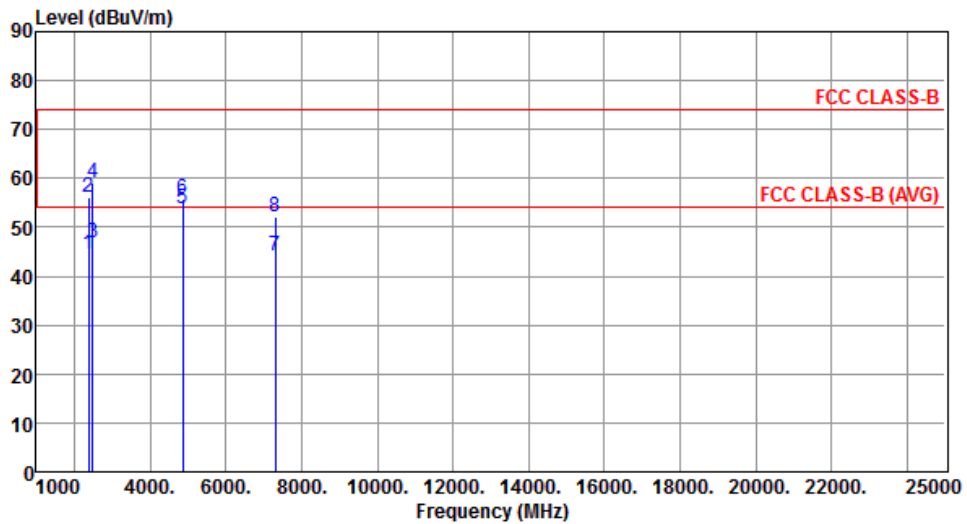

	Freq. MHz	Emission level dBuV/m	Limit dBuV/m	Margin dB	SA reading dBuV	Factor dB	Remark	ANT High cm	Turn Table deg
1	2390.00	44.61	54.00	-9.39	46.35	-1.74	Average	---	---
2	2390.00	56.02	74.00	-17.98	57.76	-1.74	Peak	---	---
3	2483.50	46.73	54.00	-7.27	48.13	-1.40	Average	---	---
4	2483.50	59.14	74.00	-14.86	60.54	-1.40	Peak	---	---
5	4874.00	53.75	54.00	-0.25	48.23	5.52	Average	---	---
6	4874.00	55.92	74.00	-18.08	50.40	5.52	Peak	---	---
7	7311.00	44.13	54.00	-9.87	32.82	11.31	Average	---	---
8	7311.00	52.10	74.00	-21.90	40.79	11.31	Peak	---	---

Note 1: Emission Level (dBuV/m) = SA Reading (dBuV/m) + Factor* (dB)

*Factor includes antenna factor , cable loss and amplifier gain

Note 2: Margin (dB) = Emission level (dBuV/m) – Limit (dBuV/m).

Modulation	11b	Test Freq. (MHz)	2437
Polarization	Vertical		

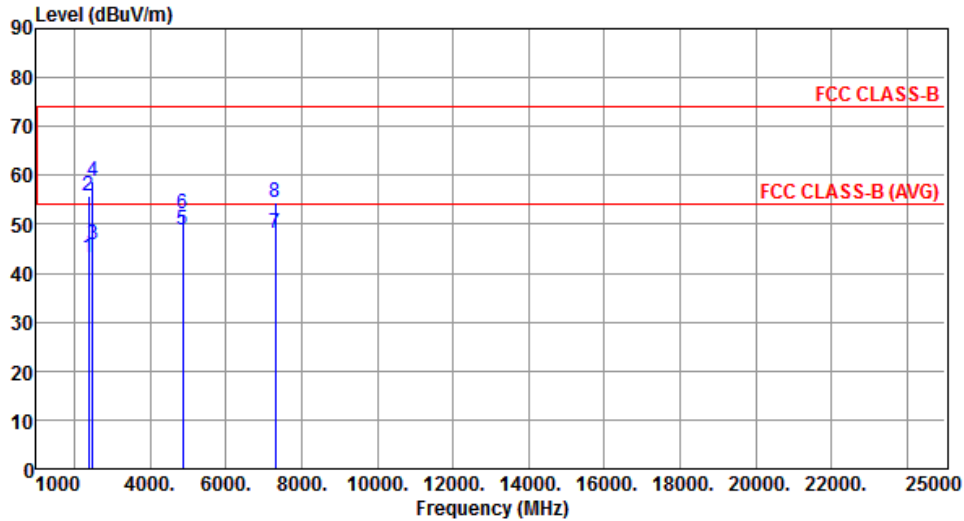

	Freq. MHz	Emission level dBuV/m	Limit dBuV/m	Margin dB	SA reading dBuV	Factor dB	Remark	ANT High cm	Turn Table deg
1	2390.00	43.16	54.00	-10.84	44.90	-1.74	Average	---	---
2	2390.00	55.74	74.00	-18.26	57.48	-1.74	Peak	---	---
3	2483.50	45.77	54.00	-8.23	47.17	-1.40	Average	---	---
4	2483.50	58.74	74.00	-15.26	60.14	-1.40	Peak	---	---
5	4874.00	48.93	54.00	-5.07	43.41	5.52	Average	---	---
6	4874.00	52.29	74.00	-21.71	46.77	5.52	Peak	---	---
7	7311.00	48.20	54.00	-5.80	36.89	11.31	Average	---	---
8	7311.00	54.47	74.00	-19.53	43.16	11.31	Peak	---	---

Note 1: Emission Level (dBuV/m) = SA Reading (dBuV/m) + Factor* (dB)

*Factor includes antenna factor , cable loss and amplifier gain

Note 2: Margin (dB) = Emission level (dBuV/m) – Limit (dBuV/m).

Modulation	11b	Test Freq. (MHz)	2462
Polarization	Horizontal		

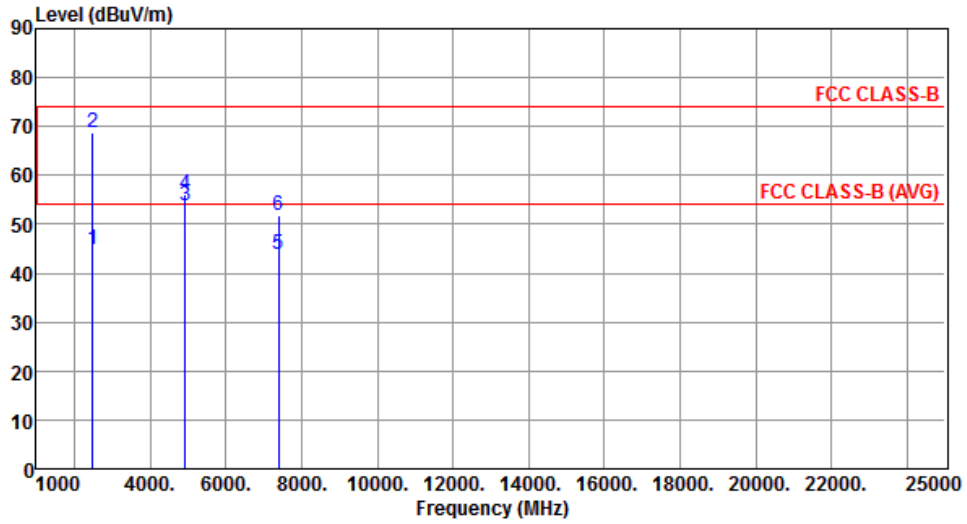

	Freq. MHz	Emission level dBuV/m	Limit dBuV/m	Margin dB	SA reading dBuV	Factor dB	Remark	ANT High cm	Turn Table deg
1	2483.50	44.73	54.00	-9.27	46.13	-1.40	Average	---	---
2	2483.50	68.84	74.00	-5.16	70.24	-1.40	Peak	---	---
3	4924.00	53.84	54.00	-0.16	48.20	5.64	Average	---	---
4	4924.00	56.10	74.00	-17.90	50.46	5.64	Peak	---	---
5	7386.00	43.81	54.00	-10.19	32.47	11.34	Average	---	---
6	7386.00	51.88	74.00	-22.12	40.54	11.34	Peak	---	---

Note 1: Emission Level (dBuV/m) = SA Reading (dBuV/m) + Factor* (dB)

*Factor includes antenna factor , cable loss and amplifier gain

Note 2: Margin (dB) = Emission level (dBuV/m) – Limit (dBuV/m).

Modulation	11b	Test Freq. (MHz)	2462
Polarization	Vertical		

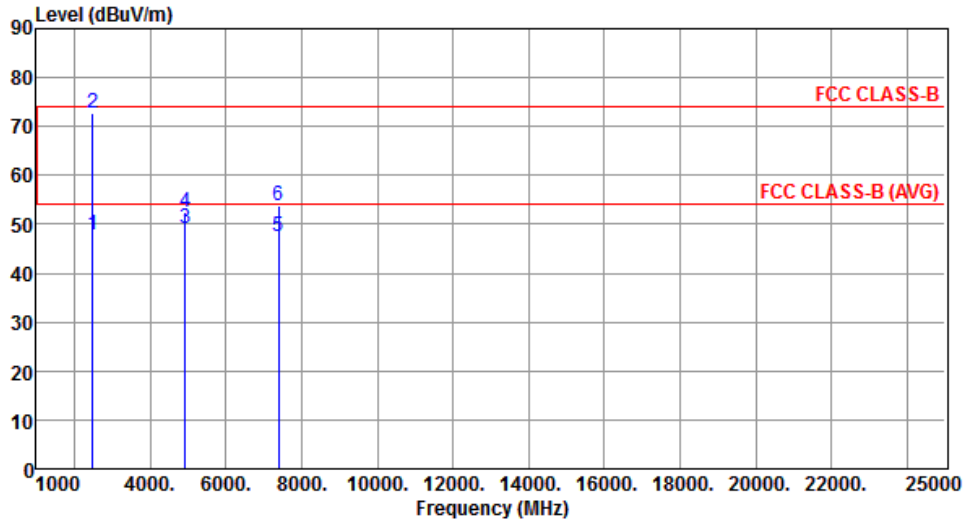

	Freq. MHz	Emission level dBuV/m	Limit dBuV/m	Margin dB	SA reading dBuV	Factor dB	Remark	ANT High cm	Turn Table deg
1	2483.50	47.91	54.00	-6.09	49.31	-1.40	Average	---	---
2	2483.50	72.88	74.00	-1.12	74.28	-1.40	Peak	---	---
3	4924.00	49.09	54.00	-4.91	43.45	5.64	Average	---	---
4	4924.00	52.43	74.00	-21.57	46.79	5.64	Peak	---	---
5	7386.00	47.34	54.00	-6.66	36.00	11.34	Average	---	---
6	7386.00	53.74	74.00	-20.26	42.40	11.34	Peak	---	---

Note 1: Emission Level (dBuV/m) = SA Reading (dBuV/m) + Factor* (dB)

*Factor includes antenna factor , cable loss and amplifier gain

Note 2: Margin (dB) = Emission level (dBuV/m) – Limit (dBuV/m).

3.5.6 Transmitter Radiated Unwanted Emissions (Above 1GHz) for 11g

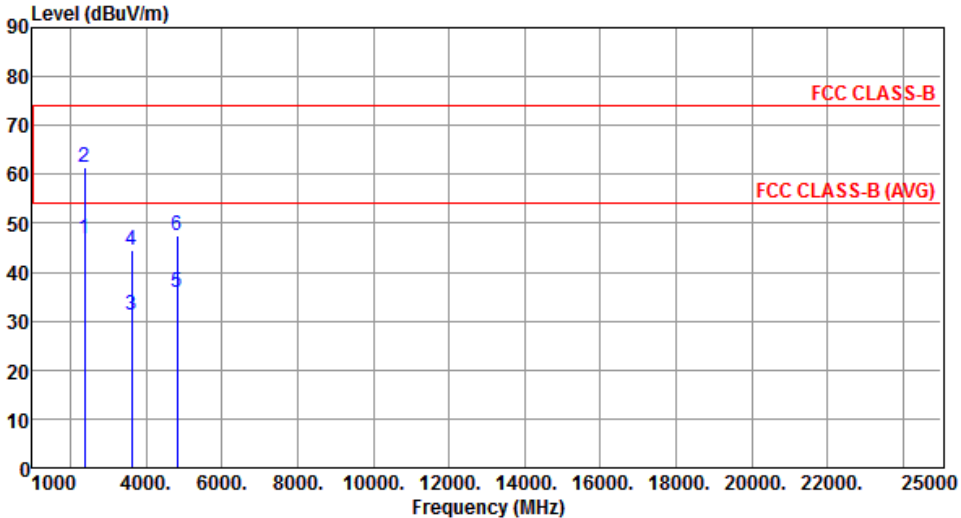
Modulation	11g	Test Freq. (MHz)	2412						
Polarization	Horizontal								
									
	Freq.	Emission level	Limit	Margin	SA reading	Factor	Remark	ANT High	Turn Table
	MHz	dBuV/m	dBuV/m	dB	dBuV	dB		cm	deg
1	2390.00	46.82	54.00	-7.18	48.56	-1.74	Average	---	---
2	2390.00	61.35	74.00	-12.65	63.09	-1.74	Peak	---	---
3	3618.00	31.31	54.00	-22.69	29.53	1.78	Average	---	---
4	3618.00	44.43	74.00	-29.57	42.65	1.78	Peak	---	---
5	4824.00	35.73	54.00	-18.27	30.34	5.39	Average	---	---
6	4824.00	47.56	74.00	-26.44	42.17	5.39	Peak	---	---
<p>Note 1: Emission Level (dBuV/m) = SA Reading (dBuV/m) + Factor* (dB) *Factor includes antenna factor , cable loss and amplifier gain Note 2: Margin (dB) = Emission level (dBuV/m) – Limit (dBuV/m).</p>									

Modulation	11g	Test Freq. (MHz)	2412
Polarization	Vertical		

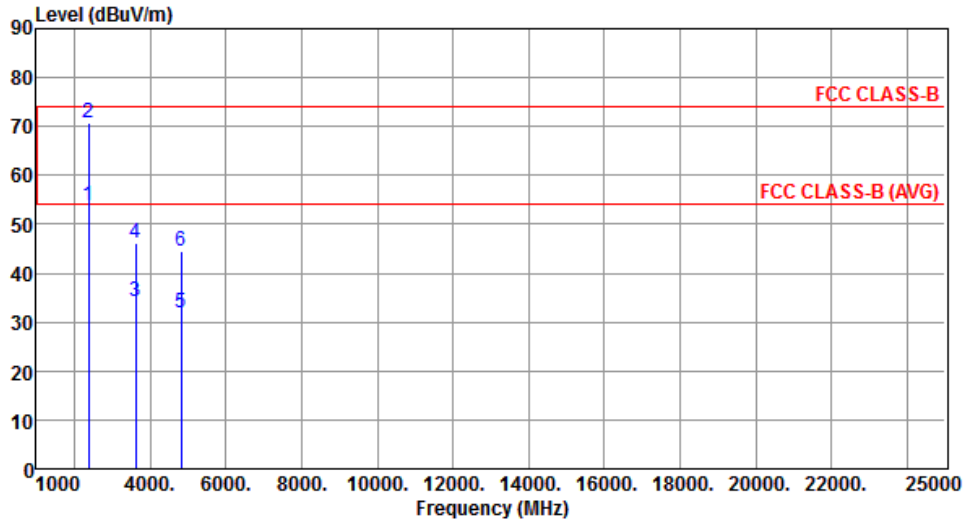

	Freq. MHz	Emission level dBuV/m	Limit dBuV/m	Margin dB	SA reading dBuV	Factor dB	Remark	ANT High cm	Turn Table deg
1	2390.00	53.79	54.00	-0.21	55.53	-1.74	Average	---	---
2	2390.00	70.87	74.00	-3.13	72.61	-1.74	Peak	---	---
3	3618.00	34.20	54.00	-19.80	32.42	1.78	Average	---	---
4	3618.00	46.31	74.00	-27.69	44.53	1.78	Peak	---	---
5	4824.00	31.92	54.00	-22.08	26.53	5.39	Average	---	---
6	4824.00	44.52	74.00	-29.48	39.13	5.39	Peak	---	---

Note 1: Emission Level (dBuV/m) = SA Reading (dBuV/m) + Factor* (dB)

*Factor includes antenna factor , cable loss and amplifier gain

Note 2: Margin (dB) = Emission level (dBuV/m) – Limit (dBuV/m).

Modulation	11g	Test Freq. (MHz)	2437
Polarization	Horizontal		

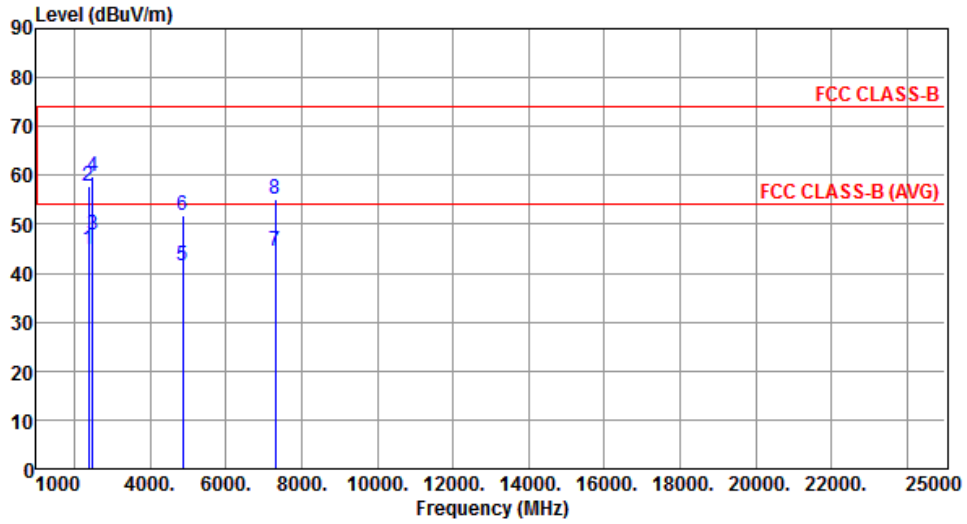

	Freq. MHz	Emission level dBuV/m	Limit dBuV/m	Margin dB	SA reading dBuV	Factor dB	Remark	ANT High cm	Turn Table deg
1	2390.00	44.78	54.00	-9.22	46.52	-1.74	Average	---	---
2	2390.00	57.64	74.00	-16.36	59.38	-1.74	Peak	---	---
3	2483.50	47.93	54.00	-6.07	49.33	-1.40	Average	---	---
4	2483.50	59.91	74.00	-14.09	61.31	-1.40	Peak	---	---
5	4874.00	41.50	54.00	-12.50	35.98	5.52	Average	---	---
6	4874.00	51.68	74.00	-22.32	46.16	5.52	Peak	---	---
7	7311.00	44.56	54.00	-9.44	33.25	11.31	Average	---	---
8	7311.00	55.00	74.00	-19.00	43.69	11.31	Peak	---	---

Note 1: Emission Level (dBuV/m) = SA Reading (dBuV/m) + Factor* (dB)

*Factor includes antenna factor , cable loss and amplifier gain

Note 2: Margin (dB) = Emission level (dBuV/m) – Limit (dBuV/m).

Modulation	11g	Test Freq. (MHz)	2437
Polarization	Vertical		

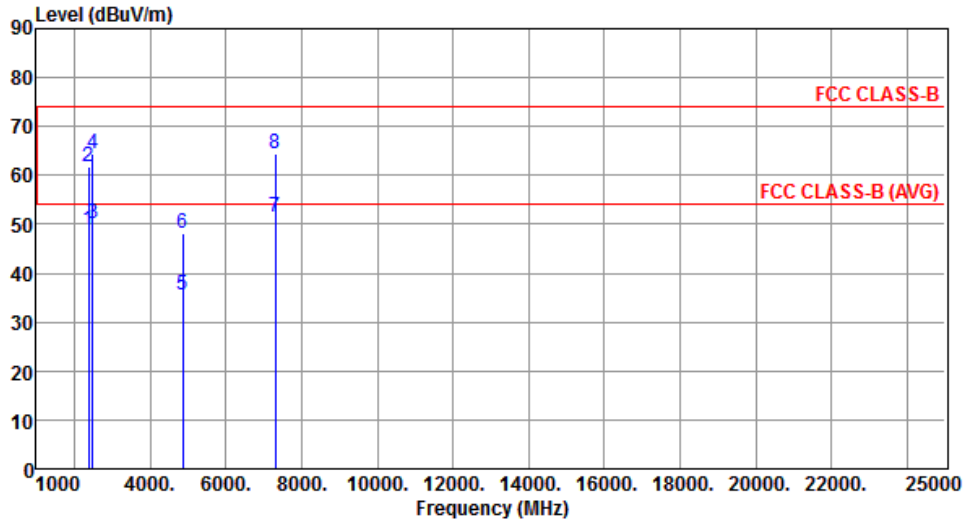

	Freq. MHz	Emission level dBuV/m	Limit dBuV/m	Margin dB	SA reading dBuV	Factor dB	Remark	ANT High cm	Turn Table deg
1	2390.00	48.71	54.00	-5.29	50.45	-1.74	Average	---	---
2	2390.00	61.74	74.00	-12.26	63.48	-1.74	Peak	---	---
3	2483.50	50.05	54.00	-3.95	51.45	-1.40	Average	---	---
4	2483.50	64.36	74.00	-9.64	65.76	-1.40	Peak	---	---
5	4874.00	35.55	54.00	-18.45	30.03	5.52	Average	---	---
6	4874.00	48.20	74.00	-25.80	42.68	5.52	Peak	---	---
7	7311.00	51.57	54.00	-2.43	40.26	11.31	Average	---	---
8	7311.00	64.39	74.00	-9.61	53.08	11.31	Peak	---	---

Note 1: Emission Level (dBuV/m) = SA Reading (dBuV/m) + Factor* (dB)

*Factor includes antenna factor , cable loss and amplifier gain

Note 2: Margin (dB) = Emission level (dBuV/m) – Limit (dBuV/m).

Modulation	11g	Test Freq. (MHz)	2462
Polarization	Horizontal		

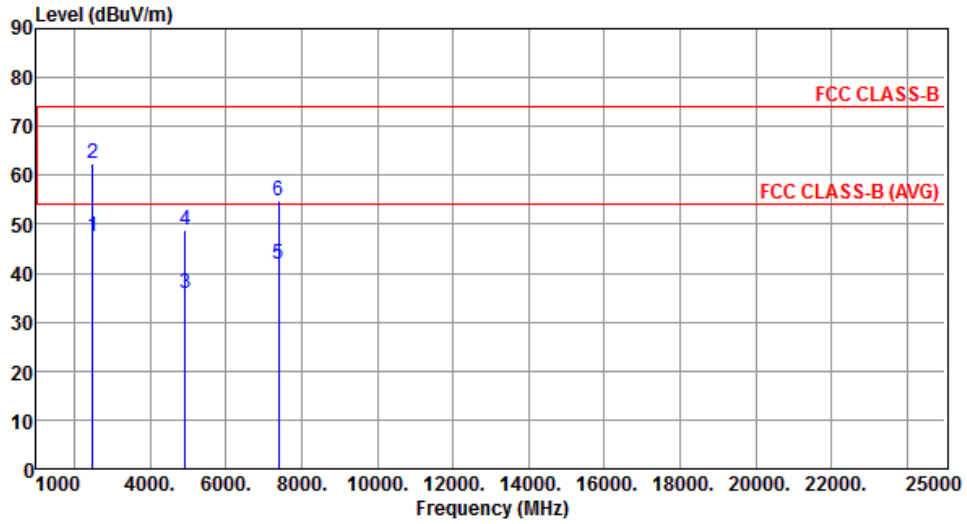

	Freq. MHz	Emission level dBuV/m	Limit dBuV/m	Margin dB	SA reading dBuV	Factor dB	Remark	ANT High cm	Turn Table deg
1	2483.50	47.56	54.00	-6.44	48.96	-1.40	Average	---	---
2	2483.50	62.54	74.00	-11.46	63.94	-1.40	Peak	---	---
3	4924.00	35.98	54.00	-18.02	30.34	5.64	Average	---	---
4	4924.00	48.81	74.00	-25.19	43.17	5.64	Peak	---	---
5	7386.00	41.81	54.00	-12.19	30.47	11.34	Average	---	---
6	7386.00	54.66	74.00	-19.34	43.32	11.34	Peak	---	---

Note 1: Emission Level (dBuV/m) = SA Reading (dBuV/m) + Factor* (dB)

*Factor includes antenna factor , cable loss and amplifier gain

Note 2: Margin (dB) = Emission level (dBuV/m) – Limit (dBuV/m).

Modulation	11g	Test Freq. (MHz)	2462
Polarization	Vertical		

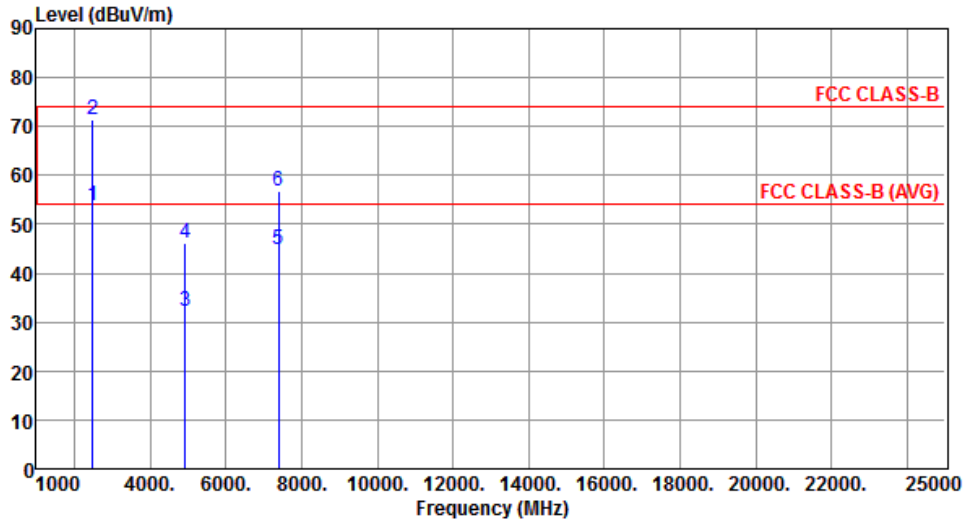

	Freq. MHz	Emission level dBuV/m	Limit dBuV/m	Margin dB	SA reading dBuV	Factor dB	Remark	ANT High cm	Turn Table deg
1	2483.50	53.90	54.00	-0.10	55.30	-1.40	Average	---	---
2	2483.50	71.51	74.00	-2.49	72.91	-1.40	Peak	---	---
3	4924.00	32.18	54.00	-21.82	26.54	5.64	Average	---	---
4	4924.00	46.12	74.00	-27.88	40.48	5.64	Peak	---	---
5	7386.00	44.68	54.00	-9.32	33.34	11.34	Average	---	---
6	7386.00	56.73	74.00	-17.27	45.39	11.34	Peak	---	---

Note 1: Emission Level (dBuV/m) = SA Reading (dBuV/m) + Factor* (dB)

*Factor includes antenna factor , cable loss and amplifier gain

Note 2: Margin (dB) = Emission level (dBuV/m) – Limit (dBuV/m).

3.5.7 Transmitter Radiated Unwanted Emissions (Above 1GHz) for HT20

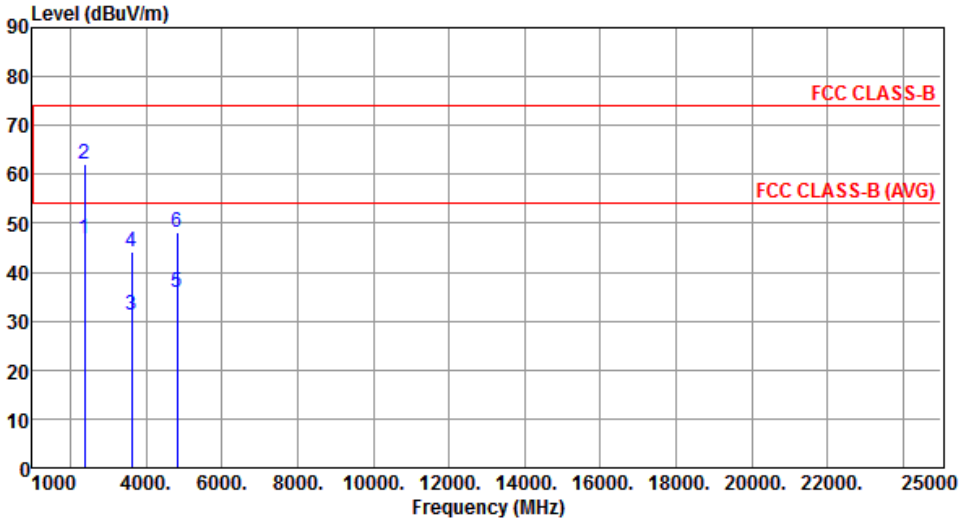
Modulation	HT20	Test Freq. (MHz)	2412																																																																						
Polarization	Horizontal																																																																								
																																																																									
	<table border="1"> <thead> <tr> <th>Freq.</th> <th>Emission level</th> <th>Limit</th> <th>Margin</th> <th>SA reading</th> <th>Factor</th> <th>Remark</th> <th>ANT High</th> <th>Turn Table</th> </tr> <tr> <th>MHz</th> <th>dBuV/m</th> <th>dBuV/m</th> <th>dB</th> <th>dBuV</th> <th>dB</th> <th></th> <th>cm</th> <th>deg</th> </tr> </thead> <tbody> <tr> <td>1</td> <td>2390.00</td> <td>46.88</td> <td>54.00</td> <td>-7.12</td> <td>48.62</td> <td>-1.74</td> <td>Average</td> <td>---</td> </tr> <tr> <td>2</td> <td>2390.00</td> <td>62.01</td> <td>74.00</td> <td>-11.99</td> <td>63.75</td> <td>-1.74</td> <td>Peak</td> <td>---</td> </tr> <tr> <td>3</td> <td>3618.00</td> <td>31.24</td> <td>54.00</td> <td>-22.76</td> <td>29.46</td> <td>1.78</td> <td>Average</td> <td>---</td> </tr> <tr> <td>4</td> <td>3618.00</td> <td>44.16</td> <td>74.00</td> <td>-29.84</td> <td>42.38</td> <td>1.78</td> <td>Peak</td> <td>---</td> </tr> <tr> <td>5</td> <td>4824.00</td> <td>35.88</td> <td>54.00</td> <td>-18.12</td> <td>30.49</td> <td>5.39</td> <td>Average</td> <td>---</td> </tr> <tr> <td>6</td> <td>4824.00</td> <td>48.12</td> <td>74.00</td> <td>-25.88</td> <td>42.73</td> <td>5.39</td> <td>Peak</td> <td>---</td> </tr> </tbody> </table>	Freq.	Emission level	Limit	Margin	SA reading	Factor	Remark	ANT High	Turn Table	MHz	dBuV/m	dBuV/m	dB	dBuV	dB		cm	deg	1	2390.00	46.88	54.00	-7.12	48.62	-1.74	Average	---	2	2390.00	62.01	74.00	-11.99	63.75	-1.74	Peak	---	3	3618.00	31.24	54.00	-22.76	29.46	1.78	Average	---	4	3618.00	44.16	74.00	-29.84	42.38	1.78	Peak	---	5	4824.00	35.88	54.00	-18.12	30.49	5.39	Average	---	6	4824.00	48.12	74.00	-25.88	42.73	5.39	Peak	---
Freq.	Emission level	Limit	Margin	SA reading	Factor	Remark	ANT High	Turn Table																																																																	
MHz	dBuV/m	dBuV/m	dB	dBuV	dB		cm	deg																																																																	
1	2390.00	46.88	54.00	-7.12	48.62	-1.74	Average	---																																																																	
2	2390.00	62.01	74.00	-11.99	63.75	-1.74	Peak	---																																																																	
3	3618.00	31.24	54.00	-22.76	29.46	1.78	Average	---																																																																	
4	3618.00	44.16	74.00	-29.84	42.38	1.78	Peak	---																																																																	
5	4824.00	35.88	54.00	-18.12	30.49	5.39	Average	---																																																																	
6	4824.00	48.12	74.00	-25.88	42.73	5.39	Peak	---																																																																	
<p>Note 1: Emission Level (dBuV/m) = SA Reading (dBuV/m) + Factor* (dB) *Factor includes antenna factor , cable loss and amplifier gain Note 2: Margin (dB) = Emission level (dBuV/m) – Limit (dBuV/m).</p>																																																																									

Modulation	HT20	Test Freq. (MHz)	2412
Polarization	Vertical		

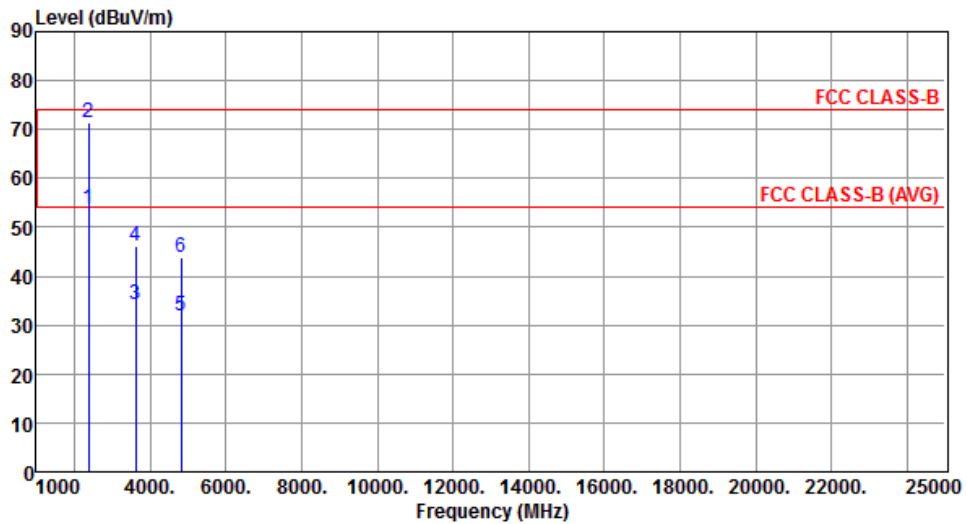

	Freq. MHz	Emission level dBuV/m	Limit dBuV/m	Margin dB	SA reading dBuV	Factor dB	Remark	ANT High cm	Turn Table deg
1	2390.00	53.72	54.00	-0.28	55.46	-1.74	Average	---	---
2	2390.00	71.45	74.00	-2.55	73.19	-1.74	Peak	---	---
3	3618.00	34.24	54.00	-19.76	32.46	1.78	Average	---	---
4	3618.00	46.31	74.00	-27.69	44.53	1.78	Peak	---	---
5	4824.00	31.81	54.00	-22.19	26.42	5.39	Average	---	---
6	4824.00	43.88	74.00	-30.12	38.49	5.39	Peak	---	---

Note 1: Emission Level (dBuV/m) = SA Reading (dBuV/m) + Factor* (dB)

*Factor includes antenna factor , cable loss and amplifier gain

Note 2: Margin (dB) = Emission level (dBuV/m) – Limit (dBuV/m).

Modulation	HT20	Test Freq. (MHz)	2437
Polarization	Horizontal		

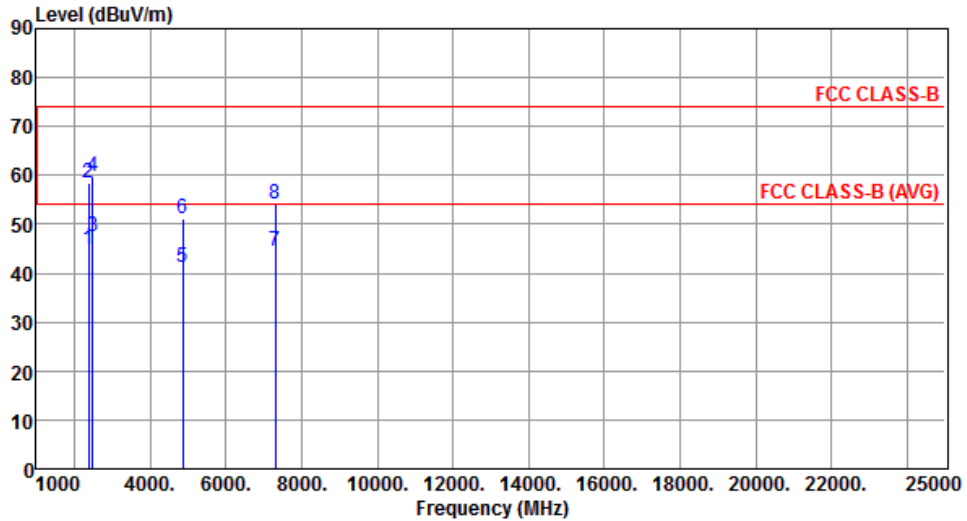

	Freq. MHz	Emission level dBuV/m	Limit dBuV/m	Margin dB	SA reading dBuV	Factor dB	Remark	ANT High cm	Turn Table deg
1	2390.00	44.88	54.00	-9.12	46.62	-1.74	Average	---	---
2	2390.00	58.57	74.00	-15.43	60.31	-1.74	Peak	---	---
3	2483.50	47.53	54.00	-6.47	48.93	-1.40	Average	---	---
4	2483.50	59.87	74.00	-14.13	61.27	-1.40	Peak	---	---
5	4874.00	41.20	54.00	-12.80	35.68	5.52	Average	---	---
6	4874.00	51.27	74.00	-22.73	45.75	5.52	Peak	---	---
7	7311.00	44.37	54.00	-9.63	33.06	11.31	Average	---	---
8	7311.00	54.29	74.00	-19.71	42.98	11.31	Peak	---	---

Note 1: Emission Level (dBuV/m) = SA Reading (dBuV/m) + Factor* (dB)

*Factor includes antenna factor , cable loss and amplifier gain

Note 2: Margin (dB) = Emission level (dBuV/m) – Limit (dBuV/m).

Modulation	HT20	Test Freq. (MHz)	2437
Polarization	Vertical		

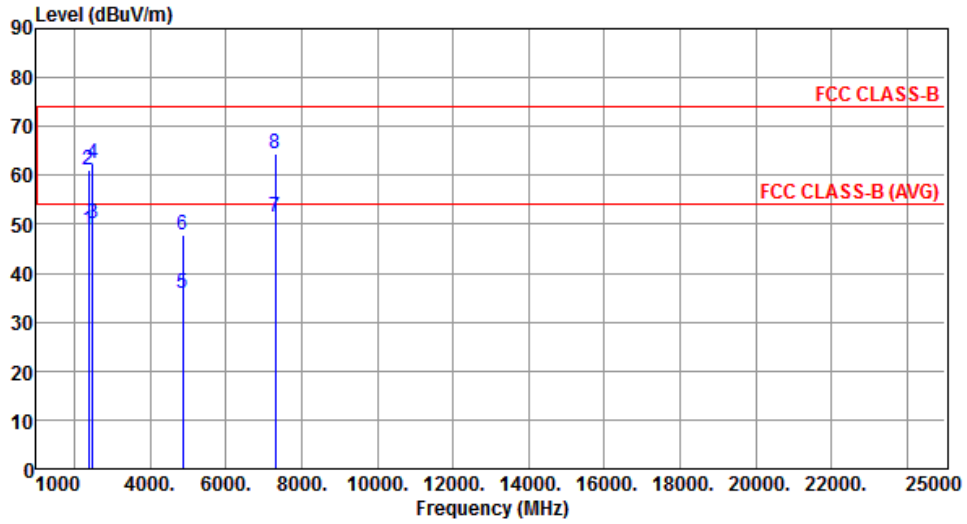

	Freq. MHz	Emission level dBuV/m	Limit dBuV/m	Margin dB	SA reading dBuV	Factor dB	Remark	ANT High cm	Turn Table deg
1	2390.00	48.68	54.00	-5.32	50.42	-1.74	Average	---	---
2	2390.00	61.22	74.00	-12.78	62.96	-1.74	Peak	---	---
3	2483.50	50.16	54.00	-3.84	51.56	-1.40	Average	---	---
4	2483.50	62.45	74.00	-11.55	63.85	-1.40	Peak	---	---
5	4874.00	35.73	54.00	-18.27	30.21	5.52	Average	---	---
6	4874.00	47.97	74.00	-26.03	42.45	5.52	Peak	---	---
7	7311.00	51.44	54.00	-2.56	40.13	11.31	Average	---	---
8	7311.00	64.29	74.00	-9.71	52.98	11.31	Peak	---	---

Note 1: Emission Level (dBuV/m) = SA Reading (dBuV/m) + Factor* (dB)

*Factor includes antenna factor , cable loss and amplifier gain

Note 2: Margin (dB) = Emission level (dBuV/m) – Limit (dBuV/m).

Modulation	HT20	Test Freq. (MHz)	2462
Polarization	Horizontal		

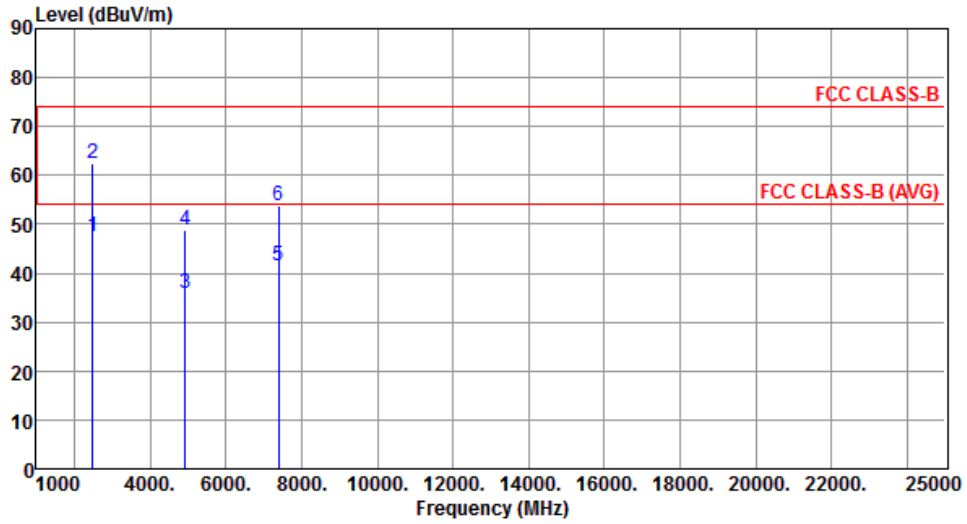

	Freq. MHz	Emission level dBuV/m	Limit dBuV/m	Margin dB	SA reading dBuV	Factor dB	Remark	ANT High cm	Turn Table deg
1	2483.50	47.36	54.00	-6.64	48.76	-1.40	Average	---	---
2	2483.50	62.35	74.00	-11.65	63.75	-1.40	Peak	---	---
3	4924.00	35.81	54.00	-18.19	30.17	5.64	Average	---	---
4	4924.00	48.90	74.00	-25.10	43.26	5.64	Peak	---	---
5	7386.00	41.47	54.00	-12.53	30.13	11.34	Average	---	---
6	7386.00	53.87	74.00	-20.13	42.53	11.34	Peak	---	---

Note 1: Emission Level (dBuV/m) = SA Reading (dBuV/m) + Factor* (dB)

*Factor includes antenna factor , cable loss and amplifier gain

Note 2: Margin (dB) = Emission level (dBuV/m) – Limit (dBuV/m).

Modulation	HT20	Test Freq. (MHz)	2462
Polarization	Vertical		

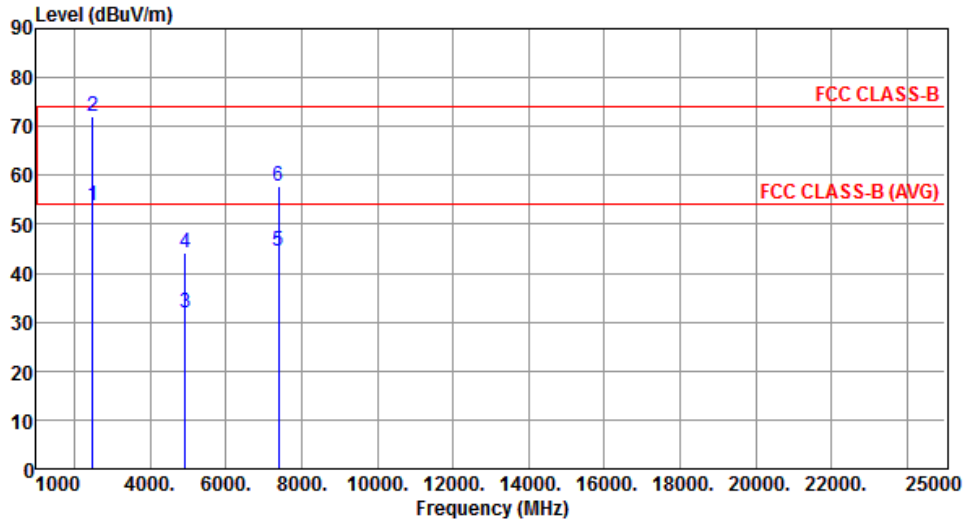

	Freq. MHz	Emission level dBuV/m	Limit dBuV/m	Margin dB	SA reading dBuV	Factor dB	Remark	ANT High cm	Turn Table deg
1	2483.50	53.85	54.00	-0.15	55.25	-1.40	Average	---	---
2	2483.50	72.19	74.00	-1.81	73.59	-1.40	Peak	---	---
3	4924.00	32.00	54.00	-22.00	26.36	5.64	Average	---	---
4	4924.00	44.30	74.00	-29.70	38.66	5.64	Peak	---	---
5	7386.00	44.59	54.00	-9.41	33.25	11.34	Average	---	---
6	7386.00	57.66	74.00	-16.34	46.32	11.34	Peak	---	---

Note 1: Emission Level (dBuV/m) = SA Reading (dBuV/m) + Factor* (dB)

*Factor includes antenna factor , cable loss and amplifier gain

Note 2: Margin (dB) = Emission level (dBuV/m) – Limit (dBuV/m).

3.5.8 Transmitter Radiated Unwanted Emissions (Above 1GHz) for HT40

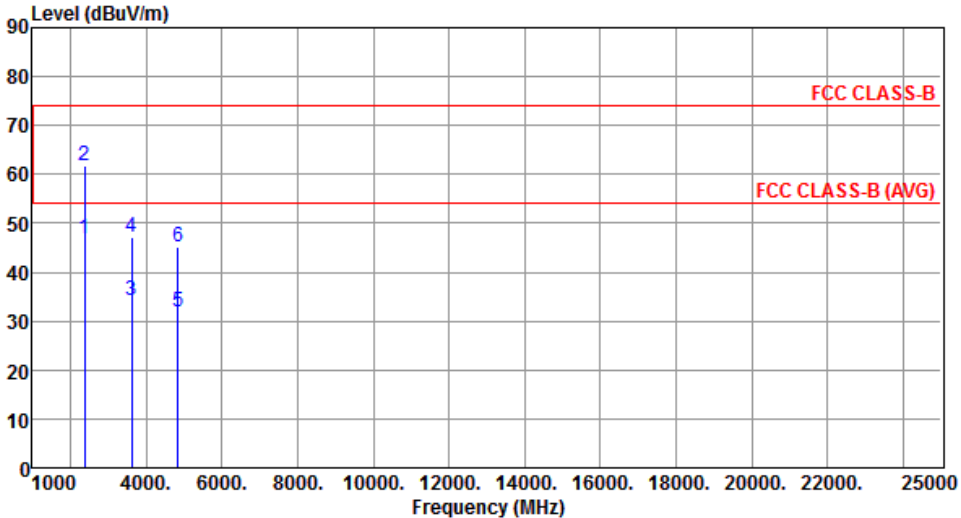
Modulation	HT40	Test Freq. (MHz)	2422						
Polarization	Horizontal								
									
	Freq.	Emission level	Limit	Margin	SA reading	Factor	Remark	ANT High	Turn Table
	MHz	dBuV/m	dBuV/m	dB	dBuV	dB		cm	deg
1	2390.00	46.88	54.00	-7.12	48.62	-1.74	Average	---	---
2	2390.00	61.92	74.00	-12.08	63.66	-1.74	Peak	---	---
3	3633.00	34.34	54.00	-19.66	32.51	1.83	Average	---	---
4	3633.00	47.25	74.00	-26.75	45.42	1.83	Peak	---	---
5	4844.00	32.02	54.00	-21.98	26.58	5.44	Average	---	---
6	4844.00	45.06	74.00	-28.94	39.62	5.44	Peak	---	---
<p>Note 1: Emission Level (dBuV/m) = SA Reading (dBuV/m) + Factor* (dB) *Factor includes antenna factor , cable loss and amplifier gain Note 2: Margin (dB) = Emission level (dBuV/m) – Limit (dBuV/m).</p>									

Modulation	HT40	Test Freq. (MHz)	2422
Polarization	Vertical		

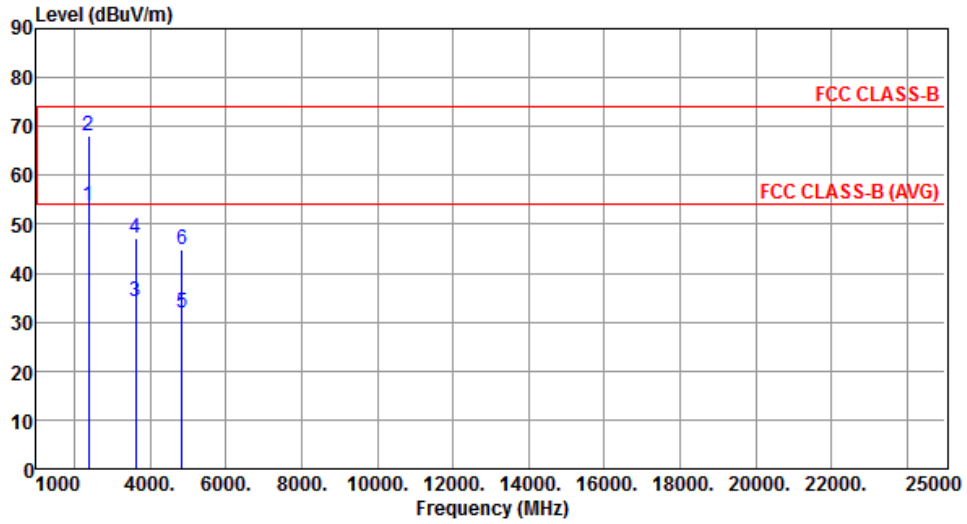

	Freq. MHz	Emission level dBuV/m	Limit dBuV/m	Margin dB	SA reading dBuV	Factor dB	Remark	ANT High cm	Turn Table deg
1	2390.00	53.77	54.00	-0.23	55.51	-1.74	Average	---	---
2	2390.00	68.18	74.00	-5.82	69.92	-1.74	Peak	---	---
3	3633.00	34.16	54.00	-19.84	32.33	1.83	Average	---	---
4	3633.00	47.01	74.00	-26.99	45.18	1.83	Peak	---	---
5	4844.00	31.93	54.00	-22.07	26.49	5.44	Average	---	---
6	4844.00	44.86	74.00	-29.14	39.42	5.44	Peak	---	---

Note 1: Emission Level (dBuV/m) = SA Reading (dBuV/m) + Factor* (dB)

*Factor includes antenna factor , cable loss and amplifier gain

Note 2: Margin (dB) = Emission level (dBuV/m) – Limit (dBuV/m).

Modulation	HT40	Test Freq. (MHz)	2437
Polarization	Horizontal		

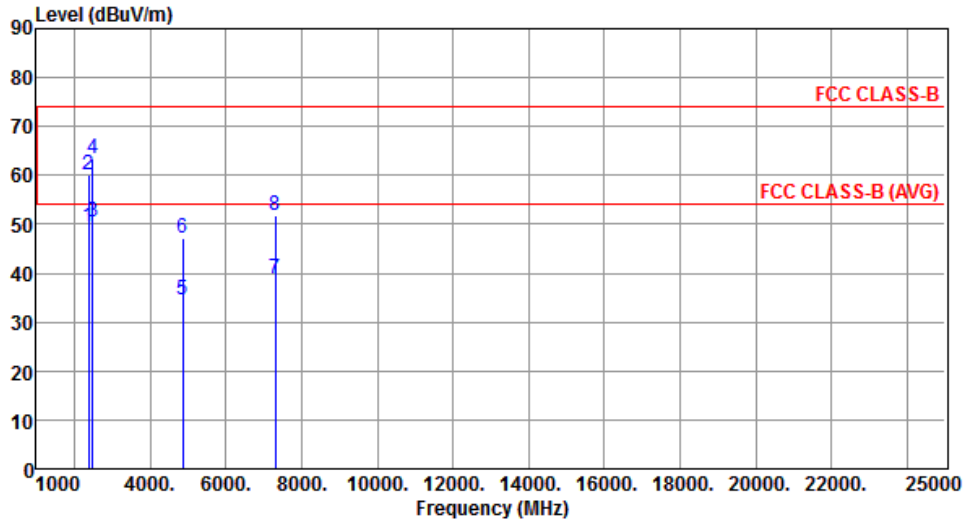

	Freq. MHz	Emission level dBuV/m	Limit dBuV/m	Margin dB	SA reading dBuV	Factor dB	Remark	ANT High cm	Turn Table deg
1	2390.00	49.42	54.00	-4.58	51.16	-1.74	Average	---	---
2	2390.00	60.11	74.00	-13.89	61.85	-1.74	Peak	---	---
3	2483.50	50.44	54.00	-3.56	51.84	-1.40	Average	---	---
4	2483.50	63.48	74.00	-10.52	64.88	-1.40	Peak	---	---
5	4874.00	34.65	54.00	-19.35	29.13	5.52	Average	---	---
6	4874.00	47.05	74.00	-26.95	41.53	5.52	Peak	---	---
7	7311.00	38.99	54.00	-15.01	27.68	11.31	Average	---	---
8	7311.00	51.90	74.00	-22.10	40.59	11.31	Peak	---	---

Note 1: Emission Level (dBuV/m) = SA Reading (dBuV/m) + Factor* (dB)

*Factor includes antenna factor , cable loss and amplifier gain

Note 2: Margin (dB) = Emission level (dBuV/m) – Limit (dBuV/m).

Modulation	HT40	Test Freq. (MHz)	2437
Polarization	Vertical		

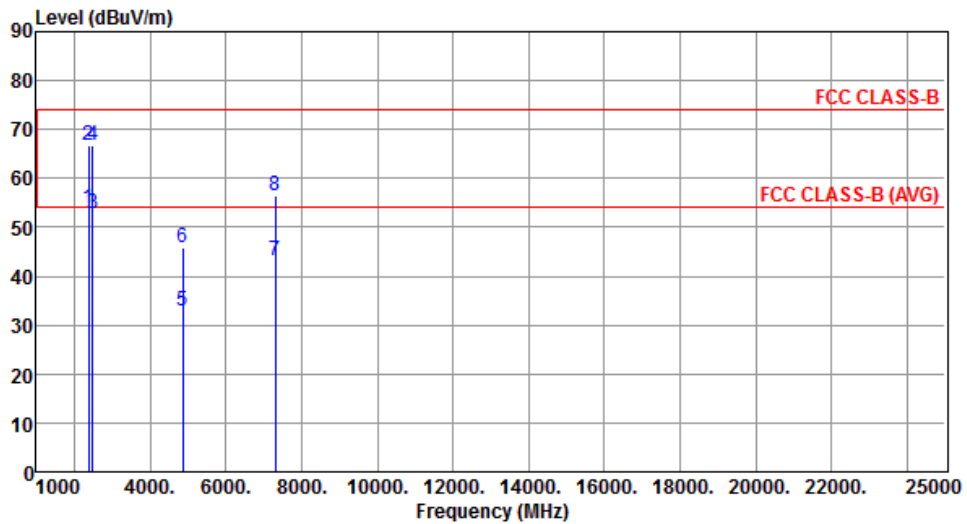

	Freq. MHz	Emission level dBuV/m	Limit dBuV/m	Margin dB	SA reading dBuV	Factor dB	Remark	ANT High cm	Turn Table deg
1	2390.00	53.72	54.00	-0.28	55.46	-1.74	Average	---	---
2	2390.00	66.85	74.00	-7.15	68.59	-1.74	Peak	---	---
3	2483.50	52.75	54.00	-1.25	54.15	-1.40	Average	---	---
4	2483.50	66.73	74.00	-7.27	68.13	-1.40	Peak	---	---
5	4874.00	32.94	54.00	-21.06	27.42	5.52	Average	---	---
6	4874.00	45.76	74.00	-28.24	40.24	5.52	Peak	---	---
7	7311.00	43.29	54.00	-10.71	31.98	11.31	Average	---	---
8	7311.00	56.47	74.00	-17.53	45.16	11.31	Peak	---	---

Note 1: Emission Level (dBuV/m) = SA Reading (dBuV/m) + Factor* (dB)

*Factor includes antenna factor , cable loss and amplifier gain

Note 2: Margin (dB) = Emission level (dBuV/m) – Limit (dBuV/m).

Modulation	HT40	Test Freq. (MHz)	2452
Polarization	Horizontal		

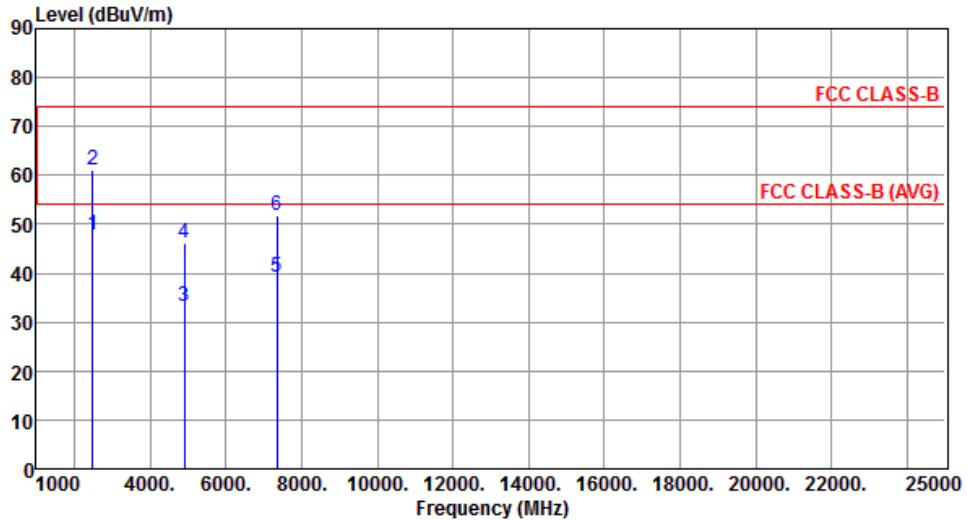

	Freq. MHz	Emission level dBuV/m	Limit dBuV/m	Margin dB	SA reading dBuV	Factor dB	Remark	ANT High cm	Turn Table deg
1	2483.50	47.82	54.00	-6.18	49.22	-1.40	Average	---	---
2	2483.50	61.14	74.00	-12.86	62.54	-1.40	Peak	---	---
3	4904.00	33.23	54.00	-20.77	27.64	5.59	Average	---	---
4	4904.00	46.08	74.00	-27.92	40.49	5.59	Peak	---	---
5	7356.00	39.18	54.00	-14.82	27.84	11.34	Average	---	---
6	7356.00	51.67	74.00	-22.33	40.33	11.34	Peak	---	---

Note 1: Emission Level (dBuV/m) = SA Reading (dBuV/m) + Factor* (dB)

*Factor includes antenna factor , cable loss and amplifier gain

Note 2: Margin (dB) = Emission level (dBuV/m) – Limit (dBuV/m).

Modulation	HT40	Test Freq. (MHz)	2452
Polarization	Vertical		

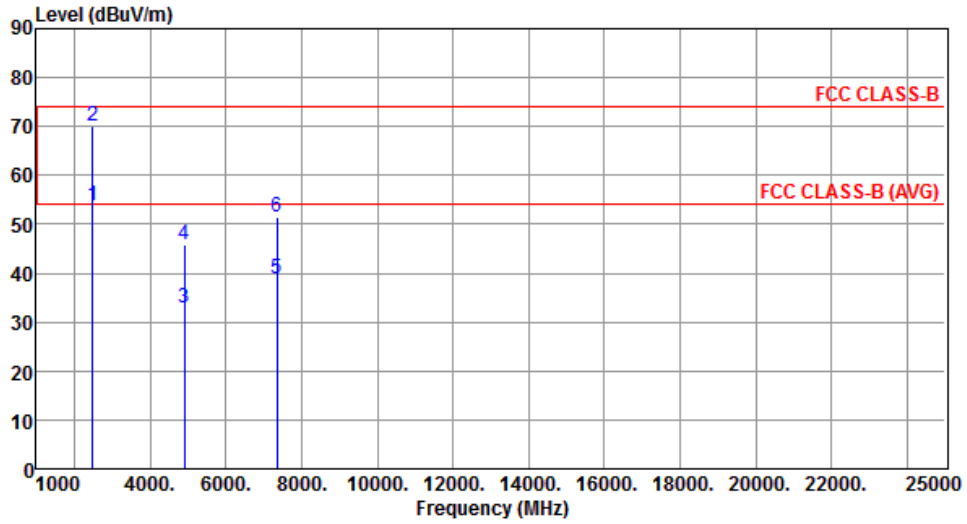

	Freq. MHz	Emission level dBuV/m	Limit dBuV/m	Margin dB	SA reading dBuV	Factor dB	Remark	ANT High cm	Turn Table deg
1	2483.50	53.64	54.00	-0.36	55.04	-1.40	Average	---	---
2	2483.50	70.06	74.00	-3.94	71.46	-1.40	Peak	---	---
3	4904.00	32.97	54.00	-21.03	27.38	5.59	Average	---	---
4	4904.00	45.85	74.00	-28.15	40.26	5.59	Peak	---	---
5	7356.00	38.77	54.00	-15.23	27.43	11.34	Average	---	---
6	7356.00	51.61	74.00	-22.39	40.27	11.34	Peak	---	---

Note 1: Emission Level (dBuV/m) = SA Reading (dBuV/m) + Factor* (dB)

*Factor includes antenna factor , cable loss and amplifier gain

Note 2: Margin (dB) = Emission level (dBuV/m) – Limit (dBuV/m).

3.6 Emissions in Non-Restricted Frequency Bands

3.6.1 Emissions in Non-Restricted Frequency Bands Limit

Peak power in any 100 kHz bandwidth outside of the authorized frequency band shall be attenuated by at least 30 dB relative to the maximum in-band peak PSD level in 100 kHz

3.6.2 Measuring Instruments

Refer a test equipment and calibration data table in this test report.

3.6.3 Test Procedures

Reference level measurement

1. Set RBW=100kHz, VBW = 300kHz , Detector = Peak, Sweep time = Auto
2. Trace = max hold , Allow Trace to fully stabilize
3. Use the peak marker function to determine the maximum PSD level

Emission level measurement

1. Set RBW=100kHz, VBW = 300kHz , Detector = Peak, Sweep time = Auto
2. Trace = max hold , Allow Trace to fully stabilize
3. Scan Frequency range is up to 25GHz
4. Use the peak marker function to determine the maximum amplitude level

3.6.4 Test Setup

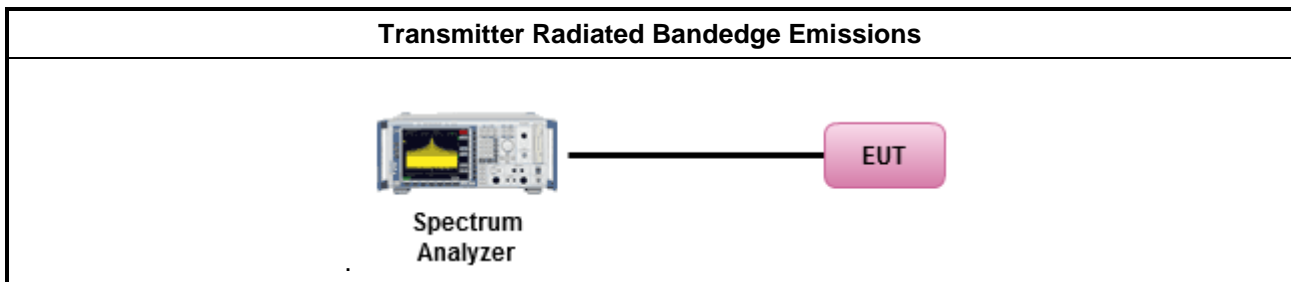

3.6.5 Test Result of Emissions in non-restricted frequency bands

This test item is performed on each TX output individually without summing or adding $10 \log(N_{ANT})$ since measurements are made relative to the in-band emissions on the individual outputs. Only worst test result of each operating mode is presented.

3.6.6 Unwanted Emissions into Non-Restricted Frequency Bands

802.11b

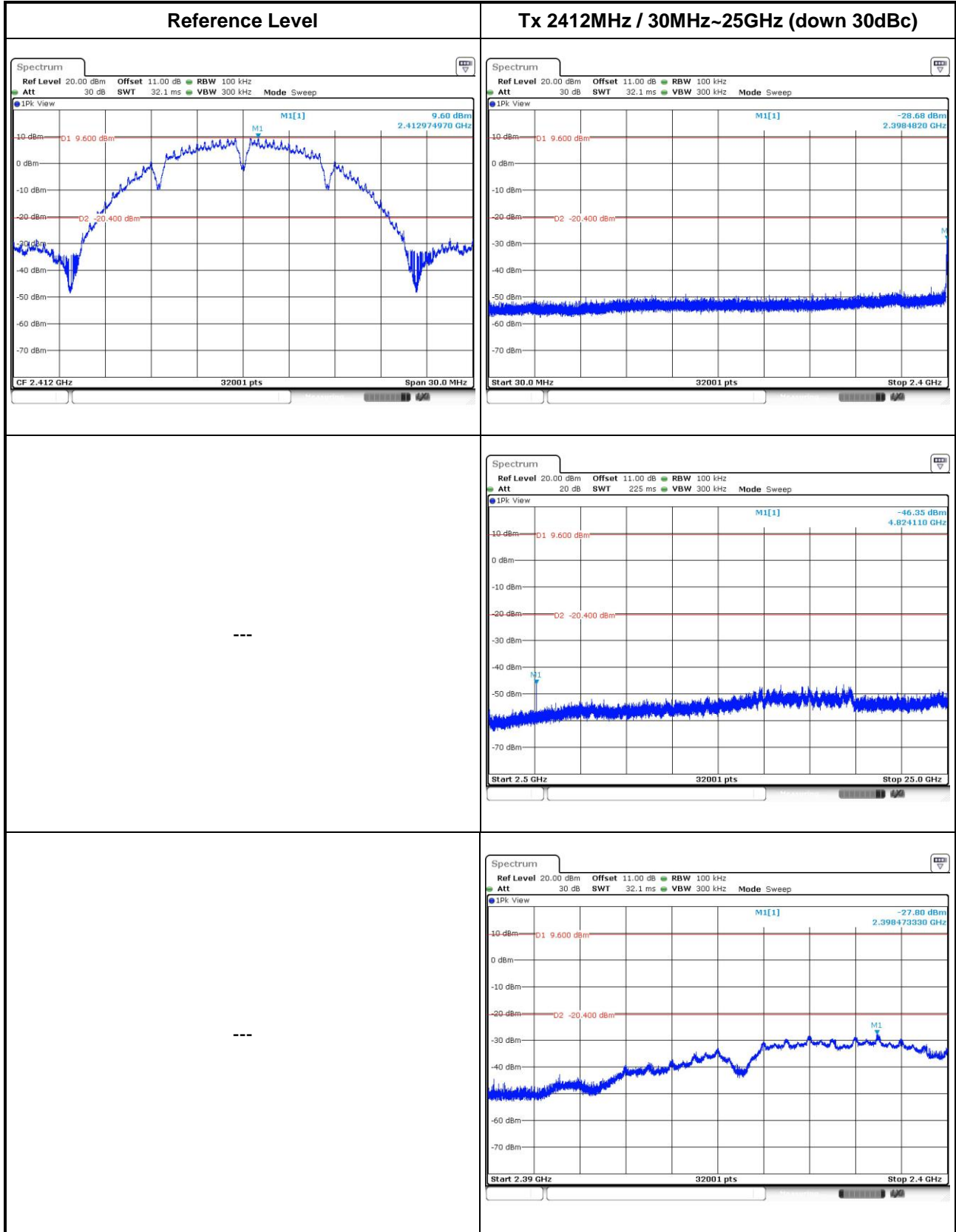

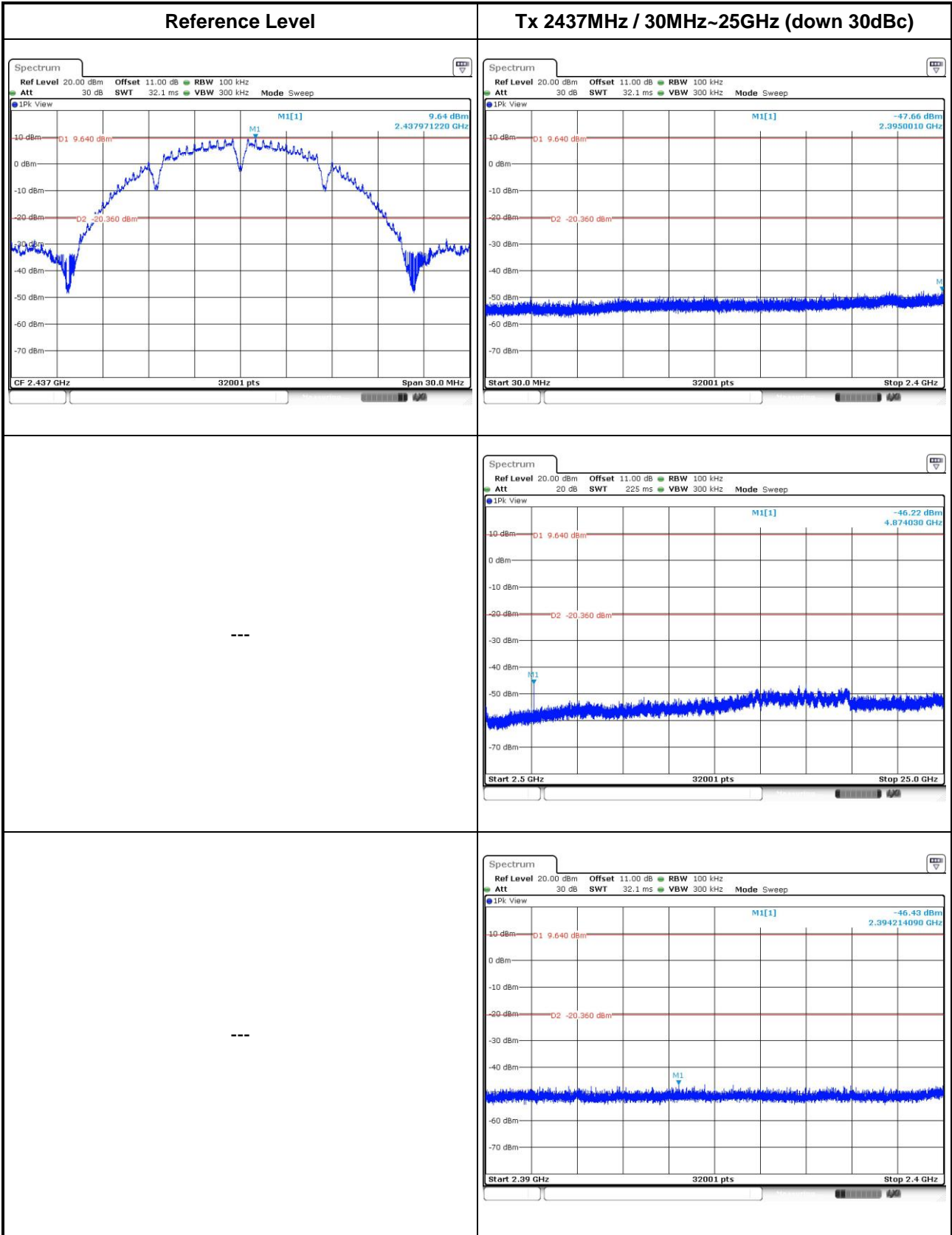

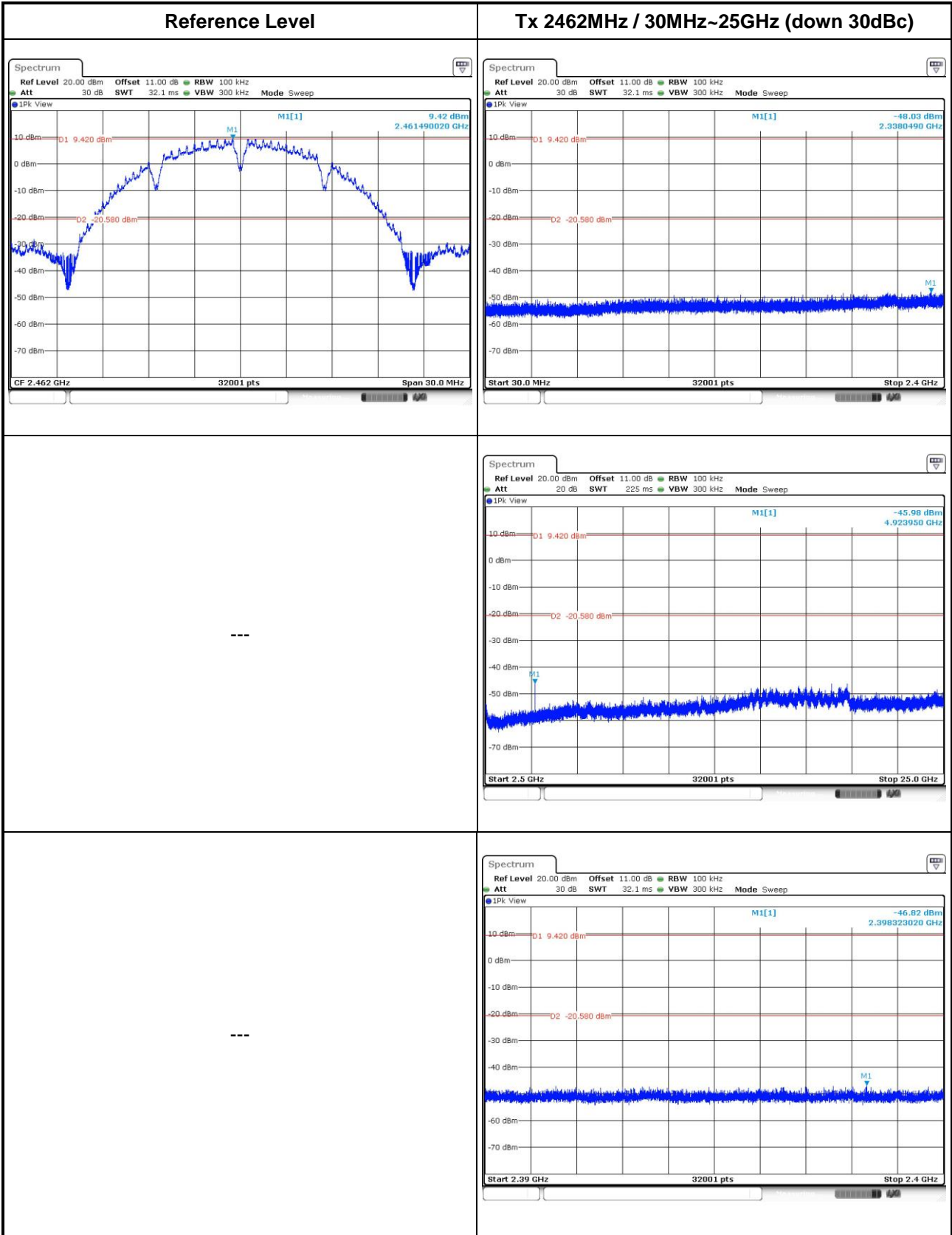

802.11g

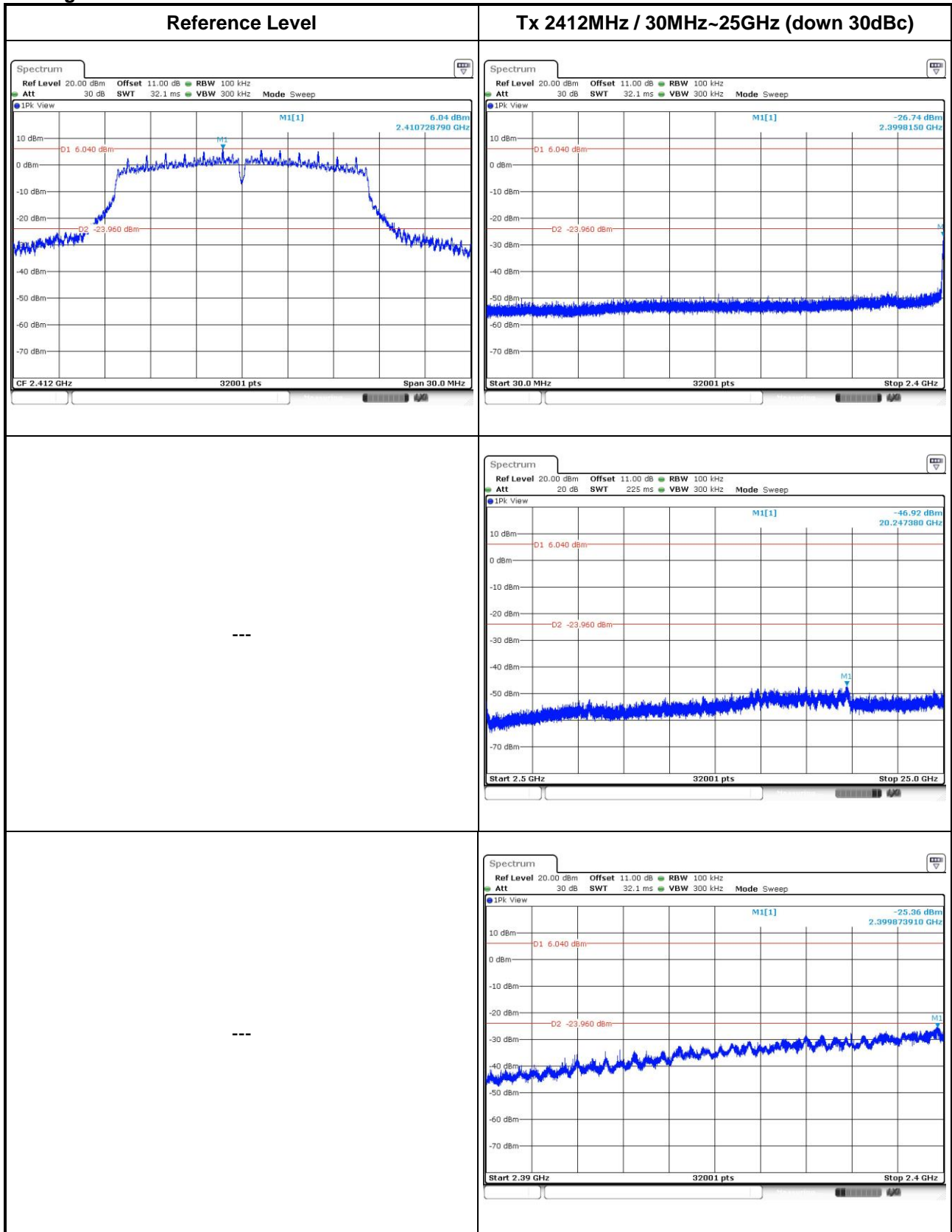

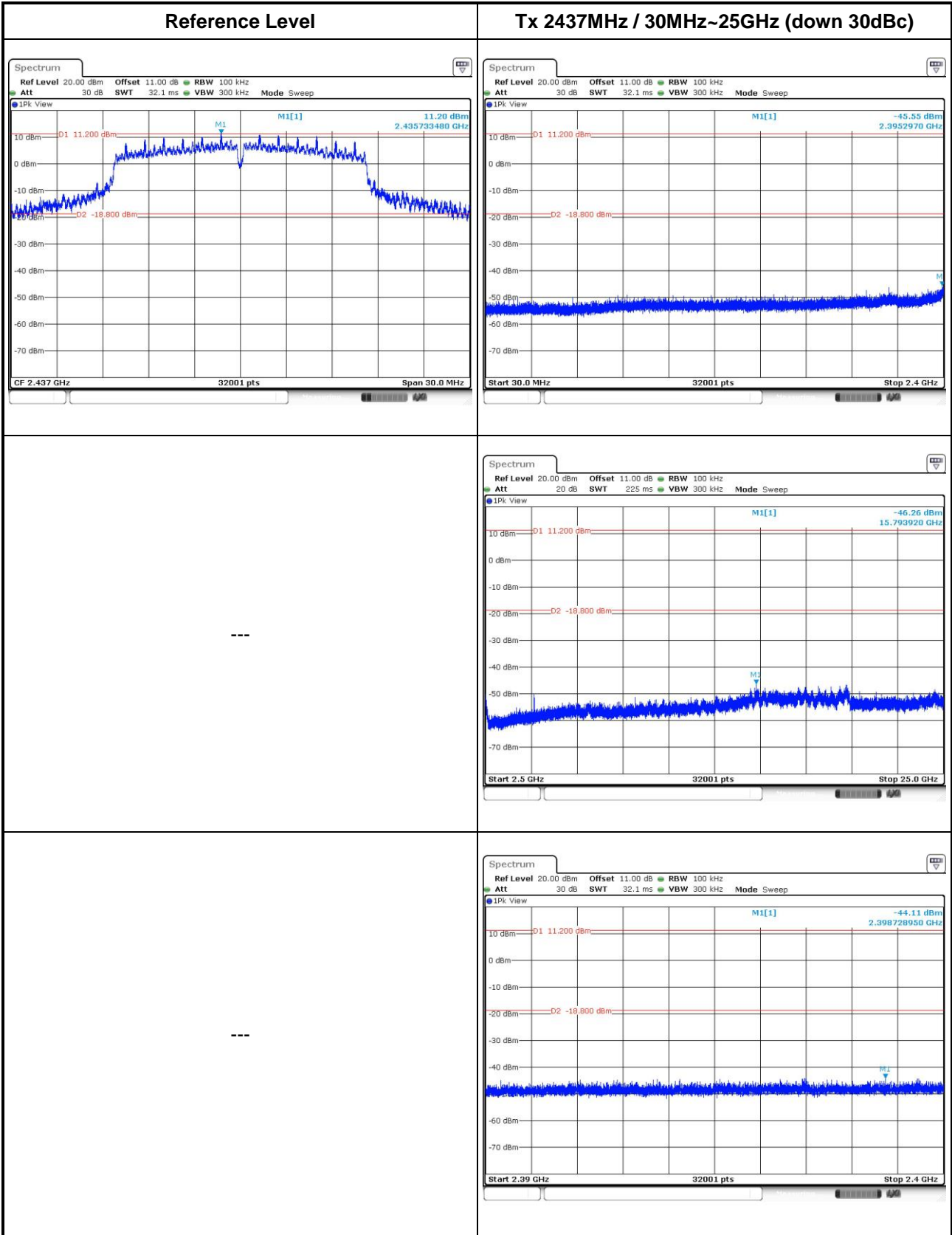

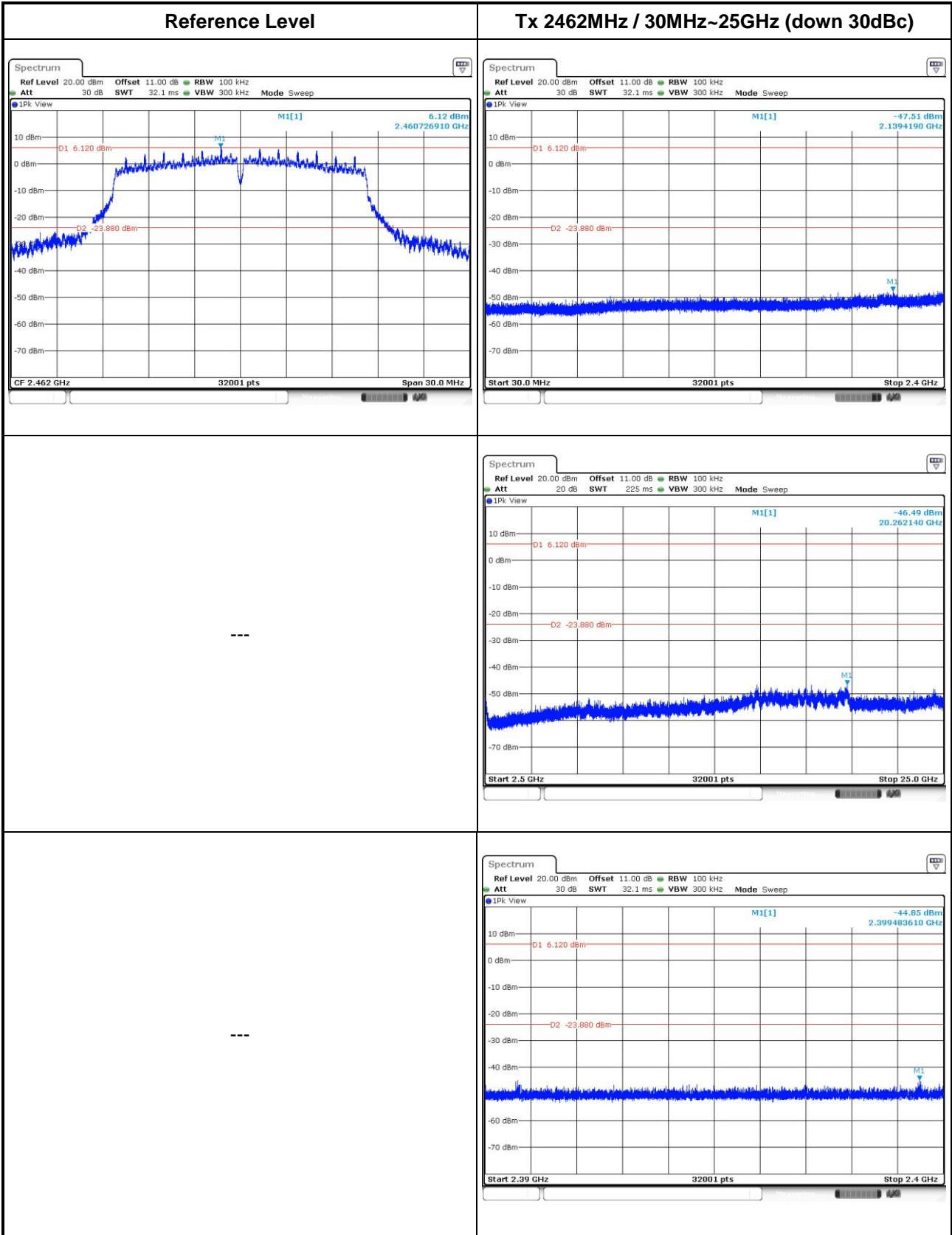

802.11n HT20

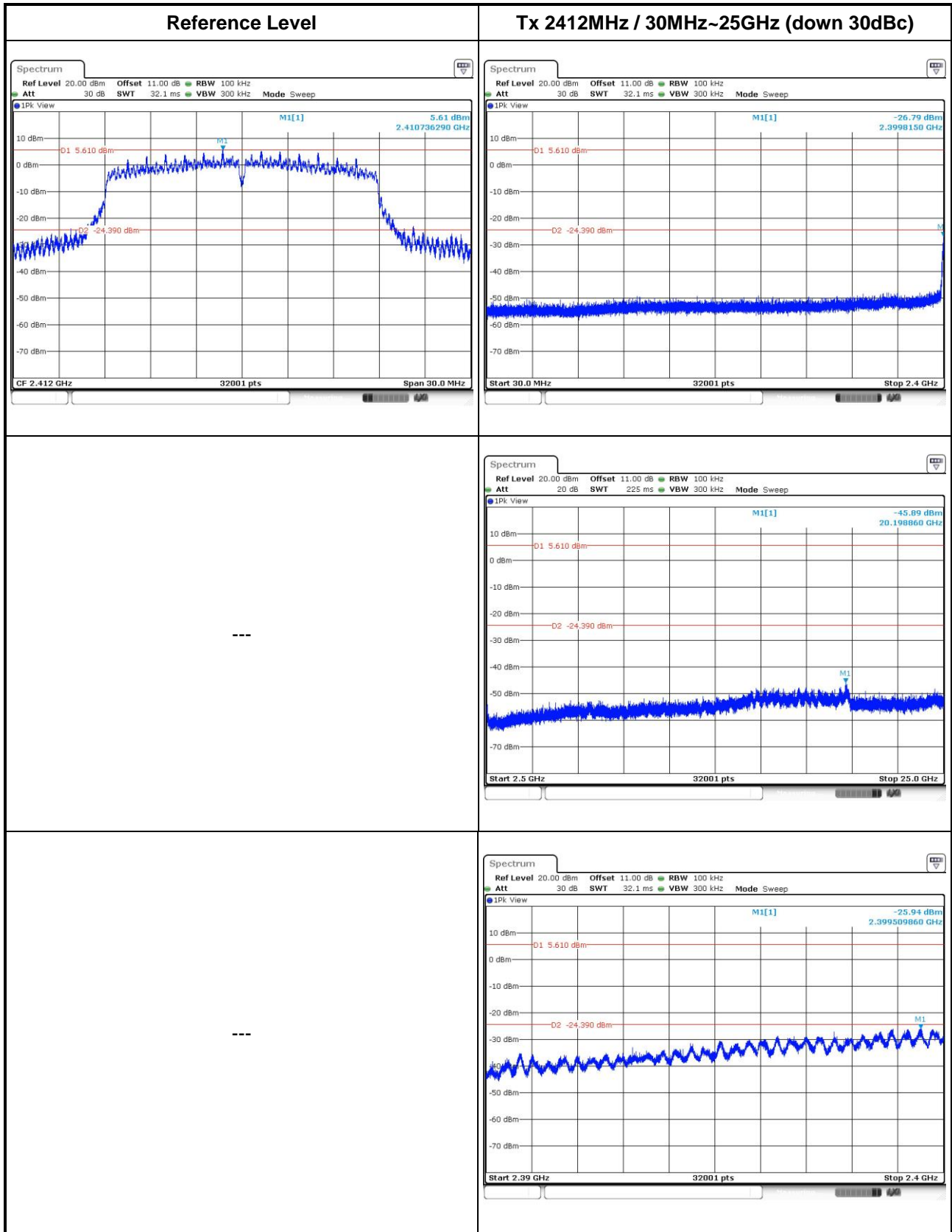

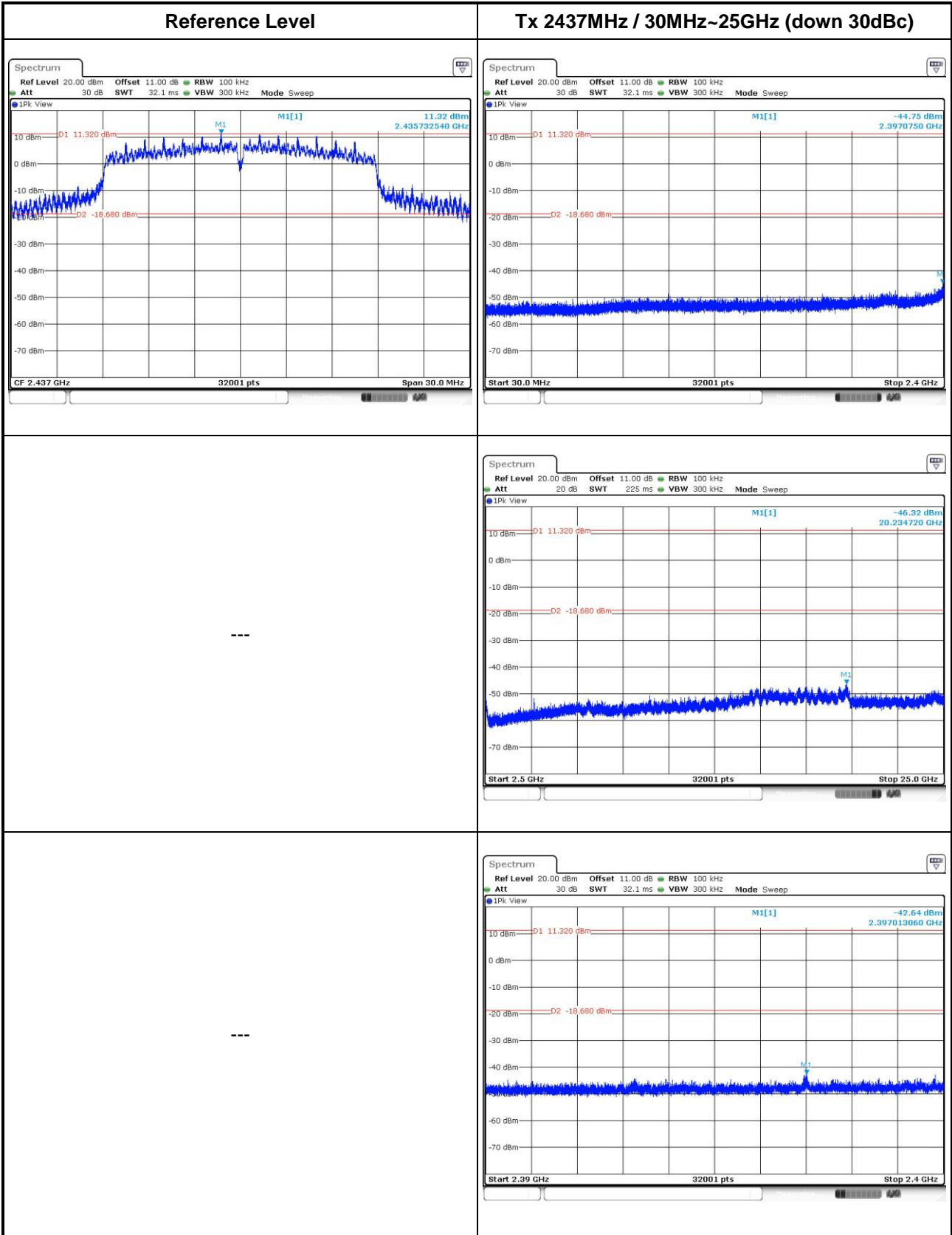

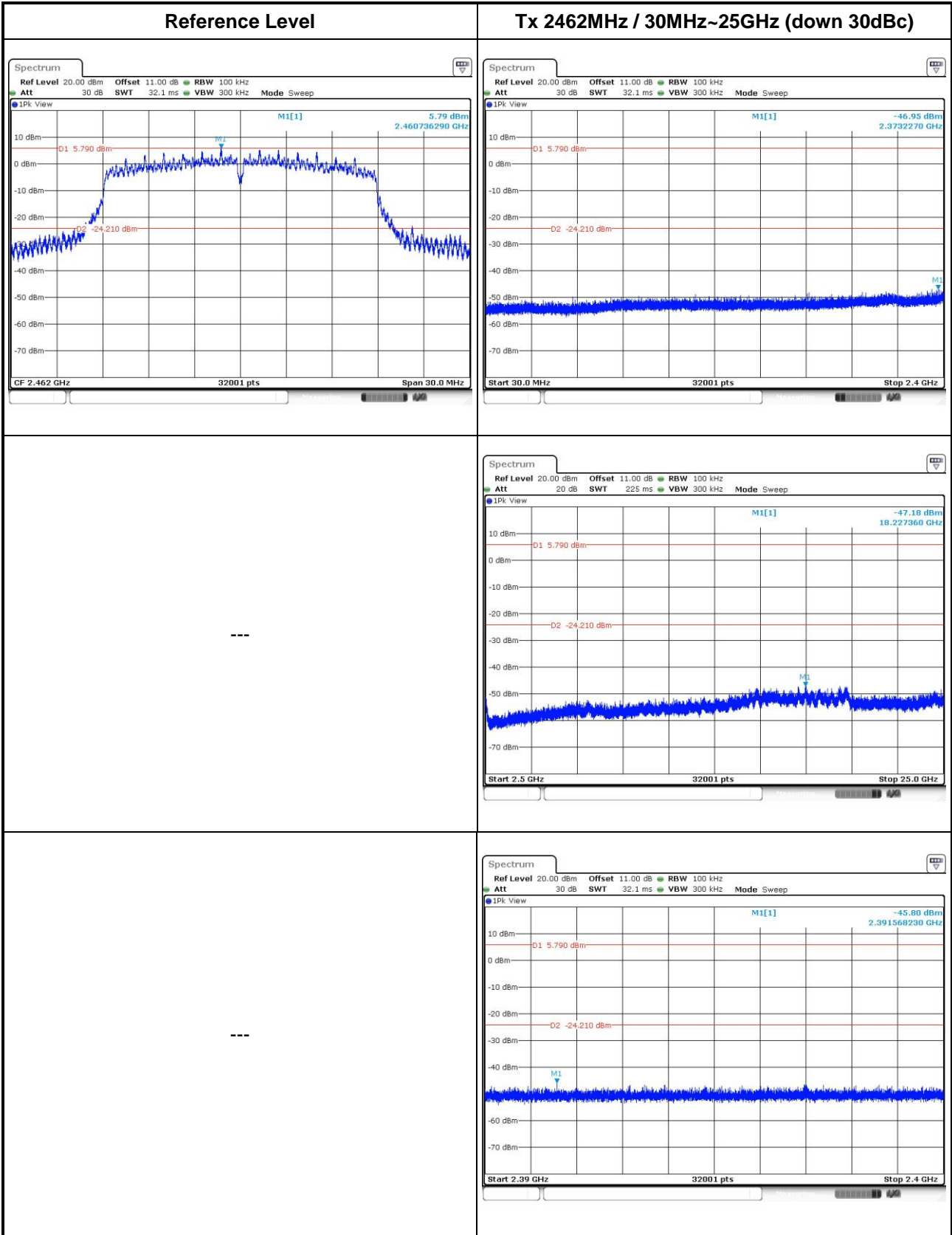

802.11n HT40

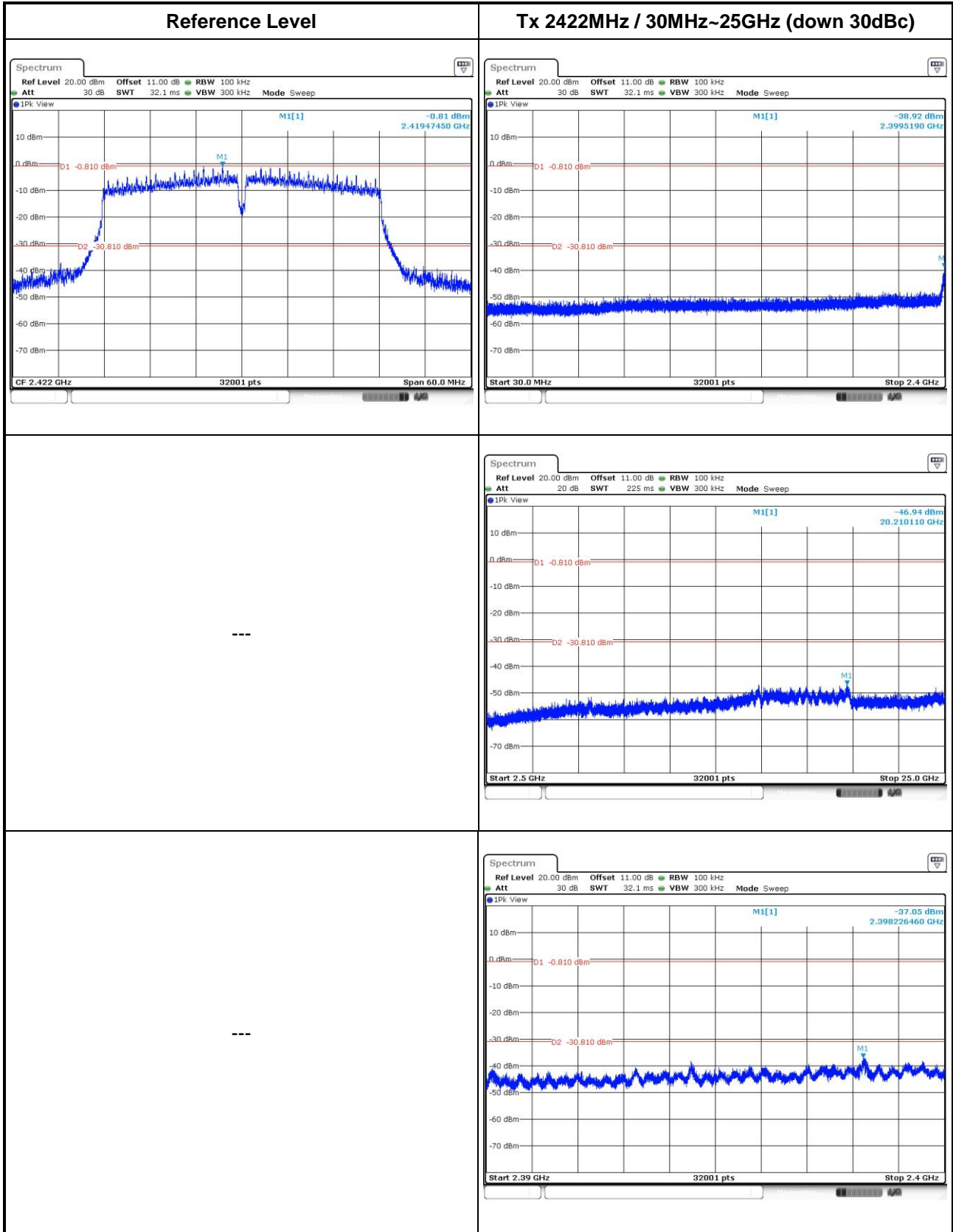

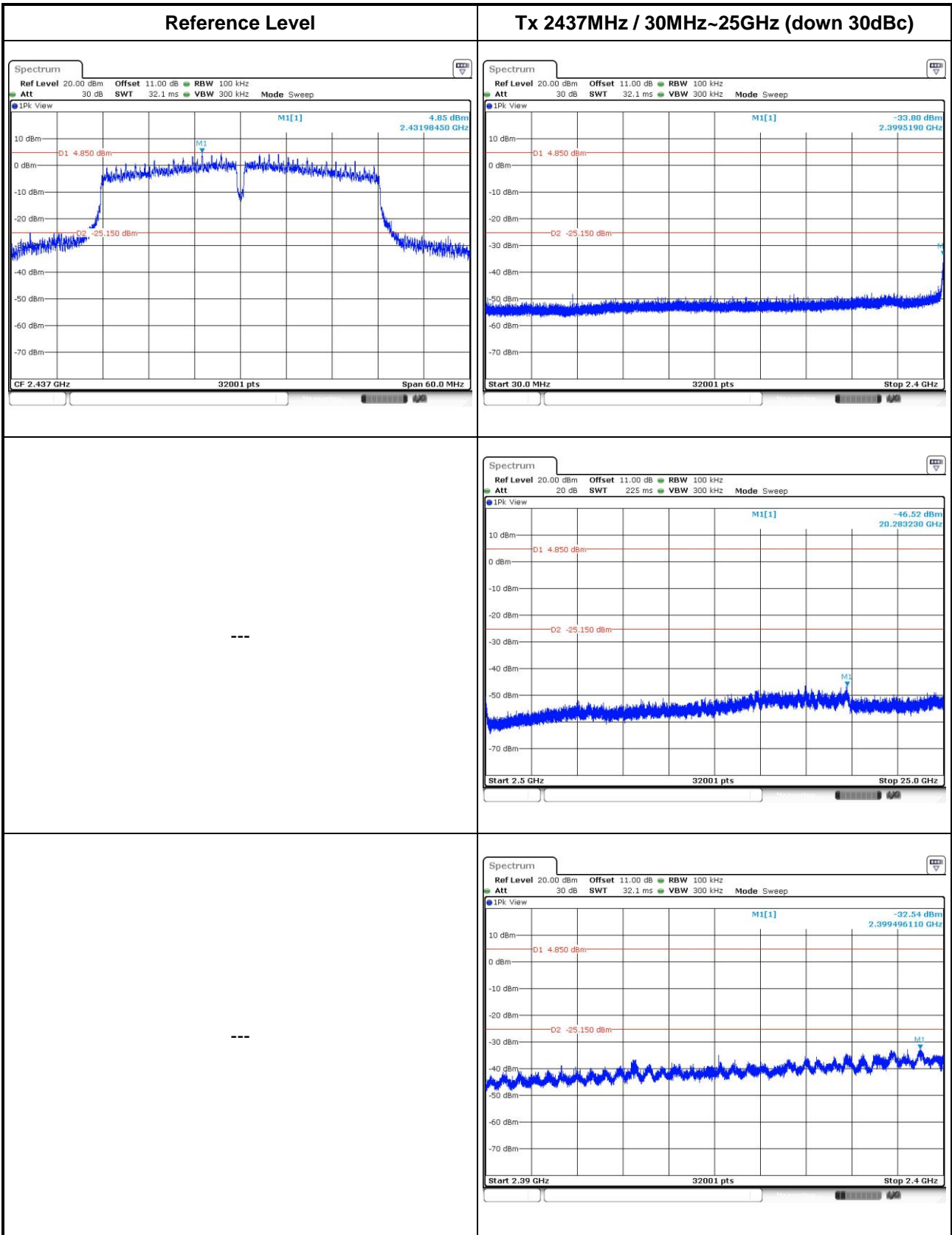

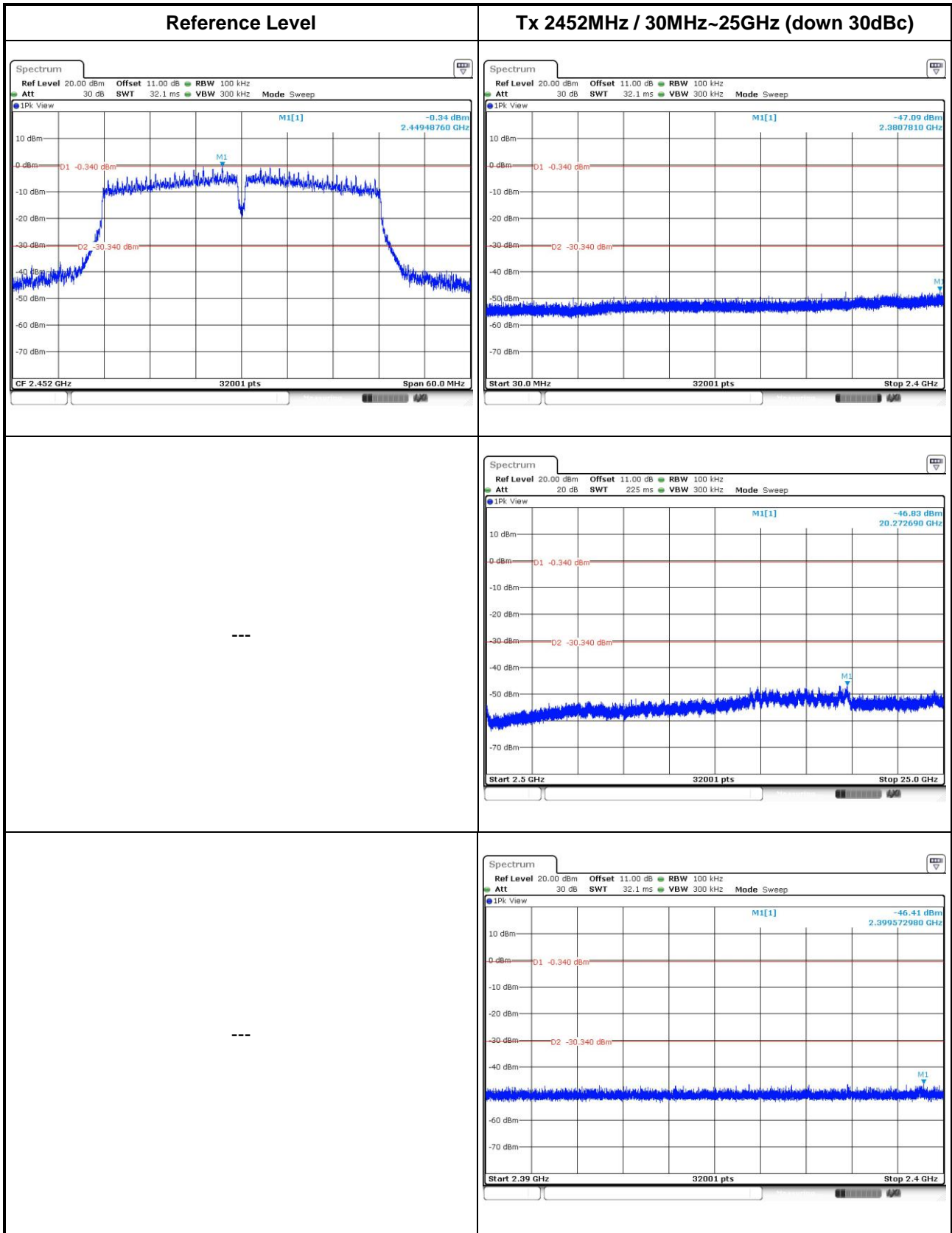

4 Test laboratory information

Established in 2012, ICC provides foremost EMC & RF Testing and advisory consultation services by our skilled engineers and technicians. Our services employ a wide variety of advanced edge test equipment and one of the widest certification extents in the business.

International Certification Corp, it is our definitive objective is to institute long term, trust-based associations with our clients. The expectation we set up with our clients is based on outstanding service, practical expertise and devotion to a certified value structure. Our passion is to grant our clients with best EMC / RF services by oriented knowledgeable and accommodating staff.

Our Test sites are located at Linkou District and Kwei Shan Hsiang. Location map can be found on our website <http://www.icertifi.com.tw>.

Linkou

Tel: 886-2-2601-1640

No. 30-2, Ding Fwu Tsuen, Lin Kou
District, New Taipei City, Taiwan,
R.O.C.

Kwei Shan

Tel: 886-3-271-8666

No. 3-1, Lane 6, Wen San 3rd
St., Kwei Shan Hsiang, Tao Yuan
Hsien 333, Taiwan, R.O.C.

Kwei Shan Site II

Tel: 886-3-271-8640

No. 14-1, Lane 19, Wen San 3rd
St., Kwei Shan Hsiang, Tao Yuan
Hsien 333, Taiwan, R.O.C.

If you have any suggestion, please feel free to contact us as below information

Tel: 886-3-271-8666

Fax: 886-3-318-0155

Email: ICC_Service@icertifi.com.tw

==END==