

REV	DESCRIPTION OF REVISION	ENG APPD	DATE
01	INITIAL DOCUMENT CREATION	R HU	13JAN14

NOTE:

1. REFER TO NETGEAR SPEC. DOC-00093 FOR COLOR TOLERANCES.
2. INK COLOR IS SHOWN TO THE RIGHT.
3. DIE LINES ARE MAGENTA COLOR AND DO NOT PRINT.
4. IMEI & SERIAL NUMBERS TO BE PRINTED BY THE ODM.
5. SN and IMEI barcode to be encoded Code128 and include printed characters below barcodes.
BARCODE LENGTH SHOULD FIT THE LABEL SIZE

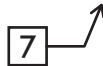
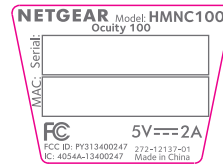

-  Pantone COOL GREY 11 C
-  LABEL COLOR WHITE

7. INSURE COUNTRY OF ORIGIN IS CORRECT.
 - A. IF COUNTRY OF ORIGIN IS PRE-PRINTED, UNHIDE THE APPROPRIATE COUNTRY OF ORIGIN LAYER AND INCLUDE COUNTRY OF ORIGIN ON LABEL.
 - B. IF COUNTRY OF ORIGIN IS POST-PRINTED USING A THERMAL PRINTER (OR EQUIVALENT), OMIT TEXT FROM ARTWORK (USE LAYERS).

AUTHOR:	R HU	TITLE:	AW, HMNC100,PLBL	NETGEAR	
SHEET:	1 of 1	THIS DOCUMENT AND THE DATA DISCLOSED HEREIN OR WHEREWITH IS NOT TO BE REPRODUCED, USED OR DISCLOSED IN WHOLE OR IN PART TO ANYONE WITHOUT THE PERMISSION OF NETGEAR, INC.		P/N:	AW-12791-01
				REV:	01

A. Label Position:

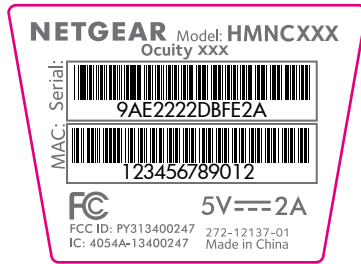

Scale: 1/1

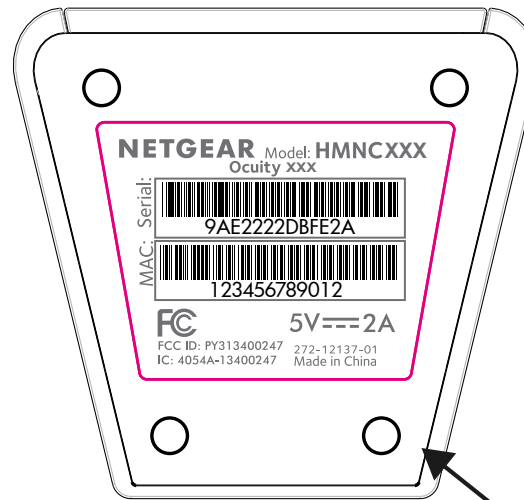

Stand

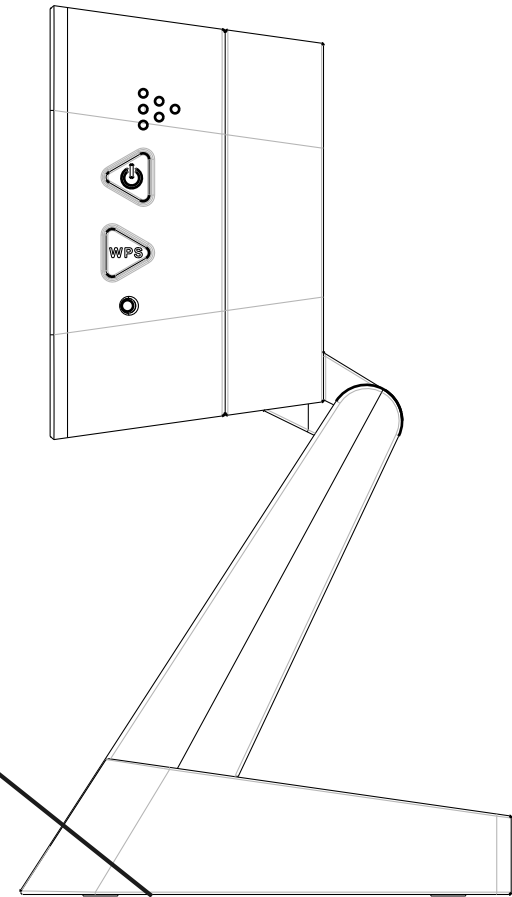

B. Label Position:

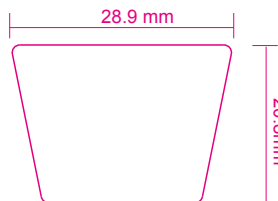

Scale: 1/1

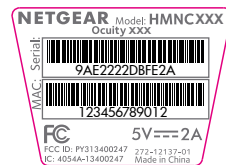

- Pantone COOL GREY 11 C
- LABEL COLOR WHITE

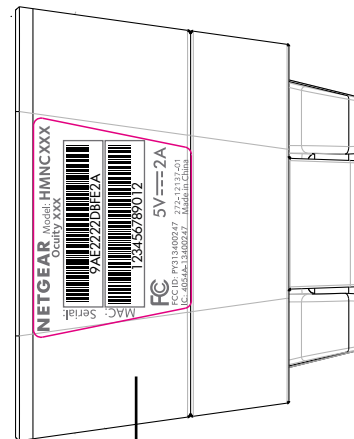

Material: Rubber