

FCC Test Report

Report No.: RF150807E06-1

FCC ID: PY313200233

Test Model: R7000

Series Model: R6900, R6700

Received Date: Aug. 07, 2015

Test Date: Sep. 17 to 24, 2015

Issued Date: Oct. 01, 2015

Applicant: NETGEAR, Inc.

Address: 350 East Plumeria Drive San Jose, CA 95134

Issued By: Bureau Veritas Consumer Products Services (H.K.) Ltd., Taoyuan Branch
Hsin Chu Laboratory

Lab Address: No. 81-1, Lu Liao Keng, 9th Ling, Wu Lung Tsuen, Chiung Lin Hsiang, Hsin
Chu Hsien 307, Taiwan R.O.C.

Test Lab A: Bureau Veritas Consumer Products Services (H.K.) Ltd., Taoyuan Branch
Hsin Chu Laboratory

Test Location (1): E-2, No.1, Li Hsin 1st Road, Hsinchu Science Park, Hsinchu City 300,
Taiwan R.O.C.

Test Lab B: Bureau Veritas Consumer Products Services (H.K.) Ltd., Taoyuan Branch
Lin Kou Laboratories

Test Location: No. 19, Hwa Ya 2nd Rd., Wen Hwa Tsuen, Kwei Shan Hsiang, Taoyuan
Hsien 33383, Taiwan, R.O.C.



This report is for your exclusive use. Any copying or replication of this report to or for any other person or entity, or use of our name or trademark, is permitted only with our prior written permission. This report sets forth our findings solely with respect to the test samples identified herein. The results set forth in this report are not indicative or representative of the quality or characteristics of the lot from which a test sample was taken or any similar or identical product unless specifically and expressly noted. Our report includes all of the tests requested by you and the results thereof based upon the information that you provided to us. You have 60 days from date of issuance of this report to notify us of any material error or omission caused by our negligence, provided, however, that such notice shall be in writing and shall specifically address the issue you wish to raise. A failure to raise such issue within the prescribed time shall constitute your unqualified acceptance of the completeness of this report, the tests conducted and the correctness of the report contents. Unless specific mention, the uncertainty of measurement has been explicitly taken into account to declare the compliance or non-compliance to the specification. The report must not be used by the client to claim product certification, approval, or endorsement by TAF or any government agencies. This report contains Radiated Emissions & Band Edge (Above 1GHz) test data that was produced under subcontract by Bureau Veritas Consumer Products Services (H.K.) Ltd., Taoyuan Branch Lin Kou Laboratories.

Table of Contents

Release Control Record	4
1 Certificate of Conformity	5
2 Summary of Test Results	6
2.1 Measurement Uncertainty.....	6
2.2 Modification Record.....	6
3 General Information	7
3.1 General Description of EUT (5GHz U-NII-3 band).....	7
3.2 Description of Test Modes.....	10
3.2.1 Test Mode Applicability and Tested Channel Detail.....	11
3.3 Duty Cycle of Test Signal.....	13
3.4 Description of Support Units.....	14
3.4.1 Configuration of System under Test.....	15
3.5 General Description of Applied Standard.....	16
4 Test Types and Results	17
4.1 Radiated Emission and Bandedge Measurement.....	17
4.1.1 Limits of Radiated Emission and Bandedge Measurement.....	17
4.1.2 Test Instruments.....	18
4.1.3 Test Procedures.....	20
4.1.4 Deviation from Test Standard.....	20
4.1.5 Test Setup.....	21
4.1.6 EUT Operating Conditions.....	21
4.1.7 Test Results.....	22
4.2 Transmit Power Measurement.....	32
4.2.1 Limits of Transmit Power Measurement.....	32
4.2.2 Test Setup.....	32
4.2.3 Test Instruments.....	33
4.2.4 Test Procedures.....	33
4.2.5 Deviation from Test Standard.....	33
4.2.6 EUT Operating Conditions.....	33
4.2.7 Test Results.....	34
4.3 Peak Power Spectral Density Measurement.....	35
4.3.1 Limits of Peak Power Spectral Density Measurement.....	35
4.3.2 Test Setup.....	35
4.3.3 Test Instruments.....	35
4.3.4 Test Procedures.....	36
4.3.5 Deviation from Test Standard.....	36
4.3.6 EUT Operating Conditions.....	36
4.3.7 Test Results.....	37
4.4 Frequency Stability Measurement.....	40
4.4.1 Limits of Frequency Stability Measurement.....	40
4.4.2 Test Setup.....	40
4.4.3 Test Instruments.....	40
4.4.4 Test Procedures.....	41
4.4.5 Deviation from Test Standard.....	41
4.4.6 EUT Operating Conditions.....	41
4.4.7 Test Results.....	42
4.5 6dB Bandwidth Measurement.....	43
4.5.1 Limits of 6dB Bandwidth Measurement.....	43
4.5.2 Test Setup.....	43
4.5.3 Test Instruments.....	43
4.5.4 Test Procedures.....	43
4.5.5 Deviation from Test Standard.....	43
4.5.6 EUT Operating Conditions.....	43



4.5.7 Test Results 44

5 Pictures of Test Arrangements..... 46

Appendix – Information on the Testing Laboratories 47



A D T

Release Control Record

Issue No.	Description	Date Issued
RF150807E06-1	Original release.	Oct. 01, 2015



1 Certificate of Conformity

Product: R7000 AC1900 Smart WiFi Router,
R6900 AC1900 Smart WiFi Router,
AC1750 Smart WiFi Router

Brand: NETGEAR

Test Model: R7000

Series Model: R6900, R6700

Sample Status: MASS-PRODUCTION

Applicant: NETGEAR, Inc.

Test Date: Sep. 17 to 24, 2015

Standard: 47 CFR FCC Part 15, Subpart E (Section 15.407)
ANSI C63.10: 2013

The above equipment has been tested by **Bureau Veritas Consumer Products Services (H.K.) Ltd., Taoyuan Branch**, and found compliance with the requirement of the above standards. The test record, data evaluation & Equipment Under Test (EUT) configurations represented herein are true and accurate accounts of the measurements of the sample's EMC characteristics under the conditions specified in this report. This report contains Radiated Emissions & Band Edge (Above 1GHz) test data that was produced under subcontract by Bureau Veritas Consumer Products Services (H.K.) Ltd., Taoyuan Branch Lin Kou Laboratories.

Prepared by : Phoenix Huang , **Date:** Oct. 01, 2015
Phoenix Huang / Specialist

Approved by : May Chen , **Date:** Oct. 01, 2015
May Chen / Manager

2 Summary of Test Results

47 CFR FCC Part 15, Subpart E (SECTION 15.407)			
FCC Clause	Test Item	Result	Remarks
15.407(b) (1/2/3/4/6)	Radiated Emissions & Band Edge Measurement	Pass	Meet the requirement of limit. Minimum passing margin is -0.1dB at 5714.00MHz
15.407(a)(1/2 /3)	Max Average Transmit Power	Pass	Meet the requirement of limit.
15.407(a)(1/2 /3)	Peak Power Spectral Density	Pass	Meet the requirement of limit.
15.407(e)	6dB bandwidth	Pass	Meet the requirement of limit. (U-NII-3 Band only)
15.407(g)	Frequency Stability	Pass	Meet the requirement of limit.
15.203	Antenna Requirement	Pass	Antenna connector is Re-SMA not a standard connector.

NOTE: 1. This report is prepared for FCC Class II change. (Upgrade the standard to section 15.407 under new rule for U-NII-3 band)

2.1 Measurement Uncertainty

Where relevant, the following measurement uncertainty levels have been estimated for tests performed on the EUT as specified in CISPR 16-4-2:

Measurement	Frequency	Expanded Uncertainty (k=2) (±)
Radiated Emissions up to 1 GHz	30MHz ~ 1GHz	5.43 dB
Radiated Emissions above 1 GHz	1GHz ~ 6GHz	3.65 dB
	6GHz ~ 18GHz	3.88 dB
	18GHz ~ 40GHz	4.11 dB

2.2 Modification Record

There were no modifications required for compliance.

3 General Information

3.1 General Description of EUT (5GHz U-NII-3 band)

Product	R7000 AC1900 Smart WiFi Router, R6900 AC1900 Smart WiFi Router, AC1750 Smart WiFi Router
Brand	NETGEAR
Test Model	R7000
Series Model	R6900, R6700
Status of EUT	MASS-PRODUCTION
Power Supply Rating	12Vdc from power adapter
Modulation Type	64QAM, 16QAM, QPSK, BPSK for OFDM 256QAM for OFDM in 11ac mode and VHT20 and VHT40 mode of 2.4GHz Band.
Modulation Technology	OFDM
Transfer Rate	802.11a: up to 54Mbps 802.11n: up to 450Mbps 802.11ac: up to 1300Mbps
Operating Frequency	5.745GHz ~ 5.825GHz
Number of Channel	802.11a, 802.11n (HT20), 802.11ac (VHT20): 5 802.11n (HT40), 802.11ac (VHT40): 2 802.11ac (VHT80): 1
Output Power	5GHz: (U-NII-3) CDD Mode: 802.11a: 340.685mW Beamforming Mode: 802.11ac (VHT20): 280.578mW 802.11ac (VHT40): 235.428mW 802.11ac (VHT80): 102.768mW
Antenna Type	Refer to Note
Antenna Connector	Refer to Note
Accessory Device	Adapter x 1
Data Cable Supplied	NA

Note:

1. This report is prepared for FCC Class II change. The differences between them are as below information:

- ◆ Upgrade the standard to section 15.407 under new rule for U-NII-3 band.
- ◆ Add one product name and model name.

Original		
Product name	Model	Description
R7000 AC1900 Smart WiFi Router	R7000	-
AC1750 Smart WiFi Router	R6700	The difference between R7000 and R6700 is that R6700 removes one USB connector and components. And the software of R6700 limits 2.4GHz from 256QAM to 64QAM.
Newly		
Product name	Model	Description
R6900 AC1900 Smart WiFi Router	R6900	The main different between R7000 and R6900 is that R6900 remove one USB connector and related circuit.
From the above models, model: R7000 was selected as representative model for the test and its data was recorded in this report.		

2. According to above conditions, all test items of U-NII-3 band need to be performed (except for Conducted Emission test item). And all data was verified to meet the requirements.

3. The EUT must be supplied with a power adapter and the following different models could be chosen:

No.	Brand	Model No.	P/N	Spec.
1	NETGEAR	AD898F20	332-10613-01	AC input: 100-120V, 50/60Hz, 1.0A DC output: 12V, 3.5A DC output cable: 1.8m, unshielded
2	NETGEAR	2AAF042F NA	332-10618-01	AC input: 100-240V, 50/60Hz, 1.5A DC output: 12V, 3.5A DC output cable: 1.8m, unshielded

Note: For the original test report: the EUT was pre-tested with above adapters, for radiated emission test the worse case was found in **Adapter 2**. Therefore only the test data of the adapter was recorded in this report.

4. The antennas provided to the EUT, please refer to the following table:

Antenna No.	Antenna Type	Antenna Gain (dBi)	Frequency range (GHz ~ GHz)	Connector Type
1	Dipole	0.6	2.4~2.4835	Re-SMA
		0.9	5.15~5.85	
2	Dipole	0.6	2.4~2.4835	Re-SMA
		0.9	5.15~5.85	
3	Dipole	0.6	2.4~2.4835	Re-SMA
		0.9	5.15~5.85	

5. 2.4GHz & 5GHz technology can transmit at same time.

6. The EUT incorporates a MIMO function with beamforming.

For 2.4GHz Band			
MODULATION MODE	DATA RATE (MCS)	TX & RX CONFIGURATION	
802.11b	1 ~ 11Mbps	3TX	3RX
802.11g	6 ~ 54Mbps	3TX	3RX
802.11n (HT20) & 802.11n (HT40)	MCS 0~7	3TX	3RX
	MCS 8~15	3TX	3RX
	MCS 16~23	3TX	3RX
VHT20	MCS0~8 Nss= 1	3TX	3RX
	MCS0~8 Nss= 2	3TX	3RX
	MCS0~9 Nss= 3	3TX	3RX
VHT40	MCS0~9 Nss= 1	3TX	3RX
	MCS0~9 Nss= 2	3TX	3RX
	MCS0~9 Nss= 3	3TX	3RX
For 5GHz Band			
MODULATION MODE	DATA RATE (MCS)	TX & RX CONFIGURATION	
802.11a	6 ~ 54Mbps	3TX	3RX
802.11n (HT20) & 802.11n (HT40)	MCS 0~7	3TX	3RX
	MCS 8~15	3TX	3RX
	MCS 16~23	3TX	3RX
802.11ac (VHT20)	MCS0~8 Nss= 1	3TX	3RX
	MCS0~8 Nss= 2	3TX	3RX
	MCS0~9 Nss= 3	3TX	3RX
802.11ac (VHT40) & 802.11ac (VHT80)	MCS0~9 Nss= 1	3TX	3RX
	MCS0~9 Nss= 2	3TX	3RX
	MCS0~9 Nss= 3	3TX	3RX

Note: 1. The modulation and bandwidth are similar for 802.11n mode for 20MHz (40MHz) and 802.11ac mode for 20MHz (40MHz), therefore investigated worst case to representative mode in test report. (Final test mode refer section 3.2.1)

2. All of modulation mode support beamforming function except 802.11b/g/a modulation mode.

7. The above EUT information is declared by manufacturer and for more detailed features description, please refer to the manufacturer's specifications or user's manual.

3.2 Description of Test Modes

FOR 5745 ~ 5825MHz:

5 channels are provided for 802.11a, 802.11n (HT20), 802.11ac (VHT20):

Channel	Frequency	Channel	Frequency
149	5745MHz	161	5805MHz
153	5765MHz	165	5825MHz
157	5785MHz		

2 channels are provided for 802.11n (HT40), 802.11ac (VHT40):

Channel	Frequency	Channel	Frequency
151	5755MHz	159	5795MHz

1 channel is provided for 802.11ac (VHT80):

Channel	Frequency
155	5775MHz

3.2.1 Test Mode Applicability and Tested Channel Detail

EUT CONFIGURE MODE	APPLICABLE TO				DESCRIPTION
	RE≥1G	RE<1G	PLC	APCM	
-	√	√	-	√	-

Where **RE≥1G**: Radiated Emission above 1GHz **RE<1G**: Radiated Emission below 1GHz
PLC: Power Line Conducted Emission **APCM**: Antenna Port Conducted Measurement

NOTE:

1. The test mode was reference to the worst case in the original test report.
2. "-" means no effect.

Radiated Emission Test (Above 1GHz):

- Pre-Scan has been conducted to determine the worst-case mode from all possible combinations between available modulations, data rates and antenna ports (if EUT with antenna diversity architecture).
- Following channel(s) was (were) selected for the final test as listed below.

CDD Mode						
MODE	FREQ. BAND (MHz)	AVAILABLE CHANNEL	TESTED CHANNEL	MODULATION TECHNOLOGY	MODULATION TYPE	DATA RATE (Mbps)
802.11a	5745-5825	149 to 165	149, 157, 165	OFDM	BPSK	6
Beamforming Mode						
MODE	FREQ. BAND (MHz)	AVAILABLE CHANNEL	TESTED CHANNEL	MODULATION TECHNOLOGY	MODULATION TYPE	DATA RATE (Mbps)
802.11ac (VHT20)	5745-5825	149 to 165	149, 157, 165	OFDM	BPSK	6.5
802.11ac (VHT40)		151 to 159	151, 159	OFDM	BPSK	13.5
802.11ac (VHT80)		155	155	OFDM	BPSK	29.3

Radiated Emission Test (Below 1GHz):

- Pre-Scan has been conducted to determine the worst-case mode from all possible combinations between available modulations, data rates and antenna ports (if EUT with antenna diversity architecture).
- Following channel(s) was (were) selected for the final test as listed below.

CDD Mode						
MODE	FREQ. BAND (MHz)	AVAILABLE CHANNEL	TESTED CHANNEL	MODULATION TECHNOLOGY	MODULATION TYPE	DATA RATE (Mbps)
802.11a	5745-5825	149 to 165	149	OFDM	BPSK	6

Antenna Port Conducted Measurement:

- This item includes all test value of each mode, but only includes spectrum plot of worst value of each mode.
- Pre-Scan has been conducted to determine the worst-case mode from all possible combinations between available modulations, data rates and antenna ports (if EUT with antenna diversity architecture).
- Following channel(s) was (were) selected for the final test as listed below.

CDD Mode						
MODE	FREQ. BAND (MHz)	AVAILABLE CHANNEL	TESTED CHANNEL	MODULATION TECHNOLOGY	MODULATION TYPE	DATA RATE (Mbps)
802.11a	5745-5825	149 to 165	149, 157, 165	OFDM	BPSK	6
Beamforming Mode						
MODE	FREQ. BAND (MHz)	AVAILABLE CHANNEL	TESTED CHANNEL	MODULATION TECHNOLOGY	MODULATION TYPE	DATA RATE (Mbps)
802.11ac (VHT20)	5745-5825	149 to 165	149, 157, 165	OFDM	BPSK	6.5
802.11ac (VHT40)		151 to 159	151, 159	OFDM	BPSK	13.5
802.11ac (VHT80)		155	155	OFDM	BPSK	29.3

Test Condition:

APPLICABLE TO	ENVIRONMENTAL CONDITIONS	INPUT POWER	TESTED BY
RE≥1G	21deg. C, 68%RH	120Vac, 60Hz	Andy Ho
RE<1G	25deg. C, 69%RH	120Vac, 60Hz	Robert Cheng
APCM	25deg. C, 60%RH	120Vac, 60Hz	Gary Cheng

3.3 Duty Cycle of Test Signal

If duty cycle of test signal is $\geq 98\%$, duty factor is not required.
 If duty cycle of test signal is $< 98\%$, duty factor shall be considered.

802.11a: Duty cycle = $2.064 \text{ ms} / 2.084 \text{ ms} = 0.99$

802.11ac (VHT20): Duty cycle = $1.919 \text{ ms} / 1.94 \text{ ms} = 0.989$

802.11ac (VHT40): Duty cycle = $0.946 \text{ ms} / 0.964 \text{ ms} = 0.981$

802.11ac (VHT80): Duty cycle = $0.458 \text{ ms} / 0.481 \text{ ms} = 0.952$, Duty factor = $10 * \log(1/0.952) = 0.21$

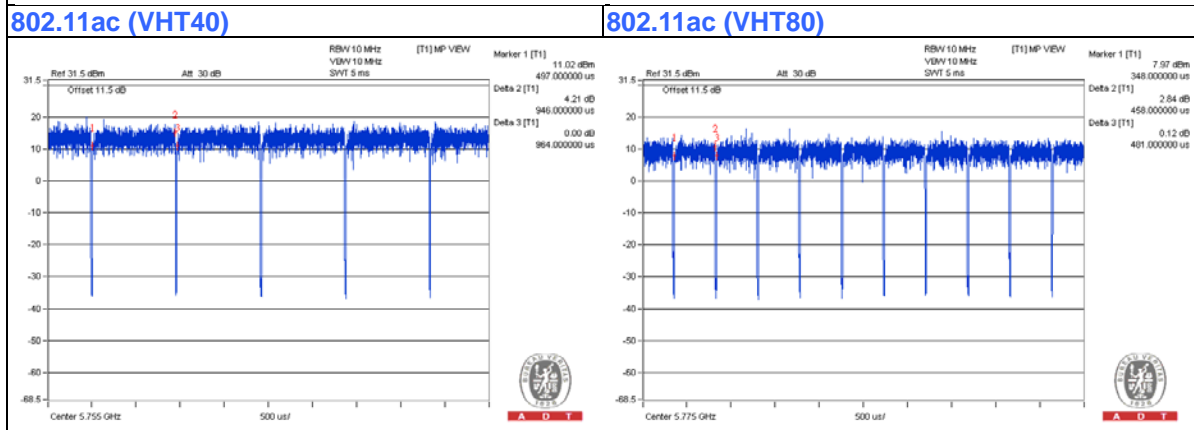
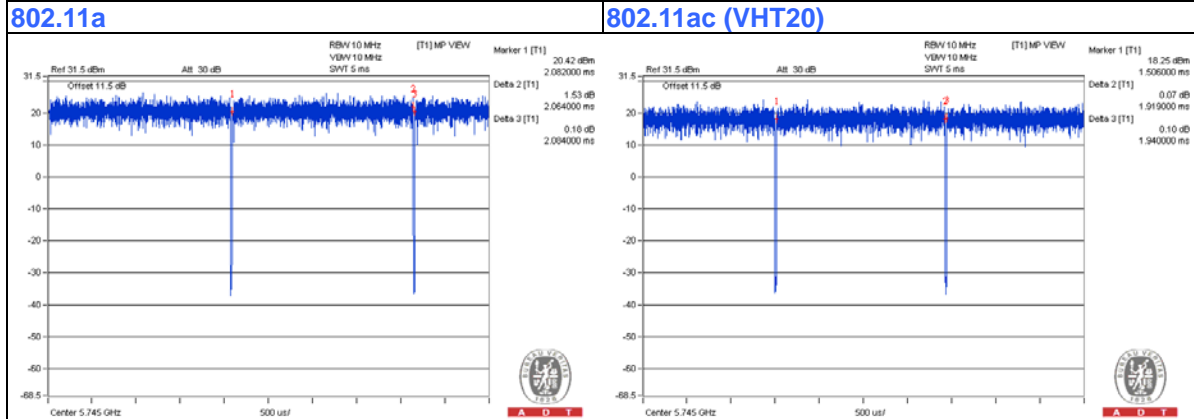

3.4 Description of Support Units

The EUT has been tested as an independent unit together with other necessary accessories or support units. The following support units or accessories were used to form a representative test configuration during the tests.

ID	Product	Brand	Model No.	Serial No.	FCC ID	Remarks
A.	iPod shuffle	Apple	MC749TA/A	CC4DMFJUDFDM	NA	Provided by Lab
B.	Notebook Computer	DELL	E5430	4YV4VY1	FCC DoC	Provided by Lab
C.	Notebook Computer	DELL	E5430	HYV4VY1	FCC DoC	Provided by Lab
D.	HUB	ZyXEL	ES-116P	S060H02000215	FCC DoC	Provided by Lab
E.	External Hard Drive	WD	WDBACW0010HB K-SESN	WCAZAL625787	FCC DoC	Provided by Lab

Note:

1. All power cords of the above support units are non-shielded (1.8m).

ID	Descriptions	Qty.	Length (m)	Shielding (Yes/No)	Cores (Qty.)	Remarks
1.	DC	1	1.8	No	0	Supplied by Client
2.	USB	1	0.1	Yes	0	Provided by Lab
3.	RJ-45	1	10	No	0	Provided by Lab
4.	RJ-45	1	10	No	0	Provided by Lab
5.	RJ-45	3	10	No	0	Provided by Lab
6.	USB	1	0.45	Yes	0	Provided by Lab

3.4.1 Configuration of System under Test

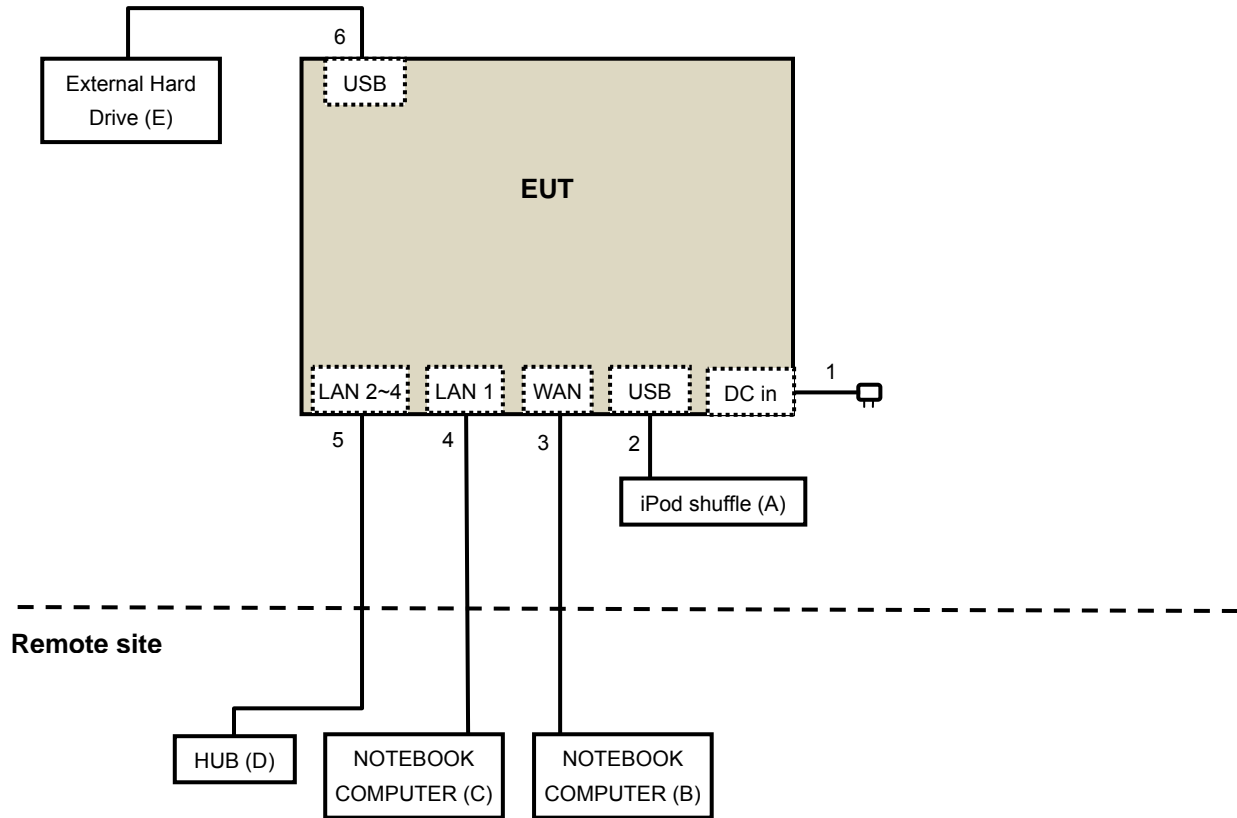

3.5 General Description of Applied Standard

The EUT is a RF Product. According to the specifications of the manufacturer, it must comply with the requirements of the following standards:

FCC Part 15, Subpart E (15.407)

789033 D02 General UNII Test Procedure New Rules v01

662911 D01 Multiple Transmitter Output v02r01

ANSI C63.10-2013

All test items have been performed and recorded as per the above standards.

NOTE: The EUT has been verified to comply with the requirements of FCC Part 15, Subpart B, Class B (DoC). The test report has been issued separately.

4 Test Types and Results

4.1 Radiated Emission and Bandedge Measurement

4.1.1 Limits of Radiated Emission and Bandedge Measurement

Radiated emissions which fall in the restricted bands must comply with the radiated emission limits specified as below table.

Frequencies (MHz)	Field Strength (microvolts/meter)	Measurement Distance (meters)
0.009 ~ 0.490	2400/F(kHz)	300
0.490 ~ 1.705	24000/F(kHz)	30
1.705 ~ 30.0	30	30
30 ~ 88	100	3
88 ~ 216	150	3
216 ~ 960	200	3
Above 960	500	3

NOTE:

1. The lower limit shall apply at the transition frequencies.
2. Emission level (dBuV/m) = 20 log Emission level (uV/m).
3. For frequencies above 1000MHz, the field strength limits are based on average detector, however, the peak field strength of any emission shall not exceed the maximum permitted average limits, specified above by more than 20dB under any condition of modulation.

LIMITS OF UNWANTED EMISSION OUT OF THE RESTRICTED BANDS

APPLICABLE TO	LIMIT	
789033 D02 General UNII Test Procedure New Rules v01	FIELD STRENGTH AT 3m	
	PK:74 (dBuV/m)	AV:54 (dBuV/m)
APPLICABLE TO	EIRP LIMIT	EQUIVALENT FIELD STRENGTH AT 3m
15.407(b)(1)	PK:-27 (dBm/MHz)	PK:68.2(dBuV/m)
15.407(b)(2)		
15.407(b)(3)		
15.407(b)(4)	PK:-27 (dBm/MHz) ^{*1} PK:-17 (dBm/MHz) ^{*2}	PK:68.2 (dBuV/m) ^{*1} PK:78.2 (dBuV/m) ^{*2}

NOTE: ^{*1} beyond 10MHz of the band edge ^{*2} within 10 MHz of band edge

The following formula is used to convert the equipment isotropic radiated power (eirp) to field strength:

$$E = \frac{1000000\sqrt{30P}}{3} \mu\text{V/m, where P is the eirp (Watts).$$

4.1.2 Test Instruments

For Above 1GHz:

DESCRIPTION & MANUFACTURER	MODEL NO.	SERIAL NO.	CALIBRATED DATE	CALIBRATED UNTIL
Test Receiver ROHDE & SCHWARZ	ESCI	100424	Oct. 06, 2014	Oct. 05, 2015
Spectrum Analyzer ROHDE & SCHWARZ	FSP40	100040	July 08, 2015	July 07, 2016
BILOG Antenna SCHWARZBECK	VULB9168	9168-155	Feb. 06, 2015	Feb. 05, 2016
HORN Antenna SCHWARZBECK	BBHA 9120D	9120D-1170	Feb. 05, 2015	Feb. 04, 2016
HORN Antenna SCHWARZBECK	BBHA 9170	BBHA9170241	Feb. 09, 2015	Feb. 08, 2016
Preamplifier Agilent	8449B	3008A01960	Aug. 09, 2015	Aug. 08, 2016
Preamplifier Agilent	8447D	2944A10631	Aug. 09, 2015	Aug. 08, 2016
RF signal cable HUBER+SUHNER	SUCOFLEX 104	Cable-CH4-02(295012+309220)	Aug. 09, 2015	Aug. 08, 2016
RF signal cable HUBER+SUHNER	SUCOFLEX 104	Cable-CH4-03(250724)	Aug. 09, 2015	Aug. 08, 2016
Software BV ADT	ADT_Radiated_V7.6.15.9.4	NA	NA	NA
Antenna Tower inn-co GmbH	MA 4000	010303	NA	NA
Antenna Tower Controller BV ADT	AT100	AT93021703	NA	NA
Turn Table BV ADT	TT100	TT93021703	NA	NA
Turn Table Controller BV ADT	SC100.	SC93021703	NA	NA
26GHz ~ 40GHz Amplifier	EM26400	815221	Oct. 18, 2014	Oct. 17, 2015
High Speed Peak Power Meter	ML2495A	0824011	July 09, 2015	July 08, 2016
Power Sensor	MA2411B	0738171	July 09, 2015	July 08, 2016
WIT Standard Temperature And Humidity Chamber	TH-4S-C	W981030	June 08, 2015	June 07, 2016
Mini-Circuits Power Splitter	ZN2PD-9G	NA	June 09, 2015	June 08, 2016
JFW 20dB attenuation	50HF-020-SMA	NA	NA	NA

- Note: 1. The calibration interval of the above test instruments is 12 months and the calibrations are traceable to NML/ROC and NIST/USA.
 2. The test was performed in HwaYa Chamber 4.
 3. The horn antenna and preamplifier (model: 8449B) are used only for the measurement of emission frequency above 1GHz if tested.
 4. The FCC Site Registration No. is 460141.
 5. The IC Site Registration No. is IC7450F-4.
 6. Tested Date: Sep. 24, 2015

**For Below 1GHz:**

DESCRIPTION & MANUFACTURER	MODEL NO.	SERIAL NO.	CALIBRATED DATE	CALIBRATED UNTIL
Test Receiver Agilent	N9038A	MY51210202	Dec. 12, 2014	Dec. 11, 2015
Pre-Amplifier Mini-Circuits	ZFL-1000VH2 B	AMP-ZFL-04	Nov. 12, 2014	Nov. 11, 2015
Trilog Broadband Antenna SCHWARZBECK	VULB 9168	9168-361	Feb. 09, 2015	Feb. 08, 2016
RF Cable	8D-FB	CHHCAB-001- 1	Oct. 05, 2014	Oct. 04, 2015
		CHHCAB-001- 2		
	RF-141	CHHCAB-004	Oct. 05, 2014	Oct. 04, 2015
Software	ADT_Radiated _V8.7.07	NA	NA	NA
Antenna Tower & Turn Table CT	NA	NA	NA	NA

Note:

1. The calibration interval of the above test instruments is 12 months and the calibrations are traceable to NML/ROC and NIST/USA.
2. The test was performed in 966 Chamber No. H.
3. The FCC Site Registration No. is 797305.
4. The CANADA Site Registration No. is IC 7450H-3.
5. Tested Date: Sep. 17, 2015

4.1.3 Test Procedures

- a. The EUT was placed on the top of a rotating table 0.8 meters (for below 1GHz) / 1.5 meters (for above 1GHz) above the ground at 3 meter chamber room for test. The table was rotated 360 degrees to determine the position of the highest radiation.
- b. The EUT was set 3 meters away from the interference-receiving antenna, which was mounted on the top of a variable-height antenna tower.
- c. The height of antenna is varied from one meter to four meters above the ground to determine the maximum value of the field strength. Both horizontal and vertical polarizations of the antenna are set to make the measurement.
- d. For each suspected emission, the EUT was arranged to its worst case and then the antenna was tuned to heights from 1 meter to 4 meters and the rotatable table was turned from 0 degrees to 360 degrees to find the maximum reading.
- e. The test-receiver system was set to quasi-peak detect function and specified bandwidth with maximum hold mode when the test frequency is below 1 GHz.
- f. The test-receiver system was set to peak and average detect function and specified bandwidth with maximum hold mode when the test frequency is above 1 GHz. If the peak reading value also meets average limit, measurement with the average detector is unnecessary.

Note:

1. The resolution bandwidth and video bandwidth of test receiver/spectrum analyzer is 120kHz for Quasi-peak detection (QP) at frequency below 1GHz.
2. The resolution bandwidth of test receiver/spectrum analyzer is 1 MHz and the video bandwidth is 3 MHz for Peak detection (PK) at frequency above 1GHz.
3. The resolution bandwidth of test receiver/spectrum analyzer is 1MHz and the video bandwidth is 3MHz for RMS Average (Duty cycle < 98%) for Average detection (AV) at frequency above 1GHz, then the measurement results was added to a correction factor ($10 \log(1/\text{duty cycle})$).
4. The resolution bandwidth of test receiver/spectrum analyzer is 1MHz and the video bandwidth is 10Hz (Duty cycle $\geq 98\%$) for Average detection (AV) at frequency above 1GHz.
5. All modes of operation were investigated and the worst-case emissions are reported.

4.1.4 Deviation from Test Standard

No deviation.

4.1.5 Test Setup

<Frequency Range below 1GHz>

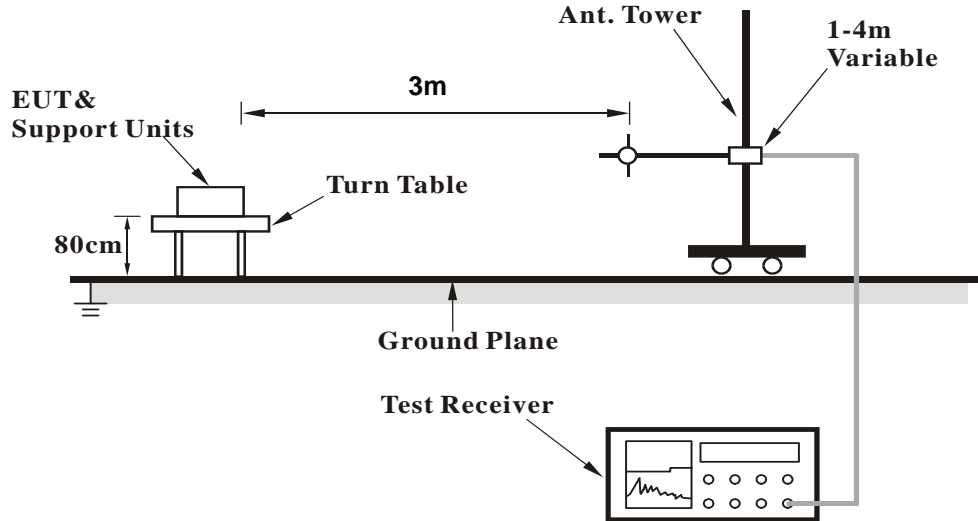

<Frequency Range above 1GHz>

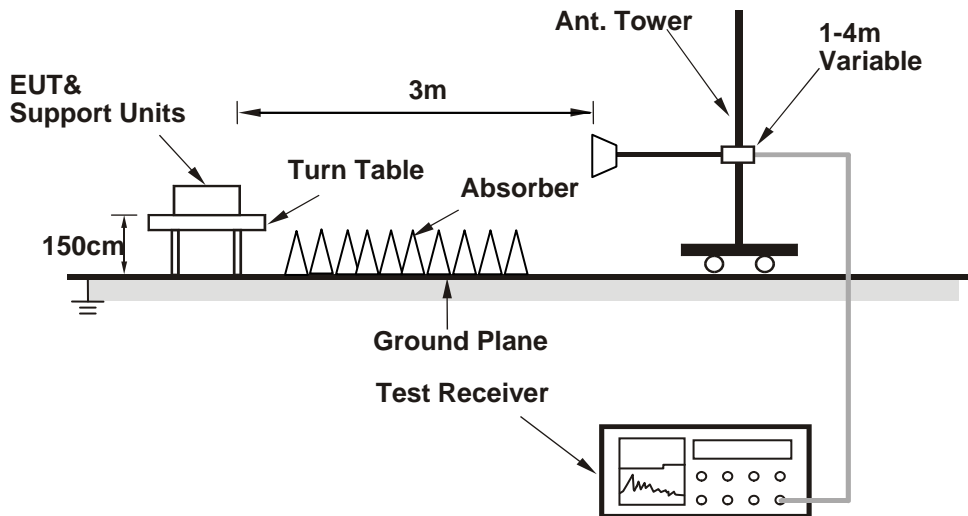

For the actual test configuration, please refer to the attached file (Test Setup Photo).

4.1.6 EUT Operating Conditions

1. Connect the EUT with the support unit C (Notebook Computer) which is placed in remote site.
2. The communication partner run test program "MTool.exe_2.0.1.1" to enable EUT under transmission/receiving condition continuously at specific channel frequency.

4.1.7 Test Results
Subcontract Item
Above 1GHz Data
CDD Mode
802.11a

CHANNEL	TX Channel 149	DETECTOR FUNCTION	Peak (PK)
FREQUENCY RANGE	1GHz ~ 40GHz		Average (AV)

ANTENNA POLARITY & TEST DISTANCE: HORIZONTAL AT 3 M								
NO.	FREQ. (MHz)	EMISSION LEVEL (dBuV/m)	LIMIT (dBuV/m)	MARGIN (dB)	ANTENNA HEIGHT (m)	TABLE ANGLE (Degree)	RAW VALUE (dBuV)	CORRECTION FACTOR (dB/m)
1	#5582.00	61.3 PK	68.2	-6.9	1.85 H	106	50.67	10.63
2	#5715.00	64.3 PK	74.0	-9.7	1.64 H	105	53.25	11.05
3	#5715.00	47.2 AV	54.0	-6.8	1.64 H	105	36.15	11.05
4	#5725.00	67.8 PK	78.2	-10.4	1.64 H	105	56.72	11.08
5	*5745.00	111.2 PK			1.64 H	105	100.06	11.14
6	*5745.00	101.4 AV			1.64 H	105	90.26	11.14
7	11490.00	51.2 PK	74.0	-22.8	1.45 H	278	34.48	16.72
8	11490.00	38.4 AV	54.0	-15.6	1.45 H	278	21.68	16.72
9	#17235.00	55.9 PK	74.0	-18.1	1.24 H	287	30.05	25.85
10	#17235.00	43.8 AV	54.0	-10.2	1.24 H	287	17.95	25.85

ANTENNA POLARITY & TEST DISTANCE: VERTICAL AT 3 M								
NO.	FREQ. (MHz)	EMISSION LEVEL (dBuV/m)	LIMIT (dBuV/m)	MARGIN (dB)	ANTENNA HEIGHT (m)	TABLE ANGLE (Degree)	RAW VALUE (dBuV)	CORRECTION FACTOR (dB/m)
1	#5582.00	67.7 PK	68.2	-0.5	2.00 V	2	57.07	10.63
2	#5715.00	72.7 PK	74.0	-1.3	2.02 V	14	61.65	11.05
3	#5715.00	52.6 AV	54.0	-1.4	2.02 V	14	41.55	11.05
4	#5725.00	76.1 PK	78.2	-2.1	2.02 V	14	65.02	11.08
5	*5745.00	122.0 PK			2.02 V	14	110.86	11.14
6	*5745.00	112.2 AV			2.02 V	14	101.06	11.14
7	11490.00	57.0 PK	74.0	-17.0	1.83 V	239	40.28	16.72
8	11490.00	43.7 AV	54.0	-10.3	1.83 V	239	26.98	16.72
9	#17235.00	56.5 PK	74.0	-17.5	1.55 V	278	30.65	25.85
10	#17235.00	44.1 AV	54.0	-9.9	1.55 V	278	18.25	25.85

REMARKS:

1. Emission Level(dBuV/m) = Raw Value(dBuV) + Correction Factor(dB/m)
2. Correction Factor(dB/m) = Antenna Factor(dB/m) + Cable Factor(dB) – Pre-Amplifier Factor(dB)
3. The other emission levels were very low against the limit.
4. Margin value = Emission Level – Limit value
5. " * ": Fundamental frequency.
6. " # ": The radiated frequency is out of the restricted band.

CHANNEL	TX Channel 157	DETECTOR FUNCTION	Peak (PK)
FREQUENCY RANGE	1GHz ~ 40GHz		Average (AV)

ANTENNA POLARITY & TEST DISTANCE: HORIZONTAL AT 3 M

NO.	FREQ. (MHz)	EMISSION LEVEL (dBuV/m)	LIMIT (dBuV/m)	MARGIN (dB)	ANTENNA HEIGHT (m)	TABLE ANGLE (Degree)	RAW VALUE (dBuV)	CORRECTION FACTOR (dB/m)
1	#5622.00	59.9 PK	68.2	-8.3	1.69 H	113	49.17	10.73
2	*5785.00	110.9 PK			1.64 H	120	99.65	11.25
3	*5785.00	101.2 AV			1.64 H	120	89.95	11.25
4	11570.00	51.6 PK	74.0	-22.4	1.40 H	285	34.38	17.22
5	11570.00	38.5 AV	54.0	-15.5	1.40 H	285	21.28	17.22
6	#17355.00	56.4 PK	74.0	-17.6	1.24 H	301	30.25	26.15
7	#17355.00	44.0 AV	54.0	-10.0	1.24 H	301	17.85	26.15

ANTENNA POLARITY & TEST DISTANCE: VERTICAL AT 3 M

NO.	FREQ. (MHz)	EMISSION LEVEL (dBuV/m)	LIMIT (dBuV/m)	MARGIN (dB)	ANTENNA HEIGHT (m)	TABLE ANGLE (Degree)	RAW VALUE (dBuV)	CORRECTION FACTOR (dB/m)
1	#5622.00	67.9 PK	68.2	-0.3	2.07 V	1	57.17	10.73
2	*5785.00	121.8 PK			1.94 V	4	110.55	11.25
3	*5785.00	112.2 AV			1.94 V	4	100.95	11.25
4	11570.00	57.0 PK	74.0	-17.0	1.83 V	226	39.78	17.22
5	11570.00	43.6 AV	54.0	-10.4	1.83 V	226	26.38	17.22
6	#17355.00	56.1 PK	74.0	-17.9	1.56 V	272	29.95	26.15
7	#17355.00	43.8 AV	54.0	-10.2	1.56 V	272	17.65	26.15

REMARKS:

1. Emission Level(dBuV/m) = Raw Value(dBuV) + Correction Factor(dB/m)
2. Correction Factor(dB/m) = Antenna Factor(dB/m) + Cable Factor(dB) – Pre-Amplifier Factor(dB)
3. The other emission levels were very low against the limit.
4. Margin value = Emission Level – Limit value
5. " * ": Fundamental frequency.
6. " # ": The radiated frequency is out of the restricted band.

CHANNEL	TX Channel 165	DETECTOR FUNCTION	Peak (PK)
FREQUENCY RANGE	1GHz ~ 40GHz		Average (AV)

ANTENNA POLARITY & TEST DISTANCE: HORIZONTAL AT 3 M

NO.	FREQ. (MHz)	EMISSION LEVEL (dBuV/m)	LIMIT (dBuV/m)	MARGIN (dB)	ANTENNA HEIGHT (m)	TABLE ANGLE (Degree)	RAW VALUE (dBuV)	CORRECTION FACTOR (dB/m)
1	#5662.00	59.7 PK	68.2	-8.5	1.88 H	96	48.84	10.86
2	*5825.00	112.4 PK			1.60 H	106	101.09	11.31
3	*5825.00	102.8 AV			1.60 H	106	91.49	11.31
4	#5850.00	67.5 PK	78.2	-10.7	1.60 H	106	56.20	11.30
5	#5860.00	63.9 PK	74.0	-10.1	1.60 H	106	52.60	11.30
6	#5860.00	46.7 AV	54.0	-7.3	1.60 H	106	35.40	11.30
7	11650.00	50.9 PK	74.0	-23.1	1.45 H	282	33.43	17.47
8	11650.00	38.0 AV	54.0	-16.0	1.45 H	282	20.53	17.47
9	#17475.00	56.6 PK	74.0	-17.4	1.19 H	289	29.71	26.89
10	#17475.00	44.2 AV	54.0	-9.8	1.19 H	289	17.31	26.89

ANTENNA POLARITY & TEST DISTANCE: VERTICAL AT 3 M

NO.	FREQ. (MHz)	EMISSION LEVEL (dBuV/m)	LIMIT (dBuV/m)	MARGIN (dB)	ANTENNA HEIGHT (m)	TABLE ANGLE (Degree)	RAW VALUE (dBuV)	CORRECTION FACTOR (dB/m)
1	#5662.00	68.0 PK	68.2	-0.2	2.30 V	226	57.14	10.86
2	*5825.00	122.4 PK			1.84 V	5	111.09	11.31
3	*5825.00	112.9 AV			1.84 V	5	101.59	11.31
4	#5850.00	76.2 PK	78.2	-2.0	1.84 V	5	64.90	11.30
5	#5860.00	73.1 PK	74.0	-0.9	1.84 V	5	61.80	11.30
6	#5860.00	52.7 AV	54.0	-1.3	1.84 V	5	41.40	11.30
7	11650.00	56.6 PK	74.0	-17.4	1.82 V	215	39.13	17.47
8	11650.00	43.1 AV	54.0	-10.9	1.82 V	215	25.63	17.47
9	#17475.00	56.7 PK	74.0	-17.3	1.52 V	268	29.81	26.89
10	#17475.00	44.2 AV	54.0	-9.8	1.52 V	268	17.31	26.89

REMARKS:

1. Emission Level(dBuV/m) = Raw Value(dBuV) + Correction Factor(dB/m)
2. Correction Factor(dB/m) = Antenna Factor(dB/m) + Cable Factor(dB) – Pre-Amplifier Factor(dB)
3. The other emission levels were very low against the limit.
4. Margin value = Emission Level – Limit value
5. " * ": Fundamental frequency.
6. " # ": The radiated frequency is out of the restricted band.

Beamforming Mode

802.11ac (VHT20)

CHANNEL	TX Channel 149	DETECTOR FUNCTION	Peak (PK)
FREQUENCY RANGE	1GHz ~ 40GHz		Average (AV)

ANTENNA POLARITY & TEST DISTANCE: HORIZONTAL AT 3 M

NO.	FREQ. (MHz)	EMISSION LEVEL (dBuV/m)	LIMIT (dBuV/m)	MARGIN (dB)	ANTENNA HEIGHT (m)	TABLE ANGLE (Degree)	RAW VALUE (dBuV)	CORRECTION FACTOR (dB/m)
1	#5585.00	59.6 PK	68.2	-8.6	1.58 H	115	48.96	10.64
2	#5715.00	63.6 PK	74.0	-10.4	1.56 H	107	52.55	11.05
3	#5715.00	45.5 AV	54.0	-8.5	1.56 H	107	34.45	11.05
4	#5725.00	67.1 PK	78.2	-11.1	1.56 H	107	56.02	11.08
5	*5745.00	107.7 PK			1.56 H	107	96.56	11.14
6	*5745.00	98.3 AV			1.56 H	107	87.16	11.14
7	11490.00	50.7 PK	74.0	-23.3	1.50 H	273	33.98	16.72
8	11490.00	37.6 AV	54.0	-16.4	1.50 H	273	20.88	16.72
9	#17235.00	56.5 PK	74.0	-17.5	1.14 H	305	30.65	25.85
10	#17235.00	44.1 AV	54.0	-9.9	1.14 H	305	18.25	25.85

ANTENNA POLARITY & TEST DISTANCE: VERTICAL AT 3 M

NO.	FREQ. (MHz)	EMISSION LEVEL (dBuV/m)	LIMIT (dBuV/m)	MARGIN (dB)	ANTENNA HEIGHT (m)	TABLE ANGLE (Degree)	RAW VALUE (dBuV)	CORRECTION FACTOR (dB/m)
1	#5585.00	67.5 PK	68.2	-0.7	2.27 V	8	56.86	10.64
2	#5715.00	71.0 PK	74.0	-3.0	2.20 V	10	59.95	11.05
3	#5715.00	50.9 AV	54.0	-3.1	2.20 V	10	39.85	11.05
4	#5725.00	75.7 PK	78.2	-2.5	2.20 V	10	64.62	11.08
5	*5745.00	118.1 PK			2.20 V	10	106.96	11.14
6	*5745.00	108.4 AV			2.20 V	10	97.26	11.14
7	11490.00	55.9 PK	74.0	-18.1	1.83 V	223	39.18	16.72
8	11490.00	42.2 AV	54.0	-11.8	1.83 V	223	25.48	16.72
9	#17235.00	56.3 PK	74.0	-17.7	1.53 V	256	30.45	25.85
10	#17235.00	44.0 AV	54.0	-10.0	1.53 V	256	18.15	25.85

REMARKS:

1. Emission Level(dBuV/m) = Raw Value(dBuV) + Correction Factor(dB/m)
2. Correction Factor(dB/m) = Antenna Factor(dB/m) + Cable Factor(dB) – Pre-Amplifier Factor(dB)
3. The other emission levels were very low against the limit.
4. Margin value = Emission Level – Limit value
5. " * ": Fundamental frequency.
6. " # ": The radiated frequency is out of the restricted band.

CHANNEL	TX Channel 157	DETECTOR FUNCTION	Peak (PK)
FREQUENCY RANGE	1GHz ~ 40GHz		Average (AV)

ANTENNA POLARITY & TEST DISTANCE: HORIZONTAL AT 3 M

NO.	FREQ. (MHz)	EMISSION LEVEL (dBuV/m)	LIMIT (dBuV/m)	MARGIN (dB)	ANTENNA HEIGHT (m)	TABLE ANGLE (Degree)	RAW VALUE (dBuV)	CORRECTION FACTOR (dB/m)
1	#5625.00	54.5 PK	68.2	-13.7	1.68 H	115	43.76	10.74
2	*5785.00	101.7 PK			1.54 H	103	90.45	11.25
3	*5785.00	90.8 AV			1.54 H	103	79.55	11.25
4	11570.00	50.6 PK	74.0	-23.4	1.51 H	271	33.38	17.22
5	11570.00	37.6 AV	54.0	-16.4	1.51 H	271	20.38	17.22
6	#17355.00	56.4 PK	74.0	-17.6	1.17 H	310	30.25	26.15
7	#17355.00	44.1 AV	54.0	-9.9	1.17 H	310	17.95	26.15

ANTENNA POLARITY & TEST DISTANCE: VERTICAL AT 3 M

NO.	FREQ. (MHz)	EMISSION LEVEL (dBuV/m)	LIMIT (dBuV/m)	MARGIN (dB)	ANTENNA HEIGHT (m)	TABLE ANGLE (Degree)	RAW VALUE (dBuV)	CORRECTION FACTOR (dB/m)
1	#5625.00	67.6 PK	68.2	-0.6	1.99 V	147	56.86	10.74
2	*5785.00	121.4 PK			1.93 V	9	110.15	11.25
3	*5785.00	111.5 AV			1.93 V	9	100.25	11.25
4	11570.00	57.5 PK	74.0	-16.5	1.83 V	214	40.28	17.22
5	11570.00	44.6 AV	54.0	-9.4	1.83 V	214	27.38	17.22
6	#17355.00	56.2 PK	74.0	-17.8	1.56 V	250	30.05	26.15
7	#17355.00	43.8 AV	54.0	-10.2	1.56 V	250	17.65	26.15

REMARKS:

- Emission Level(dBuV/m) = Raw Value(dBuV) + Correction Factor(dB/m)
- Correction Factor(dB/m) = Antenna Factor(dB/m) + Cable Factor(dB) – Pre-Amplifier Factor(dB)
- The other emission levels were very low against the limit.
- Margin value = Emission Level – Limit value
- " * ": Fundamental frequency.
- " # ": The radiated frequency is out of the restricted band.

CHANNEL	TX Channel 165	DETECTOR FUNCTION	Peak (PK)
FREQUENCY RANGE	1GHz ~ 40GHz		Average (AV)

ANTENNA POLARITY & TEST DISTANCE: HORIZONTAL AT 3 M

NO.	FREQ. (MHz)	EMISSION LEVEL (dBuV/m)	LIMIT (dBuV/m)	MARGIN (dB)	ANTENNA HEIGHT (m)	TABLE ANGLE (Degree)	RAW VALUE (dBuV)	CORRECTION FACTOR (dB/m)
1	#5666.00	54.1 PK	68.2	-14.1	1.87 H	113	43.22	10.88
2	*5825.00	103.3 PK			1.50 H	98	91.99	11.31
3	*5825.00	92.3 AV			1.50 H	98	80.99	11.31
4	#5850.00	66.7 PK	78.2	-11.5	1.61 H	93	55.40	11.30
5	#5860.00	63.9 PK	74.0	-10.1	1.62 H	100	52.60	11.30
6	#5860.00	46.7 AV	54.0	-7.3	1.62 H	100	35.40	11.30
7	11650.00	50.3 PK	74.0	-23.7	1.54 H	285	32.83	17.47
8	11650.00	37.1 AV	54.0	-16.9	1.54 H	285	19.63	17.47
9	#17475.00	56.7 PK	74.0	-17.3	1.11 H	318	29.81	26.89
10	#17475.00	44.3 AV	54.0	-9.7	1.11 H	318	17.41	26.89

ANTENNA POLARITY & TEST DISTANCE: VERTICAL AT 3 M

NO.	FREQ. (MHz)	EMISSION LEVEL (dBuV/m)	LIMIT (dBuV/m)	MARGIN (dB)	ANTENNA HEIGHT (m)	TABLE ANGLE (Degree)	RAW VALUE (dBuV)	CORRECTION FACTOR (dB/m)
1	#5666.00	67.4 PK	68.2	-0.8	1.96 V	7	56.52	10.88
2	*5825.00	119.6 PK			1.99 V	9	108.29	11.31
3	*5825.00	109.4 AV			1.99 V	9	98.09	11.31
4	#5850.00	74.0 PK	78.2	-4.2	1.88 V	12	62.70	11.30
5	#5860.00	71.2 PK	74.0	-2.8	1.89 V	14	59.90	11.30
6	#5860.00	51.1 AV	54.0	-2.9	1.89 V	14	39.80	11.30
7	11650.00	55.2 PK	74.0	-18.8	1.77 V	227	37.73	17.47
8	11650.00	42.4 AV	54.0	-11.6	1.77 V	227	24.93	17.47
9	#17475.00	56.6 PK	74.0	-17.4	1.50 V	261	29.71	26.89
10	#17475.00	44.3 AV	54.0	-9.7	1.50 V	261	17.41	26.89

REMARKS:

- Emission Level(dBuV/m) = Raw Value(dBuV) + Correction Factor(dB/m)
- Correction Factor(dB/m) = Antenna Factor(dB/m) + Cable Factor(dB) – Pre-Amplifier Factor(dB)
- The other emission levels were very low against the limit.
- Margin value = Emission Level – Limit value
- " * ": Fundamental frequency.
- " # ": The radiated frequency is out of the restricted band.

802.11ac (VHT40)

CHANNEL	TX Channel 151	DETECTOR FUNCTION	Peak (PK)
FREQUENCY RANGE	1GHz ~ 40GHz		Average (AV)

ANTENNA POLARITY & TEST DISTANCE: HORIZONTAL AT 3 M								
NO.	FREQ. (MHz)	EMISSION LEVEL (dBuV/m)	LIMIT (dBuV/m)	MARGIN (dB)	ANTENNA HEIGHT (m)	TABLE ANGLE (Degree)	RAW VALUE (dBuV)	CORRECTION FACTOR (dB/m)
1	#5714.00	62.5 PK	74.0	-11.5	1.45 H	87	51.45	11.05
2	#5714.00	45.9 AV	54.0	-8.1	1.45 H	87	34.85	11.05
3	#5725.00	65.8 PK	78.2	-12.4	1.45 H	87	54.72	11.08
4	*5755.00	105.7 PK			1.45 H	87	94.54	11.16
5	*5755.00	95.6 AV			1.45 H	87	84.44	11.16
6	11510.00	50.6 PK	74.0	-23.4	1.52 H	284	33.87	16.73
7	11510.00	37.5 AV	54.0	-16.5	1.52 H	284	20.77	16.73
8	#17265.00	56.7 PK	74.0	-17.3	1.14 H	309	30.95	25.75
9	#17265.00	44.2 AV	54.0	-9.8	1.14 H	309	18.45	25.75

ANTENNA POLARITY & TEST DISTANCE: VERTICAL AT 3 M								
NO.	FREQ. (MHz)	EMISSION LEVEL (dBuV/m)	LIMIT (dBuV/m)	MARGIN (dB)	ANTENNA HEIGHT (m)	TABLE ANGLE (Degree)	RAW VALUE (dBuV)	CORRECTION FACTOR (dB/m)
1	#5714.00	72.3 PK	74.0	-1.7	1.92 V	11	61.25	11.05
2	#5714.00	53.9 AV	54.0	-0.1	1.92 V	11	42.85	11.05
3	#5725.00	76.7 PK	78.2	-1.5	2.33 V	360	65.62	11.08
4	*5755.00	115.1 PK			1.92 V	11	103.94	11.16
5	*5755.00	105.1 AV			1.92 V	11	93.94	11.16
6	11510.00	51.1 PK	74.0	-22.9	1.71 V	228	34.37	16.73
7	11510.00	37.1 AV	54.0	-16.9	1.71 V	228	20.37	16.73
8	#17265.00	56.4 PK	74.0	-17.6	1.47 V	276	30.65	25.75
9	#17265.00	44.2 AV	54.0	-9.8	1.47 V	276	18.45	25.75

REMARKS:

1. Emission Level(dBuV/m) = Raw Value(dBuV) + Correction Factor(dB/m)
2. Correction Factor(dB/m) = Antenna Factor(dB/m) + Cable Factor(dB) – Pre-Amplifier Factor(dB)
3. The other emission levels were very low against the limit.
4. Margin value = Emission Level – Limit value
5. " * ": Fundamental frequency.
6. " # ": The radiated frequency is out of the restricted band.

CHANNEL	TX Channel 159	DETECTOR FUNCTION	Peak (PK)
FREQUENCY RANGE	1GHz ~ 40GHz		Average (AV)

ANTENNA POLARITY & TEST DISTANCE: HORIZONTAL AT 3 M

NO.	FREQ. (MHz)	EMISSION LEVEL (dBuV/m)	LIMIT (dBuV/m)	MARGIN (dB)	ANTENNA HEIGHT (m)	TABLE ANGLE (Degree)	RAW VALUE (dBuV)	CORRECTION FACTOR (dB/m)
1	#5631.00	53.9 PK	68.2	-14.3	1.45 H	94	43.14	10.76
2	*5795.00	108.1 PK			1.44 H	89	96.81	11.29
3	*5795.00	98.9 AV			1.44 H	89	87.61	11.29
4	#5850.00	66.3 PK	78.2	-11.9	1.44 H	89	55.00	11.30
5	#5861.00	63.3 PK	74.0	-10.7	1.44 H	89	52.00	11.30
6	#5861.00	46.4 AV	54.0	-7.6	1.44 H	89	35.10	11.30
7	11590.00	50.3 PK	74.0	-23.7	1.56 H	270	32.93	17.37
8	11590.00	37.3 AV	54.0	-16.7	1.56 H	270	19.93	17.37
9	#17385.00	56.7 PK	74.0	-17.3	1.14 H	315	30.26	26.44
10	#17385.00	44.5 AV	54.0	-9.5	1.14 H	315	18.06	26.44

ANTENNA POLARITY & TEST DISTANCE: VERTICAL AT 3 M

NO.	FREQ. (MHz)	EMISSION LEVEL (dBuV/m)	LIMIT (dBuV/m)	MARGIN (dB)	ANTENNA HEIGHT (m)	TABLE ANGLE (Degree)	RAW VALUE (dBuV)	CORRECTION FACTOR (dB/m)
1	#5631.00	66.4 PK	68.2	-1.8	1.91 V	7	55.64	10.76
2	*5795.00	117.8 PK			1.92 V	7	106.51	11.29
3	*5795.00	108.1 AV			1.92 V	7	96.81	11.29
4	#5850.00	73.6 PK	78.2	-4.6	1.92 V	17	62.30	11.30
5	#5861.00	69.9 PK	74.0	-4.1	1.92 V	7	58.60	11.30
6	#5861.00	53.7 AV	54.0	-0.3	1.92 V	7	42.40	11.30
7	11590.00	53.4 PK	74.0	-20.6	1.69 V	215	36.03	17.37
8	11590.00	39.2 AV	54.0	-14.8	1.69 V	215	21.83	17.37
9	#17385.00	56.4 PK	74.0	-17.6	1.52 V	286	29.96	26.44
10	#17385.00	43.9 AV	54.0	-10.1	1.52 V	286	17.46	26.44

REMARKS:

1. Emission Level(dBuV/m) = Raw Value(dBuV) + Correction Factor(dB/m)
2. Correction Factor(dB/m) = Antenna Factor(dB/m) + Cable Factor(dB) – Pre-Amplifier Factor(dB)
3. The other emission levels were very low against the limit.
4. Margin value = Emission Level – Limit value
5. " * ": Fundamental frequency.
6. " # ": The radiated frequency is out of the restricted band.

802.11ac (VHT80)

CHANNEL	TX Channel 155	DETECTOR FUNCTION	Peak (PK)
FREQUENCY RANGE	1GHz ~ 40GHz		Average (AV)

ANTENNA POLARITY & TEST DISTANCE: HORIZONTAL AT 3 M								
NO.	FREQ. (MHz)	EMISSION LEVEL (dBuV/m)	LIMIT (dBuV/m)	MARGIN (dB)	ANTENNA HEIGHT (m)	TABLE ANGLE (Degree)	RAW VALUE (dBuV)	CORRECTION FACTOR (dB/m)
1	#5714.00	62.6 PK	74.0	-11.4	1.44 H	96	51.55	11.05
2	#5714.00	45.8 AV	54.0	-8.2	1.44 H	96	34.75	11.05
3	#5725.00	66.6 PK	78.2	-11.6	1.44 H	96	55.52	11.08
4	*5775.00	95.7 PK			1.44 H	96	84.47	11.23
5	*5775.00	83.3 AV			1.44 H	96	72.07	11.23
6	#5850.00	63.1 PK	78.2	-15.1	1.44 H	96	51.80	11.30
7	#5861.00	61.7 PK	74.0	-12.3	1.44 H	96	50.40	11.30
8	#5861.00	44.8 AV	54.0	-9.2	1.44 H	96	33.50	11.30
9	11550.00	50.6 PK	74.0	-23.4	1.50 H	269	33.54	17.06
10	11550.00	37.8 AV	54.0	-16.2	1.50 H	269	20.74	17.06
11	#17325.00	56.5 PK	74.0	-17.5	1.14 H	327	30.63	25.87
12	#17325.00	44.5 AV	54.0	-9.5	1.14 H	327	18.63	25.87

ANTENNA POLARITY & TEST DISTANCE: VERTICAL AT 3 M								
NO.	FREQ. (MHz)	EMISSION LEVEL (dBuV/m)	LIMIT (dBuV/m)	MARGIN (dB)	ANTENNA HEIGHT (m)	TABLE ANGLE (Degree)	RAW VALUE (dBuV)	CORRECTION FACTOR (dB/m)
1	#5714.00	70.8 PK	74.0	-3.2	1.94 V	11	59.75	11.05
2	#5714.00	53.9 AV	54.0	-0.1	1.94 V	11	42.85	11.05
3	#5725.00	76.8 PK	78.2	-1.4	1.94 V	11	65.72	11.08
4	*5775.00	111.6 PK			1.94 V	11	100.37	11.23
5	*5775.00	101.0 AV			1.94 V	11	89.77	11.23
6	#5850.00	73.3 PK	78.2	-4.9	1.94 V	11	62.00	11.30
7	#5860.00	67.5 PK	74.0	-6.5	1.94 V	11	56.20	11.30
8	#5860.00	51.6 AV	54.0	-2.4	1.94 V	11	40.30	11.30
9	11550.00	51.6 PK	74.0	-22.4	1.63 V	220	34.54	17.06
10	11550.00	37.2 AV	54.0	-16.8	1.63 V	220	20.14	17.06
11	#17325.00	56.3 PK	74.0	-17.7	1.52 V	295	30.43	25.87
12	#17325.00	43.6 AV	54.0	-10.4	1.52 V	295	17.73	25.87

REMARKS:

1. Emission Level(dBuV/m) = Raw Value(dBuV) + Correction Factor(dB/m)
2. Correction Factor(dB/m) = Antenna Factor(dB/m) + Cable Factor(dB) – Pre-Amplifier Factor(dB)
3. The other emission levels were very low against the limit.
4. Margin value = Emission Level – Limit value
5. " * ": Fundamental frequency.
6. " # ": The radiated frequency is out of the restricted band.

Below 1GHz Data

802.11a

CHANNEL	TX Channel 149	DETECTOR FUNCTION	Quasi-Peak (QP)
FREQUENCY RANGE	Below 1GHz		

ANTENNA POLARITY & TEST DISTANCE: HORIZONTAL AT 3 M

NO.	FREQ. (MHz)	EMISSION LEVEL (dBuV/m)	LIMIT (dBuV/m)	MARGIN (dB)	ANTENNA HEIGHT (m)	TABLE ANGLE (Degree)	RAW VALUE (dBuV)	CORRECTION FACTOR (dB/m)
1	69.28	26.8 QP	40.0	-13.2	2.00 H	86	41.86	-15.10
2	101.78	27.5 QP	43.5	-16.0	1.50 H	59	44.75	-17.22
3	275.70	28.4 QP	46.0	-17.7	1.00 H	110	41.17	-12.82
4	500.01	37.5 QP	46.0	-8.5	1.00 H	13	44.70	-7.16
5	600.02	32.6 QP	46.0	-13.4	1.50 H	24	37.29	-4.69
6	1000.00	36.0 QP	54.0	-18.1	1.50 H	26	34.28	1.67

ANTENNA POLARITY & TEST DISTANCE: VERTICAL AT 3 M

NO.	FREQ. (MHz)	EMISSION LEVEL (dBuV/m)	LIMIT (dBuV/m)	MARGIN (dB)	ANTENNA HEIGHT (m)	TABLE ANGLE (Degree)	RAW VALUE (dBuV)	CORRECTION FACTOR (dB/m)
1	37.71	33.0 QP	40.0	-7.0	1.00 V	212	46.92	-13.96
2	48.09	33.8 QP	40.0	-6.2	1.50 V	360	47.05	-13.21
3	66.52	32.1 QP	40.0	-7.9	1.50 V	205	46.89	-14.81
4	500.01	34.6 QP	46.0	-11.4	1.50 V	135	41.72	-7.16
5	749.98	31.6 QP	46.0	-14.4	1.00 V	360	33.55	-1.99
6	1000.00	35.0 QP	54.0	-19.1	1.00 V	61	33.28	1.67

REMARKS:

1. Emission Level(dBuV/m) = Raw Value(dBuV) + Correction Factor(dB/m)
2. Correction Factor(dB/m) = Antenna Factor(dB/m) + Cable Factor(dB) – Pre-Amplifier Factor(dB)
3. The other emission levels were very low against the limit.
4. Margin value = Emission Level – Limit value

4.2 Transmit Power Measurement

4.2.1 Limits of Transmit Power Measurement

Operation Band	EUT Category		LIMIT
U-NII-1		Outdoor Access Point	1 Watt (30 dBm) (Max. e.i.r.p \leq 125mW(21 dBm) at any elevation angle above 30 degrees as measured from the horizon)
		Fixed point-to-point Access Point	1 Watt (30 dBm)
		Indoor Access Point	1 Watt (30 dBm)
		Mobile and Portable client device	250mW (24 dBm)
U-NII-2A			250mW (24 dBm) or 11 dBm+10 log B*
U-NII-2C			250mW (24 dBm) or 11 dBm+10 log B*
U-NII-3	√		1 Watt (30 dBm)

*B is the 26 dB emission bandwidth in megahertz

Per KDB 662911 D01 Multiple Transmitter Output v02r01 Method of conducted output power measurement on IEEE 802.11 devices,

Array Gain = 0 dB (i.e., no array gain) for $N_{ANT} \leq 4$;

Array Gain = 0 dB (i.e., no array gain) for channel widths ≥ 40 MHz for any N_{ANT} ;

Array Gain = $5 \log(N_{ANT}/N_{SS})$ dB or 3 dB, whichever is less for 20-MHz channel widths with $N_{ANT} \geq 5$.

For power measurements on all other devices: Array Gain = $10 \log(N_{ANT}/N_{SS})$ dB.

4.2.2 Test Setup

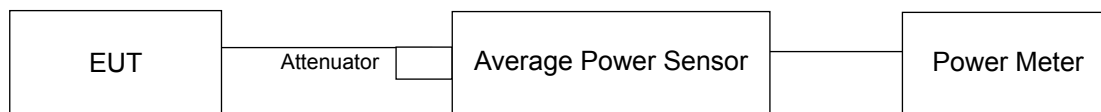

4.2.3 Test Instruments

DESCRIPTION & MANUFACTURER	MODEL NO.	SERIAL NO.	CALIBRATED DATE	CALIBRATED UNTIL
Power Meter Anritsu	ML2495A	1014008	Apr. 28, 2015	Apr. 27, 2016
Power Sensor Anritsu	MA2411B	0917122	Apr. 28, 2015	Apr. 27, 2016

- NOTE:**
1. The test was performed in Oven room 2.
 2. The calibration interval of the above test instruments is 12 months and the calibrations are traceable to NML/ROC and NIST/USA.
 3. Tested Date: Sep. 23, 2015

4.2.4 Test Procedures

Method PM is used to perform output power measurement, trigger and gating function of wide band power meter is enabled to measure max output power of TX on burst. Duty factor is not added to measured value.

4.2.5 Deviation from Test Standard

No deviation.

4.2.6 EUT Operating Conditions

The software provided by client to enable the EUT under transmission condition continuously at lowest, middle and highest channel frequencies individually.

4.2.7 Test Results

CDD Mode

802.11a

Chan.	Chan. Freq. (MHz)	Average Power (dBm)			Total Power (mW)	Total Power (dBm)	Limit (dBm)	Pass / Fail
		Chain 0	Chain 1	Chain 2				
149	5745	20.42	20.33	20.75	336.899	25.27	30	Pass
157	5785	20.58	20.12	20.92	340.685	25.32	30	Pass
165	5825	20.36	20.16	20.45	323.313	25.10	30	Pass

Beamforming Mode

802.11ac (VHT20)

Chan.	Chan. Freq. (MHz)	Average Power (dBm)			Total Power (mW)	Total Power (dBm)	Limit (dBm)	Pass / Fail
		Chain 0	Chain 1	Chain 2				
149	5745	18.08	17.96	17.95	189.159	22.77	30	Pass
157	5785	19.38	20.07	19.65	280.578	24.48	30	Pass
165	5825	17.66	17.96	18.04	184.542	22.66	30	Pass

Note: Directional gain = $0.9\text{dBi} + 10\log(3) = 5.67\text{dBi} < 6\text{dBi}$, so the power limit shall not be reduced.

802.11ac (VHT40)

Chan.	Chan. Freq. (MHz)	Average Power (dBm)			Total Power (mW)	Total Power (dBm)	Limit (dBm)	Pass / Fail
		Chain 0	Chain 1	Chain 2				
151	5755	16.42	16.58	16.75	136.667	21.36	30	Pass
159	5795	18.95	18.85	19.04	235.428	23.72	30	Pass

Note: Directional gain = $0.9\text{dBi} + 10\log(3) = 5.67\text{dBi} < 6\text{dBi}$, so the power limit shall not be reduced.

802.11ac (VHT80)

Chan.	Chan. Freq. (MHz)	Average Power (dBm)			Total Power (mW)	Total Power (dBm)	Limit (dBm)	Pass / Fail
		Chain 0	Chain 1	Chain 2				
155	5775	15.26	15.33	15.45	102.768	20.12	30	Pass

Note: Directional gain = $0.9\text{dBi} + 10\log(3) = 5.67\text{dBi} < 6\text{dBi}$, so the power limit shall not be reduced.

4.3 Peak Power Spectral Density Measurement

4.3.1 Limits of Peak Power Spectral Density Measurement

Operation Band	EUT Category		LIMIT
U-NII-1		Outdoor Access Point	17dBm/ MHz
		Fixed point-to-point Access Point	
		Indoor Access Point	
		Mobile and Portable client device	11dBm/ MHz
U-NII-2A			11dBm/ MHz
U-NII-2C			11dBm/ MHz
U-NII-3	√		30dBm/ 500kHz

4.3.2 Test Setup

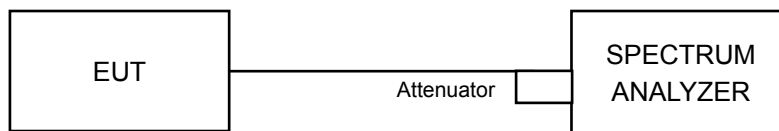

4.3.3 Test Instruments

DESCRIPTION & MANUFACTURER	MODEL NO.	SERIAL NO.	CALIBRATED DATE	CALIBRATED UNTIL
Spectrum Analyzer R&S	FSP40	100060	May 08, 2015	May 07, 2016

- NOTE:**
1. The test was performed in Oven room 2.
 2. The calibration interval of the above test instruments is 12 months and the calibrations are traceable to NML/ROC and NIST/USA.
 3. Tested Date: Sep. 23, 2015

4.3.4 Test Procedures

For 802.11a, 802.11ac (VHT20), 802.11ac (VHT40):

Using method SA-1

- a. Set span to encompass the entire emission bandwidth (EBW) of the signal.
- b. Set RBW = 300 kHz, Set VBW \geq 1 MHz, Detector = RMS
- c. Use the peak marker function to determine the maximum power level in any 300 kHz band segment within the fundamental EBW.
- d. Scale the observed power level to an equivalent value in 500 kHz by adjusting (reducing) the measured power by a bandwidth correction factor (BWCF) where $BWCF = 10\log(500 \text{ kHz}/300\text{kHz})$
- e. Sweep time = auto, trigger set to "free run".
- f. Trace average at least 100 traces in power averaging mode.
- g. Record the max value

For 802.11ac (VHT80):

Using method SA-2

- a. Set span to encompass the entire emission bandwidth (EBW) of the signal.
- b. Set RBW = 300 kHz, Set VBW \geq 1 MHz, Detector = RMS
- c. Use the peak marker function to determine the maximum power level in any 300 kHz band segment within the fundamental EBW.
- d. Scale the observed power level to an equivalent value in 500 kHz by adjusting (reducing) the measured power by a bandwidth correction factor (BWCF) where $BWCF = 10\log(500 \text{ kHz}/300\text{kHz})$
- e. Sweep time = auto, trigger set to "free run".
- f. Trace average at least 100 traces in power averaging mode.
- g. Record the max value and add $10 \log (1/\text{duty cycle})$

4.3.5 Deviation from Test Standard

No deviation.

4.3.6 EUT Operating Conditions

Same as Item 4.3.6.

4.3.7 Test Results

CDD Mode

802.11a

TX chain	Chan.	Chan. Freq. (MHz)	PSD		10 log (N=3) dB	Total PSD (dBm/500kHz)	Limit (dBm/500kHz)	Pass /Fail
			(dBm/300kHz)	(dBm/500kHz)				
0	149	5745	-1.36	0.86	4.77	5.63	30	Pass
	157	5785	-1.63	0.59	4.77	5.36	30	Pass
	165	5825	-1.19	1.03	4.77	5.80	30	Pass
1	149	5745	-1.56	0.66	4.77	5.43	30	Pass
	157	5785	-1.78	0.44	4.77	5.21	30	Pass
	165	5825	-1.32	0.90	4.77	5.67	30	Pass
2	149	5745	-1.54	0.68	4.77	5.45	30	Pass
	157	5785	-1.64	0.58	4.77	5.35	30	Pass
	165	5825	-1.40	0.82	4.77	5.59	30	Pass

Note: 1. Directional gain = $0.9\text{dBi} + 10\log(3) = 5.67\text{dBi} < 6\text{dBi}$, so the power density limit shall not be reduced.

Beamforming Mode

802.11ac (VHT20)

TX chain	Chan.	Chan. Freq. (MHz)	PSD		10 log (N=3) dB	Total PSD (dBm/500kHz)	Limit (dBm/500kHz)	Pass /Fail
			(dBm/300kHz)	(dBm/500kHz)				
0	149	5745	-3.62	-1.40	4.77	3.37	30	Pass
	157	5785	-1.76	0.46	4.77	5.23	30	Pass
	165	5825	-3.89	-1.67	4.77	3.10	30	Pass
1	149	5745	-3.84	-1.62	4.77	3.15	30	Pass
	157	5785	-1.88	0.34	4.77	5.11	30	Pass
	165	5825	-3.78	-1.56	4.77	3.21	30	Pass
2	149	5745	-3.78	-1.56	4.77	3.21	30	Pass
	157	5785	-2.21	0.01	4.77	4.78	30	Pass
	165	5825	-3.86	-1.64	4.77	3.13	30	Pass

Note: 1. Directional gain = $0.9\text{dBi} + 10\log(3) = 5.67\text{dBi} < 6\text{dBi}$, so the power density limit shall not be reduced.

802.11ac (VHT40)

TX chain	Chan.	Chan. Freq. (MHz)	PSD		10 log (N=3) dB	Total PSD (dBm/500kHz)	Limit (dBm/500kHz)	Pass /Fail
			(dBm/300kHz)	(dBm/500kHz)				
0	151	5755	-8.46	-6.24	4.77	-1.47	30	Pass
	159	5795	-6.52	-4.30	4.77	0.47	30	Pass
1	151	5755	-8.69	-6.47	4.77	-1.70	30	Pass
	159	5795	-6.57	-4.35	4.77	0.42	30	Pass
2	151	5755	-8.73	-6.51	4.77	-1.74	30	Pass
	159	5795	-6.91	-4.69	4.77	0.08	30	Pass

Note: 1. Directional gain = $0.9\text{dBi} + 10\log(3) = 5.67\text{dBi} < 6\text{dBi}$, so the power density limit shall not be reduced.

802.11ac (VHT80)

TX chain	Chan.	Chan. Freq. (MHz)	PSD W/O Duty Factor		10 log (N=3) dB	Duty Factor (dB)	Total PSD With Duty Factor (dBm/500kHz)	Limit (dBm/500kHz)	Pass /Fail
			(dBm/300kHz)	(dBm/500kHz)					
0	155	5775	-12.87	-10.65	4.77	0.21	-5.67	30	Pass
1	155	5775	-12.91	-10.69	4.77	0.21	-5.71	30	Pass
2	155	5775	-12.15	-9.93	4.77	0.21	-4.95	30	Pass

Note: 1. Directional gain = $0.9\text{dBi} + 10\log(3) = 5.67\text{dBi} < 6\text{dBi}$, so the power density limit shall not be reduced.
 2. Refer to section 3.3 for duty cycle spectrum plot.

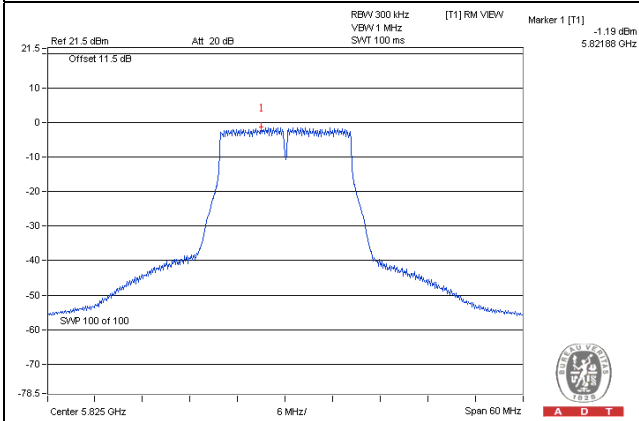
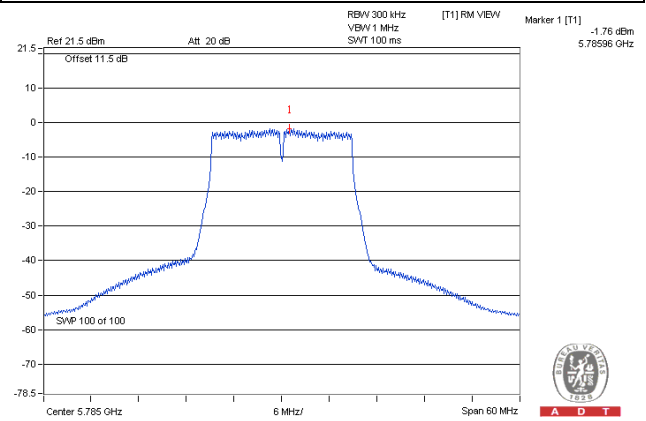
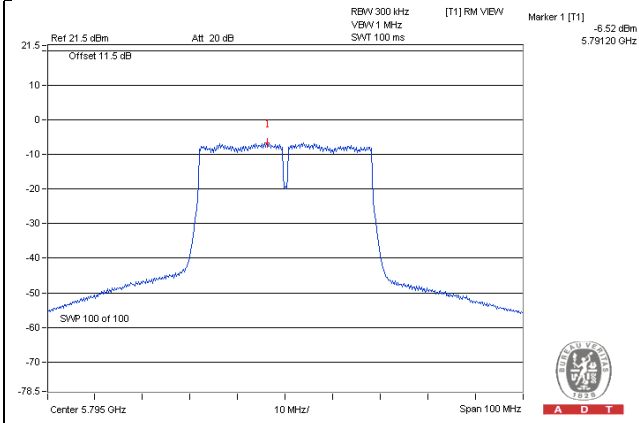
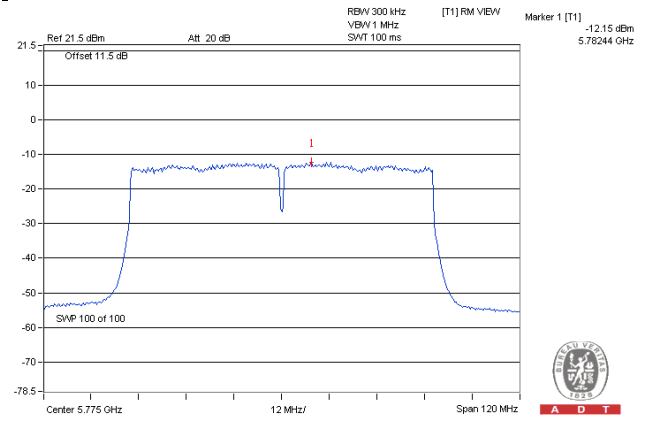
Spectrum Plot of Worst Value**802.11a_Chain 0 / CH165****802.11ac (VHT20)_Chain 0 / CH157****802.11ac (VHT40)_Chain 0 / CH159****802.11ac (VHT80)_Chain 2 / CH155**

4.4 Frequency Stability Measurement

4.4.1 Limits of Frequency Stability Measurement

The frequency of the carrier signal shall be maintained within band of operation

4.4.2 Test Setup

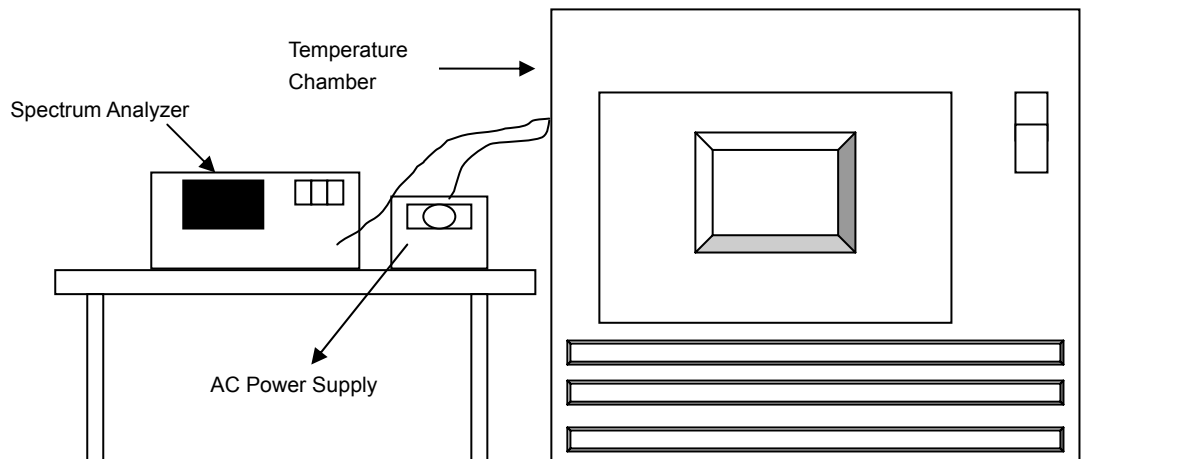

4.4.3 Test Instruments

DESCRIPTION & MANUFACTURER	MODEL NO.	SERIAL NO.	CALIBRATED DATE	CALIBRATED UNTIL
Spectrum Analyzer R&S	FSP40	100060	May 08, 2015	May 07, 2016
Temperature & Humidity Chamber GIANTFORCE	GTH-150-40-S P-AR	MAA0812-008	Jan. 12, 2015	Jan. 11, 2016

- NOTE:**
1. The test was performed in Oven room 2.
 2. The calibration interval of the above test instruments is 12 months and the calibrations are traceable to NML/ROC and NIST/USA.
 3. Tested Date: Sep. 23, 2015

4.4.4 Test Procedures

- a. The EUT was placed inside the environmental test chamber and powered by nominal AC voltage.
- b. Turn the EUT on and couple its output to a spectrum analyzer.
- c. Turn the EUT off and set the chamber to the highest temperature specified.
- d. Allow sufficient time (approximately 30 min) for the temperature of the chamber to stabilize, turn the EUT on and measure the operating frequency after 2, 5, and 10 minutes.
- e. Repeat step 2 and 3 with the temperature chamber set to the lowest temperature.
- f. The test chamber was allowed to stabilize at +20 degree C for a minimum of 30 minutes. The supply voltage was then adjusted on the EUT from 85% to 115% and the frequency record.

4.4.5 Deviation from Test Standard

No deviation.

4.4.6 EUT Operating Conditions

Set the EUT transmit at un-modulation mode to test frequency stability.

4.4.7 Test Results

Frequency Stability Versus Temp.									
Operating Frequency: 5745MHz									
Temp. (°C)	Power Supply (Vac)	0 Minute		2 Minute		5 Minute		10 Minute	
		Measured Frequency (MHz)	Frequency Drift (%)	Measured Frequency (MHz)	Frequency Drift (%)	Measured Frequency (MHz)	Frequency Drift (%)	Measured Frequency (MHz)	Frequency Drift (%)
50	120	5744.9768	-0.00040	5744.9728	-0.00047	5744.9729	-0.00047	5744.9723	-0.00048
40	120	5744.9997	-0.00001	5745.0014	0.00002	5745.0027	0.00005	5745.0024	0.00004
30	120	5744.982	-0.00031	5744.9844	-0.00027	5744.9818	-0.00032	5744.982	-0.00031
20	120	5744.9993	-0.00001	5744.9998	0.00000	5745.0027	0.00005	5745.0006	0.00001
10	120	5745.0044	0.00008	5744.9999	0.00000	5745.0046	0.00008	5745.0039	0.00007
0	120	5744.9806	-0.00034	5744.9816	-0.00032	5744.9816	-0.00032	5744.9842	-0.00028
-10	120	5744.989	-0.00019	5744.9906	-0.00016	5744.9873	-0.00022	5744.9881	-0.00021
-20	120	5745.0243	0.00042	5745.0292	0.00051	5745.0284	0.00049	5745.0258	0.00045
-30	120	5744.9702	-0.00052	5744.9705	-0.00051	5744.972	-0.00049	5744.9696	-0.00053

Frequency Stability Versus Temp.									
Operating Frequency: 5745MHz									
Temp. (°C)	Power Supply (Vac)	0 Minute		2 Minute		5 Minute		10 Minute	
		Measured Frequency (MHz)	Frequency Drift (%)	Measured Frequency (MHz)	Frequency Drift (%)	Measured Frequency (MHz)	Frequency Drift (%)	Measured Frequency (MHz)	Frequency Drift (%)
20	138	5744.9985	-0.00003	5744.9994	-0.00001	5745.0032	0.00006	5745.0016	0.00003
	120	5744.9993	-0.00001	5744.9998	0.00000	5745.0027	0.00005	5745.0006	0.00001
	102	5745.0003	0.00001	5744.9999	0.00000	5745.0017	0.00003	5745.0001	0.00000

4.5 6dB Bandwidth Measurement

4.5.1 Limits of 6dB Bandwidth Measurement

The minimum of 6dB Bandwidth Measurement is 0.5MHz.

4.5.2 Test Setup

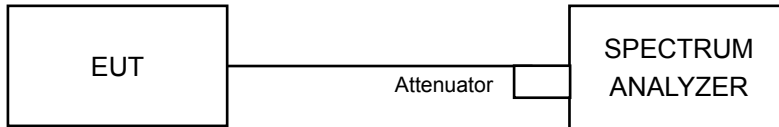

4.5.3 Test Instruments

DESCRIPTION & MANUFACTURER	MODEL NO.	SERIAL NO.	CALIBRATED DATE	CALIBRATED UNTIL
Spectrum Analyzer R&S	FSP40	100060	May 08, 2015	May 07, 2016

- NOTE:**
1. The test was performed in Oven room 2.
 2. The calibration interval of the above test instruments is 12 months and the calibrations are traceable to NML/ROC and NIST/USA.
 3. Tested Date: Sep. 23, 2015

4.5.4 Test Procedures

MEASUREMENT PROCEDURE REF

- a. Set resolution bandwidth (RBW) = 100kHz
- b. Set the video bandwidth (VBW) ≥ 3 x RBW, Detector = Peak.
- c. Trace mode = max hold.
- d. Sweep = auto couple.
- e. Measure the maximum width of the emission that is constrained by the frequencies associated with the two amplitude points (upper and lower) that are attenuated by 6 dB relative to the maximum level measured in the fundamental emission

4.5.5 Deviation from Test Standard

No deviation.

4.5.6 EUT Operating Conditions

The software provided by client to enable the EUT under transmission condition continuously at lowest, middle and highest channel frequencies individually.

4.5.7 Test Results

802.11a

Channel	Frequency (MHz)	6dB Bandwidth (MHz)			Minimum Limit (MHz)	Pass / Fail
		Chain 0	Chain 1	Chain 2		
149	5745	16.43	16.42	16.43	0.5	Pass
157	5785	16.46	16.46	16.44	0.5	Pass
165	5825	16.45	16.45	16.44	0.5	Pass

802.11ac (VHT20)

Channel	Frequency (MHz)	6dB Bandwidth (MHz)			Minimum Limit (MHz)	Pass / Fail
		Chain 0	Chain 1	Chain 2		
149	5745	17.70	17.68	17.69	0.5	Pass
157	5785	17.67	17.67	17.70	0.5	Pass
165	5825	17.67	17.66	17.69	0.5	Pass

802.11ac (VHT40)

Channel	Frequency (MHz)	6dB Bandwidth (MHz)			Minimum Limit (MHz)	Pass / Fail
		Chain 0	Chain 1	Chain 2		
151	5755	36.44	36.45	36.46	0.5	Pass
159	5795	36.46	36.48	36.46	0.5	Pass

802.11ac (VHT80)

Channel	Frequency (MHz)	6dB Bandwidth (MHz)			Minimum Limit (MHz)	Pass / Fail
		Chain 0	Chain 1	Chain 2		
155	5775	76.11	76.43	76.35	0.5	Pass

Spectrum Plot of Worst Value

802.11a_Chain 1 / CH149

802.11ac (VHT20)_Chain 1 / CH165

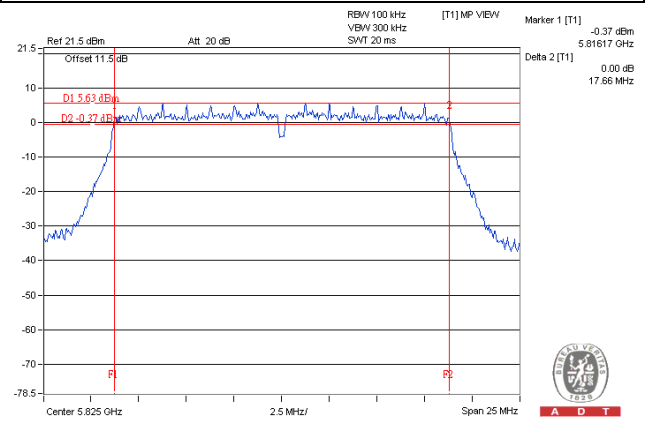
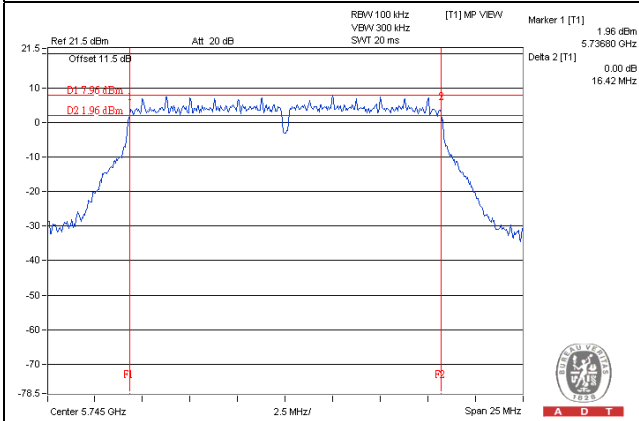

802.11ac (VHT40)_Chain 0 / CH151

802.11ac (VHT80)_Chain 0 / CH155

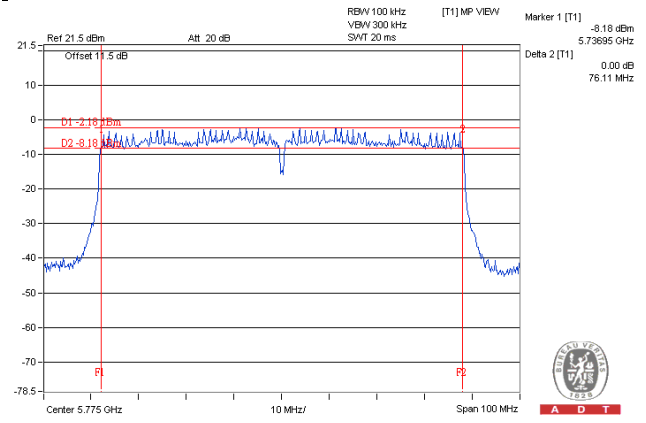
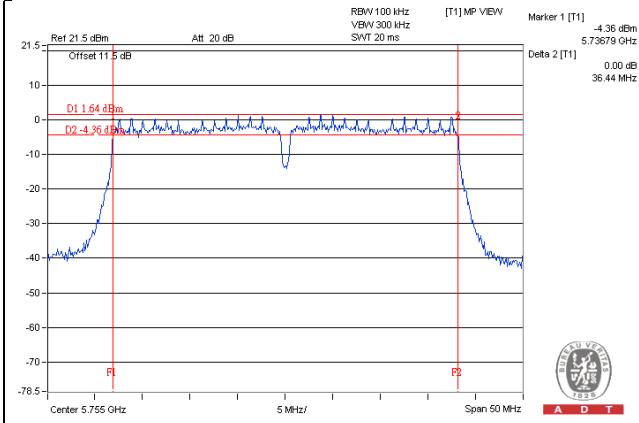

5 Pictures of Test Arrangements

Please refer to the attached file (Test Setup Photo).



Appendix – Information on the Testing Laboratories

We, Bureau Veritas Consumer Products Services (H.K.) Ltd., Taoyuan Branch, were founded in 1988 to provide our best service in EMC, Radio, Telecom and Safety consultation. Our laboratories are accredited and approved according to ISO/IEC 17025.

If you have any comments, please feel free to contact us at the following:

Linko EMC/RF Lab

Tel: 886-2-26052180

Fax: 886-2-26051924

Hsin Chu EMC/RF Lab/Telecom Lab

Tel: 886-3-5935343

Fax: 886-3-5935342

Hwa Ya EMC/RF/Safety

Tel: 886-3-3183232

Fax: 886-3-3270892

Email: service.adt@tw.bureauveritas.com

Web Site: www.bureauveritas-adt.com

The address and road map of all our labs can be found in our web site also.

--- END ---