



SPORTON International Inc.

No.8, Lane 724, Bo-ai St., Jhubei City, HsinChu County 302, Taiwan, R.O.C.
Ph: 886-3-656-9065 / FAX: 886-3-656-9085 / www.sporton.com.tw

FCC RADIO TEST REPORT

Applicant's company	Netgear Inc.
Applicant Address	350 East Plumeria Drive, San Jose, CA 95134, USA
FCC ID	PY312200201
Manufacturer's company	Wistron NeWeb Corporation
Manufacturer Address	20 Park Avenue II, Hsinchu Science Park, Hsinchu 308, Taiwan, R.O.C.

Product Name	WLAN 802.11 1x1 SB + BT3.0 SDIO Module for NeoTV Prime
Brand Name	NETGEAR
Model Name	GTV100
Test Rule	47 CFR FCC Part 15 Subpart C § 15.247
Test Freq. Range	2400 ~ 2483.5MHz
Received Date	Feb. 10, 2012
Final Test Date	Oct. 25, 2012
Submission Type	Original Equipment

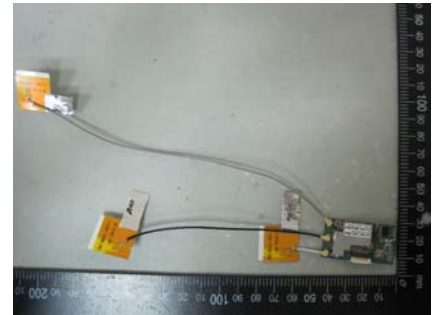

Statement

Test result included in this report is for the IEEE 802.11n and IEEE 802.11b/g part of the product.

The test result in this report refers exclusively to the presented test model / sample.

Without written approval of SPORTON International Inc., the test report shall not be reproduced except in full.

The measurements and test results shown in this test report were made in accordance with the procedures and found in compliance with the limit given in **ANSI C63.10-2009** and **47 CFR FCC Part 15 Subpart C, KDB 558074 D01 v02** and **KDB 662911 D01 v01r02**.

The test equipment used to perform the test is calibrated and traceable to NML/ROC.



Table of Contents

1. CERTIFICATE OF COMPLIANCE	1
2. SUMMARY OF THE TEST RESULT	2
3. GENERAL INFORMATION	3
3.1. Product Details	3
3.2. Accessories	5
3.3. Table for Filed Antenna	5
3.4. Table for Carrier Frequencies	6
3.5. Table for Test Modes	6
3.6. Table for Testing Locations.....	7
3.7. Table for Supporting Units	7
3.8. Table for Parameters of Test Software Setting	7
3.9. Test Configurations.....	9
4. TEST RESULT	12
4.1. AC Power Line Conducted Emissions Measurement	12
4.2. Peak Output Power Measurement	16
4.3. Average Output Power Measurement.....	19
4.4. Power Spectral Density Measurement.....	22
4.5. 6dB Spectrum Bandwidth Measurement	34
4.6. Radiated Emissions Measurement.....	43
4.7. Band Edge Emissions Measurement.....	61
4.8. Antenna Requirements	74
5. LIST OF MEASURING EQUIPMENTS	75
6. TEST LOCATION	77
7. TAF CERTIFICATE OF ACCREDITATION	78
APPENDIX A. TEST PHOTOS	A1 ~ A8
APPENDIX B. MAXIMUM PERMISSIBLE EXPOSURE	B1 ~ B3
APPENDIX C. CO-LOCATION REPORT	C1 ~ C3



History of This Test Report

REPORT NO.	VERSION	DESCRIPTION	ISSUED DATE
FR221025-01	Rev. 01	Initial issue of report	Nov. 19, 2012

1. CERTIFICATE OF COMPLIANCE

Product Name : WLAN 802.11 1x1 SB + BT3.0 SDIO Module for NeoTV Prime
Brand Name : NETGEAR
Model Name : GTV100
Applicant : Netgear Inc.
Test Rule Part(s) : 47 CFR FCC Part 15 Subpart C § 15.247

Sporton International as requested by the applicant to evaluate the EMC performance of the product sample received on Feb. 10, 2012 would like to declare that the tested sample has been evaluated and found to be in compliance with the tested rule parts. The data recorded as well as the test configuration specified is true and accurate for showing the sample's EMC nature.

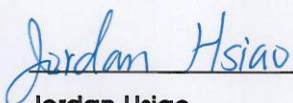

Jordan Hsiao

SPORTON INTERNATIONAL INC.

2. SUMMARY OF THE TEST RESULT

Applied Standard: 47 CFR FCC Part 15 Subpart C				
Part	Rule Section	Description of Test	Result	Under Limit
4.1	15.207	AC Power Line Conducted Emissions	Complies	5.50 dB
4.2	15.247(b)(3)	Peak Output Power	Complies	8.28 dB
4.3	-	Average Output Power	-	-
4.4	15.247(e)	Power Spectral Density	Complies	20.76 dB
4.5	15.247(a)(2)	6dB Spectrum Bandwidth	Complies	-
4.6	15.247(d)	Radiated Emissions	Complies	0.62 dB
4.7	15.247(d)	Band Edge Emissions	Complies	0.18 dB
4.8	15.203	Antenna Requirements	Complies	-

Test Items	Uncertainty	Remark
AC Power Line Conducted Emissions	±2.3dB	Confidence levels of 95%
Maximum Peak Output Power	±0.8dB	Confidence levels of 95%
Power Spectral Density	±0.5dB	Confidence levels of 95%
6dB Spectrum Bandwidth	±8.5×10 ⁻⁸	Confidence levels of 95%
Radiated Emissions (9kHz~30MHz)	±0.8dB	Confidence levels of 95%
Radiated Emissions (30MHz~1000MHz)	±1.9dB	Confidence levels of 95%
Radiated / Band Edge Emissions (1GHz~18GHz)	±1.9dB	Confidence levels of 95%
Radiated Emissions (18GHz~40GHz)	±1.9dB	Confidence levels of 95%
Temperature	±0.7°C	Confidence levels of 95%
Humidity	±3.2%	Confidence levels of 95%
DC / AC Power Source	±1.4%	Confidence levels of 95%

3. GENERAL INFORMATION

3.1. Product Details

IEEE 802.11n

Items	Description
Product Type	WLAN (1TX, 1RX)
Radio Type	Intentional Transceiver
Power Type	From Host System
Modulation	see the below table for IEEE 802.11n
Data Modulation	OFDM (BPSK / QPSK / 16QAM / 64QAM)
Data Rate (Mbps)	see the below table for IEEE 802.11n
Frequency Range	2400 ~ 2483.5MHz
Channel Number	11 for 20MHz bandwidth ; 7 for 40MHz bandwidth
Channel Band Width (99%)	MCS0 (20MHz): 17.76 MHz ; MCS0 (40MHz): 36.36 MHz
Peak Output Power	MCS0 (20MHz): 21.72 dBm ; MCS0 (40MHz): 21.44 dBm
Carrier Frequencies	Please refer to section 3.4
Antenna	Please refer to section 3.3

IEEE 802.11b/g

Items	Description
Product Type	802.11b :WLAN (1TX, 1RX) 802.11g :WLAN (1TX, 1RX)
Radio Type	Intentional Transceiver
Power Type	From Host System
Modulation	DSSS for IEEE 802.11b ; OFDM for IEEE 802.11g
Data Modulation	DSSS (BPSK / QPSK / CCK) ; OFDM (BPSK / QPSK / 16QAM / 64QAM)
Data Rate (Mbps)	DSSS (1/ 2/ 5.5/11) ; OFDM (6/9/12/18/24/36/48/54)
Frequency Range	2400 ~ 2483.5MHz
Channel Number	11
Channel Band Width (99%)	11b: 13.60 MHz ; 11g: 16.56 MHz
Peak Output Power	11b: 15.44 dBm ; 11g: 21.22 dBm
Carrier Frequencies	Please refer to section 3.4
Antenna	Please refer to section 3.3

Antenna & Band width

Antenna	Single (TX)	
Band width Mode	20 MHz	40 MHz
IEEE 802.11b	V	X
IEEE 802.11g	V	X
IEEE 802.11n	V	V

IEEE 802.11n spec

MCS Index	Nss	Modulation	R	NBPS	NCBPS		NDBPS		Datarate(Mbps)			
					20MHz	40MHz	20MHz	40MHz	800nsGI		400nsGI	
									20MHz	40MHz	20MHz	40MHz
0	1	BPSK	1/2	1	52	108	26	54	6.5	13.5	7.200	15
1	1	QPSK	1/2	2	104	216	52	108	13.0	27.0	14.400	30
2	1	QPSK	3/4	2	104	216	78	162	19.5	40.5	21.700	45
3	1	16-QAM	1/2	4	208	432	104	216	26.0	54.0	28.900	60
4	1	16-QAM	3/4	4	208	432	156	324	39.0	81.0	43.300	90
5	1	64-QAM	2/3	6	312	648	208	432	52.0	108.0	57.800	120
6	1	64-QAM	3/4	6	312	648	234	486	58.5	121.5	65.000	135
7	1	64-QAM	5/6	6	312	648	260	540	65.0	135.0	72.200	150
8	2	BPSK	1/2	1	104	216	52	108	13.0	27.0	14.444	30
9	2	QPSK	1/2	2	208	432	104	216	26.0	54.0	28.889	60
10	2	QPSK	3/4	2	208	432	156	324	39.0	81.0	43.333	90
11	2	16-QAM	1/2	4	416	864	208	432	52.0	108.0	57.778	120
12	2	16-QAM	3/4	4	416	864	312	648	78.0	162.0	86.667	180
13	2	64-QAM	2/3	6	624	1296	416	864	104.0	216.0	115.556	240
14	2	64-QAM	3/4	6	624	1296	468	972	117.0	243.0	130.000	270
15	2	64-QAM	5/6	6	624	1296	520	1080	130.0	270.0	144.444	300

Symbol	Explanation
NSS	Number of spatial streams
R	Code rate
NBPS	Number of coded bits per single carrier
NCBPS	Number of coded bits per symbol
NDBPS	Number of data bits per symbol
GI	guard interval

3.2. Accessories

N/A

3.3. Table for Filed Antenna

Ant.	Antenna Part Number	Antenna Type	Connector	Gain (dBi)	Remark
A	25.91426.001	PIFA Antenna	RF connect	0.83	TX/RX
B	25.91427.001	PIFA Antenna	RF connect	0.7	TX/RX
C	25.91428.001	PIFA Antenna	RF connect	1.41	TX/RX

Note 1: The EUT has three antennas.

Ant. A and Ant. B are for WLAN function.

Either Antenna A or Antenna B is used as transmitting antenna and receiving antenna, and it uses Antenna A as a Main port.

When Antenna A is broken, it turns Antenna B as a Main Port.

Ant. C is for Bluetooth function.

Because Ant. B generated the worst case, it was selected to perform test and its test result was written in the report.



3.4. Table for Carrier Frequencies

For IEEE 802.11b/g, use Channel 1~Channel 11.

There are two bandwidth systems for IEEE 802.11n.

For both 20MHz bandwidth systems, use Channel 1~Channel 11.

For both 40MHz bandwidth systems, use Channel 3~Channel 9.

Frequency Band	Channel No.	Frequency	Channel No.	Frequency
2400~2483.5MHz	1	2412 MHz	7	2442 MHz
	2	2417 MHz	8	2447 MHz
	3	2422 MHz	9	2452 MHz
	4	2427 MHz	10	2457 MHz
	5	2432 MHz	11	2462 MHz
	6	2437 MHz	-	-

3.5. Table for Test Modes

Preliminary tests were performed in different data rate to find the worst radiated emission. The data rate shown in the table below is the worst-case rate with respect to the specific test item. Investigation has been done on all the possible configurations for searching the worst cases. The following table is a list of the test modes shown in this test report.

Test Items	Mode	Data Rate	Channel	Antenna
AC Power Line Conducted Emissions	Normal Link	-	-	-
Peak Output Power Average Output Power Power Spectral Density	MCS0/20MHz	6.5 Mbps	1/6/11	B
	MCS0/40MHz	13.5 Mbps	3/6/9	B
	11b/BPSK	1 Mbps	1/6/11	B
	11g/BPSK	6 Mbps	1/6/11	B
6dB Spectrum Bandwidth	MCS0/20MHz	6.5 Mbps	1/6/11	B
	MCS0/40MHz	13.5 Mbps	3/6/9	B
	11b/BPSK	1 Mbps	1/6/11	B
	11g/BPSK	6 Mbps	1/6/11	B
Radiated Emissions 9kHz~1GHz	Normal Link	-	-	-
Radiated Emissions 1GHz~10 th Harmonic	MCS0/20MHz	6.5 Mbps	1/6/11	B
	MCS0/40MHz	13.5 Mbps	3/6/9	B
	11b/BPSK	1 Mbps	1/6/11	B
	11g/BPSK	6 Mbps	1/6/11	B
Band Edge Emissions	MCS0/20MHz	6.5 Mbps	1/11	B
	MCS0/40MHz	13.5 Mbps	3/9	B
	11b/BPSK	1 Mbps	1/11	B
	11g/BPSK	6 Mbps	1/11	B

3.6. Table for Testing Locations

Test Site No.	Site Category	Location	FCC Reg. No.	IC File No.	VCCI Reg. No
03CH01-CB	SAC	Hsin Chu	262045	IC 4086D	-
CO01-CB	Conduction	Hsin Chu	262045	IC 4086D	-
TH01-CB	OVEN Room	Hsin Chu	-	-	-

Open Area Test Site (OATS); Semi Anechoic Chamber (SAC).

Please refer section 6 for Test Site Address.

3.7. Table for Supporting Units

Support Unit	Brand	Model	FCC ID
Notebook	DELL	D420	E2KWM3945ABG
Mouse	Logitech	M-U0026	DoC
Earphone	SHYARO CHI	MIC-04	DoC
Earphone	E-books	E-EPC040	DoC
Wireless AP	BELKIN	WG7016G22-LF-AK	DoC

3.8. Table for Parameters of Test Software Setting

During testing, Channel & Power Controlling Software provided by the customer was used to control the operating channel as well as the output power level. The RF output power selection is for the setting of RF output power expected by the customer and is going to be fixed on the firmware of the final end product.

Power Parameters of IEEE 802.11n

Test Software Version	W8787 (802.11a/g/b/n) TEST MENU		
Frequency	2412 MHz	2437 MHz	2462 MHz
MCS0 20MHz	15	23	15
Frequency	2422 MHz	2437 MHz	2452 MHz
MCS0 40MHz	14	23	14

Power Parameters of IEEE 802.11b/g

Test Software Version	W8787 (802.11a/g/b/n) TEST MENU		
Frequency	2412 MHz	2437 MHz	2462 MHz
IEEE 802.11b	13	13	13
IEEE 802.11g	15	23	15

During the test, "W8787 (802.11a/g/b/n) TEST MENU" under WIN XP was executed the test program to control the EUT continuously transmit RF signal.

3.9. Test Configurations

3.9.1. Radiation Emissions Test Configuration

Test Configuration: 30MHz~1GHz

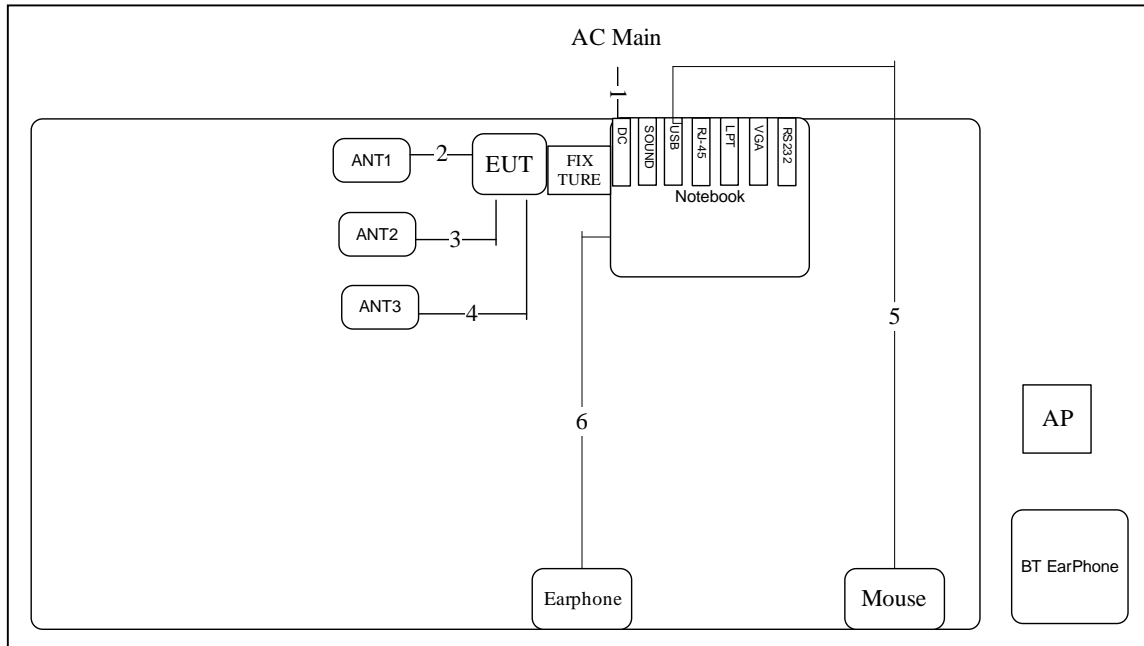

Item	Connection	Shield	Length
1	Power cable	No	2.6M
2	Ant cable	Yes	0.012M
3	Ant cable	Yes	0.105M
4	Ant cable	Yes	0.175M
5	USB Cable	Yes	1.8M
6	Earphone Cable	No	0.72M

Test Configuration: above 1GHz

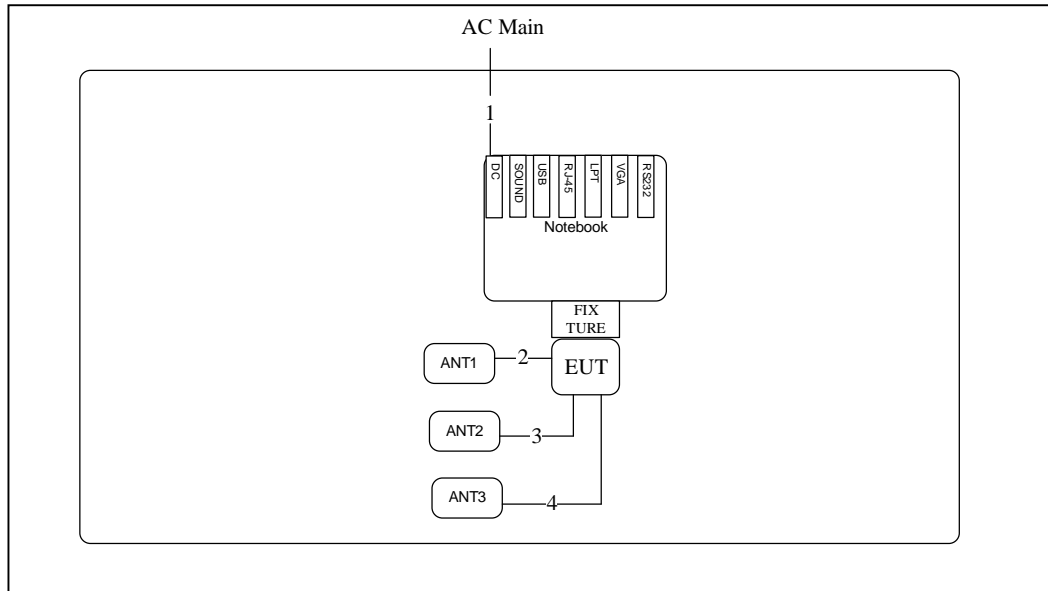

Item	Connection	Shield	Length
1	Power cable	No	2.6M
2	Ant cable	Yes	0.012m
3	Ant cable	Yes	0.105m
4	Ant cable	Yes	0.175m

3.9.2. AC Power Line Conduction Emissions Test Configuration

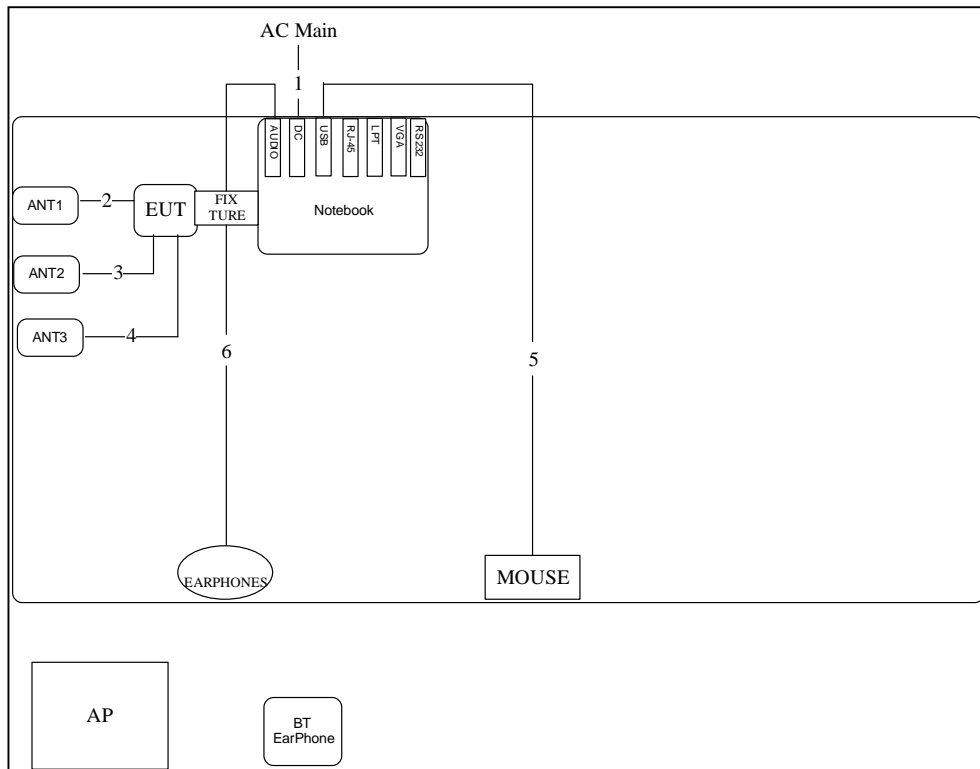

Item	Connection	Shield	Length
1	Power cable	No	2.6M
2	Ant cable	Yes	0.012M
3	Ant cable	Yes	0.105M
4	Ant cable	Yes	0.175M
5	USB cable	Yes	1.8M
6	Earphone cable	No	0.72M

4. TEST RESULT

4.1. AC Power Line Conducted Emissions Measurement

4.1.1. Limit

For this product which is designed to be connected to the AC power line, the radio frequency voltage that is conducted back onto the AC power line on any frequency or frequencies within the band 150 kHz to 30 MHz shall not exceed below limits table.

Frequency (MHz)	QP Limit (dBuV)	AV Limit (dBuV)
0.15~0.5	66~56	56~46
0.5~5	56	46
5~30	60	50

4.1.2. Measuring Instruments and Setting

Please refer to section 5 of equipments list in this report. The following table is the setting of the receiver.

Receiver Parameters	Setting
Attenuation	10 dB
Start Frequency	0.15 MHz
Stop Frequency	30 MHz
IF Bandwidth	9 KHz

4.1.3. Test Procedures

1. Configure the EUT according to ANSI C63.10. The EUT or host of EUT has to be placed 0.4 meter far from the conducting wall of the shielding room and at least 80 centimeters from any other grounded conducting surface.
2. Connect EUT or host of EUT to the power mains through a line impedance stabilization network (LISN).
3. All the support units are connected to the other LISNs. The LISN should provide 50uH/50ohms coupling impedance.
4. The frequency range from 150 KHz to 30 MHz was searched.
5. Set the test-receiver system to Peak Detect Function and Specified Bandwidth with Maximum Hold Mode.
6. The measurement has to be done between each power line and ground at the power terminal.

4.1.4. Test Setup Layout

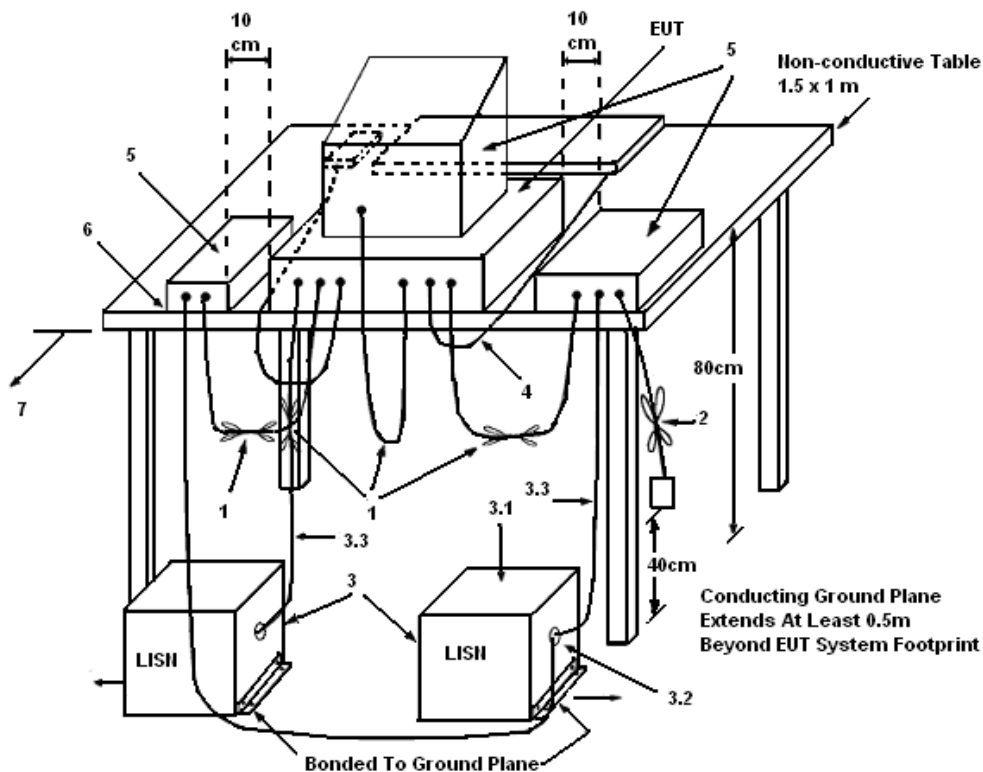

LEGEND:

- (1) Interconnecting cables that hang closer than 40 cm to the ground plane shall be folded back and forth in the center forming a bundle 30 to 40 cm long.
- (2) I/O cables that are not connected to a peripheral shall be bundled in the center. The end of the cable may be terminated, if required, using the correct terminating impedance. The overall length shall not exceed 1 m.
- (3) EUT connected to one LISN. Unused LISN measuring port connectors shall be terminated in 50 Ω . LISN can be placed on top of, or immediately beneath, reference ground plane.
 - (3.1) All other equipment powered from additional LISN(s).
 - (3.2) Multiple outlet strip can be used for multiple power cords of non-EUT equipment.
 - (3.3) LISN at least 80 cm from nearest part of EUT chassis.
- (4) Cables of hand-operated devices, such as keyboards, mice, etc., shall be placed as for normal use.
- (5) Non-EUT components of EUT system being tested.
- (6) Rear of EUT, including peripherals, shall all be aligned and flush with rear of tabletop.
- (7) Rear of tabletop shall be 40 cm removed from a vertical conducting plane that is bonded to the ground plane.

4.1.5. Test Deviation

There is no deviation with the original standard.

4.1.6. EUT Operation during Test

The EUT was placed on the test table and programmed in normal function.

4.1.7. Results of AC Power Line Conducted Emissions Measurement

Temperature	20°C	Humidity	55%
Test Engineer	Kai Yang	Phase	Line
Configuration	Normal Link		

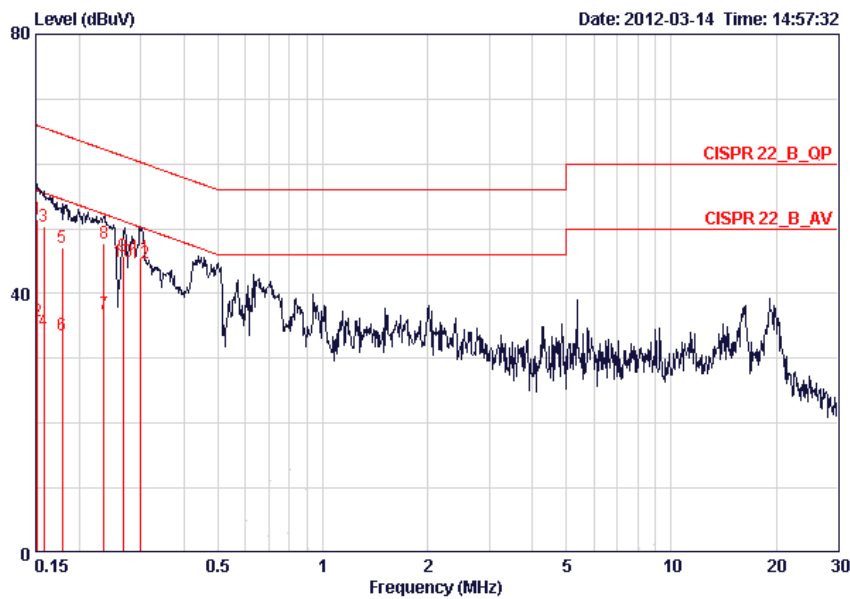

	Freq	Level	Over Limit	Limit Line	Read Level	LISN Factor	Cable Loss	Remark
	MHz	dBuV	dB	dBuV	dBuV	dB	dB	
1	0.15160	51.50	-14.41	65.91	51.23	0.07	0.20	QP
2	0.15160	35.82	-20.09	55.91	35.55	0.07	0.20	AVERAGE
3	0.15816	50.36	-15.20	65.56	50.09	0.07	0.20	QP
4	0.15816	34.33	-21.23	55.56	34.06	0.07	0.20	AVERAGE
5	0.17866	47.14	-17.41	64.55	46.88	0.06	0.20	QP
6	0.17866	33.58	-20.97	54.55	33.32	0.06	0.20	AVERAGE
7	0.23533	36.74	-15.52	52.26	36.49	0.05	0.20	AVERAGE
8	0.23533	47.73	-14.53	62.26	47.48	0.05	0.20	QP
9	0.26724	45.81	-15.39	61.20	45.57	0.04	0.20	QP
10	0.26724	44.82	-6.38	51.20	44.58	0.04	0.20	AVERAGE
11	0.30077	45.58	-14.64	60.22	45.34	0.04	0.20	QP
12	0.30077	44.65	-5.57	50.22	44.41	0.04	0.20	AVERAGE

Temperature	20°C	Humidity	55%
Test Engineer	Kai Yang	Phase	Neutral
Configuration	Normal Link		

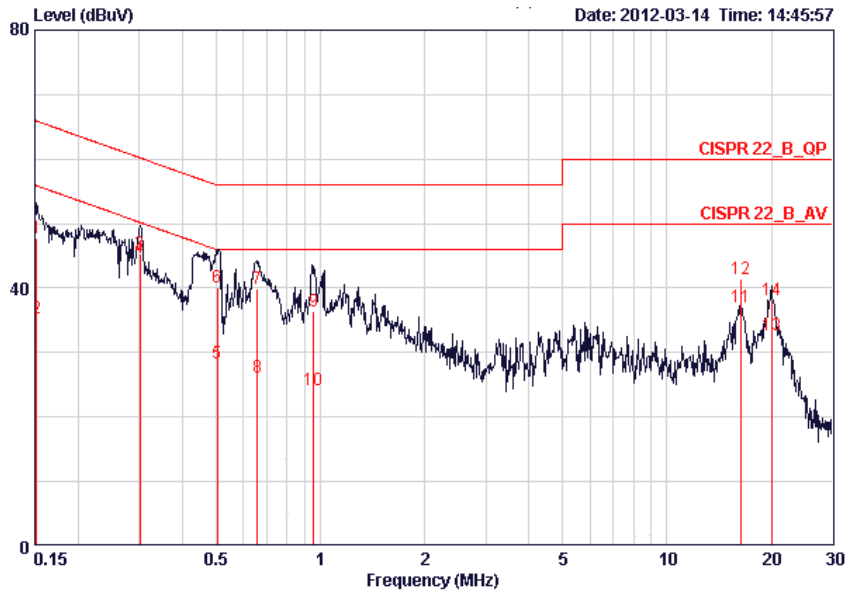

	Freq	Level	Over Limit	Limit Line	Read Level	LISN Factor	Cable Loss	Remark
	MHz	dBuV	dB	dBuV	dBuV	dB	dB	
1	0.15160	47.80	-18.11	65.91	47.50	0.10	0.20	QP
2	0.15160	35.39	-20.52	55.91	35.09	0.10	0.20	AVERAGE
3	0.30213	45.40	-14.78	60.18	45.13	0.07	0.20	QP
4	0.30213	44.68	-5.50	50.18	44.41	0.07	0.20	AVERAGE
5	0.50419	28.39	-17.61	46.00	28.13	0.07	0.19	AVERAGE
6	0.50419	40.21	-15.79	56.00	39.95	0.07	0.19	QP
7	0.65778	39.82	-16.18	56.00	39.55	0.07	0.20	QP
8	0.65778	26.21	-19.79	46.00	25.94	0.07	0.20	AVERAGE
9	0.95459	36.31	-19.69	56.00	36.04	0.07	0.20	QP
10	0.95459	24.19	-21.81	46.00	23.92	0.07	0.20	AVERAGE
11	16.400	37.01	-12.99	50.00	35.94	0.65	0.42	AVERAGE
12	16.400	41.34	-18.66	60.00	40.27	0.65	0.42	QP
13	20.051	32.74	-17.26	50.00	31.43	0.81	0.50	AVERAGE
14	20.051	38.14	-21.86	60.00	36.83	0.81	0.50	QP

Note:

Level = Read Level + LISN Factor + Cable Loss.

4.2. Peak Output Power Measurement

4.2.1. Limit

For systems using digital modulation in the 2400-2483.5MHz, the limit for peak output power is 30dBm. The limited has to be reduced by the amount in dB that the gain of the antenna exceed 6dBi. In case of point-to-point operation, the limit has to be reduced by 1dB for every 3dB that the directional gain of the antenna exceeds 6dBi.

4.2.2. Measuring Instruments and Setting

Please refer to section 5 of equipments list in this report. The following table is the setting of the peak power meter.

Power Meter Parameter	Setting
Bandwidth	50MHz bandwidth is greater than the EUT emission bandwidth
Detector	Peak

4.2.3. Test Procedures

Spectrum Parameter	Setting
RF Output Power Method	<input checked="" type="checkbox"/> ANSI C63.10 clause 6.10.2.1 (a) power meter method
RF Output Power Method	<input type="checkbox"/> ANSI C63.10 clause 6.10.2.1 (b) channel integration method
RF Output Power Method	<input type="checkbox"/> ANSI C63.10 clause 6.10.3.1 Method 1 - spectral trace averaging
RF Output Power Method	<input type="checkbox"/> ANSI C63.10 clause 6.10.3.2 Method 2 - zero-span mode with trace averaging

4.2.4. Test Setup Layout

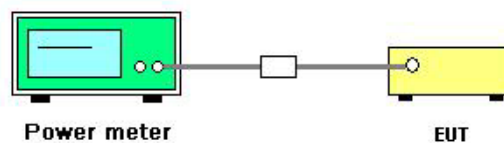

4.2.5. Test Deviation

There is no deviation with the original standard.

4.2.6. EUT Operation during Test

The EUT was programmed to be in continuously transmitting mode.

4.2.7. Test Result of Peak Output Power

Temperature	25°C	Humidity	60%
Test Engineer	Sean Ku	Configurations	IEEE 802.11n
Test Date	Mar. 01, 2012		

Configuration IEEE 802.11n MCS0 20MHz / Ant.B

Channel	Frequency	Conducted Power (dBm)	Max. Limit (dBm)	Result
1	2412 MHz	21.19	30.00	Complies
6	2437 MHz	21.72	30.00	Complies
11	2462 MHz	21.15	30.00	Complies

Configuration IEEE 802.11n MCS0 40MHz / Ant.B

Channel	Frequency	Conducted Power (dBm)	Max. Limit (dBm)	Result
3	2422 MHz	20.13	30.00	Complies
6	2437 MHz	21.44	30.00	Complies
9	2452 MHz	19.91	30.00	Complies

Temperature	25°C	Humidity	60%
Test Engineer	Sean Ku	Configurations	IEEE 802.11b/g
Test Date	Mar. 01, 2012		

Configuration IEEE 802.11b / Ant.B

Channel	Frequency	Conducted Power (dBm)	Max. Limit (dBm)	Result
1	2412 MHz	14.98	30.00	Complies
6	2437 MHz	14.54	30.00	Complies
11	2462 MHz	15.44	30.00	Complies

Configuration IEEE 802.11g / Ant.B

Channel	Frequency	Conducted Power (dBm)	Max. Limit (dBm)	Result
1	2412 MHz	20.84	30.00	Complies
6	2437 MHz	21.22	30.00	Complies
11	2462 MHz	20.93	30.00	Complies

4.3. Average Output Power Measurement

4.3.1. Measuring Instruments and Setting

Please refer to section 5 of equipments list in this report. The following table is the setting of the power meter.

Power Meter Parameter	Setting
Bandwidth	50MHz bandwidth is greater than the EUT emission bandwidth
Detector	Average

4.3.2. Test Procedures

Spectrum Parameter	Setting
RF Output Power Method	<input checked="" type="checkbox"/> ANSI C63.10 clause 6.10.2.1 (a) power meter method
RF Output Power Method	<input type="checkbox"/> ANSI C63.10 clause 6.10.2.1 (b) channel integration method
RF Output Power Method	<input type="checkbox"/> ANSI C63.10 clause 6.10.3.1 Method 1 - spectral trace averaging
RF Output Power Method	<input type="checkbox"/> ANSI C63.10 clause 6.10.3.2 Method 2 - zero-span mode with trace averaging

4.3.3. Test Setup Layout

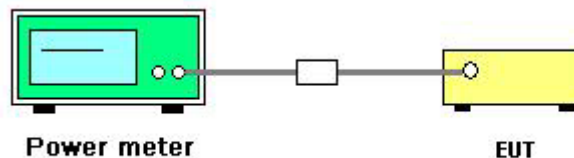

4.3.4. Test Deviation

There is no deviation with the original standard.

4.3.5. EUT Operation during Test

The EUT was programmed to be in continuously transmitting mode.

4.3.6. Test Result of Average Output Power

Temperature	25°C	Humidity	60%
Test Engineer	Sean Ku	Configurations	IEEE 802.11n
Test Date	Mar. 01, 2012		

Configuration IEEE 802.11n MCS8 20MHz / Ant.B

Channel	Frequency	Average Conducted Power (dBm)
1	2412 MHz	14.67
6	2437 MHz	15.58
11	2462 MHz	14.48

Configuration IEEE 802.11n MCS8 40MHz / Ant.B

Channel	Frequency	Average Conducted Power (dBm)
3	2422 MHz	12.85
6	2437 MHz	15.27
9	2452 MHz	12.56

Temperature	25°C	Humidity	60%
Test Engineer	Sean Ku	Configurations	IEEE 802.11b/g
Test Date	Mar. 01, 2012		

Configuration IEEE 802.11b / Ant.B

Channel	Frequency	Average Conducted Power (dBm)
1	2412 MHz	12.51
6	2437 MHz	12.11
11	2462 MHz	13.02

Configuration IEEE 802.11g / Ant.B

Channel	Frequency	Average Conducted Power (dBm)
1	2412 MHz	13.95
6	2437 MHz	15.06
11	2462 MHz	14.02

4.4. Power Spectral Density Measurement

4.4.1. Limit

For digitally modulated systems, the power spectral density conducted from the intentional radiator to the antenna shall not be greater than 8 dBm in any 3 kHz band during any time interval of continuous transmission.

4.4.2. Measuring Instruments and Setting

Please refer to section 5 of equipments list in this report. The following table is the setting of Spectrum Analyzer.

Spectrum Parameter	Setting
Attenuation	Auto
Span Frequency	Set the span to 1.5 times the DTS channel bandwidth.
RB	100 kHz
VB	300 kHz
Detector	Peak
Trace	Max Hold
Sweep Time	Auto

4.4.3. Test Procedures

1. Test procedures refer KDB558074 v01 r02 section 9.1 option 1
2. Spectrum analyzer must be capable of utilizing a number of measurement points in each sweep that is greater than or equal to twice the span/RBW in order to ensure bin-to-bin spacing of $\leq RBW/2$ so that narrowband signals are not lost between frequency bins.
3. Use this procedure when the maximum conducted output power in the fundamental emission is used to demonstrate compliance. The EUT must be configured to transmit continuously at full power over the measurement duration.
4. Ensure that the number of measurement points in the sweep $\geq 2 \times \text{span}/\text{RBW}$ (use of a greater number of measurement points than this minimum requirement is recommended).
5. Use the peak marker function to determine the maximum level in any 100 kHz band segment within the fundamental EBW.
6. Scale the observed power level to an equivalent level in 3 kHz by adjusting (reducing) the measured power by a bandwidth correction factor (BWCF) where: $BWCF = 10\log(3 \text{ kHz}/100 \text{ kHz} = -15.2 \text{ dB})$.
7. The resulting PSD level must be $\leq 8 \text{ dBm}$.
8. When measuring power spectral density with multiple antenna systems, add every result of the values by mathematic formula.

4.4.4. Test Setup Layout

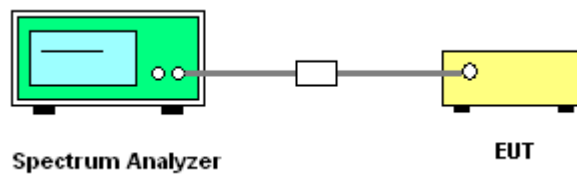

4.4.5. Test Deviation

There is no deviation with the original standard.

4.4.6. EUT Operation during Test

The EUT was programmed to be in continuously transmitting mode.

4.4.7. Test Result of Power Spectral Density

Temperature	25°C	Humidity	60%
Test Engineer	Sean Ku	Configurations	IEEE 802.11n

Configuration IEEE 802.11n MCS0 20MHz / Ant.B

Channel	Frequency	Power Density (dBm/100kHz)	BWCF factor (100KHz to 3KHz)	Power Density (dBm/3kHz)	Max. Limit (dBm/3kHz)	Result
1	2412 MHz	1.26	-15.23	-13.97	8.00	Complies
6	2437 MHz	2.25	-15.23	-12.98	8.00	Complies
11	2462 MHz	1.05	-15.23	-14.18	8.00	Complies

Configuration IEEE 802.11n MCS0 40MHz / Ant.B

Channel	Frequency	Power Density (dBm/100kHz)	BWCF factor (100KHz to 3KHz)	Power Density (dBm/3kHz)	Max. Limit (dBm/3kHz)	Result
3	2422 MHz	-3.91	-15.23	-19.14	8.00	Complies
6	2437 MHz	-1.13	-15.23	-16.36	8.00	Complies
9	2452 MHz	-3.19	-15.23	-18.42	8.00	Complies

Temperature	25°C	Humidity	60%
Test Engineer	Sean Ku	Configurations	IEEE 802.11b/g

Configuration IEEE 802.11b / Ant.B

Channel	Frequency	Power Density (dBm/100kHz)	BWCF factor (100KHz to 3KHz)	Power Density (dBm/3kHz)	Max. Limit (dBm/3kHz)	Result
1	2412 MHz	2.47	-15.23	-12.76	8.00	Complies
6	2437 MHz	1.77	-15.23	-13.46	8.00	Complies
11	2462 MHz	2.29	-15.23	-12.94	8.00	Complies

Configuration IEEE 802.11g / Ant.B

Channel	Frequency	Power Density (dBm/100kHz)	BWCF factor (100KHz to 3KHz)	Power Density (dBm/3kHz)	Max. Limit (dBm/3kHz)	Result
1	2412 MHz	0.48	-15.23	-14.75	8.00	Complies
6	2437 MHz	1.79	-15.23	-13.44	8.00	Complies
11	2462 MHz	0.12	-15.23	-15.11	8.00	Complies

Power Density Plot on Configuration IEEE 802.11n MCS0 20MHz / 2412 MHz

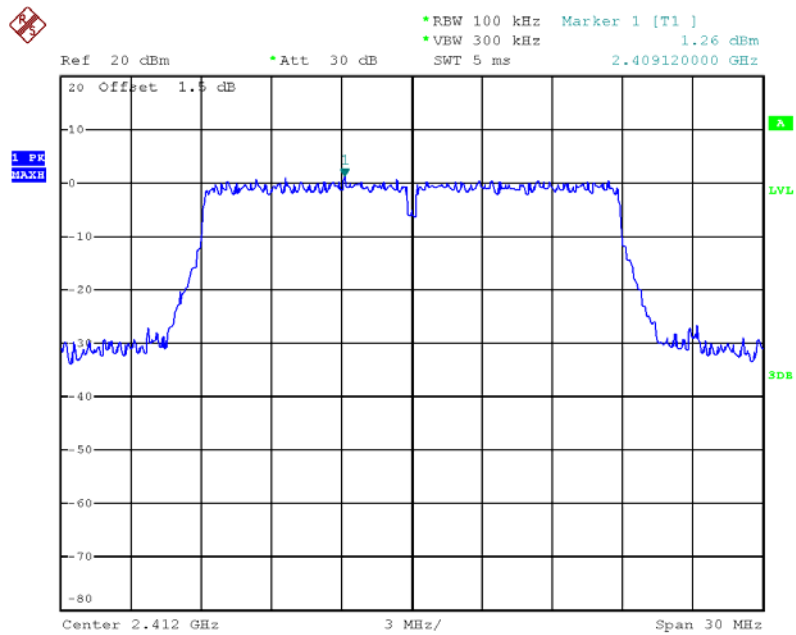

Date: 25.OCT.2012 12:56:04

Power Density Plot on Configuration IEEE 802.11n MCS0 20MHz / 2437 MHz

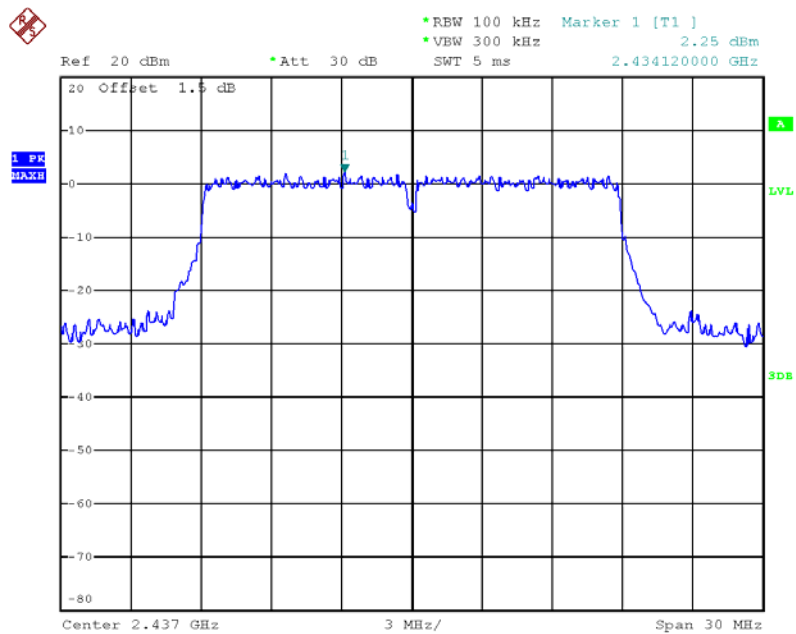

Date: 25.OCT.2012 12:55:05

Power Density Plot on Configuration IEEE 802.11n MCS0 20MHz / 2462 MHz

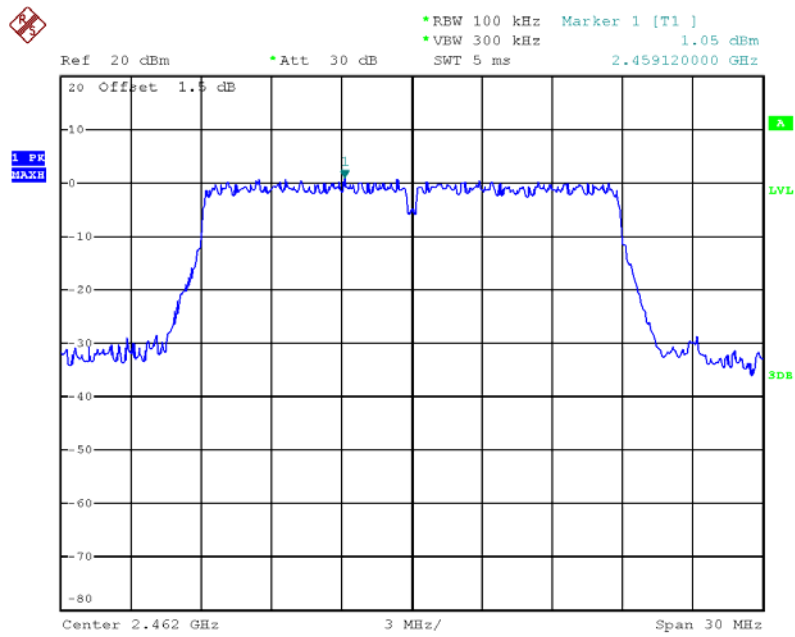

Date: 25.OCT.2012 12:52:28

Power Density Plot on Configuration IEEE 802.11n MCS0 40MHz / 2422 MHz

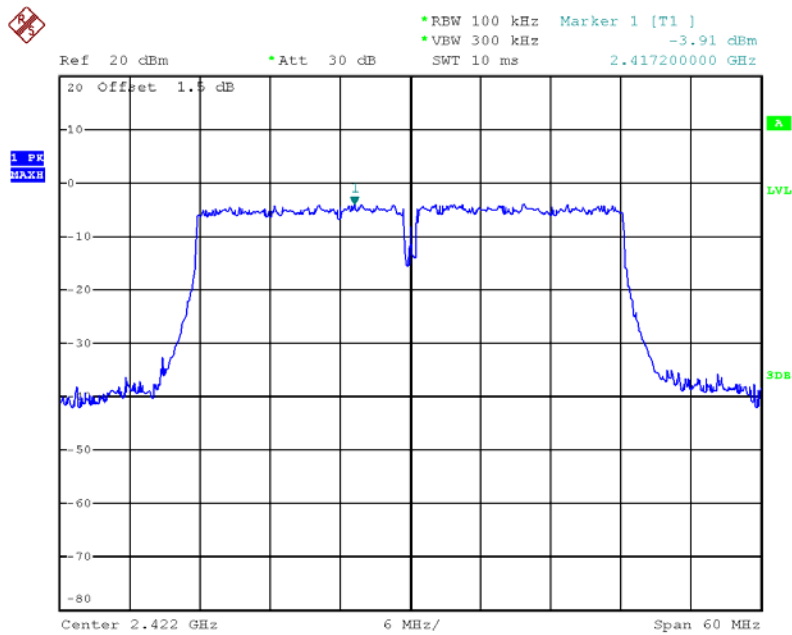

Date: 25.OCT.2012 13:00:35

Power Density Plot on Configuration IEEE 802.11n MCS0 40MHz / 2437 MHz

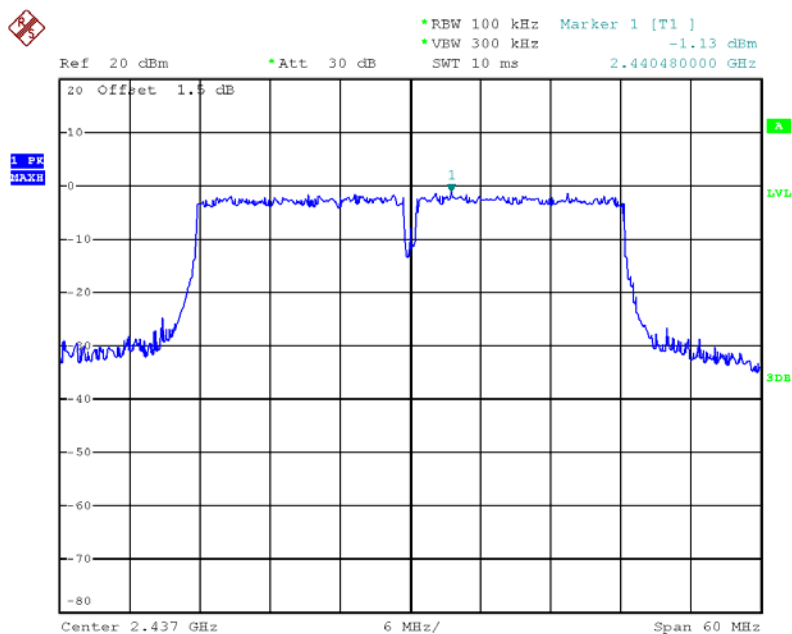

Date: 25.OCT.2012 13:04:27

Power Density Plot on Configuration IEEE 802.11n MCS0 40MHz / 2452 MHz

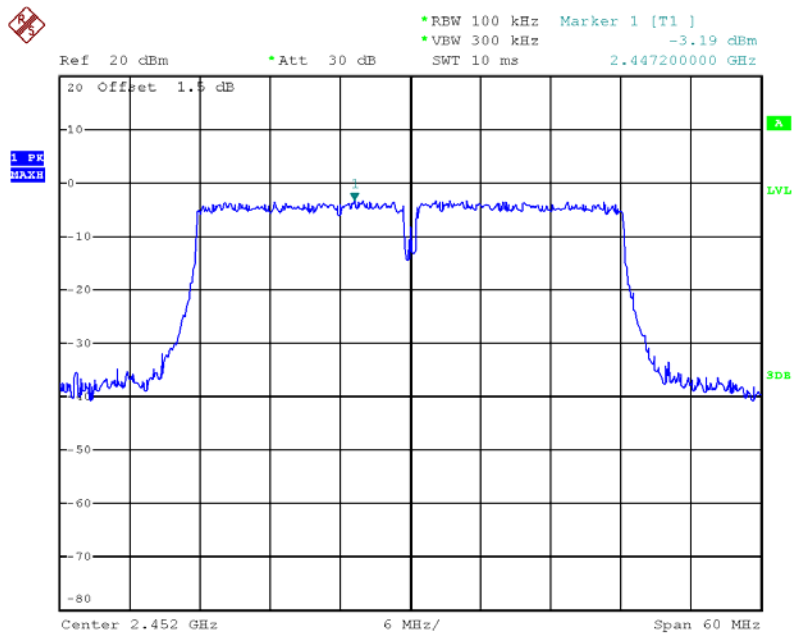

Date: 25.OCT.2012 13:05:32

Power Density Plot on Configuration IEEE 802.11b / 2412 MHz

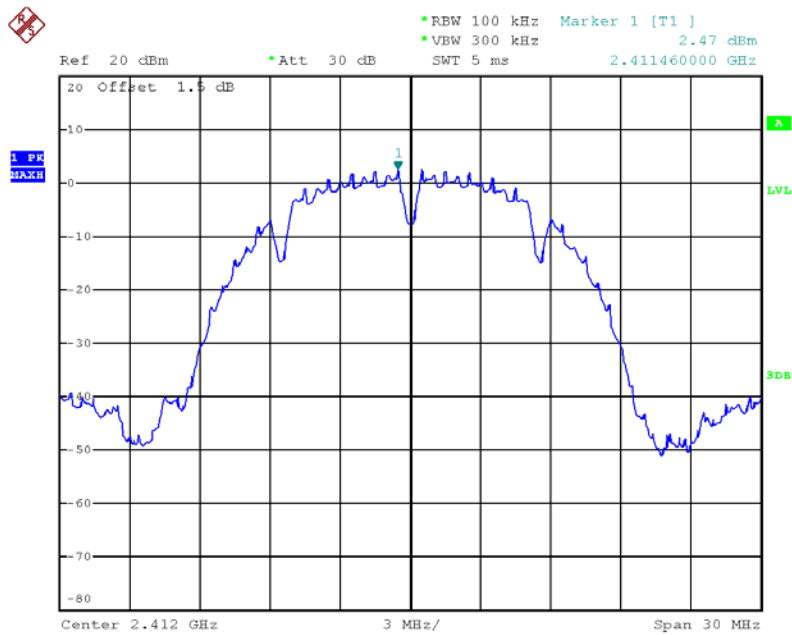

Date: 25.OCT.2012 12:35:45

Power Density Plot on Configuration IEEE 802.11b / 2437 MHz

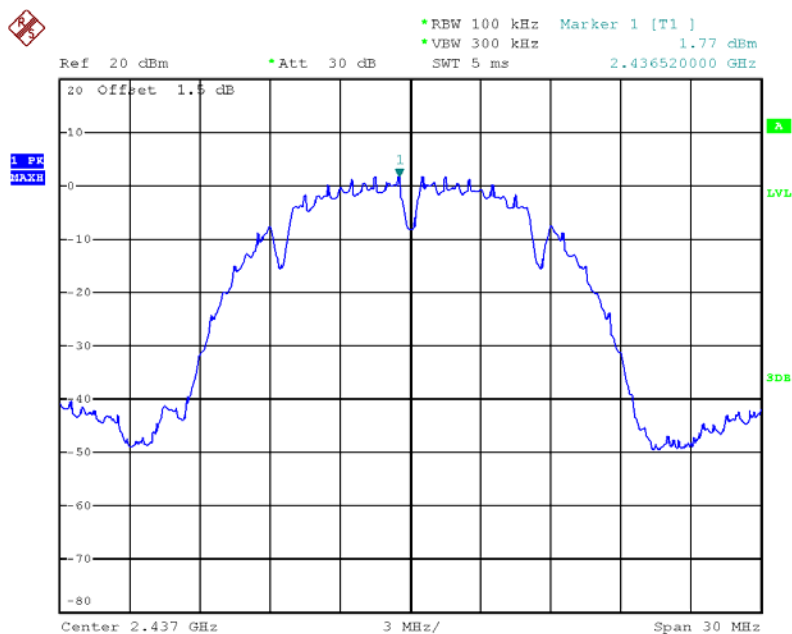

Date: 25.OCT.2012 12:31:07

Power Density Plot on Configuration IEEE 802.11b / 2462 MHz

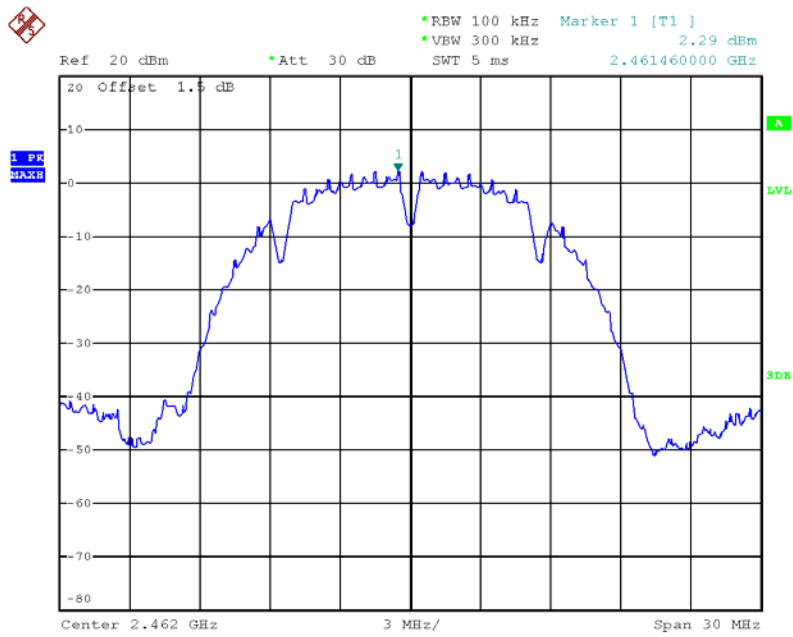

Date: 25.OCT.2012 12:37:16

Power Density Plot on Configuration IEEE 802.11g / 2412 MHz

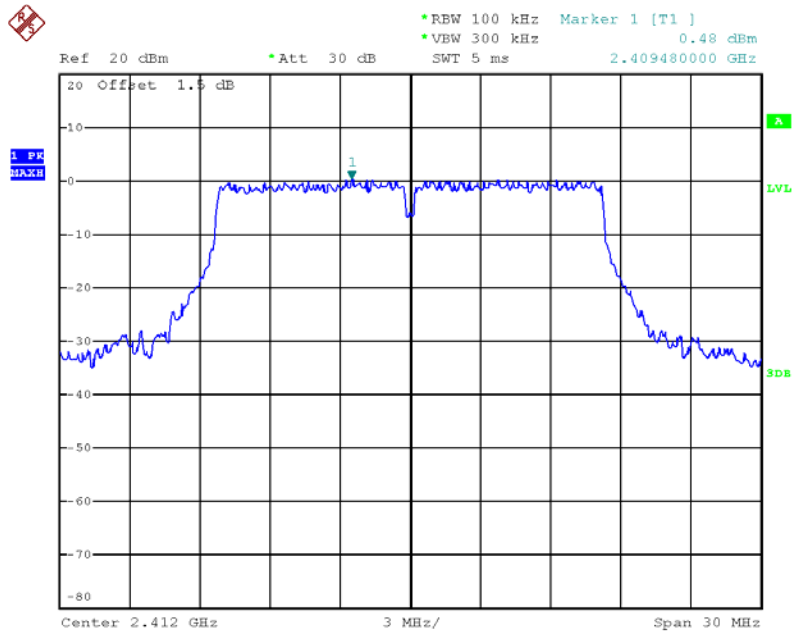

Date: 25.OCT.2012 12:42:10

Power Density Plot on Configuration IEEE 802.11g / 2437 MHz

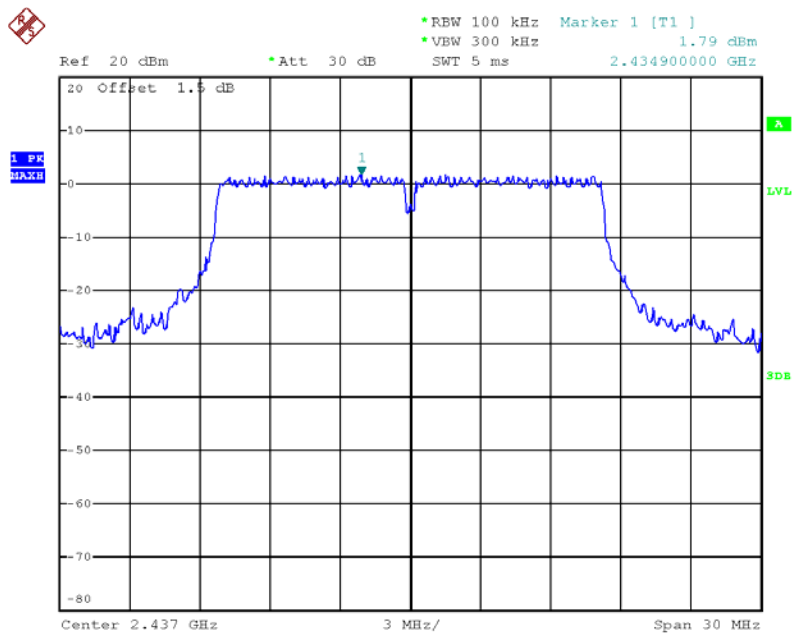

Date: 25.OCT.2012 12:45:47

Power Density Plot on Configuration IEEE 802.11g / 2462 MHz

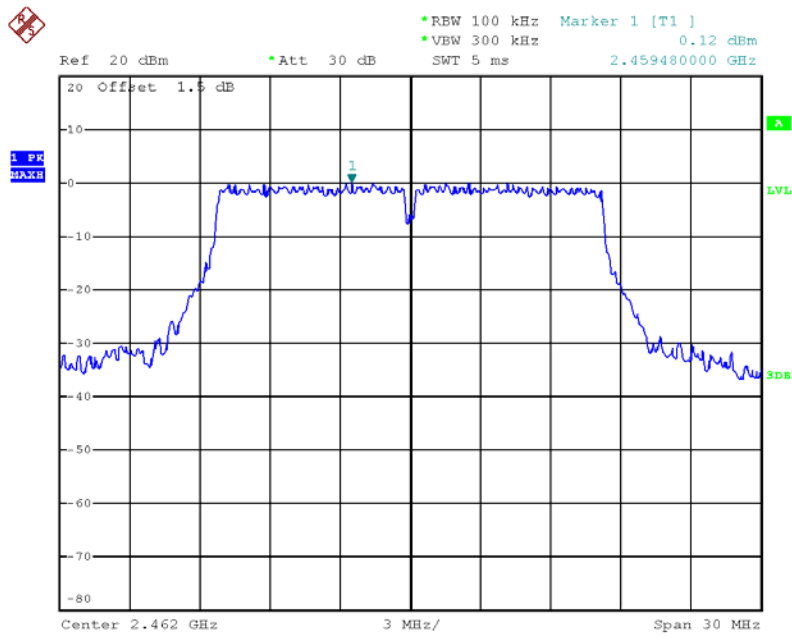

Date: 25.OCT.2012 12:50:07

4.5. 6dB Spectrum Bandwidth Measurement

4.5.1. Limit

For digital modulation systems, the minimum 6 dB bandwidth shall be at least 500 kHz.

4.5.2. Measuring Instruments and Setting

Please refer to section 5 of equipments list in this report. The following table is the setting of the Spectrum Analyzer.

Spectrum Parameters	Setting
Attenuation	Auto
Span Frequency	> 6dB Bandwidth
RB	1-5 % of the emission bandwidth (EBW)
VB	$\geq 3 \times \text{RBW}$
Detector	Peak
Trace	Max Hold
Sweep Time	Auto

4.5.3. Test Procedures

1. The transmitter output (antenna port) was connected to the spectrum analyzer in peak hold mode.
2. Test was performed in accordance with KDB 558074 Guidance for Performing Compliance Measurements on Digital Transmission Systems (DTS) Operating Under §15.247 section 5.1.1 EBW Measurement Procedure
3. Multiple antenna system was performed in accordance with KDB 662911 Emissions Testing of Transmitters with Multiple Outputs in the Same Band.
4. Measured the spectrum width with power higher than 6dB below carrier.

4.5.4. Test Setup Layout

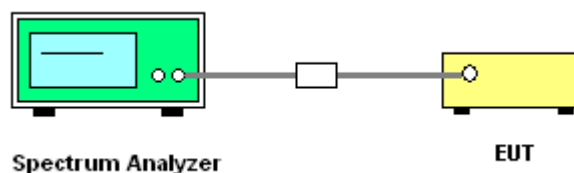

4.5.5. Test Deviation

There is no deviation with the original standard.

4.5.6. EUT Operation during Test

The EUT was programmed to be in continuously transmitting mode.

4.5.7. Test Result of 6dB Spectrum Bandwidth

Temperature	21°C	Humidity	65%
Test Engineer	Sean Ku	Configurations	IEEE 802.11n

Configuration IEEE 802.11n MCS0 20MHz / Ant. B

Channel	Frequency	6dB Bandwidth (MHz)	99% Occupied Bandwidth (MHz)	Min. Limit (kHz)	Test Result
1	2412 MHz	17.76	17.76	500	Complies
6	2437 MHz	17.84	17.76	500	Complies
11	2462 MHz	17.84	17.76	500	Complies

Configuration IEEE 802.11n MCS0 40MHz / Ant. B

Channel	Frequency	6dB Bandwidth (MHz)	99% Occupied Bandwidth (MHz)	Min. Limit (kHz)	Test Result
3	2422 MHz	36.60	36.36	500	Complies
6	2437 MHz	36.60	36.36	500	Complies
9	2452 MHz	36.60	36.36	500	Complies

Temperature	21°C	Humidity	65%
Test Engineer	Sean Ku	Configurations	IEEE 802.11b/g

Configuration IEEE 802.11b / Ant. B

Channel	Frequency	6dB Bandwidth (MHz)	99% Occupied Bandwidth (MHz)	Min. Limit (kHz)	Test Result
1	2412 MHz	10.00	13.60	500	Complies
6	2437 MHz	10.00	13.52	500	Complies
11	2462 MHz	10.08	13.52	500	Complies

Configuration IEEE 802.11g / Ant. B

Channel	Frequency	6dB Bandwidth (MHz)	99% Occupied Bandwidth (MHz)	Min. Limit (kHz)	Test Result
1	2412 MHz	16.64	16.56	500	Complies
6	2437 MHz	16.56	16.48	500	Complies
11	2462 MHz	16.56	16.48	500	Complies

6 dB Bandwidth Plot on Configuration IEEE 802.11n MCS0 20MHz / 2412 MHz

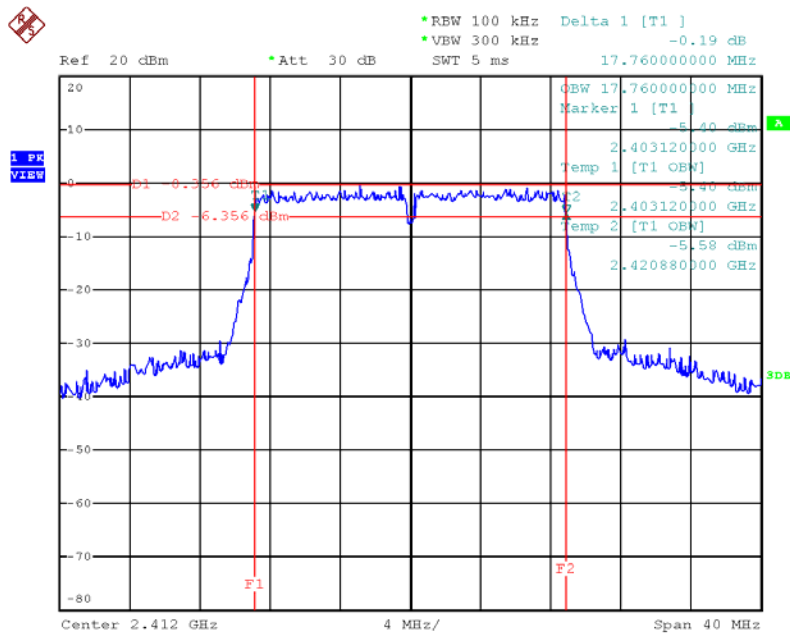

Date: 25.OCT.2012 12:56:38

6 dB Bandwidth Plot on Configuration IEEE 802.11n MCS0 20MHz / 2437 MHz

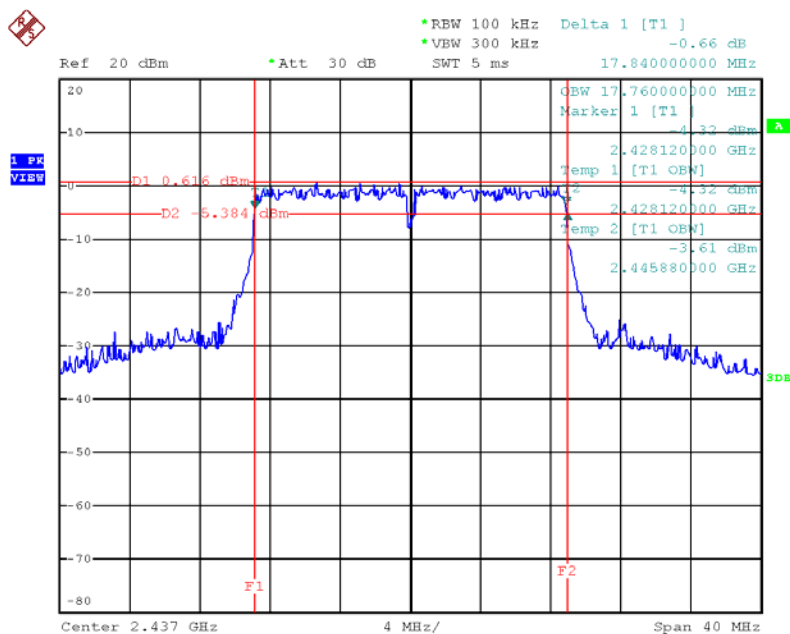

Date: 25.OCT.2012 12:54:39

6 dB Bandwidth Plot on Configuration IEEE 802.11n MCS0 20MHz / 2462 MHz

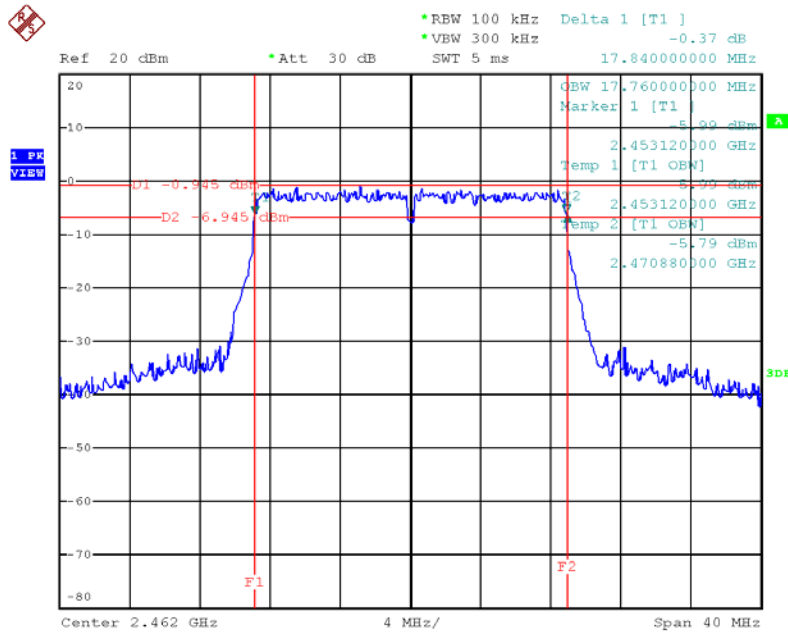

Date: 25.OCT.2012 12:53:32

6 dB Bandwidth Plot on Configuration IEEE 802.11n MCS0 40MHz / 2422 MHz

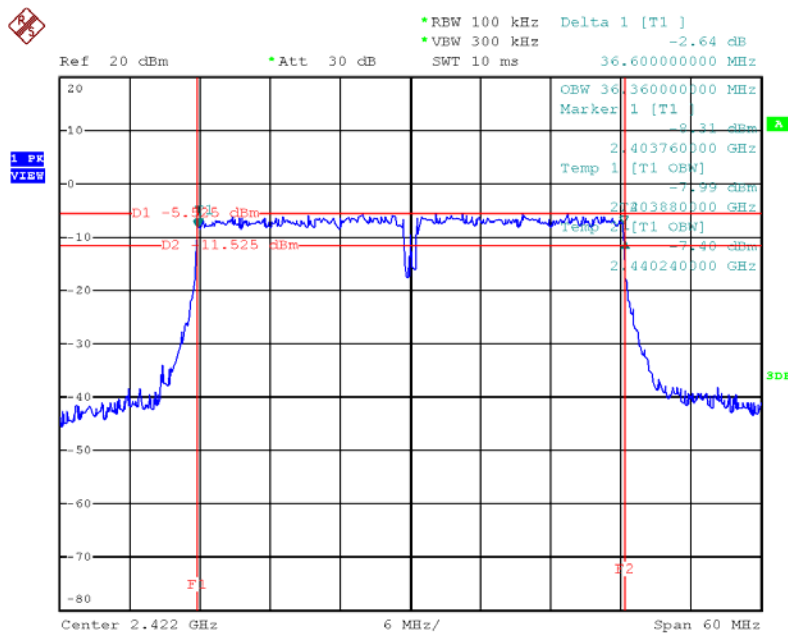

Date: 25.OCT.2012 13:02:13

6 dB Bandwidth Plot on Configuration IEEE 802.11n MCS0 40MHz / 2437 MHz

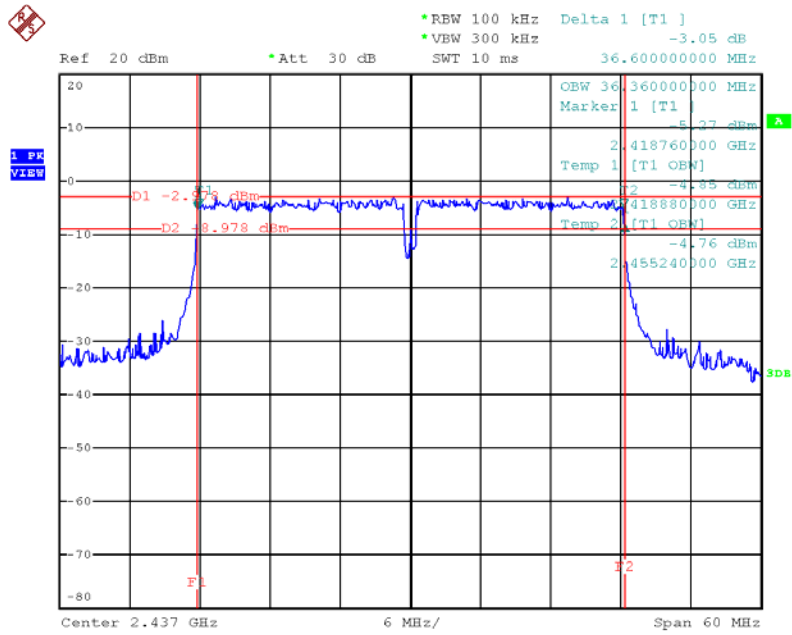

Date: 25.OCT.2012 13:03:41

6 dB Bandwidth Plot on Configuration IEEE 802.11n MCS0 40MHz / 2452 MHz

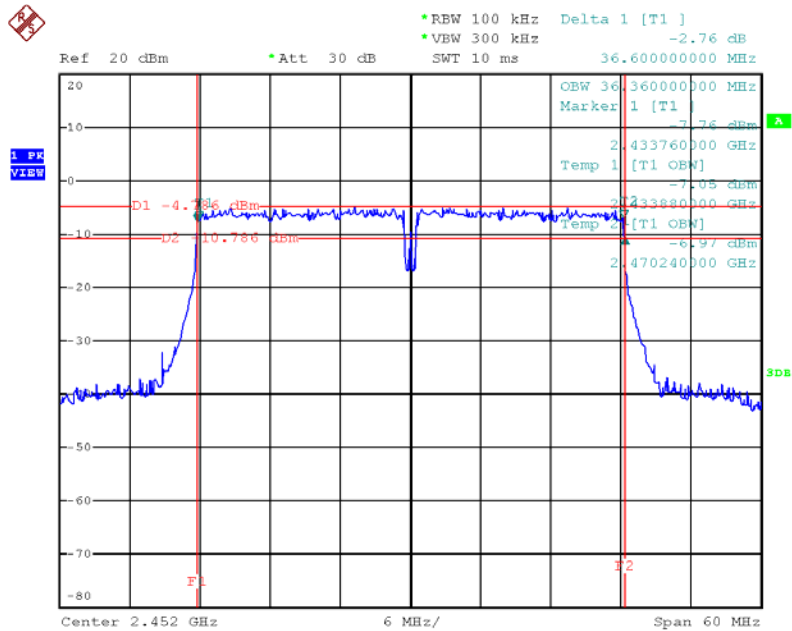

Date: 25.OCT.2012 13:06:06

6 dB Bandwidth Plot on Configuration IEEE 802.11b / 2412 MHz

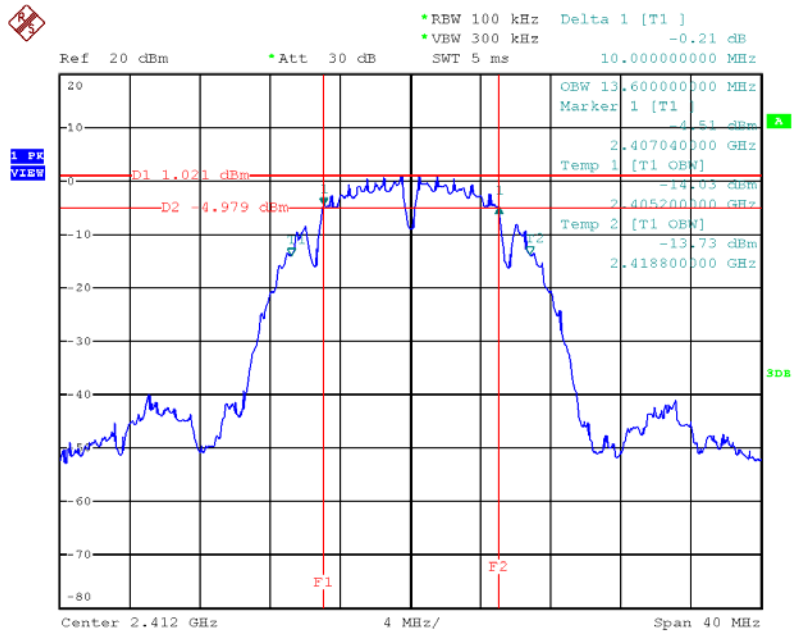

Date: 25.OCT.2012 12:34:39

6 dB Bandwidth Plot on Configuration IEEE 802.11b / 2437 MHz

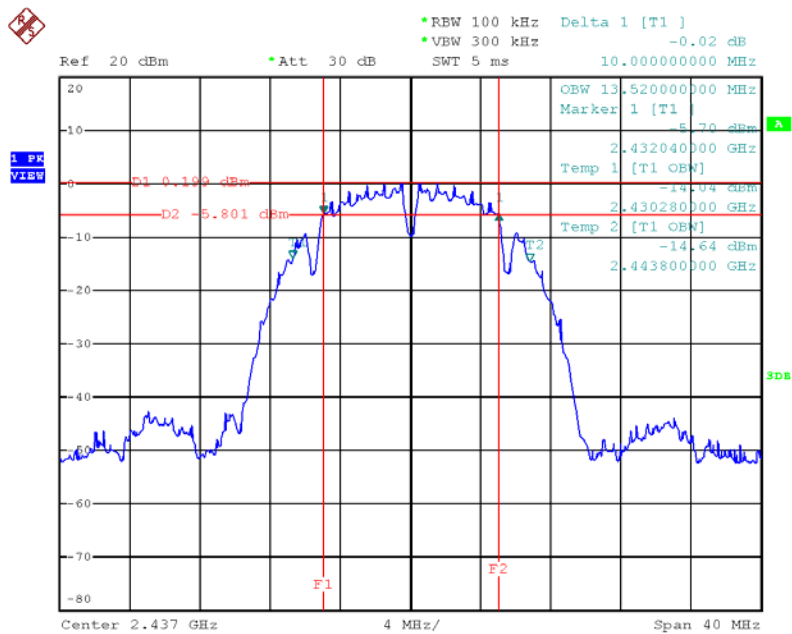

Date: 25.OCT.2012 12:32:01

6 dB Bandwidth Plot on Configuration IEEE 802.11b / 2462 MHz

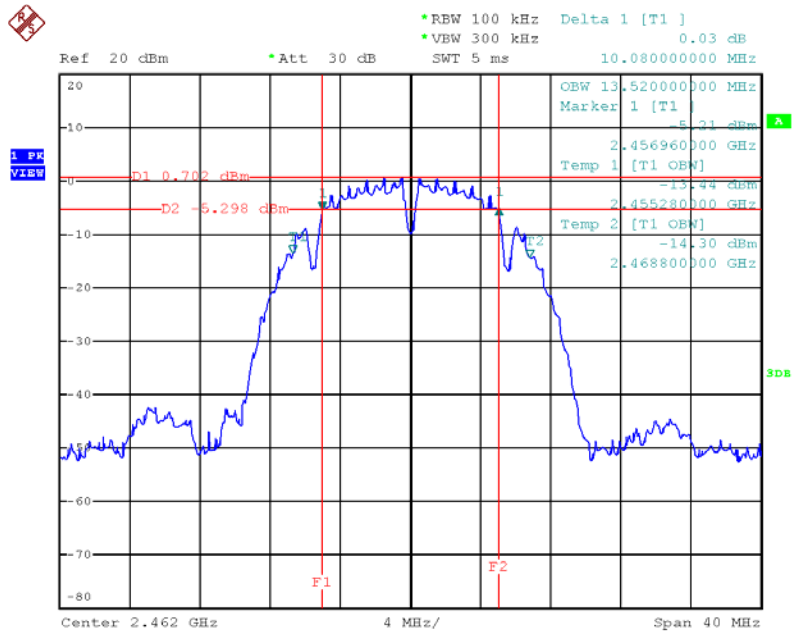

Date: 25.OCT.2012 12:38:04

6 dB Bandwidth Plot on Configuration IEEE 802.11g / 2412 MHz

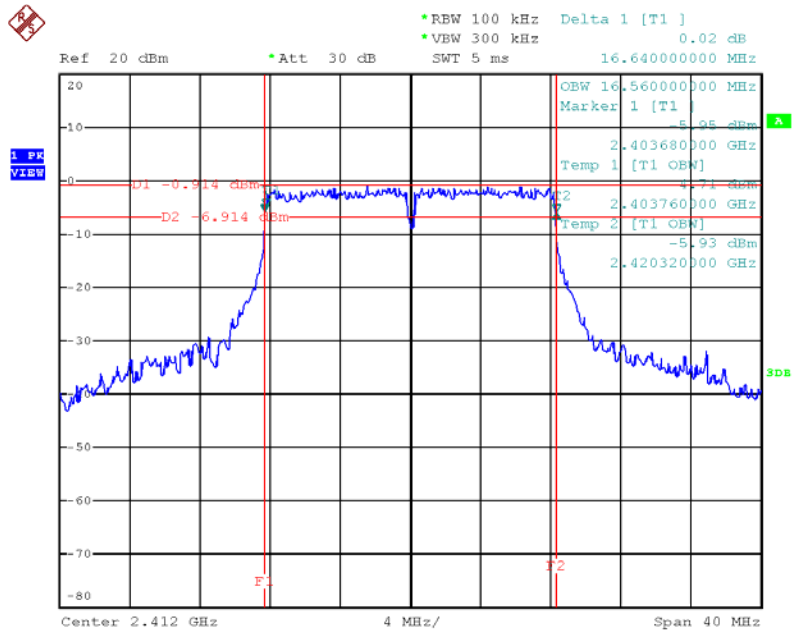

Date: 25.OCT.2012 12:41:45

6 dB Bandwidth Plot on Configuration IEEE 802.11g / 2437 MHz

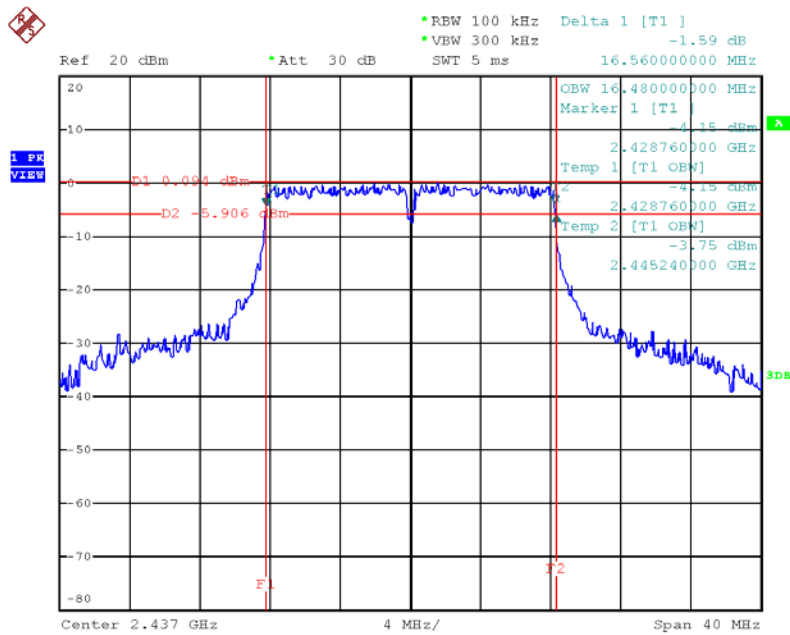

Date: 25.OCT.2012 12:46:23

6 dB Bandwidth Plot on Configuration IEEE 802.11g / 2462 MHz

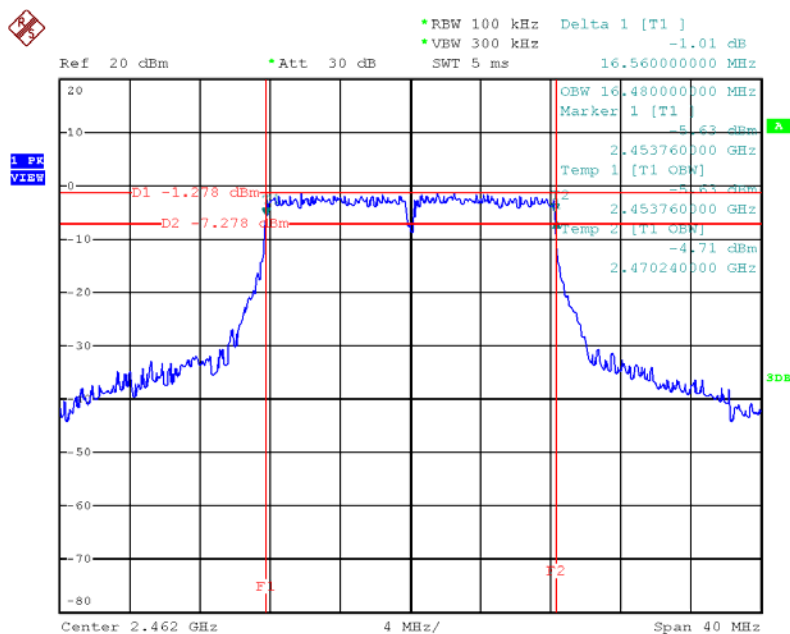

Date: 25.OCT.2012 12:49:29

4.6. Radiated Emissions Measurement

4.6.1. Limit

20dBc in any 100 kHz bandwidth outside the operating frequency band. In case the emission fall within the restricted band specified on 15.205(a), then the 15.209(a) limit in the table below has to be followed.

Frequencies (MHz)	Field Strength (micorvolts/meter)	Measurement Distance (meters)
0.009~0.490	2400/F(KHz)	300
0.490~1.705	24000/F(KHz)	30
1.705~30.0	30	30
30~88	100	3
88~216	150	3
216~960	200	3
Above 960	500	3

4.6.2. Measuring Instruments and Setting

Please refer to section 5 of equipments list in this report. The following table is the setting of spectrum analyzer and receiver.

Spectrum Parameter	Setting
Attenuation	Auto
Start Frequency	1000 MHz
Stop Frequency	10th carrier harmonic
RB / VB (Emission in restricted band)	1MHz / 3MHz for Peak, 1 MHz / 10Hz for Average
RB / VB (Emission in non-restricted band)	1MHz / 3MHz for peak

Receiver Parameter	Setting
Attenuation	Auto
Start ~ Stop Frequency	9kHz~150kHz / RB 200Hz for QP
Start ~ Stop Frequency	150kHz~30MHz / RB 9kHz for QP
Start ~ Stop Frequency	30MHz~1000MHz / RB 120kHz for QP

4.6.3. Test Procedures

1. Configure the EUT according to ANSI C63.10. The EUT was placed on the top of the turntable 0.8 meter above ground. The phase center of the receiving antenna mounted on the top of a height-variable antenna tower was placed 3 meters far away from the turntable.
2. Power on the EUT and all the supporting units. The turntable was rotated by 360 degrees to determine the position of the highest radiation.
3. The height of the broadband receiving antenna was varied between one meter and four meters above ground to find the maximum emissions field strength of both horizontal and vertical polarization.
4. For each suspected emissions, the antenna tower was scan (from 1 m to 4 m) and then the turntable was rotated (from 0 degree to 360 degrees) to find the maximum reading.
5. Set the test-receiver system to Peak or CISPR quasi-peak Detect Function with specified bandwidth under Maximum Hold Mode.
6. For emissions above 1GHz, use 1MHz VBW and 3MHz RBW for peak reading. Then 1MHz RBW and 10Hz VBW for average reading in spectrum analyzer.
7. When the radiated emissions limits are expressed in terms of the average value of the emissions, and pulsed operation is employed, the measurement field strength shall be determined by averaging over one complete pulse train, including blanking intervals, as long as the pulse train does not exceed 0.1 seconds. As an alternative (provided the transmitter operates for longer than 0.1 seconds) or in cases where the pulse train exceeds 0.1 seconds, the measured field strength shall be determined from the average absolute voltage during a 0.1 second interval during which the field strength is at its maximum value.
8. If the emissions level of the EUT in peak mode was 3 dB lower than the average limit specified, then testing will be stopped and peak values of EUT will be reported, otherwise, the emissions which do not have 3 dB margin will be repeated one by one using the quasi-peak method for below 1GHz.
9. For testing above 1GHz, the emissions level of the EUT in peak mode was lower than average limit (that means the emissions level in peak mode also complies with the limit in average mode), then testing will be stopped and peak values of EUT will be reported, otherwise, the emissions will be measured in average mode again and reported.
10. In case the emission is lower than 30MHz, loop antenna has to be used for measurement and the recorded data should be QP measured by receiver. High – Low scan is not required in this case.

4.6.4. Test Setup Layout

For Radiated Emissions below 1GHz

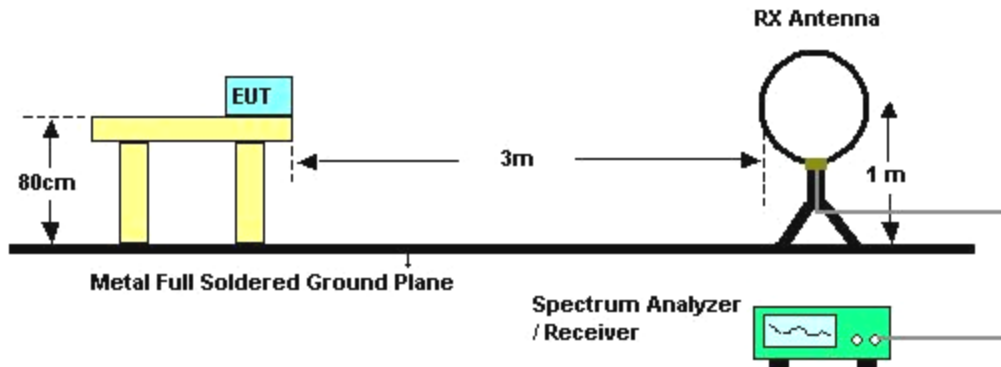

For Radiated Emissions above 1GHz

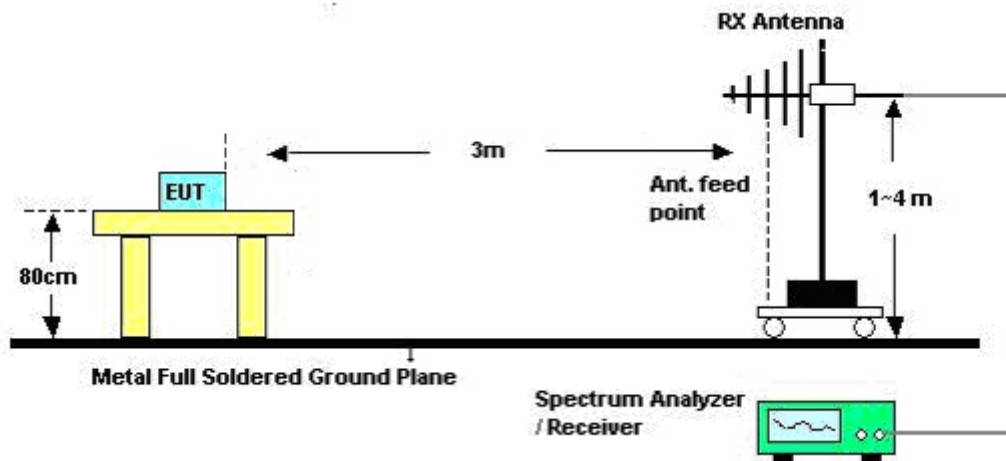

4.6.5. Test Deviation

There is no deviation with the original standard.

4.6.6. EUT Operation during Test

The EUT was programmed to be in continuously transmitting mode.

4.6.7. Results of Radiated Emissions (9kHz~30MHz)

Temperature	26°C	Humidity	60%
Test Engineer	Serway Li	Configurations	Normal Link
Test Date	Mar. 14, 2012		

Freq. (MHz)	Level (dBuV)	Over Limit (dB)	Limit Line (dBuV)	Remark
-	-	-	-	See Note

Note:

The amplitude of spurious emissions which are attenuated by more than 20 dB below the permissible value has no need to be reported.

Distance extrapolation factor = $40 \log (\text{specific distance} / \text{test distance})$ (dB);

Limit line = specific limits (dBuV) + distance extrapolation factor.

4.6.8. Results of Radiated Emissions (30MHz~1GHz)

Temperature	26°C	Humidity	60%
Test Engineer	Serway Li	Configurations	Normal Link

Horizontal

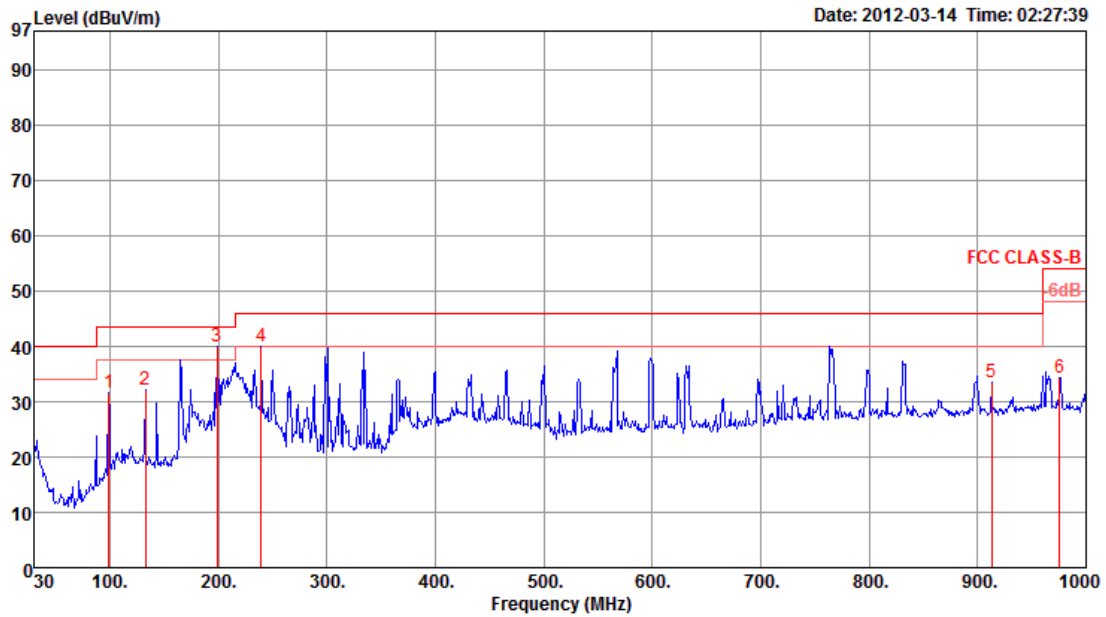

	Freq	Level	Limit	Over	Read	Cable	Preamp	Antenna	T/Pos	A/Pos	Remark	Pol/Phase
	MHz	dBuV/m	dBuV/m	dB	dBuV	Loss	Factor	Factor	deg	cm		
1	98.87	31.51	43.50	-11.99	46.75	1.49	27.61	10.88	0	400	Peak	HORIZONTAL
2	132.82	32.06	43.50	-11.44	45.61	1.68	27.43	12.20	0	400	Peak	HORIZONTAL
3	198.78	39.94	43.50	-3.56	55.31	2.09	27.11	9.65	0	400	Peak	HORIZONTAL
4	239.52	40.08	46.00	-5.92	53.33	2.31	27.02	11.46	0	400	Peak	HORIZONTAL
5	912.70	33.39	46.00	-12.61	35.27	4.66	27.35	20.81	0	400	Peak	HORIZONTAL
6	975.75	34.27	54.00	-19.73	35.15	4.85	27.10	21.37	0	400	Peak	HORIZONTAL

Vertical

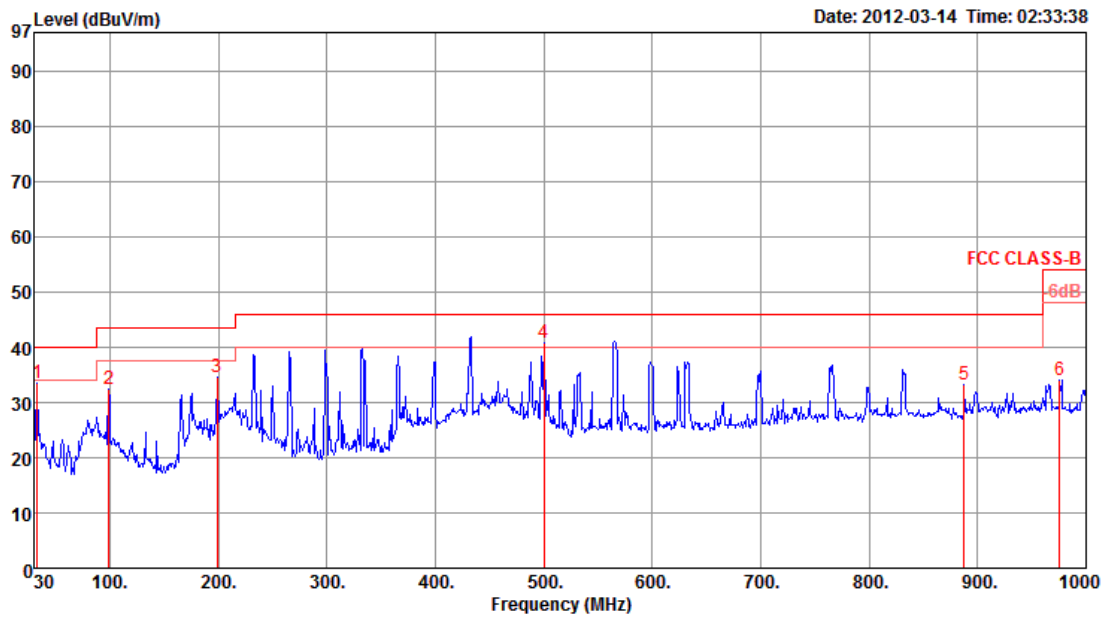

	Freq	Level	Limit	Over	Read	Cable	Preamp	Antenna	T/Pos	A/Pos	Remark	Pol/Phase
	MHz	dBuV/m	dBuV/m	dB	dBuV	dB	dB	dB/m	deg	cm		
1	32.91	33.62	40.00	-6.38	43.29	0.88	27.80	17.25	0	100	Peak	VERTICAL
2	98.87	32.46	43.50	-11.04	47.70	1.49	27.61	10.88	0	100	Peak	VERTICAL
3	198.78	34.69	43.50	-8.81	50.06	2.09	27.11	9.65	0	100	Peak	VERTICAL
4	500.45	40.77	46.00	-5.23	47.39	3.38	28.10	18.10	0	100	Peak	VERTICAL
5	887.48	33.10	46.00	-12.90	35.14	4.55	27.43	20.84	0	100	Peak	VERTICAL
6	975.75	33.97	54.00	-20.03	34.85	4.85	27.10	21.37	0	100	Peak	VERTICAL

Note:

The amplitude of spurious emissions which are attenuated by more than 20 dB below the permissible value has no need to be reported.

Emission level (dBuV/m) = 20 log Emission level (uV/m).

Corrected Reading: Antenna Factor + Cable Loss + Read Level - Preamp Factor = Level.

4.6.9. Results for Radiated Emissions (1GHz~10th Harmonic)

Temperature	26°C	Humidity	60%
Test Engineer	Serway Li	Configurations	IEEE 802.11n MCS0 20MHz Ch 1 / Ant. B
Test Date	Feb. 27, 2012		

Horizontal

	Freq	Level	Limit Line	Over Limit	Read Level	CableAntenna Loss	Antenna Factor	Preamp Factor	Remark	A/Pos	T/Pos	Pol/Phase
	MHz	dBuV/m	dBuV/m	dB	dBuV	dB	dB/m	dB		cm	deg	
1	4822.20	48.77	74.00	-25.23	47.43	3.31	33.06	35.03	Peak	101	254	HORIZONTAL
2	4823.80	35.79	54.00	-18.21	34.45	3.31	33.06	35.03	Average	101	254	HORIZONTAL

Vertical

	Freq	Level	Limit Line	Over Limit	Read Level	CableAntenna Loss	Antenna Factor	Preamp Factor	Remark	A/Pos	T/Pos	Pol/Phase
	MHz	dBuV/m	dBuV/m	dB	dBuV	dB	dB/m	dB		cm	deg	
1	4823.12	53.89	74.00	-20.11	52.55	3.31	33.06	35.03	Peak	104	158	VERTICAL
2	4823.84	39.73	54.00	-14.27	38.39	3.31	33.06	35.03	Average	104	158	VERTICAL



Temperature	26°C	Humidity	60%
Test Engineer	Serway Li	Configurations	IEEE 802.11n MCS0 20MHz Ch 6 / Ant. B
Test Date	Feb. 27, 2012		

Horizontal

	Freq	Level	Limit Line	Over Limit	Read Level	CableAntenna Loss	Antenna Factor	Preamp Factor	Remark	A/Pos	T/Pos	PoI/Phase
	MHz	dBuV/m	dBuV/m	dB	dBuV	dB	dB/m	dB		cm	deg	
1	4873.04	52.88	74.00	-21.12	51.42	3.33	33.16	35.03	Peak	101	256	HORIZONTAL
2	4873.76	39.83	54.00	-14.17	38.37	3.33	33.16	35.03	Average	101	256	HORIZONTAL
3	7306.70	46.85	54.00	-7.15	42.27	4.06	35.92	35.40	Average	101	193	HORIZONTAL
4	7309.20	62.44	74.00	-11.56	57.82	4.06	35.96	35.40	Peak	101	193	HORIZONTAL

Vertical

	Freq	Level	Limit Line	Over Limit	Read Level	CableAntenna Loss	Antenna Factor	Preamp Factor	Remark	A/Pos	T/Pos	PoI/Phase
	MHz	dBuV/m	dBuV/m	dB	dBuV	dB	dB/m	dB		cm	deg	
1	4873.88	43.99	54.00	-10.01	42.53	3.33	33.16	35.03	Average	101	154	VERTICAL
2	4876.56	58.13	74.00	-15.87	56.67	3.33	33.16	35.03	Peak	101	154	VERTICAL
3	7309.60	66.83	74.00	-7.17	62.21	4.06	35.96	35.40	Peak	101	212	VERTICAL
4	7311.60	52.70	54.00	-1.30	48.08	4.06	35.96	35.40	Average	101	212	VERTICAL



Temperature	26°C	Humidity	60%
Test Engineer	Serway Li	Configurations	IEEE 802.11n MCS0 20MHz Ch 11 / Ant. B
Test Date	Feb. 27, 2012		

Horizontal

	Freq	Level	Limit Line	Over Limit	Read Level	CableAntenna Loss	Antenna Factor	Preamp Factor	Remark	A/Pos	T/Pos	Pol/Phase
	MHz	dBuV/m	dBuV/m	dB	dBuV	dB	dB/m	dB		cm	deg	
1	4924.04	40.84	54.00	-13.16	39.24	3.35	33.26	35.01	Average	100	244	HORIZONTAL
2	4931.04	55.19	74.00	-18.81	53.59	3.35	33.26	35.01	Peak	100	244	HORIZONTAL

Vertical

	Freq	Level	Limit Line	Over Limit	Read Level	CableAntenna Loss	Antenna Factor	Preamp Factor	Remark	A/Pos	T/Pos	Pol/Phase
	MHz	dBuV/m	dBuV/m	dB	dBuV	dB	dB/m	dB		cm	deg	
1	4923.08	58.65	74.00	-15.35	57.05	3.35	33.26	35.01	Peak	102	151	VERTICAL
2	4923.92	44.84	54.00	-9.16	43.24	3.35	33.26	35.01	Average	102	151	VERTICAL

Temperature	26°C	Humidity	60%
Test Engineer	Serway Li	Configurations	IEEE 802.11n MCS0 40MHz Ch 3 / Ant. B
Test Date	Feb. 27, 2012		

Horizontal

	Freq	Level	Limit	Over	Read	CableAntenna	Preamp	Remark	A/Pos	T/Pos	Pol/Phase
	MHz	dBuV/m	dBuV/m	dB	dBuV	dB	dB/m	dB	cm	deg	
1	4843.83	44.80	74.00	-29.20	43.42	3.32	33.09	35.03	Peak	100	218 HORIZONTAL
2	4843.90	34.03	54.00	-19.97	32.65	3.32	33.09	35.03	Average	100	218 HORIZONTAL

Vertical

	Freq	Level	Limit	Over	Read	CableAntenna	Preamp	Remark	A/Pos	T/Pos	Pol/Phase
	MHz	dBuV/m	dBuV/m	dB	dBuV	dB	dB/m	dB	cm	deg	
1	4843.94	35.60	54.00	-18.40	34.22	3.32	33.09	35.03	Average	100	131 VERTICAL
2	4844.20	44.92	74.00	-29.08	43.54	3.32	33.09	35.03	Peak	100	131 VERTICAL



Temperature	26°C	Humidity	60%
Test Engineer	Serway Li	Configurations	IEEE 802.11n MCS0 40MHz Ch 6 / Ant. B
Test Date	Feb. 27, 2012		

Horizontal

	Freq	Level	Limit	Over	Read	CableAntenna	Preamp		A/Pos	T/Pos	Pol/Phase
	MHz	dBuV/m	dBuV/m	dB	dBuV	dB	dB/m	dB	cm	deg	
1	4874.00	38.36	54.00	-15.64	36.90	3.33	33.16	35.03	100	207	HORIZONTAL
2	4875.04	50.34	74.00	-23.66	48.88	3.33	33.16	35.03	100	207	HORIZONTAL
3	7304.20	57.81	74.00	-16.19	53.23	4.06	35.92	35.40	100	183	HORIZONTAL
4	7307.40	40.80	54.00	-13.20	36.22	4.06	35.92	35.40	100	183	HORIZONTAL

Vertical

	Freq	Level	Limit	Over	Read	CableAntenna	Preamp		A/Pos	T/Pos	Pol/Phase
	MHz	dBuV/m	dBuV/m	dB	dBuV	dB	dB/m	dB	cm	deg	
1	4873.44	51.65	74.00	-22.35	50.19	3.33	33.16	35.03	100	142	VERTICAL
2	4874.24	40.25	54.00	-13.75	38.79	3.33	33.16	35.03	100	142	VERTICAL
3	7304.24	57.59	74.00	-16.41	53.01	4.06	35.92	35.40	100	115	VERTICAL
4	7304.44	40.72	54.00	-13.28	36.14	4.06	35.92	35.40	100	115	VERTICAL

Temperature	26°C	Humidity	60%
Test Engineer	Serway Li	Configurations	IEEE 802.11n MCS0 40MHz Ch 9 / Ant. B
Test Date	Feb. 27, 2012		

Horizontal

	Freq	Level	Limit	Over	Read	Cable	Antenna	Preamp	Remark	A/Pos	T/Pos	Pol/Phase
	MHz	dBuV/m	dBuV/m	dB	dBuV	dB	dB/m	dB		cm	deg	
1	4903.88	36.17	54.00	-17.83	34.66	3.34	33.19	35.02	Average	100	132	HORIZONTAL
2	4906.24	45.01	74.00	-28.99	43.46	3.34	33.23	35.02	Peak	100	132	HORIZONTAL

Vertical

	Freq	Level	Limit	Over	Read	Cable	Antenna	Preamp	Remark	A/Pos	T/Pos	Pol/Phase
	MHz	dBuV/m	dBuV/m	dB	dBuV	dB	dB/m	dB		cm	deg	
1	4902.88	55.35	74.00	-18.65	53.84	3.34	33.19	35.02	Peak	100	312	VERTICAL
2	4904.04	40.09	54.00	-13.91	38.58	3.34	33.19	35.02	Average	100	312	VERTICAL

Note:

The amplitude of spurious emissions which are attenuated by more than 20 dB below the permissible value has no need to be reported.

Emission level (dBuV/m) = 20 log Emission level (uV/m).

Corrected Reading: Antenna Factor + Cable Loss + Read Level - Preamp Factor = Level.

Temperature	26°C	Humidity	60%
Test Engineer	Serway Li	Configurations	IEEE 802.11b CH 1 / Ant. B
Test Date	Feb. 25, 2012		

Horizontal

	Freq	Level	Limit Line	Over Limit	Read Level	CableAntenna Loss	Antenna Factor	Preamp Factor	Remark	A/Pos	T/Pos	Pol/Phase
	MHz	dBuV/m	dBuV/m	dB	dBuV	dB	dB/m	dB		cm	deg	
1	4823.96	55.34	74.00	-18.66	54.00	3.31	33.06	35.03	Peak	142	199	HORIZONTAL
2	4823.97	53.05	54.00	-0.95	51.71	3.31	33.06	35.03	Average	142	199	HORIZONTAL

Vertical

	Freq	Level	Limit Line	Over Limit	Read Level	CableAntenna Loss	Antenna Factor	Preamp Factor	Remark	A/Pos	T/Pos	Pol/Phase
	MHz	dBuV/m	dBuV/m	dB	dBuV	dB	dB/m	dB		cm	deg	
1	4823.97	50.51	54.00	-3.49	49.17	3.31	33.06	35.03	Average	100	265	VERTICAL
2	4823.98	53.16	74.00	-20.84	51.82	3.31	33.06	35.03	Peak	100	265	VERTICAL



Temperature	26°C	Humidity	60%
Test Engineer	Serway Li	Configurations	IEEE 802.11b CH 6 / Ant. B
Test Date	Feb. 25, 2012		

Horizontal

	Freq	Level	Limit Line	Over Limit	Read Level	Cable Loss	Antenna Factor	Preamp Factor	Remark	A/Pos	T/Pos	Pol/Phase
	MHz	dBuV/m	dBuV/m	dB	dBuV	dB	dB/m	dB		cm	deg	
1	4873.94	55.36	74.00	-18.64	53.90	3.33	33.16	35.03	Peak	143	224	HORIZONTAL
2	4873.96	53.14	54.00	-0.86	51.68	3.33	33.16	35.03	Average	143	224	HORIZONTAL

Vertical

	Freq	Level	Limit Line	Limit	Level	Loss	Factor	Factor	Remark	A/Pos	T/Pos	Pol/Phase
	MHz	dBuV/m	dBuV/m	dB	dBuV	dB	dB/m	dB		cm	deg	
1	4873.90	54.76	74.00	-19.24	53.30	3.33	33.16	35.03	Peak	100	211	VERTICAL
2	4873.97	52.23	54.00	-1.77	50.77	3.33	33.16	35.03	Average	100	211	VERTICAL

Temperature	26°C	Humidity	60%
Test Engineer	Serway Li	Configurations	IEEE 802.11b CH 11 / Ant. B
Test Date	Feb. 24, 2012		

Horizontal

	Freq	Level	Limit	Over	Read	CableAntenna	Preamp		A/Pos	T/Pos	Pol/Phase	
	MHz	dBuV/m	dBuV/m	dB	dBuV	dB	dB/m	dB	cm	deg		
1	4923.96	53.38	54.00	-0.62	51.78	3.35	33.26	35.01	Average	112	189	HORIZONTAL
2	4924.01	55.43	74.00	-18.57	53.83	3.35	33.26	35.01	Peak	112	189	HORIZONTAL

Vertical

	Freq	Level	Limit	Over	Read	CableAntenna	Preamp		A/Pos	T/Pos	Pol/Phase	
	MHz	dBuV/m	dBuV/m	dB	dBuV	dB	dB/m	dB	cm	deg		
1	4923.97	52.53	54.00	-1.47	50.93	3.35	33.26	35.01	Average	158	192	VERTICAL
2	4924.03	56.06	74.00	-17.94	54.46	3.35	33.26	35.01	Peak	158	192	VERTICAL

Temperature	26°C	Humidity	60%
Test Engineer	Serway Li	Configurations	IEEE 802.11g CH 1 / Ant. B
Test Date	Feb. 24, 2012		

Horizontal

	Freq	Level	Limit	Over	Read	CableAntenna	Preamp	Remark	A/Pos	T/Pos	Pol/Phase	
	MHz	dBuV/m	dBuV/m	dB	dBuV	dB	dB/m	dB	cm	deg		
1	4824.04	36.80	54.00	-17.20	35.46	3.31	33.06	35.03	Average	183	194	HORIZONTAL
2	4825.84	49.20	74.00	-24.80	47.86	3.31	33.06	35.03	Peak	183	194	HORIZONTAL

Vertical

	Freq	Level	Limit	Over	Read	CableAntenna	Preamp	Remark	A/Pos	T/Pos	Pol/Phase	
	MHz	dBuV/m	dBuV/m	dB	dBuV	dB	dB/m	dB	cm	deg		
1	4824.10	39.96	54.00	-14.04	38.62	3.31	33.06	35.03	Average	153	54	VERTICAL
2	4824.49	52.88	74.00	-21.12	51.54	3.31	33.06	35.03	Peak	153	54	VERTICAL

Temperature	26°C	Humidity	60%
Test Engineer	Serway Li	Configurations	IEEE 802.11g CH 6 / Ant. B
Test Date	Feb. 27, 2012		

Horizontal

	Freq	Level	Limit	Over	Read	Cable	Antenna	Preamp	Remark	A/Pos	T/Pos	Pol/Phase
	MHz	dBuV/m	dBuV/m	dB	dBuV	dB	dB/m	dB		cm	deg	
1	4875.80	54.96	74.00	-19.04	53.50	3.33	33.16	35.03	Peak	131	80	HORIZONTAL
2	4876.20	41.74	54.00	-12.26	40.28	3.33	33.16	35.03	Average	131	80	HORIZONTAL
3	7310.40	45.73	54.00	-8.27	41.11	4.06	35.96	35.40	Average	103	179	HORIZONTAL
4	7312.80	59.90	74.00	-14.10	55.28	4.06	35.96	35.40	Peak	103	179	HORIZONTAL

Vertical

	Freq	Level	Limit	Over	Read	Cable	Antenna	Preamp	Remark	A/Pos	T/Pos	Pol/Phase
	MHz	dBuV/m	dBuV/m	dB	dBuV	dB	dB/m	dB		cm	deg	
1	4875.80	60.57	74.00	-13.43	59.11	3.33	33.16	35.03	Peak	106	0	VERTICAL
2	4876.20	46.24	54.00	-7.76	44.78	3.33	33.16	35.03	Average	106	0	VERTICAL
3	7308.70	53.12	54.00	-0.88	48.50	4.06	35.96	35.40	Average	100	191	VERTICAL
4	7311.65	67.08	74.00	-6.92	62.46	4.06	35.96	35.40	Peak	100	191	VERTICAL

Temperature	26°C	Humidity	60%
Test Engineer	Serway Li	Configurations	IEEE 802.11g CH 11 / Ant. B
Test Date	Feb. 27, 2012		

Horizontal

	Freq	Level	Limit	Over	Read	Cable	Antenna	Preamp	Remark	A/Pos	T/Pos	Pol/Phase
	MHz	dBuV/m	dBuV/m	dB	dBuV	dB	dB/m	dB		cm	deg	
1	4924.00	42.82	54.00	-11.18	41.22	3.35	33.26	35.01	Average	101	192	HORIZONTAL
2	4926.40	55.08	74.00	-18.92	53.48	3.35	33.26	35.01	Peak	101	192	HORIZONTAL

Vertical

	Freq	Level	Limit	Over	Read	Cable	Antenna	Preamp	Remark	A/Pos	T/Pos	Pol/Phase
	MHz	dBuV/m	dBuV/m	dB	dBuV	dB	dB/m	dB		cm	deg	
1	4925.84	45.94	54.00	-8.06	44.34	3.35	33.26	35.01	Average	102	157	VERTICAL
2	4926.52	58.62	74.00	-15.38	57.02	3.35	33.26	35.01	Peak	102	157	VERTICAL

Note:

The amplitude of spurious emissions that are attenuated by more than 20dB below the permissible value has no need to be reported.

Emission level (dBuV/m) = 20 log Emission level (uV/m).

Corrected Reading: Antenna Factor + Cable Loss + Read Level - Preamp Factor = Level.

4.7. Band Edge Emissions Measurement

4.7.1. Limit

20dBc in any 100 kHz bandwidth outside the operating frequency band. In case the emission fall within the restricted band specified on 15.205(a), then the 15.209(a) limit in the table below has to be followed.

Frequencies (MHz)	Field Strength (micorvolts/meter)	Measurement Distance (meters)
0.009~0.490	2400/F(KHz)	300
0.490~1.705	24000/F(KHz)	30
1.705~30.0	30	30
30~88	100	3
88~216	150	3
216~960	200	3
Above 960	500	3

4.7.2. Measuring Instruments and Setting

Please refer to section 5 of equipments list in this report. The following table is the setting of the spectrum analyzer.

Spectrum Parameter	Setting
Attenuation	Auto
Span Frequency	100 MHz
RB / VB (Emission in restricted band)	1 MHz / 3MHz for Peak, 1 MHz / 10Hz for Average
RB / VB (Emission in non-restricted band)	100 KHz / 100 KHz for Peak

4.7.3. Test Procedures

1. The test procedure is the same as section 4.5.3, only the frequency range investigated is limited to 100MHz around bandedges.
2. In case the emission is fail due to the used RB/VB is too wide, marker-delta method of FCC Public Notice DA00-705 will be followed.

4.7.4. Test Setup Layout

This test setup layout is the same as that shown in section 4.5.4.

4.7.5. Test Deviation

There is no deviation with the original standard.

4.7.6. EUT Operation during Test

The EUT was programmed to be in continuously transmitting mode.

4.7.7. Test Result of Band Edge and Fundamental Emissions

Temperature	26°C	Humidity	60%
Test Engineer	Serway Li	Configurations	IEEE 802.11n MCS0 20MHz Ch 1, 6, 11 / Ant. B
Test Date	Feb. 27, 2012		

Channel 1

	Freq	Level	Limit	Over	Read	Cable	Antenna	Preamp	Remark	A/Pos	T/Pos	Pol/Phase
	MHz	dBuV/m	dBuV/m	dB	dBuV	dB	dB/m	dB		cm	deg	
1	2389.60	66.55	74.00	-7.45	36.17	2.21	28.17	0.00	Peak	100	173	VERTICAL
2	2390.00	53.07	54.00	-0.93	22.68	2.22	28.17	0.00	Average	100	173	VERTICAL
3	2406.40	93.41	54.00			2.22	28.21	0.00	Average	100	173	VERTICAL
4	2406.60	102.66	74.00			2.22	28.21	0.00	Peak	100	173	VERTICAL

Item 3, 4 are the fundamental frequency at 2412 MHz.

Channel 6

	Freq	Level	Limit	Over	Read	Cable	Antenna	Preamp	Remark	A/Pos	T/Pos	Pol/Phase
	MHz	dBuV/m	dBuV/m	dB	dBuV	dB	dB/m	dB		cm	deg	
1	2389.60	53.98	74.00	-20.02	23.60	2.21	28.17	0.00	Peak	100	200	HORIZONTAL
2	2390.00	43.06	54.00	-10.94	12.67	2.22	28.17	0.00	Average	100	200	HORIZONTAL
3	2429.00	92.51	54.00			2.23	28.25	0.00	Average	100	200	HORIZONTAL
4	2429.40	104.69	74.00			2.23	28.25	0.00	Peak	100	200	HORIZONTAL
5	2483.50	43.26	54.00	-10.74	12.62	2.26	28.38	0.00	Average	100	200	HORIZONTAL
6	2483.70	52.80	74.00	-21.20	22.16	2.26	28.38	0.00	Peak	100	200	HORIZONTAL

Item 3, 4 are the fundamental frequency at 2437MHz.

Channel 11

	Freq	Level	Limit	Over	Read	Cable	Antenna	Preamp	Remark	A/Pos	T/Pos	Pol/Phase
	MHz	dBuV/m	dBuV/m	dB	dBuV	dB	dB/m	dB		cm	deg	
1	2467.00	100.63	74.00			2.26	28.33	0.00	Peak	100	142	VERTICAL
2	2467.40	91.56	54.00			2.26	28.33	0.00	Average	100	142	VERTICAL
3	2483.50	53.82	54.00	-0.18	23.19	2.26	28.37	0.00	Average	100	142	VERTICAL
4	2483.50	69.38	74.00	-4.62	38.75	2.26	28.37	0.00	Peak	100	142	VERTICAL

Item 1, 2 are the fundamental frequency at 2462 MHz.



Temperature	26°C	Humidity	60%
Test Engineer	Serway Li	Configurations	IEEE 802.11n MCS0 40MHz Ch 3, 6, 9 / Ant. B
Test Date	Feb. 27, 2012		

Channel 3

	Freq	Level	Limit Line	Over Limit	Read Level	Cable Loss	Antenna Factor	Preamp Factor	Remark	A/Pos	T/Pos	Pol/Phase
	MHz	dBuV/m	dBuV/m	dB	dBuV	dB	dB/m	dB		cm	deg	
1	2388.00	67.10	74.00	-6.90	36.72	2.21	28.17	0.00	Peak	100	164	VERTICAL
2	2390.00	53.03	54.00	-0.97	22.64	2.22	28.17	0.00	Average	100	164	VERTICAL
3	2406.40	88.75	54.00			2.22	28.21	0.00	Average	100	164	VERTICAL
4	2408.00	97.84	74.00			2.22	28.21	0.00	Peak	100	164	VERTICAL

Item 3, 4 are the fundamental frequency at 2422 MHz.

Channel 6

	Freq	Level	Limit Line	Over Limit	Read Level	Cable Loss	Antenna Factor	Preamp Factor	Remark	A/Pos	T/Pos	Pol/Phase
	MHz	dBuV/m	dBuV/m	dB	dBuV	dB	dB/m	dB		cm	deg	
1	2390.00	53.57	54.00	-0.43	23.18	2.22	28.17	0.00	Average	100	166	VERTICAL
2	2390.00	65.11	74.00	-8.89	34.72	2.22	28.17	0.00	Peak	100	166	VERTICAL
3	2420.20	101.66	74.00			2.23	28.25	0.00	Peak	100	166	VERTICAL
4	2420.60	92.79	54.00			2.23	28.25	0.00	Average	100	166	VERTICAL
5	2483.50	51.15	54.00	-2.85	20.52	2.26	28.37	0.00	Average	100	166	VERTICAL
6	2483.50	63.63	74.00	-10.37	33.00	2.26	28.37	0.00	Peak	100	166	VERTICAL

Item 3, 4 are the fundamental frequency at 2437MHz.

Channel 9

	Freq	Level	Limit Line	Over Limit	Read Level	Cable Loss	Antenna Factor	Preamp Factor	Remark	A/Pos	T/Pos	Pol/Phase
	MHz	dBuV/m	dBuV/m	dB	dBuV	dB	dB/m	dB		cm	deg	
1	2465.20	86.04	54.00			2.24	28.33	0.00	Average	101	146	VERTICAL
2	2466.00	97.81	74.00			2.24	28.33	0.00	Peak	101	146	VERTICAL
3	2483.50	52.88	54.00	-1.12	22.25	2.26	28.37	0.00	Average	101	146	VERTICAL
4	2483.50	66.70	74.00	-7.30	36.07	2.26	28.37	0.00	Peak	101	146	VERTICAL

Item 1, 2 are the fundamental frequency at 2452 MHz.

Note:

Emission level (dBuV/m) = 20 log Emission level (uV/m).

Corrected Reading: Antenna Factor + Cable Loss + Read Level - Preamp Factor = Level.

Temperature	26°C	Humidity	60%
Test Engineer	Serway Li	Configurations	IEEE 802.11b CH 1, 6, 11 / Ant. B
Test Date	Feb. 25, 2012		

Channel 1

	Freq	Level	Limit Line	Over Limit	Read Level	CableAntenna Loss	Antenna Factor	Preamp Factor	Remark	A/Pos	T/Pos	Pol/Phase
	MHz	dBuV/m	dBuV/m	dB	dBuV	dB	dB/m	dB		cm	deg	
1	2390.00	42.50	54.00	-11.50	12.11	2.22	28.17	0.00	Average	100	31	VERTICAL
2	2390.00	53.40	74.00	-20.60	23.01	2.22	28.17	0.00	Peak	100	31	VERTICAL
3	2413.00	92.98				2.22	28.21	0.00	Peak	100	31	VERTICAL
4	2413.80	89.38				2.22	28.21	0.00	Average	100	31	VERTICAL

Item 3, 4 are the fundamental frequency at 2412 MHz.

Channel 6

	Freq	Level	Limit Line	Over Limit	Read Level	CableAntenna Loss	Antenna Factor	Preamp Factor	Remark	A/Pos	T/Pos	Pol/Phase
	MHz	dBuV/m	dBuV/m	dB	dBuV	dB	dB/m	dB		cm	deg	
1	2390.00	42.52	54.00	-11.48	12.13	2.22	28.17	0.00	Average	100	237	HORIZONTAL
2	2390.00	53.15	74.00	-20.85	22.76	2.22	28.17	0.00	Peak	100	237	HORIZONTAL
3	2438.00	99.67				2.23	28.29	0.00	Peak	100	237	HORIZONTAL
4	2438.80	95.82				2.23	28.29	0.00	Average	100	237	HORIZONTAL
5	2483.50	42.82	54.00	-11.18	12.18	2.26	28.38	0.00	Average	100	237	HORIZONTAL
6	2485.50	54.88	74.00	-19.12	24.20	2.26	28.42	0.00	Peak	100	237	HORIZONTAL

Item 3, 4 are the fundamental frequency at 2437MHz.

Channel 11

	Freq	Level	Limit Line	Over Limit	Read Level	CableAntenna Loss	Antenna Factor	Preamp Factor	Remark	A/Pos	T/Pos	Pol/Phase
	MHz	dBuV/m	dBuV/m	dB	dBuV	dB	dB/m	dB		cm	deg	
1	2460.20	97.61				2.24	28.33	0.00	Average	187	252	HORIZONTAL
2	2461.20	101.44				2.24	28.33	0.00	Peak	187	252	HORIZONTAL
3	2483.50	42.92	54.00	-11.08	12.28	2.26	28.38	0.00	Average	187	252	HORIZONTAL
4	2485.50	54.59	74.00	-19.41	23.91	2.26	28.42	0.00	Peak	187	252	HORIZONTAL

Item 1, 2 are the fundamental frequency at 2462 MHz.

Temperature	26°C	Humidity	60%
Test Engineer	Serway Li	Configurations	IEEE 802.11g CH 1, 6, 11 / Ant. B
Test Date	Feb. 27, 2012		

Channel 1

	Freq	Level	Limit Line	Over Limit	Read Level	Cable Loss	Antenna Factor	Preamp Factor	Remark	A/Pos	T/Pos	Pol/Phase
	MHz	dBuV/m	dBuV/m	dB	dBuV	dB	dB/m	dB		cm	deg	
1	2390.00	52.49	54.00	-1.51	22.10	2.22	28.17	0.00	Average	100	145	VERTICAL
2	2390.00	67.60	74.00	-6.40	37.21	2.22	28.17	0.00	Peak	100	145	VERTICAL
3	2418.60	93.51				2.23	28.25	0.00	Average	100	145	VERTICAL
4	2419.00	102.88				2.23	28.25	0.00	Peak	100	145	VERTICAL

Item 3, 4 are the fundamental frequency at 2412 MHz.

Channel 6

	Freq	Level	Limit Line	Over Limit	Read Level	Cable Loss	Antenna Factor	Preamp Factor	Remark	A/Pos	T/Pos	Pol/Phase
	MHz	dBuV/m	dBuV/m	dB	dBuV	dB	dB/m	dB		cm	deg	
1	2389.80	54.10	74.00	-19.90	23.71	2.22	28.17	0.00	Peak	100	195	HORIZONTAL
2	2390.00	43.16	54.00	-10.84	12.77	2.22	28.17	0.00	Average	100	195	HORIZONTAL
3	2430.00	104.22				2.23	28.25	0.00	Peak	100	195	HORIZONTAL
4	2443.60	92.07				2.24	28.29	0.00	Average	100	195	HORIZONTAL
5	2483.50	43.43	54.00	-10.57	12.79	2.26	28.38	0.00	Average	100	195	HORIZONTAL
6	2483.50	53.82	74.00	-20.18	23.18	2.26	28.38	0.00	Peak	100	195	HORIZONTAL

Item 3, 4 are the fundamental frequency at 2437 MHz.

Channel 11

	Freq	Level	Limit Line	Over Limit	Read Level	Cable Loss	Antenna Factor	Preamp Factor	Remark	A/Pos	T/Pos	Pol/Phase
	MHz	dBuV/m	dBuV/m	dB	dBuV	dB	dB/m	dB		cm	deg	
1	2466.00	92.63				2.24	28.33	0.00	Average	100	148	VERTICAL
2	2467.60	102.00				2.26	28.33	0.00	Peak	100	148	VERTICAL
3	2483.50	53.51	54.00	-0.49	22.88	2.26	28.37	0.00	Average	100	148	VERTICAL
4	2483.70	69.19	74.00	-4.81	38.56	2.26	28.37	0.00	Peak	100	148	VERTICAL

Item 1, 2 are the fundamental frequency at 2462 MHz.

Note:

Emission level (dBuV/m) = 20 log Emission level (uV/m).

Corrected Reading: Antenna Factor + Cable Loss + Read Level - Preamp Factor = Level.

For Emission not in Restricted Band

Plot on Configuration IEEE 802.11n MCS0 20MHz / Reference Level

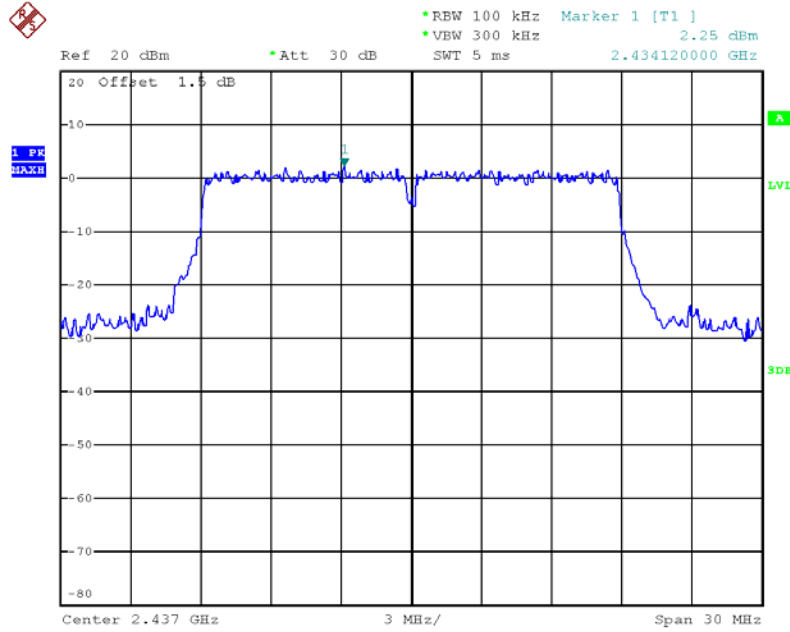

Date: 25.OCT.2012 12:55:05

Plot on Configuration IEEE 802.11n MCS0 20MHz / CH 1 / 2412MHz (down 30dBc)

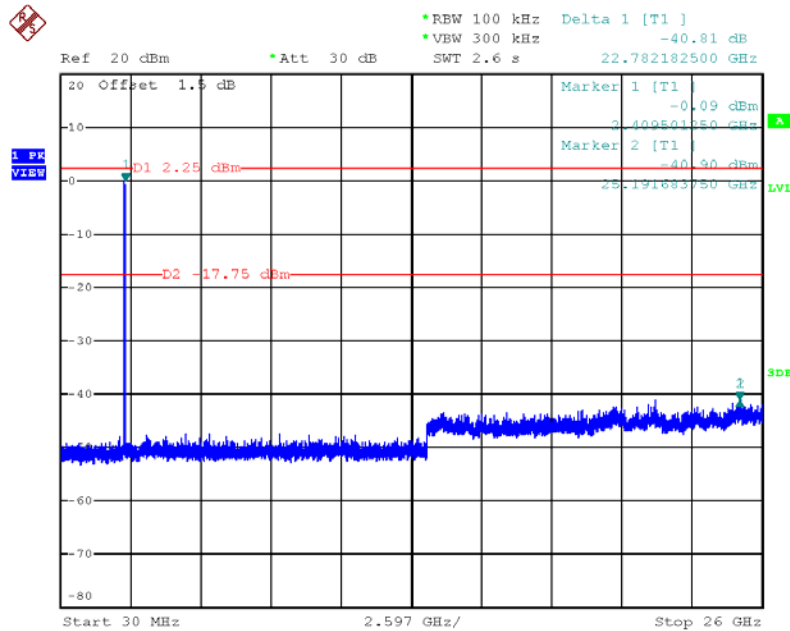

Date: 25.OCT.2012 13:59:52

Plot on Configuration IEEE 802.11n MCS0 20MHz / CH 6 / 2437MHz (down 30dBc)

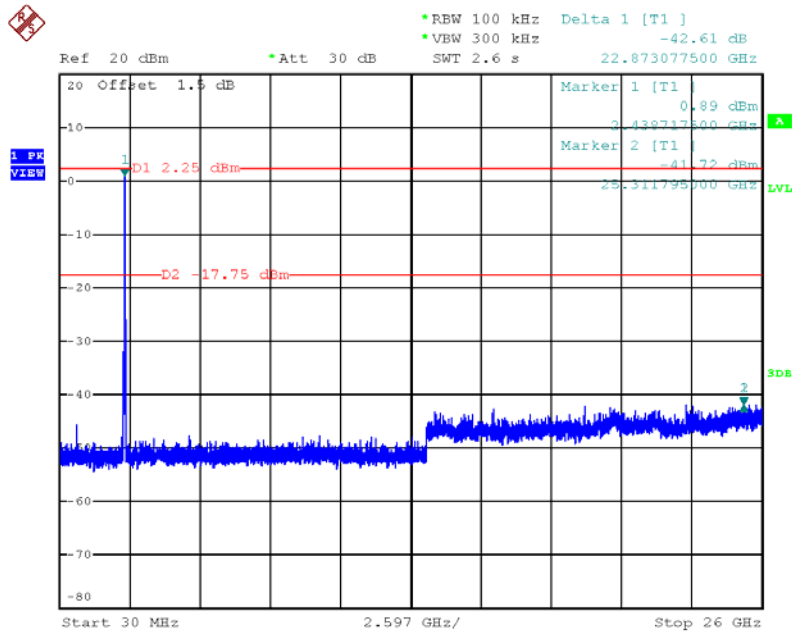

Date: 25.OCT.2012 14:02:15

Plot on Configuration IEEE 802.11n MCS0 20MHz / CH 11 / 2462MHz (down 30dBc)

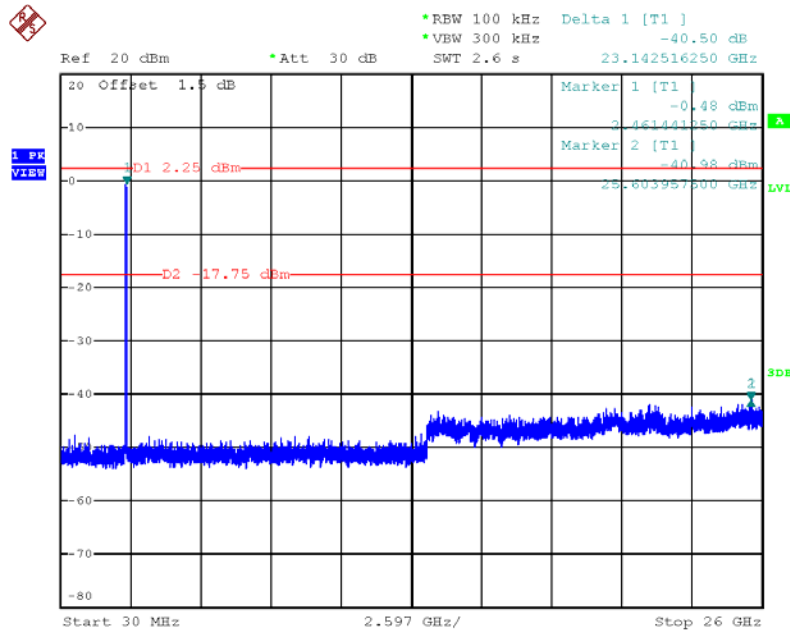

Date: 25.OCT.2012 14:03:36

Plot on Configuration IEEE 802.11n MCS0 40MHz / Reference Level

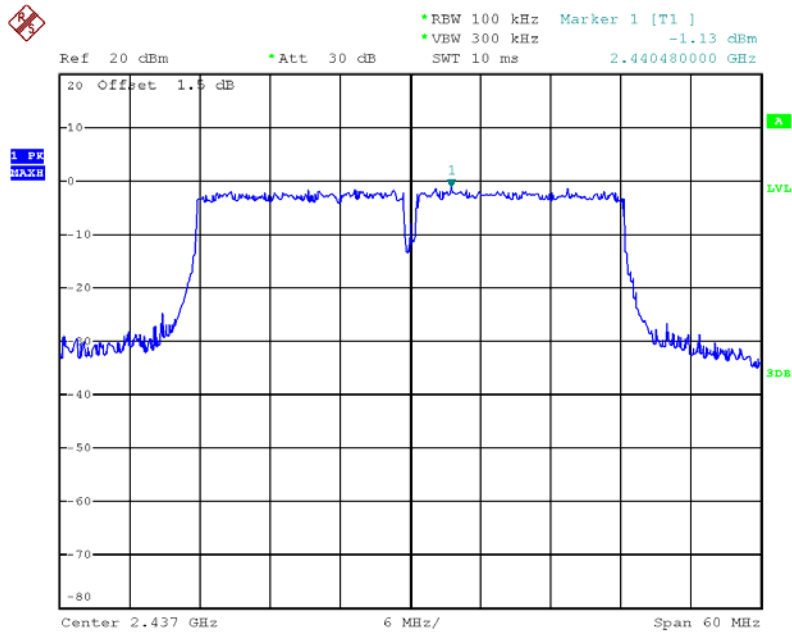

Date: 25.OCT.2012 13:04:27

Plot on Configuration IEEE 802.11n MCS0 40MHz / CH 3 / 2422MHz (down 30dBc)

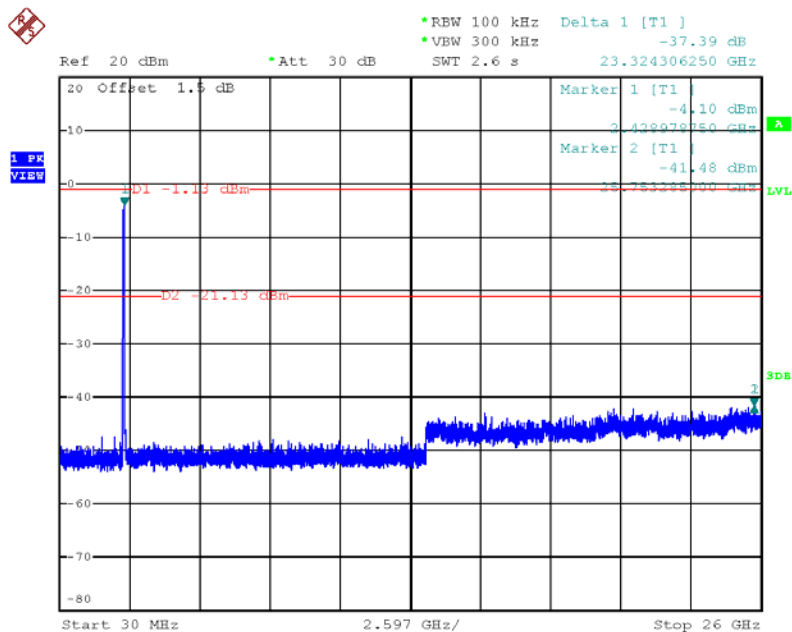

Date: 25.OCT.2012 14:05:41

Plot on Configuration IEEE 802.11n MCS0 40MHz / CH 6 / 2437MHz (down 30dBc)

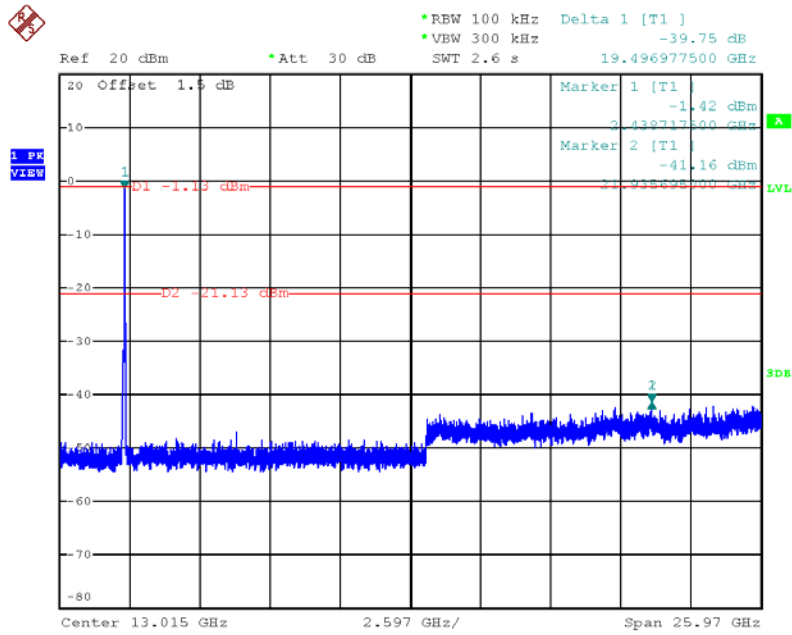

Date: 25.OCT.2012 14:07:12

Plot on Configuration IEEE 802.11n MCS0 40MHz / CH 9 / 2452MHz (down 30dBc)

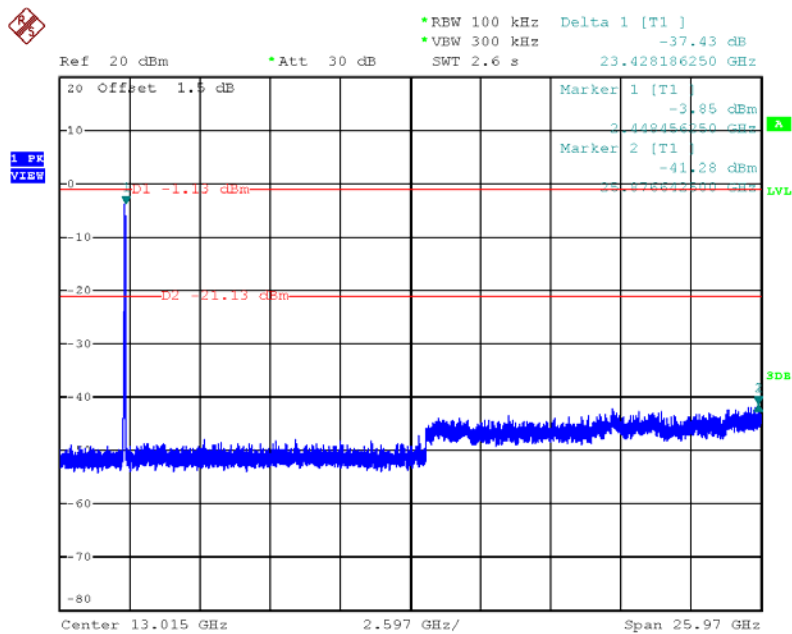

Date: 25.OCT.2012 14:09:30

Plot on Configuration IEEE 802.11b / Reference Level

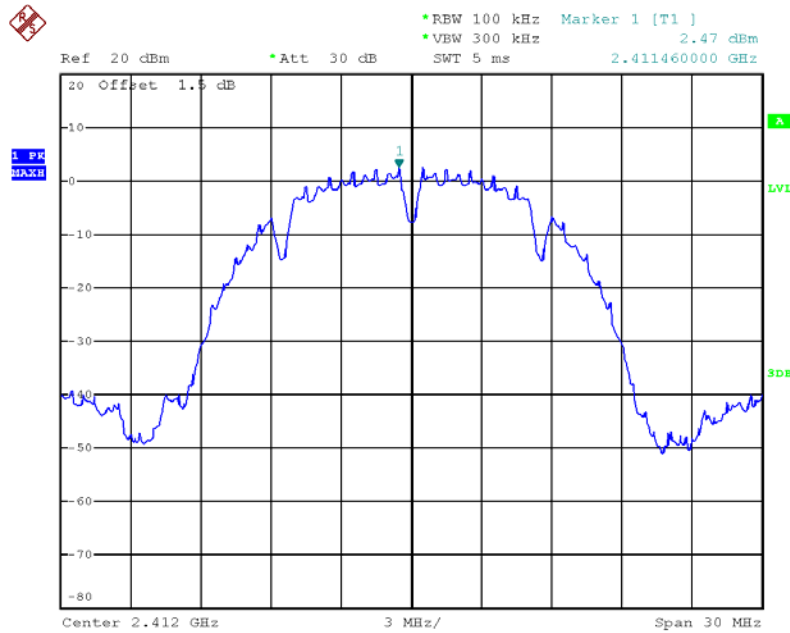

Date: 25.OCT.2012 12:35:45

Plot on Configuration IEEE 802.11b / CH 1/ 2412MHz (down 30dBc)

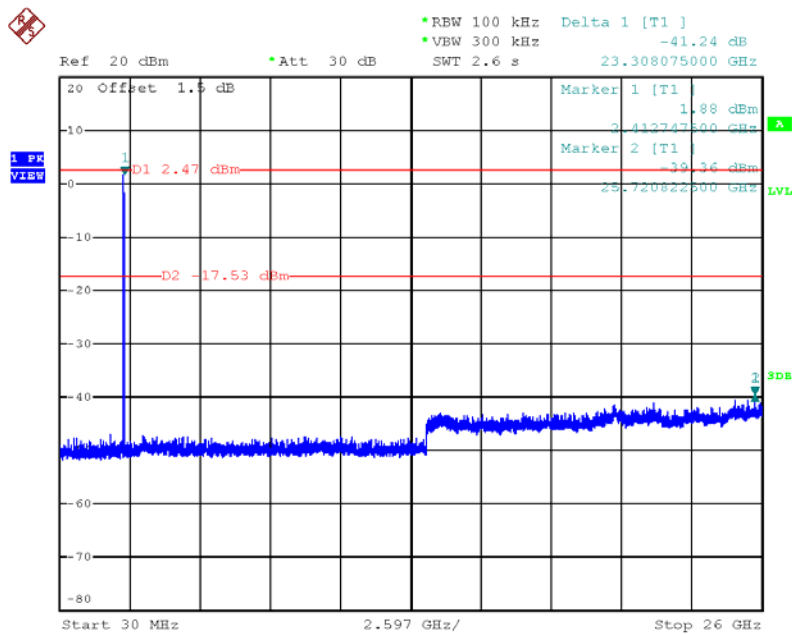

Date: 25.OCT.2012 13:42:30

Plot on Configuration IEEE 802.11b / CH 6 / 2437MHz (down 30dBc)

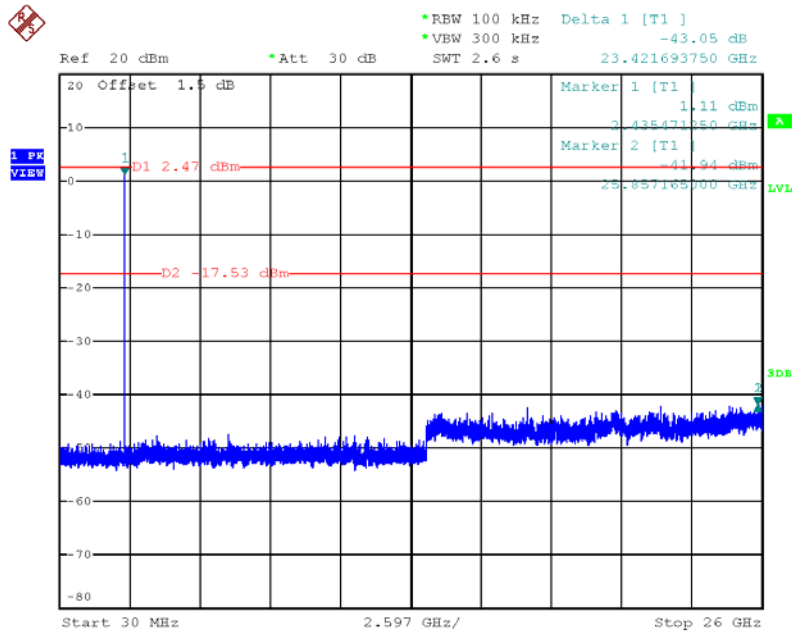

Date: 25.OCT.2012 13:53:35

Plot on Configuration IEEE 802.11b / CH 11 / 2462MHz (down 30dBc)

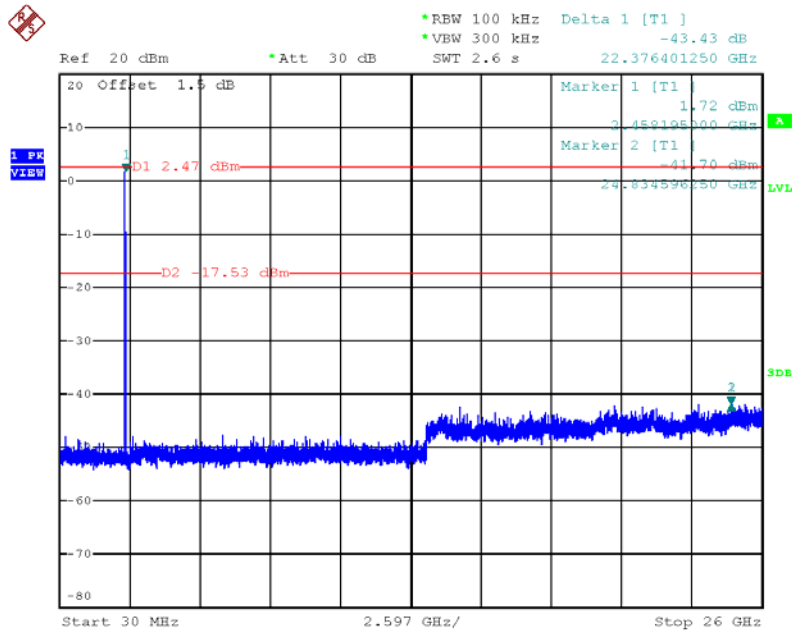

Date: 25.OCT.2012 13:55:39

Plot on Configuration IEEE 802.11g / Reference Level

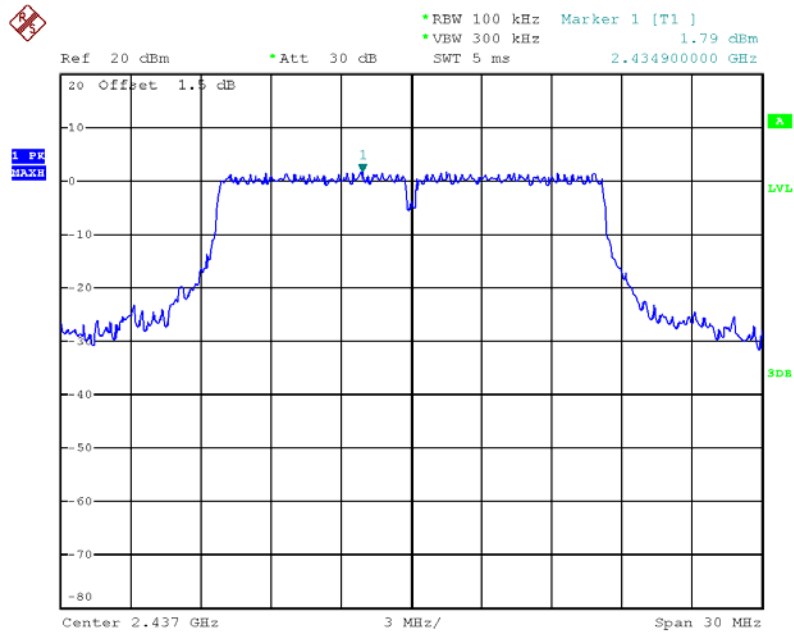

Date: 25.OCT.2012 12:45:47

Plot on Configuration IEEE 802.11g / CH 1 / 2412MHz (down 30dBc)

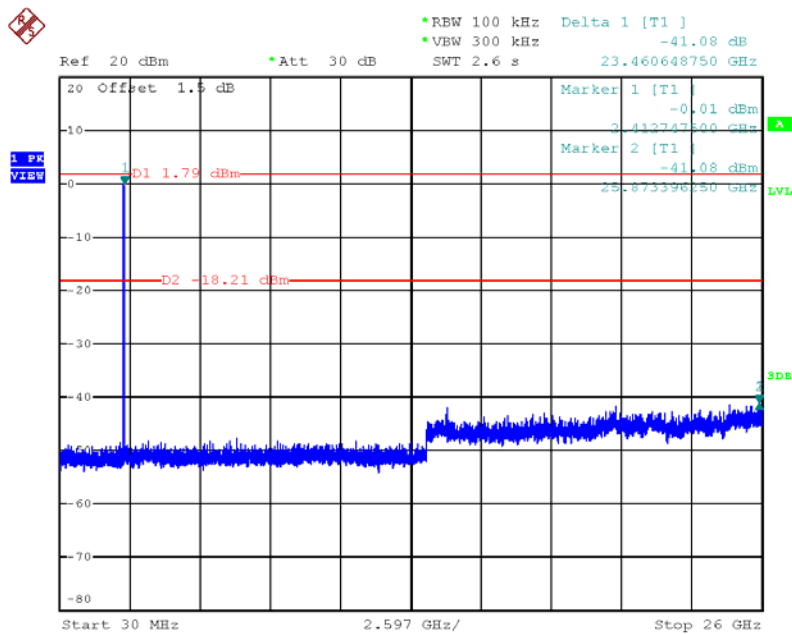

Date: 25.OCT.2012 13:49:18

Plot on Configuration IEEE 802.11g / CH 6 / 2437MHz (down 30dBc)

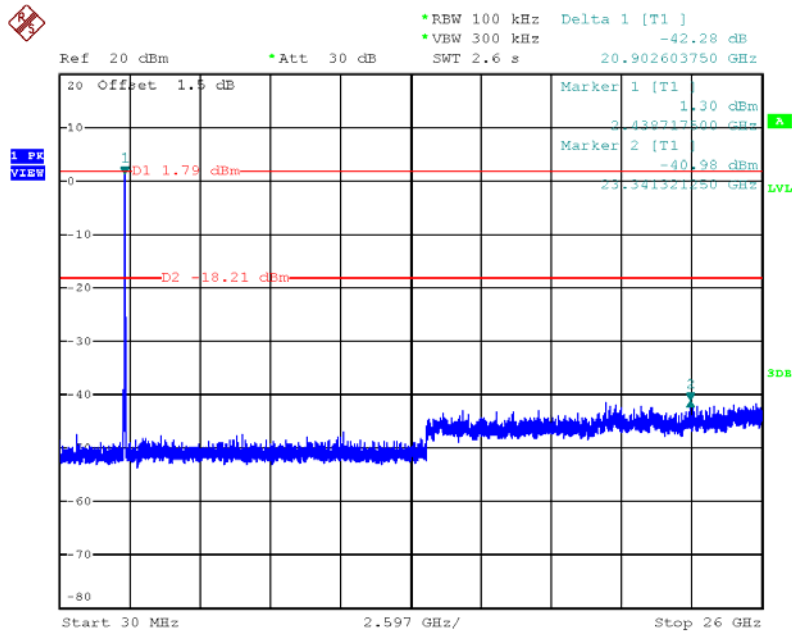

Date: 25.OCT.2012 13:46:10

Plot on Configuration IEEE 802.11g / CH 11 / 2462MHz (down 30dBc)

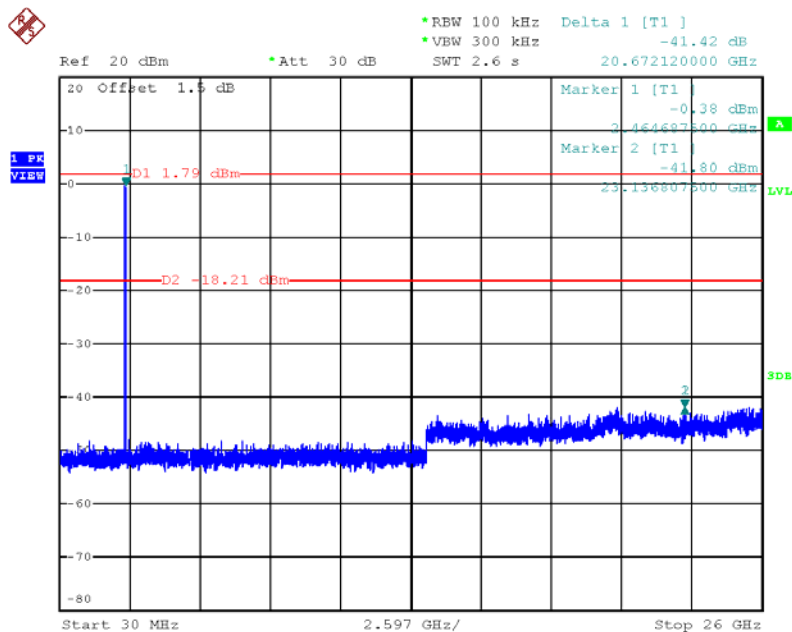

Date: 25.OCT.2012 13:50:55

4.8. Antenna Requirements

4.8.1. Limit

Except for special regulations, the Low-power Radio-frequency Devices must not be equipped with any jacket for installing an antenna with extension cable. An intentional radiator shall be designed to ensure that no antenna other than that furnished by the responsible party shall be used with the device. The use of a permanently attached antenna or of an antenna that uses a unique coupling to the intentional radiator shall be considered sufficient to comply with the provisions of this Section. The manufacturer may design the unit so that the user can replace a broken antenna, but the use of a standard antenna jack or electrical connector is prohibited. Further, this requirement does not apply to intentional radiators that must be professionally installed.

4.8.2. Antenna Connector Construction

Please refer to section 3.3 in this test report; antenna connector complied with the requirements.

5. LIST OF MEASURING EQUIPMENTS

Instrument	Manufacturer	Model No.	Serial No.	Characteristics	Calibration Date	Remark
EMI Test Receiver	R&S	ESCS 30	100377	9kHz ~ 2.75GHz	Sep. 14, 2011	Conduction (CO01-CB)
LISN	F.C.C.	FCC-LISN-50-16-2	04083	150kHz ~ 100MHz	Nov. 14, 2011	Conduction (CO01-CB)
V- LISN	Schwarzbeck	NSLK 8127	8127-478	9K ~ 30MHz	Nov. 30, 2011	Conduction (CO01-CB)
PULSE LIMITER	R&S	ESH3-Z2	100430	9K~30MHz	Jan. 04, 2012	Conduction (CO01-CB)
COND Cable	-	Cable	-	0.15MHz~30MHz	Dec. 04, 2011	Conduction (CO01-CB)
Signal analyzer	R&S	FSV40	100979	9KHz~40GHz	Oct. 08, 2012	Conducted (TH01-CB)
Thermo-Hygro Meter	N/A	HC 520	#1	15~70 degree	Nov. 02, 2011	Conducted (TH01-CB)
RF Power Divider	HP	11636A	00306	2GHz ~ 18GHz	N/A	Conducted (TH01-CB)
RF Power Splitter	Anaren	44100	1839	2GHz ~ 18GHz	N/A	Conducted (TH01-CB)
RF Power Splitter	Anaren	42100	17930	2GHz ~ 18GHz	N/A	Conducted (TH01-CB)
RF Cable-high	Woken	High Cable-7	-	1 GHz – 26.5 GHz	Nov. 17, 2011	Conducted (TH01-CB)
RF Cable-high	Woken	High Cable-8	-	1 GHz – 26.5 GHz	Nov. 17, 2011	Conducted (TH01-CB)
RF Cable-high	Woken	High Cable-9	-	1 GHz – 26.5 GHz	Nov. 17, 2011	Conducted (TH01-CB)
RF Cable-high	Woken	High Cable-10	-	1 GHz – 26.5 GHz	Nov. 17, 2011	Conducted (TH01-CB)
RF Cable-high	Woken	High Cable-11	-	1 GHz – 26.5 GHz	Nov. 17, 2011	Conducted (TH01-CB)
RF Cable-high	Woken	High Cable-12	-	1 GHz – 26.5 GHz	Nov. 17, 2011	Conducted (TH01-CB)
RF Cable-high	Woken	High Cable-13	-	1 GHz – 26.5 GHz	Nov. 17, 2011	Conducted (TH01-CB)
Power Sensor	Anritsu	MA2411B	0917223	300MHz~40GHz	Nov. 01, 2011	Conducted (TH01-CB)
Power Meter	Anritsu	ML2495A	1035008	300MHz~40GHz	Nov. 01, 2011	Conducted (TH01-CB)
BILOG ANTENNA	Schaffner	CBL6112D	22021	20MHz ~ 2GHz	Jan. 11, 2012	Radiation (03CH01-CB)
Horn Antenna	EMCO	3115	00075790	750MHz~18GHz	Nov. 25, 2011	Radiation (03CH01-CB)
Pre-Amplifier	Agilent	8447D	2944A10991	0.1MHz ~ 1.3GHz	Nov. 17, 2011	Radiation (03CH01-CB)
Pre-Amplifier	Agilent	8449B	3008A02310	1GHz ~ 26.5GHz	Nov. 29, 2011	Radiation (03CH01-CB)
Spectrum analyzer	R&S	FSP40	100056	9KHz~40GHz	Nov. 03, 2011	Radiation (03CH01-CB)
EMI Test Receiver	R&S	ESCS 30	100355	9KHz ~ 2.75GHz	Mar. 22, 2011	Radiation (03CH01-CB)
Loop Antenna	Teseq	HLA 6120	24155	9 kHz - 30 MHz	Sep. 09, 2010*	Radiation (03CH01-CB)

Instrument	Manufacturer	Model No.	Serial No.	Characteristics	Calibration Date	Remark
Turn Table	INN CO	CO 2000	N/A	0 ~ 360 degree	N/A	Radiation (03CH01-CB)
Antenna Mast	INN CO	CO2000	N/A	1 m - 4 m	N/A	Radiation (03CH01-CB)
RF Cable-low	Woken	Low Cable-1	N/A	30 MHz - 1 GHz	Nov. 17, 2011	Radiation (03CH01-CB)
RF Cable-high	Woken	High Cable-1	N/A	1 GHz – 26.5 GHz	Nov. 17, 2011	Radiation (03CH01-CB)
RF Cable-high	Woken	High Cable-2	N/A	1 GHz – 26.5 GHz	Nov. 17, 2011	Radiation (03CH01-CB)
RF Cable-high	Woken	High Cable-3	N/A	1 GHz - 40 GHz	Nov. 17, 2011	Radiation (03CH01-CB)
RF Cable-high	Woken	High Cable-4	N/A	1 GHz - 40 GHz	Nov. 17, 2011	Radiation (03CH01-CB)

Note: Calibration Interval of instruments listed above is one year.

Note: "*" Calibration Interval of instruments listed above is two years.

6. TEST LOCATION

SHIJR	ADD : 6Fl., No. 106, Sec. 1, Shintai 5th Rd., Shijr City, Taipei, Taiwan 221, R.O.C. TEL : 886-2-2696-2468 FAX : 886-2-2696-2255
HWA YA	ADD : No. 52, Hwa Ya 1st Rd., Kwei-Shan Hsiang, Tao Yuan Hsien, Taiwan, R.O.C. TEL : 886-3-327-3456 FAX : 886-3-318-0055
LINKOU	ADD : No. 30-2, Dingfu Tsuen, Linkou Shiang, Taipei, Taiwan 244, R.O.C TEL : 886-2-2601-1640 FAX : 886-2-2601-1695
DUNGHU	ADD : No. 3, Lane 238, Kangle St., Neihu Chiu, Taipei, Taiwan 114, R.O.C. TEL : 886-2-2631-4739 FAX : 886-2-2631-9740
JUNGHE	ADD : 7Fl., No. 758, Jungjeng Rd., Junghe City, Taipei, Taiwan 235, R.O.C. TEL : 886-2-8227-2020 FAX : 886-2-8227-2626
NEIHU	ADD : 4Fl., No. 339, Hsin Hu 2 nd Rd., Taipei 114, Taiwan, R.O.C. TEL : 886-2-2794-8886 FAX : 886-2-2794-9777
JHUBEI	ADD : No.8, Lane 724, Bo-ai St., Jhubei City, HsinChu County 302, Taiwan, R.O.C. TEL : 886-3-656-9065 FAX : 886-3-656-9085

7. TAF CERTIFICATE OF ACCREDITATION



Certificate No. : L1190-110702

財團法人全國認證基金會
Taiwan Accreditation Foundation

Certificate of Accreditation

This is to certify that

Sporton International Inc.
EMC & Wireless Communications Laboratory
No.52, Hwa Ya 1st Road, Hwa Ya Technology Park, Kwei-Shan Hsiang, Tao Yuan Hsien,
Taiwan, R.O.C.

is accredited in respect of laboratory

Accreditation Criteria	: ISO/IEC 17025:2005
Accreditation Number	: 1190
Originally Accredited	: December 15, 2003
Effective Period	: January 10, 2010 to January 09, 2013
Accredited Scope	: Testing Field, see described in the Appendix
Specific Accreditation Program	: Accreditation Program for Designated Testing Laboratory for Commodities Inspection Accreditation Program for Telecommunication Equipment Testing Laboratory Accreditation Program for BSMI Mutual Recognition Arrangement with Foreign Authorities

Jay-San Chen
President, Taiwan Accreditation Foundation
Date : July 02, 2011

P1, total 22 pages

The Appendix forms an integral part of this Certificate, which shall be invalid when use without the Appendix