



SPORTON International Inc.

No. 52, Hwa Ya 1st Rd., Kwei-Shan Hsiang, TaoYuan Hsien, Taiwan, R.O.C.
Ph: 886-3-327-3456 / FAX: 886-3-327-0973 / www.sporton.com.tw

FCC RADIO TEST REPORT

Applicant's company	NETGEAR, Inc.
Applicant Address	350 East Plumeria Drive, San Jose, California 95134-1911
FCC ID	PY312200200
Manufacturer's company	Ambit Microsystems (Shanghai) Ltd.
Manufacturer Address	No. 1925, Nanle Road, Songjiang Export Processing Zone, Shanghai, China

Product Name	WiFi USB Adapter
Brand Name	NETGEAR
Model Name	A6200
Test Rule Part(s)	47 CFR FCC Part 15 Subpart C § 15.247
Test Freq. Range	2400 ~ 2483.5MHz / 5725 ~ 5850MHz
Received Date	Jun. 22, 2012
Final Test Date	Jul. 31, 2012
Submission Type	Original Equipment

Statement

Test result included is only for the IEEE 802.11n, IEEE 802.11b/g part and IEEE 802.11a (5725 ~ 5850MHz) of the product.

The test result in this report refers exclusively to the presented test model / sample.

Without written approval of SPORTON International Inc., the test report shall not be reproduced except in full.

The measurements and test results shown in this test report were made in accordance with the procedures and found in compliance with the limit given in ANSI C63.10-2009 and 47 CFR FCC Part 15 Subpart C and KDB 558074 – 20120118 & KDB662911 D01-20110404.

The test equipment used to perform the test is calibrated and traceable to NML/ROC.



Table of Contents

1. CERTIFICATE OF COMPLIANCE	1
2. SUMMARY OF THE TEST RESULT	2
3. GENERAL INFORMATION	3
3.1. Product Details.....	3
3.2. Accessories.....	6
3.3. Table for Filed Antenna.....	7
3.4. Table for Carrier Frequencies	8
3.5. Table for Test Modes	9
3.6. Table for Testing Locations.....	11
3.7. Table for Supporting Units	11
3.8. Table for Parameters of Test Software Setting	12
3.9. Test Configurations	14
4. TEST RESULT	17
4.1. AC Power Line Conducted Emissions Measurement.....	17
4.2. Conducted Output Power Measurement	21
4.3. Power Spectral Density Measurement	35
4.4. 6dB Spectrum Bandwidth Measurement	48
4.5. Radiated Emissions Measurement	56
4.6. Band Edge Emissions Measurement	88
4.7. Antenna Requirements	103
5. LIST OF MEASURING EQUIPMENTS	104
6. TEST LOCATION.....	106
7. TAF CERTIFICATE OF ACCREDITATION	107
APPENDIX A. TEST PHOTOS	A1 ~ A6
APPENDIX B. MAXIMUM PERMISSIBLE EXPOSURE	B1 ~ B3



History of This Test Report

REPORT NO.	VERSION	DESCRIPTION	ISSUED DATE
FR262930AB	Rev. 01	Initial issue of report	Aug. 01, 2012



1. CERTIFICATE OF COMPLIANCE

Product Name : WiFi USB Adapter
Brand Name : NETGEAR
Model Name : A6200
Applicant : NETGEAR, Inc.
Test Rule Part(s) : 47 CFR FCC Part 15 Subpart C § 15.247

Sporton International as requested by the applicant to evaluate the EMC performance of the product sample received on Jun. 22, 2012 would like to declare that the tested sample has been evaluated and found to be in compliance with the tested rule parts. The data recorded as well as the test configuration specified is true and accurate for showing the sample's EMC nature.

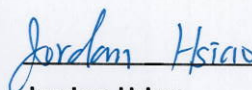

Jordan Hsiao

SPORTON INTERNATIONAL INC.

2. SUMMARY OF THE TEST RESULT

Applied Standard: 47 CFR FCC Part 15 Subpart C				
Part	Rule Section	Description of Test	Result	Under Limit
4.1	15.207	AC Power Line Conducted Emissions	Complies	15.33 dB
4.2	15.247(b)(3)	Conducted Output Power	Complies	12.82 dB
4.3	15.247(e)	Power Spectral Density	Complies	18.08 dB
4.4	15.247(a)(2)	6dB Spectrum Bandwidth	Complies	-
4.5	15.247(d)	Radiated Emissions	Complies	0.15 dB
4.6	15.247(d)	Band Edge Emissions	Complies	0.18 dB
4.7	15.203	Antenna Requirements	Complies	-

Test Items	Uncertainty	Remark
AC Power Line Conducted Emissions	±2.3dB	Confidence levels of 95%
Maximum Conducted Output Power	±0.8dB	Confidence levels of 95%
Power Spectral Density	±0.5dB	Confidence levels of 95%
6dB Spectrum Bandwidth	±8.5×10 ⁻⁸	Confidence levels of 95%
Radiated Emissions (9kHz~30MHz)	±0.8dB	Confidence levels of 95%
Radiated Emissions (30MHz~1GHz)	±1.9dB	Confidence levels of 95%
Radiated / Band Edge Emissions (1GHz~18GHz)	±1.9dB	Confidence levels of 95%
Radiated Emissions (18GHz~40GHz)	±1.9dB	Confidence levels of 95%
Temperature	±0.7°C	Confidence levels of 95%
Humidity	±3.2%	Confidence levels of 95%
DC / AC Power Source	±1.4%	Confidence levels of 95%

3. GENERAL INFORMATION

3.1. Product Details

IEEE 802.11n

Items	Description
Product Type	WLAN (2TX, 2RX)
Radio Type	Intentional Transceiver
Power Type	From Host System
Modulation	see the below table for IEEE 802.11n see the below table for IEEE 802.11ac
Data Modulation	OFDM (BPSK / QPSK / 16QAM / 64QAM) For 802.11n OFDM (BPSK / QPSK / 16QAM / 64QAM / 256QAM) For 802.11ac
Data Rate (Mbps)	see the below table for IEEE 802.11n see the below table for IEEE 802.11ac
Frequency Range	2400 ~ 2483.5MHz / 5725 ~ 5850MHz
Channel Number	For 2.4GHz Band: 11 for 20MHz bandwidth ; 7 for 40MHz bandwidth For 5GHz Band: 5 for 20MHz bandwidth ; 2 for 40MHz bandwidth; 1 for 80MHz bandwidth
Channel Band Width (99%)	For 2.4GHz Band: MCS0 (HT 20MHz): 17.52 MHz ; MCS0 (HT 40MHz): 37.08 MHz For 5GHz Band: 11n MCS0 (HT 20MHz): 26.00 MHz ; 11n MCS0 (HT40 MHz): 45.24 MHz; 11ac MCS0 (VHT 80MHz): 76.40 MHz
Conducted Output Power	For 2.4GHz Band: MCS0 (HT 20MHz): 14.15 dBm ; MCS0 (HT 40MHz): 14.44 dBm For 5GHz Band: 11n MCS0 (HT 20MHz): 15.67 dBm ; 11n MCS0 (HT 40 MHz): 15.68 dBm; 11ac MCS0 (VHT 20MHz): 15.92 dBm; 11ac MCS0 (VHT 40MHz): 15.82 dBm; 11ac MCS0 (VHT 80MHz): 13.98 dBm.
Carrier Frequencies	Please refer to section 3.4
Antenna	Please refer to section 3.3

802.11a/b/g

Items	Description
Product Type	WLAN (2TX, 2RX)
Radio Type	Intentional Transceiver
Power Type	From Host System
Modulation	DSSS for IEEE 802.11b ; OFDM for IEEE 802.11a/g
Data Modulation	DSSS (BPSK / QPSK / CCK) ; OFDM (BPSK / QPSK / 16QAM / 64QAM)
Data Rate (Mbps)	DSSS (1/ 2/ 5.5/11) ; OFDM (6/9/12/18/24/36/48/54)
Frequency Range	2400 ~ 2483.5MHz / 5725 ~ 5850MHz
Channel Number	11b/g: 11 ; 11a: 5
Channel Band Width (99%)	11b: 13.28 MHz ; 11g: 16.40 MHz ; 11a: 26.00 MHz
Conducted Output Power	11b: 14.29 dBm ; 11g: 14.15 dBm ; 11a: 15.87 dBm
Carrier Frequencies	Please refer to section 3.4
Antenna	Please refer to section 3.3

Antenna & Band width

Antenna	Two (TX)		
	20 MHz	40 MHz	80MHz
Band width Mode			
IEEE 802.11a	V	X	X
IEEE 802.11b	V	X	X
IEEE 802.11g	V	X	X
IEEE 802.11n	V	V	X
IEEE 802.11ac	V	V	V

IEEE 802.11n spec

MCS Index	Nss	Modulation	R	NBPS	NCBPS		NDBPS		Datarate(Mbps)			
					20MHz	40MHz	20MHz	40MHz	800nsGI		400nsGI	
									20MHz	40MHz	20MHz	40MHz
0	1	BPSK	1/2	1	52	108	26	54	6.5	13.5	7.200	15
1	1	QPSK	1/2	2	104	216	52	108	13.0	27.0	14.400	30
2	1	QPSK	3/4	2	104	216	78	162	19.5	40.5	21.700	45
3	1	16-QAM	1/2	4	208	432	104	216	26.0	54.0	28.900	60
4	1	16-QAM	3/4	4	208	432	156	324	39.0	81.0	43.300	90
5	1	64-QAM	2/3	6	312	648	208	432	52.0	108.0	57.800	120
6	1	64-QAM	3/4	6	312	648	234	486	58.5	121.5	65.000	135
7	1	64-QAM	5/6	6	312	648	260	540	65.0	135.0	72.200	150
8	2	BPSK	1/2	1	104	216	52	108	13.0	27.0	14.444	30
9	2	QPSK	1/2	2	208	432	104	216	26.0	54.0	28.889	60
10	2	QPSK	3/4	2	208	432	156	324	39.0	81.0	43.333	90
11	2	16-QAM	1/2	4	416	864	208	432	52.0	108.0	57.778	120
12	2	16-QAM	3/4	4	416	864	312	648	78.0	162.0	86.667	180
13	2	64-QAM	2/3	6	624	1296	416	864	104.0	216.0	115.556	240
14	2	64-QAM	3/4	6	624	1296	468	972	117.0	243.0	130.000	270
15	2	64-QAM	5/6	6	624	1296	520	1080	130.0	270.0	144.444	300

Symbol	Explanation
NSS	Number of spatial streams
R	Code rate
NBPS	Number of coded bits per single carrier
NCBPS	Number of coded bits per symbol
NDBPS	Number of data bits per symbol
GI	guard interval

IEEE 802. 11a, 11n and 11ac Spec.

Worst Modulation Used for Conformance Testing				
Protocol	Number of Transmit Chains (NTX)	Data Rate / MCS	Worst Data Rate / MCS	Worst Modulation Mode
802.11a	3	6-54 Mbps	6Mbps	11A5.2G-20M
802.11n 20MHz	3	MCS 0-15	MCS 0	11N5.2G-20M
802.11n 40MHz	3	MCS 0-15	MCS 0	11N5.2G-40M
802.11ac 20MHz	3	MCS 0-9	MCS 0-Nss1	11AC5.8G-20M
802.11ac 40MHz	3	MCS 0-9	MCS 0-Nss1	11AC5.8G-40M
802.11ac 80MHz	3	MCS 0-9	MCS 0-Nss1	11AC5.8G-80M
Note 1: IEEE Std. 802.11-2007 modulation consists of IEEE Std. 802.11a-1999.				
Note 2: IEEE Std. 802.11n-2009 modulation consists of HT20 and HT40 (HT: High Throughput). Then EUT support HT20 and HT40. Worst modulation mode of Guard Interval (GI) is 400ns.				
Note 3: draft IEEE Std. 802.11ac-2012 modulation consists of VHT20, VHT40, VHT80 and VHT160. Then EUT support VHT20, VHT40, VHT80. (VHT: Very High Throughput).				
Note 4: Modulation modes consist of 11A5.2G-20M, 11A5.3G-20M, 11A5.6G-20M, 11A5.8G-20M, 11N5.2G-20M, 11N5.3G-20M, 11N5.6G-20M, 11N5.8G-20M, 11N5.2G-40M, 11N5.3G-40M, 11N5.6G-40M, 11N5.8G-40M, 11AC5.2G-20M, 11AC5.3G-20M, 11AC5.6G-20M, 11AC5.8G-20M, 11AC5.2G-40M, 11AC5.3G-40M, 11AC5.6G-40M, 11AC5.8G-40M, 11AC5.2G-80M, 11AC5.3G-80M, 11AC5.6G-80M, 11AC5.8G-80M,				
11A: IEEE 802.11a, 11N: IEEE 802.11n, 11AC: IEEE 802.11ac. 5.2G: 5.15-5.25 GHz band, 5.3G: 5.25-5.35 GHz band, 5.6G: 5.47-5.725 GHz band , 5.8G: 5.725-5.850GHz band				
20M/40M/80M: Channel Bandwidth 20MHz/40MHz/80MHz				

3.2. Accessories

Other
USB Cable * 1, No-Shield 0.8m

3.3. Table for Filed Antenna

Ant.	Brand	Model Name	Antenna Type	Connector	Gain (dBi)	
					2.4GHz	4.30
1	WNC	-	LCD Antenna	I-PEX	5GHz Band 4	4.30
					2.4GHz	4.30
2	WNC	-	LCD Antenna	I-PEX	5GHz Band 4	4.30
					2.4GHz	4.30

Note: The EUT has two antennas

For 2.4GHz Band:

For IEEE 802.11 bgn mode (2TX/2RX):

Ant. 1 and Ant. 2 could transmit/receive simultaneously.

For 5GHz Band:

For IEEE 802.11 n mode (2TX/2RX):

Ant. 1 and Ant. 2 could transmit/receive simultaneously.

For IEEE 802.11 a/ac mode (2TX/2RX):

Ant. 1 and Ant. 2 could transmit/receive simultaneously.

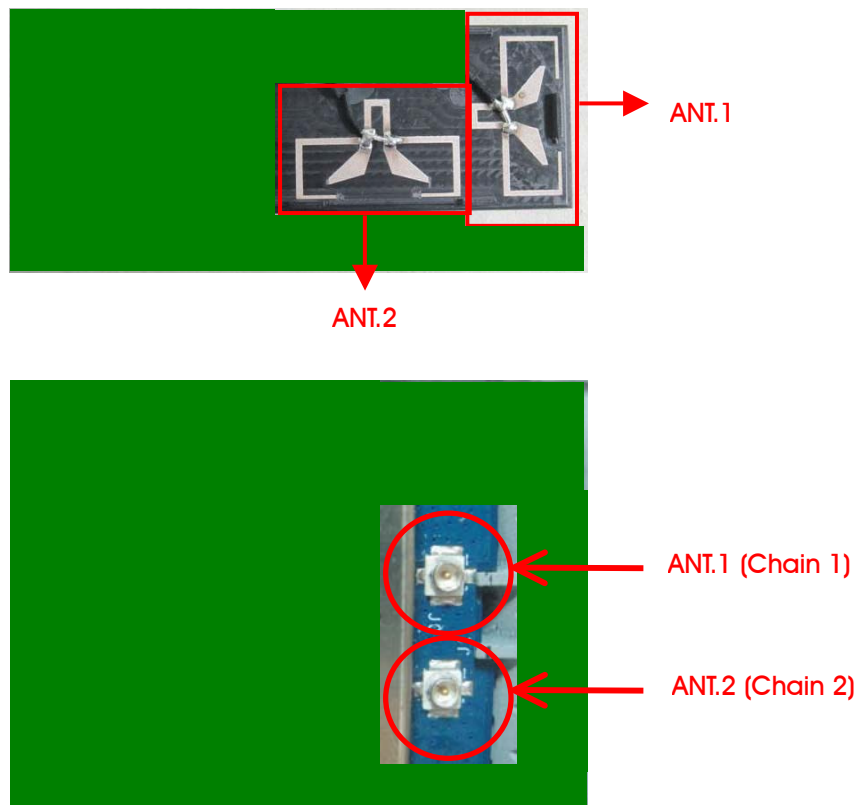

3.4. Table for Carrier Frequencies

For 2.4GHz Band:

For IEEE 802.11b/g, use Channel 1~Channel 11.

There are two bandwidth systems for IEEE 802.11n.

For 20MHz bandwidth systems, use Channel 1~Channel 11.

For 40MHz bandwidth systems, use Channel 3~Channel 9.

Frequency Band	Channel No.	Frequency	Channel No.	Frequency
2400~2483.5MHz	1	2412 MHz	7	2442 MHz
	2	2417 MHz	8	2447 MHz
	3	2422 MHz	9	2452 MHz
	4	2427 MHz	10	2457 MHz
	5	2432 MHz	11	2462 MHz
	6	2437 MHz	-	-

For 5GHz Band:

The EUT has three bandwidth system.

For 20MHz bandwidth systems, use Channel 149, 153, 157, 161, 165.

For 40MHz bandwidth systems, use Channel 151, 159.

For 80MHz bandwidth systems, use Channel 155.

Frequency Band	Channel No.	Frequency	Channel No.	Frequency
5725~5850 MHz Band 4	149	5745 MHz	157	5785 MHz
	151	5755 MHz	159	5795 MHz
	153	5765 MHz	161	5805 MHz
	155	5775 MHz	165	5825 MHz

3.5. Table for Test Modes

Preliminary tests were performed in different data rate to find the worst radiated emission. The data rate shown in the table below is the worst-case rate with respect to the specific test item. Investigation has been done on all the possible configurations for searching the worst cases. The following table is a list of the test modes shown in this test report.

For 2.4GHz Band

Test Items	Mode	Data Rate	Channel	Antenna
AC Power Line Conducted Emissions	Normal Link	Auto	-	-
Conducted Output Power Power Spectral Density	MCS0/20MHz	6.5 Mbps	1/6/11	1/2/1+2
	MCS0/40MHz	13.5 Mbps	3/6/9	1/2/1+2
	11b/CCK	1 Mbps	1/6/11	1/2/1+2
	11g/BPSK	6 Mbps	1/6/11	1/2/1+2
6dB Spectrum Bandwidth	MCS0/20MHz	6.5 Mbps	1/6/11	1+2
	MCS0/40MHz	13.5 Mbps	3/6/9	1+2
	11b/CCK	1 Mbps	1/6/11	1+2
	11g/BPSK	6 Mbps	1/6/11	1+2
Radiated Emissions Below 1GHz	Normal Link	Auto	-	-
Radiated Emissions Above 1GHz	MCS0/20MHz	6.5 Mbps	1/6/11	1+2
	MCS0/40MHz	13.5 Mbps	3/6/9	1+2
	11b/CCK	1 Mbps	1/6/11	1+2
	11g/BPSK	6 Mbps	1/6/11	1+2
Band Edge Emissions	MCS0/20MHz	6.5 Mbps	1/11	1+2
	MCS0/40MHz	13.5 Mbps	3/9	1+2
	11b/CCK	1 Mbps	1/11	1+2
	11g/BPSK	6 Mbps	1/11	1+2

For 5GHz Band

Test Items	Mode	Data Rate	Channel	Antenna
AC Power Line Conducted Emissions	Normal Link	Auto	-	-
Conducted Output Power Power Spectral Density	11n 20MHz	6.5 Mbps	149/157/165	1/2/1+2
	11n 40MHz	13.5 Mbps	151/159	1/2/1+2
	11ac 20MHz	MCS0NSS1	149/157/165	1/2/1+2
	11ac 40MHz	MCS0NSS1	151/159	1/2/1+2
	11ac 80MHz	MCS0NSS1	155	1/2/1+2
	11a	6 Mbps	149/157/165	1/2/1+2
6dB Spectrum Bandwidth	11n 20MHz	6.5 Mbps	149/157/165	1+2
	11n 40MHz	13.5 Mbps	151/159	1+2
	11ac 80MHz	MCS0NSS1	155	1+2
	11a	6 Mbps	149/157/165	1+2
Radiated Emissions Below 1GHz	Normal Link	Auto	-	-
Radiated Emissions Above 1GHz	11n 20MHz	6.5 Mbps	149/157/165	1+2
	11n 40MHz	13.5 Mbps	151/159	1+2
	11ac 20MHz	MCS0NSS1	149/157/165	1+2
	11ac 40MHz	MCS0NSS1	151/159	1+2
	11ac 80MHz	MCS0NSS1	155	1+2
	11a	6 Mbps	149/157/165	1+2
Band Edge Emissions	11n 20MHz	6.5 Mbps	149/157/165	1+2
	11n 40MHz	13.5 Mbps	151/159	1+2
	11ac 20MHz	MCS0NSS1	149/157/165	1+2
	11ac 40MHz	MCS0NSS1	151/159	1+2
	11ac 80MHz	MCS0NSS1	155	1+2
	11a	6 Mbps	149/157/165	1+2

The following test modes were performed for all tests:

Mode 1: EUT - X axis + antenna 0°

Mode 2: EUT - X axis + antenna 90°

Mode 3: EUT - X axis + antenna 180°

Mode 3 has been evaluated to be the worst case, thus measurement will follow this same test mode.

Mode 4: EUT - Y axis + antenna 180°

Mode 5: EUT - Z axis + antenna 180°

For Conducted Emission test:

Due to Mode 3 generated the worst test result, it was recorded in this report.

For Radiated Emission test:

<For Radiated Emissions Test below 1GHz:>

Due to Mode 3 generated the worst test result, it was recorded in this report.

<For Radiated Emissions Test above 1GHz:> **Radiated Emissions (1GHz~10th Harmonic)**

Due to Mode 4 generated the worst test result, it was recorded in this report.

<For Radiated Emissions Test above 1GHz:> **Band Edge Emissions**

Due to Mode 2 generated the worst test result, it was recorded in this report.

<For MPE >:

The EUT could be applied with 2.4GHz WLAN function and 5GHz WLAN function; therefore Maximum Permissible Exposure (Please refer to Appendix B)

3.6. Table for Testing Locations

Test Site No.	Site Category	Location	FCC Reg. No.	IC File No.
03CH01-CB	SAC	Hsin Chu	262045	IC 4086D
CO01-CB	Conduction	Hsin Chu	262045	IC 4086D
TH01-CB	OVEN Room	Hsin Chu	-	-

Open Area Test Site (OATS); Semi Anechoic Chamber (SAC); Fully Anechoic Chamber (FAC).

Please refer section 6 for Test Site Address.

3.7. Table for Supporting Units

Support Unit	Brand	Model	FCC ID
Mouse	Logitech	M-U0026	DoC
EARPHONES	E-books	E-EPC040	N/A
Wireless AP	BELKIN	WG7016G22-LF-AK	DOC
Notebook	DELL	D505	E2K24GBRL

3.8. Table for Parameters of Test Software Setting

During testing, Channel & Power Controlling Software provided by the customer was used to control the operating channel as well as the output power level. The RF output power selection is for the setting of RF output power expected by the customer and is going to be fixed on the firmware of the final end product.

For 2.4GHz Band

Power Parameters of IEEE 802.11n MCS0 HT 20MHz

Test Software Version	Manual Toov Version 1.0.0.10		
Frequency	2412 MHz	2437 MHz	2462 MHz
MCS0 20MHz	45	45	45

Power Parameters of IEEE 802.11n MCS0 HT 40MHz

Test Software Version	Manual Toov Version 1.0.0.10		
Frequency	2422 MHz	2437 MHz	2452 MHz
MCS0 40MHz	45	45	45

Power Parameters of IEEE 802.11b/g

Test Software Version	Manual Toov Version 1.0.0.10		
Frequency	2412 MHz	2437 MHz	2462 MHz
IEEE 802.11b	45	45	45
IEEE 802.11g	45	45	45

For 5GHz Band
Power Parameters of IEEE 802.11n MCS0 HT 20MHz

Test Software Version	Manual Toov Version 1.0.0.10		
Frequency	5745 MHz	5785 MHz	5825 MHz
MCS0 20MHz	42	42	42

Power Parameters of IEEE 802.11n MCS0 HT 40MHz

Test Software Version	Manual Toov Version 1.0.0.10	
Frequency	5755 MHz	5795 MHz
MCS0 40MHz	42	42

Power Parameters of IEEE 802.11ac MCS0 VHT 20MHz

Test Software Version	Manual Toov Version 1.0.0.10		
Frequency	5745 MHz	5785 MHz	5825 MHz
MCS0 20MHz	42	42	42

Power Parameters of IEEE 802.11ac MCS0 VHT 40MHz

Test Software Version	Manual Toov Version 1.0.0.10	
Frequency	5755 MHz	5795 MHz
MCS0 40MHz	42	42

Power Parameters of IEEE 802.11ac MCS0 VHT 80MHz

Test Software Version	Manual Toov Version 1.0.0.10	
Frequency	5775 MHz	
MCS0 80MHz	42	

Power Parameters of IEEE 802.11a

Test Software Version	Manual Toov Version 1.0.0.10		
Frequency	5745 MHz	5785 MHz	5825 MHz
IEEE 802.11a	42	42	42

During the test, "Manual Toov Version 1.0.0.10" under WIN XP was executed the test program to control the EUT continuously transmit RF signal.

3.9. Test Configurations

3.9.1. Radiation Emissions Test Configuration

For Radiated Emission test below 1GHz :

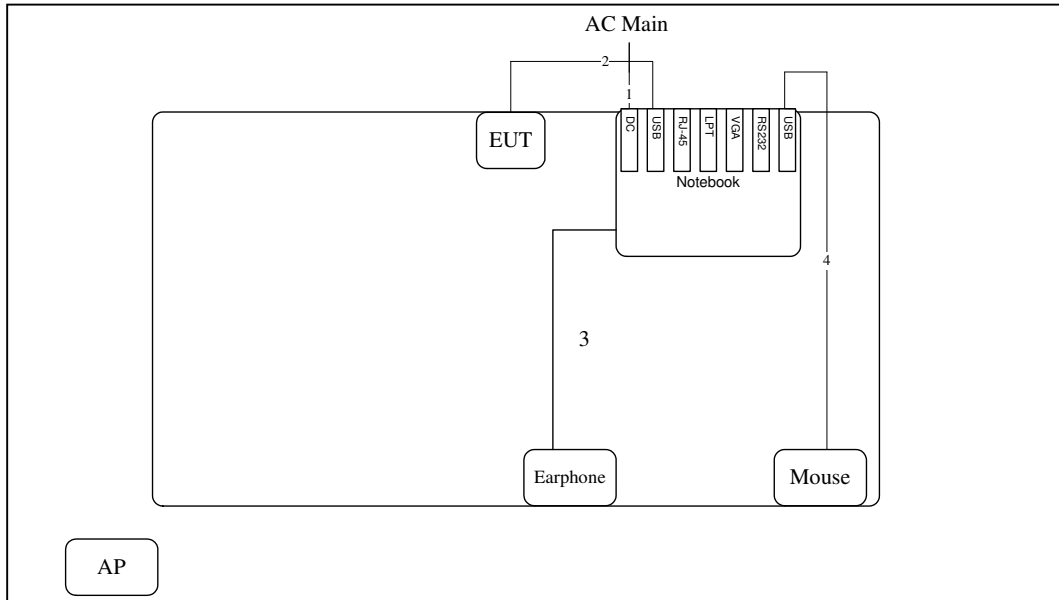

Item	Connection	Shield	Length
1	Power Cable	No	2.6M
2	USB Cable	Yes	0.8M
3	Earphone Cable	NO	1.1M
4	USB Cable	Yes	1.8M

For Radiated Emission test above 1GHz :

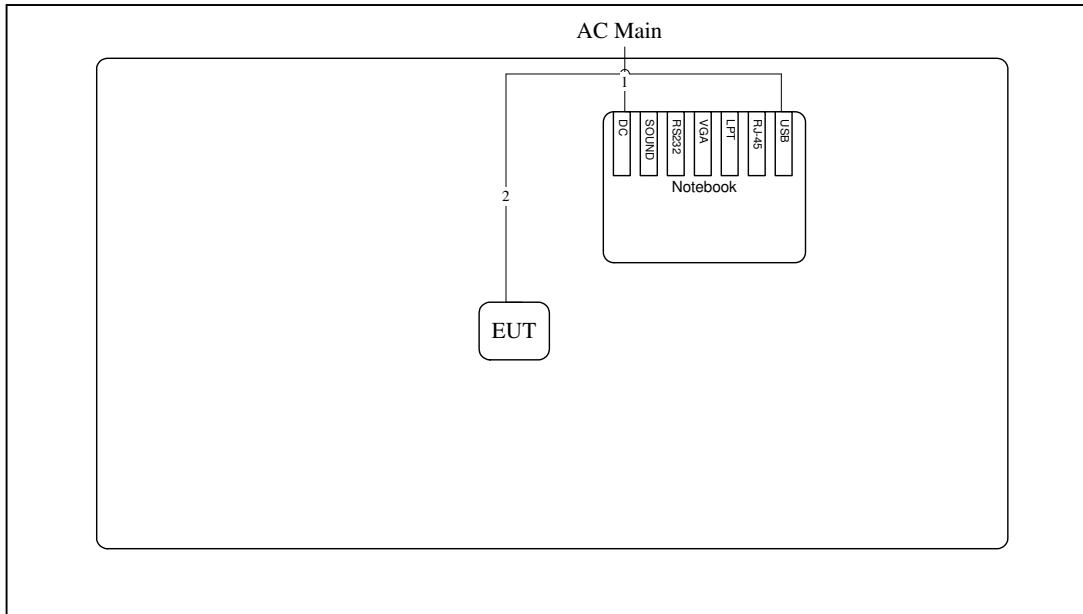

Item	Connection	Shield	Length
1	Power Cable	No	2.6m
2	USB Cable	Yes	0.1m

3.9.2. AC Power Line Conduction Emissions Test Configuration

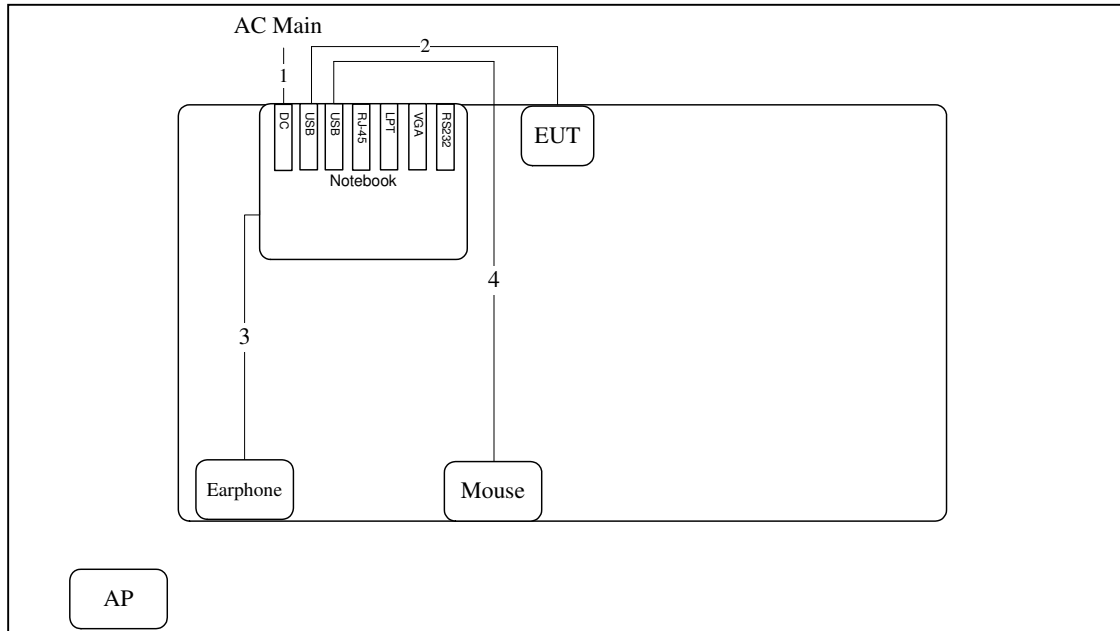

Item	Connection	Shield	Length
1	Power Cable	No	2.6M
2	USB Cable	Yes	0.8M
3	Earphone Cable	No	1.1M
4	USB Cable	Yes	1.8M

4. TEST RESULT

4.1. AC Power Line Conducted Emissions Measurement

4.1.1. Limit

For this product which is designed to be connected to the AC power line, the radio frequency voltage that is conducted back onto the AC power line on any frequency or frequencies within the band 150 kHz to 30 MHz shall not exceed below limits table.

Frequency (MHz)	QP Limit (dBuV)	AV Limit (dBuV)
0.15~0.5	66~56	56~46
0.5~5	56	46
5~30	60	50

4.1.2. Measuring Instruments and Setting

Please refer to section 5 of equipments list in this report. The following table is the setting of the receiver.

Receiver Parameters	Setting
Attenuation	10 dB
Start Frequency	0.15 MHz
Stop Frequency	30 MHz
IF Bandwidth	9 KHz

4.1.3. Test Procedures

1. Configure the EUT according to ANSI C63.10. The EUT or host of EUT has to be placed 0.4 meter far from the conducting wall of the shielding room and at least 80 centimeters from any other grounded conducting surface.
2. Connect EUT or host of EUT to the power mains through a line impedance stabilization network (LISN).
3. All the support units are connected to the other LISNs. The LISN should provide 50uH/50ohms coupling impedance.
4. The frequency range from 150 KHz to 30 MHz was searched.
5. Set the test-receiver system to Peak Detect Function and Specified Bandwidth with Maximum Hold Mode.
6. The measurement has to be done between each power line and ground at the power terminal.

4.1.4. Test Setup Layout

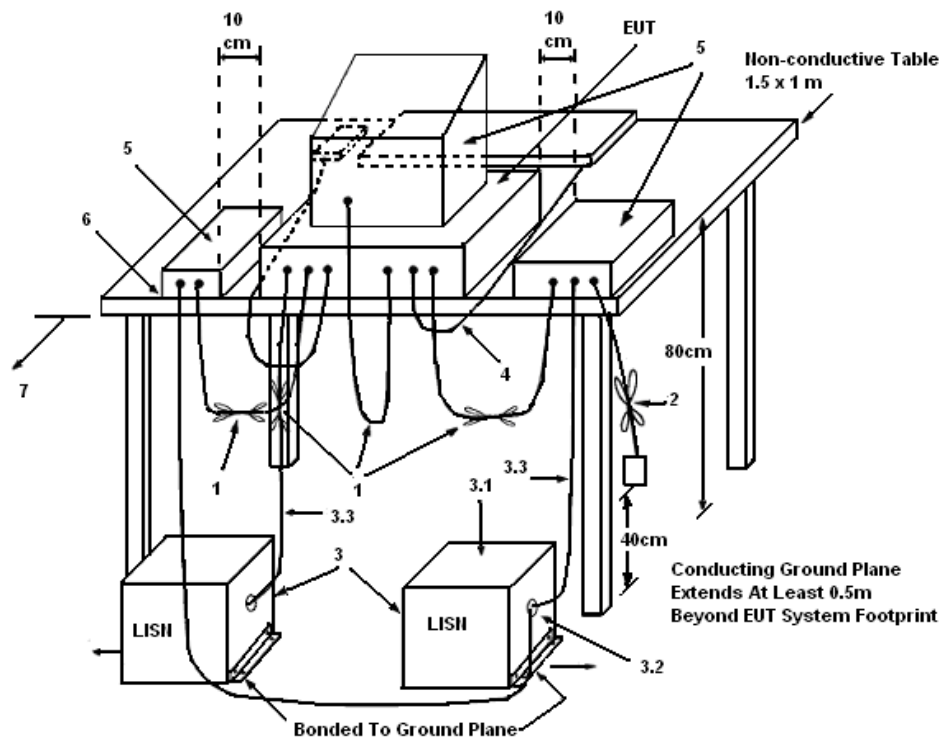

LEGEND:

- (1) Interconnecting cables that hang closer than 40 cm to the ground plane shall be folded back and forth in the center forming a bundle 30 to 40 cm long.
- (2) I/O cables that are not connected to a peripheral shall be bundled in the center. The end of the cable may be terminated, if required, using the correct terminating impedance. The overall length shall not exceed 1 m.
- (3) EUT connected to one LISN. Unused LISN measuring port connectors shall be terminated in 50 Ω . LISN can be placed on top of, or immediately beneath, reference ground plane.
 - (3.1) All other equipment powered from additional LISN(s).
 - (3.2) Multiple outlet strip can be used for multiple power cords of non-EUT equipment.
 - (3.3) LISN at least 80 cm from nearest part of EUT chassis.
- (4) Cables of hand-operated devices, such as keyboards, mice, etc., shall be placed as for normal use.
- (5) Non-EUT components of EUT system being tested.
- (6) Rear of EUT, including peripherals, shall all be aligned and flush with rear of tabletop.
- (7) Rear of tabletop shall be 40 cm removed from a vertical conducting plane that is bonded to the ground plane.

4.1.5. Test Deviation

There is no deviation with the original standard.

4.1.6. EUT Operation during Test

The EUT was placed on the test table and programmed in normal function.

4.1.7. Results of AC Power Line Conducted Emissions Measurement

Temperature	24°C	Humidity	56%
Test Engineer	Simon Yang	Phase	Line
Configuration	Normal Link	Test Mode	Mode 3

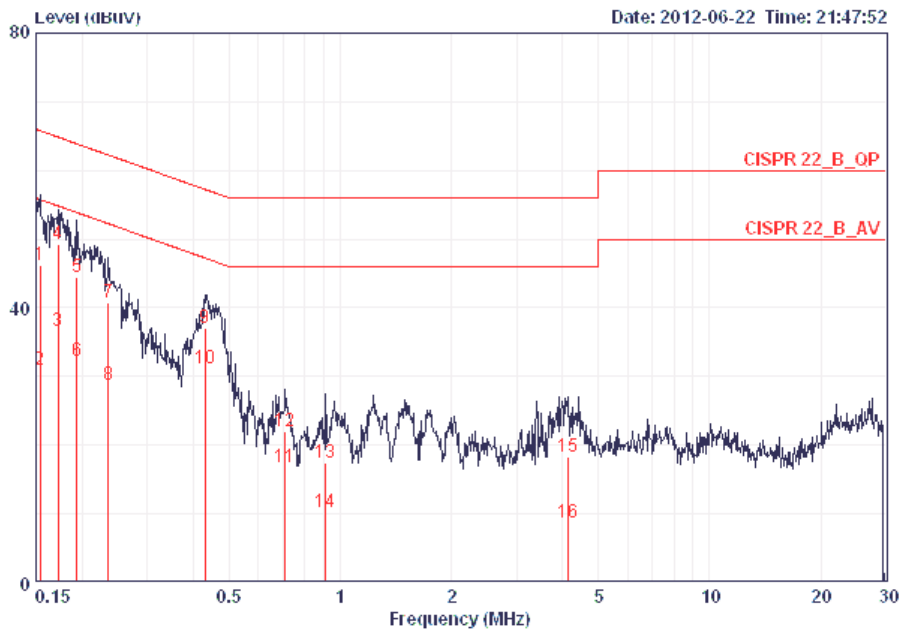

	Freq	Level	Over Limit	Limit Line	Read Level	LISN Factor	Cable Loss	Remark
	MHz	dBuV	dB	dBuV	dBuV	dB	dB	
1	0.15403	46.22	-19.56	65.78	45.78	0.24	0.20	QP
2	0.15403	30.87	-24.91	55.78	30.43	0.24	0.20	AVERAGE
3	0.17215	36.54	-18.32	54.86	36.13	0.21	0.20	AVERAGE
4	0.17215	49.26	-15.60	64.86	48.85	0.21	0.20	QP
5	0.19344	44.46	-19.43	63.89	44.09	0.17	0.20	QP
6	0.19344	32.34	-21.55	53.89	31.97	0.17	0.20	AVERAGE
7	0.23533	40.77	-21.49	62.26	40.43	0.14	0.20	QP
8	0.23533	28.70	-23.56	52.26	28.36	0.14	0.20	AVERAGE
9	0.43052	37.02	-20.22	57.24	36.74	0.08	0.20	QP
10	0.43052	31.22	-16.02	47.24	30.94	0.08	0.20	AVERAGE
11	0.70842	16.78	-29.22	46.00	16.51	0.07	0.20	AVERAGE
12	0.70842	21.93	-34.07	56.00	21.66	0.07	0.20	QP
13	0.91357	17.41	-38.59	56.00	17.15	0.06	0.20	QP
14	0.91357	10.34	-35.66	46.00	10.08	0.06	0.20	AVERAGE
15	4.136	18.30	-37.70	56.00	17.92	0.08	0.30	QP
16	4.136	8.78	-37.22	46.00	8.40	0.08	0.30	AVERAGE

Temperature	24°C	Humidity	56%
Test Engineer	Simon Yang	Phase	Neutral
Configuration	Normal Link	Test Mode	Mode 3

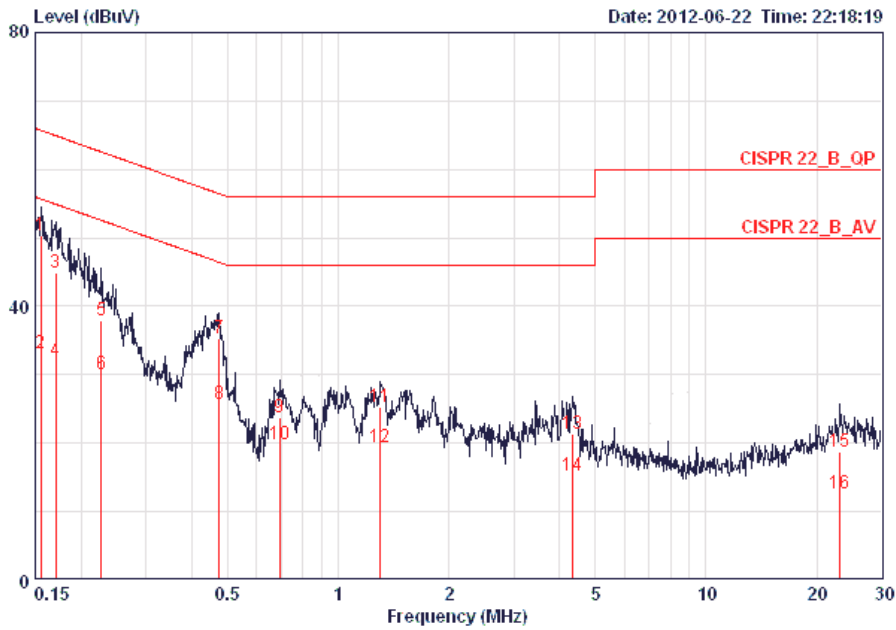

	Freq	Level	Over Limit	Limit Line	Read Level	LISN Factor	Cable Loss	Remark
	MHz	dBuV	dB	dBuV	dBuV	dB	dB	
1	0.15567	50.36	-15.33	65.69	49.92	0.24	0.20	QP
2	0.15567	33.12	-22.57	55.69	32.68	0.24	0.20	AVERAGE
3	0.17034	44.80	-20.14	64.94	44.39	0.21	0.20	QP
4	0.17034	32.15	-22.79	54.94	31.74	0.21	0.20	AVERAGE
5	0.22676	37.91	-24.65	62.57	37.57	0.14	0.20	QP
6	0.22676	30.14	-22.42	52.57	29.80	0.14	0.20	AVERAGE
7	0.47360	35.23	-21.22	56.45	35.00	0.07	0.17	QP
8	0.47360	25.76	-20.69	46.45	25.53	0.07	0.17	AVERAGE
9	0.69357	23.81	-32.19	56.00	23.55	0.06	0.20	QP
10	0.69357	19.85	-26.15	46.00	19.59	0.06	0.20	AVERAGE
11	1.303	25.19	-30.81	56.00	25.00	0.05	0.14	QP
12	1.303	19.37	-26.63	46.00	19.18	0.05	0.14	AVERAGE
13	4.338	21.36	-34.64	56.00	21.00	0.06	0.30	QP
14	4.338	15.36	-30.64	46.00	15.00	0.06	0.30	AVERAGE
15	23.140	18.67	-41.33	60.00	18.00	0.17	0.50	QP
16	23.140	12.67	-37.33	50.00	12.00	0.17	0.50	AVERAGE

Note:

Level = Read Level + LISN Factor + Cable Loss

4.2. Conducted Output Power Measurement

4.2.1. Limit

For systems using digital modulation in the 2400-2483.5MHz, the limit for peak output power is 30dBm. The limited has to be reduced by the amount in dB that the gain of the antenna exceed 6dBi. In case of point-to-point operation, the limit has to be reduced by 1dB for every 3dB that the directional gain of the antenna exceeds 6dBi.

4.2.2. Measuring Instruments and Setting

Please refer to section 5 of equipments list in this report. The following table is the setting of spectrum analyzer.

Spectrum Parameter	Setting
Attenuation	Auto
Span Frequency	Encompass the entire emissions bandwidth (EBW) of the signal
RB	1MHz
VB	3MHz
Detector	RMS
Trace	Average 100
Sweep Time	Auto

4.2.3. Test Procedures

1. The transmitter output (antenna port) was connected to the spectrum analyzer.
2. Test was performed in accordance with KDB 558074 Guidance for Performing Compliance Measurements on Digital Transmission Systems (DTS) Operating Under §15.247 section 5.2.2.2. Multiple antenna systems was performed in accordance with KDB 662911 Emissions Testing of Transmitters with Multiple Outputs in the Same Band.
3. When measuring maximum conducted output power with multiple antenna systems, add every result of the values by mathematic formula.

4.2.4. Test Setup Layout

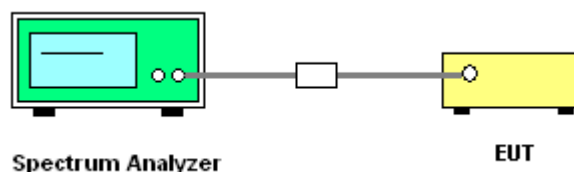

4.2.5. Test Deviation

There is no deviation with the original standard.

4.2.6. EUT Operation during Test

The EUT was programmed to be in continuously transmitting mode.

4.2.7. Test Result of Conducted Output Power

Temperature	26°C	Humidity	61%
Test Engineer	Satoshi Yang	Configurations	IEEE 802.11n/ac

For 2.4GHz Band

Configuration IEEE 802.11n MCS0 HT20MHz / Ant. 1 + Ant. 2

Channel	Frequency	Conducted Power (dBm)		Total Conducted Power (dBm)	Max. Limit (dBm)	Result
		Ant. 1	Ant. 2			
1	2412 MHz	11.35	10.83	14.11	30.00	Complies
6	2437 MHz	11.37	10.77	14.09	30.00	Complies
11	2462 MHz	11.40	10.87	14.15	30.00	Complies

Configuration IEEE 802.11n MCS0 HT40MHz / Ant. 1 + Ant. 2

Channel	Frequency	Conducted Power (dBm)		Total Conducted Power (dBm)	Max. Limit (dBm)	Result
		Ant. 1	Ant. 2			
3	2422 MHz	11.72	11.12	14.44	30.00	Complies
6	2437 MHz	11.58	11.00	14.31	30.00	Complies
9	2452 MHz	11.53	11.05	14.31	30.00	Complies

For 5GHz Band

Configuration IEEE 802.11n MCS0 HT20MHz / Ant. 1 + Ant. 2

Channel	Frequency	Conducted Power (dBm)		Total Conducted Power (dBm)	Max. Limit (dBm)	Result
		Ant. 1	Ant. 2			
149	5745 MHz	12.39	12.56	15.49	30.00	Complies
157	5785 MHz	12.57	12.66	15.63	30.00	Complies
165	5825 MHz	12.46	12.85	15.67	30.00	Complies

Configuration IEEE 802.11n MCS0 HT40MHz / Ant. 1 + Ant. 2

Channel	Frequency	Conducted Power (dBm)		Total Conducted Power (dBm)	Max. Limit (dBm)	Result
		Ant. 1	Ant. 2			
151	5755 MHz	12.34	12.66	15.51	30.00	Complies
159	5795 MHz	12.55	12.79	15.68	30.00	Complies

Configuration IEEE 802.11ac MCS0 VHT20MHz / Ant. 1 + Ant. 2

Channel	Frequency	Conducted Power (dBm)		Total Conducted Power (dBm)	Max. Limit (dBm)	Result
		Ant. 1	Ant. 2			
149	5745 MHz	12.51	12.74	15.64	30.00	Complies
157	5785 MHz	12.66	12.78	15.73	30.00	Complies
165	5825 MHz	12.86	12.96	15.92	30.00	Complies

Configuration IEEE 802.11ac MCS0 VHT40MHz / Ant. 1 + Ant. 2

Channel	Frequency	Conducted Power (dBm)		Total Conducted Power (dBm)	Max. Limit (dBm)	Result
		Ant. 1	Ant. 2			
151	5755 MHz	12.47	12.93	15.72	30.00	Complies
159	5795 MHz	12.66	12.95	15.82	30.00	Complies

Configuration IEEE 802.11ac MCS0 VHT80MHz / Ant. 1 + Ant. 2

Channel	Frequency	Conducted Power (dBm)		Total Conducted Power (dBm)	Max. Limit (dBm)	Result
		Ant. 1	Ant. 2			
155	5775 MHz	10.88	11.05	13.98	30.00	Complies

Temperature	26°C	Humidity	61%
Test Engineer	Satoshi Yang	Configurations	IEEE 802.11a/b/g

Configuration IEEE 802.11b / Ant. 1 + Ant. 2

Channel	Frequency	Conducted Power (dBm)		Total Conducted Power (dBm)	Max. Limit (dBm)	Result
		Ant. 1	Ant. 2			
1	2412 MHz	11.32	10.80	14.08	28.69	Complies
6	2437 MHz	11.54	11.00	14.29	28.69	Complies
11	2462 MHz	11.44	10.96	14.22	28.69	Complies

Note: Directional gain = $G_{ANT} + 10 \log(N)$ dBi = 7.31dBi > 6dBi, so the conducted power limit = $30 - (7.31 \text{ dBi} - 6) = 28.69 \text{ dBm}$

Configuration IEEE 802.11g / Ant. 1 + Ant. 2

Channel	Frequency	Conducted Power (dBm)		Total Conducted Power (dBm)	Max. Limit (dBm)	Result
		Ant. 1	Ant. 2			
1	2412 MHz	11.45	10.79	14.14	28.69	Complies
6	2437 MHz	11.41	10.86	14.15	28.69	Complies
11	2462 MHz	11.32	10.91	14.13	28.69	Complies

Note: Directional gain = $G_{ANT} + 10 \log(N)$ dBi = 7.31dBi > 6dBi, so the conducted power limit = $30 - (7.31 \text{ dBi} - 6) = 28.69 \text{ dBm}$

Configuration IEEE 802.11a / Ant. 1 + Ant. 2

Channel	Frequency	Conducted Power (dBm)		Total Conducted Power (dBm)	Max. Limit (dBm)	Result
		Ant. 1	Ant. 2			
149	5745 MHz	12.53	12.61	15.58	28.69	Complies
157	5785 MHz	12.68	12.82	15.76	28.69	Complies
165	5825 MHz	12.81	12.90	15.87	28.69	Complies

Note: Directional gain = $G_{ANT} + 10 \log(N)$ dBi = 7.31dBi > 6dBi, so the conducted power limit = $30 - (7.31 \text{ dBi} - 6) = 28.69 \text{ dBm}$

Conducted Output Power Plot on Configuration IEEE 802.11n MCS0 HT20MHz / 2462 MHz / ANT. 1

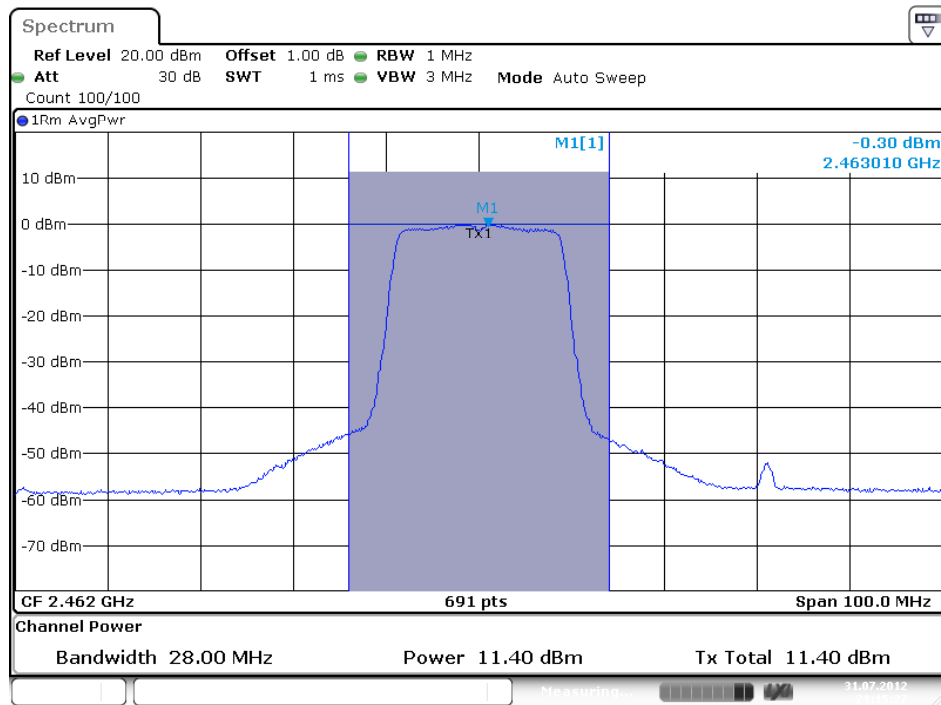

Conducted Output Power Plot on Configuration IEEE 802.11n MCS0 HT20MHz / 2462 MHz / ANT. 2

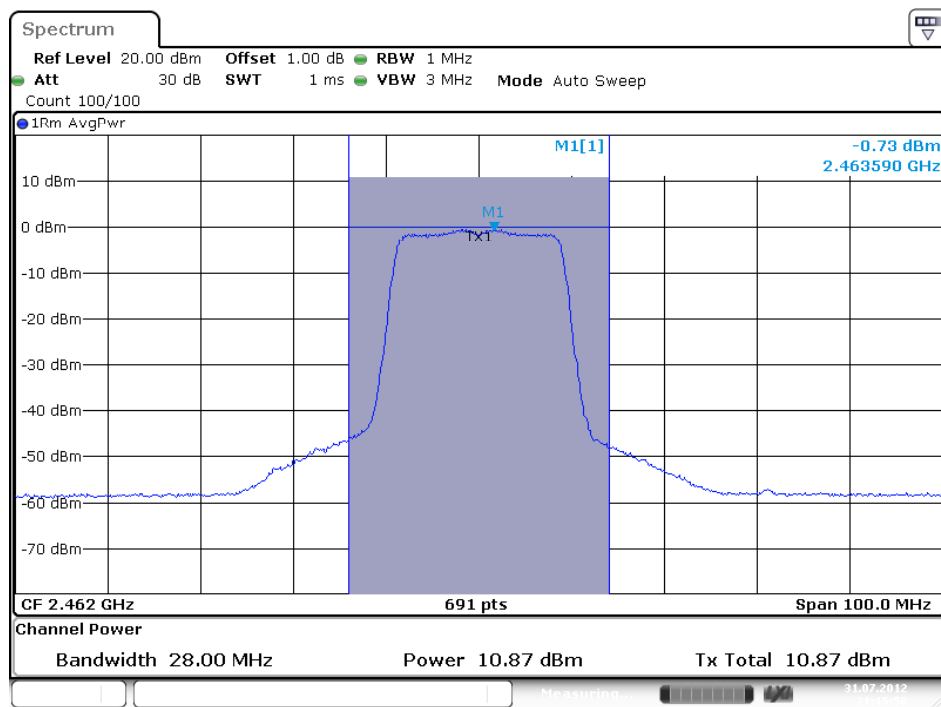

Conducted Output Power Plot on Configuration IEEE 802.11n MCS0 HT40MHz / 2422 MHz/ ANT. 1

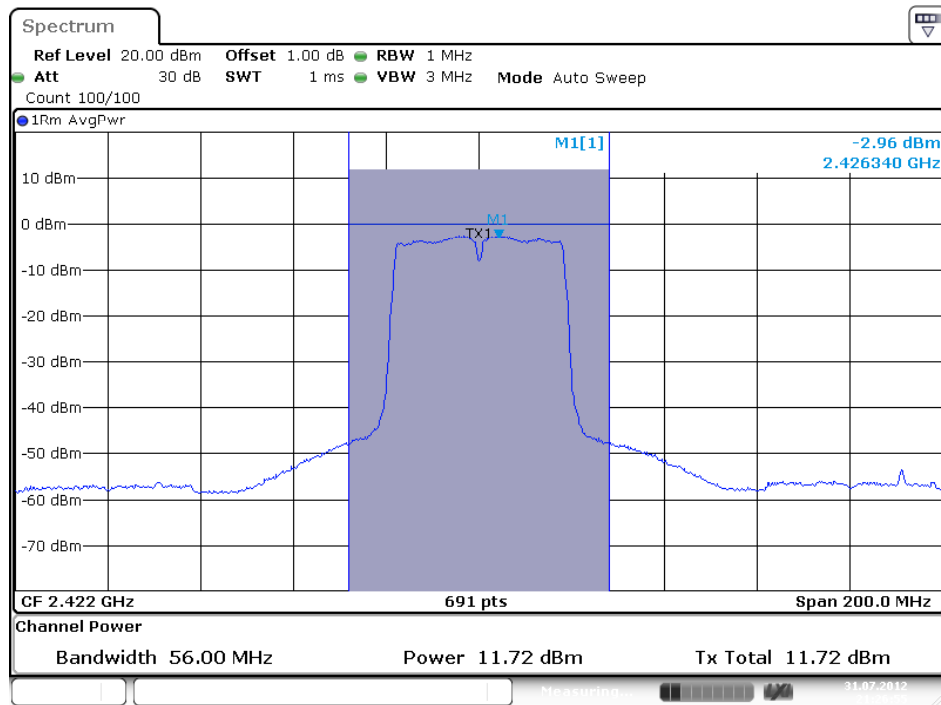

Date: 31.JUL.2012 21:26:55

Conducted Output Power Plot on Configuration IEEE 802.11n MCS0 HT40MHz / 2422 MHz/ ANT. 2

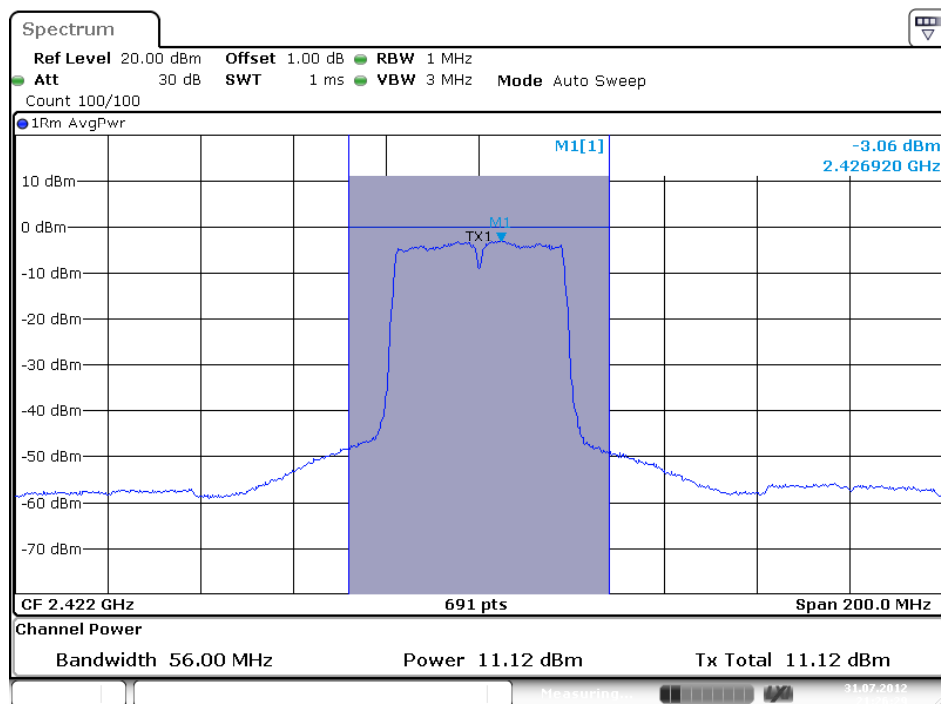

Date: 31.JUL.2012 21:26:28

Conducted Output Power Plot on Configuration IEEE 802.11n MCS0 HT20MHz / 5825 MHz / ANT. 1

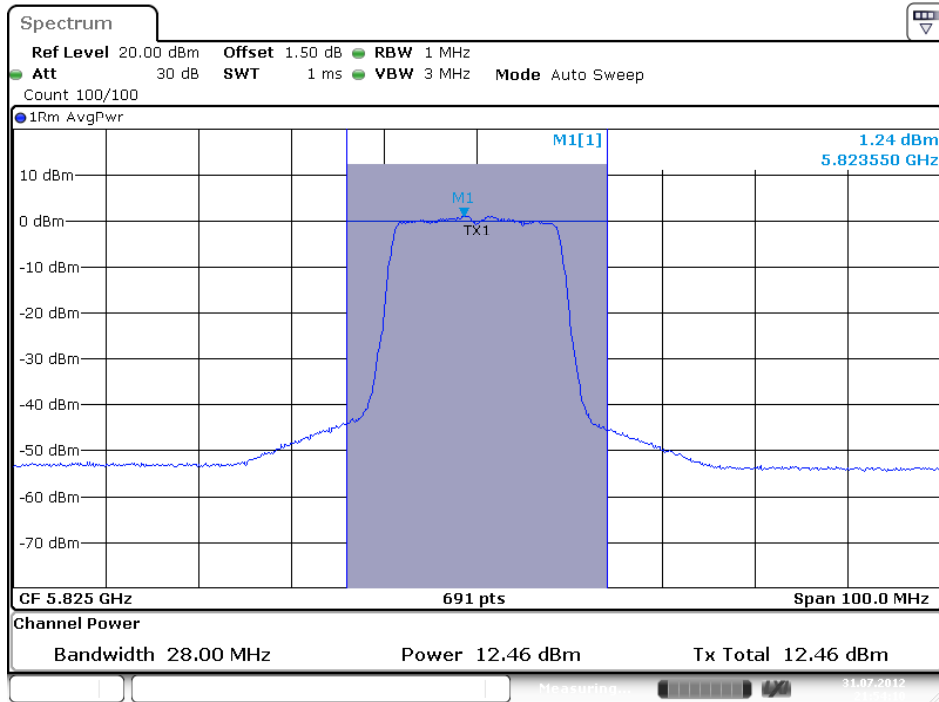

Conducted Output Power Plot on Configuration IEEE 802.11n MCS0 HT20MHz / 5825 MHz / ANT. 2

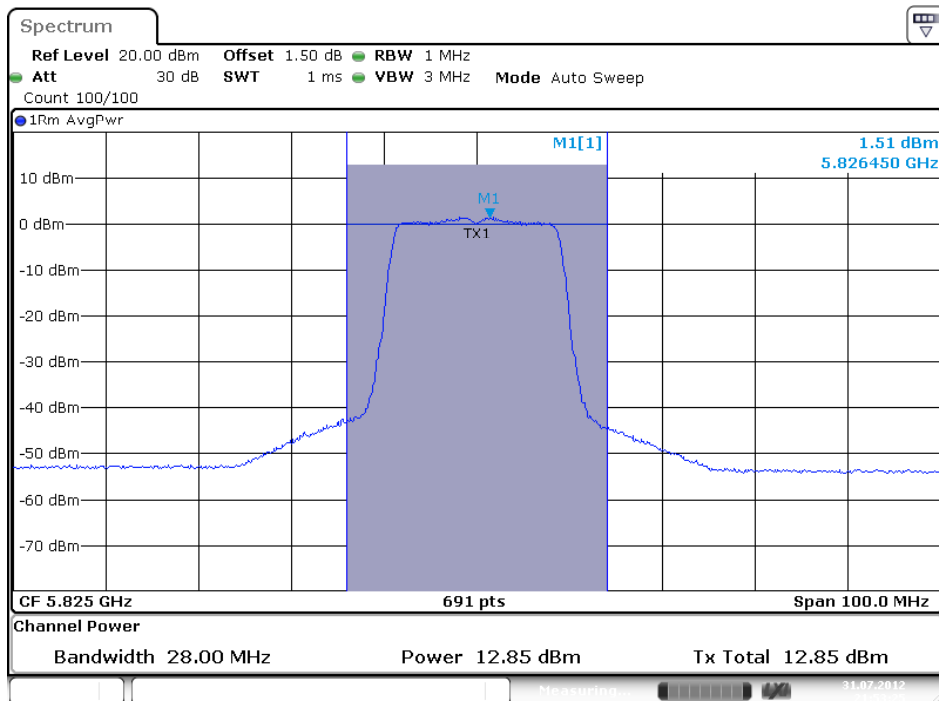

Conducted Output Power Plot on Configuration IEEE 802.11n MCS0 HT40MHz / 5795 MHz/ ANT. 1

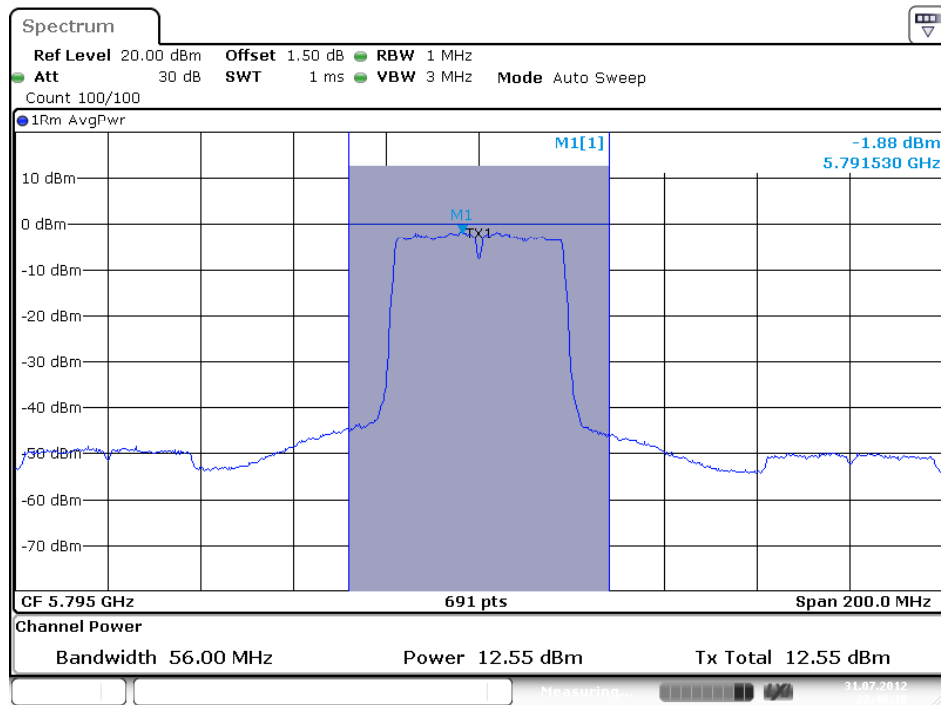

Conducted Output Power Plot on Configuration IEEE 802.11n MCS0 HT40MHz / 5795 MHz/ ANT. 2

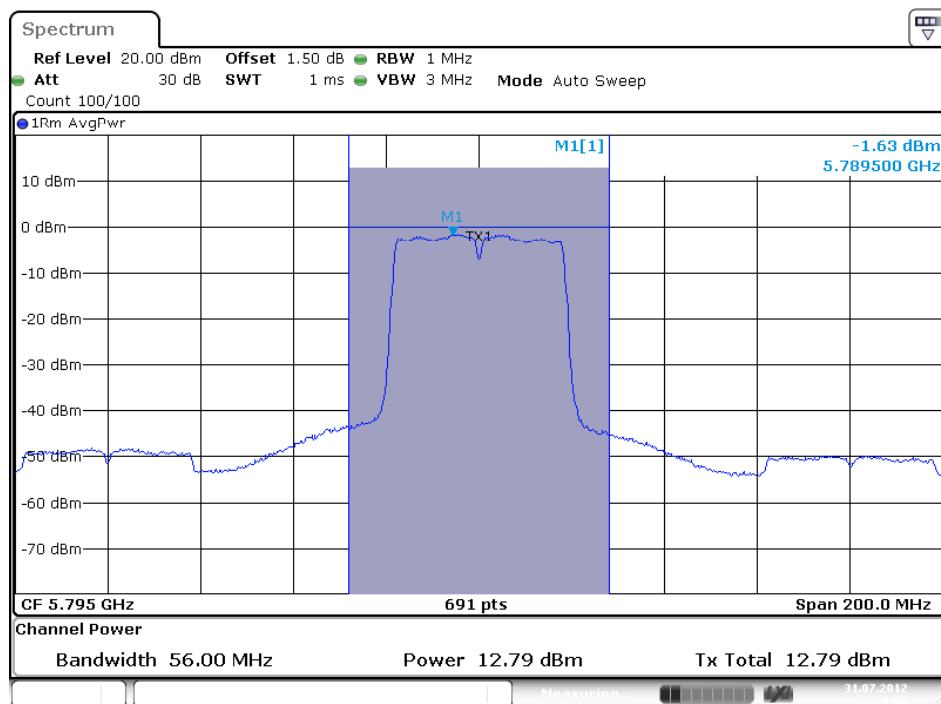

Conducted Output Power Plot on Configuration IEEE 802.11b / 2437 MHz/ ANT. 1

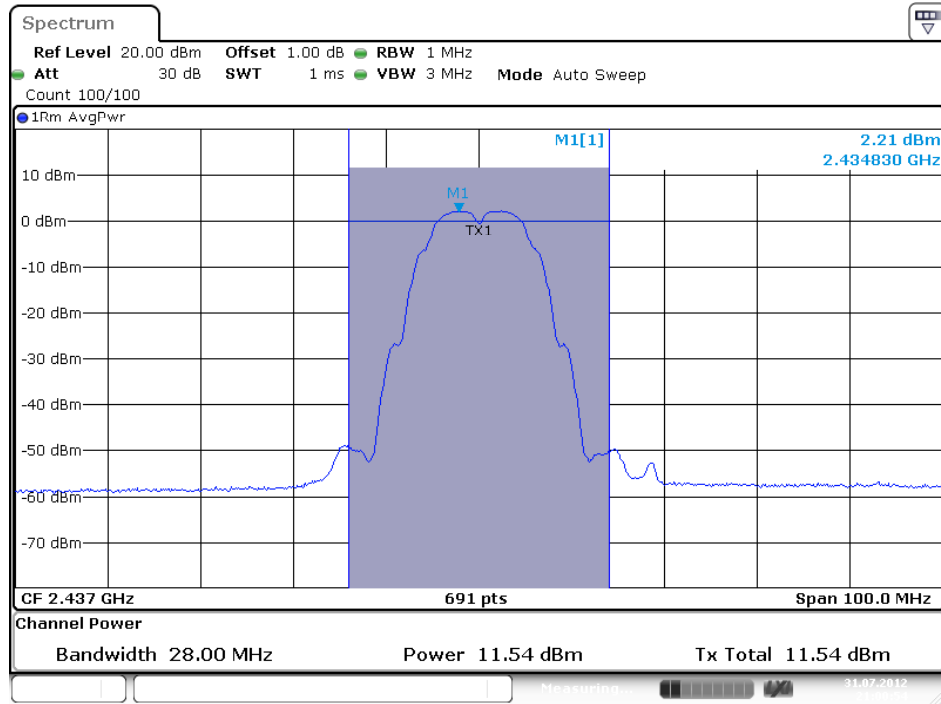

Date: 31.JUL.2012 21:00:53

Conducted Output Power Plot on Configuration IEEE 802.11b / 2437 MHz/ ANT. 2

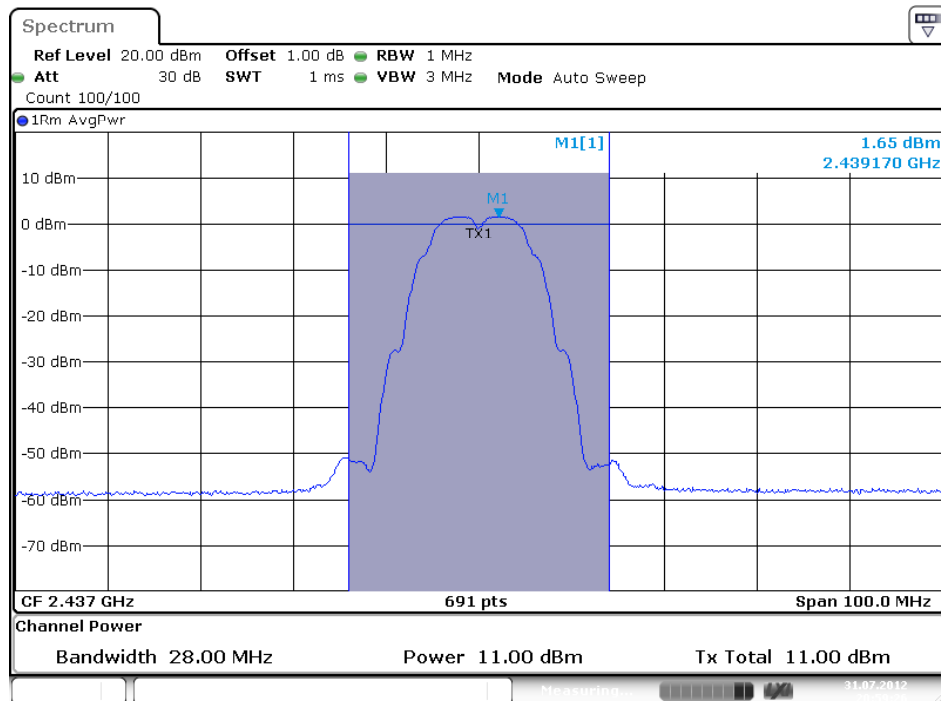

Date: 31.JUL.2012 20:59:26

Conducted Output Power Plot on Configuration IEEE 802.11g / 2437 MHz/ ANT. 1

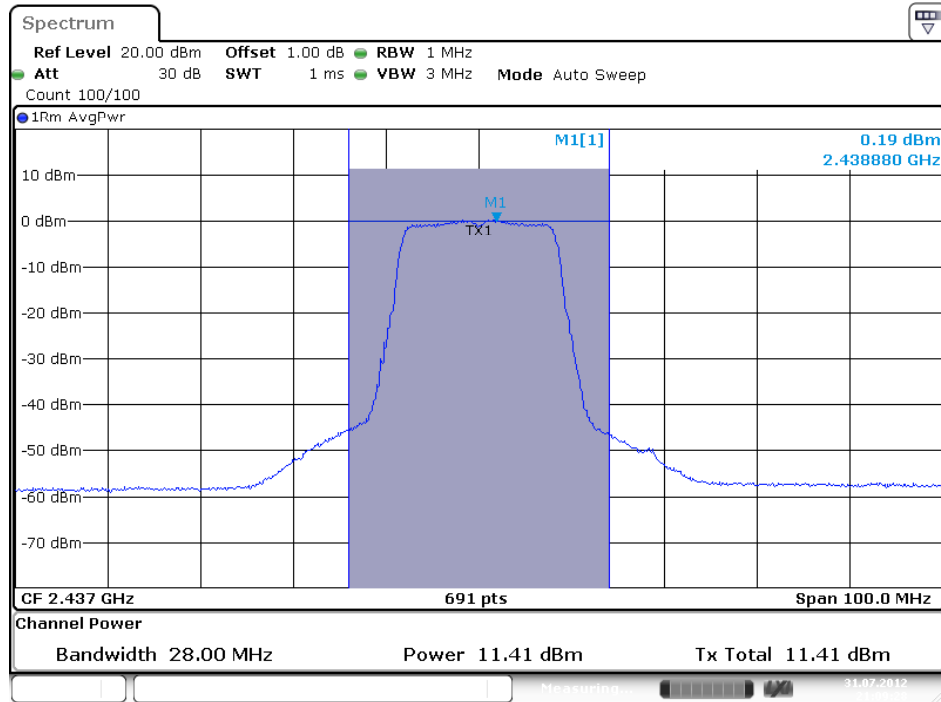

Conducted Output Power Plot on Configuration IEEE 802.11g / 2437 MHz/ ANT. 2

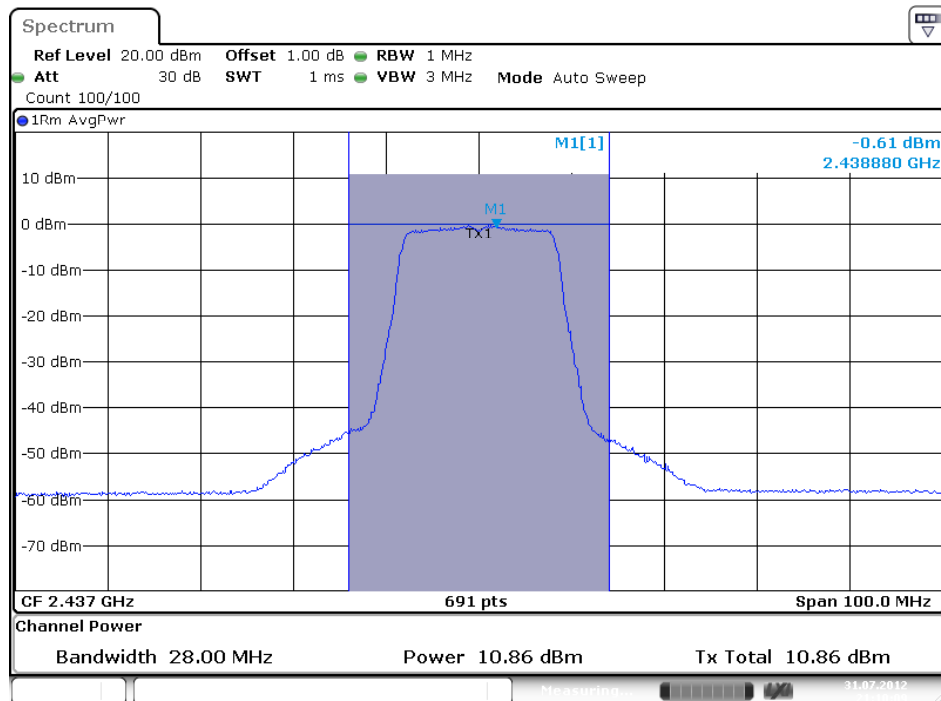

Conducted Output Power Plot on Configuration IEEE 802.11a / 5825 MHz/ ANT. 1

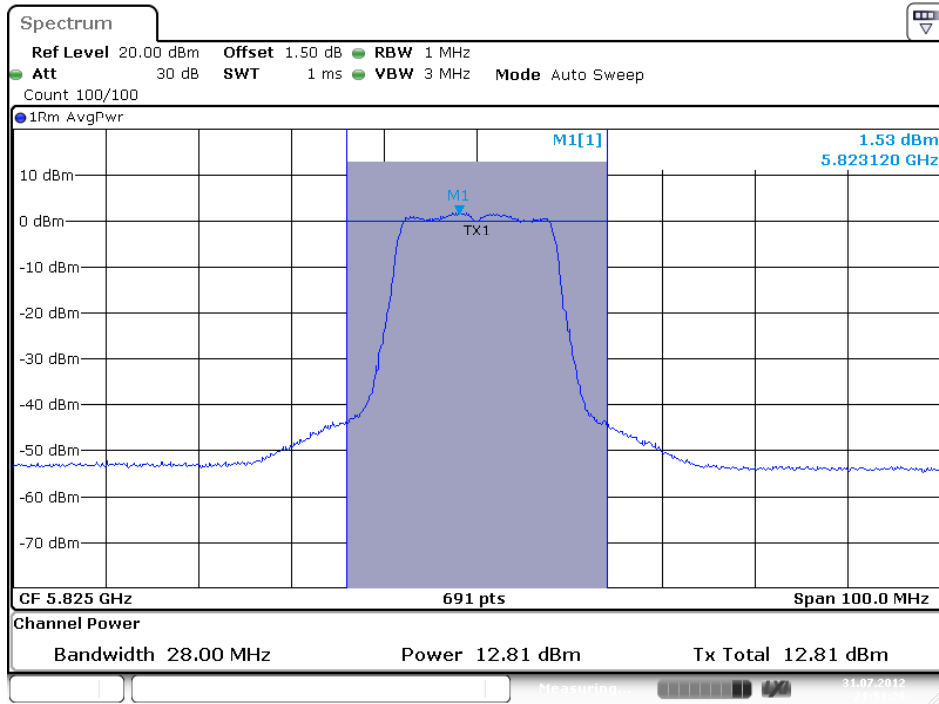

Date: 31.JUL.2012 21:51:28

Conducted Output Power Plot on Configuration IEEE 802.11a / 5825 MHz/ ANT. 2

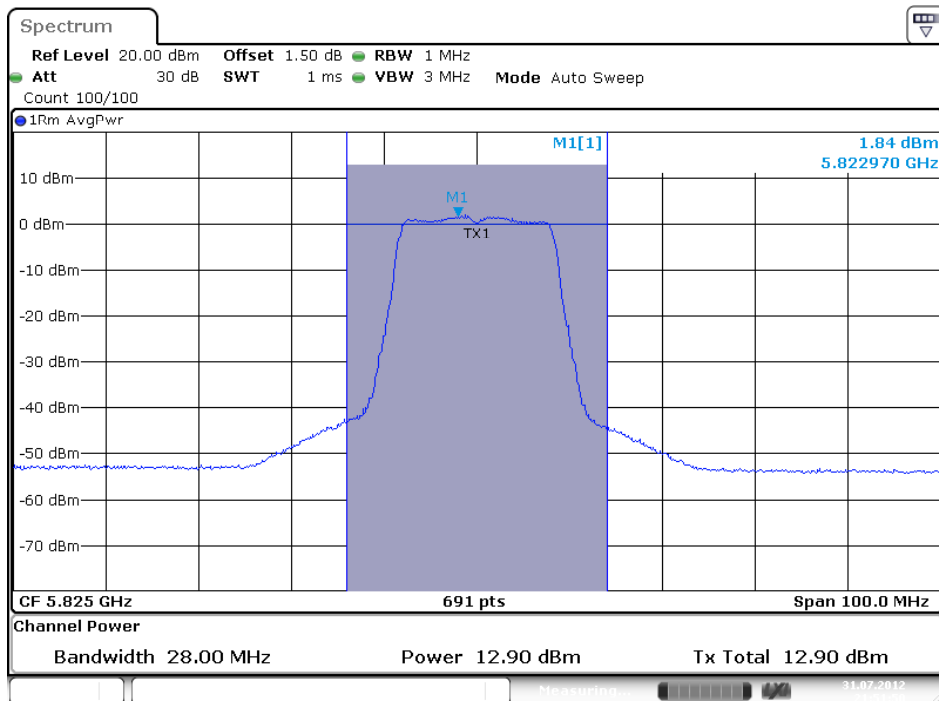

Date: 31.JUL.2012 21:51:49

Conducted Output Power Plot on Configuration IEEE 802.11ac MCS0 VHT 20MHz / 5825 MHz / ANT. 1

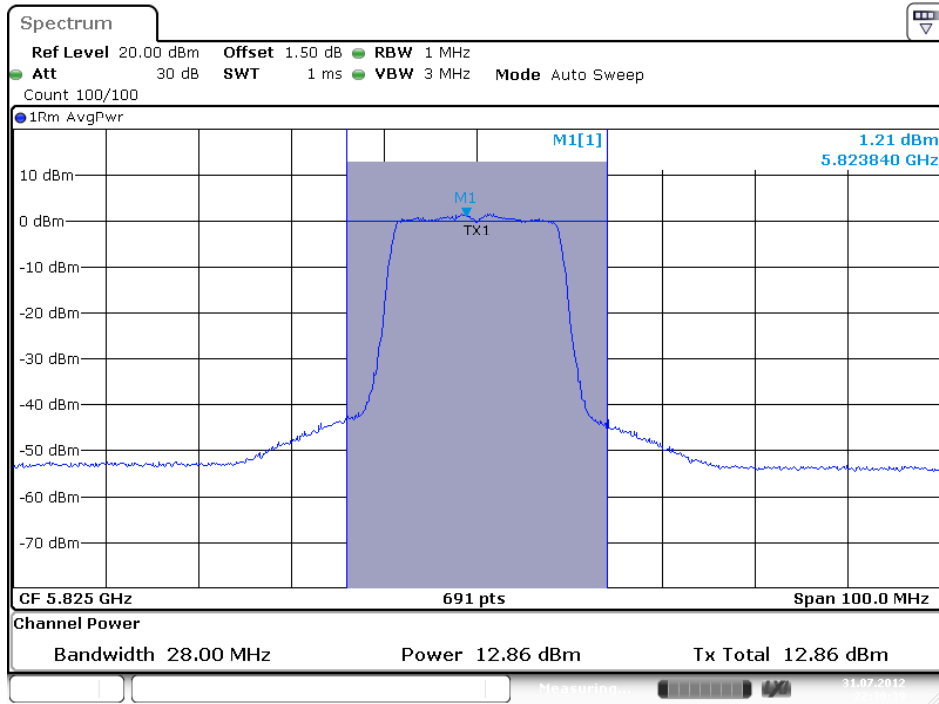

Date: 31.JUL.2012 22:30:39

Conducted Output Power Plot on Configuration IEEE 802.11ac MCS0 VHT 20MHz / 5825MHz / ANT. 2

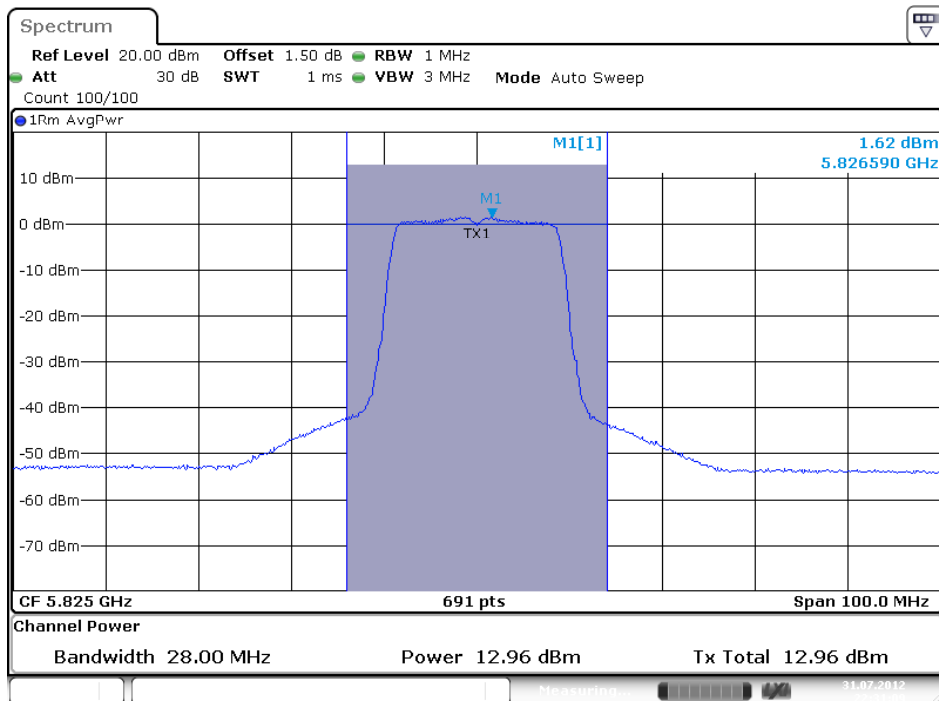

Date: 31.JUL.2012 22:31:09

Conducted Output Power Plot on Configuration IEEE 802.11ac MCS0 VHT 40MHz / 5795 MHz / ANT. 1

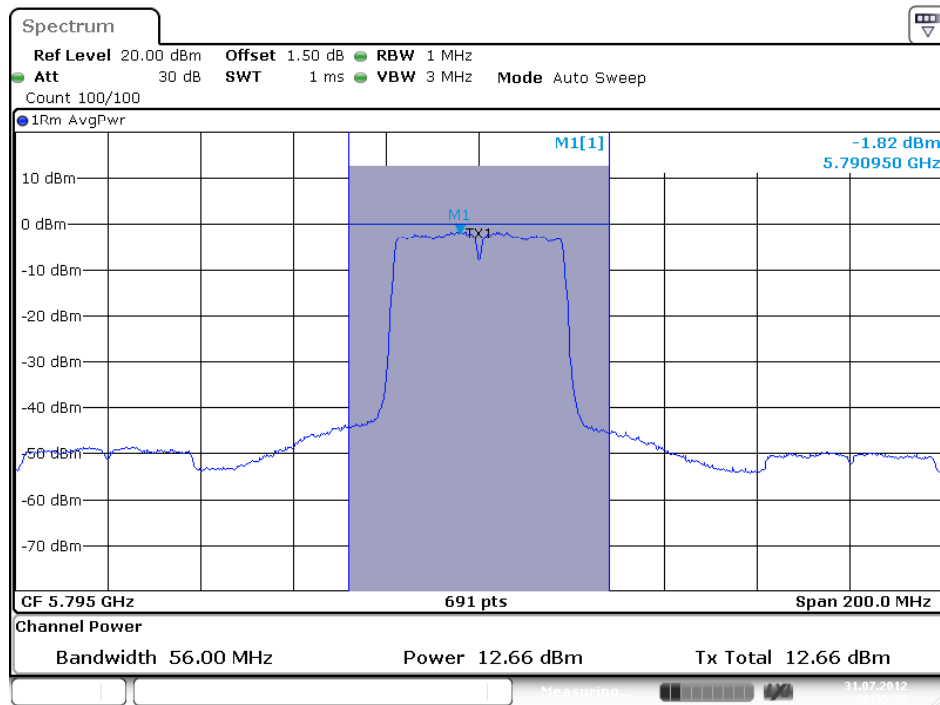

Conducted Output Power Plot on Configuration IEEE 802.11ac MCS0 VHT 40MHz / 5795MHz / ANT. 2

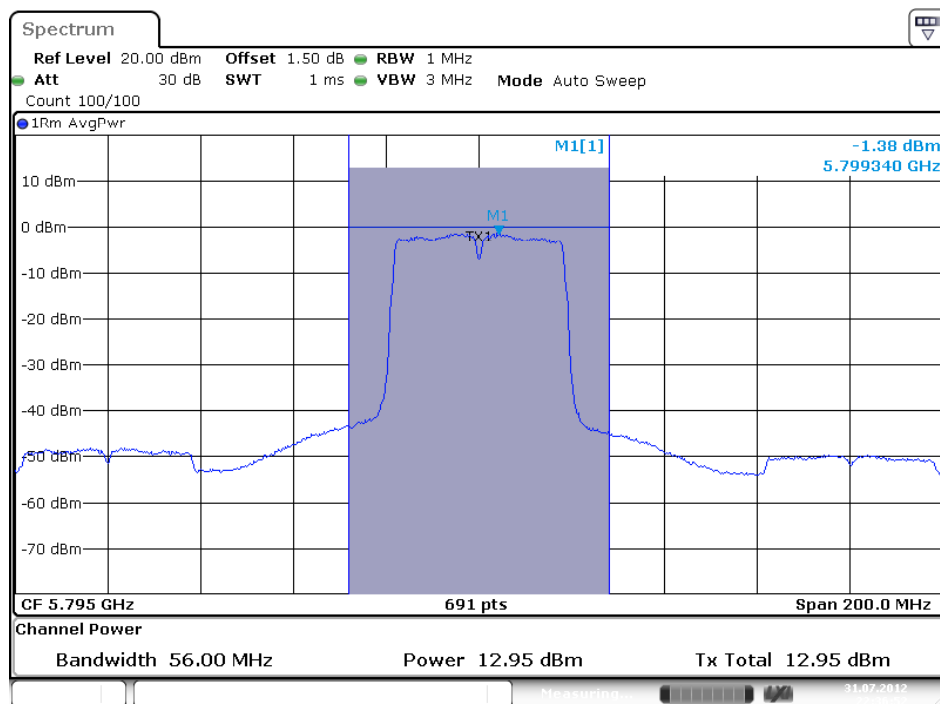

Conducted Output Power Plot on Configuration IEEE 802.11ac MCS0 VHT 80MHz / 5775 MHz / ANT. 1

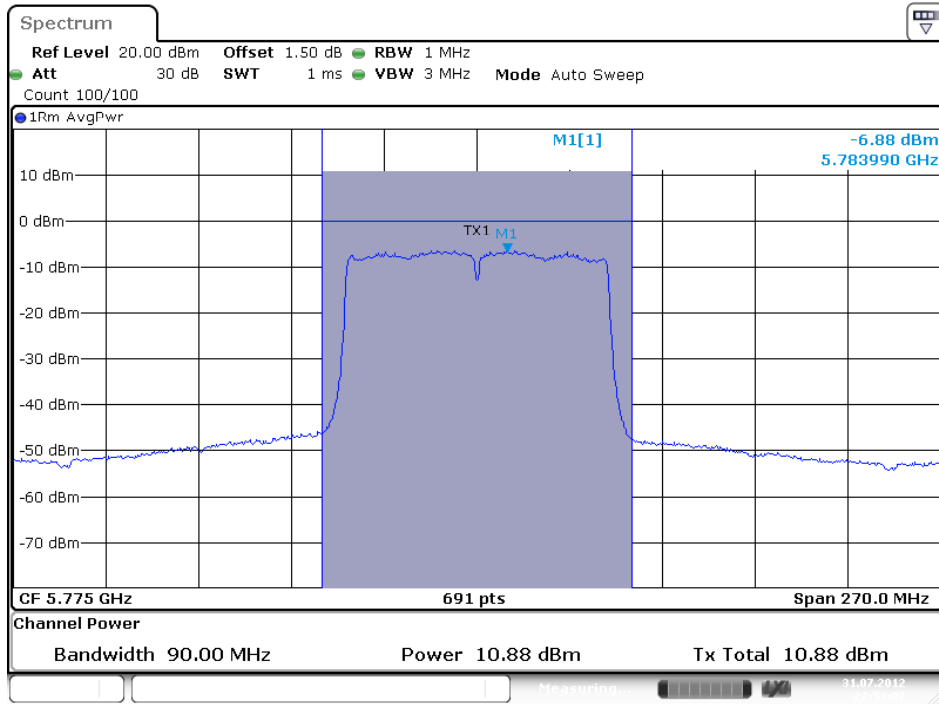

Conducted Output Power Plot on Configuration IEEE 802.11ac MCS0 VHT 80MHz / 5775MHz / ANT. 2

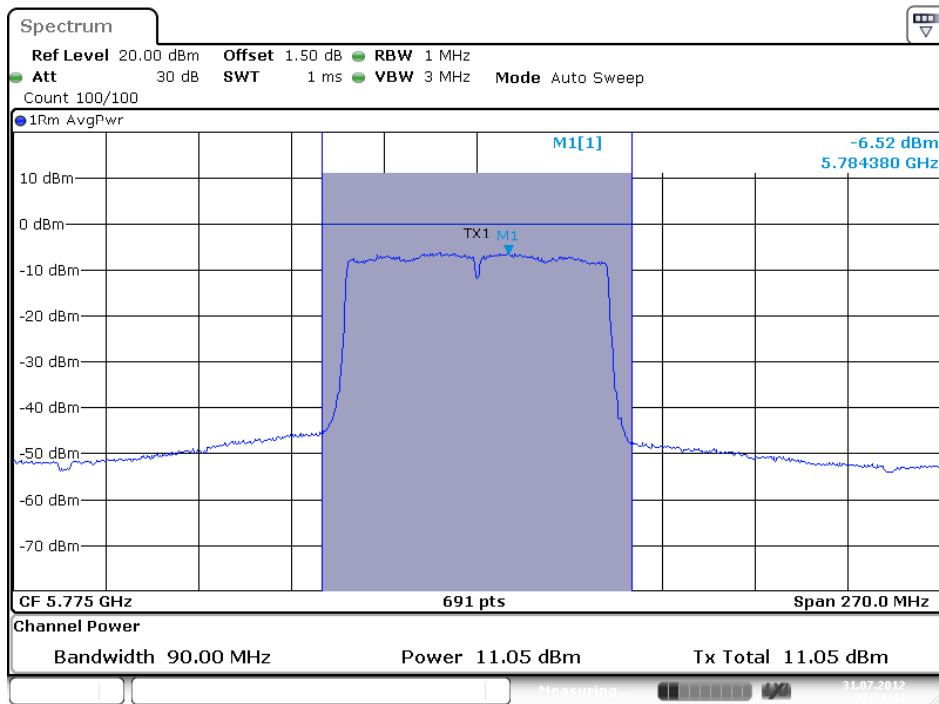

4.3. Power Spectral Density Measurement

4.3.1. Limit

For digitally modulated systems, the power spectral density conducted from the intentional radiator to the antenna shall not be greater than 8dBm in any 3 kHz band during any time interval of continuous transmission.

4.3.2. Measuring Instruments and Setting

Please refer to section 5 of equipments list in this report. The following table is the setting of spectrum analyzer.

Spectrum Parameter	Setting
Attenuation	Auto
Span Frequency	Set the analyzer span to 5-30% greater than the EBW.
RB	100 kHz
VB	300 kHz
Detector	RMS
Trace	Single Sweep
Sweep Time	$\geq 10 \times (\text{number of measurement points in sweep}) \times (\text{transmission symbol period})$.

4.3.3. Test Procedures

1. Test was performed in accordance with KDB 558074 Guidance for Performing Compliance Measurements on Digital Transmission Systems (DTS) Operating Under §15.247 section 5.3.2 Multiple antenna systems was performed in accordance with KDB 662911 in-Band Power Spectral Density (PSD) Measurements(2) Measure and add $10 \log(N)$ dB (as described in the preceding section).
2. Use this procedure when the maximum conducted output power in the fundamental emission is used to demonstrate compliance. The EUT must be configured to transmit continuously at full power over the measurement duration.
3. Ensure that the number of measurement points in the sweep $\geq 2 \times \text{span}/\text{RBW}$ (use of a greater number of measurement points than this minimum requirement is recommended).
4. Use the peak marker function to determine the maximum level in any 100 kHz band segment within the fundamental EBW.
5. Scale the observed power level to an equivalent level in 3 kHz by adjusting (reducing) the measured power by a bandwidth correction factor (BWCF) where: $\text{BWCF} = 10 \log(3 \text{ kHz}/100 \text{ kHz} = -15.2 \text{ dB})$.
6. The resulting PSD level must be $\leq 8 \text{ dBm}$.
7. When measuring power spectral density with multiple antenna systems, add every result of the values by mathematic formula.

4.3.4. Test Setup Layout

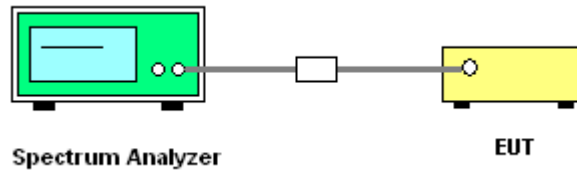

4.3.5. Test Deviation

There is no deviation with the original standard.

4.3.6. EUT Operation during Test

The EUT was programmed to be in continuously transmitting mode.

4.3.7. Test Result of Power Spectral Density

Temperature	26°C	Humidity	61%
Test Engineer	Satoshi Yang	Configurations	IEEE 802.11n / ac

For 2.4GHz Band

Configuration IEEE 802.11n MCS0 HT20MHz / Ant. 1 + Ant. 2

Channel	Frequency	Power Density (dBm/100kHz)		Total Power Density (dBm/100 kHz)	BWCF factor (100KHz to 3KHz)	Total Power Density (dBm/3kHz)	Max. Limit (dBm/3kHz)	Result
		Ant.1	Ant.2					
1	2412 MHz	-4.64	-7.61	-2.87	-15.23	-18.09	8.00	Complies
6	2437 MHz	-4.50	-6.81	-2.49	-15.23	-17.72	8.00	Complies
11	2462 MHz	-3.73	-6.64	-1.94	-15.23	-17.16	8.00	Complies

Configuration IEEE 802.11n MCS0 HT40MHz / Ant. 1 + Ant. 2

Channel	Frequency	Power Density (dBm/100kHz)		Total Power Density (dBm/100 kHz)	BWCF factor (100KHz to 3KHz)	Total Power Density (dBm/3kHz)	Max. Limit (dBm/3kHz)	Result
		Ant.1	Ant.2					
3	2422 MHz	-9.43	-12.37	-7.65	-15.23	-22.87	8.00	Complies
6	2437 MHz	-7.59	-10.42	-5.77	-15.23	-21.00	8.00	Complies
9	2452 MHz	-9.20	-12.06	-7.39	-15.23	-22.62	8.00	Complies

For 5GHz Band

Configuration IEEE 802.11n MCS0 HT20MHz / Ant. 1 + Ant. 2

Channel	Frequency	Power Density (dBm/100kHz)		Total Power Density (dBm/100 kHz)	BWCF factor (100KHz to 3KHz)	Total Power Density (dBm/3kHz)	Max. Limit (dBm/3kHz)	Result
		Ant.1	Ant.2					
149	5745 MHz	-0.31	-1.87	1.99	-15.23	-13.24	8.00	Complies
157	5785 MHz	0.64	0.07	3.37	-15.23	-11.85	8.00	Complies
165	5825 MHz	1.04	-0.01	3.56	-15.23	-11.67	8.00	Complies

Configuration IEEE 802.11n MCS0 HT40MHz / Ant. 1 + Ant. 2

Channel	Frequency	Power Density (dBm/100kHz)		Total Power Density (dBm/100 kHz)	BWCF factor (100KHz to 3KHz)	Total Power Density (dBm/3kHz)	Max. Limit (dBm/3kHz)	Result
		Ant.1	Ant.2					
151	5755 MHz	-5.35	-5.52	-2.42	-15.23	-17.65	8.00	Complies
159	5795 MHz	-1.73	-2.24	1.03	-15.23	-14.20	8.00	Complies

Configuration IEEE 802.11ac MCS0 VHT 80MHz / Ant. 1 + Ant. 2

Channel	Frequency	Power Density (dBm/100kHz)		Total Power Density (dBm/100 kHz)	BWCF factor (100KHz to 3KHz)	Total Power Density (dBm/3kHz)	Max. Limit (dBm/3kHz)	Result
		Ant.1	Ant.2					
155	5775 MHz	-9.58	-9.70	-6.63	-15.23	-21.86	8.00	Complies

Temperature	26°C	Humidity	61%
Test Engineer	Satoshi Yang	Configurations	IEEE 802.11a/b/g

Configuration IEEE 802.11b / Ant. 1 + Ant. 2

Channel	Frequency	Power Density (dBm/100kHz)		Total Power Density (dBm/100 kHz)	BWCF factor (100KHz to 3KHz)	Total Power Density (dBm/3kHz)	Max. Limit (dBm/3kHz)	Result
		Ant.1	Ant.2					
1	2412 MHz	-3.08	-5.81	-1.22	-15.23	-16.45	6.69	Complies
6	2437 MHz	-2.92	-5.63	-1.06	-15.23	-16.29	6.69	Complies
11	2462 MHz	-3.27	-5.95	-1.40	-15.23	-16.62	6.69	Complies

Note: Directional gain = $G_{ANT} + 10 \log(N)$ dBi = 7.31dBi > 6dBi, so the conducted power limit = 8-(7.31dBi-6)=6.69dBm

Configuration IEEE 802.11g / Ant. 1 + Ant. 2

Channel	Frequency	Power Density (dBm/100kHz)		Total Power Density (dBm/100 kHz)	BWCF factor (100KHz to 3KHz)	Total Power Density (dBm/3kHz)	Max. Limit (dBm/3kHz)	Result
		Ant.1	Ant.2					
1	2412 MHz	-4.43	-7.23	-2.60	-15.23	-17.83	6.69	Complies
6	2437 MHz	-3.91	-7.30	-2.27	-15.23	-17.50	6.69	Complies
11	2462 MHz	-3.59	-5.72	-1.52	-15.23	-16.74	6.69	Complies

Note: Directional gain = $G_{ANT} + 10 \log(N)$ dBi = 7.31dBi > 6dBi, so the conducted power limit = 8-(7.31dBi-6)=6.69dBm

Configuration IEEE 802.11a / Ant. 1 + Ant. 2

Channel	Frequency	Power Density (dBm/100kHz)		Total Power Density (dBm/100 kHz)	BWCF factor (100KHz to 3KHz)	Total Power Density (dBm/3kHz)	Max. Limit (dBm/3kHz)	Result
		Ant.1	Ant.2					
149	5745 MHz	0.20	0.00	3.11	-15.23	-12.12	6.69	Complies
157	5785 MHz	0.88	0.77	3.84	-15.23	-11.39	6.69	Complies
165	5825 MHz	1.03	0.41	3.74	-15.23	-11.49	6.69	Complies

Note: Directional gain = $G_{ANT} + 10 \log(N)$ dBi = 7.31dBi > 6dBi, so the conducted power limit = 8-(7.31dBi-6)=6.69dBm

Note: All the test values were listed in the report.

For plots, only the channel with maximum results was shown.

Power Density Plot on Configuration IEEE 802.11n MCS0 HT20MHz / Ant. 1 / 2462 MHz

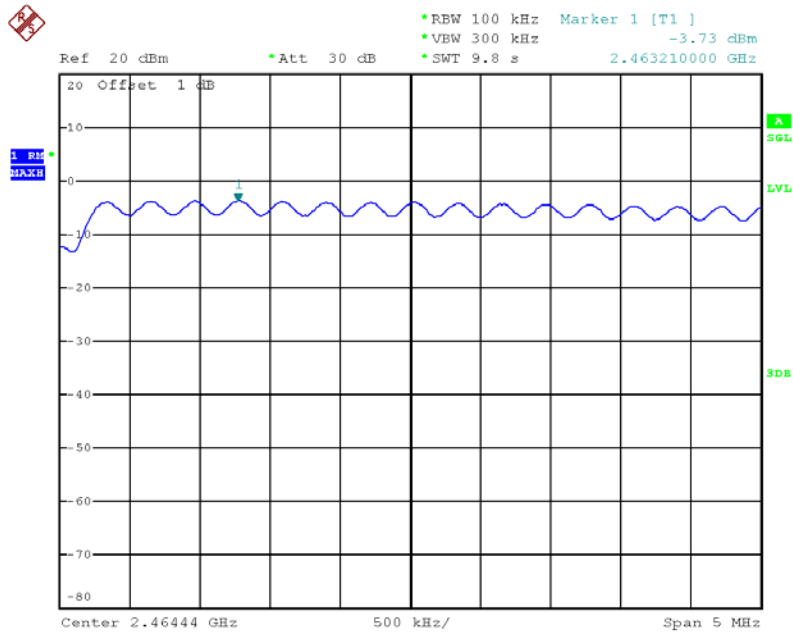

Date: 26.JUN.2012 23:06:12

Power Density Plot on Configuration IEEE 802.11n MCS0 HT20MHz / Ant. 2 / 2462 MHz

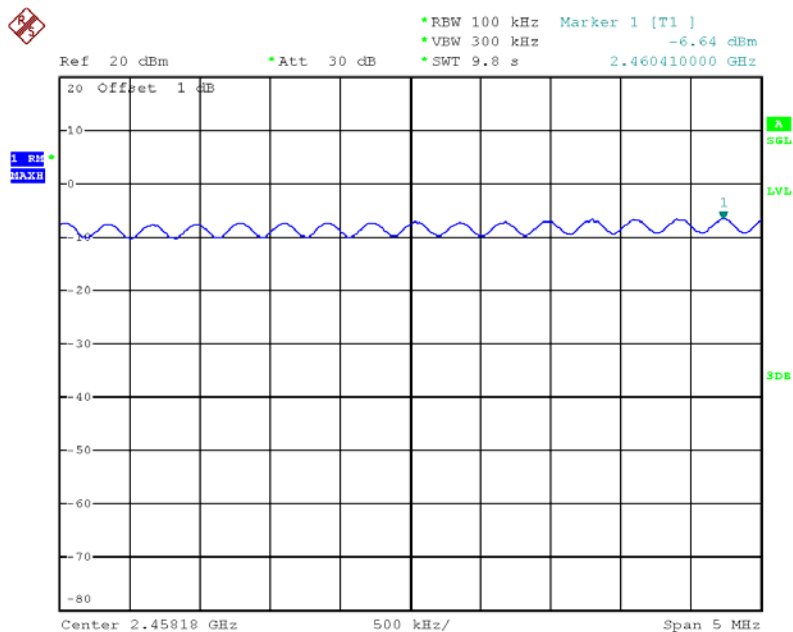

Date: 26.JUN.2012 23:07:02

Power Density Plot on Configuration IEEE 802.11n MCS0 HT40MHz / Ant. 1 / 2437 MHz

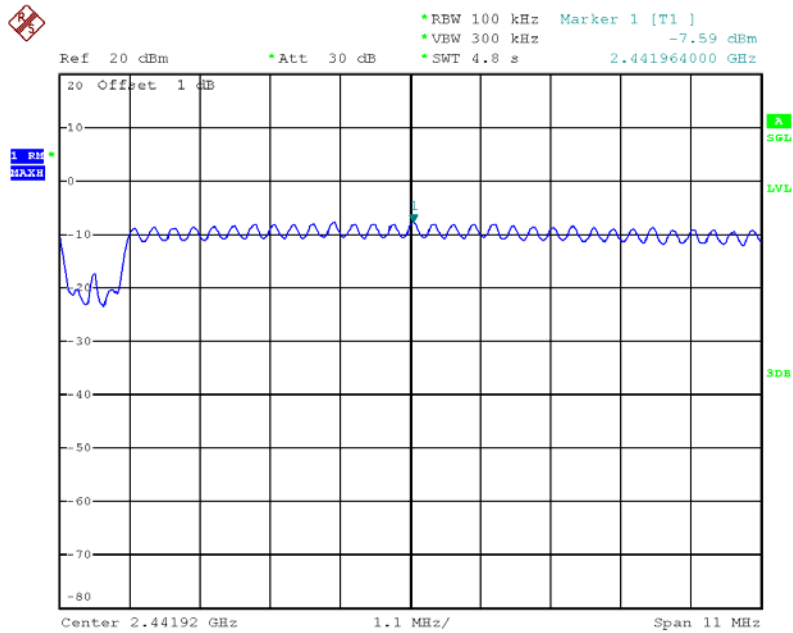

Date: 26.JUN.2012 23:11:35

Power Density Plot on Configuration IEEE 802.11n MCS0 HT40MHz / Ant. 2 / 2437 MHz

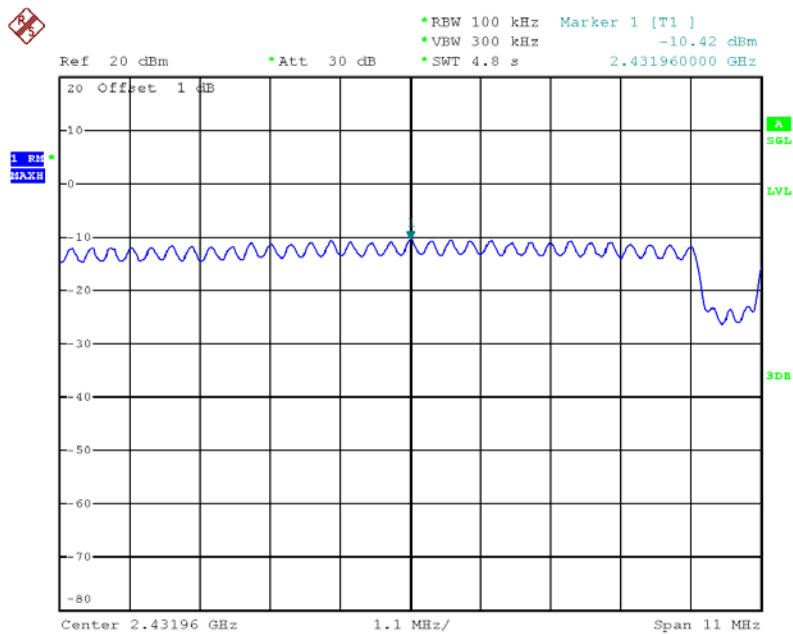

Date: 26.JUN.2012 23:12:27

Power Density Plot on Configuration IEEE 802.11n MCS0 HT20MHz / Ant. 1 / 5825 MHz

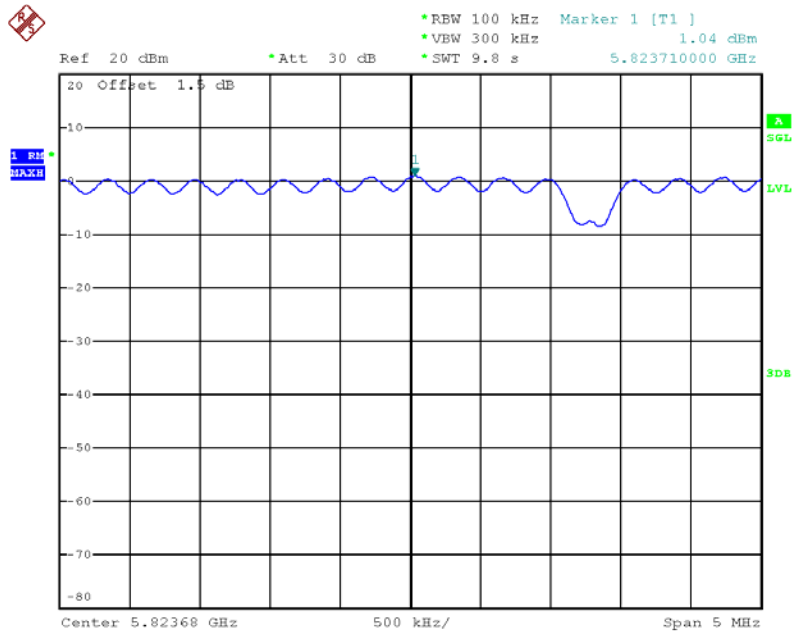

Date: 26.JUN.2012 23:32:11

Power Density Plot on Configuration IEEE 802.11n MCS0 HT20MHz / Ant. 2 / 5825 MHz

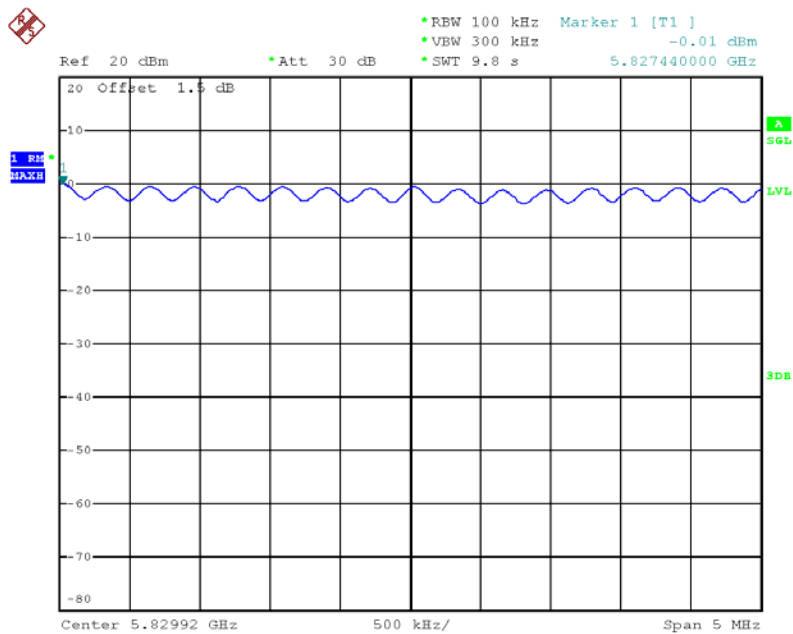

Date: 26.JUN.2012 23:31:29

Power Density Plot on Configuration IEEE 802.11n MCS0 HT40MHz / Ant. 1 / 5795 MHz

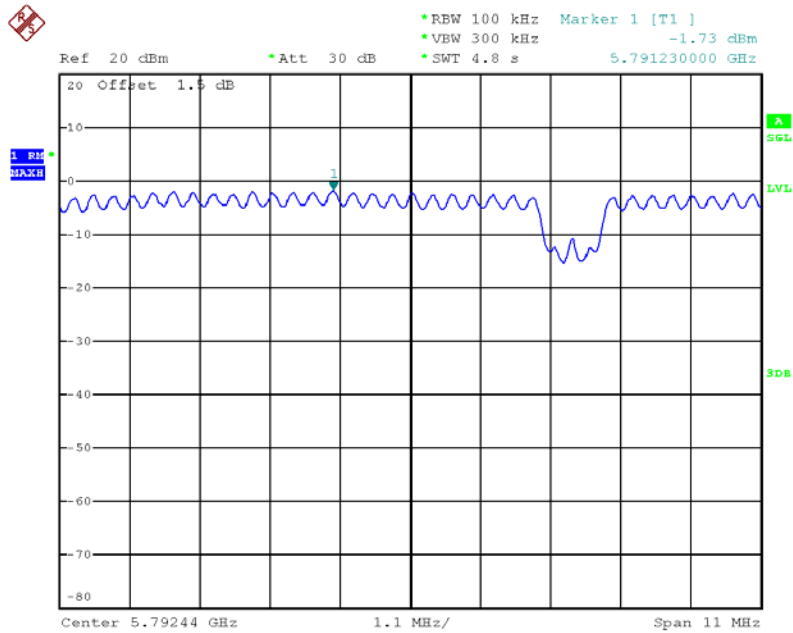

Date: 26.JUN.2012 23:37:02

Power Density Plot on Configuration IEEE 802.11n MCS0 HT40MHz / Ant. 2 / 5795 MHz

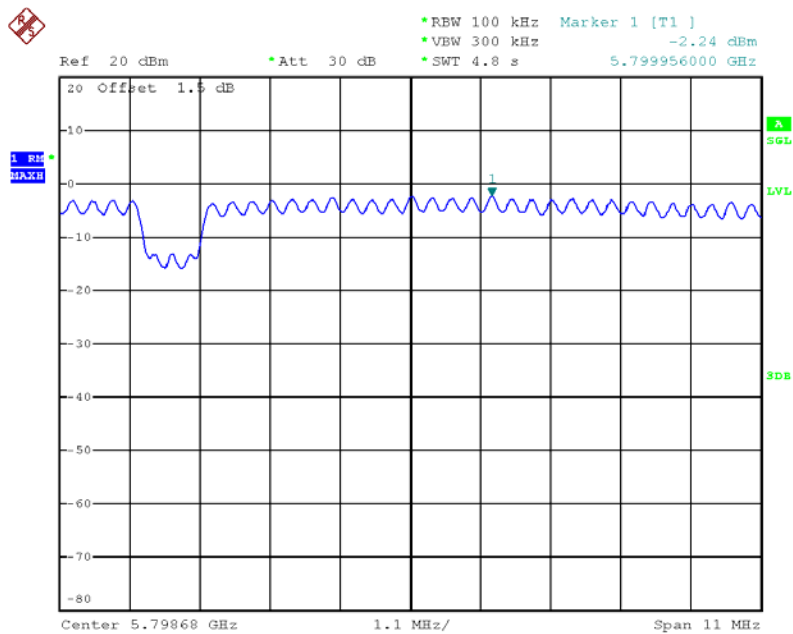

Date: 26.JUN.2012 23:36:14

Power Density Plot on Configuration IEEE 802.11b / Ant. 1 / 2437 MHz

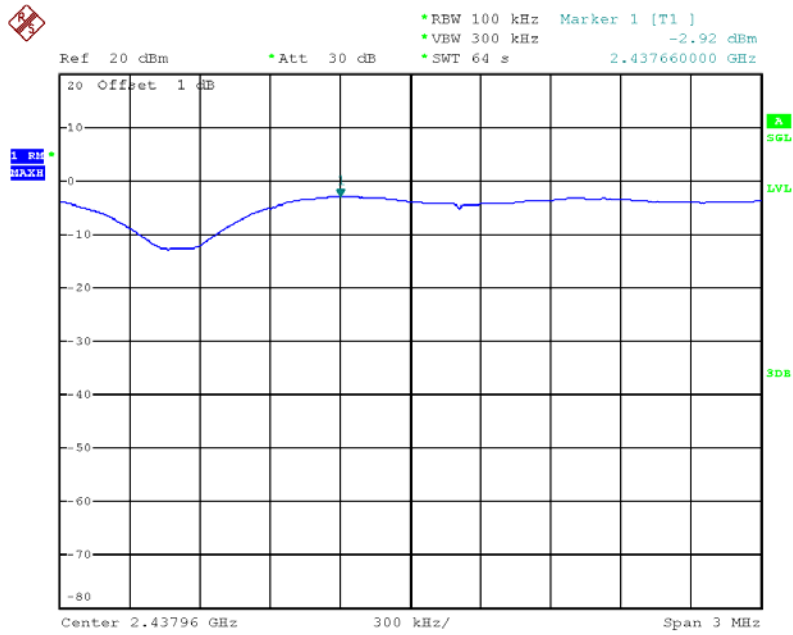

Date: 6.JUL.2012 22:07:38

Power Density Plot on Configuration IEEE 802.11b / Ant. 2 / 2437 MHz

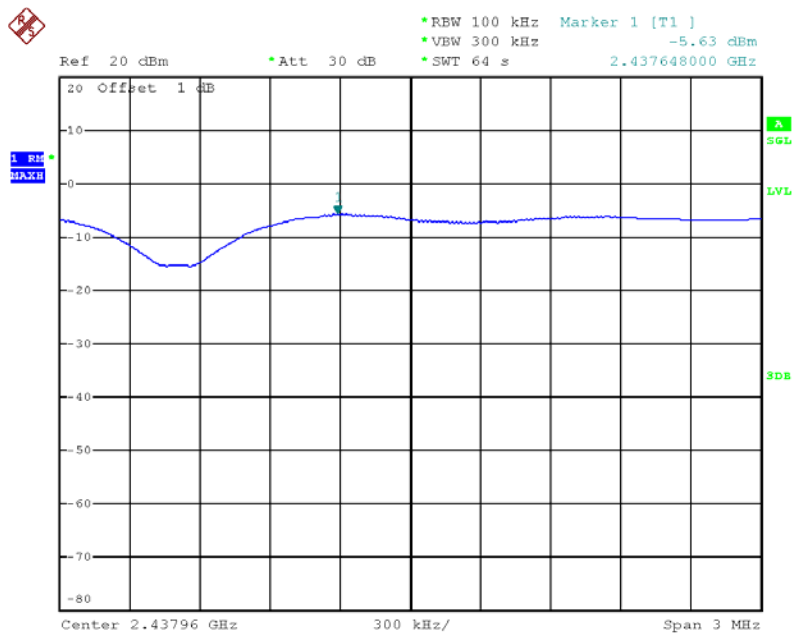

Date: 6.JUL.2012 22:09:12

Power Density Plot on Configuration IEEE 802.11g / Ant. 1 / 2462 MHz

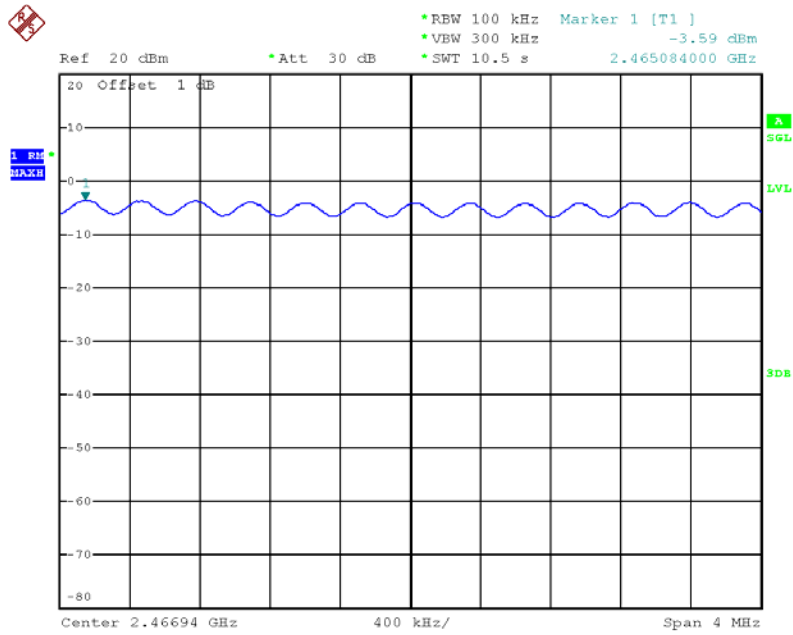

Date: 26.JUN.2012 23:00:01

Power Density Plot on Configuration IEEE 802.11g / Ant. 2 / 2462 MHz

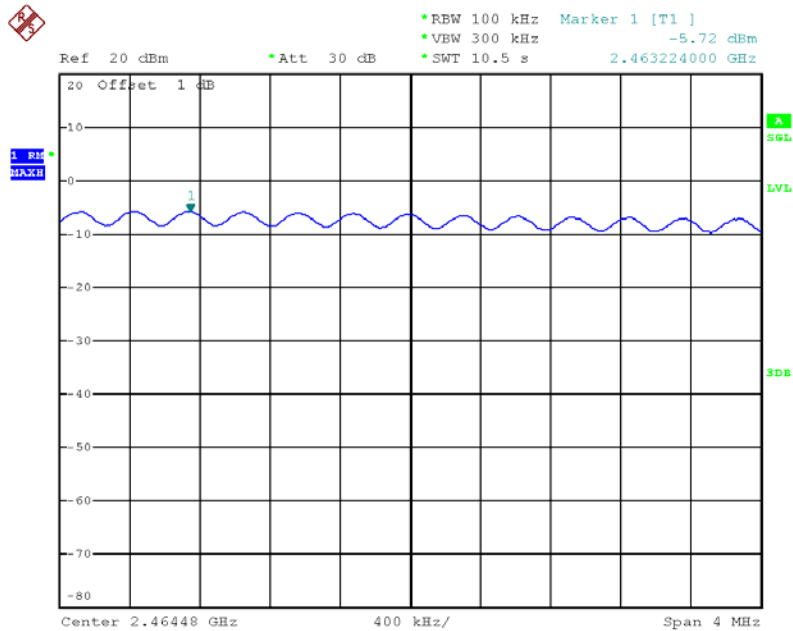

Date: 26.JUN.2012 22:59:11

Power Density Plot on Configuration IEEE 802.11a / Ant. 1 / 5785 MHz

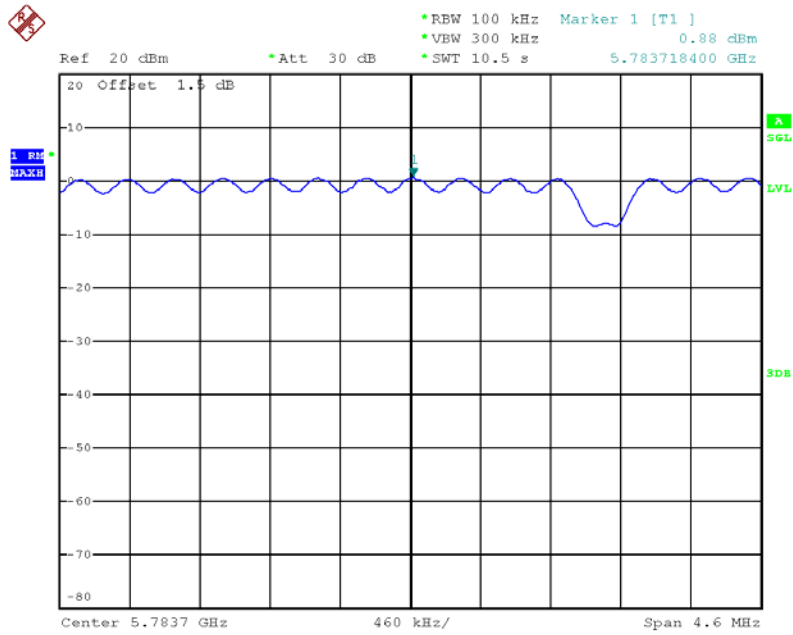

Date: 26.JUN.2012 23:23:23

Power Density Plot on Configuration IEEE 802.11a / Ant. 2 / 5785 MHz

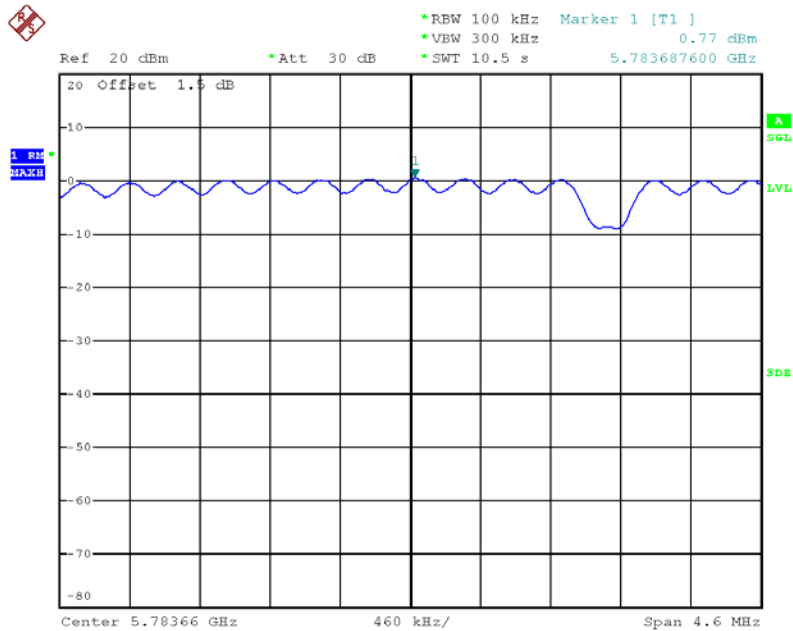

Date: 26.JUN.2012 23:22:35

Power Density Plot on Configuration IEEE 802.11ac MCS0 VHT 80MHz / Ant. 1 / 5775 MHz

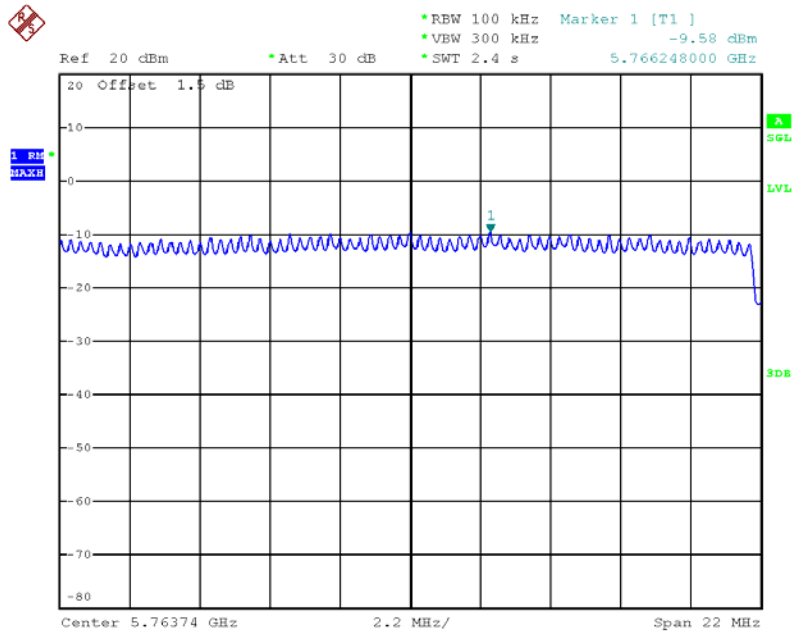

Date: 26.JUN.2012 23:52:56

Power Density Plot on Configuration IEEE 802.11ac MCS0 VHT 80MHz / Ant. 2 / 5775 MHz

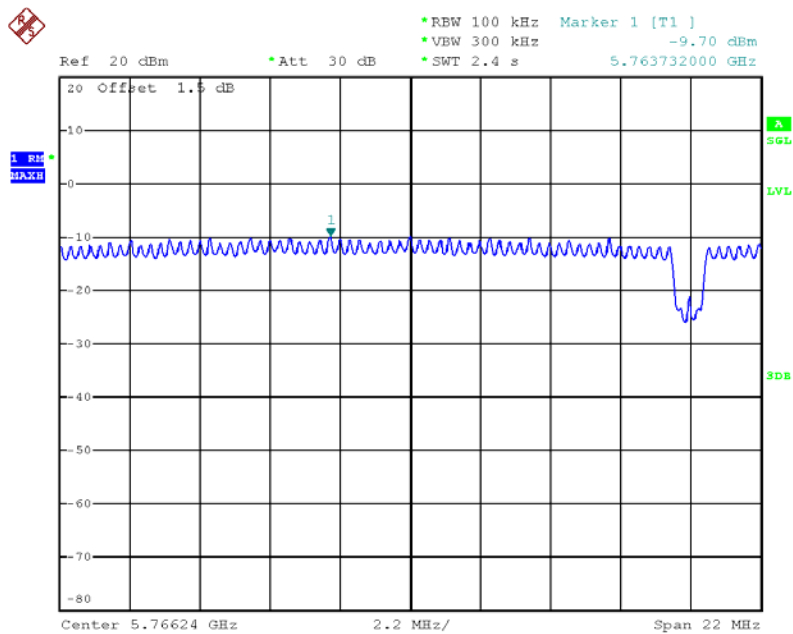

Date: 26.JUN.2012 23:52:04

4.4. 6dB Spectrum Bandwidth Measurement

4.4.1. Limit

For digital modulation systems, the minimum 6dB bandwidth shall be at least 500 kHz.

4.4.2. Measuring Instruments and Setting

Please refer to section 5 of equipments list in this report. The following table is the setting of spectrum analyzer.

Spectrum Parameters	Setting
Attenuation	Auto
Span Frequency	> 6dB Bandwidth
RB	1-5 % of the emission bandwidth (EBW)
VB	$\geq 3 \times RBW$
Detector	Peak
Trace	Max Hold
Sweep Time	Auto

4.4.3. Test Procedures

1. The transmitter output (antenna port) was connected to the spectrum analyzer in peak hold mode.
2. Test was performed in accordance with KDB 558074 Guidance for Performing Compliance Measurements on Digital Transmission Systems (DTS) Operating Under §15.247 section 5.1.1 EBW Measurement Procedure
3. Multiple antenna systems was performed in accordance with KDB 662911 Emissions Testing of Transmitters with Multiple Outputs in the Same Band.
4. Measured the spectrum width with power higher than 6dB below carrier.

4.4.4. Test Setup Layout

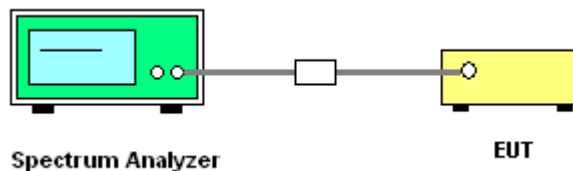

4.4.5. Test Deviation

There is no deviation with the original standard.

4.4.6. EUT Operation during Test

The EUT was programmed to be in continuously transmitting mode.

4.4.7. Test Result of 6dB Spectrum Bandwidth

Temperature	26°C	Humidity	61%
Test Engineer	Satoshi Yang	Configurations	IEEE 802.11n/ac

For 2.4GHz Band

Configuration IEEE 802.11n MCS0 HT20MHz / Ant. 1 + Ant. 2

Channel	Frequency	6dB Bandwidth (MHz)	99% Occupied Bandwidth (MHz)	Min. Limit (kHz)	Test Result
1	2412 MHz	16.80	17.52	500	Complies
6	2437 MHz	17.04	17.36	500	Complies
11	2462 MHz	16.80	17.52	500	Complies

Configuration IEEE 802.11n MCS0 HT40MHz / Ant. 1 + Ant. 2

Channel	Frequency	6dB Bandwidth (MHz)	99% Occupied Bandwidth (MHz)	Min. Limit (kHz)	Test Result
3	2422 MHz	36.84	36.96	500	Complies
6	2437 MHz	36.84	37.08	500	Complies
9	2452 MHz	36.72	36.96	500	Complies

For 5GHz Band

Configuration IEEE 802.11n MCS0 HT20MHz / Ant. 1 + Ant. 2

Channel	Frequency	6dB Bandwidth (MHz)	99% Occupied Bandwidth (MHz)	Min. Limit (kHz)	Test Result
149	5745 MHz	16.88	20.00	500	Complies
157	5785 MHz	16.88	25.76	500	Complies
165	5825 MHz	16.80	26.00	500	Complies

Configuration IEEE 802.11n MCS0 HT40MHz / Ant. 1 + Ant. 2

Channel	Frequency	6dB Bandwidth (MHz)	99% Occupied Bandwidth (MHz)	Min. Limit (kHz)	Test Result
151	5755 MHz	34.48	37.20	500	Complies
159	5795 MHz	36.36	45.24	500	Complies

Configuration IEEE 802.11ac MCS0 VHT 80MHz / Ant. 1 + Ant. 2

Channel	Frequency	6dB Bandwidth (MHz)	99% Occupied Bandwidth (MHz)	Min. Limit (kHz)	Test Result
155	5775 MHz	76.60	76.40	500	Complies

Temperature	26°C	Humidity	61%
Test Engineer	Satoshi Yang	Configurations	IEEE 802.11a/b/g

Configuration IEEE 802.11b / Ant. 1 + Ant. 2

Channel	Frequency	6dB Bandwidth (MHz)	99% Occupied Bandwidth (MHz)	Min. Limit (kHz)	Test Result
1	2412 MHz	10.24	13.20	500	Complies
6	2437 MHz	10.32	13.28	500	Complies
11	2462 MHz	10.24	13.20	500	Complies

Configuration IEEE 802.11g / Ant. 1 + Ant. 2

Channel	Frequency	6dB Bandwidth (MHz)	99% Occupied Bandwidth (MHz)	Min. Limit (kHz)	Test Result
1	2412 MHz	13.76	16.32	500	Complies
6	2437 MHz	13.44	16.40	500	Complies
11	2462 MHz	13.76	16.32	500	Complies

Configuration IEEE 802.11a / Ant. 1 + Ant. 2

Channel	Frequency	6dB Bandwidth (MHz)	99% Occupied Bandwidth (MHz)	Min. Limit (kHz)	Test Result
149	5745 MHz	15.60	21.12	500	Complies
157	5785 MHz	15.68	25.04	500	Complies
165	5825 MHz	15.76	26.00	500	Complies

6 dB Bandwidth Plot on Configuration IEEE 802.11n MCS0 HT20MHz / Ant. 1 + Ant. 2 / 2412 MHz

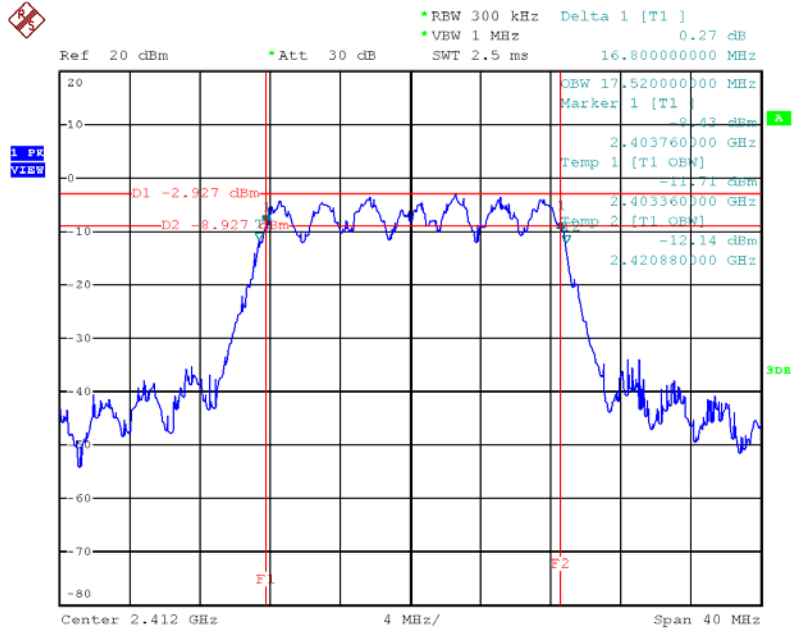

Date: 26.JUN.2012 21:54:05

6 dB Bandwidth Plot on Configuration IEEE 802.11n MCS0 HT40MHz / Ant. 1 + Ant. 2 / 2452 MHz

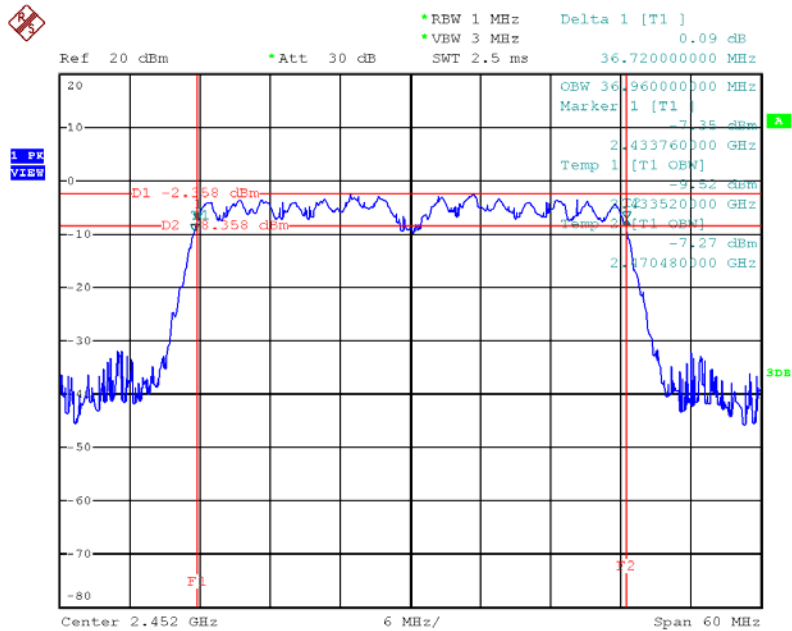

Date: 26.JUN.2012 21:59:10

6 dB Bandwidth Plot on Configuration IEEE 802.11n MCS0 HT20MHz / Ant. 1 + Ant. 2 / 5825 MHz

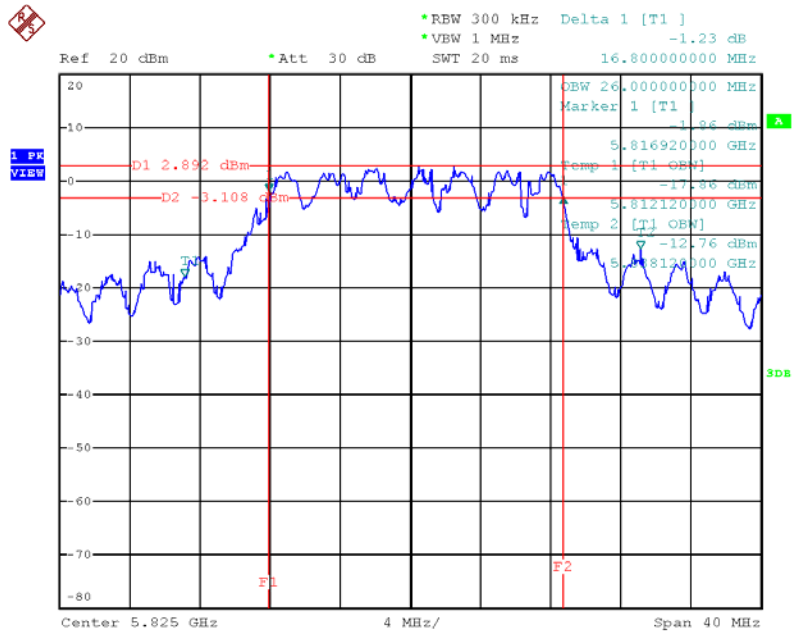

Date: 26.JUN.2012 22:04:58

6 dB Bandwidth Plot on Configuration IEEE 802.11n MCS0 HT40MHz / Ant. 1 + Ant. 2 / 5755 MHz

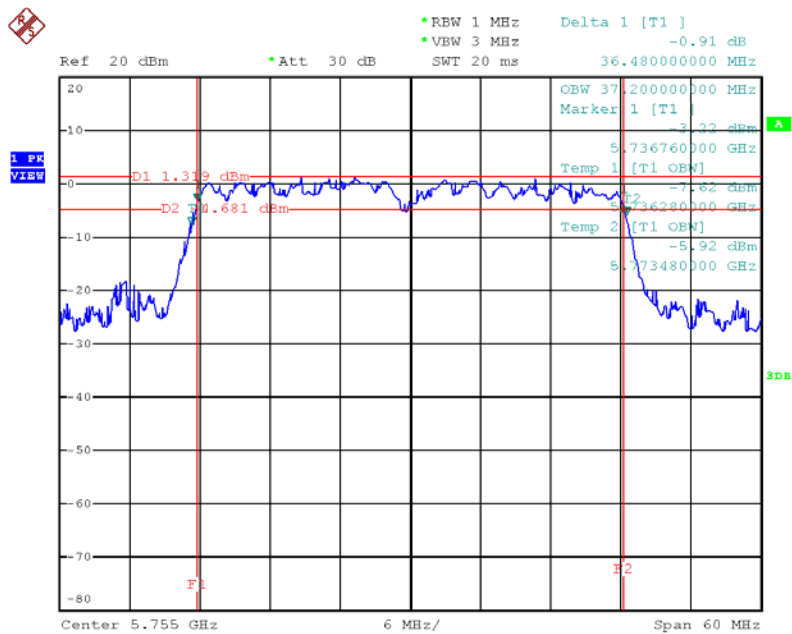

Date: 26.JUN.2012 22:08:50

6 dB Bandwidth Plot on Configuration IEEE 802.11b / Ant. 1 + Ant. 2 / 2412 MHz

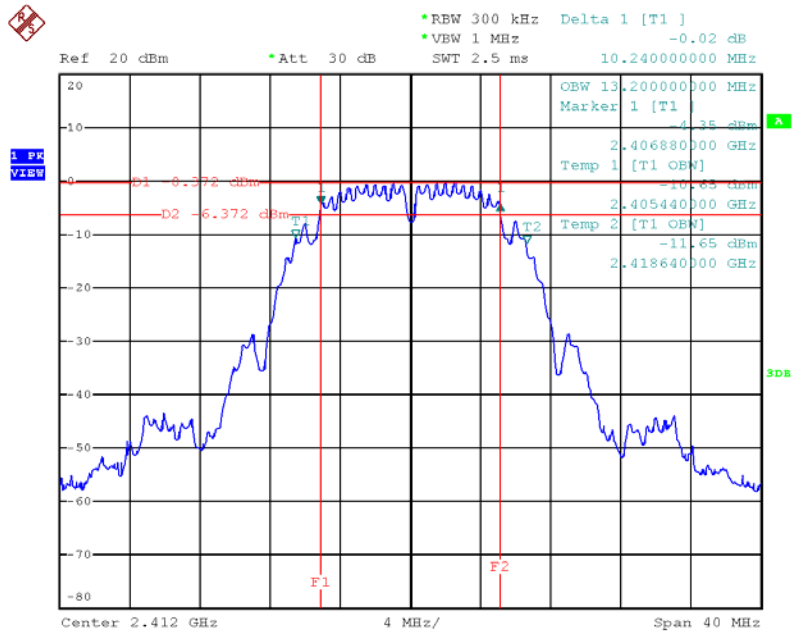

Date: 26.JUN.2012 21:46:59

6 dB Bandwidth Plot on Configuration IEEE 802.11g / Ant. 1 + Ant. 2 / 2437 MHz

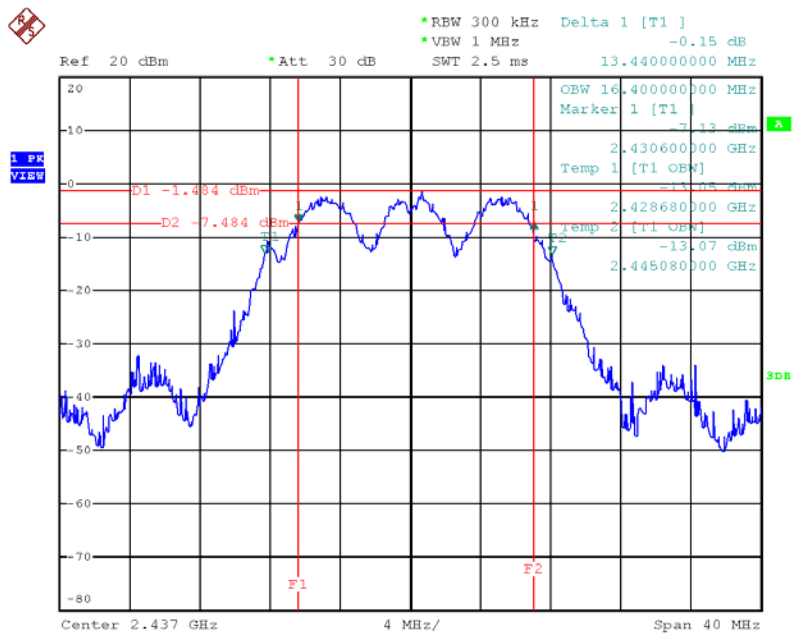

Date: 26.JUN.2012 21:51:46

6 dB Bandwidth Plot on Configuration IEEE 802.11a / Ant. 1 + Ant. 2 / 5745 MHz

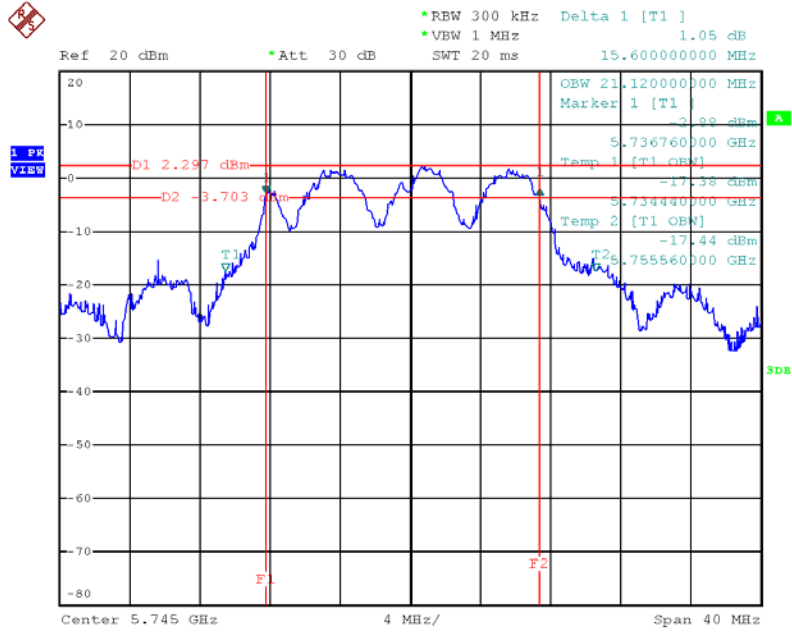

Date: 26.JUN.2012 22:00:43

6 dB Bandwidth Plot on Configuration IEEE 802.11ac MCS0 VHT 80MHz / Ant. 1 + Ant. 2 / 5775 MHz

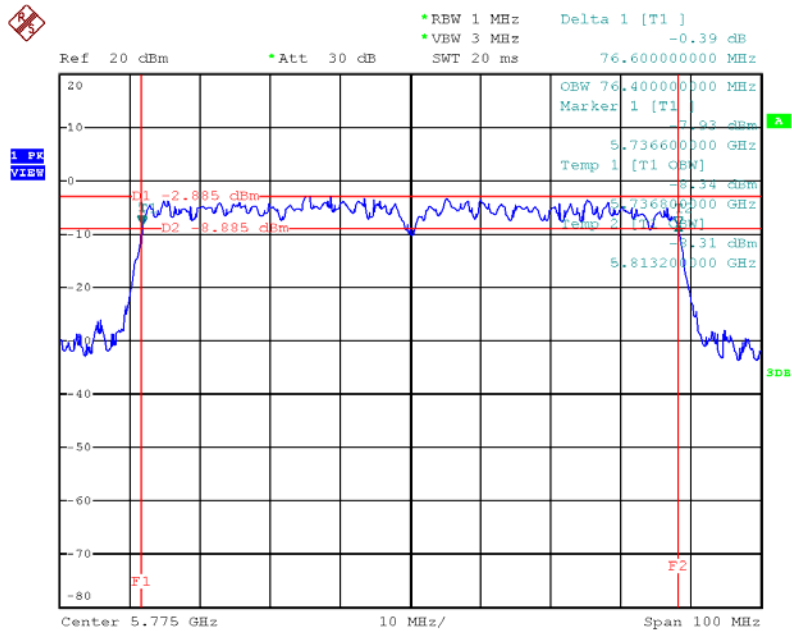

Date: 26.JUN.2012 22:19:08

4.5. Radiated Emissions Measurement

4.5.1. Limit

30dBc in any 100 kHz bandwidth outside the operating frequency band. In case the emission fall within the restricted band specified on 15.205(a), then the 15.209(a) limit in the table below has to be followed.

Frequencies (MHz)	Field Strength (microvolts/meter)	Measurement Distance (meters)
0.009~0.490	2400/F(KHz)	300
0.490~1.705	24000/F(KHz)	30
1.705~30.0	30	30
30~88	100	3
88~216	150	3
216~960	200	3
Above 960	500	3

4.5.2. Measuring Instruments and Setting

Please refer to section 5 of equipments list in this report. The following table is the setting of spectrum analyzer and receiver.

Spectrum Parameter	Setting
Attenuation	Auto
Start Frequency	1GHz
Stop Frequency	10th carrier harmonic
RB / VB (Emission in restricted band)	1MHz / 3MHz for Peak, 1MHz / 10Hz for Average
RB / VB (Emission in non-restricted band)	1MHz / 3MHz for peak

Receiver Parameter	Setting
Attenuation	Auto
Start ~ Stop Frequency	9kHz~150kHz / RB 200Hz for QP
Start ~ Stop Frequency	150kHz~30MHz / RB 9kHz for QP
Start ~ Stop Frequency	30MHz~1GHz / RB 120kHz for QP

4.5.3. Test Procedures

1. Configure the EUT according to ANSI C63.10. The EUT was placed on the top of the turntable 0.8 meter above ground. The phase center of the receiving antenna mounted on the top of a height-variable antenna tower was placed 3 meters far away from the turntable.
2. Power on the EUT and all the supporting units. The turntable was rotated by 360 degrees to determine the position of the highest radiation.
3. The height of the broadband receiving antenna was varied between one meter and four meters above ground to find the maximum emissions field strength of both horizontal and vertical polarization.
4. For each suspected emissions, the antenna tower was scan (from 1 M to 4 M) and then the turntable was rotated (from 0 degree to 360 degrees) to find the maximum reading.
5. Set the test-receiver system to Peak or CISPR quasi-peak Detect Function with specified bandwidth under Maximum Hold Mode.
6. For emissions above 1GHz, use 1MHz VBW and 3MHz RBW for peak reading. Then 1MHz RBW and 10Hz VBW for average reading in spectrum analyzer.
7. When the radiated emissions limits are expressed in terms of the average value of the emissions, and pulsed operation is employed, the measurement field strength shall be determined by averaging over one complete pulse train, including blanking intervals, as long as the pulse train does not exceed 0.1 seconds. As an alternative (provided the transmitter operates for longer than 0.1 seconds) or in cases where the pulse train exceeds 0.1 seconds, the measured field strength shall be determined from the average absolute voltage during a 0.1 second interval during which the field strength is at its maximum value.
8. If the emissions level of the EUT in peak mode was 3 dB lower than the average limit specified, then testing will be stopped and peak values of EUT will be reported, otherwise, the emissions which do not have 3 dB margin will be repeated one by one using the quasi-peak method for below 1GHz.
9. For testing above 1GHz, the emissions level of the EUT in peak mode was lower than average limit (that means the emissions level in peak mode also complies with the limit in average mode), then testing will be stopped and peak values of EUT will be reported, otherwise, the emissions will be measured in average mode again and reported.
10. In case the emission is lower than 30MHz, loop antenna has to be used for measurement and the recorded data should be QP measured by receiver. High – Low scan is not required in this case.

4.5.4. Test Setup Layout

For radiated emissions below 1GHz

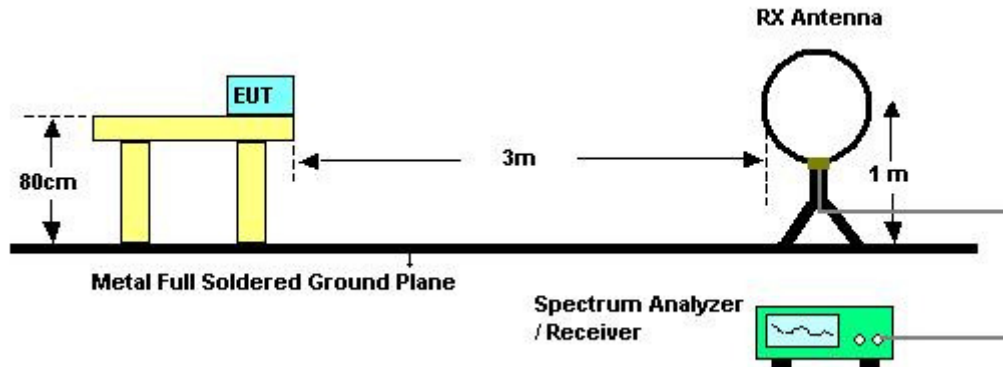

For radiated emissions above 1GHz

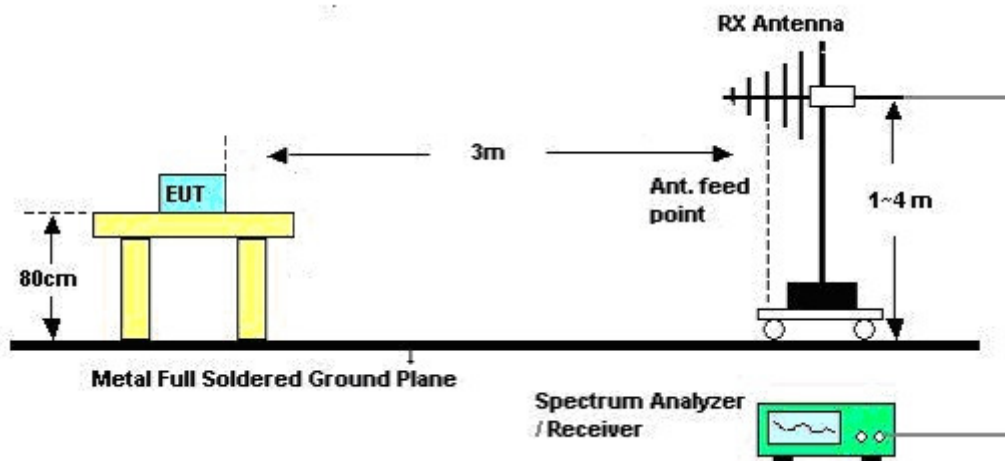

4.5.5. Test Deviation

There is no deviation with the original standard.

4.5.6. EUT Operation during Test

The EUT was programmed to be in continuously transmitting mode.

4.5.7. Results of Radiated Emissions (9kHz~30MHz)

Temperature	26°C	Humidity	60%
Test Engineer	Magic Lai	Configurations	Normal Link
Test Date	Jun. 25, 2012	Test Mode	Mode 3

Freq. (MHz)	Level (dBuV)	Over Limit (dB)	Limit Line (dBuV)	Remark
-	-	-	-	See Note

Note:

The amplitude of spurious emissions that are attenuated by more than 20 dB below the permissible value has no need to be reported.

Distance extrapolation factor = $40 \log(\text{specific distance} / \text{test distance})$ (dB);

Limit line = specific limits (dBuV) + distance extrapolation factor.

4.5.8. Results of Radiated Emissions (30MHz~1GHz)

Temperature	26°C	Humidity	60%
Test Engineer	Magic Lai	Configurations	Normal Link
Test Mode	Mode 3		

Horizontal

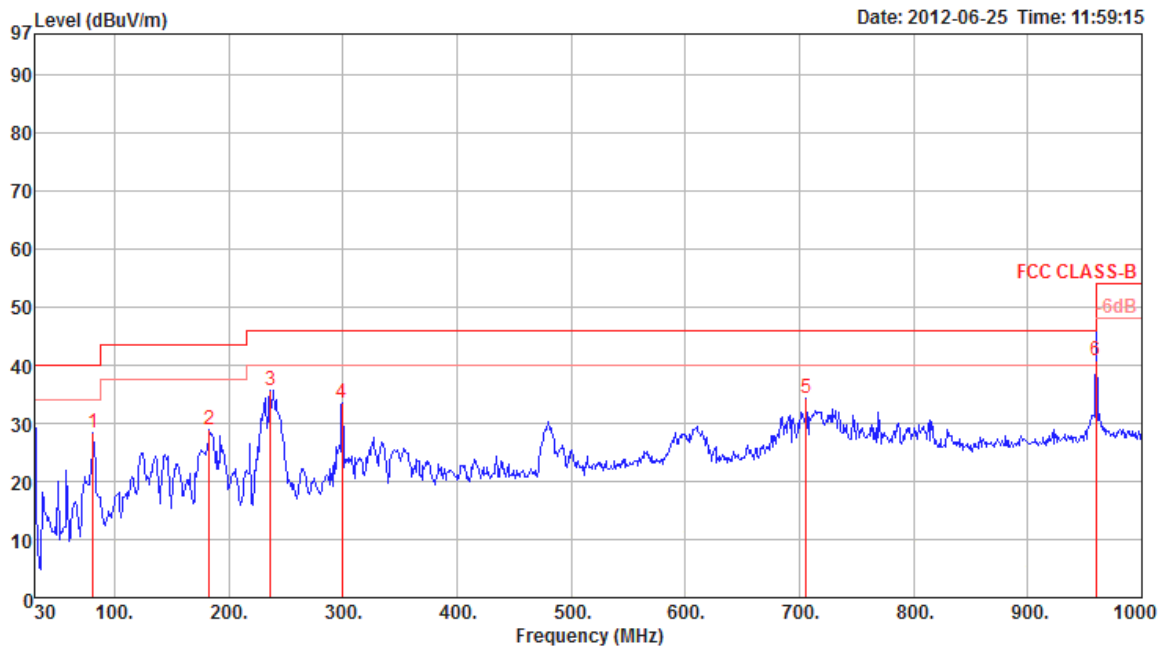

	Freq	Level	Limit	Over	Read	Cable	Preamp	Antenna	Remark	Pol/Phase	A/Pos	T/Pos
	MHz	dBUV/m	dBUV/m	dB	dBUV	Loss	Factor	Factor			cm	deg
1	81.41	28.36	40.00	-11.64	47.23	1.35	27.90	7.68	Peak	HORIZONTAL	400	0
2	183.26	28.83	43.50	-14.67	44.31	2.02	27.37	9.87	Peak	HORIZONTAL	400	0
3 p	236.61	35.70	46.00	-10.30	48.53	2.30	26.99	11.86	Peak	HORIZONTAL	400	0
4	299.66	33.38	46.00	-12.62	43.90	2.51	26.83	13.80	Peak	HORIZONTAL	400	0
5	706.09	34.33	46.00	-11.67	37.22	4.17	27.08	20.02	Peak	HORIZONTAL	400	0
6 q	959.99	40.69	46.00	-5.31	40.32	4.86	26.45	21.96	QP	HORIZONTAL	400	0

Vertical

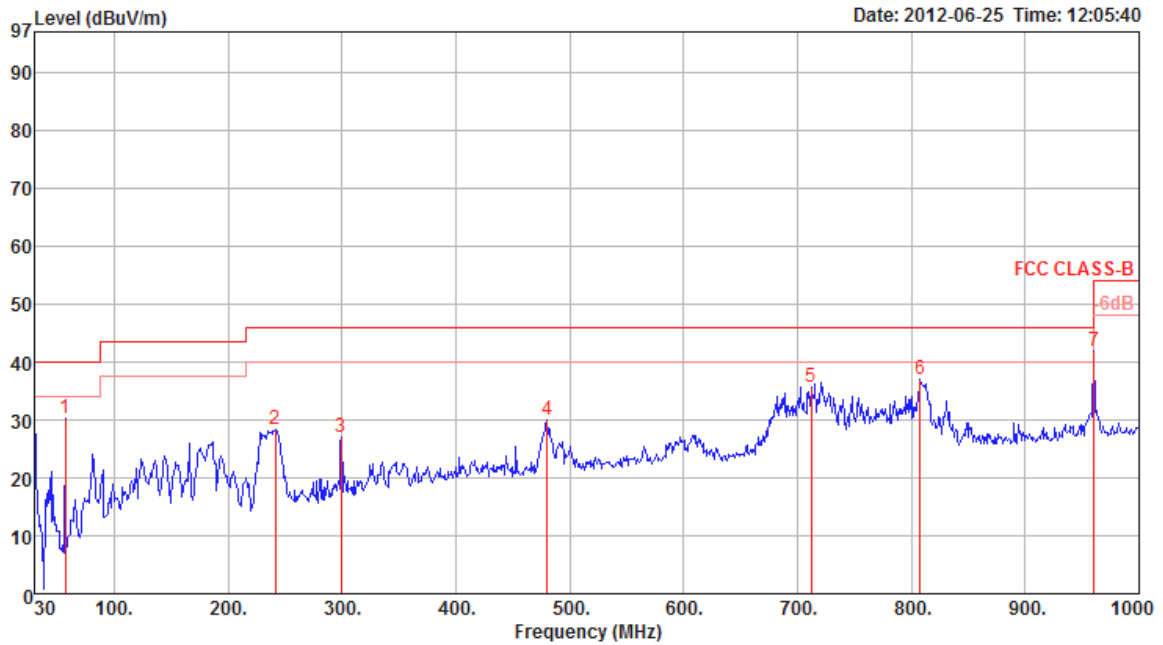

	Freq	Level	Limit Line	Over Limit	Read Level	Cable Loss	Preamp Factor	Antenna Factor	Remark	Pol/Phase	A/Pos	T/Pos
	MHz	dBuV/m	dBuV/m	dB	dBuV	dB	dB	dB/m			cm	deg
1	57.16	30.37	40.00	-9.63	49.71	1.15	27.93	7.44	Peak	VERTICAL	100	0
2	241.46	28.28	46.00	-17.72	40.68	2.32	26.97	12.25	Peak	VERTICAL	100	0
3	299.66	27.14	46.00	-18.86	37.66	2.51	26.83	13.80	Peak	VERTICAL	100	0
4	480.08	30.10	46.00	-15.90	37.19	3.33	27.90	17.48	Peak	VERTICAL	100	0
5	711.91	35.73	46.00	-10.27	38.60	4.17	27.09	20.05	Peak	VERTICAL	100	0
6 p	807.94	37.02	46.00	-8.98	38.68	4.37	26.89	20.86	Peak	VERTICAL	100	0
7	960.23	41.90	54.00	-12.10	41.53	4.86	26.45	21.96	Peak	VERTICAL	100	0

Note:

The amplitude of spurious emissions that are attenuated by more than 20dB below the permissible value has no need to be reported.

Emission level (dBuV/m) = 20 log Emission level (uV/m).

Corrected Reading: Antenna Factor + Cable Loss + Read Level - Preamp Factor = Level.

4.5.9. Results for Radiated Emissions (1GHz~10th Harmonic)

Temperature	26°C	Humidity	60%
Test Engineer	Magic Lai	Configurations	IEEE 802.11n MCS0 HT20MHz Ch 1 / Ant. 1 + Ant. 2
Test Date	Jun. 25, 2012	Test Mode	Mode 4

Horizontal

	Freq	Level	Limit Line	Over Limit	Read Level	CableAntenna Loss Factor	Preamp Factor	Remark	A/Pos	T/Pos	Pol/Phase
	MHz	dBuV/m	dBuV/m	dB	dBuV	dB	dB/m	dB	cm	deg	
1	4824.01	54.06	74.00	-19.94	52.72	3.31	33.06	35.03	Peak	162	211 HORIZONTAL
2	4824.30	36.98	54.00	-17.02	35.64	3.31	33.06	35.03	Average	162	211 HORIZONTAL

Vertical

	Freq	Level	Limit Line	Over Limit	Read Level	CableAntenna Loss Factor	Preamp Factor	Remark	A/Pos	T/Pos	Pol/Phase
	MHz	dBuV/m	dBuV/m	dB	dBuV	dB	dB/m	dB	cm	deg	
1	4824.04	35.68	54.00	-18.32	34.34	3.31	33.06	35.03	Average	102	174 VERTICAL
2	4824.15	50.40	74.00	-23.60	49.06	3.31	33.06	35.03	Peak	102	174 VERTICAL

Temperature	26°C	Humidity	60%
Test Engineer	Magic Lai	Configurations	IEEE 802.11n MCS0 HT20MHz Ch 6 / Ant. 1 + Ant. 2
Test Date	Jun. 25, 2012	Test Mode	Mode 4

Horizontal

	Freq	Level	Limit	Over	Read	Cable	Antenna	Preamp	Remark	A/Pos	T/Pos	Pol/Phase
	MHz	dBuV/m	dBuV/m	dB	dBuV	Loss	Factor	Factor		cm	deg	
1	4873.54	40.09	54.00	-13.91	38.63	3.33	33.16	35.03	Average	196	180	HORIZONTAL
2	4874.32	57.96	74.00	-16.04	56.50	3.33	33.16	35.03	Peak	196	180	HORIZONTAL

Vertical

	Freq	Level	Limit	Over	Read	Cable	Antenna	Preamp	Remark	A/Pos	T/Pos	Pol/Phase
	MHz	dBuV/m	dBuV/m	dB	dBuV	Loss	Factor	Factor		cm	deg	
1	4874.53	54.39	74.00	-19.61	52.93	3.33	33.16	35.03	Peak	102	211	VERTICAL
2	4874.90	39.10	54.00	-14.90	37.64	3.33	33.16	35.03	Average	102	211	VERTICAL

Temperature	26°C	Humidity	60%
Test Engineer	Magic Lai	Configurations	IEEE 802.11n MCS0 HT20MHz Ch 11 / Ant. 1 + Ant. 2
Test Date	Jun. 25, 2012	Test Mode	Mode 4

Horizontal

	Freq	Level	Limit	Over	Read	CableAntenna	Preamp	Remark	A/Pos	T/Pos	Pol/Phase
	MHz	dBuV/m	dBuV/m	dB	dBuV	Loss	Factor		cm	deg	
1	4925.71	40.82	54.00	-13.18	39.22	3.35	33.26	35.01 Average	197	146	HORIZONTAL
2	4926.00	59.86	74.00	-14.14	58.26	3.35	33.26	35.01 Peak	197	146	HORIZONTAL

Vertical

	Freq	Level	Limit	Over	Read	CableAntenna	Preamp	Remark	A/Pos	T/Pos	Pol/Phase
	MHz	dBuV/m	dBuV/m	dB	dBuV	Loss	Factor		cm	deg	
1	4924.39	57.09	74.00	-16.91	55.49	3.35	33.26	35.01 Peak	101	326	VERTICAL
2	4924.93	41.16	54.00	-12.84	39.56	3.35	33.26	35.01 Average	101	326	VERTICAL

Temperature	26°C	Humidity	60%
Test Engineer	Magic Lai	Configurations	IEEE 802.11n MCS0 HT40MHz Ch 3 / Ant. 1 + Ant. 2
Test Date	Jun. 25, 2012	Test Mode	Mode 4

Horizontal

	Freq	Level	Limit	Over	Read	Cable	Antenna	Preamp	Remark	A/Pos	T/Pos	Pol/Phase
	MHz	dBuV/m	dBuV/m	dB	dBuV	Loss	Factor	Factor		cm	deg	
1	4843.71	32.26	54.00	-21.74	30.88	3.32	33.09	35.03	Average	152	154	HORIZONTAL
2	4844.01	46.49	74.00	-27.51	45.11	3.32	33.09	35.03	Peak	152	154	HORIZONTAL

Vertical

	Freq	Level	Limit	Over	Read	Cable	Antenna	Preamp	Remark	A/Pos	T/Pos	Pol/Phase
	MHz	dBuV/m	dBuV/m	dB	dBuV	Loss	Factor	Factor		cm	deg	
1	4844.27	43.79	74.00	-30.21	42.41	3.32	33.09	35.03	Peak	100	203	VERTICAL
2	4844.39	31.53	54.00	-22.47	30.15	3.32	33.09	35.03	Average	100	203	VERTICAL

Temperature	26°C	Humidity	60%
Test Engineer	Magic Lai	Configurations	IEEE 802.11n MCS0 HT40MHz Ch 6 / Ant. 1 + Ant. 2
Test Date	Jun. 25, 2012	Test Mode	Mode 4

Horizontal

	Freq	Level	Limit	Over	Read	Cable	Antenna	Preamp	Remark	A/Pos	T/Pos	Pol/Phase
	MHz	dBuV/m	dBuV/m	dB	dBuV	Loss	Factor	Factor		cm	deg	
1	4873.72	36.18	54.00	-17.82	34.72	3.33	33.16	35.03	Average	163	178	HORIZONTAL
2	4873.87	51.53	74.00	-22.47	50.07	3.33	33.16	35.03	Peak	163	178	HORIZONTAL

Vertical

	Freq	Level	Limit	Over	Read	Cable	Antenna	Preamp	Remark	A/Pos	T/Pos	Pol/Phase
	MHz	dBuV/m	dBuV/m	dB	dBuV	Loss	Factor	Factor		cm	deg	
1	4874.39	34.70	54.00	-19.30	33.24	3.33	33.16	35.03	Average	105	211	VERTICAL
2	4874.49	48.75	74.00	-25.25	47.29	3.33	33.16	35.03	Peak	105	211	VERTICAL

Temperature	26°C	Humidity	60%
Test Engineer	Magic Lai	Configurations	IEEE 802.11n MCS0 HT40MHz Ch 9 / Ant. 1 + Ant. 2
Test Date	Jun. 25, 2012	Test Mode	Mode 4

Horizontal

	Freq	Level	Limit	Over	Read	Cable	Antenna	Preamp	Remark	A/Pos	T/Pos	Pol/Phase
	MHz	dBuV/m	dBuV/m	dB	dBuV	Loss	Factor	Factor		cm	deg	
1	4903.71	32.02	54.00	-21.98	30.51	3.34	33.19	35.02	Average	100	184	HORIZONTAL
2	4903.95	45.24	74.00	-28.76	43.73	3.34	33.19	35.02	Peak	100	184	HORIZONTAL

Vertical

	Freq	Level	Limit	Over	Read	Cable	Antenna	Preamp	Remark	A/Pos	T/Pos	Pol/Phase
	MHz	dBuV/m	dBuV/m	dB	dBuV	Loss	Factor	Factor		cm	deg	
1	4904.13	46.39	74.00	-27.61	44.88	3.34	33.19	35.02	Peak	100	196	VERTICAL
2	4904.26	33.17	54.00	-20.83	31.66	3.34	33.19	35.02	Average	100	196	VERTICAL

Temperature	26°C	Humidity	60%
Test Engineer	Magic Lai	Configurations	IEEE 802.11n MCS0 HT20MHz Ch 149 / Ant. 1 + Ant. 2
Test Date	Jun. 25, 2012	Test Mode	Mode 4

Horizontal

	Freq	Level	Limit	Over	Read	Cable	Preamp	Antenna	Remark	Pol/Phase	A/Pos	T/Pos
	MHz	dBuV/m	dBuV/m	dB	dBuV	dB	dB	dB/m			cm	deg
1 p	11483.00	50.11	74.00	-23.89	39.69	6.74	34.82	38.50	Peak	HORIZONTAL	100	328
2 a	11490.72	38.77	54.00	-15.23	28.35	6.74	34.82	38.50	Average	HORIZONTAL	100	328

Vertical

	Freq	Level	Limit	Over	Read	Cable	Preamp	Antenna	Remark	Pol/Phase	A/Pos	T/Pos
	MHz	dBuV/m	dBuV/m	dB	dBuV	dB	dB	dB/m			cm	deg
1 a	11489.48	47.08	54.00	-6.92	36.66	6.74	34.82	38.50	Average	VERTICAL	145	220
2 p	11492.80	60.41	74.00	-13.59	49.99	6.74	34.82	38.50	Peak	VERTICAL	145	220

Temperature	26°C	Humidity	60%
Test Engineer	Magic Lai	Configurations	IEEE 802.11n MCS0 HT20MHz Ch 157 / Ant. 1 + Ant. 2
Test Date	Jun. 25, 2012	Test Mode	Mode 4

Horizontal

	Freq	Level	Limit	Over	Read	Cable	Preamp	Antenna	Remark	Pol/Phase	A/Pos	T/Pos
	MHz	dBuV/m	dBuV/m	dB	dBuV	dB	dB	dB/m			cm	deg
1 a	11569.04	39.79	54.00	-14.21	29.36	6.77	34.84	38.50	Average	HORIZONTAL	100	110
2 p	11572.40	50.61	74.00	-23.39	40.19	6.77	34.85	38.50	Peak	HORIZONTAL	100	110

Vertical

	Freq	Level	Limit	Over	Read	Cable	Preamp	Antenna	Remark	Pol/Phase	A/Pos	T/Pos
	MHz	dBuV/m	dBuV/m	dB	dBuV	dB	dB	dB/m			cm	deg
1 p	11564.48	61.73	74.00	-12.27	51.30	6.77	34.84	38.50	Peak	VERTICAL	100	209
2 a	11569.28	48.87	54.00	-5.13	38.44	6.77	34.84	38.50	Average	VERTICAL	100	209

Temperature	26°C	Humidity	60%
Test Engineer	Magic Lai	Configurations	IEEE 802.11n MCS0 HT20MHz Ch 165 / Ant. 1 + Ant. 2
Test Date	Jun. 25, 2012	Test Mode	Mode 4

Horizontal

	Freq	Level	Limit	Over	Read	Cable	Preamp	Antenna	Remark	Pol/Phase	A/Pos	T/Pos
	MHz	dBuV/m	dBuV/m	dB	dBuV	dB	dB	dB/m			cm	deg
1 a	11649.28	40.22	54.00	-13.78	29.79	6.80	34.87	38.50	Average	HORIZONTAL	110	99
2 p	11652.68	51.48	74.00	-22.52	41.05	6.80	34.87	38.50	Peak	HORIZONTAL	110	99

Vertical

	Freq	Level	Limit	Over	Read	Cable	Preamp	Antenna	Remark	Pol/Phase	A/Pos	T/Pos
	MHz	dBuV/m	dBuV/m	dB	dBuV	dB	dB	dB/m			cm	deg
1 a	11649.80	50.05	54.00	-3.95	39.62	6.80	34.87	38.50	Average	VERTICAL	100	212
2 p	11650.24	63.07	74.00	-10.93	52.64	6.80	34.87	38.50	Peak	VERTICAL	100	212

Temperature	26°C	Humidity	60%
Test Engineer	Magic Lai	Configurations	IEEE 802.11n MCS0 HT40MHz Ch 151 / Ant. 1 + Ant. 2
Test Date	Jun. 25, 2012	Test Mode	Mode 4

Horizontal

	Freq	Level	Limit	Over	Read	Cable	Preamp	Antenna	Remark	Pol/Phase	A/Pos	T/Pos
	MHz	dBuV/m	dBuV/m	dB	dBuV	dB	dB	dB/m			cm	deg
1 p	11510.04	51.39	74.00	-22.61	40.96	6.75	34.82	38.50	Peak	HORIZONTAL	156	121
2 a	11510.48	38.46	54.00	-15.54	28.03	6.75	34.82	38.50	Average	HORIZONTAL	156	121

Vertical

	Freq	Level	Limit	Over	Read	Cable	Preamp	Antenna	Remark	Pol/Phase	A/Pos	T/Pos
	MHz	dBuV/m	dBuV/m	dB	dBuV	dB	dB	dB/m			cm	deg
1 a	11509.40	43.90	54.00	-10.10	33.47	6.75	34.82	38.50	Average	VERTICAL	100	208
2 p	11514.80	55.68	74.00	-18.32	45.24	6.76	34.82	38.50	Peak	VERTICAL	100	208

Temperature	26°C	Humidity	60%
Test Engineer	Magic Lai	Configurations	IEEE 802.11n MCS0 HT40MHz Ch 159 / Ant. 1 + Ant. 2
Test Date	Jun. 25, 2012	Test Mode	Mode 4

Horizontal

	Freq	Level	Limit	Over	Read	Cable	Preamp	Antenna	Remark	Pol/Phase	A/Pos	T/Pos
	MHz	dBuV/m	dBuV/m	dB	dBuV	dB	dB	dB/m			cm	deg
1 p	11593.80	51.96	74.00	-22.04	41.53	6.78	34.85	38.50	Peak	HORIZONTAL	100	278
2 a	11596.96	38.90	54.00	-15.10	28.47	6.78	34.85	38.50	Average	HORIZONTAL	100	278

Vertical

	Freq	Level	Limit	Over	Read	Cable	Preamp	Antenna	Remark	Pol/Phase	A/Pos	T/Pos
	MHz	dBuV/m	dBuV/m	dB	dBuV	dB	dB	dB/m			cm	deg
1 a	11587.16	45.69	54.00	-8.31	35.26	6.78	34.85	38.50	Average	VERTICAL	100	210
2 p	11589.24	58.60	74.00	-15.40	48.17	6.78	34.85	38.50	Peak	VERTICAL	100	210

Temperature	26°C	Humidity	60%
Test Engineer	Magic Lai	Configurations	IEEE 802.11b CH 1 / Ant. 1 + Ant. 2
Test Date	Jun. 25, 2012	Test Mode	Mode 4

Horizontal

	Freq	Level	Limit Line	Over Limit	Read Level	Cable Loss	Antenna Factor	Preamp Factor	Remark	A/Pos	T/Pos	Pol/Phase
	MHz	dBuV/m	dBuV/m	dB	dBuV	dB	dB/m	dB		cm	deg	
1	4823.90	55.25	74.00	-18.75	53.91	3.31	33.06	35.03	Peak	103	29	HORIZONTAL
2	4823.93	53.34	54.00	-0.66	52.00	3.31	33.06	35.03	Average	103	29	HORIZONTAL

Vertical

	Freq	Level	Limit Line	Over Limit	Read Level	Cable Loss	Antenna Factor	Preamp Factor	Remark	A/Pos	T/Pos	Pol/Phase
	MHz	dBuV/m	dBuV/m	dB	dBuV	dB	dB/m	dB		cm	deg	
1	4823.90	54.24	74.00	-19.76	52.90	3.31	33.06	35.03	Peak	100	248	VERTICAL
2	4824.00	52.54	54.00	-1.46	51.20	3.31	33.06	35.03	Average	100	248	VERTICAL

Temperature	26°C	Humidity	60%
Test Engineer	Magic Lai	Configurations	IEEE 802.11b CH 6 / Ant. 1 + Ant. 2
Test Date	Jun. 25, 2012	Test Mode	Mode 4

Horizontal

	Freq	Level	Limit Line	Over Limit	Read Level	Cable Loss	Antenna Factor	Preamp Factor	Remark	A/Pos	T/Pos	Pol/Phase
	MHz	dBuV/m	dBuV/m	dB	dBuV	dB	dB/m	dB		cm	deg	
1	4873.92	55.86	74.00	-18.14	54.40	3.33	33.16	35.03	Peak	101	9	HORIZONTAL
2	4873.94	53.85	54.00	-0.15	52.39	3.33	33.16	35.03	Average	101	9	HORIZONTAL

Vertical

	Freq	Level	Limit Line	Over Limit	Read Level	Cable Loss	Antenna Factor	Preamp Factor	Remark	A/Pos	T/Pos	Pol/Phase
	MHz	dBuV/m	dBuV/m	dB	dBuV	dB	dB/m	dB		cm	deg	
1	4873.92	54.00	74.00	-20.00	52.54	3.33	33.16	35.03	Peak	101	216	VERTICAL
2	4873.97	52.12	54.00	-1.88	50.66	3.33	33.16	35.03	Average	101	216	VERTICAL

Temperature	26°C	Humidity	60%
Test Engineer	Magic Lai	Configurations	IEEE 802.11b CH 11 / Ant. 1 + Ant. 2
Test Date	Jun. 25, 2012	Test Mode	Mode 4

Horizontal

	Freq	Level	Limit Line	Over Limit	Read Level	Cable Loss	Antenna Factor	Preamp Factor	Remark	A/Pos	T/Pos	Pol/Phase
	MHz	dBuV/m	dBuV/m	dB	dBuV	dB	dB/m	dB		cm	deg	
1	4923.93	53.81	54.00	-0.19	52.21	3.35	33.26	35.01	Average	100	9	HORIZONTAL
2	4923.98	55.72	74.00	-18.28	54.12	3.35	33.26	35.01	Peak	100	9	HORIZONTAL

Vertical

	Freq	Level	Limit Line	Over Limit	Read Level	Cable Loss	Antenna Factor	Preamp Factor	Remark	A/Pos	T/Pos	Pol/Phase
	MHz	dBuV/m	dBuV/m	dB	dBuV	dB	dB/m	dB		cm	deg	
1	4923.94	52.47	74.00	-21.53	50.87	3.35	33.26	35.01	Peak	102	321	VERTICAL
2	4923.97	50.66	54.00	-3.34	49.06	3.35	33.26	35.01	Average	102	321	VERTICAL

Temperature	26°C	Humidity	60%
Test Engineer	Magic Lai	Configurations	IEEE 802.11g CH 1 / Ant. 1 + Ant. 2
Test Date	Jun. 25, 2012	Test Mode	Mode 4

Horizontal

	Freq	Level	Limit	Over	Read	Cable	Antenna	Preamp	Remark	A/Pos	T/Pos	Pol/Phase
	MHz	dBuV/m	dBuV/m	dB	dBuV	Loss	Factor	Factor		cm	deg	
1	4824.02	36.10	54.00	-17.90	34.76	3.31	33.06	35.03	Average	105	144	HORIZONTAL
2	4824.09	51.33	74.00	-22.67	49.99	3.31	33.06	35.03	Peak	105	144	HORIZONTAL

Vertical

	Freq	Level	Limit	Over	Read	Cable	Antenna	Preamp	Remark	A/Pos	T/Pos	Pol/Phase
	MHz	dBuV/m	dBuV/m	dB	dBuV	Loss	Factor	Factor		cm	deg	
1	4825.92	51.79	74.00	-22.21	50.45	3.31	33.06	35.03	Peak	100	267	VERTICAL
2	4826.03	36.97	54.00	-17.03	35.63	3.31	33.06	35.03	Average	100	267	VERTICAL



Temperature	26°C	Humidity	60%
Test Engineer	Magic Lai	Configurations	IEEE 802.11g CH 6 / Ant. 1 + Ant. 2
Test Date	Jun. 25, 2012	Test Mode	Mode 4

Horizontal

	Freq	Level	Limit Line	Over Limit	Read Level	Cable Loss	Antenna Factor	Preamp Factor	Remark	A/Pos	T/Pos	Pol/Phase
	MHz	dBuV/m	dBuV/m	dB	dBuV	dB	dB/m	dB		cm	deg	
1	4873.47	54.49	74.00	-19.51	53.03	3.33	33.16	35.03	Peak	100	180	HORIZONTAL
2	4873.57	38.28	54.00	-15.72	36.82	3.33	33.16	35.03	Average	100	180	HORIZONTAL

Vertical

	Freq	Level	Limit Line	Over Limit	Read Level	Cable Loss	Antenna Factor	Preamp Factor	Remark	A/Pos	T/Pos	Pol/Phase
	MHz	dBuV/m	dBuV/m	dB	dBuV	dB	dB/m	dB		cm	deg	
1	4875.62	55.20	74.00	-18.80	53.74	3.33	33.16	35.03	Peak	100	319	VERTICAL
2	4876.27	38.84	54.00	-15.16	37.38	3.33	33.16	35.03	Average	100	319	VERTICAL

Temperature	26°C	Humidity	60%
Test Engineer	Magic Lai	Configurations	IEEE 802.11g CH 11 / Ant. 1 + Ant. 2
Test Date	Jun. 25, 2012	Test Mode	Mode 4

Horizontal

	Freq	Level	Limit	Over	Read	Cable	Antenna	Preamp	Remark	A/Pos	T/Pos	Pol/Phase
	MHz	dBuV/m	dBuV/m	dB	dBuV	Loss	Factor	Factor		cm	deg	
1	4922.38	41.57	54.00	-12.43	39.97	3.35	33.26	35.01	Average	212	146	HORIZONTAL
2	4922.72	59.97	74.00	-14.03	58.37	3.35	33.26	35.01	Peak	212	146	HORIZONTAL

Vertical

	Freq	Level	Limit	Over	Read	Cable	Antenna	Preamp	Remark	A/Pos	T/Pos	Pol/Phase
	MHz	dBuV/m	dBuV/m	dB	dBuV	Loss	Factor	Factor		cm	deg	
1	4924.94	57.65	74.00	-16.35	56.05	3.35	33.26	35.01	Peak	100	327	VERTICAL
2	4925.78	41.09	54.00	-12.91	39.49	3.35	33.26	35.01	Average	100	327	VERTICAL

Temperature	26°C	Humidity	60%
Test Engineer	Magic Lai	Configurations	IEEE 802. 11a CH 149 / Ant. 1 + Ant. 2
Test Date	Jun. 25, 2012	Test Mode	Mode 4

Horizontal

	Freq	Level	Limit	Over	Read	Cable	Preamp	Antenna	Remark	Pol/Phase	A/Pos	T/Pos
	MHz	dBuV/m	dBuV/m	dB	dBuV	dB	dB	dB/m			cm	deg
1 p	11487.48	52.07	74.00	-21.93	41.65	6.74	34.82	38.50	Peak	HORIZONTAL	148	143
2 a	11488.20	39.96	54.00	-14.04	29.54	6.74	34.82	38.50	Average	HORIZONTAL	148	143

Vertical

	Freq	Level	Limit	Over	Read	Cable	Preamp	Antenna	Remark	Pol/Phase	A/Pos	T/Pos
	MHz	dBuV/m	dBuV/m	dB	dBuV	dB	dB	dB/m			cm	deg
1 a	11489.10	45.28	54.00	-8.72	34.86	6.74	34.82	38.50	Average	VERTICAL	100	207
2 p	11492.20	57.39	74.00	-16.61	46.97	6.74	34.82	38.50	Peak	VERTICAL	100	207

Temperature	26°C	Humidity	60%
Test Engineer	Magic Lai	Configurations	IEEE 802. 11a CH 157 / Ant. 1 + Ant. 2
Test Date	Jun. 25, 2012	Test Mode	Mode 4

Horizontal

	Freq	Level	Limit	Over	Read	Cable	Preamp	Antenna	Remark	Pol/Phase	A/Pos	T/Pos
	MHz	dBuV/m	dBuV/m	dB	dBuV	dB	dB	dB/m			cm	deg
1 p	11566.20	51.63	74.00	-22.37	41.20	6.77	34.84	38.50	Peak	HORIZONTAL	100	51
2 a	11570.12	40.20	54.00	-13.80	29.78	6.77	34.85	38.50	Average	HORIZONTAL	100	52

Vertical

	Freq	Level	Limit	Over	Read	Cable	Preamp	Antenna	Remark	Pol/Phase	A/Pos	T/Pos
	MHz	dBuV/m	dBuV/m	dB	dBuV	dB	dB	dB/m			cm	deg
1 a	11569.08	49.99	54.00	-4.01	39.56	6.77	34.84	38.50	Average	VERTICAL	100	210
2 p	11574.12	63.08	74.00	-10.92	52.66	6.77	34.85	38.50	Peak	VERTICAL	100	210

Temperature	26°C	Humidity	60%
Test Engineer	Magic Lai	Configurations	IEEE 802. 11a CH 165 / Ant. 1 + Ant. 2
Test Date	Jun. 25, 2012	Test Mode	Mode 4

Horizontal

	Freq	Level	Limit	Over	Read	Cable	Preamp	Antenna	Remark	Pol/Phase	A/Pos	T/Pos
	MHz	dBuV/m	dBuV/m	dB	dBuV	dB	dB	dB/m			cm	deg
1 a	11648.96	40.05	54.00	-13.95	29.62	6.80	34.87	38.50	Average	HORIZONTAL	100	360
2 p	11658.04	50.75	74.00	-23.25	40.32	6.80	34.87	38.50	Peak	HORIZONTAL	100	360

Vertical

	Freq	Level	Limit	Over	Read	Cable	Preamp	Antenna	Remark	Pol/Phase	A/Pos	T/Pos
	MHz	dBuV/m	dBuV/m	dB	dBuV	dB	dB	dB/m			cm	deg
1 p	11649.80	63.49	74.00	-10.51	53.06	6.80	34.87	38.50	Peak	VERTICAL	100	210
2 a	11649.92	50.00	54.00	-4.00	39.57	6.80	34.87	38.50	Average	VERTICAL	100	210

Temperature	26°C	Humidity	60%
Test Engineer	Magic Lai	Configurations	IEEE 802. 11ac MCS0 VHT 20MHz CH 149 / Ant. 1 + Ant. 2
Test Date	Jun. 25, 2012	Test Mode	Mode 4

Horizontal

	Freq	Level	Limit	Over	Read	Cable	Preamp	Antenna	Remark	Pol/Phase	A/Pos	T/Pos
	MHz	dBuV/m	dBuV/m	dB	dBuV	dB	dB	dB/m			cm	deg
1 p	11485.64	50.44	74.00	-23.56	40.02	6.74	34.82	38.50	Peak	HORIZONTAL	100	60
2 a	11490.28	40.71	54.00	-13.29	30.29	6.74	34.82	38.50	Average	HORIZONTAL	100	60

Vertical

	Freq	Level	Limit	Over	Read	Cable	Preamp	Antenna	Remark	Pol/Phase	A/Pos	T/Pos
	MHz	dBuV/m	dBuV/m	dB	dBuV	dB	dB	dB/m			cm	deg
1 a	11490.84	46.04	54.00	-7.96	35.62	6.74	34.82	38.50	Average	VERTICAL	150	210
2 p	11493.08	58.41	74.00	-15.59	47.99	6.74	34.82	38.50	Peak	VERTICAL	150	210

Temperature	26°C	Humidity	60%
Test Engineer	Magic Lai	Configurations	IEEE 802. 11ac MCS0 VHT 20MHz CH 157 / Ant. 1 + Ant. 2
Test Date	Jun. 25, 2012	Test Mode	Mode 4

Horizontal

	Freq	Level	Limit	Over	Read	Cable	Preamp	Antenna	Remark	Pol/Phase	A/Pos	T/Pos
	MHz	dBuV/m	dBuV/m	dB	dBuV	dB	dB	dB/m			cm	deg
1 a	11569.60	40.08	54.00	-13.92	29.65	6.77	34.84	38.50	Average	HORIZONTAL	100	59
2 p	11573.56	51.56	74.00	-22.44	41.14	6.77	34.85	38.50	Peak	HORIZONTAL	100	59

Vertical

	Freq	Level	Limit	Over	Read	Cable	Preamp	Antenna	Remark	Pol/Phase	A/Pos	T/Pos
	MHz	dBuV/m	dBuV/m	dB	dBuV	dB	dB	dB/m			cm	deg
1 a	11572.08	48.63	54.00	-5.37	38.21	6.77	34.85	38.50	Average	VERTICAL	100	212
2 p	11572.56	61.03	74.00	-12.97	50.61	6.77	34.85	38.50	Peak	VERTICAL	100	212

Temperature	26°C	Humidity	60%
Test Engineer	Magic Lai	Configurations	IEEE 802. 11ac MCS0 VHT 20MHz CH 165 / Ant. 1 + Ant. 2
Test Date	Jun. 25, 2012	Test Mode	Mode 4

Horizontal

	Freq	Level	Limit	Over	Read	Cable	Preamp	Antenna	Remark	Pol/Phase	A/Pos	T/Pos
	MHz	dBuV/m	dBuV/m	dB	dBuV	dB	dB	dB/m			cm	deg
1 p	11646.80	51.19	74.00	-22.81	40.76	6.80	34.87	38.50	Peak	HORIZONTAL	100	169
2 a	11649.52	40.06	54.00	-13.94	29.63	6.80	34.87	38.50	Average	HORIZONTAL	100	169

Vertical

	Freq	Level	Limit	Over	Read	Cable	Preamp	Antenna	Remark	Pol/Phase	A/Pos	T/Pos
	MHz	dBuV/m	dBuV/m	dB	dBuV	dB	dB	dB/m			cm	deg
1 a	11650.20	49.49	54.00	-4.51	39.06	6.80	34.87	38.50	Average	VERTICAL	100	207
2 p	11651.72	62.78	74.00	-11.22	52.35	6.80	34.87	38.50	Peak	VERTICAL	100	207

Temperature	26°C	Humidity	60%
Test Engineer	Magic Lai	Configurations	IEEE 802. 11ac MCS0 VHT 40MHz CH 151 / Ant. 1 + Ant. 2
Test Date	Jun. 25, 2012	Test Mode	Mode 4

Horizontal

	Freq	Level	Limit	Over	Read	Cable	Preamp	Antenna	Remark	Pol/Phase	A/Pos	T/Pos
	MHz	dBuV/m	dBuV/m	dB	dBuV	dB	dB	dB/m			cm	deg
1 a	11508.80	41.96	54.00	-12.04	31.53	6.75	34.82	38.50	Average	HORIZONTAL	144	127
2 p	11516.20	51.60	74.00	-22.40	41.16	6.76	34.82	38.50	Peak	HORIZONTAL	144	127

Vertical

	Freq	Level	Limit	Over	Read	Cable	Preamp	Antenna	Remark	Pol/Phase	A/Pos	T/Pos
	MHz	dBuV/m	dBuV/m	dB	dBuV	dB	dB	dB/m			cm	deg
1 p	11505.40	56.01	74.00	-17.99	45.58	6.75	34.82	38.50	Peak	VERTICAL	144	214
2 a	11509.88	43.54	54.00	-10.46	33.11	6.75	34.82	38.50	Average	VERTICAL	144	214

Temperature	26°C	Humidity	60%
Test Engineer	Magic Lai	Configurations	IEEE 802. 11ac MCS0 VHT 40MHz CH 159 / Ant. 1 + Ant. 2
Test Date	Jun. 25, 2012	Test Mode	Mode 4

Horizontal

	Freq	Level	Limit	Over	Read	Cable	Preamp	Antenna	Remark	Pol/Phase	A/Pos	T/Pos
	MHz	dBuV/m	dBuV/m	dB	dBuV	dB	dB	dB/m			cm	deg
1 p	11585.76	49.91	74.00	-24.09	39.48	6.78	34.85	38.50	Peak	HORIZONTAL	100	41
2 a	11590.36	39.50	54.00	-14.50	29.07	6.78	34.85	38.50	Average	HORIZONTAL	100	41

Vertical

	Freq	Level	Limit	Over	Read	Cable	Preamp	Antenna	Remark	Pol/Phase	A/Pos	T/Pos
	MHz	dBuV/m	dBuV/m	dB	dBuV	dB	dB	dB/m			cm	deg
1 p	11587.40	57.85	74.00	-16.15	47.42	6.78	34.85	38.50	Peak	VERTICAL	143	213
2 a	11589.32	45.22	54.00	-8.78	34.79	6.78	34.85	38.50	Average	VERTICAL	143	213

Temperature	26°C	Humidity	60%
Test Engineer	Magic Lai	Configurations	IEEE 802. 11ac MCS0 VHT 80MHz CH 155 / Ant. 1 + Ant. 2
Test Date	Jun. 25, 2012	Test Mode	Mode 4

Horizontal

	Freq	Level	Limit Line	Over Limit	Read Level	Cable Loss	Preamp Factor	Antenna Factor	Remark	Pol/Phase	A/Pos	T/Pos
	MHz	dBuV/m	dBuV/m	dB	dBuV	dB	dB	dB/m			cm	deg
1 p	11543.32	49.86	74.00	-24.14	39.43	6.76	34.83	38.50	Peak	HORIZONTAL	100	304
2 a	11558.96	37.63	54.00	-16.37	27.20	6.77	34.84	38.50	Average	HORIZONTAL	100	304

Vertical

	Freq	Level	Limit Line	Over Limit	Read Level	Cable Loss	Preamp Factor	Antenna Factor	Remark	Pol/Phase	A/Pos	T/Pos
	MHz	dBuV/m	dBuV/m	dB	dBuV	dB	dB	dB/m			cm	deg
1 p	11553.76	49.81	74.00	-24.19	39.38	6.77	34.84	38.50	Peak	VERTICAL	100	109
2 a	11556.52	37.45	54.00	-16.55	27.02	6.77	34.84	38.50	Average	VERTICAL	100	109

Note:

The amplitude of spurious emissions that are attenuated by more than 20dB below the permissible value has no need to be reported.

Emission level (dBuV/m) = 20 log Emission level (uV/m).

Corrected Reading: Antenna Factor + Cable Loss + Read Level - Preamp Factor = Level.

4.6. Band Edge Emissions Measurement

4.6.1. Limit

20dBc in any 100 kHz bandwidth outside the operating frequency band. In case the emission fall within the restricted band specified on 15.205(a), then the 15.209(a) limit in the table below has to be followed.

Frequencies (MHz)	Field Strength (micorvolts/meter)	Measurement Distance (meters)
0.009~0.490	2400/F(KHz)	300
0.490~1.705	24000/F(KHz)	30
1.705~30.0	30	30
30~88	100	3
88~216	150	3
216~960	200	3
Above 960	500	3

4.6.2. Measuring Instruments and Setting

Please refer to section 5 of equipments list in this report. The following table is the setting of the spectrum analyzer.

Spectrum Parameter	Setting
Attenuation	Auto
Span Frequency	100 MHz
RB / VB (Emission in restricted band)	1 MHz / 3MHz for Peak, 1 MHz / 10Hz for Average
RB / VB (Emission in non-restricted band)	100 KHz / 300 KHz for Peak

4.6.3. Test Procedures

- The test procedure is the same as section 4.5.3, only the frequency range investigated is limited to 100MHz around bandedges.

4.6.4. Test Setup Layout

This test setup layout is the same as that shown in section 4.5.4.

4.6.5. Test Deviation

There is no deviation with the original standard.

4.6.6. EUT Operation during Test

The EUT was programmed to be in continuously transmitting mode.

4.6.7. Test Result of Band Edge and Fundamental Emissions

Temperature	26°C	Humidity	60%
Test Engineer	Magic Lai	Configurations	IEEE 802.11n MCS0 HT20MHz Ch 1, 6, 11 / Ant. 1 + Ant. 2
Test Date	Jun. 25, 2012	Test Mode	Mode 2

Channel 1

	Freq	Level	Limit Line	Over Limit	Read Level	Cable Loss	Antenna Factor	Preamp Factor	Remark	A/Pos	T/Pos	Pol/Phase
	MHz	dBuV/m	dBuV/m	dB	dBuV	dB	dB/m	dB		cm	deg	
1	2388.56	73.18	74.00	-0.82	42.80	2.21	28.17	0.00	Peak	100	151	HORIZONTAL
2	2390.00	52.87	54.00	-1.13	22.48	2.22	28.17	0.00	Average	100	151	HORIZONTAL
3	2410.08				83.57	2.22	28.21	0.00	Peak	100	151	HORIZONTAL
4	2413.44				70.29	2.22	28.21	0.00	Average	100	151	HORIZONTAL

Item 3, 4 are the fundamental frequency at 2412 MHz.

Channel 6

	Freq	Level	Limit Line	Over Limit	Read Level	Cable Loss	Antenna Factor	Preamp Factor	Remark	A/Pos	T/Pos	Pol/Phase
	MHz	dBuV/m	dBuV/m	dB	dBuV	dB	dB/m	dB		cm	deg	
1	2284.14	53.77	54.00	-0.23	23.67	2.16	27.94	0.00	Average	100	179	HORIZONTAL
2	2284.23	58.40	74.00	-15.60	28.30	2.16	27.94	0.00	Peak	100	179	HORIZONTAL
3	2431.87	112.83				2.23	28.25	0.00	Peak	100	179	HORIZONTAL
4	2433.80	100.55				2.23	28.25	0.00	Average	100	179	HORIZONTAL
5	2483.50	39.77	54.00	-14.23	9.13	2.26	28.38	0.00	Average	100	179	HORIZONTAL
6	2483.50	50.19	74.00	-23.81	19.55	2.26	28.38	0.00	Peak	100	179	HORIZONTAL

Item 3, 4 are the fundamental frequency at 2437MHz.

Channel 11

	Freq	Level	Limit Line	Over Limit	Read Level	Cable Loss	Antenna Factor	Preamp Factor	Remark	A/Pos	T/Pos	Pol/Phase
	MHz	dBuV/m	dBuV/m	dB	dBuV	dB	dB/m	dB		cm	deg	
1	2461.36	99.35				2.24	28.33	0.00	Average	100	158	HORIZONTAL
2	2461.36	112.09				2.24	28.33	0.00	Peak	100	158	HORIZONTAL
3	2483.66	53.19	54.00	-0.81	22.55	2.26	28.38	0.00	Average	100	158	HORIZONTAL
4	2484.30	73.39	74.00	-0.61	42.75	2.26	28.38	0.00	Peak	100	158	HORIZONTAL

Item 1, 2 are the fundamental frequency at 2462 MHz.

Temperature	26°C	Humidity	60%
Test Engineer	Magic Lai	Configurations	IEEE 802.11n MCS0 HT40MHz Ch 3, 6, 9 / Ant. 1 + Ant. 2
Test Date	Jun. 25, 2012	Test Mode	Mode 2

Channel 3

	Freq	Level	Limit Line	Over Limit	Read Level	Cable Loss	Antenna Factor	Preamp Factor	Remark	A/Pos	T/Pos	Pol/Phase
	MHz	dBuV/m	dBuV/m	dB	dBuV	dB	dB/m	dB		cm	deg	
1	2269.81	52.88	54.00	-1.12	22.81	2.16	27.91	0.00	Average	100	177	HORIZONTAL
2	2270.00	56.98	74.00	-17.02	26.91	2.16	27.91	0.00	Peak	100	177	HORIZONTAL
3	2385.19	69.79	74.00	-4.21	39.41	2.21	28.17	0.00	Peak	100	177	HORIZONTAL
4	2389.04	52.78	54.00	-1.22	22.40	2.21	28.17	0.00	Average	100	177	HORIZONTAL
5	2426.81				62.78	2.23	28.25	0.00	Average	100	177	HORIZONTAL
6	2426.81				77.48	2.23	28.25	0.00	Peak	100	177	HORIZONTAL

Item 5, 6 are the fundamental frequency at 2422 MHz.

Channel 6

	Freq	Level	Limit Line	Over Limit	Read Level	Cable Loss	Antenna Factor	Preamp Factor	Remark	A/Pos	T/Pos	Pol/Phase
	MHz	dBuV/m	dBuV/m	dB	dBuV	dB	dB/m	dB		cm	deg	
1	2285.03	53.57	54.00	-0.43	23.47	2.16	27.94	0.00	Average	100	189	HORIZONTAL
2	2285.03	58.49	74.00	-15.51	28.39	2.16	27.94	0.00	Peak	100	189	HORIZONTAL
3	2431.39				63.90	2.23	28.25	0.00	Average	100	189	HORIZONTAL
4	2432.19				79.42	2.23	28.25	0.00	Peak	100	189	HORIZONTAL
5	2483.50	45.96	54.00	-8.04	15.32	2.26	28.38	0.00	Average	100	189	HORIZONTAL
6	2483.50	64.44	74.00	-9.56	33.80	2.26	28.38	0.00	Peak	100	189	HORIZONTAL

Item 3, 4 are the fundamental frequency at 2437MHz.

Channel 9

	Freq	Level	Limit Line	Over Limit	Read Level	Cable Loss	Antenna Factor	Preamp Factor	Remark	A/Pos	T/Pos	Pol/Phase
	MHz	dBuV/m	dBuV/m	dB	dBuV	dB	dB/m	dB		cm	deg	
1	2298.40	53.27	54.00	-0.73	23.12	2.17	27.98	0.00	Average	100	171	HORIZONTAL
2	2298.96	58.17	74.00	-15.83	28.02	2.17	27.98	0.00	Peak	100	171	HORIZONTAL
3	2446.39				61.52	2.24	28.29	0.00	Average	100	171	HORIZONTAL
4	2447.19				77.03	2.24	28.29	0.00	Peak	100	171	HORIZONTAL
5	2484.30	49.56	54.00	-4.44	18.92	2.26	28.38	0.00	Average	100	171	HORIZONTAL
6	2491.51	68.54	74.00	-5.46	37.86	2.26	28.42	0.00	Peak	100	171	HORIZONTAL

Item 3, 4 are the fundamental frequency at 2452 MHz.

Temperature	26°C	Humidity	60%
Test Engineer	Magic Lai	Configurations	IEEE 802.11b CH 1, 6, 11 / Ant. 1 + Ant. 2
Test Date	Jun. 25, 2012	Test Mode	Mode 2

Channel 1

	Freq	Level	Limit Line	Over Limit	Read Level	Cable Loss	Antenna Factor	Preamp Factor	Remark	A/Pos	T/Pos	Pol/Phase
	MHz	dBuV/m	dBuV/m	dB	dBuV	dB	dB/m	dB		cm	deg	
1	2260.99	49.14	54.00	-4.86	19.13	2.14	27.87	0.00	Average	100	204	HORIZONTAL
2	2260.99	53.18	74.00	-20.82	23.17	2.14	27.87	0.00	Peak	100	204	HORIZONTAL
3	2410.40				79.98	2.22	28.21	0.00	Average	100	204	HORIZONTAL
4	2411.20				83.88	2.22	28.21	0.00	Peak	100	204	HORIZONTAL
5	2487.51	57.95	74.00	-16.05	27.27	2.26	28.42	0.00	Peak	100	204	HORIZONTAL
6	2493.92	50.34	54.00	-3.66	19.65	2.27	28.42	0.00	Average	100	204	HORIZONTAL

Item 3, 4 are the fundamental frequency at 2412 MHz.

Channel 6

	Freq	Level	Limit Line	Over Limit	Read Level	Cable Loss	Antenna Factor	Preamp Factor	Remark	A/Pos	T/Pos	Pol/Phase
	MHz	dBuV/m	dBuV/m	dB	dBuV	dB	dB/m	dB		cm	deg	
1	2285.03	50.65	54.00	-3.35	20.55	2.16	27.94	0.00	Average	100	204	HORIZONTAL
2	2285.03	54.28	74.00	-19.72	24.18	2.16	27.94	0.00	Peak	100	204	HORIZONTAL
3	2434.60				82.82	2.23	28.29	0.00	Peak	100	204	HORIZONTAL
4	2435.40				78.61	2.23	28.29	0.00	Average	100	204	HORIZONTAL
5	2483.50	40.17	54.00	-13.83	9.53	2.26	28.38	0.00	Average	100	204	HORIZONTAL
6	2483.50	52.25	74.00	-21.75	21.61	2.26	28.38	0.00	Peak	100	204	HORIZONTAL

Item 3, 4 are the fundamental frequency at 2437 MHz.

Channel 11

	Freq	Level	Limit Line	Over Limit	Read Level	Cable Loss	Antenna Factor	Preamp Factor	Remark	A/Pos	T/Pos	Pol/Phase
	MHz	dBuV/m	dBuV/m	dB	dBuV	dB	dB/m	dB		cm	deg	
1	2384.39	47.28	54.00	-6.72	16.90	2.21	28.17	0.00	Average	100	201	HORIZONTAL
2	2385.99	54.95	74.00	-19.05	24.57	2.21	28.17	0.00	Peak	100	201	HORIZONTAL
3	2463.60				76.49	2.24	28.33	0.00	Average	100	201	HORIZONTAL
4	2464.40				80.50	2.24	28.33	0.00	Peak	100	201	HORIZONTAL
5	2493.12	45.34	54.00	-8.66	14.65	2.27	28.42	0.00	Average	100	201	HORIZONTAL
6	2493.12	53.52	74.00	-20.48	22.83	2.27	28.42	0.00	Peak	100	201	HORIZONTAL

Item 3, 4 are the fundamental frequency at 2462 MHz.

Temperature	26°C	Humidity	60%
Test Engineer	Magic Lai	Configurations	IEEE 802.11g CH 1, 6, 11 / Ant. 1 + Ant. 2
Test Date	Jun. 25, 2012	Test Mode	Mode 2

Channel 1

	Freq	Level	Limit	Over	Read	Cable	Antenna	Preamp	Remark	A/Pos	T/Pos	Pol/Phase
	MHz	dBuV/m	dBuV/m	dB	dBuV	dB	dB/m	dB		cm	deg	
1	2260.72	52.98	54.00	-1.02	22.97	2.14	27.87	0.00	Average	100	151	HORIZONTAL
2	2261.36	55.84	74.00	-18.16	25.83	2.14	27.87	0.00	Peak	100	151	HORIZONTAL
3	2390.00	53.54	54.00	-0.46	23.15	2.22	28.17	0.00	Average	100	151	HORIZONTAL
4	2390.00	67.02	74.00	-6.98	36.63	2.22	28.17	0.00	Peak	100	151	HORIZONTAL
5	2410.72				74.39	2.22	28.21	0.00	Average	100	151	HORIZONTAL
6	2410.72				83.56	2.22	28.21	0.00	Peak	100	151	HORIZONTAL

Item 5, 6 are the fundamental frequency at 2412 MHz.

Channel 6

	Freq	Level	Limit	Over	Read	Cable	Antenna	Preamp	Remark	A/Pos	T/Pos	Pol/Phase
	MHz	dBuV/m	dBuV/m	dB	dBuV	dB	dB/m	dB		cm	deg	
1	2284.23	53.82	54.00	-0.18	23.72	2.16	27.94	0.00	Average	100	177	HORIZONTAL
2	2284.23	57.62	74.00	-16.38	27.52	2.16	27.94	0.00	Peak	100	177	HORIZONTAL
3	2431.23				82.87	2.23	28.25	0.00	Peak	100	177	HORIZONTAL
4	2435.72				70.60	2.23	28.29	0.00	Average	100	177	HORIZONTAL
5	2483.50	39.49	54.00	-14.51	8.85	2.26	28.38	0.00	Average	100	177	HORIZONTAL
6	2483.50	49.98	74.00	-24.02	19.34	2.26	28.38	0.00	Peak	100	177	HORIZONTAL

Item 3, 4 are the fundamental frequency at 2437 MHz.

Channel 11

	Freq	Level	Limit	Over	Read	Cable	Antenna	Preamp	Remark	A/Pos	T/Pos	Pol/Phase
	MHz	dBuV/m	dBuV/m	dB	dBuV	dB	dB/m	dB		cm	deg	
1	2461.36				69.27	2.24	28.33	0.00	Average	100	184	HORIZONTAL
2	2462.00				82.00	2.24	28.33	0.00	Peak	100	184	HORIZONTAL
3	2483.50	51.10	54.00	-2.90	20.46	2.26	28.38	0.00	Average	100	184	HORIZONTAL
4	2483.98	73.38	74.00	-0.62	42.74	2.26	28.38	0.00	Peak	100	184	HORIZONTAL

Item 1, 2 are the fundamental frequency at 2462 MHz.

Note:

Emission level (dBuV/m) = 20 log Emission level (uV/m).

Corrected Reading: Antenna Factor + Cable Loss + Read Level - Preamp Factor = Level.

For Emission not in Restricted Band

Plot on Configuration IEEE 802.11n MCS0 HT20MHz / Ant. 1 + Ant. 2 / 2412 MHz

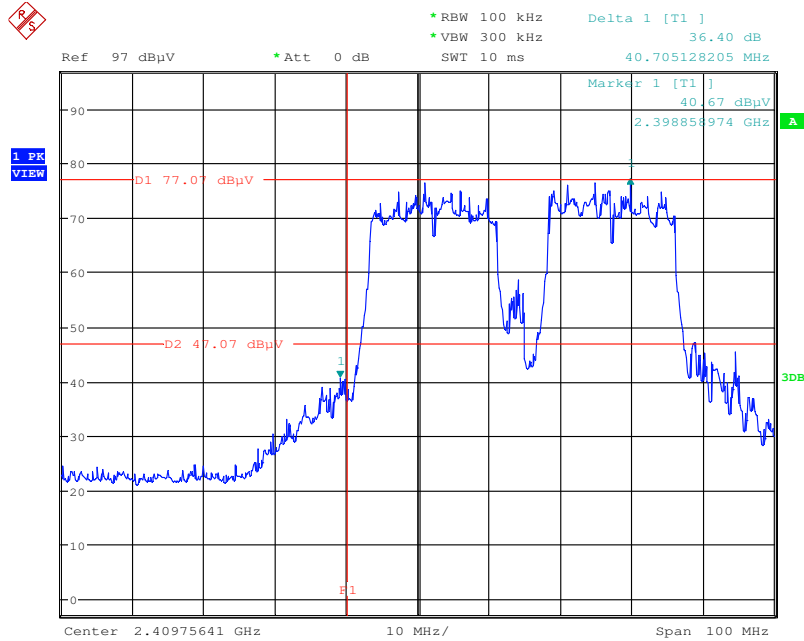

Date: 8.JUN.2012 19:10:28

Plot on Configuration IEEE 802.11n MCS0 HT20MHz / Ant. 1 + Ant. 2 / 2462 MHz

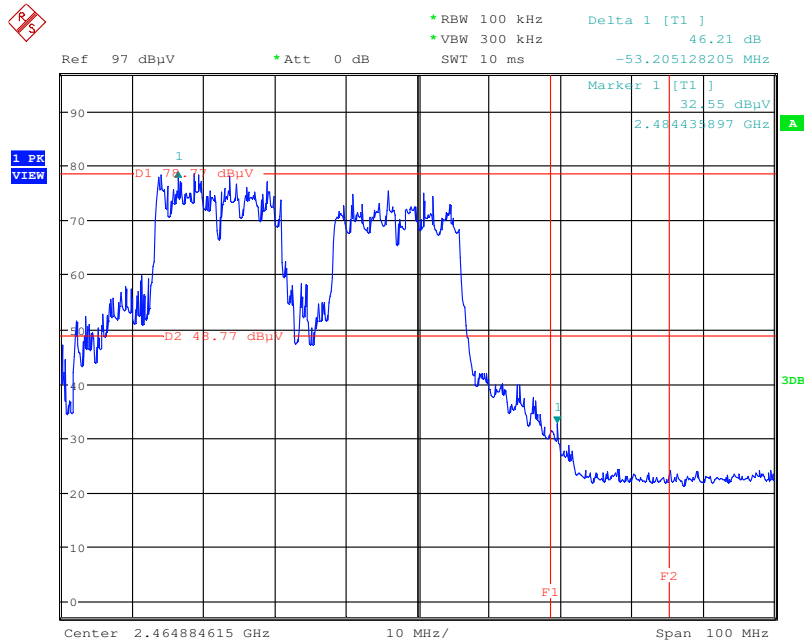

Date: 8.JUN.2012 19:13:44

Plot on Configuration IEEE 802.11n MCS0 HT40MHz / Ant. 1 + Ant. 2 / 2422 MHz

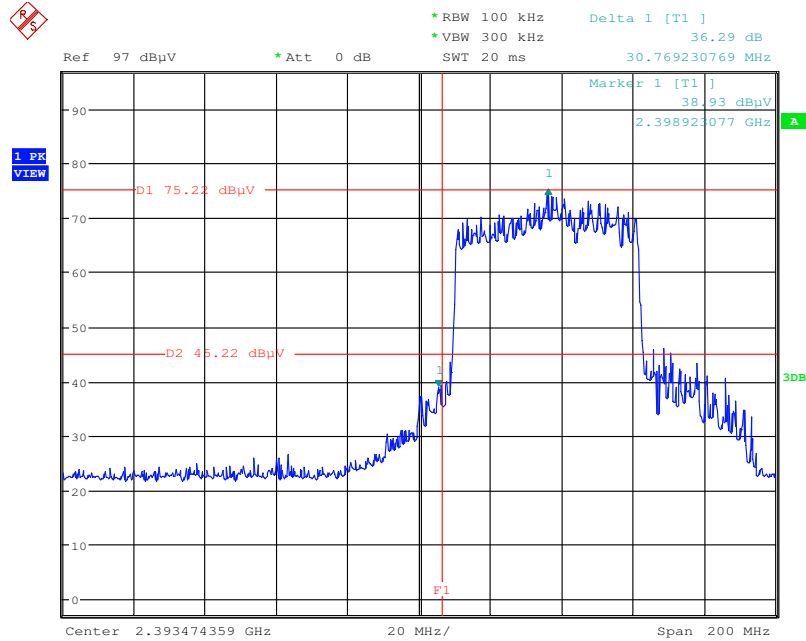

Date: 8.JUN.2012 19:16:18

Plot on Configuration IEEE 802.11n MCS0 HT40MHz / Ant. 1 + Ant. 2 / 2452 MHz

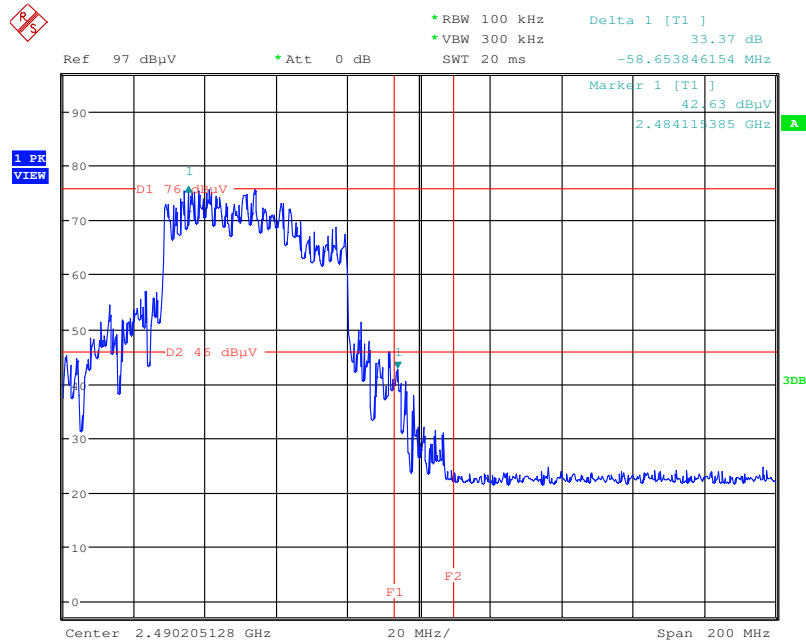

Date: 8.JUN.2012 19:19:16

Plot on Configuration IEEE 802.11b / Ant. 1 + Ant. 2 / 2412 MHz

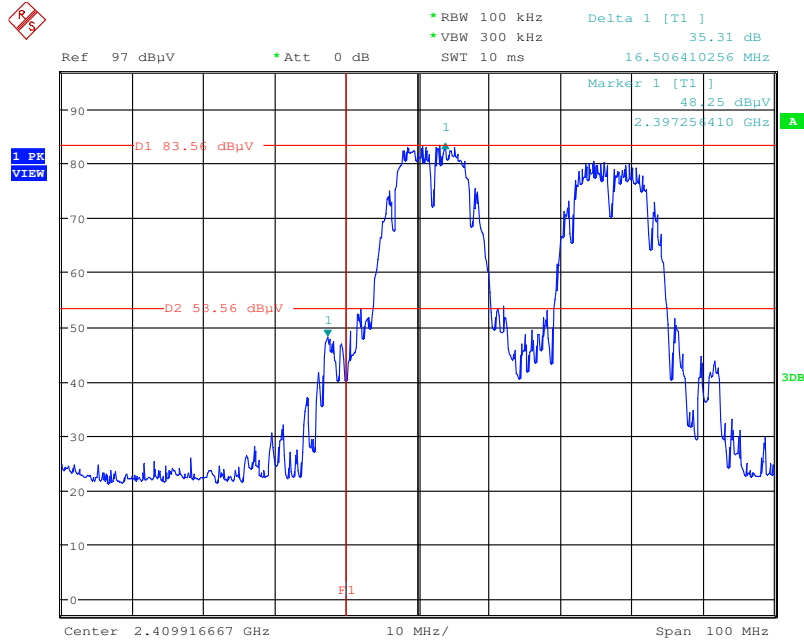

Date: 13.JUN.2012 15:28:13

Plot on Configuration IEEE 802.11b / Ant. 1 + Ant. 2 / 2462 MHz

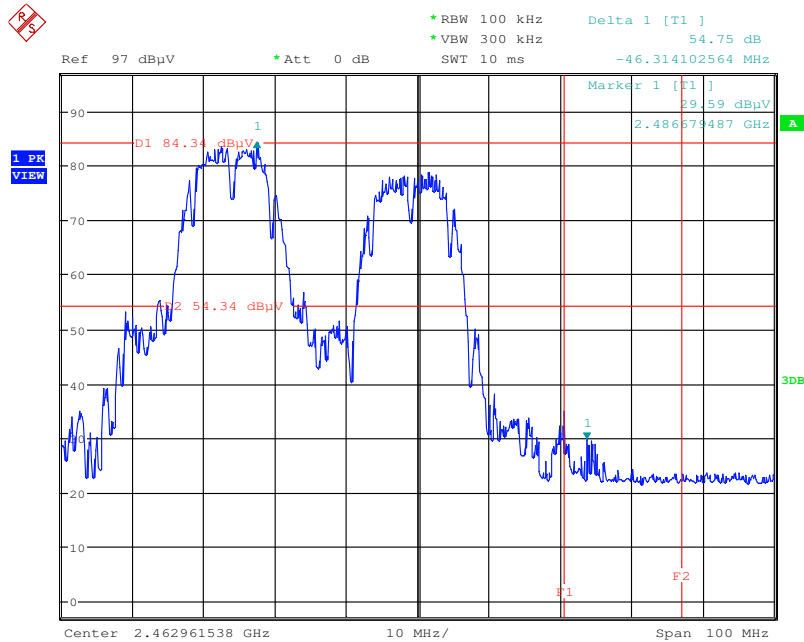

Date: 13.JUN.2012 15:33:01

Plot on Configuration IEEE 802.11g / Ant. 1 + Ant. 2 / 2412 MHz

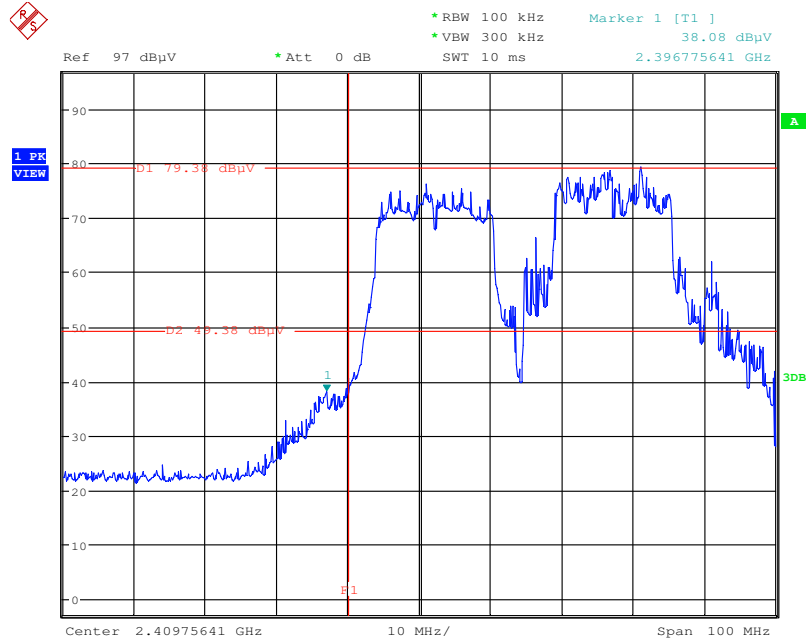

Date: 8.JUN.2012 19:08:15

Plot on Configuration IEEE 802.11g / Ant. 1 + Ant. 2 / 2462 MHz

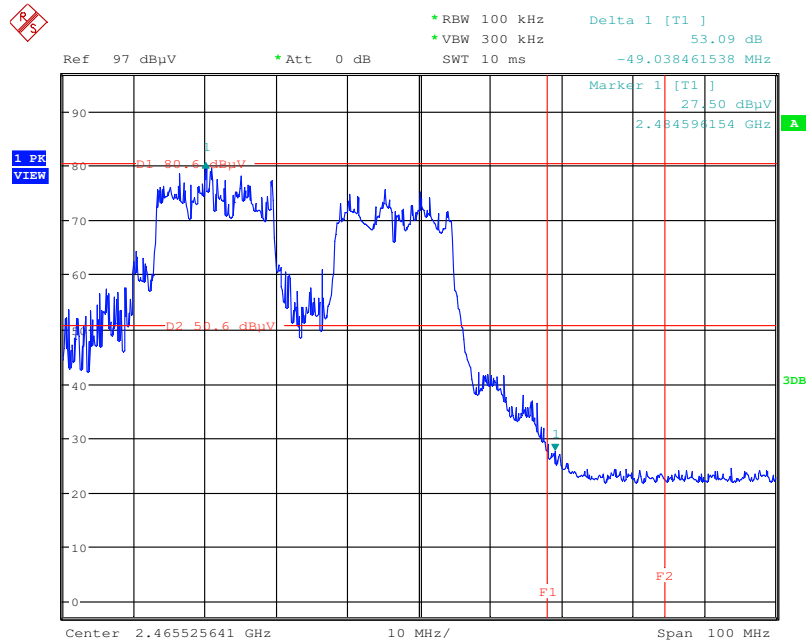

Date: 8.JUN.2012 19:05:34

Plot on Configuration IEEE 802.11n MCS0 HT20MHz / Ant. 1 + Ant. 2 / 5745 MHz

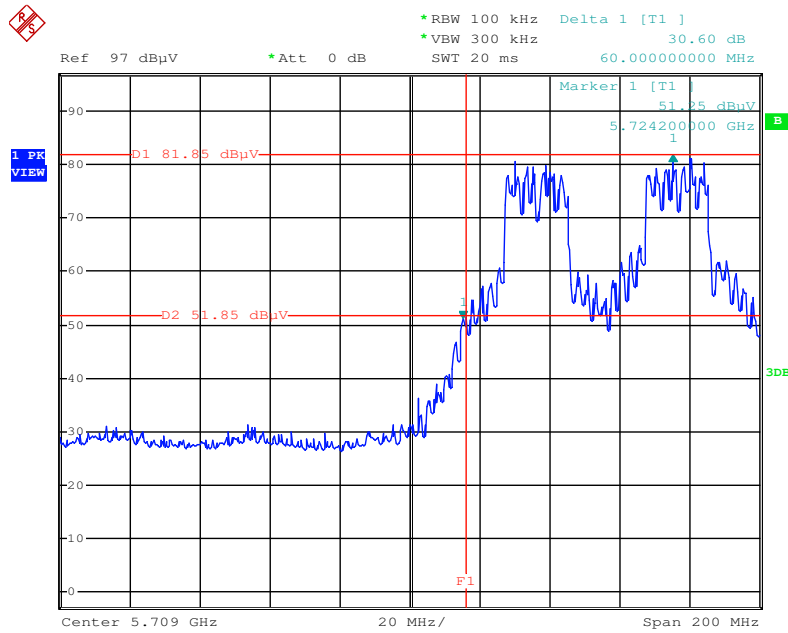

Date: 13.JUN.2012 18:25:23

Plot on Configuration IEEE 80211n MCS0 HT20MHz / Ant. 1 + Ant. 2 / 5825 MHz

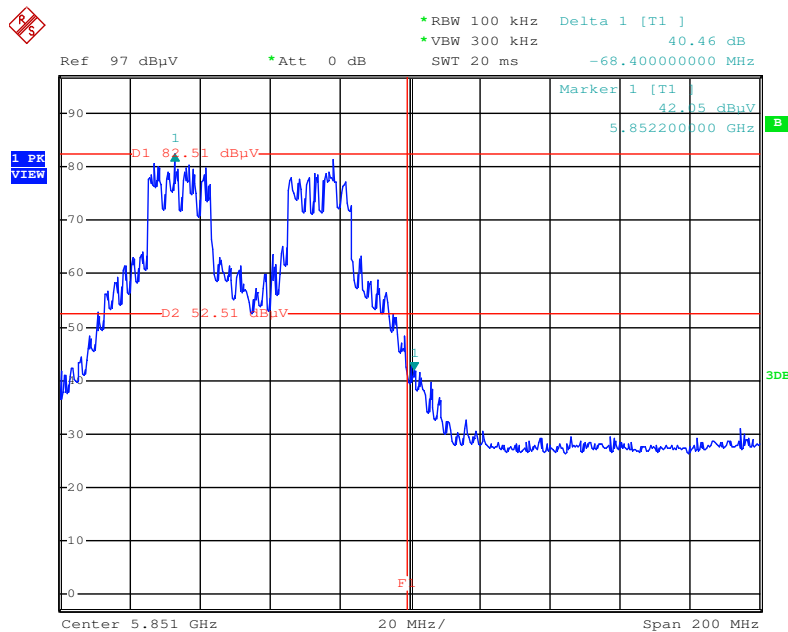

Date: 13.JUN.2012 18:28:50

Plot on Configuration IEEE 802.11n MCS0 HT40MHz / Ant. 1 + Ant. 2 / 5755 MHz

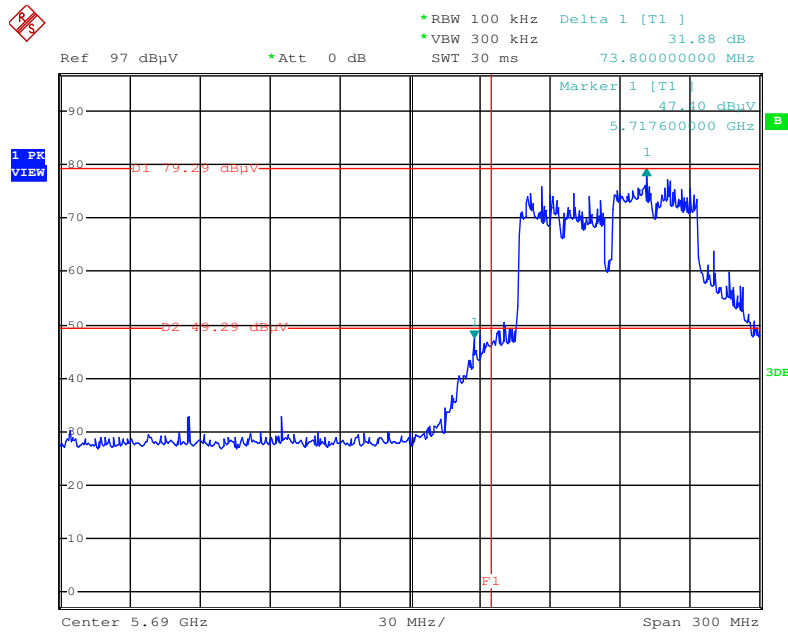

Date: 13.JUN.2012 18:50:45

Plot on Configuration IEEE 80211n MCS0 HT40MHz / Ant. 1 + Ant. 2 / 5795 MHz

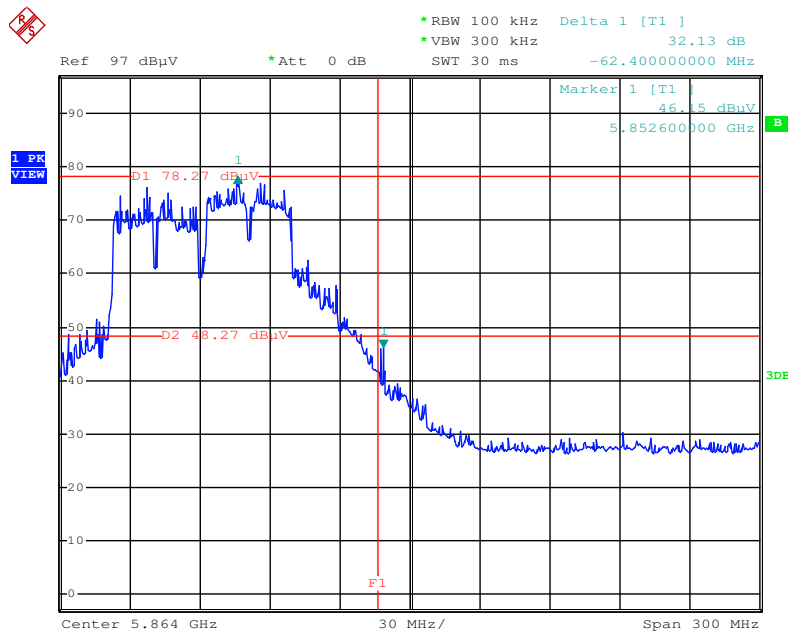

Date: 13.JUN.2012 18:55:21

Plot on Configuration IEEE 802.11a / Ant. 1 + Ant. 2 / 5745 MHz

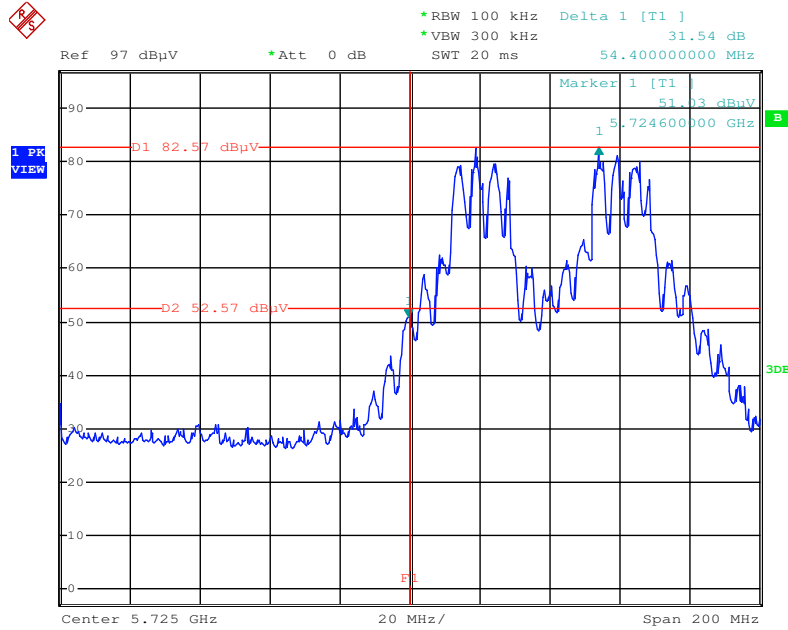

Date: 13.JUN.2012 18:13:03

Plot on Configuration IEEE 80211a / Ant. 1 + Ant. 2 / 5825 MHz

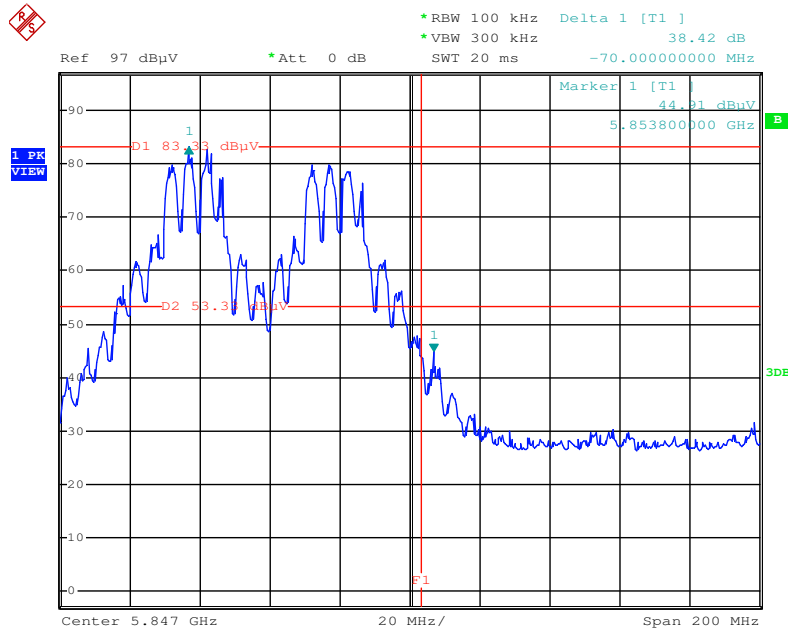

Date: 13.JUN.2012 18:15:56

Plot on Configuration IEEE 802.11ac MCS0 VHT 20MHz / Ant. 1 + Ant. 2 / 5745 MHz

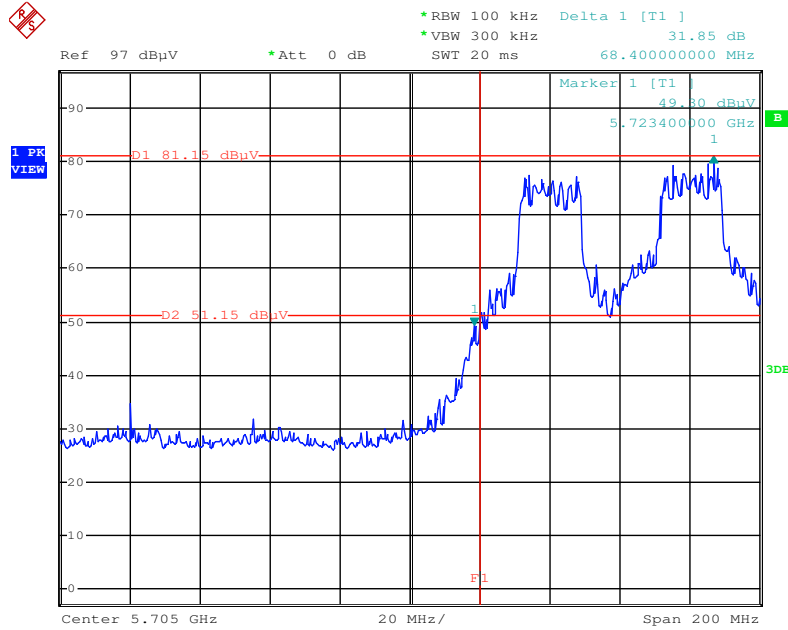

Date: 13.JUN.2012 19:04:30

Plot on Configuration IEEE 802.11ac MCS0 VHT 20MHz / Ant. 1 + Ant. 2 / 5825 MHz

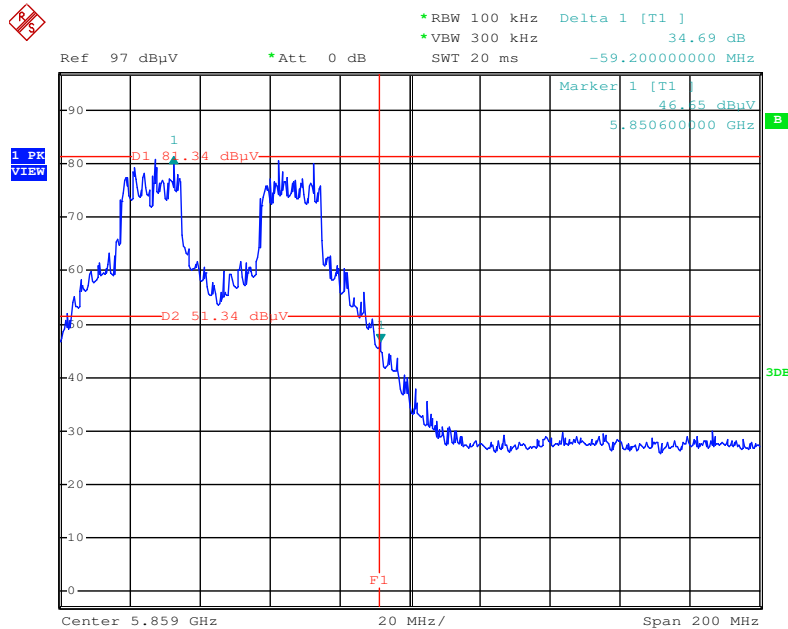

Date: 13.JUN.2012 19:07:16

Plot on Configuration IEEE 802.11ac MCS0 VHT 40MHz / Ant. 1 + Ant. 2 / 5755 MHz

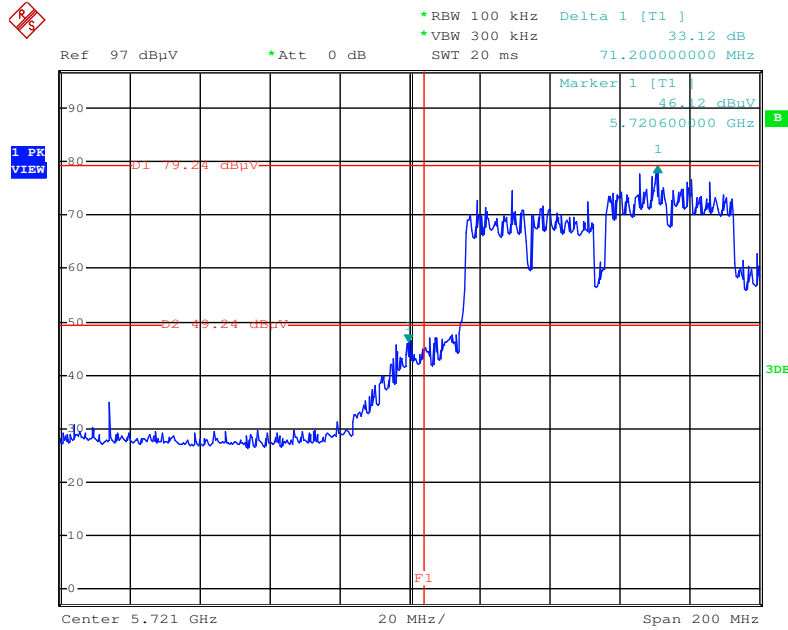

Date: 13.JUN.2012 19:15:28

Plot on Configuration IEEE 802.11ac MCS0 VHT 40MHz / Ant. 1 + Ant. 2 / 5795 MHz

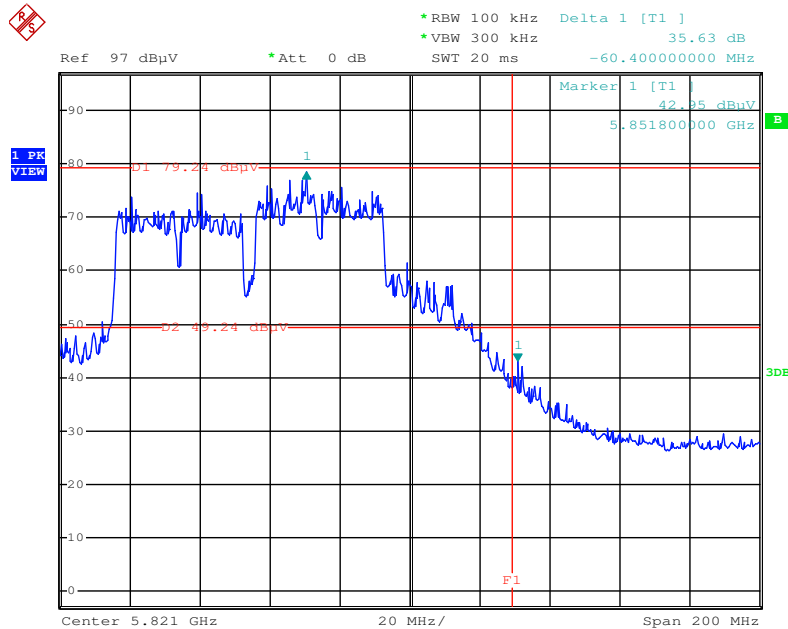

Date: 13.JUN.2012 19:17:22

Plot on Configuration IEEE 802.11ac MCS0 VHT 80MHz / Ant. 1 + Ant. 2 / 5775 MHz

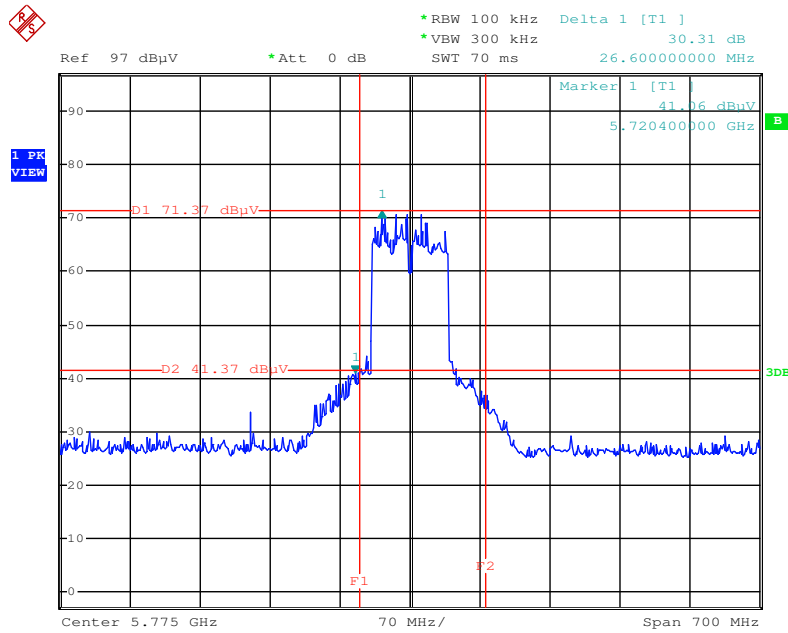

Date: 13.JUN.2012 19:57:00

4.7. Antenna Requirements

4.7.1. Limit

Except for special regulations, the Low-power Radio-frequency Devices must not be equipped with any jacket for installing an antenna with extension cable. An intentional radiator shall be designed to ensure that no antenna other than that furnished by the responsible party shall be used with the device. The use of a permanently attached antenna or of an antenna that uses a unique coupling to the intentional radiator shall be considered sufficient to comply with the provisions of this Section. The manufacturer may design the unit so that the user can replace a broken antenna, but the use of a standard antenna jack or electrical connector is prohibited. Further, this requirement does not apply to intentional radiators that must be professionally installed.

4.7.2. Antenna Connector Construction

Please refer to section 3.3 in this test report; antenna connector complied with the requirements.

5. LIST OF MEASURING EQUIPMENTS

Instrument	Manufacturer	Model No.	Serial No.	Characteristics	Calibration Date	Remark
EMI Test Receiver	R&S	ESCS 30	100377	9kHz ~ 2.75GHz	Sep. 14, 2011	Conduction (CO01-CB)
LISN	F.C.C.	FCC-LISN-50-16-2	04083	150kHz ~ 100MHz	Nov. 14, 2011	Conduction (CO01-CB)
V- LISN	Schwarzbeck	NSLK 8127	8127-478	9K ~ 30MHz	Nov. 30, 2011	Conduction (CO01-CB)
PULSE LIMITER	R&S	ESH3-Z2	100430	9K~30MHz	Feb. 03, 2012	Conduction (CO01-CB)
COND Cable	Woken	Cable	01	0.15MHz~30MHz	Dec. 4, 2011	Conduction (CO01-CB)
BILOG ANTENNA	Schaffner	CBL6112D	22021	20MHz ~ 2GHz	Jan. 11, 2012	Radiation (03CH01-CB)
Horn Antenna	EMCO	3115	00075790	750MHz~18GHz	Nov. 25, 2011	Radiation (03CH01-CB)
Horn Antenna	SCHWARZBEAK	BBHA 9170	BBHA9170252	15GHz ~ 40GHz	Nov. 22, 2011	Radiation (03CH01-CB)
Pre-Amplifier	Agilent	8449B	3008A02310	1GHz ~ 26.5GHz	Nov. 29, 2011	Radiation (03CH01-CB)
Spectrum analyzer	R&S	FSP40	100056	9KHz~40GHz	Nov. 03, 2011	Radiation (03CH01-CB)
EMI Test Receiver	R&S	ESCS 30	100355	9KHz ~ 2.75GHz	Mar. 20, 2012	Radiation (03CH01-CB)
Loop Antenna	Teseq	HLA 6120	24155	9 kHz - 30 MHz	Sep. 09, 2010*	Radiation (03CH01-CB)
Turn Table	INN CO	CO 2000	N/A	0 ~ 360 degree	N/A	Radiation (03CH01-CB)
Antenna Mast	INN CO	CO2000	N/A	1 m - 4 m	N/A	Radiation (03CH01-CB)
RF Cable-low	Woken	Low Cable-1	N/A	30 MHz - 1 GHz	Nov. 17, 2011	Radiation (03CH01-CB)
RF Cable-high	Woken	High Cable-1	N/A	1 GHz – 26.5 GHz	Nov. 17, 2011	Radiation (03CH01-CB)
RF Cable-high	Woken	High Cable-2	N/A	1 GHz – 26.5 GHz	Nov. 17, 2011	Radiation (03CH01-CB)
RF Cable-high	Woken	High Cable-3	N/A	1 GHz - 40 GHz	Nov. 17, 2011	Radiation (03CH01-CB)
RF Cable-high	Woken	High Cable-4	N/A	1 GHz - 40 GHz	Nov. 17, 2011	Radiation (03CH01-CB)
Signal analyzer	R&S	FSV40	100979	9KHz~40GHz	Sep. 26, 2011	Conducted (TH01-CB)
Temp. and Humidity Chamber	Ten Billion	TTH-D3SP	TBN-931011	-30~100 degree	May 20, 2012	Conducted (TH01-CB)
Thermo-Hygro Meter	N/A	HC 520	#1	15~70 degree	Nov. 02, 2011	Conducted (TH01-CB)
Signal Generator	R&S	SMR40	100302	10MHz-40GHz	Nov. 22, 2011	Conducted (TH01-CB)
RF Power Divider	HP	11636A	00306	2GHz ~ 18GHz	N/A	Conducted (TH01-CB)
RF Power Splitter	Anaren	44100	1839	2GHz ~ 18GHz	N/A	Conducted (TH01-CB)

Instrument	Manufacturer	Model No.	Serial No.	Characteristics	Calibration Date	Remark
RF Power Splitter	Anaren	42100	17930	2GHz ~ 18GHz	N/A	Conducted (TH01-CB)
Signal generator	R&S	SMU200A	102782	10MHz-40GHz	Jun. 07, 2012	Conducted (TH01-CB)
Horn Antenna	COM-POWER	AH-118	071187	1GHz – 18GHz	May 09, 2012	Conducted (TH01-CB)
Horn Antenna	COM-POWER	AH-118	071042	1GHz – 18GHz	Nov. 01, 2011	Conducted (TH01-CB)
RF Cable-high	Woken	High Cable-7	-	1 GHz – 26.5 GHz	Nov. 17, 2011	Conducted (TH01-CB)
RF Cable-high	Woken	High Cable-8	-	1 GHz – 26.5 GHz	Nov. 17, 2011	Conducted (TH01-CB)
RF Cable-high	Woken	High Cable-9	-	1 GHz – 26.5 GHz	Nov. 17, 2011	Conducted (TH01-CB)
RF Cable-high	Woken	High Cable-10	-	1 GHz – 26.5 GHz	Nov. 17, 2011	Conducted (TH01-CB)
RF Cable-high	Woken	High Cable-11	-	1 GHz – 26.5 GHz	Nov. 17, 2011	Conducted (TH01-CB)
RF Cable-high	Woken	High Cable-12	-	1 GHz – 26.5 GHz	Nov. 17, 2011	Conducted (TH01-CB)
RF Cable-high	Woken	High Cable-13	-	1 GHz – 26.5 GHz	Nov. 17, 2011	Conducted (TH01-CB)
Power Sensor	Anritsu	MA2411B	0917223	300MHz~40GHz	Nov. 01, 2011	Conducted (TH01-CB)
Power Meter	Anritsu	ML2495A	1035008	300MHz~40GHz	Nov. 01, 2011	Conducted (TH01-CB)

Note: Calibration Interval of instruments listed above is one year.

Note: "*" Calibration Interval of instruments listed above is two years.

6. TEST LOCATION

SHIJR	ADD : 6Fl., No. 106, Sec. 1, Shintai 5th Rd., Shijr City, Taipei, Taiwan 221, R.O.C. TEL : 886-2-2696-2468 FAX : 886-2-2696-2255
HWA YA	ADD : No. 52, Hwa Ya 1st Rd., Kwei-Shan Hsiang, Tao Yuan Hsien, Taiwan, R.O.C. TEL : 886-3-327-3456 FAX : 886-3-318-0055
LINKOU	ADD : No. 30-2, Dingfu Tsuen, Linkou Shiang, Taipei, Taiwan 244, R.O.C TEL : 886-2-2601-1640 FAX : 886-2-2601-1695
DUNGHU	ADD : No. 3, Lane 238, Kangle St., Neihu Chiu, Taipei, Taiwan 114, R.O.C. TEL : 886-2-2631-4739 FAX : 886-2-2631-9740
JUNGHE	ADD : 7Fl., No. 758, Jungjeng Rd., Junghe City, Taipei, Taiwan 235, R.O.C. TEL : 886-2-8227-2020 FAX : 886-2-8227-2626
NEIHU	ADD : 4Fl., No. 339, Hsin Hu 2 nd Rd., Taipei 114, Taiwan, R.O.C. TEL : 886-2-2794-8886 FAX : 886-2-2794-9777
JHUBEI	ADD : No.8, Lane 724, Bo-ai St., Jhubei City, HsinChu County 302, Taiwan, R.O.C. TEL : 886-3-656-9065 FAX : 886-3-656-9085

7. TAF CERTIFICATE OF ACCREDITATION



Certificate No. : L1190-110702

財團法人全國認證基金會
Taiwan Accreditation Foundation

Certificate of Accreditation

This is to certify that

Sporton International Inc.
EMC & Wireless Communications Laboratory
No.52, Hwa Ya 1st Road, Hwa Ya Technology Park, Kwei-Shan Hsiang, Tao Yuan Hsien,
Taiwan, R.O.C.

is accredited in respect of laboratory

Accreditation Criteria	: ISO/IEC 17025:2005
Accreditation Number	: 1190
Originally Accredited	: December 15, 2003
Effective Period	: January 10, 2010 to January 09, 2013
Accredited Scope	: Testing Field, see described in the Appendix
Specific Accreditation Program	: Accreditation Program for Designated Testing Laboratory for Commodities Inspection Accreditation Program for Telecommunication Equipment Testing Laboratory Accreditation Program for BSMI Mutual Recognition Arrangement with Foreign Authorities

Jay-San Chen
President, Taiwan Accreditation Foundation
Date : July 02, 2011

P1, total 22 pages

The Appendix forms an integral part of this Certificate, which shall be invalid when use without the Appendix