



FCC TEST REPORT

REPORT NO.: RF120511C23

MODEL NO.: PGZNG1, C24-HUB2, ASG1000

FCC ID: PY312100192

RECEIVED: May 11, 2012

TESTED: May 15 to 21, 2012

ISSUED: June 27, 2012

APPLICANT: Netgear Incorporated

ADDRESS: 350 East Plumeria Drive San Jose California
United States 95134

ISSUED BY: Bureau Veritas Consumer Products Services (H.K.) Ltd.,
Taoyuan Branch Hsin Chu Laboratory

LAB ADDRESS: No. 81-1, Lu Liao Keng, 9th Ling, Wu Lung Tsuen, Chiung
Lin Hsiang, Hsin Chu Hsien 307, Taiwan, R.O.C.

TEST LOCATION (1): No. 81-1, Lu Liao Keng, 9th Ling, Wu Lung Tsuen, Chiung
Lin Hsiang, Hsin Chu Hsien 307, Taiwan, R.O.C.

TEST LOCATION (2): No. 49, Ln. 206, Wende Rd., Shangshan Tsuen, Chiung
Lin Hsiang, Hsin Chu Hsien 307, Taiwan, R.O.C.

This report should not be used by the client to claim product certification, approval, or endorsement by TAF or any government agencies.



This report is for your exclusive use. Any copying or replication of this report to or for any other person or entity, or use of our name or trademark, is permitted only with our prior written permission. This report sets forth our findings solely with respect to the test samples identified herein. The results set forth in this report are not indicative or representative of the quality or characteristics of the lot from which a test sample was taken or any similar or identical product unless specifically and expressly noted. Our report includes all of the tests requested by you and the results thereof based upon the information that you provided to us. You have 60 days from date of issuance of this report to notify us of any material error or omission caused by our negligence, provided, however, that such notice shall be in writing and shall specifically address the issue you wish to raise. A failure to raise such issue within the prescribed time shall constitute your unqualified acceptance of the completeness of this report, the tests conducted and the correctness of the report contents. Unless specific mention, the uncertainty of measurement has been explicitly taken into account to declare the compliance or non-compliance to the specification



A D T

Table of Contents

RELEASE CONTROL RECORD	4
1. CERTIFICATION	5
2. SUMMARY OF TEST RESULTS	6
2.1 MEASUREMENT UNCERTAINTY	6
3. GENERAL INFORMATION	7
3.1 GENERAL DESCRIPTION OF EUT	7
3.2 DESCRIPTION OF TEST MODES	10
3.2.1 TEST MODE APPLICABILITY AND TESTED CHANNEL DETAIL	11
3.3 GENERAL DESCRIPTION OF APPLIED STANDARDS	14
3.4 DESCRIPTION OF SUPPORT UNITS.....	15
3.5 CONFIGURATION OF SYSTEM UNDER TEST	16
4. TEST TYPES AND RESULTS	17
4.1 CONDUCTED EMISSION MEASUREMENT	17
4.1.1 LIMITS OF CONDUCTED EMISSION MEASUREMENT	17
4.1.2 TEST INSTRUMENTS.....	17
4.1.3 TEST PROCEDURES	18
4.1.4 DEVIATION FROM TEST STANDARD	18
4.1.5 TEST SETUP	19
4.1.6 EUT OPERATING CONDITIONS	19
4.1.7 TEST RESULTS (MODE 1)	20
4.1.8 TEST RESULTS (MODE 2)	22
4.1.9 TEST RESULTS (MODE 3)	24
4.2 RADIATED EMISSION AND BANDEDGE MEASUREMENT	26
4.2.1 LIMITS OF RADIATED EMISSION AND BANDEDGE MEASUREMENT.....	26
4.2.2 TEST INSTRUMENTS.....	27
4.2.3 TEST PROCEDURES	28
4.2.4 DEVIATION FROM TEST STANDARD	28
4.2.5 TEST SETUP	29
4.2.6 EUT OPERATING CONDITIONS	29
4.2.7 TEST RESULTS	30
4.3 6dB BANDWIDTH MEASUREMENT	43
4.3.1 LIMITS OF 6dB BANDWIDTH MEASUREMENT	43
4.3.2 TEST INSTRUMENTS.....	43
4.3.3 TEST PROCEDURE.....	43
4.3.4 DEVIATION FROM TEST STANDARD	43
4.3.5 TEST SETUP	43
4.3.6 EUT OPERATING CONDITIONS	43
4.3.7 TEST RESULTS	44
4.4 CONDUCTED OUTPUT POWER MEASUREMENT	45
4.4.1 LIMITS OF MAXIMUM PEAK OUTPUT POWER MEASUREMENT	45



A D T

4.4.2	INSTRUMENTS.....	45
4.4.3	TEST PROCEDURES	45
4.4.4	DEVIATION FROM TEST STANDARD	45
4.4.5	TEST SETUP	45
4.4.6	EUT OPERATING CONDITIONS	45
4.4.7	TEST RESULTS	46
4.5	POWER SPECTRAL DENSITY MEASUREMENT.....	48
4.5.1	LIMITS OF POWER SPECTRAL DENSITY MEASUREMENT	48
4.5.2	TEST INSTRUMENTS.....	48
4.5.3	TEST PROCEDURE.....	48
4.5.4	DEVIATION FROM TEST STANDARD	48
4.5.5	TEST SETUP	48
4.5.6	EUT OPERATING CONDITION.....	48
4.5.7	TEST RESULTS	49
4.6	CONDUCTED OUT-BAND EMISSION MEASUREMENT.....	51
4.6.1	LIMITS OF CONDUCTED OUT-BAND EMISSION MEASUREMENT.....	51
4.6.2	TEST INSTRUMENTS.....	51
4.6.3	TEST PROCEDURE.....	51
4.6.4	DEVIATION FROM TEST STANDARD	52
4.6.5	TEST SETUP	52
4.6.6	EUT OPERATING CONDITION.....	52
4.6.7	TEST RESULTS	52
5.	PHOTOGRAPHS OF THE TEST CONFIGURATION.....	57
6.	INFORMATION ON THE TESTING LABORATORIES	58
7.	APPENDIX A - MODIFICATIONS RECORDERS FOR ENGINEERING CHANGES TO THE EUT BY THE LAB.....	59



A D T

RELEASE CONTROL RECORD

ISSUE NO.	REASON FOR CHANGE	DATE ISSUED
RF120511C23	Original release	June 27, 2012



A D T

1. CERTIFICATION

PRODUCT: Home Security
BRAND NAME: ADT, DSC, NTGR, G2i
MODEL NO.: PGZNG1, C24-HUB2, ASG1000
TEST SAMPLE: ENGINEERING SAMPLE
APPLICANT: Netgear Incorporated
TESTED: May 15 to 21, 2012
STANDARDS: **FCC Part 15, Subpart C (Section 15.247)**
ANSI C63.10-2009

The above equipment (Model: PGZNG1) has been tested by **Bureau Veritas Consumer Products Services (H.K.) Ltd., Taoyuan Branch**, and found compliance with the requirement of the above standards. The test record, data evaluation & Equipment Under Test (EUT) configurations represented herein are true and accurate accounts of the measurements of the sample's EMC characteristics under the conditions specified in this report.

PREPARED BY : Phoenix Huang , **DATE:** June 27, 2012
(Phoenix Huang, Specialist)

APPROVED BY : May Chen , **DATE:** June 27, 2012
(May Chen, Deputy Manager)

2. SUMMARY OF TEST RESULTS

The EUT has been tested according to the following specifications:

APPLIED STANDARD: FCC PART 15, SUBPART C (SECTION 15.247)			
STANDARD SECTION	TEST TYPE	RESULT	REMARK
15.207	AC Power Conducted Emission	PASS	Meet the requirement of limit. Minimum passing margin is -9.20dB at 0.30234MHz
15.247(d) 15.209	Radiated Emissions	PASS	Meet the requirement of limit. Minimum passing margin is -0.5dB at 2483.50MHz & 4874.00MHz
15.247(d)	Band Edge Measurement	PASS	Meet the requirement of limit.
15.247(a)(2)	6dB bandwidth	PASS	Meet the requirement of limit.
15.247(b)	Conducted power	PASS	Meet the requirement of limit.
15.247(e)	Power Spectral Density	PASS	Meet the requirement of limit.
15.203	Antenna Requirement	PASS	No antenna connector is used.

2.1 MEASUREMENT UNCERTAINTY

Where relevant, the following measurement uncertainty levels have been estimated for tests performed on the EUT as specified in CISPR 16-4-2:

This uncertainty represents an expanded uncertainty expressed at approximately the 95% confidence level using a coverage factor of $k=2$.

MEASUREMENT	FREQUENCY	UNCERTAINTY
Conducted emissions	150kHz ~ 30MHz	2.98dB
Radiated emission	30MHz ~ 1GHz	5.59 dB
	1GHz ~6GHz	5.12 dB
	6GHz ~ 18GHz	5.32 dB
	18GHz ~ 40GHz	5.37 dB



A D T

3. GENERAL INFORMATION

3.1 GENERAL DESCRIPTION OF EUT

PRODUCT	Home Security
MODEL NO.	PGZNG1, C24-HUB2, ASG1000
POWER SUPPLY	DC 12V from power adapter
MODULATION TYPE	CCK, DQPSK, DBPSK for DSSS 64QAM, 16QAM, QPSK, BPSK for OFDM
MODULATION TECHNOLOGY	DSSS, OFDM
TRANSFER RATE	802.11b: up to 11Mbps 802.11g: up to 54Mbps 802.11n: up to 300Mbps
OPERATING FREQUENCY	2.412 ~ 2.462GHz
NUMBER OF CHANNEL	11 for 802.11b, 802.11g, 802.11n (20MHz) 7 for 802.11n (40MHz)
MAXIMUM OUTPUT POWER	802.11b: 172.210mW 802.11g: 734.613mW 802.11n (20MHz): 710.379mW 802.11n (40MHz): 586.621mW
ANTENNA TYPE	Please see NOTE
DATA CABLE	NA
I/O PORTS	Refer to user's manual
ASSOCIATED DEVICES	Adapter × 1

NOTE:

1. There are WLAN technology and Z-Wave technology used for the EUT. <the Z-Wave test data please refer " Report No.: RF120511C23-1">

2. The EUT has three model names and four brand names which are identical to each other in all aspects except for the following table:

Brand	Model Name	Description
ADT	PGZNG1	for different brand name
DSC	C24-HUB2	
NTGR	ASG1000	
G2i		

From the above models, model: **PGZNG1** was selected as representative model for the test and its data was recorded in this report.

3. The EUT could be supplied with a power adapter, following three different adapter models could be chosen as following table:

No	Brand	Model No.	Spec.
1	NETGEAR	MT18-9120150-A1	Input: 120V, 60Hz, 0.5A Output: 12V, 1.5A (unshielded 1.8m)
2	NETGEAR	AD817F10	Input: 100-120V, 50/60Hz, 0.56A Output: 12V, 1.5A (unshielded 1.8m)
3	NETGEAR	SAL018F1 NA	Input: 100-120V, 47/63Hz, 0.6A Output: 12V, 1.5A (unshielded 1.8m)

For radiated test, the EUT was pre-tested with above adapters, the worse case was found in adapter 1. Therefore only the test data of the adapter was recorded in this report.

4. There are three antennas provided to this EUT, please refer to the following table:

For WLAN			
Transmitter Circuit	Antenna Type	Peak Gain (dBi)	Connector Type
Chain (1)	PIFA	3.85	iPEX
Chain (2)	PIFA	4.01	iPEX
For Z-Wave			
Antenna Type	Peak Gain (dBi)	Connector Type	
Dipole	3.1	iPEX	

5. The EUT incorporates a MIMO function.

MODULATION MODE	TX/Rx FUNCTION
802.11b	2Tx/2Rx
802.11g	2Tx/2Rx
802.11n (20MHz)	2Tx/2Rx
802.11n (40MHz)	2Tx/2Rx

6. Radiated emission of the simultaneous operation (WiFi & Z-Wave) has been evaluated and no non-compliance was found.



A D T

7. The EUT incorporates CDD function with 802.11b, 802.11g and MIMO function with 802.11n.
8. The EUT is 2 * 2 spatial MIMO (2Tx & 2Rx) without beam forming function.
9. When the EUT operating in 802.11n, the software operation, which is defined by manufacturer, MCS (Modulation and Coding Schemes) from 0 to 15.
10. The above EUT information was declared by the manufacturer and for more detailed features description, please refer to the manufacturer's specifications or User's Manual.

3.2 DESCRIPTION OF TEST MODES

Eleven channels are provided for 802.11b, 802.11g, 802.11n (20MHz):

CHANNEL	FREQUENCY	CHANNEL	FREQUENCY
1	2412MHz	7	2442MHz
2	2417MHz	8	2447MHz
3	2422MHz	9	2452MHz
4	2427MHz	10	2457MHz
5	2432MHz	11	2462MHz
6	2437MHz		

Seven channels are provided for 802.11n (40MHz):

CHANNEL	FREQUENCY	CHANNEL	FREQUENCY
3	2422MHz	7	2442MHz
4	2427MHz	8	2447MHz
5	2432MHz	9	2452MHz
6	2437MHz		



3.2.1 TEST MODE APPLICABILITY AND TESTED CHANNEL DETAIL

EUT CONFIGURE MODE	APPLICABLE TO					DESCRIPTION
	PLC	RE < 1G	RE ≥ 1G	APCM	OB	
1	√	√	√	√	√	Adapter 1
2	√	-	-	-	-	Adapter 2
3	√	-	-	-	-	Adapter 3

Where **PLC**: Power Line Conducted Emission **RE < 1G**: Radiated Emission below 1GHz
RE ≥ 1G: Radiated Emission above 1GHz **APCM**: Antenna Port Conducted Measurement
OB: Conducted Out-Band Emission Measurement

Note: The EUT had been pre-tested on the positioned of each 2 polarity. The worst case was found when positioned on laying – flat.

POWER LINE CONDUCTED EMISSION TEST:

- Pre-Scan has been conducted to determine the worst-case mode from all possible combinations between available modulations, data rates and antenna ports (if EUT with antenna diversity architecture).
- Following channel(s) was (were) selected for the final test as listed below.

MODE	AVAILABLE CHANNEL	TESTED CHANNEL	MODULATION TECHNOLOGY	MODULATION TYPE	DATA RATE (Mbps)
802.11g	1 to 11	6	OFDM	BPSK	6

RADIATED EMISSION TEST (BELOW 1 GHz):

- Pre-Scan has been conducted to determine the worst-case mode from all possible combinations between available modulations, data rates and antenna ports (if EUT with antenna diversity architecture).
- Following channel(s) was (were) selected for the final test as listed below.

MODE	AVAILABLE CHANNEL	TESTED CHANNEL	MODULATION TECHNOLOGY	MODULATION TYPE	DATA RATE (Mbps)
802.11g	1 to 11	6	OFDM	BPSK	6

RADIATED EMISSION TEST (ABOVE 1 GHZ):

- Pre-Scan has been conducted to determine the worst-case mode from all possible combinations between available modulations, data rates and antenna ports (if EUT with antenna diversity architecture).
- Following channel(s) was (were) selected for the final test as listed below.

MODE	AVAILABLE CHANNEL	TESTED CHANNEL	MODULATION TECHNOLOGY	MODULATION TYPE	DATA RATE (Mbps)
802.11b	1 to 11	1, 6, 11	DSSS	DBPSK	1
802.11g	1 to 11	1, 6, 11	OFDM	BPSK	6
802.11n (20MHz)	1 to 11	1, 6, 11	OFDM	BPSK	6.5
802.11n (40MHz)	3 to 9	3, 6, 9	OFDM	BPSK	13.5

ANTENNA PORT CONDUCTED MEASUREMENT:

- Pre-Scan has been conducted to determine the worst-case mode from all possible combinations between available modulations, data rates and antenna ports (if EUT with antenna diversity architecture).
- Following channel(s) was (were) selected for the final test as listed below.

MODE	AVAILABLE CHANNEL	TESTED CHANNEL	MODULATION TECHNOLOGY	MODULATION TYPE	DATA RATE (Mbps)
802.11b	1 to 11	1, 6, 11	DSSS	DBPSK	1
802.11g	1 to 11	1, 6, 11	OFDM	BPSK	6
802.11n (20MHz)	1 to 11	1, 6, 11	OFDM	BPSK	6.5
802.11n (40MHz)	3 to 9	3, 6, 9	OFDM	BPSK	13.5

CONDUCTED OUT-BAND EMISSION MEASUREMENT:

- Pre-Scan has been conducted to determine the worst-case mode from all possible combinations between available modulations, data rates and antenna ports (if EUT with antenna diversity architecture).
- Following channel(s) was (were) selected for the final test as listed below.

MODE	AVAILABLE CHANNEL	TESTED CHANNEL	MODULATION TECHNOLOGY	MODULATION TYPE	DATA RATE (Mbps)
802.11b	1 to 11	1, 6, 11	DSSS	DBPSK	1
802.11g	1 to 11	1, 6, 11	OFDM	BPSK	6
802.11n (20MHz)	1 to 11	1, 6, 11	OFDM	BPSK	6.5
802.11n (40MHz)	3 to 9	3, 6, 9	OFDM	BPSK	13.5



A D T

TEST CONDITION:

APPLICABLE TO	ENVIRONMENTAL CONDITIONS	INPUT POWER	TESTED BY
PLC	25deg. C, 75%RH	120Vac, 60Hz	JyunChun Lin
RE<1G	20deg. C, 63%RH	120Vac, 60Hz	Frank Liu
RE ³ 1G	27deg. C, 75%RH	120Vac, 60Hz	Frank Liu
APCM	25deg. C, 60%RH	120Vac, 60Hz	Nelson Teng
OB	25deg. C, 60%RH	120Vac, 60Hz	Nelson Teng

3.3 GENERAL DESCRIPTION OF APPLIED STANDARDS

The EUT is a RF product. According to the specifications of the manufacturer, it must comply with the requirements of the following standards:

FCC Part 15, Subpart C (15.247)

ANSI C63.10-2009

All test items have been performed and recorded as per the above standards.

NOTE: The EUT has been verified to comply with the requirements of FCC Part 15, Subpart B, Class B (DoC). The test report has been issued separately.



A D T

3.4 DESCRIPTION OF SUPPORT UNITS

The EUT has been tested as an independent unit together with other necessary accessories or support units. The following support units or accessories were used to form a representative test configuration during the tests.

NO.	PRODUCT	BRAND	MODEL NO.	SERIAL NO.	FCC ID
1	NOTEBOOK COMPUTER	DELL	PP32LA	FSLB32S	FCC DoC
2	NOTEBOOK COMPUTER	DELL	PP32LA	GSLB32S	FCC DoC
3	iPod shuffle	Apple	MC749TA/A	CC4DN25WDF DM	NA

NO.	SIGNAL CABLE DESCRIPTION OF THE ABOVE SUPPORT UNITS
1	UTP cable, 10m
2	UTP cable, 10m
3	USB cable, 0.1m

NOTE: All power cords of the above support units are non shielded (1.8m).

3.5 CONFIGURATION OF SYSTEM UNDER TEST

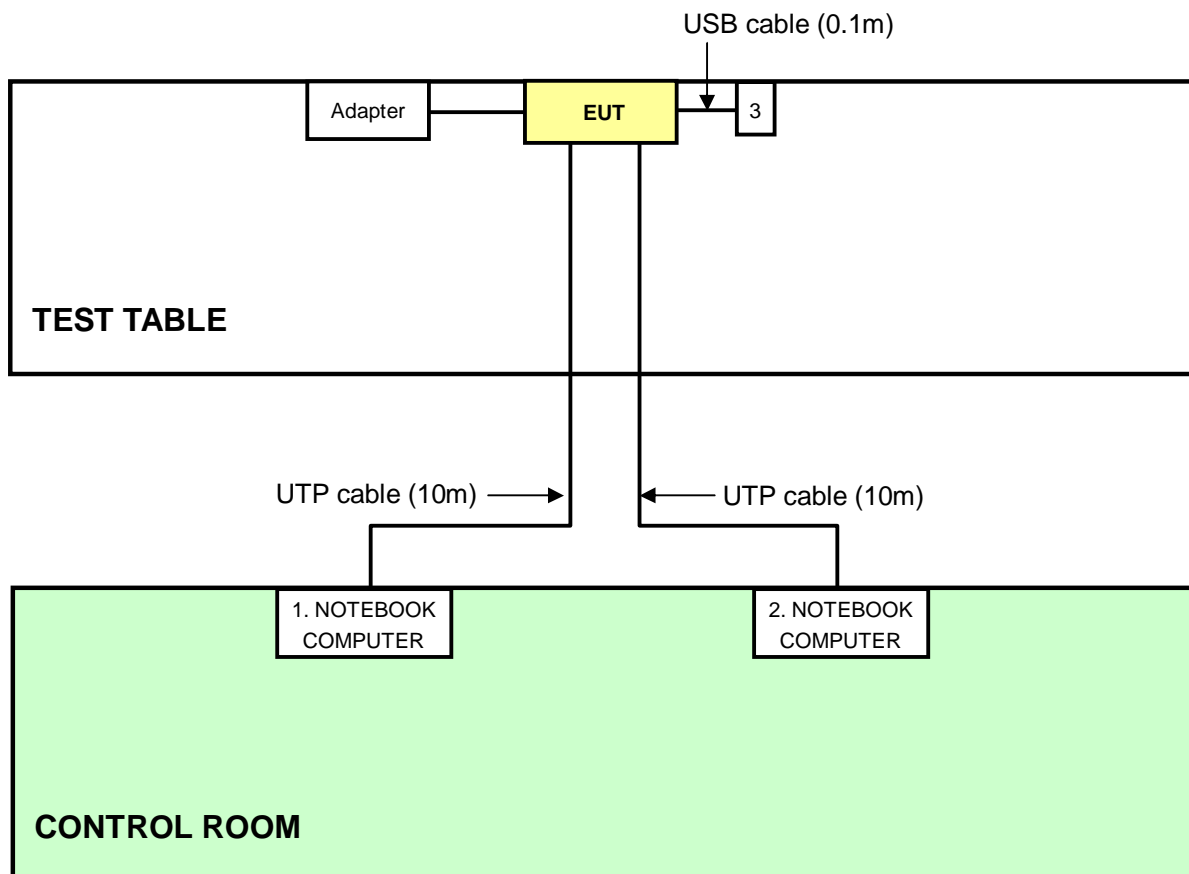



A D T

4. TEST TYPES AND RESULTS

4.1 CONDUCTED EMISSION MEASUREMENT

4.1.1 LIMITS OF CONDUCTED EMISSION MEASUREMENT

FREQUENCY OF EMISSION (MHz)	CONDUCTED LIMIT (dB μ V)	
	Quasi-peak	Average
0.15-0.5	66 to 56	56 to 46
0.5-5	56	46
5-30	60	50

- NOTE:**
1. The lower limit shall apply at the transition frequencies.
 2. The limit decreases in line with the logarithm of the frequency in the range of 0.15 to 0.50 MHz.

4.1.2 TEST INSTRUMENTS

DESCRIPTION & MANUFACTURER	MODEL NO.	SERIAL NO.	CALIBRATED DATE	CALIBRATED UNTIL
Test Receiver	ESCS 30	100375	Mar. 08, 2012	Mar. 07, 2013
Line-Impedance Stabilization Network (for EUT) SCHWARZBECK	NSLK8127	8127-522	Sep. 07, 2011	Sep. 06, 2012
Line-Impedance Stabilization Network (for Peripheral)	ESH3-Z5	848773/004	Nov. 02, 2011	Nov. 01, 2012
RF Cable (JYEBAO)	5DFB	COCCAB-001	Aug. 29, 2011	Aug. 28, 2012
50 ohms Terminator	50	3	Nov. 02, 2011	Nov. 01, 2012
Software ADT	BV ADT_Cond_V7.3.7	NA	NA	NA

Note:

1. The calibration interval of the above test instruments is 12 months and the calibrations are traceable to NML/ROC and NIST/USA.
2. The test was performed in Shielded Room No. C.
3. The VCCI Con C Registration No. is C-3611.
4. Tested Date: May 21, 2012

4.1.3 TEST PROCEDURES

- a. The EUT/HOST was placed 0.4 meters from the conducting wall of the shielded room with EUT/HOST being connected to the power mains through a line impedance stabilization network (LISN). Other support units were connected to the power mains through another LISN. The two LISNs provide 50 ohm/ 50uH of coupling impedance for the measuring instrument.
- b. Both lines of the power mains connected to the EUT were checked for maximum conducted interference.
- c. The frequency range from 150kHz to 30MHz was searched. Emission levels under (Limit - 20dB) were not recorded.

4.1.4 DEVIATION FROM TEST STANDARD

No deviation

4.1.5 TEST SETUP

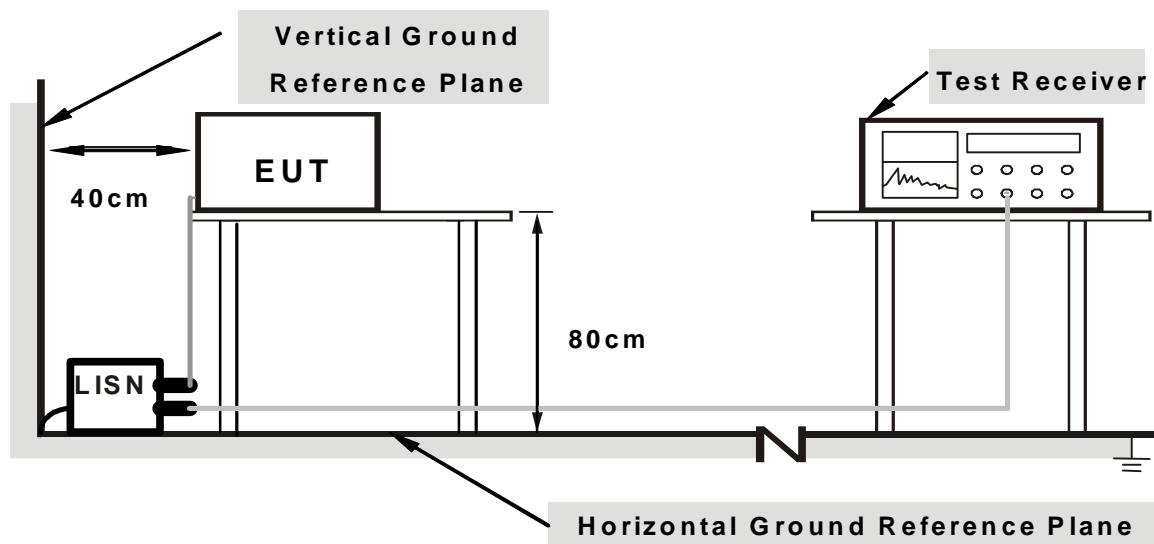

Note: 1. Support units were connected to second LISN.

2. Both of LISNs (AMN) are 80 cm from EUT and at least 80 from other units and other metal planes

For the actual test configuration, please refer to the related item – Photographs of the Test Configuration.

4.1.6 EUT OPERATING CONDITIONS

1. Placed the EUT on testing table.
2. Prepared computer system (support unit 1) to act as communication partner.
3. The communication partner ran test program “artgui.exe” to enable EUT under transmission/receiving condition continuously.

4.1.7 TEST RESULTS (MODE 1)

PHASE	Line (L)	6dB BANDWIDTH	9 kHz
--------------	----------	----------------------	-------

No	Freq. [MHz]	Corr. Factor (dB)	Reading Value [dB (uV)]		Emission Level [dB (uV)]		Limit [dB (uV)]		Margin (dB)	
			Q.P.	AV.	Q.P.	AV.	Q.P.	AV.	Q.P.	AV.
			1	0.16172	0.07	46.14	40.45	46.21	40.52	65.38
2	0.28478	0.09	33.11	29.18	33.20	29.27	60.68	50.68	-27.47	-21.40
3	0.50156	0.12	37.10	29.55	37.22	29.67	56.00	46.00	-18.78	-16.33
4	0.95859	0.15	23.42	15.43	23.57	15.58	56.00	46.00	-32.43	-30.42
5	2.11328	0.28	24.94	15.46	25.22	15.74	56.00	46.00	-30.78	-30.26
6	10.94141	0.75	31.29	26.84	32.04	27.59	60.00	50.00	-27.96	-22.41

REMARKS:

1. Q.P. and AV. are abbreviations of quasi-peak and average individually.
2. The emission levels of other frequencies were very low against the limit.
3. Margin value = Emission level - Limit value
4. Correction factor = Insertion loss + Cable loss
5. Emission Level = Correction Factor + Reading Value.

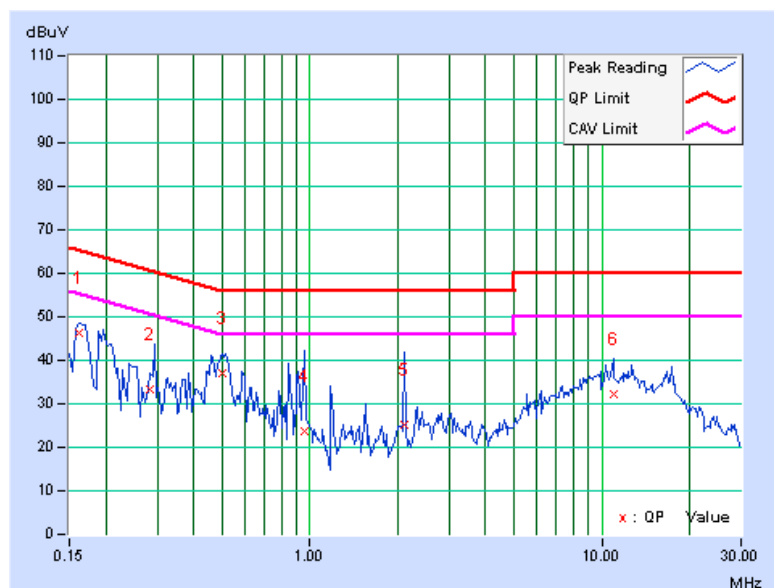

PHASE	Neutral (N)	6dB BANDWIDTH	9 kHz
-------	-------------	---------------	-------

No	Freq. [MHz]	Corr. Factor (dB)	Reading Value [dB (uV)]		Emission Level [dB (uV)]		Limit [dB (uV)]		Margin (dB)	
			Q.P.	AV.	Q.P.	AV.	Q.P.	AV.	Q.P.	AV.
			1	0.16562	0.06	45.75	37.59	45.81	37.65	65.18
2	0.49766	0.10	33.10	28.57	33.20	28.67	56.04	46.04	-22.84	-17.37
3	0.92734	0.11	24.80	12.78	24.91	12.89	56.00	46.00	-31.09	-33.11
4	1.47656	0.15	27.37	13.37	27.52	13.52	56.00	46.00	-28.48	-32.48
5	2.21484	0.20	24.60	12.61	24.80	12.81	56.00	46.00	-31.20	-33.19
6	12.30859	0.69	30.36	25.66	31.05	26.35	60.00	50.00	-28.95	-23.65

REMARKS:

1. Q.P. and AV. are abbreviations of quasi-peak and average individually.
2. The emission levels of other frequencies were very low against the limit.
3. Margin value = Emission level - Limit value
4. Correction factor = Insertion loss + Cable loss
5. Emission Level = Correction Factor + Reading Value.

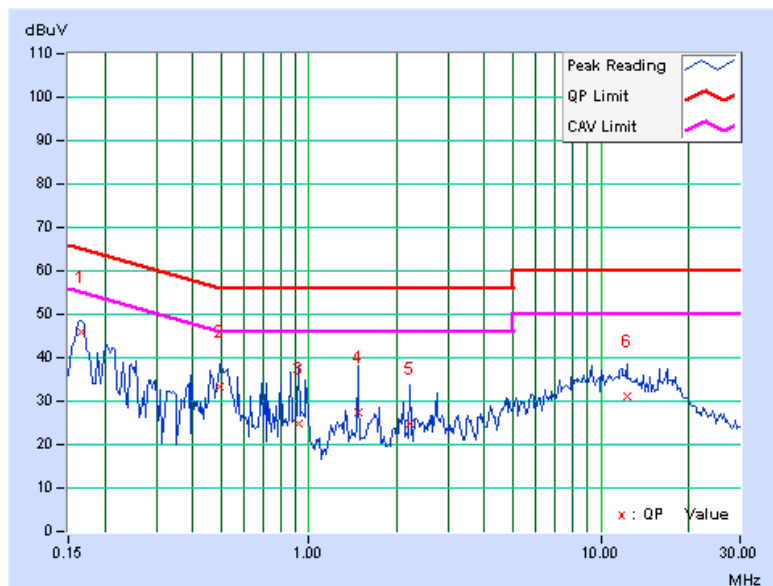

4.1.8 TEST RESULTS (MODE 2)

PHASE	Line (L)	6dB BANDWIDTH	9 kHz
-------	----------	---------------	-------

No	Freq. [MHz]	Corr. Factor (dB)	Reading Value		Emission Level		Limit		Margin	
			[dB (uV)]		[dB (uV)]		[dB (uV)]		(dB)	
			Q.P.	AV.	Q.P.	AV.	Q.P.	AV.	Q.P.	AV.
1	0.15781	0.07	53.79	30.08	53.86	30.15	65.58	55.58	-11.72	-25.43
2	0.18906	0.08	52.56	27.51	52.64	27.59	64.08	54.08	-11.44	-26.49
3	0.26328	0.09	49.73	23.98	49.82	24.07	61.33	51.33	-11.51	-27.26
4	0.30209	0.10	47.63	20.10	47.73	20.20	60.19	50.19	-12.46	-29.99
5	0.34141	0.10	44.14	20.13	44.24	20.23	59.17	49.17	-14.93	-28.94
6	0.43516	0.11	42.29	20.58	42.40	20.69	57.15	47.15	-14.75	-26.46
7	0.58359	0.12	40.13	12.33	40.25	12.45	56.00	46.00	-15.75	-33.55
8	0.85703	0.14	32.62	9.14	32.76	9.28	56.00	46.00	-23.24	-36.72

REMARKS:

1. Q.P. and AV. are abbreviations of quasi-peak and average individually.
2. The emission levels of other frequencies were very low against the limit.
3. Margin value = Emission level - Limit value
4. Correction factor = Insertion loss + Cable loss
5. Emission Level = Correction Factor + Reading Value.

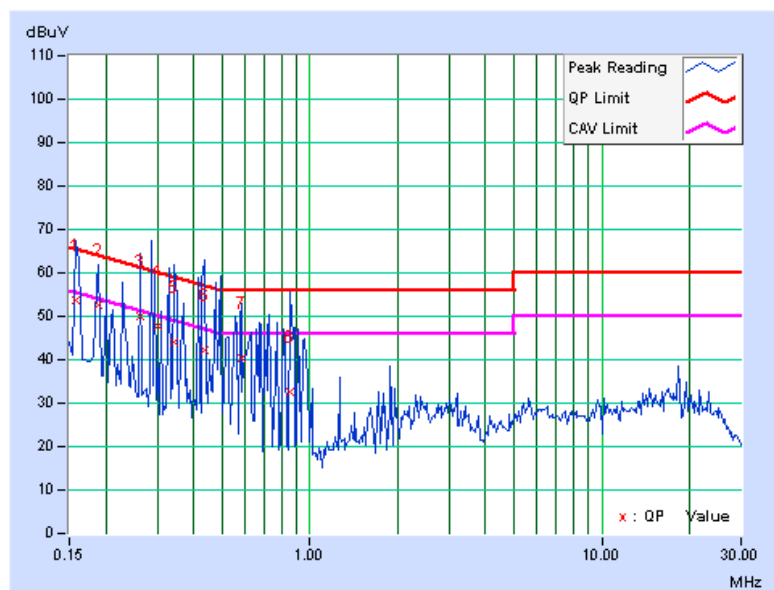

PHASE	Neutral (N)	6dB BANDWIDTH	9 kHz
--------------	-------------	----------------------	-------

No	Freq. [MHz]	Corr. Factor (dB)	Reading Value		Emission Level		Limit		Margin	
			[dB (uV)]		[dB (uV)]		[dB (uV)]		(dB)	
			Q.P.	AV.	Q.P.	AV.	Q.P.	AV.	Q.P.	AV.
1	0.18516	0.07	52.57	27.28	52.64	27.35	64.25	54.25	-11.61	-26.90
2	0.25938	0.08	46.53	21.18	46.61	21.26	61.45	51.45	-14.84	-30.19
3	0.34531	0.09	37.86	16.30	37.95	16.39	59.07	49.07	-21.12	-32.68
4	0.41953	0.10	42.58	20.26	42.68	20.36	57.46	47.46	-14.78	-27.10
5	0.50000	0.10	37.97	14.22	38.07	14.32	56.00	46.00	-17.93	-31.68
6	0.64219	0.10	38.45	13.03	38.55	13.13	56.00	46.00	-17.45	-32.87
7	0.84922	0.11	30.02	8.59	30.13	8.70	56.00	46.00	-25.87	-37.30
8	0.99766	0.11	30.34	8.47	30.45	8.58	56.00	46.00	-25.55	-37.42

REMARKS:

1. Q.P. and AV. are abbreviations of quasi-peak and average individually.
2. The emission levels of other frequencies were very low against the limit.
3. Margin value = Emission level - Limit value
4. Correction factor = Insertion loss + Cable loss
5. Emission Level = Correction Factor + Reading Value.

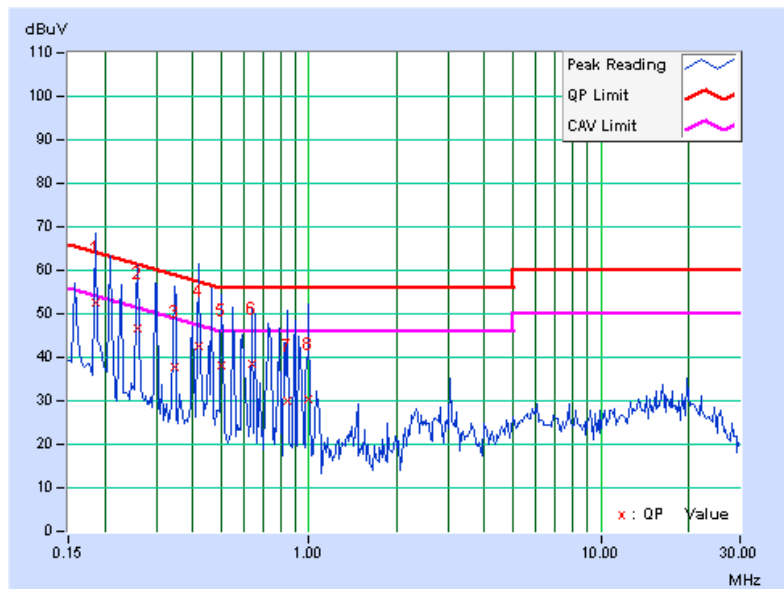

4.1.9 TEST RESULTS (MODE 3)

PHASE	Line (L)	6dB BANDWIDTH	9 kHz
-------	----------	---------------	-------

No	Freq. [MHz]	Corr. Factor (dB)	Reading Value [dB (uV)]		Emission Level [dB (uV)]		Limit [dB (uV)]		Margin (dB)	
			Q.P.	AV.	Q.P.	AV.	Q.P.	AV.	Q.P.	AV.
			1	0.17734	0.08	51.12	41.40	51.20	41.48	64.61
2	0.24375	0.09	47.21	38.36	47.30	38.45	61.97	51.97	-14.67	-13.52
3	0.30234	0.10	49.86	40.88	49.96	40.98	60.18	50.18	-10.22	-9.20
4	0.36875	0.11	40.04	23.72	40.15	23.83	58.53	48.53	-18.38	-24.70
5	0.76719	0.13	38.63	28.51	38.76	28.64	56.00	46.00	-17.24	-17.36
6	3.10938	0.34	33.15	25.19	33.49	25.53	56.00	46.00	-22.51	-20.47

REMARKS:

1. Q.P. and AV. are abbreviations of quasi-peak and average individually.
2. The emission levels of other frequencies were very low against the limit.
3. Margin value = Emission level - Limit value
4. Correction factor = Insertion loss + Cable loss
5. Emission Level = Correction Factor + Reading Value.

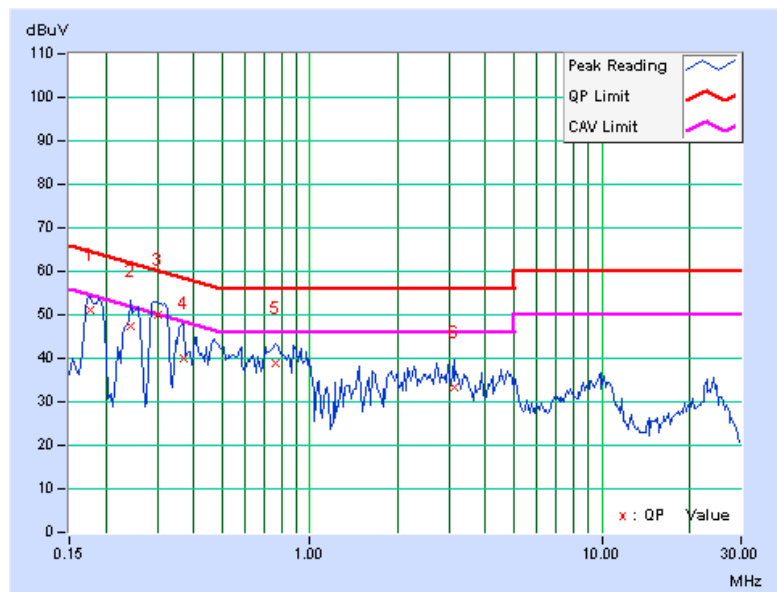

PHASE	Neutral (N)	6dB BANDWIDTH	9 kHz
-------	-------------	---------------	-------

No	Freq. [MHz]	Corr. Factor (dB)	Reading Value		Emission Level		Limit		Margin	
			[dB (uV)]		[dB (uV)]		[dB (uV)]		(dB)	
			Q.P.	AV.	Q.P.	AV.	Q.P.	AV.	Q.P.	AV.
1	0.17734	0.07	50.98	40.92	51.05	40.99	64.61	54.61	-13.56	-13.62
2	0.30234	0.09	47.51	38.27	47.60	38.36	60.18	50.18	-12.58	-11.82
3	0.46641	0.10	36.35	23.05	36.45	23.15	56.58	46.58	-20.13	-23.43
4	0.93906	0.11	36.50	24.93	36.61	25.04	56.00	46.00	-19.39	-20.96
5	1.48047	0.15	30.25	17.41	30.40	17.56	56.00	46.00	-25.60	-28.44
6	3.18359	0.26	32.07	23.60	32.33	23.86	56.00	46.00	-23.67	-22.14

REMARKS:

1. Q.P. and AV. are abbreviations of quasi-peak and average individually.
2. The emission levels of other frequencies were very low against the limit.
3. Margin value = Emission level - Limit value
4. Correction factor = Insertion loss + Cable loss
5. Emission Level = Correction Factor + Reading Value.

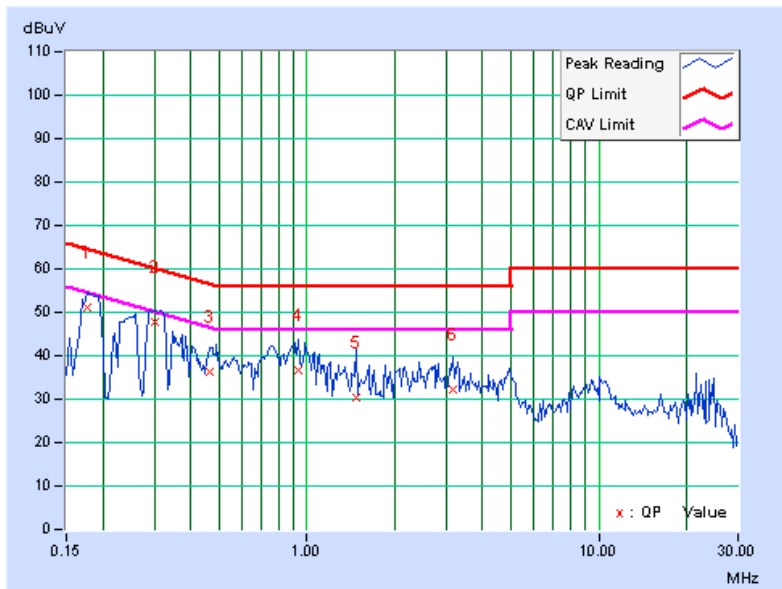

4.2 RADIATED EMISSION AND BANDEDGE MEASUREMENT

4.2.1 LIMITS OF RADIATED EMISSION AND BANDEDGE MEASUREMENT

Radiated emissions which fall in the restricted bands must comply with the radiated emission limits specified as below table. Other emissions shall be at least 20dB below the highest level of the desired power:

Frequencies (MHz)	Field strength (microvolts/meter)	Measurement distance (meters)
0.009-0.490	2400/F(kHz)	300
0.490-1.705	24000/F(kHz)	30
1.705-30.0	30	30
30-88	100	3
88-216	150	3
216-960	200	3
Above 960	500	3

NOTE:

1. The lower limit shall apply at the transition frequencies.
2. Emission level (dBuV/m) = 20 log Emission level (uV/m).
3. For frequencies above 1000MHz, the field strength limits are based on average detector, however, the peak field strength of any emission shall not exceed the maximum permitted average limits, specified above by more than 20dB under any condition of modulation.



A D T

4.2.2 TEST INSTRUMENTS

DESCRIPTION & MANUFACTURER	MODEL NO.	SERIAL NO.	CALIBRATED DATE	CALIBRATED UNTIL
Agilent Spectrum Analyzer	E4446A	MY48250253	Aug. 29, 2011	Aug. 28, 2012
Agilent Pre-Selector	N9039A	MY46520310	Aug. 29, 2011	Aug. 28, 2012
Agilent Signal Generator	N5181A	MY49060347	July 25, 2011	July 24, 2012
Mini-Circuits Pre-Amplifier	ZFL-1000VH2B	AMP-ZFL-04	Nov. 15, 2011	Nov. 14, 2012
Agilent Pre-Amplifier	8449B	3008A02465	Feb. 27, 2012	Feb. 26, 2013
SPACEK LABS	SLKKa-48-6	9K16	Nov. 15, 2011	Nov. 14, 2012
SCHWARZBECK Trilog Broadband Antenna	VULB 9168	9168-361	Apr. 06, 2012	Apr. 05, 2013
AISI Horn_Antenna	AIH.8018	0000220091110	Nov. 23, 2011	Nov. 22, 2012
SCHWARZBECK Horn_Antenna	BBHA 9170	9170-424	Oct. 07, 2011	Oct. 06, 2012
RF CABLE	NA	RF104-205 RF104-207 RF104-202	Dec. 27, 2011	Dec. 26, 2012
RF Cable	NA	CHHCAB_001	Oct. 08, 2011	Oct. 07, 2012
Software	ADT_Radiated_V8.7.05	NA	NA	NA
CT Antenna Tower & Turn Table	NA	NA	NA	NA

Note:

1. The calibration interval of the above test instruments is 12 months and the calibrations are traceable to NML/ROC and NIST/USA.
2. The horn antenna, preamplifier (model: 8449B) are used only for the measurement of emission frequency above 1GHz if tested.
- 3 The test was performed in 966 Chamber No. H.
4. The FCC Site Registration No. is 797305.
- 5 The CANADA Site Registration No. is IC 7450H-3.
- 6 Tested Date: May 15, 2012

4.2.3 TEST PROCEDURES

- a. The EUT was placed on the top of a rotating table 0.8 meters above the ground at 3 meter chamber room. The table was rotated 360 degrees to determine the position of the highest radiation.
- b. The EUT was set 3 meters away from the interference-receiving antenna, which was mounted on the top of a variable-height antenna tower.
- c. The height of antenna is varied from one meter to four meters above the ground to determine the maximum value of the field strength. Both horizontal and vertical polarizations of the antenna are set to make the measurement.
- d. For each suspected emission, the EUT was arranged to its worst case and then the antenna was tuned to heights from 1 meter to 4 meters and the rotatable table was turned from 0 degrees to 360 degrees to find the maximum reading.
- e. The test-receiver system was set to quasi-peak detect function and specified bandwidth with maximum hold mode when the test frequency is below 1 GHz.
- f. The test-receiver system was set to peak and average detect function and specified bandwidth with maximum hold mode when the test frequency is above 1 GHz. If the peak reading value also meets average limit, measurement with the average detector is unnecessary.

NOTE:

1. The resolution bandwidth and video bandwidth of test receiver/spectrum analyzer is 120kHz for Quasi-peak detection (QP) at frequency below 1GHz.
2. The resolution bandwidth of test receiver/spectrum analyzer is 1 MHz and the video bandwidth is 3 MHz for Peak detection (PK) at frequency above 1GHz.
3. The resolution bandwidth of test receiver/spectrum analyzer is 1 MHz and the video bandwidth is 10 Hz for Average detection (AV) at frequency above 1GHz.
4. All modes of operation were investigated and the worst-case emissions are reported.

4.2.4 DEVIATION FROM TEST STANDARD

No deviation

4.2.5 TEST SETUP

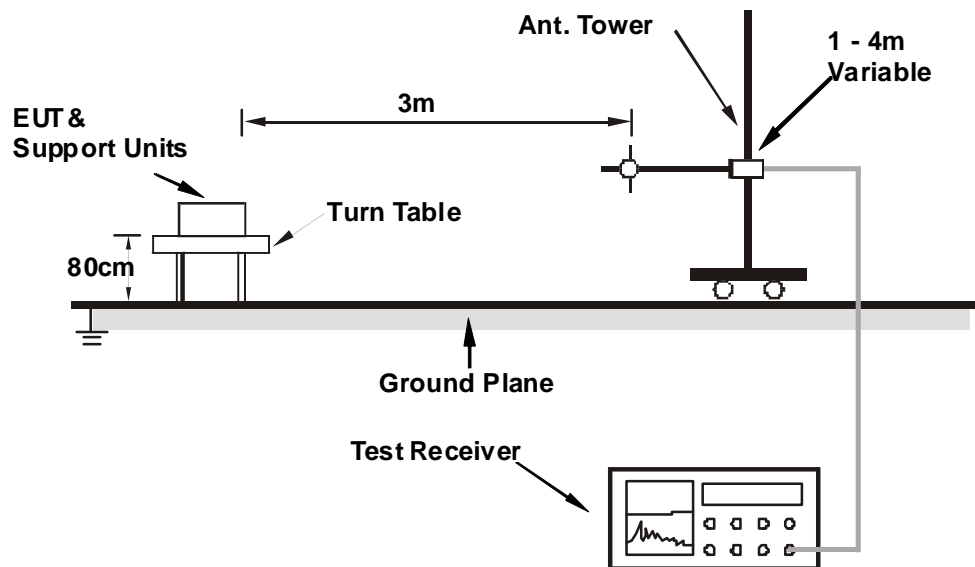

For the actual test configuration, please refer to the related item – Photographs of the Test Configuration.

4.2.6 EUT OPERATING CONDITIONS

Same as 4.1.6

4.2.7 TEST RESULTS

BELOW 1GHz WORST-CASE DATA

802.11g

CHANNEL	TX Channel 6	DETECTOR FUNCTION	Quasi-Peak (QP)
FREQUENCY RANGE	Below 1GHz		

ANTENNA POLARITY & TEST DISTANCE: HORIZONTAL AT 3 M								
NO.	FREQ. (MHz)	EMISSION LEVEL (dBuV/m)	LIMIT (dBuV/m)	MARGIN (dB)	ANTENNA HEIGHT (m)	TABLE ANGLE (Degree)	RAW VALUE (dBuV)	CORRECTION FACTOR (dB/m)
1	85.42	30.4 QP	40.0	-9.6	2.00 H	303	21.55	8.86
2	101.88	36.5 QP	43.5	-7.0	2.00 H	292	26.48	9.98
3	141.20	29.7 QP	43.5	-13.8	1.50 H	236	15.52	14.22
4	374.97	28.6 QP	46.0	-17.4	1.00 H	111	11.50	17.08
5	399.95	35.9 QP	46.0	-10.1	1.00 H	120	18.21	17.70
6	799.98	41.2 QP	46.0	-4.8	1.00 H	198	15.60	25.62
ANTENNA POLARITY & TEST DISTANCE: VERTICAL AT 3 M								
NO.	FREQ. (MHz)	EMISSION LEVEL (dBuV/m)	LIMIT (dBuV/m)	MARGIN (dB)	ANTENNA HEIGHT (m)	TABLE ANGLE (Degree)	RAW VALUE (dBuV)	CORRECTION FACTOR (dB/m)
1	43.79	35.9 QP	40.0	-4.1	1.00 V	151	21.80	14.07
2	58.73	36.2 QP	40.0	-3.9	1.00 V	17	22.52	13.63
3	71.09	35.1 QP	40.0	-4.9	1.50 V	360	23.13	11.96
4	101.88	33.5 QP	43.5	-10.0	1.00 V	346	23.56	9.98
5	399.95	30.0 QP	46.0	-16.0	1.50 V	97	12.34	17.70
6	799.96	44.6 QP	46.0	-1.5	1.50 V	55	18.93	25.62

REMARKS:

1. Emission level (dBuV/m) = Raw Value (dBuV) + Correction Factor (dB/m).
2. Correction Factor (dB/m) = Antenna Factor (dB/m) + Cable Factor (dB).
3. The other emission levels were very low against the limit.
4. Margin value = Emission level – Limit value.



A D T

ABOVE 1GHz DATA

802.11b

CHANNEL	TX Channel 1	DETECTOR FUNCTION	Peak (PK)
FREQUENCY RANGE	1GHz ~ 25GHz		Average (AV)

ANTENNA POLARITY & TEST DISTANCE: HORIZONTAL AT 3 M

NO.	FREQ. (MHz)	EMISSION LEVEL (dBuV/m)	LIMIT (dBuV/m)	MARGIN (dB)	ANTENNA HEIGHT (m)	TABLE ANGLE (Degree)	RAW VALUE (dBuV)	CORRECTION FACTOR (dB/m)
1	2390.00	61.6 PK	74.0	-12.4	1.00 H	123	29.94	31.66
2	2390.00	50.7 AV	54.0	-3.3	1.00 H	123	19.04	31.66
3	*2412.00	116.5 PK			1.00 H	114	84.77	31.73
4	*2412.00	106.3 AV			1.00 H	114	74.57	31.73
5	4824.00	54.9 PK	74.0	-19.1	1.34 H	253	15.93	38.97
6	4824.00	50.9 AV	54.0	-3.1	1.34 H	253	11.93	38.97

ANTENNA POLARITY & TEST DISTANCE: VERTICAL AT 3 M

NO.	FREQ. (MHz)	EMISSION LEVEL (dBuV/m)	LIMIT (dBuV/m)	MARGIN (dB)	ANTENNA HEIGHT (m)	TABLE ANGLE (Degree)	RAW VALUE (dBuV)	CORRECTION FACTOR (dB/m)
1	2390.00	54.7 PK	74.0	-19.3	1.00 V	36	23.04	31.66
2	2390.00	44.6 AV	54.0	-9.4	1.00 V	36	12.94	31.66
3	*2412.00	110.6 PK			1.23 V	26	78.87	31.73
4	*2412.00	100.3 AV			1.23 V	26	68.57	31.73
5	4824.00	56.2 PK	74.0	-17.8	1.29 V	292	17.23	38.97
6	4824.00	53.1 AV	54.0	-0.9	1.29 V	292	14.13	38.97

REMARKS:

1. Emission level (dBuV/m) = Raw Value (dBuV) + Correction Factor (dB/m).
2. Correction Factor (dB/m) = Antenna Factor (dB/m) + Cable Factor (dB).
3. The other emission levels were very low against the limit.
4. Margin value = Emission level – Limit value.
5. " * ": Fundamental frequency.



A D T

CHANNEL	TX Channel 6	DETECTOR FUNCTION	Peak (PK)
FREQUENCY RANGE	1GHz ~ 25GHz		Average (AV)

ANTENNA POLARITY & TEST DISTANCE: HORIZONTAL AT 3 M

NO.	FREQ. (MHz)	EMISSION LEVEL (dBuV/m)	LIMIT (dBuV/m)	MARGIN (dB)	ANTENNA HEIGHT (m)	TABLE ANGLE (Degree)	RAW VALUE (dBuV)	CORRECTION FACTOR (dB/m)
1	*2437.00	117.3 PK			1.00 H	119	85.49	31.81
2	*2437.00	107.9 AV			1.00 H	119	76.09	31.81
3	4874.00	53.5 PK	74.0	-20.5	1.21 H	293	14.36	39.14
4	4874.00	49.2 AV	54.0	-4.8	1.21 H	293	10.06	39.14
5	7311.00	53.5 PK	74.0	-20.5	1.00 H	44	6.87	46.63
6	7311.00	43.3 AV	54.0	-10.7	1.00 H	44	-3.33	46.63

ANTENNA POLARITY & TEST DISTANCE: VERTICAL AT 3 M

NO.	FREQ. (MHz)	EMISSION LEVEL (dBuV/m)	LIMIT (dBuV/m)	MARGIN (dB)	ANTENNA HEIGHT (m)	TABLE ANGLE (Degree)	RAW VALUE (dBuV)	CORRECTION FACTOR (dB/m)
1	*2437.00	111.6 PK			1.24 V	37	79.79	31.81
2	*2437.00	101.3 AV			1.24 V	37	69.49	31.81
3	4874.00	56.6 PK	74.0	-17.4	1.23 V	278	17.46	39.14
4	4874.00	53.5 AV	54.0	-0.5	1.23 V	278	14.36	39.14
5	7311.00	53.3 PK	74.0	-20.7	1.00 V	34	6.67	46.63
6	7311.00	43.0 AV	54.0	-11.0	1.00 V	34	-3.63	46.63

REMARKS:

1. Emission level (dBuV/m) = Raw Value (dBuV) + Correction Factor (dB/m).
2. Correction Factor (dB/m) = Antenna Factor (dB/m) + Cable Factor (dB).
3. The other emission levels were very low against the limit.
4. Margin value = Emission level – Limit value.
5. " * ": Fundamental frequency.



CHANNEL	TX Channel 11	DETECTOR FUNCTION	Peak (PK)
FREQUENCY RANGE	1GHz ~ 25GHz		Average (AV)

ANTENNA POLARITY & TEST DISTANCE: HORIZONTAL AT 3 M

NO.	FREQ. (MHz)	EMISSION LEVEL (dBuV/m)	LIMIT (dBuV/m)	MARGIN (dB)	ANTENNA HEIGHT (m)	TABLE ANGLE (Degree)	RAW VALUE (dBuV)	CORRECTION FACTOR (dB/m)
1	*2462.00	116.1 PK			1.04 H	126	84.21	31.89
2	*2462.00	105.8 AV			1.04 H	126	73.91	31.89
3	2483.50	62.4 PK	74.0	-11.6	1.00 H	156	30.43	31.97
4	2483.50	51.3 AV	54.0	-2.7	1.00 H	156	19.33	31.97
5	4924.00	54.9 PK	74.0	-19.1	1.00 H	294	15.59	39.31
6	4924.00	50.0 AV	54.0	-4.0	1.00 H	294	10.69	39.31
7	7386.00	53.8 PK	74.0	-20.2	1.00 H	106	7.20	46.60
8	7386.00	42.8 AV	54.0	-11.2	1.00 H	106	-3.80	46.60

ANTENNA POLARITY & TEST DISTANCE: VERTICAL AT 3 M

NO.	FREQ. (MHz)	EMISSION LEVEL (dBuV/m)	LIMIT (dBuV/m)	MARGIN (dB)	ANTENNA HEIGHT (m)	TABLE ANGLE (Degree)	RAW VALUE (dBuV)	CORRECTION FACTOR (dB/m)
1	*2462.00	110.9 PK			1.20 V	39	79.01	31.89
2	*2462.00	100.7 AV			1.20 V	39	68.81	31.89
3	2483.50	55.6 PK	74.0	-18.4	1.00 V	72	23.63	31.97
4	2483.50	45.7 AV	54.0	-8.3	1.00 V	72	13.73	31.97
5	4924.00	56.7 PK	74.0	-17.3	1.19 V	273	17.39	39.31
6	4924.00	53.1 AV	54.0	-0.9	1.19 V	273	13.79	39.31
7	7386.00	53.5 PK	74.0	-20.5	1.00 V	26	6.90	46.60
8	7386.00	43.4 AV	54.0	-10.6	1.00 V	26	-3.20	46.60

REMARKS:

1. Emission level (dBuV/m) = Raw Value (dBuV) + Correction Factor (dB/m).
2. Correction Factor (dB/m) = Antenna Factor (dB/m) + Cable Factor (dB).
3. The other emission levels were very low against the limit.
4. Margin value = Emission level – Limit value.
5. " * ": Fundamental frequency.



A D T

802.11g

CHANNEL	TX Channel 1	DETECTOR FUNCTION	Peak (PK)
FREQUENCY RANGE	1GHz ~ 25GHz		Average (AV)

ANTENNA POLARITY & TEST DISTANCE: HORIZONTAL AT 3 M								
NO.	FREQ. (MHz)	EMISSION LEVEL (dBuV/m)	LIMIT (dBuV/m)	MARGIN (dB)	ANTENNA HEIGHT (m)	TABLE ANGLE (Degree)	RAW VALUE (dBuV)	CORRECTION FACTOR (dB/m)
1	2390.00	71.6 PK	74.0	-2.4	1.00 H	113	39.94	31.66
2	2390.00	53.1 AV	54.0	-0.9	1.00 H	113	21.44	31.66
3	*2412.00	112.9 PK			1.00 H	112	81.17	31.73
4	*2412.00	102.4 AV			1.00 H	112	70.67	31.73
5	4824.00	55.4 PK	74.0	-18.6	1.00 H	283	16.43	38.97
6	4824.00	45.3 AV	54.0	-8.7	1.00 H	283	6.33	38.97
ANTENNA POLARITY & TEST DISTANCE: VERTICAL AT 3 M								
NO.	FREQ. (MHz)	EMISSION LEVEL (dBuV/m)	LIMIT (dBuV/m)	MARGIN (dB)	ANTENNA HEIGHT (m)	TABLE ANGLE (Degree)	RAW VALUE (dBuV)	CORRECTION FACTOR (dB/m)
1	2390.00	57.4 PK	74.0	-16.6	1.20 V	69	25.74	31.66
2	2390.00	47.3 AV	54.0	-6.7	1.20 V	69	15.64	31.66
3	*2412.00	108.4 PK			1.21 V	42	76.67	31.73
4	*2412.00	97.3 AV			1.21 V	42	65.57	31.73
5	4824.00	60.4 PK	74.0	-13.6	1.21 V	269	21.43	38.97
6	4824.00	48.4 AV	54.0	-5.6	1.21 V	269	9.43	38.97

REMARKS:

1. Emission level (dBuV/m) = Raw Value (dBuV) + Correction Factor (dB/m).
2. Correction Factor (dB/m) = Antenna Factor (dB/m) + Cable Factor (dB).
3. The other emission levels were very low against the limit.
4. Margin value = Emission level – Limit value.
5. " * ": Fundamental frequency.



A D T

CHANNEL	TX Channel 6	DETECTOR FUNCTION	Peak (PK)
FREQUENCY RANGE	1GHz ~ 25GHz		Average (AV)

ANTENNA POLARITY & TEST DISTANCE: HORIZONTAL AT 3 M

NO.	FREQ. (MHz)	EMISSION LEVEL (dBuV/m)	LIMIT (dBuV/m)	MARGIN (dB)	ANTENNA HEIGHT (m)	TABLE ANGLE (Degree)	RAW VALUE (dBuV)	CORRECTION FACTOR (dB/m)
1	2388.00	68.8 PK	74.0	-5.2	1.00 H	114	37.15	31.65
2	2388.00	52.8 AV	54.0	-1.2	1.00 H	114	21.15	31.65
3	*2437.00	116.5 PK			1.00 H	114	84.69	31.81
4	*2437.00	106.4 AV			1.00 H	114	74.59	31.81
5	2483.50	68.2 PK	74.0	-5.8	1.00 H	122	36.23	31.97
6	2483.50	51.0 AV	54.0	-3.0	1.00 H	122	19.03	31.97
7	4874.00	61.4 PK	74.0	-12.6	1.00 H	274	22.26	39.14
8	4874.00	50.4 AV	54.0	-3.6	1.00 H	274	11.26	39.14
9	7311.00	53.7 PK	74.0	-20.3	1.00 H	109	7.07	46.63
10	7311.00	43.4 AV	54.0	-10.6	1.00 H	109	-3.23	46.63

ANTENNA POLARITY & TEST DISTANCE: VERTICAL AT 3 M

NO.	FREQ. (MHz)	EMISSION LEVEL (dBuV/m)	LIMIT (dBuV/m)	MARGIN (dB)	ANTENNA HEIGHT (m)	TABLE ANGLE (Degree)	RAW VALUE (dBuV)	CORRECTION FACTOR (dB/m)
1	2388.00	57.9 PK	74.0	-16.1	1.24 V	57	26.25	31.65
2	2388.00	47.2 AV	54.0	-6.8	1.24 V	57	15.55	31.65
3	*2437.00	112.3 PK			1.24 V	59	80.49	31.81
4	*2437.00	101.5 AV			1.24 V	59	69.69	31.81
5	2483.50	58.4 PK	74.0	-15.6	1.21 V	63	26.43	31.97
6	2483.50	47.6 AV	54.0	-6.4	1.21 V	63	15.63	31.97
7	4874.00	66.3 PK	74.0	-7.7	1.24 V	277	27.16	39.14
8	4874.00	53.5 AV	54.0	-0.5	1.24 V	277	14.36	39.14
9	7311.00	72.4 PK	74.0	-1.6	1.63 V	155	25.77	46.63
10	7311.00	52.7 AV	54.0	-1.3	1.63 V	155	6.07	46.63

REMARKS:

1. Emission level (dBuV/m) = Raw Value (dBuV) + Correction Factor (dB/m).
2. Correction Factor (dB/m) = Antenna Factor (dB/m) + Cable Factor (dB).
3. The other emission levels were very low against the limit.
4. Margin value = Emission level – Limit value.
5. " * ": Fundamental frequency.



A D T

CHANNEL	TX Channel 11	DETECTOR FUNCTION	Peak (PK)
FREQUENCY RANGE	1GHz ~ 25GHz		Average (AV)

ANTENNA POLARITY & TEST DISTANCE: HORIZONTAL AT 3 M

NO.	FREQ. (MHz)	EMISSION LEVEL (dBuV/m)	LIMIT (dBuV/m)	MARGIN (dB)	ANTENNA HEIGHT (m)	TABLE ANGLE (Degree)	RAW VALUE (dBuV)	CORRECTION FACTOR (dB/m)
1	2376.10	63.7 PK	74.0	-10.3	1.00 H	112	32.09	31.61
2	2376.10	50.6 AV	54.0	-3.4	1.00 H	112	18.99	31.61
3	*2462.00	113.3 PK			1.00 H	115	81.41	31.89
4	*2462.00	102.5 AV			1.00 H	115	70.61	31.89
5	2483.50	73.5 PK	74.0	-0.5	1.00 H	69	41.53	31.97
6	2483.50	53.1 AV	54.0	-0.9	1.00 H	69	21.13	31.97
7	4924.00	56.0 PK	74.0	-18.0	1.00 H	275	16.69	39.31
8	4924.00	45.7 AV	54.0	-8.3	1.00 H	275	6.39	39.31
9	7386.00	54.1 PK	74.0	-19.9	1.00 H	102	7.50	46.60
10	7386.00	43.7 AV	54.0	-10.3	1.00 H	102	-2.90	46.60

ANTENNA POLARITY & TEST DISTANCE: VERTICAL AT 3 M

NO.	FREQ. (MHz)	EMISSION LEVEL (dBuV/m)	LIMIT (dBuV/m)	MARGIN (dB)	ANTENNA HEIGHT (m)	TABLE ANGLE (Degree)	RAW VALUE (dBuV)	CORRECTION FACTOR (dB/m)
1	*2462.00	106.6 PK			1.23 V	21	74.71	31.89
2	*2462.00	96.5 AV			1.23 V	21	64.61	31.89
3	2483.50	64.1 PK	74.0	-9.9	1.19 V	24	32.13	31.97
4	2483.50	48.4 AV	54.0	-5.6	1.19 V	24	16.43	31.97
5	4924.00	60.7 PK	74.0	-13.3	1.19 V	268	21.39	39.31
6	4924.00	48.6 AV	54.0	-5.4	1.19 V	268	9.29	39.31
7	7386.00	58.3 PK	74.0	-15.7	1.04 V	101	11.70	46.60
8	7386.00	48.4 AV	54.0	-5.6	1.04 V	101	1.80	46.60

REMARKS:

1. Emission level (dBuV/m) = Raw Value (dBuV) + Correction Factor (dB/m).
2. Correction Factor (dB/m) = Antenna Factor (dB/m) + Cable Factor (dB).
3. The other emission levels were very low against the limit.
4. Margin value = Emission level – Limit value.
5. " * ": Fundamental frequency.



A D T

802.11n (20MHz)

CHANNEL	TX Channel 1	DETECTOR FUNCTION	Peak (PK)
FREQUENCY RANGE	1GHz ~ 25GHz		Average (AV)

ANTENNA POLARITY & TEST DISTANCE: HORIZONTAL AT 3 M								
NO.	FREQ. (MHz)	EMISSION LEVEL (dBuV/m)	LIMIT (dBuV/m)	MARGIN (dB)	ANTENNA HEIGHT (m)	TABLE ANGLE (Degree)	RAW VALUE (dBuV)	CORRECTION FACTOR (dB/m)
1	2390.00	72.2 PK	74.0	-1.8	1.00 H	114	40.54	31.66
2	2390.00	53.2 AV	54.0	-0.8	1.00 H	114	21.54	31.66
3	*2412.00	111.0 PK			1.00 H	115	79.27	31.73
4	*2412.00	100.6 AV			1.00 H	115	68.87	31.73
5	4824.00	55.7 PK	74.0	-18.3	1.00 H	283	16.73	38.97
6	4824.00	45.6 AV	54.0	-8.4	1.00 H	283	6.63	38.97
ANTENNA POLARITY & TEST DISTANCE: VERTICAL AT 3 M								
NO.	FREQ. (MHz)	EMISSION LEVEL (dBuV/m)	LIMIT (dBuV/m)	MARGIN (dB)	ANTENNA HEIGHT (m)	TABLE ANGLE (Degree)	RAW VALUE (dBuV)	CORRECTION FACTOR (dB/m)
1	2390.00	57.1 PK	74.0	-16.9	1.21 V	61	25.44	31.66
2	2390.00	46.9 AV	54.0	-7.1	1.21 V	61	15.24	31.66
3	*2412.00	108.9 PK			1.15 V	52	77.17	31.73
4	*2412.00	97.6 AV			1.15 V	52	65.87	31.73
5	4824.00	60.9 PK	74.0	-13.1	1.18 V	275	21.93	38.97
6	4824.00	48.8 AV	54.0	-5.2	1.18 V	275	9.83	38.97

REMARKS:

1. Emission level (dBuV/m) = Raw Value (dBuV) + Correction Factor (dB/m).
2. Correction Factor (dB/m) = Antenna Factor (dB/m) + Cable Factor (dB).
3. The other emission levels were very low against the limit.
4. Margin value = Emission level – Limit value.
5. " * ": Fundamental frequency.



A D T

CHANNEL	TX Channel 6	DETECTOR FUNCTION	Peak (PK)
FREQUENCY RANGE	1GHz ~ 25GHz		Average (AV)

ANTENNA POLARITY & TEST DISTANCE: HORIZONTAL AT 3 M

NO.	FREQ. (MHz)	EMISSION LEVEL (dBuV/m)	LIMIT (dBuV/m)	MARGIN (dB)	ANTENNA HEIGHT (m)	TABLE ANGLE (Degree)	RAW VALUE (dBuV)	CORRECTION FACTOR (dB/m)
1	2390.00	69.3 PK	74.0	-4.7	1.00 H	113	37.64	31.66
2	2390.00	52.0 AV	54.0	-2.0	1.00 H	113	20.34	31.66
3	*2437.00	116.4 PK			1.00 H	113	84.59	31.81
4	*2437.00	106.3 AV			1.00 H	113	74.49	31.81
5	2483.50	72.3 PK	74.0	-1.7	1.00 H	113	40.33	31.97
6	2483.50	50.2 AV	54.0	-3.8	1.00 H	113	18.23	31.97
7	4874.00	55.7 PK	74.0	-18.3	1.32 H	250	16.56	39.14
8	4874.00	42.6 AV	54.0	-11.4	1.32 H	250	3.46	39.14
9	7311.00	72.2 PK	74.0	-1.8	1.18 H	65	25.57	46.63
10	7311.00	51.2 AV	54.0	-2.8	1.18 H	65	4.57	46.63

ANTENNA POLARITY & TEST DISTANCE: VERTICAL AT 3 M

NO.	FREQ. (MHz)	EMISSION LEVEL (dBuV/m)	LIMIT (dBuV/m)	MARGIN (dB)	ANTENNA HEIGHT (m)	TABLE ANGLE (Degree)	RAW VALUE (dBuV)	CORRECTION FACTOR (dB/m)
1	*2437.00	112.4 PK			1.20 V	49	80.59	31.81
2	*2437.00	101.8 AV			1.20 V	49	69.99	31.81
3	4874.00	62.0 PK	74.0	-12.0	1.24 V	279	22.86	39.14
4	4874.00	50.0 AV	54.0	-4.0	1.24 V	279	10.86	39.14
5	7311.00	72.9 PK	74.0	-1.1	1.65 V	155	26.27	46.63
6	7311.00	52.6 AV	54.0	-1.4	1.65 V	155	5.97	46.63

REMARKS:

1. Emission level (dBuV/m) = Raw Value (dBuV) + Correction Factor (dB/m).
2. Correction Factor (dB/m) = Antenna Factor (dB/m) + Cable Factor (dB).
3. The other emission levels were very low against the limit.
4. Margin value = Emission level – Limit value.
5. " * ": Fundamental frequency.

CHANNEL	TX Channel 11	DETECTOR FUNCTION	Peak (PK)
FREQUENCY RANGE	1GHz ~ 25GHz		Average (AV)

ANTENNA POLARITY & TEST DISTANCE: HORIZONTAL AT 3 M

NO.	FREQ. (MHz)	EMISSION LEVEL (dBuV/m)	LIMIT (dBuV/m)	MARGIN (dB)	ANTENNA HEIGHT (m)	TABLE ANGLE (Degree)	RAW VALUE (dBuV)	CORRECTION FACTOR (dB/m)
1	*2462.00	110.6 PK			1.00 H	114	78.71	31.89
2	*2462.00	100.0 AV			1.00 H	114	68.11	31.89
3	2483.50	73.1 PK	74.0	-0.9	1.00 H	111	41.13	31.97
4	2483.50	52.2 AV	54.0	-1.8	1.00 H	111	20.23	31.97
5	4924.00	55.7 PK	74.0	-18.3	1.05 H	290	16.39	39.31
6	4924.00	45.5 AV	54.0	-8.5	1.05 H	290	6.19	39.31
7	7386.00	53.8 PK	74.0	-20.2	1.00 H	117	7.20	46.60
8	7386.00	43.7 AV	54.0	-10.3	1.00 H	117	-2.90	46.60

ANTENNA POLARITY & TEST DISTANCE: VERTICAL AT 3 M

NO.	FREQ. (MHz)	EMISSION LEVEL (dBuV/m)	LIMIT (dBuV/m)	MARGIN (dB)	ANTENNA HEIGHT (m)	TABLE ANGLE (Degree)	RAW VALUE (dBuV)	CORRECTION FACTOR (dB/m)
1	*2462.00	106.4 PK			1.23 V	14	74.51	31.89
2	*2462.00	96.1 AV			1.23 V	14	64.21	31.89
3	2483.50	64.4 PK	74.0	-9.6	1.23 V	26	32.43	31.97
4	2483.50	48.6 AV	54.0	-5.4	1.23 V	26	16.63	31.97
5	4924.00	60.9 PK	74.0	-13.1	1.23 V	260	21.59	39.31
6	4924.00	48.7 AV	54.0	-5.3	1.23 V	260	9.39	39.31
7	7386.00	58.8 PK	74.0	-15.2	1.00 V	94	12.20	46.60
8	7386.00	48.7 AV	54.0	-5.3	1.00 V	94	2.10	46.60

REMARKS:

1. Emission level (dBuV/m) = Raw Value (dBuV) + Correction Factor (dB/m).
2. Correction Factor (dB/m) = Antenna Factor (dB/m) + Cable Factor (dB).
3. The other emission levels were very low against the limit.
4. Margin value = Emission level – Limit value.
5. " * ": Fundamental frequency.



A D T

802.11n (40MHz)

CHANNEL	TX Channel 3	DETECTOR FUNCTION	Peak (PK)
FREQUENCY RANGE	1GHz ~ 25GHz		Average (AV)

ANTENNA POLARITY & TEST DISTANCE: HORIZONTAL AT 3 M								
NO.	FREQ. (MHz)	EMISSION LEVEL (dBuV/m)	LIMIT (dBuV/m)	MARGIN (dB)	ANTENNA HEIGHT (m)	TABLE ANGLE (Degree)	RAW VALUE (dBuV)	CORRECTION FACTOR (dB/m)
1	2390.00	71.8 PK	74.0	-2.2	1.00 H	70	40.14	31.66
2	2390.00	52.9 AV	54.0	-1.1	1.00 H	70	21.24	31.66
3	*2422.00	105.2 PK			1.00 H	113	73.44	31.76
4	*2422.00	95.0 AV			1.00 H	113	63.24	31.76
5	4844.00	46.7 PK	74.0	-27.3	1.04 H	283	7.66	39.04
6	4844.00	36.4 AV	54.0	-17.6	1.04 H	283	-2.64	39.04
7	7266.00	53.4 PK	74.0	-20.6	1.00 H	123	6.73	46.67
8	7266.00	43.1 AV	54.0	-10.9	1.00 H	123	-3.57	46.67

ANTENNA POLARITY & TEST DISTANCE: VERTICAL AT 3 M								
NO.	FREQ. (MHz)	EMISSION LEVEL (dBuV/m)	LIMIT (dBuV/m)	MARGIN (dB)	ANTENNA HEIGHT (m)	TABLE ANGLE (Degree)	RAW VALUE (dBuV)	CORRECTION FACTOR (dB/m)
1	2390.00	67.4 PK	74.0	-6.6	1.26 V	43	35.74	31.66
2	2390.00	48.3 AV	54.0	-5.7	1.26 V	43	16.64	31.66
3	*2422.00	100.6 PK			1.24 V	56	68.84	31.76
4	*2422.00	90.7 AV			1.24 V	56	58.94	31.76
5	4844.00	49.6 PK	74.0	-24.4	1.24 V	277	10.56	39.04
6	4844.00	40.7 AV	54.0	-13.3	1.24 V	277	1.66	39.04
7	7266.00	54.6 PK	74.0	-19.4	1.00 V	100	7.93	46.67
8	7266.00	44.7 AV	54.0	-9.3	1.00 V	100	-1.97	46.67

REMARKS:

1. Emission level (dBuV/m) = Raw Value (dBuV) + Correction Factor (dB/m).
2. Correction Factor (dB/m) = Antenna Factor (dB/m) + Cable Factor (dB).
3. The other emission levels were very low against the limit.
4. Margin value = Emission level – Limit value.
5. " * ": Fundamental frequency.



A D T

CHANNEL	TX Channel 6	DETECTOR FUNCTION	Peak (PK)
FREQUENCY RANGE	1GHz ~ 25GHz		Average (AV)

ANTENNA POLARITY & TEST DISTANCE: HORIZONTAL AT 3 M

NO.	FREQ. (MHz)	EMISSION LEVEL (dBuV/m)	LIMIT (dBuV/m)	MARGIN (dB)	ANTENNA HEIGHT (m)	TABLE ANGLE (Degree)	RAW VALUE (dBuV)	CORRECTION FACTOR (dB/m)
1	2390.00	71.6 PK	74.0	-2.4	1.00 H	112	39.94	31.66
2	2390.00	53.1 AV	54.0	-0.9	1.00 H	112	21.44	31.66
3	*2437.00	109.2 PK			1.00 H	113	77.39	31.81
4	*2437.00	98.4 AV			1.00 H	113	66.59	31.81
5	2483.50	63.7 PK	74.0	-10.3	1.00 H	68	31.73	31.97
6	2483.50	49.8 AV	54.0	-4.2	1.00 H	68	17.83	31.97
7	4874.00	50.7 PK	74.0	-23.3	1.13 H	284	11.56	39.14
8	4874.00	39.4 AV	54.0	-14.6	1.13 H	284	0.26	39.14
9	7311.00	54.6 PK	74.0	-19.4	1.00 H	124	7.97	46.63
10	7311.00	44.6 AV	54.0	-9.4	1.00 H	124	-2.03	46.63

ANTENNA POLARITY & TEST DISTANCE: VERTICAL AT 3 M

NO.	FREQ. (MHz)	EMISSION LEVEL (dBuV/m)	LIMIT (dBuV/m)	MARGIN (dB)	ANTENNA HEIGHT (m)	TABLE ANGLE (Degree)	RAW VALUE (dBuV)	CORRECTION FACTOR (dB/m)
1	*2437.00	103.6 PK			1.29 V	73	71.79	31.81
2	*2437.00	93.7 AV			1.29 V	73	61.89	31.81
3	4874.00	54.6 PK	74.0	-19.4	1.31 V	279	15.46	39.14
4	4874.00	44.3 AV	54.0	-9.7	1.31 V	279	5.16	39.14
5	7311.00	55.6 PK	74.0	-18.4	1.00 V	124	8.97	46.63
6	7311.00	45.3 AV	54.0	-8.7	1.00 V	124	-1.33	46.63

REMARKS:

1. Emission level (dBuV/m) = Raw Value (dBuV) + Correction Factor (dB/m).
2. Correction Factor (dB/m) = Antenna Factor (dB/m) + Cable Factor (dB).
3. The other emission levels were very low against the limit.
4. Margin value = Emission level – Limit value.
5. " * " : Fundamental frequency.



A D T

CHANNEL	TX Channel 9	DETECTOR FUNCTION	Peak (PK)
FREQUENCY RANGE	1GHz ~ 25GHz		Average (AV)

ANTENNA POLARITY & TEST DISTANCE: HORIZONTAL AT 3 M

NO.	FREQ. (MHz)	EMISSION LEVEL (dBuV/m)	LIMIT (dBuV/m)	MARGIN (dB)	ANTENNA HEIGHT (m)	TABLE ANGLE (Degree)	RAW VALUE (dBuV)	CORRECTION FACTOR (dB/m)
1	*2452.00	106.4 PK			1.00 H	114	74.54	31.86
2	*2452.00	95.8 AV			1.00 H	114	63.94	31.86
3	2486.05	72.6 PK	74.0	-1.4	1.00 H	113	40.63	31.97
4	2486.05	52.2 AV	54.0	-1.8	1.00 H	113	20.23	31.97
5	4904.00	47.1 PK	74.0	-26.9	1.10 H	299	7.86	39.24
6	4904.00	36.6 AV	54.0	-17.4	1.10 H	299	-2.64	39.24
7	7356.00	53.7 PK	74.0	-20.3	1.00 H	126	7.09	46.61
8	7356.00	43.2 AV	54.0	-10.8	1.00 H	126	-3.41	46.61

ANTENNA POLARITY & TEST DISTANCE: VERTICAL AT 3 M

NO.	FREQ. (MHz)	EMISSION LEVEL (dBuV/m)	LIMIT (dBuV/m)	MARGIN (dB)	ANTENNA HEIGHT (m)	TABLE ANGLE (Degree)	RAW VALUE (dBuV)	CORRECTION FACTOR (dB/m)
1	*2452.00	100.5 PK			1.23 V	61	68.64	31.86
2	*2452.00	90.5 AV			1.23 V	61	58.64	31.86
3	2486.05	67.9 PK	74.0	-6.1	1.21 V	30	35.93	31.97
4	2486.05	48.6 AV	54.0	-5.4	1.21 V	30	16.63	31.97
5	4904.00	49.9 PK	74.0	-24.1	1.30 V	266	10.66	39.24
6	4904.00	40.8 AV	54.0	-13.2	1.30 V	266	1.56	39.24
7	7356.00	54.2 PK	74.0	-19.8	1.00 V	113	7.59	46.61
8	7356.00	44.3 AV	54.0	-9.7	1.00 V	113	-2.31	46.61

REMARKS:

1. Emission level (dBuV/m) = Raw Value (dBuV) + Correction Factor (dB/m).
2. Correction Factor (dB/m) = Antenna Factor (dB/m) + Cable Factor (dB).
3. The other emission levels were very low against the limit.
4. Margin value = Emission level – Limit value.
5. " * " : Fundamental frequency.

4.3 6dB BANDWIDTH MEASUREMENT

4.3.1 LIMITS OF 6dB BANDWIDTH MEASUREMENT

The minimum of 6dB Bandwidth Measurement is 0.5 MHz.

4.3.2 TEST INSTRUMENTS

DESCRIPTION & MANUFACTURER	MODEL NO.	SERIAL NO.	CALIBRATED DATE	CALIBRATED UNTIL
R&S Spectrum Analyzer	FSP 40	100060	May 09, 2012	May 08, 2013

Note:

1. The calibration interval of the above test instruments is 12 months and the calibrations are traceable to NML/ROC and NIST/USA.
2. Tested date : May 18, 2012

4.3.3 TEST PROCEDURE

1. Set resolution bandwidth (RBW) = approximately 1% of the emission bandwidth
2. Set the video bandwidth (VBW) $\geq 3 \times$ RBW, Detector = Peak.
3. Trace mode = max hold.
4. Sweep = auto couple.
5. Measure the maximum width of the emission that is constrained by the frequencies associated with the two amplitude points (upper and lower) that are attenuated by 6 dB relative to the maximum level measured in the fundamental emission

4.3.4 DEVIATION FROM TEST STANDARD

No deviation

4.3.5 TEST SETUP

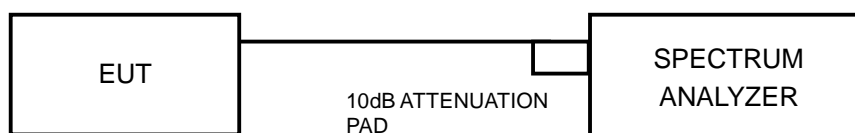

4.3.6 EUT OPERATING CONDITIONS

The software provided by client to enable the EUT under transmission condition continuously at lowest, middle and highest channel frequencies individually.



A D T

4.3.7 TEST RESULTS

802.11b

CHANNEL	FREQUENCY (MHz)	6dB BANDWIDTH (MHz)		MINIMUM LIMIT (MHz)	PASS / FAIL
		CHAIN 0	CHAIN 1		
1	2412	10.51	10.62	0.5	PASS
6	2437	10.65	10.54	0.5	PASS
11	2462	10.41	10.48	0.5	PASS

802.11g

CHANNEL	FREQUENCY (MHz)	6dB BANDWIDTH (MHz)		MINIMUM LIMIT (MHz)	PASS / FAIL
		CHAIN 0	CHAIN 1		
1	2412	16.62	16.53	0.5	PASS
6	2437	16.56	16.58	0.5	PASS
11	2462	16.57	16.52	0.5	PASS

802.11n (20MHz)

CHANNEL	FREQUENCY (MHz)	6dB BANDWIDTH (MHz)		MINIMUM LIMIT (MHz)	PASS / FAIL
		CHAIN 0	CHAIN 1		
1	2412	17.79	17.84	0.5	PASS
6	2437	17.73	17.77	0.5	PASS
11	2462	17.70	17.71	0.5	PASS

802.11n (40MHz)

CHANNEL	FREQUENCY (MHz)	6dB BANDWIDTH (MHz)		MINIMUM LIMIT (MHz)	PASS / FAIL
		CHAIN 0	CHAIN 1		
3	2422	37.32	36.73	0.5	PASS
6	2437	36.51	36.51	0.5	PASS
9	2452	36.40	36.55	0.5	PASS

4.4 CONDUCTED OUTPUT POWER MEASUREMENT

4.4.1 LIMITS OF MAXIMUM PEAK OUTPUT POWER MEASUREMENT

For systems using digital modulation in the 2400–2483.5 MHz band: 1 Watt (30dBm)

4.4.2 INSTRUMENTS

DESCRIPTION & MANUFACTURER	MODEL NO.	SERIAL NO.	CALIBRATED DATE	CALIBRATED UNTIL
Peak Power Meter	ML2495A	0824006	May 10, 2012	May 09, 2013
Power Sensor	MA2411B	0738172	May 10, 2012	May 09, 2013

Note:

1. The calibration interval of the above test instruments is 12 months and the calibrations are traceable to NML/ROC and NIST/USA.
2. Tested date : May 18, 2012

4.4.3 TEST PROCEDURES

A peak power sensor was used on the output port of the EUT. A power meter was used to read the response of the peak power sensor. Record the peak power level.

4.4.4 DEVIATION FROM TEST STANDARD

No deviation

4.4.5 TEST SETUP

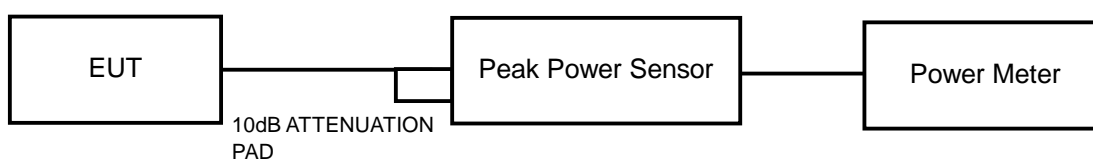

4.4.6 EUT OPERATING CONDITIONS

Same as Item 4.3.6

4.4.7 TEST RESULTS

802.11b

CHAN.	FREQUENCY (MHz)	PEAK POWER (dBm)		TOTAL POWER (mW)	TOTAL POWER (dBm)	LIMIT (dBm)	PASS / FAIL
		CHAIN 0	CHAIN 1				
1	2412	17.60	18.60	129.988	21.14	29.06	PASS
6	2437	19.30	19.40	172.210	22.36	29.06	PASS
11	2462	18.00	18.70	137.227	21.37	29.06	PASS

Directional gain = $10 \log[(10^{G1/20} + 10^{G2/20})^2 / 2]$

Effective Legacy Gain (dBi) = 6.94

The effective legacy gain is 6.94dBi, therefore the limit needs to reduce.

802.11g

CHAN.	FREQUENCY (MHz)	PEAK POWER (dBm)		TOTAL POWER (mW)	TOTAL POWER (dBm)	LIMIT (dBm)	PASS / FAIL
		CHAIN 0	CHAIN 1				
1	2412	24.20	25.70	634.562	28.02	29.06	PASS
6	2437	25.60	25.70	734.613	28.66	29.06	PASS
11	2462	24.30	24.30	538.306	27.31	29.06	PASS

Directional gain = $10 \log[(10^{G1/20} + 10^{G2/20})^2 / 2]$

Effective Legacy Gain (dBi) = 6.94

The effective legacy gain is 6.94dBi, therefore the limit needs to reduce.

802.11n (20MHz)

CHAN.	FREQUENCY (MHz)	PEAK POWER (dBm)		TOTAL POWER (mW)	TOTAL POWER (dBm)	LIMIT (dBm)	PASS / FAIL
		CHAIN 0	CHAIN 1				
1	2412	23.60	24.10	486.127	26.87	30.00	PASS
6	2437	25.30	25.70	710.379	28.51	30.00	PASS
11	2462	23.30	23.50	437.668	26.41	30.00	PASS



A D T

802.11n (40MHz)

CHAN.	FREQUENCY (MHz)	PEAK POWER (dBm)		TOTAL POWER (mW)	TOTAL POWER (dBm)	LIMIT (dBm)	PASS / FAIL
		CHAIN 0	CHAIN 1				
3	2422	21.60	21.50	285.798	24.56	30.00	PASS
6	2437	24.20	25.10	586.621	27.68	30.00	PASS
9	2452	22.40	22.10	335.961	25.26	30.00	PASS

4.5 POWER SPECTRAL DENSITY MEASUREMENT

4.5.1 LIMITS OF POWER SPECTRAL DENSITY MEASUREMENT

The Maximum of Power Spectral Density Measurement is 8dBm.

4.5.2 TEST INSTRUMENTS

DESCRIPTION & MANUFACTURER	MODEL NO.	SERIAL NO.	CALIBRATED DATE	CALIBRATED UNTIL
R&S Spectrum Analyzer	FSP 40	100060	May 09, 2012	May 08, 2013

Note:

1. The calibration interval of the above test instruments is 12 months and the calibrations are traceable to NML/ROC and NIST/USA.
2. Tested date : May 18, 2012

4.5.3 TEST PROCEDURE

1. Set the RBW = 100 kHz, VBW =300 kHz, Detector = peak.
2. Sweep time = auto couple, Trace mode = max hold, allow trace to fully stabilize.
3. Use the peak marker function to determine the maximum power level in any 100 kHz band segment within the fundamental EBW.
4. Scale the observed power level to an equivalent value in 3 kHz by adjusting (reducing) the measured power by a bandwidth correction factor (BWCF) where $BWCF = 10\log(3 \text{ kHz}/100\text{kHz})$
- 5.

4.5.4 DEVIATION FROM TEST STANDARD

No deviation

4.5.5 TEST SETUP



4.5.6 EUT OPERATING CONDITION

Same as Item 4.3.6



A D T

4.5.7 TEST RESULTS

802.11b

TX chain	Channel	FREQ. (MHz)	PSD (dBm/100kHz)	PSD (dBm/3kHz)	10 log (N=2) dB	Total PSD (dBm/3kHz)	Limit (dBm/3kHz)	PASS /FAIL
0	1	2412	7.95	-7.28	3.01	-4.27	7.06	PASS
	6	2437	9.58	-5.65	3.01	-2.64	7.06	PASS
	11	2462	7.72	-7.51	3.01	-4.50	7.06	PASS
1	1	2412	7.44	-7.79	3.01	-4.78	7.06	PASS
	6	2437	8.91	-6.32	3.01	-3.31	7.06	PASS
	11	2462	7.54	-7.69	3.01	-4.68	7.06	PASS

$$\text{Directional gain} = 10 \log[(10^{G1/20} + 10^{G2/20})^2 / 2]$$

Effective Legacy Gain (dBi) = 6.94

The effective legacy gain is 6.94dBi, therefore the limit needs to reduce.

802.11g

TX chain	Channel	FREQ. (MHz)	PSD (dBm/100kHz)	PSD (dBm/3kHz)	10 log (N=2) dB	Total PSD (dBm/3kHz)	Limit (dBm/3kHz)	PASS /FAIL
0	1	2412	3.65	-11.58	3.01	-8.57	7.06	PASS
	6	2437	6.15	-9.08	3.01	-6.07	7.06	PASS
	11	2462	4.25	-10.98	3.01	-7.97	7.06	PASS
1	1	2412	4.37	-10.86	3.01	-7.85	7.06	PASS
	6	2437	5.65	-9.58	3.01	-6.57	7.06	PASS
	11	2462	3.80	-11.43	3.01	-8.42	7.06	PASS

$$\text{Directional gain} = 10 \log[(10^{G1/20} + 10^{G2/20})^2 / 2]$$

Effective Legacy Gain (dBi) = 6.94

The effective legacy gain is 6.94dBi, therefore the limit needs to reduce.

802.11n (20MHz)

TX chain	Channel	FREQ. (MHz)	PSD (dBm/100kHz)	PSD (dBm/3kHz)	10 log (N=2) dB	Total PSD (dBm/3kHz)	Limit (dBm/3kHz)	PASS /FAIL
0	1	2412	3.88	-11.35	3.01	-8.34	8.00	PASS
	6	2437	5.82	-9.41	3.01	-6.40	8.00	PASS
	11	2462	4.26	-10.97	3.01	-7.96	8.00	PASS
1	1	2412	3.38	-11.85	3.01	-8.84	8.00	PASS
	6	2437	5.49	-9.74	3.01	-6.73	8.00	PASS
	11	2462	3.25	-11.98	3.01	-8.97	8.00	PASS



A D T

802.11n (40MHz)

TX chain	Channel	FREQ. (MHz)	PSD (dBm/100kHz)	PSD (dBm/3kHz)	10 log (N=2) dB	Total PSD (dBm/3kHz)	Limit (dBm/3kHz)	PASS /FAIL
0	3	2422	-1.80	-17.03	3.01	-14.02	8.00	PASS
	6	2437	2.56	-12.67	3.01	-9.66	8.00	PASS
	9	2452	-0.78	-16.01	3.01	-13.00	8.00	PASS
1	3	2422	-1.90	-17.13	3.01	-14.12	8.00	PASS
	6	2437	1.55	-13.68	3.01	-10.67	8.00	PASS
	9	2452	-0.88	-16.11	3.01	-13.10	8.00	PASS



A D T

4.6 CONDUCTED OUT-BAND EMISSION MEASUREMENT

4.6.1 LIMITS OF CONDUCTED OUT-BAND EMISSION MEASUREMENT

Below -20dB of the highest emission level of operating band (in 100kHz Resolution Bandwidth).

4.6.2 TEST INSTRUMENTS

DESCRIPTION & MANUFACTURER	MODEL NO.	SERIAL NO.	CALIBRATED DATE	CALIBRATED UNTIL
R&S Spectrum Analyzer	FSP 40	100060	May 09, 2012	May 08, 2013

Note:

1. The calibration interval of the above test instruments is 12 months and the calibrations are traceable to NML/ROC and NIST/USA.
2. Tested date : May 18, 2012

4.6.3 TEST PROCEDURE

MEASUREMENT PROCEDURE REF

1. Set the RBW = 100 kHz.
2. Set the VBW \geq 300 kHz.
3. Detector = peak.
4. Sweep time = auto couple.
5. Trace mode = max hold.
6. Allow trace to fully stabilize.
7. Use the peak marker function to determine the maximum power level in any 100 kHz band segment within the fundamental EBW.

MEASUREMENT PROCEDURE OOB

1. Set RBW = 100 kHz.
2. Set VBW \geq 300 kHz.
3. Set span to encompass the spectrum to be examined
4. Detector = peak.
5. Trace Mode = max hold.
6. Sweep = auto couple.

4.6.4 DEVIATION FROM TEST STANDARD

No deviation

4.6.5 TEST SETUP

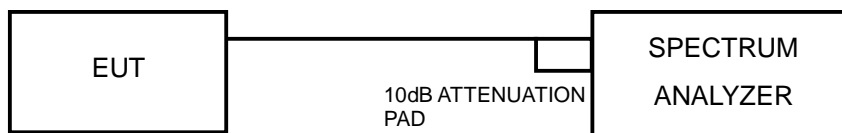

4.6.6 EUT OPERATING CONDITION

Same as Item 4.3.6

4.6.7 TEST RESULTS

The conducted emission test is performed on each TX port of operating mode without summing or adding $10\log(N)$ since the limit is relative emission limit. Only worst data of each operating mode is presented.

The spectrum plots are attached on the following pages. D1 line indicates the highest level, and D2 line indicates the 20dB offset below D1. It shows compliance with the requirement.



A D T

802.11b

CH 1

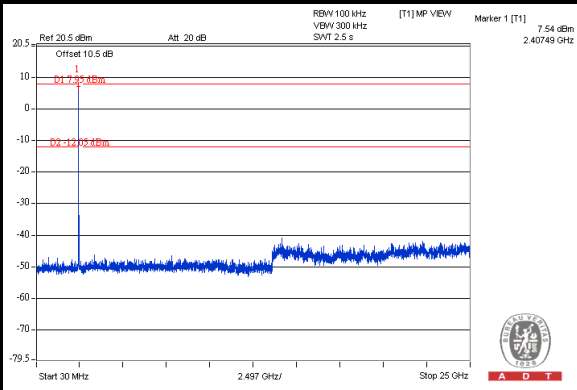
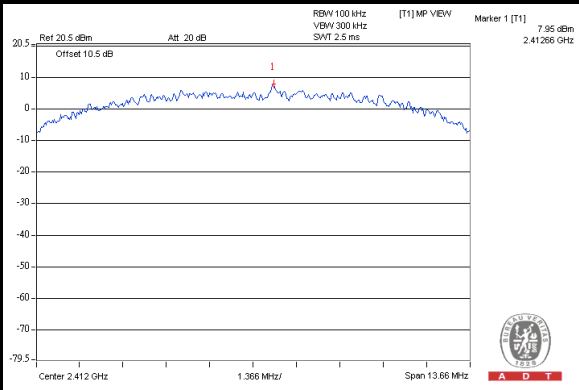

CH 6

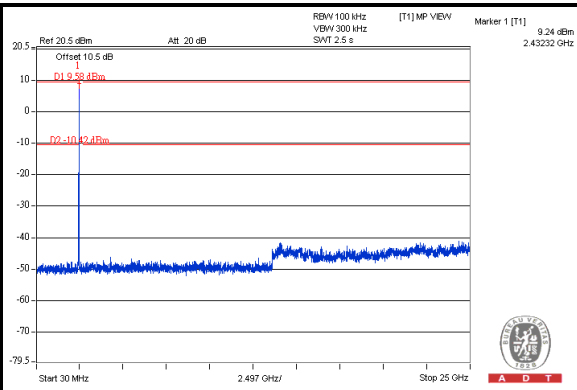
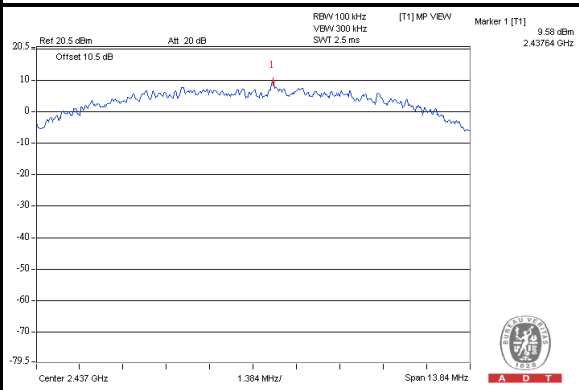

CH 11

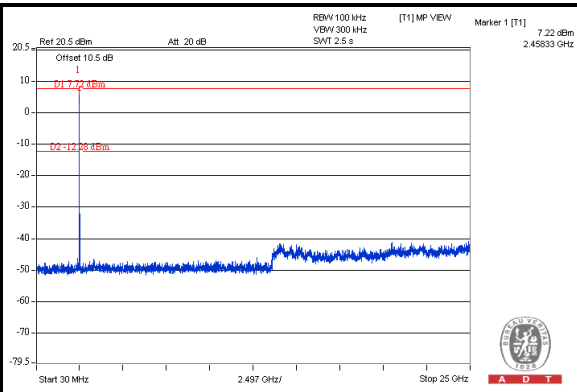
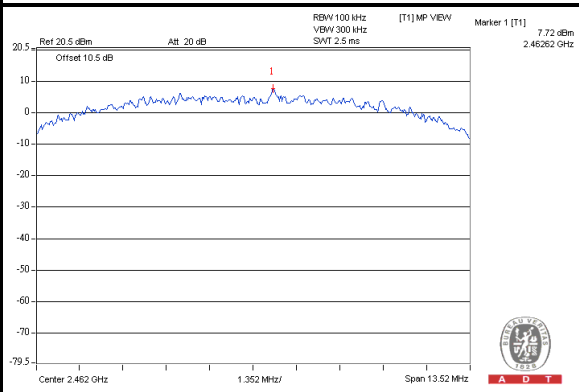



A D T

802.11g

CH 1

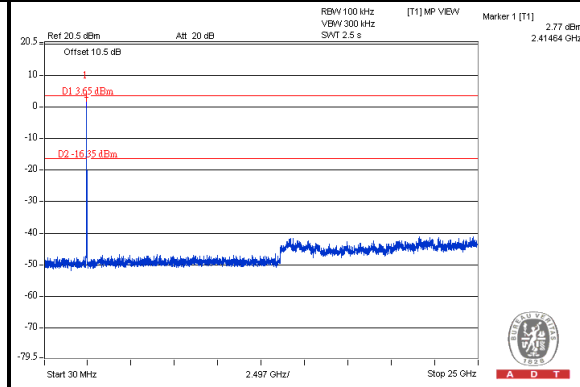
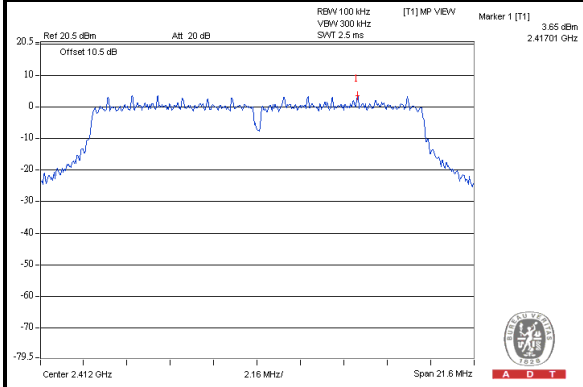

CH 6

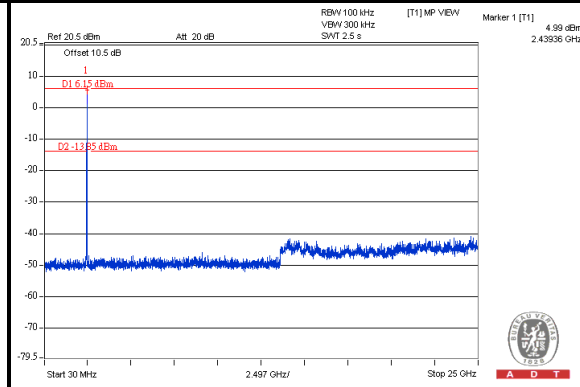
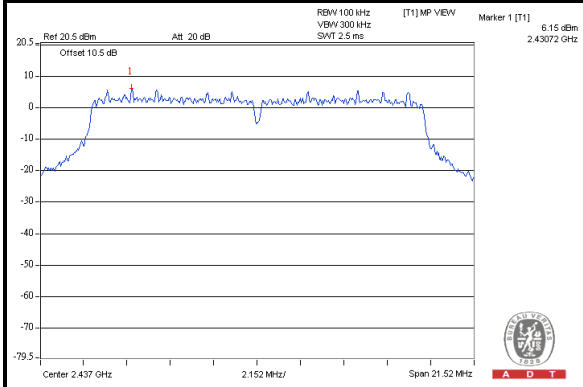

CH 11

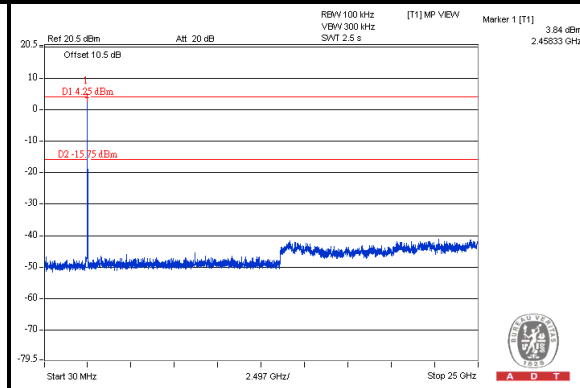
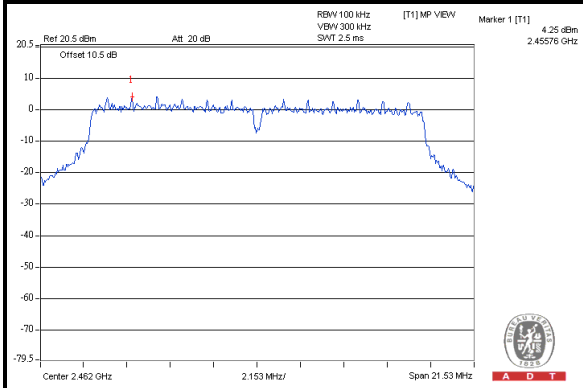



A D T

802.11n (20MHz)

CH 1

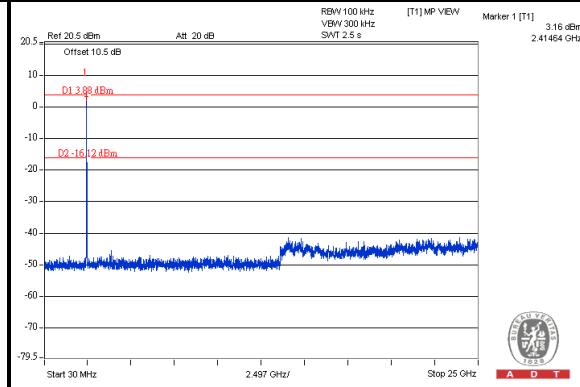
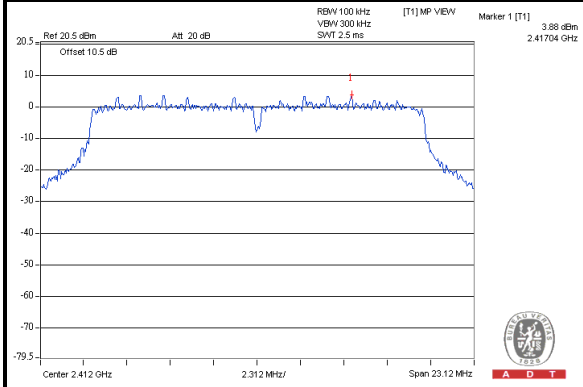

CH 6

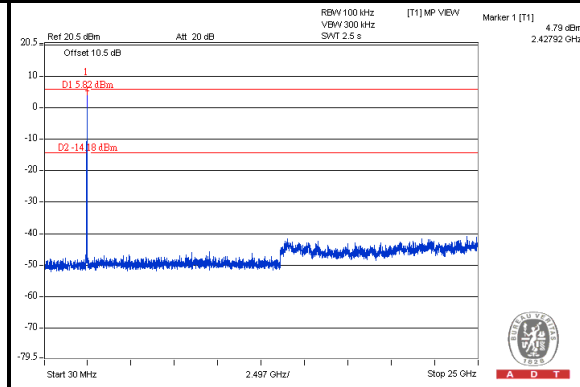
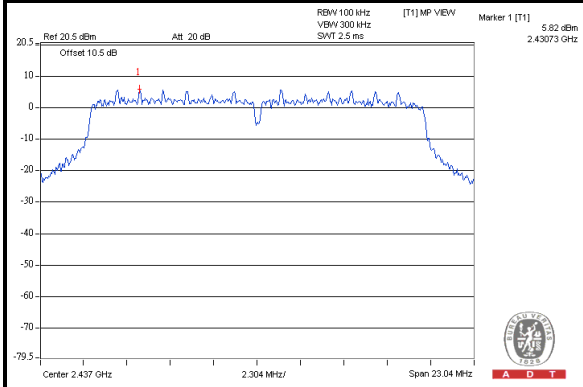

CH 11

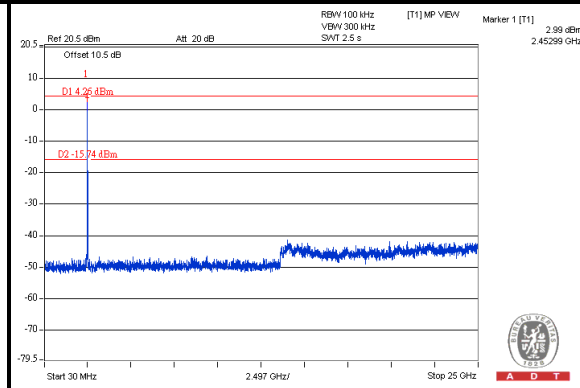
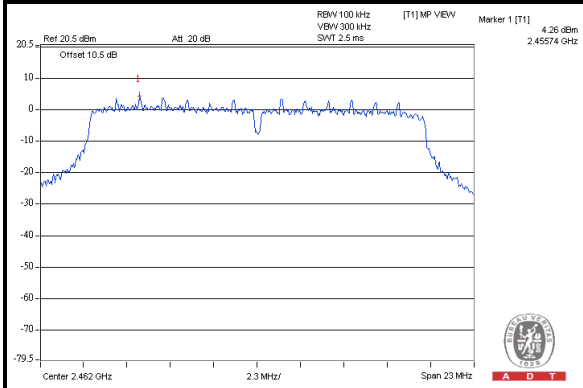



A D T

802.11n (40MHz)

CH 3

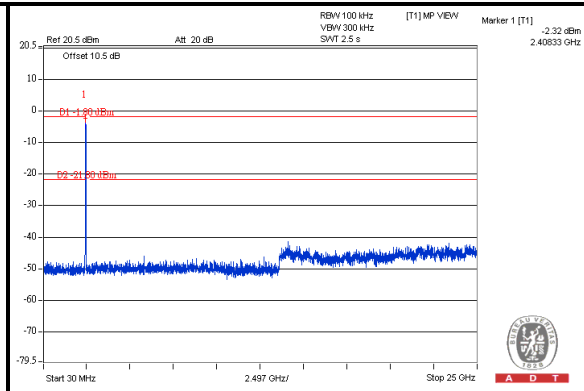
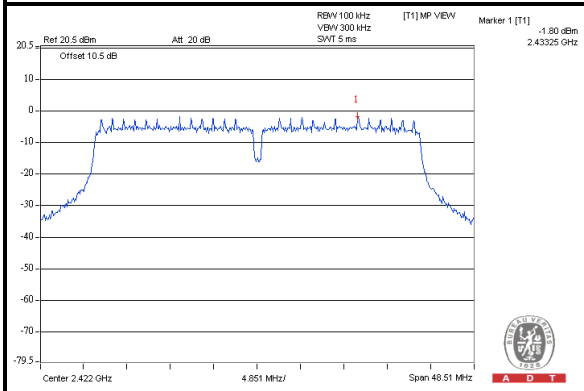

CH 6

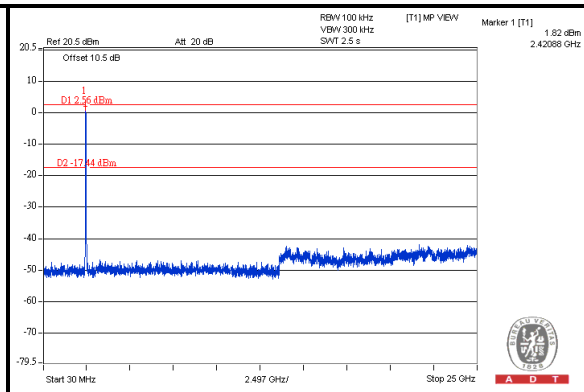
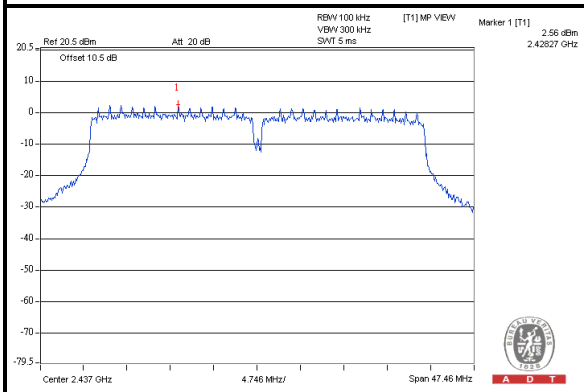

CH 9

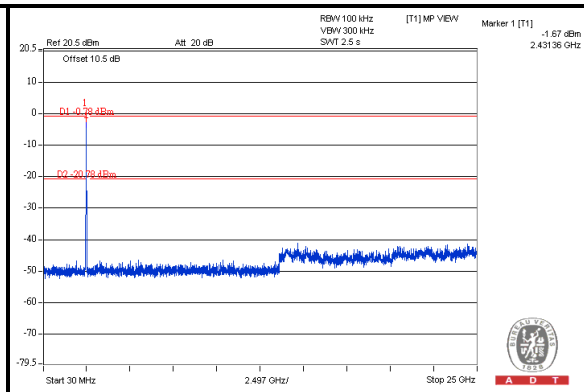
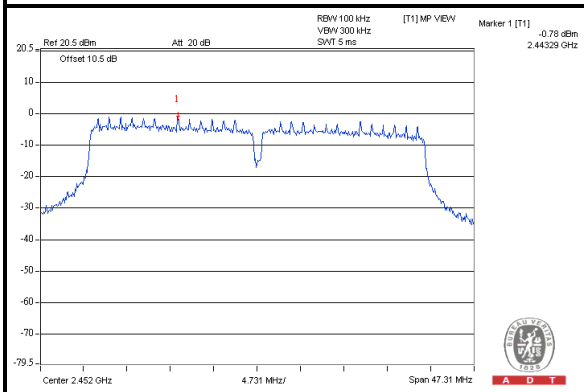



A D T

5. PHOTOGRAPHS OF THE TEST CONFIGURATION

Please refer to the attached file (Test Setup Photo).





6. INFORMATION ON THE TESTING LABORATORIES

We, Bureau Veritas Consumer Products Services (H.K.) Ltd., Taoyuan Branch, were founded in 1988 to provide our best service in EMC, Radio, Telecom and Safety consultation. Our laboratories are accredited and approved according to ISO/IEC 17025.

If you have any comments, please feel free to contact us at the following:

Linko EMC/RF Lab:

Tel: 886-2-26052180

Fax: 886-2-26052943

Hsin Chu EMC/RF Lab:

Tel: 886-3-5935343

Fax: 886-3-5935342

Hwa Ya EMC/RF/Safety/Telecom Lab:

Tel: 886-3-3183232

Fax: 886-3-3270892

Email: service.adt@tw.bureauveritas.com

Web Site: www.adt.com.tw

The address and road map of all our labs can be found in our web site also.



A D T

7. APPENDIX A - MODIFICATIONS RECORDERS FOR ENGINEERING CHANGES TO THE EUT BY THE LAB

No modifications were made to the EUT by the lab during the test.

--- END ---