

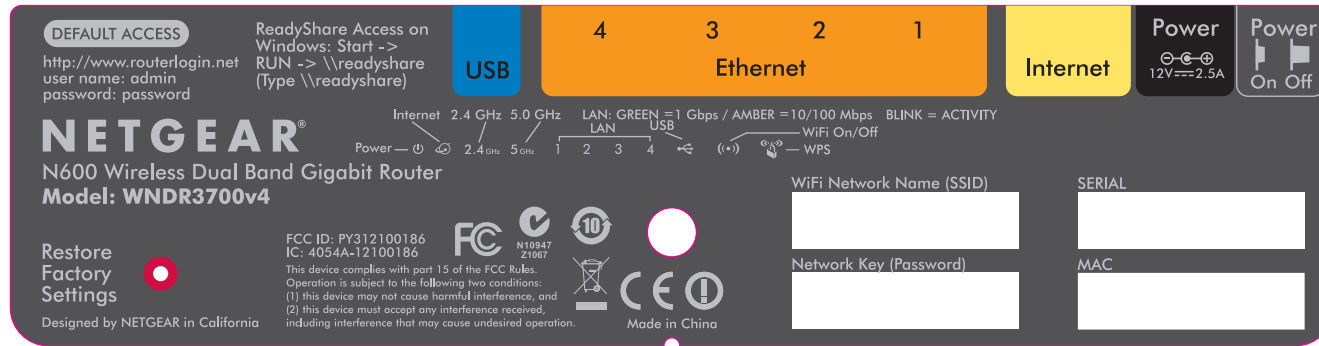







REV	DESCRIPTION OF REVISION	ENG APPD	DATE
01	INITIAL DOCUMENT CREATION	T TSAO	23JAN12



NOTE:

1. REFER TO NETGEAR SPEC. DOC-00093 FOR COLOR TOLERANCES.
2. INK COLOR IS SHOWN TO THE RIGHT.
3. DIE LINES ARE MAGENTA COLOR AND DO NOT PRINT.
4. MAC & SERIAL NUMBERS TO BE PRINTED BY THE ODM.
5. See NTGR DOC-00112 for SN standard.
6. NTGR SN and MAC address barcode to be encoded AIM USS Code39 and include printed characters below barcodes.

7. INSURE COUNTRY OF ORIGIN IS CORRECT.
 - A. IF COUNTRY OF ORIGIN IS PRE-PRINTED, UNHIDE THE APPROPRIATE COUNTRY OF ORIGIN LAYER AND INCLUDE COUNTRY OF ORIGIN ON LABEL.
 - B. IF COUNTRY OF ORIGIN IS POST-PRINTED USING A THERMAL PRINTER (OR EQUIVALENT), OMIT TEXT FROM ARTWORK (USE LAYERS).

-  Black
-  Pantone 200C
-  Pantone 114C
-  Pantone 144C
-  Pantone Cool Gray 5C
-  NETGEAR 490-10021-01
-  Pantone 285C

AUTHOR: T TSAO	TITLE: AW, WNDR3700, V4H1, PLBL	NETGEAR	
SHEET: 1 of 1	THIS DOCUMENT AND THE DATA DISCLOSED HEREIN OR WHEREWITH IS NOT TO BE REPRODUCED, USED OR DISCLOSED IN WHOLE OR IN PART TO ANYONE WITHOUT THE PERMISSION OF NETGEAR, INC.	P/N: AW-11837-01	REV: 01