



A D T

# FCC/IC SAR Test Report

**Report No.** : SA111122C09  
**Applicant** : NETGEAR, INC.  
**Address** : 350 East Plumeria Drive San Jose, CA 95134  
**Product** : N900 Wireless Dual Band USB Adapter  
**FCC ID** : PY311300176  
**IC** : 4054A-11300176  
**Brand** : NETGEAR  
**Model No.** : WNDA4100  
**Standards** : FCC 47 CFR Part 2 (2.1093) / IEEE C95.1:1991  
IEEE 1528:2003 / FCC OET Bulletin 65 Supplement C (Edition 01-01)  
IC RSS-102 Issue 4:2010 / IEC 62209-2:2010  
KDB 248227 D01 v01r02 / KDB 447498 D01 v04 / KDB 447498 D02 v02  
**Date of Testing** : Dec. 01, 2011 ~ Feb. 07, 2012

**CERTIFICATION:** The above equipment have been tested by **Bureau Veritas Consumer Products Services (H.K.) Ltd., Taoyuan Branch - Taiwan HwaYa Lab**, and found compliance with the requirement of the above standards. The test record, data evaluation & Equipment Under Test (EUT) configurations represented herein are true and accurate accounts of the measurements of the sample's SAR characteristics under the conditions specified in this report.

This test report consists of 24 pages in total except Appendix. It may be duplicated completely for legal use with the approval of the applicant. It should not be reproduced except in full, without the written approval of our laboratory. The client should not use it to claim product certification, approval, or endorsement by TAF or any government agency. The test results in the report only apply to the tested sample.

**Prepared By :**   
Rennie Wang / Assistant Manager

**Approved By :**   
Roy Wu / Manager





## Table of Contents

Release Control Record .....	3
1. Summary of Maximum SAR Value .....	4
2. Description of Equipment Under Test .....	5
3. SAR Measurement System .....	6
3.1 Definition of Specific Absorption Rate (SAR).....	6
3.2 SPEAG DASY System .....	6
3.2.1 Robot.....	7
3.2.2 Probes.....	8
3.2.3 Data Acquisition Electronics (DAE) .....	8
3.2.4 Phantoms .....	9
3.2.5 Device Holder.....	10
3.2.6 System Validation Dipoles .....	10
3.2.7 Tissue Simulating Liquids.....	11
3.3 SAR System Verification .....	13
3.4 SAR Measurement Procedure .....	14
3.4.1 Area & Zoom Scan Procedure .....	14
3.4.2 Volume Scan Procedure.....	14
3.4.3 Power Drift Monitoring.....	14
3.4.4 Spatial Peak SAR Evaluation .....	15
3.4.5 SAR Averaged Methods .....	15
4. SAR Measurement Evaluation .....	16
4.1 EUT Configuration and Setting.....	16
4.2 EUT Testing Position .....	16
4.3 Tissue Verification .....	17
4.4 System Verification.....	17
4.5 Conducted Power Results.....	18
4.6 SAR Testing Results.....	19
4.6.1 SAR Results for Body.....	19
5. Calibration of Test Equipment.....	21
6. Measurement Uncertainty .....	22
7. Information on the Testing Laboratories .....	24
Appendix A. SAR Plots of System Verification	
Appendix B. SAR Plots of SAR Measurement	
Appendix C. Calibration Certificate for Probe and Dipole	
Appendix D. Photographs of EUT and Setup	



A D T

## Release Control Record

Issue No.	Reason for Change	Date Issued
R01	Original release	Feb. 07, 2012



### 1. Summary of Maximum SAR Value

Mode / Band	Test Position	SAR-1g (W/kg)
WLAN 2.4GHz	Body (0.5 cm Gap)	0.189
WLAN 5GHz	Body (0.5 cm Gap)	1.11

**Note:**

The SAR limit (**1.6 W/kg**) for general population/uncontrolled exposure is specified in FCC 47 CFR part 2 (2.1093) and ANSI/IEEE C95.1-1991.



## FCC/IC SAR Test Report

### 2. Description of Equipment Under Test

<b>DUT Type</b>	N900 Wireless Dual Band USB Adapter
<b>FCC ID</b>	PY311300176
<b>IC</b>	4054A-11300176
<b>Brand Name</b>	NETGEAR
<b>Model Name</b>	WNDA4100
<b>Tx Frequency Bands (Unit: MHz)</b>	2400 ~ 2483.5, 5150 ~ 5350, 5470 ~ 5725, 5725 ~ 5850
<b>Uplink Modulations</b>	802.11b : DSSS 802.11a/g/n : OFDM
<b>Maximum AVG Conducted Power (Unit: dBm)</b>	802.11b : 20.00 802.11g : 19.00 802.11n HT20 (2.4GHz) : 22.90 802.11n HT40 (2.4GHz) : 22.00 802.11a : 17.70 802.11n HT20 (5GHz) : 20.25 802.11n HT40 (5GHz) : 20.94
<b>Antenna Type</b>	PIFA Antenna
<b>DUT Stage</b>	Production Unit

**Note:**

1. The above EUT information is declared by manufacturer and for more detailed features description please refers to the manufacturer's specifications or User's Manual.
2. Antenna transmitting mode

Operation Mode	Tx Function	Tx Antenna Port
802.11b	1 Tx	0
802.11g	1 Tx	0
802.11a	1 Tx	0
802.11n HT20	3 Tx	0+1+2
802.11n HT40	3 Tx	0+1+2

### **3. SAR Measurement System**

#### **3.1 Definition of Specific Absorption Rate (SAR)**

SAR is related to the rate at which energy is absorbed per unit mass in an object exposed to a radio field. The SAR distribution in a biological body is complicated and is usually carried out by experimental techniques or numerical modeling. The standard recommends limits for two tiers of groups, occupational/controlled and general population/uncontrolled, based on a person's awareness and ability to exercise control over his or her exposure. In general, occupational/controlled exposure limits are higher than the limits for general population/uncontrolled.

The SAR definition is the time derivative (rate) of the incremental energy (dW) absorbed by (dissipated in) an incremental mass (dm) contained in a volume element (dv) of a given density ( $\rho$ ). The equation description is as below:

$$\text{SAR} = \frac{d}{dt} \left( \frac{dW}{dm} \right) = \frac{d}{dt} \left( \frac{dW}{\rho dv} \right)$$

SAR is expressed in units of Watts per kilogram (W/kg)

SAR measurement can be related to the electrical field in the tissue by

$$\text{SAR} = \frac{\sigma |E|^2}{\rho}$$

Where:  $\sigma$  is the conductivity of the tissue,  $\rho$  is the mass density of the tissue and E is the RMS electrical field strength.

#### **3.2 SPEAG DASY System**

DASY system consists of high precision robot, probe alignment sensor, phantom, robot controller, controlled measurement server and near-field probe. The robot includes six axes that can move to the precision position of the DASY4/5 software defined. The DASY software can define the area that is detected by the probe. The robot is connected to controlled box. Controlled measurement server is connected to the controlled robot box. The DAE includes amplifier, signal multiplexing, AD converter, offset measurement and surface detection. It is connected to the Electro-optical coupler (ECO). The ECO performs the conversion from the optical into digital electric signal of the DAE and transfers data to the PC.



Fig-3.1 DASY System Setup

### 3.2.1 Robot

The DASY system uses the high precision robots from Stäubli SA (France). For the 6-axis controller system, the robot controller version (DASY4: CS7MB; DASY5: CS8c) from Stäubli is used. The Stäubli robot series have many features that are important for our application:

- High precision (repeatability  $\pm 0.035$  mm)
- High reliability (industrial design)
- Jerk-free straight movements
- Low ELF interference (the closed metallic construction shields against motor control fields)



Fig-3.2 DASY4





Fig-3.3 DASY5

## FCC/IC SAR Test Report

### 3.2.2 Probes

The SAR measurement is conducted with the dosimetric probe. The probe is specially designed and calibrated for use in liquid with high permittivity. The dosimetric probe has special calibration in liquid at different frequency.

<b>Model</b>	EX3DV4	
<b>Construction</b>	Symmetrical design with triangular core. Built-in shielding against static charges. PEEK enclosure material (resistant to organic solvents, e.g., DGBE).	
<b>Frequency</b>	10 MHz to 6 GHz Linearity: $\pm 0.2$ dB	
<b>Directivity</b>	$\pm 0.3$ dB in HSL (rotation around probe axis) $\pm 0.5$ dB in tissue material (rotation normal to probe axis)	
<b>Dynamic Range</b>	10 $\mu$ W/g to 100 mW/g Linearity: $\pm 0.2$ dB (noise: typically $< 1$ $\mu$ W/g)	
<b>Dimensions</b>	Overall length: 337 mm (Tip: 20 mm) Tip diameter: 2.5 mm (Body: 12 mm) Typical distance from probe tip to dipole centers: 1 mm	

<b>Model</b>	ES3DV3	
<b>Construction</b>	Symmetrical design with triangular core. Interleaved sensors. Built-in shielding against static charges. PEEK enclosure material (resistant to organic solvents, e.g., DGBE).	
<b>Frequency</b>	10 MHz to 4 GHz Linearity: $\pm 0.2$ dB	
<b>Directivity</b>	$\pm 0.2$ dB in HSL (rotation around probe axis) $\pm 0.3$ dB in tissue material (rotation normal to probe axis)	
<b>Dynamic Range</b>	5 $\mu$ W/g to 100 mW/g Linearity: $\pm 0.2$ dB	
<b>Dimensions</b>	Overall length: 337 mm (Tip: 20 mm) Tip diameter: 3.9 mm (Body: 12 mm) Distance from probe tip to dipole centers: 2.0 mm	

### 3.2.3 Data Acquisition Electronics (DAE)

<b>Model</b>	DAE3, DAE4	
<b>Construction</b>	Signal amplifier, multiplexer, A/D converter and control logic. Serial optical link for communication with DASY4/5 embedded system (fully remote controlled). Two step probe touch detector for mechanical surface detection and emergency robot stop.	
<b>Measurement Range</b>	-100 to +300 mV (16 bit resolution and two range settings: 4mV, 400mV)	
<b>Input Offset Voltage</b>	$< 5$ $\mu$ V (with auto zero)	
<b>Input Bias Current</b>	$< 50$ fA	
<b>Dimensions</b>	60 x 60 x 68 mm	



# FCC/IC SAR Test Report

## 3.2.4 Phantoms

<b>Model</b>	Twin SAM	
<b>Construction</b>	The shell corresponds to the specifications of the Specific Anthropomorphic Mannequin (SAM) phantom defined in IEEE 1528 and IEC 62209-1. It enables the dosimetric evaluation of left and right hand phone usage as well as body mounted usage at the flat phantom region. A cover prevents evaporation of the liquid. Reference markings on the phantom allow the complete setup of all predefined phantom positions and measurement grids by teaching three points with the robot.	
<b>Material</b>	Vinylester, glass fiber reinforced (VE-GF)	
<b>Shell Thickness</b>	2 ± 0.2 mm (6 ± 0.2 mm at ear point)	
<b>Dimensions</b>	Length: 1000 mm Width: 500 mm Height: adjustable feet	
<b>Filling Volume</b>	approx. 25 liters	

<b>Model</b>	ELI	
<b>Construction</b>	Phantom for compliance testing of handheld and body-mounted wireless devices in the frequency range of 30 MHz to 6 GHz. ELI is fully compatible with the IEC 62209-2 standard and all known tissue simulating liquids. ELI has been optimized regarding its performance and can be integrated into our standard phantom tables. A cover prevents evaporation of the liquid. Reference markings on the phantom allow installation of the complete setup, including all predefined phantom positions and measurement grids, by teaching three points. The phantom is compatible with all SPEAG dosimetric probes and dipoles.	
<b>Material</b>	Vinylester, glass fiber reinforced (VE-GF)	
<b>Shell Thickness</b>	2.0 ± 0.2 mm (bottom plate)	
<b>Dimensions</b>	Major axis: 600 mm Minor axis: 400 mm	
<b>Filling Volume</b>	approx. 30 liters	

## FCC/IC SAR Test Report

### 3.2.5 Device Holder

<b>Model</b>	Mounting Device	
<b>Construction</b>	In combination with the Twin SAM Phantom or ELI4, the Mounting Device enables the rotation of the mounted transmitter device in spherical coordinates. Rotation point is the ear opening point. Transmitter devices can be easily and accurately positioned according to IEC, IEEE, FCC or other specifications. The device holder can be locked for positioning at different phantom sections (left head, right head, flat).	
<b>Material</b>	POM	

<b>Model</b>	Laptop Extensions Kit	
<b>Construction</b>	Simple but effective and easy-to-use extension for Mounting Device that facilitates the testing of larger devices according to IEC 62209-2 (e.g., laptops, cameras, etc.). It is lightweight and fits easily on the upper part of the Mounting Device in place of the phone positioner.	
<b>Material</b>	POM, Acrylic glass, Foam	

### 3.2.6 System Validation Dipoles

<b>Model</b>	D-Serial	
<b>Construction</b>	Symmetrical dipole with 1/4 balun. Enables measurement of feed point impedance with NWA. Matched for use near flat phantoms filled with tissue simulating solutions.	
<b>Frequency</b>	750 MHz to 5800 MHz	
<b>Return Loss</b>	> 20 dB	
<b>Power Capability</b>	> 100 W (f < 1GHz), > 40 W (f > 1GHz)	



## FCC/IC SAR Test Report

### 3.2.7 Tissue Simulating Liquids

For SAR measurement of the field distribution inside the phantom, the phantom must be filled with homogeneous tissue simulating liquid to a depth of at least 15 cm. For head SAR testing, the liquid height from the ear reference point (ERP) of the phantom to the liquid top surface is larger than 15 cm. For body SAR testing, the liquid height from the center of the flat phantom to the liquid top surface is larger than 15 cm. The nominal dielectric values of the tissue simulating liquids in the phantom and the tolerance of 5% are listed in below table.

The body tissue parameters that have not been specified in IEEE 1528 are derived from the tissue dielectric parameters computed from the 4-Cole-Cole equations and extrapolated according to the head parameters specified in IEEE 1528. The dielectric properties of the tissue simulating liquids were verified prior to the SAR evaluation using an Agilent 85070D Dielectric Probe Kit and an Agilent Network Analyzer.

**Table-3.1 Targets of Tissue Simulating Liquid**

Frequency (MHz)	Target Permittivity	Range of $\pm 5\%$	Target Conductivity	Range of $\pm 5\%$
<b>For Head</b>				
750	41.9	39.8 ~ 44.0	0.89	0.85 ~ 0.93
835	41.5	39.4 ~ 43.6	0.90	0.86 ~ 0.95
900	41.5	39.4 ~ 43.6	0.97	0.92 ~ 1.02
1450	40.5	38.5 ~ 42.5	1.20	1.14 ~ 1.26
1640	40.3	38.3 ~ 42.3	1.29	1.23 ~ 1.35
1750	40.1	38.1 ~ 42.1	1.37	1.30 ~ 1.44
1800	40.0	38.0 ~ 42.0	1.40	1.33 ~ 1.47
1900	40.0	38.0 ~ 42.0	1.40	1.33 ~ 1.47
2000	40.0	38.0 ~ 42.0	1.40	1.33 ~ 1.47
2300	39.5	37.5 ~ 41.5	1.67	1.59 ~ 1.75
2450	39.2	37.2 ~ 41.2	1.80	1.71 ~ 1.89
2600	39.0	37.1 ~ 41.0	1.96	1.86 ~ 2.06
3500	37.9	36.0 ~ 39.8	2.91	2.76 ~ 3.06
5200	36.0	34.2 ~ 37.8	4.66	4.43 ~ 4.89
5300	35.9	34.1 ~ 37.7	4.76	4.52 ~ 5.00
5500	35.6	33.8 ~ 37.4	4.96	4.71 ~ 5.21
5600	35.5	33.7 ~ 37.3	5.07	4.82 ~ 5.32
5800	35.3	33.5 ~ 37.1	5.27	5.01 ~ 5.53
<b>For Body</b>				
750	55.5	52.7 ~ 58.3	0.96	0.91 ~ 1.01
835	55.2	52.4 ~ 58.0	0.97	0.92 ~ 1.02
900	55.0	52.3 ~ 57.8	1.05	1.00 ~ 1.10
1450	54.0	51.3 ~ 56.7	1.30	1.24 ~ 1.37
1640	53.8	51.1 ~ 56.5	1.40	1.33 ~ 1.47
1750	53.4	50.7 ~ 56.1	1.49	1.42 ~ 1.56
1800	53.3	50.6 ~ 56.0	1.52	1.44 ~ 1.60
1900	53.3	50.6 ~ 56.0	1.52	1.44 ~ 1.60
2000	53.3	50.6 ~ 56.0	1.52	1.44 ~ 1.60
2300	52.9	50.3 ~ 55.5	1.81	1.72 ~ 1.90
2450	52.7	50.1 ~ 55.3	1.95	1.85 ~ 2.05
2600	52.5	49.9 ~ 55.1	2.16	2.05 ~ 2.27
3500	51.3	48.7 ~ 53.9	3.31	3.14 ~ 3.48
5200	49.0	46.6 ~ 51.5	5.30	5.04 ~ 5.57
5300	48.9	46.5 ~ 51.3	5.42	5.15 ~ 5.69
5500	48.6	46.2 ~ 51.0	5.65	5.37 ~ 5.93
5600	48.5	46.1 ~ 50.9	5.77	5.48 ~ 6.06
5800	48.2	45.8 ~ 50.6	6.00	5.70 ~ 6.30

**FCC/IC SAR Test Report**

The following table gives the recipes for tissue simulating liquids.

**Table-3.2 Recipes of Tissue Simulating Liquid**

Tissue Type	Bactericide	DGBE	HEC	NaCl	Sucrose	Triton X-100	Water	Diethylene Glycol Mono-hexylether
H750	0.2	-	0.2	1.5	56.0	-	42.1	-
H835	0.2	-	0.2	1.5	57.0	-	41.1	-
H900	0.2	-	0.2	1.4	58.0	-	40.2	-
H1450	-	43.3	-	0.6	-	-	56.1	-
H1640	-	45.8	-	0.5	-	-	53.7	-
H1750	-	47.0	-	0.4	-	-	52.6	-
H1800	-	44.5	-	0.3	-	-	55.2	-
H1900	-	44.5	-	0.2	-	-	55.3	-
H2000	-	44.5	-	0.1	-	-	55.4	-
H2300	-	44.9	-	0.1	-	-	55.0	-
H2450	-	45.0	-	0.1	-	-	54.9	-
H2600	-	45.1	-	0.1	-	-	54.8	-
H3500	-	8.0	-	0.2	-	20.0	71.8	-
H5G	-	-	-	-	-	17.2	65.5	17.3
B750	0.2	-	0.2	0.8	48.8	-	50.0	-
B835	0.2	-	0.2	0.9	48.5	-	50.2	-
B900	0.2	-	0.2	0.9	48.2	-	50.5	-
B1450	-	34.0	-	0.3	-	-	65.7	-
B1640	-	32.5	-	0.3	-	-	67.2	-
B1750	-	31.0	-	0.2	-	-	68.8	-
B1800	-	29.5	-	0.4	-	-	70.1	-
B1900	-	29.5	-	0.3	-	-	70.2	-
B2000	-	30.0	-	0.2	-	-	69.8	-
B2300	-	31.0	-	0.1	-	-	68.9	-
B2450	-	31.4	-	0.1	-	-	68.5	-
B2600	-	31.8	-	0.1	-	-	68.1	-
B3500	-	28.8	-	0.1	-	-	71.1	-
B5G	-	-	-	-	-	10.7	78.6	10.7

### 3.3 SAR System Verification

The system check verifies that the system operates within its specifications. It is performed daily or before every SAR measurement. The system check uses normal SAR measurements in the flat section of the phantom with a matched dipole at a specified distance. The system verification setup is shown as below.

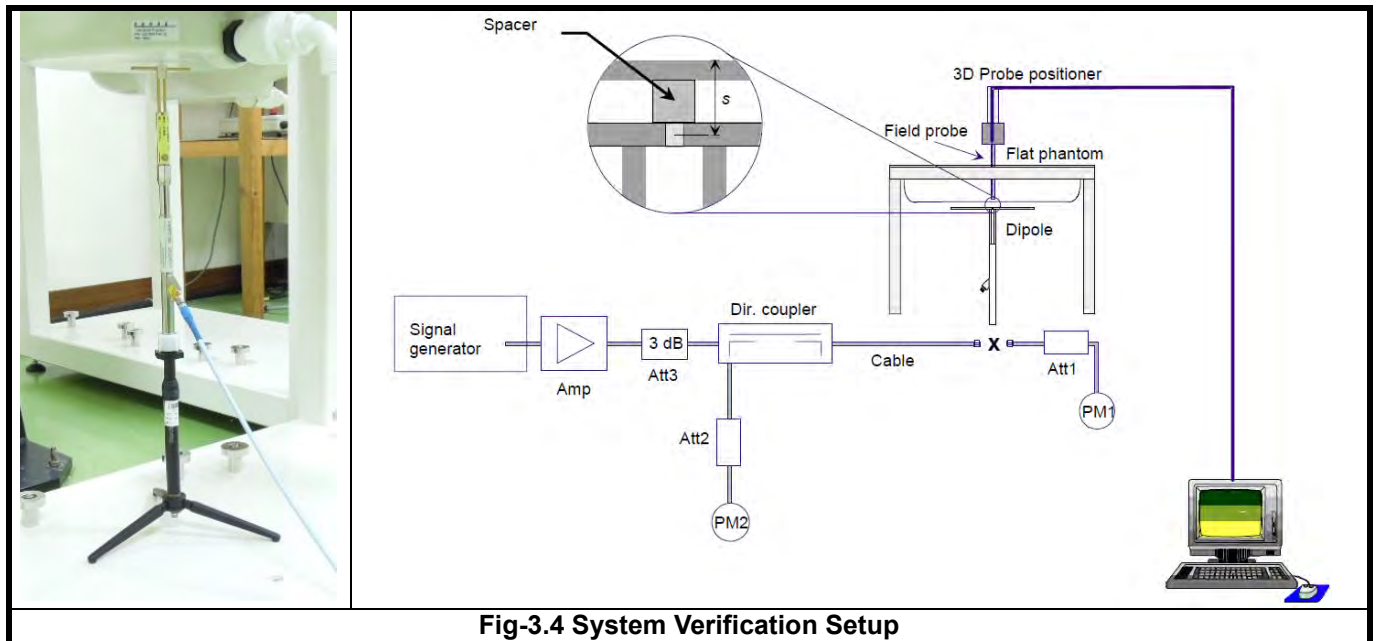

**Fig-3.4 System Verification Setup**

The validation dipole is placed beneath the flat phantom with the specific spacer in place. The distance spacer is touch the phantom surface with a light pressure at the reference marking and be oriented parallel to the long side of the phantom. The power meter PM1 measures the forward power at the location of the system check dipole connector. The signal generator is adjusted for the desired forward power (250 mW is used for 700 MHz to 3 GHz, 100 mW is used for 3.5 GHz to 6 GHz) at the dipole connector and the power meter PM2 is read at that level. After connecting the cable to the dipole, the signal generator is readjusted for the same reading at power meter PM2.

After system check testing, the SAR result will be normalized to 1W forward input power and compared with the reference SAR value derived from validation dipole certificate report. The deviation of system check should be within 10 %.

## **3.4 SAR Measurement Procedure**

According to the SAR test standard, the recommended procedure for assessing the peak spatial-average SAR value consists of the following steps:

- (a) Power reference measurement
- (b) Area scan
- (c) Zoom scan
- (d) Power drift measurement

The SAR measurement procedures for each of test conditions are as follows:

- (a) Make EUT to transmit maximum output power
- (b) Measure conducted output power through RF cable
- (c) Place the EUT in the specific position of phantom
- (d) Perform SAR testing steps on the DASY system
- (e) Record the SAR value

### **3.4.1 Area & Zoom Scan Procedure**

First Area Scan is used to locate the approximate location(s) of the local peak SAR value(s). The measurement grid within an Area Scan is defined by the grid extent, grid step size and grid offset. Next, in order to determine the EM field distribution in a three-dimensional spatial extension, Zoom Scan is required. The Zoom Scan measures 5x5x7 points with step size 8, 8 and 5 mm for below 3 GHz, and 7x7x9 points with step size 4, 4 and 2.5 mm for above 5 GHz. The Zoom Scan is performed around the highest E-field value to determine the averaged SAR-distribution over 10 g.

### **3.4.2 Volume Scan Procedure**

The volume scan is used for assess overlapping SAR distributions for antennas transmitting in different frequency bands. It is equivalent to an oversized zoom scan used in standalone measurements. The measurement volume will be used to enclose all the simultaneous transmitting antennas. For antennas transmitting simultaneously in different frequency bands, the volume scan is measured separately in each frequency band. In order to sum correctly to compute the 1g aggregate SAR, the DUT remain in the same test position for all measurements and all volume scan use the same spatial resolution and grid spacing. When all volume scan were completed, the software, SEMCAD postprocessor can combine and subsequently superpose these measurement data to calculating the multiband SAR.

### **3.4.3 Power Drift Monitoring**

All SAR testing is under the DUT install full charged battery and transmit maximum output power. In DASY measurement software, the power reference measurement and power drift measurement procedures are used for monitoring the power drift of DUT during SAR test. Both these procedures measure the field at a specified reference position before and after the SAR testing. The software will calculate the field difference in dB. If the power drift more than 5%, the SAR will be retested.



## FCC/IC SAR Test Report

---

### 3.4.4 Spatial Peak SAR Evaluation

The procedure for spatial peak SAR evaluation has been implemented according to the test standard. It can be conducted for 1g and 10g, as well as for user-specific masses. The DASY software includes all numerical procedures necessary to evaluate the spatial peak SAR value.

The base for the evaluation is a "cube" measurement. The measured volume must include the 1g and 10g cubes with the highest averaged SAR values. For that purpose, the center of the measured volume is aligned to the interpolated peak SAR value of a previously performed area scan.

The entire evaluation of the spatial peak values is performed within the post-processing engine (SEMCAD). The system always gives the maximum values for the 1g and 10g cubes. The algorithm to find the cube with highest averaged SAR is divided into the following stages:

- (a) Extraction of the measured data (grid and values) from the Zoom Scan
- (b) Calculation of the SAR value at every measurement point based on all stored data (A/D values and measurement parameters)
- (c) Generation of a high-resolution mesh within the measured volume
- (d) Interpolation of all measured values from the measurement grid to the high-resolution grid
- (e) Extrapolation of the entire 3-D field distribution to the phantom surface over the distance from sensor to surface
- (f) Calculation of the averaged SAR within masses of 1g and 10g

### 3.4.5 SAR Averaged Methods

In DASY, the interpolation and extrapolation are both based on the modified Quadratic Shepard's method. The interpolation scheme combines a least-square fitted function method and a weighted average method which are the two basic types of computational interpolation and approximation.

Extrapolation routines are used to obtain SAR values between the lowest measurement points and the inner phantom surface. The extrapolation distance is determined by the surface detection distance and the probe sensor offset. The uncertainty increases with the extrapolation distance. To keep the uncertainty within 1% for the 1 g and 10 g cubes, the extrapolation distance should not be larger than 5 mm.

## **4. SAR Measurement Evaluation**

### **4.1 EUT Configuration and Setting**

For WLAN SAR testing, the EUT has installed WLAN engineering testing software which can provide continuous transmitting RF signal. This RF signal utilized in SAR measurement has almost 100% duty cycle. The data rates for WLAN SAR testing were set in 1 Mbps for 802.11b, 6 Mbps for 802.11g, 6Mbps for 802.11a, and MCS0 for 802.11n per KDB 248227.

### **4.2 EUT Testing Position**

This DUT was tested in four different USB configurations. They are “direct laptop plug-in for configuration 1 and 4”, “USB cable plug-in for configuration 2, 3”, and “USB cable plug-in for DUT Tip Mode” shown as below. Both direct laptop plug-in and USB cable plug-in test configurations are tested with 5 mm separation between the particular dongle orientation and the flat phantom.

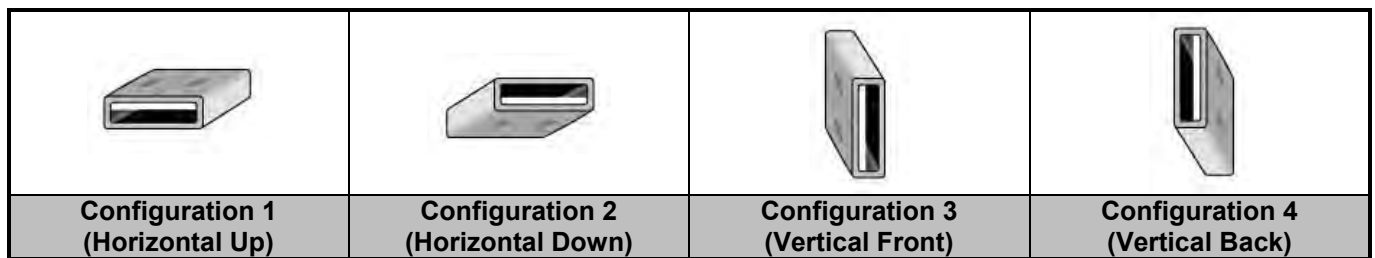

**Fig-4.1 Illustration for USB Connector Orientations**





# FCC/IC SAR Test Report

## 4.3 Tissue Verification

The measuring results for tissue simulating liquid are shown as below.

Tissue Type	Frequency (MHz)	Liquid Temp. (°C)	Measured Conductivity (σ)	Measured Permittivity (ε <sub>r</sub> )	Target Conductivity (σ)	Target Permittivity (ε <sub>r</sub> )	Conductivity Deviation (%)	Permittivity Deviation (%)	Test Date
B2450	2450	21.6	1.97	51.2	1.95	52.7	1.03	-2.85	Dec. 01, 2011
B2450	2450	20.6	1.97	50.9	1.95	52.7	1.03	-3.42	Feb. 07, 2012
B5G	5200	21.1	5.18	47.8	5.3	49	-2.26	-2.45	Dec. 13, 2011
B5G	5200	21.4	5.196	48.174	5.3	49	-1.96	-1.69	Dec. 21, 2011
B5G	5200	20.7	5.17	47.5	5.3	49	-2.45	-3.06	Feb. 06, 2012
B5G	5500	21.1	5.68	47.8	5.65	48.6	0.53	-1.65	Dec. 13, 2011
B5G	5500	21.4	5.699	48.07	5.65	48.6	0.87	-1.09	Dec. 21, 2011
B5G	5500	20.7	5.66	47.4	5.65	48.6	0.18	-2.47	Feb. 06, 2012
B5G	5800	21.3	6.25	46.7	6	48.2	4.17	-3.11	Dec. 06, 2011
B5G	5800	21.1	6.26	47.1	6	48.2	4.33	-2.28	Dec. 13, 2011
B5G	5800	20.7	6.25	46.7	6	48.2	4.17	-3.11	Feb. 06, 2012

**Note:**

The dielectric properties of the tissue simulating liquid must be measured within 24 hours before the SAR testing and within ±5% of the target values. Liquid temperature during the SAR testing must be within ±2 °C.

## 4.4 System Verification

The measuring results for system check are shown as below.

Test Date	Frequency (MHz)	1W Target SAR-1g (W/kg)	Measured SAR-1g (W/kg)	Normalized to 1W SAR-1g (W/kg)	Deviation (%)	Dipole S/N	Probe S/N	DAE S/N
Dec. 01, 2011	2450	53.30	13.60	54.40	2.06	716	3650	1277
Feb. 07, 2012	2450	53.30	13.10	52.40	-1.69	716	3650	579
Dec. 13, 2011	5200	77.10	7.99	79.90	3.63	1019	3650	1277
Dec. 21, 2011	5200	77.10	7.53	75.30	-2.33	1019	3650	1277
Feb. 06, 2012	5200	77.10	7.98	79.80	3.50	1019	3650	579
Dec. 13, 2011	5500	82.40	8.32	83.20	0.97	1019	3650	1277
Dec. 21, 2011	5500	82.40	8.04	80.40	-2.43	1019	3650	1277
Feb. 06, 2012	5500	82.40	8.31	83.10	0.85	1019	3650	579
Dec. 06, 2011	5800	73.40	7.85	78.50	6.95	1019	3650	1277
Dec. 13, 2011	5800	73.40	7.39	73.90	0.68	1019	3650	1277
Feb. 06, 2012	5800	73.40	7.40	74.00	0.82	1019	3650	579

**Note:**

Comparing to the reference SAR value provided by SPEAG, the validation data should be within its specification of 10 %. The result indicates the system check can meet the variation criterion and the plots can be referred to Appendix A of this report.

# FCC/IC SAR Test Report

## 4.5 Conducted Power Results

The measuring conducted power (Unit: dBm) are shown as below.

Band	802.11b			802.11g		
Channel	1	6	11	1	6	11
Frequency (MHz)	2412	2437	2462	2412	2437	2462
Average Power	19.30	20.00	18.60	18.10	19.00	16.80

Band	802.11n (HT20)			802.11n (HT40)		
Channel	1	6	11	3	6	9
Frequency (MHz)	2412	2437	2462	2422	2437	2452
Average Power	20.90	22.90	21.50	21.30	22.00	20.10

Band	802.11a							
Channel	36	40	44	48	52	56	60	64
Frequency (MHz)	5180	5200	5220	5240	5260	5280	5300	5320
Average Power	14.40	14.50	14.30	14.30	16.40	16.30	16.50	16.50

Band	802.11a							
Channel	100	104	108	112	116	132	136	140
Frequency (MHz)	5500	5520	5540	5560	5580	5660	5680	5700
Average Power	17.70	17.10	17.10	17.00	17.50	17.40	17.30	16.90

Band	802.11a							
Channel	149	153	157	161	165	-	-	-
Frequency (MHz)	5745	5765	5785	5805	5825	-	-	-
Average Power	16.80	15.80	16.40	16.50	15.90	-	-	-

Band	802.11n (HT20)							
Channel	36	40	44	48	52	56	60	64
Frequency (MHz)	5180	5200	5220	5240	5260	5280	5300	5320
Average Power	13.37	13.34	13.20	13.34	19.87	19.77	19.80	19.87

Band	802.11n (HT20)							
Channel	100	104	108	112	116	132	136	140
Frequency (MHz)	5500	5520	5540	5560	5580	5660	5680	5700
Average Power	19.87	19.74	19.74	19.77	19.87	19.90	19.80	19.87

Band	802.11n (HT20)							
Channel	149	153	157	161	165	-	-	-
Frequency (MHz)	5745	5765	5785	5805	5825	-	-	-
Average Power	20.25	20.08	19.75	19.58	19.66	-	-	-

Band	802.11n (HT40)								
Channel	38	46	54	62	102	118	134	151	159
Frequency (MHz)	5190	5230	5270	5310	5510	5590	5670	5755	5795
Average Power	15.04	15.07	20.58	20.74	20.94	20.77	20.87	20.21	20.61

# FCC/IC SAR Test Report

## 4.6 SAR Testing Results

### 4.6.1 SAR Results for Body

Plot No.	Band	Mode	Test Position	Separation Distance (cm)	Channel	Tx Antenna	SAR-1g (W/kg)
1	802.11b	-	Horizontal Up	0.5	6	0	0.119
2	802.11b	-	Horizontal Down	0.5	6	0	0.108
3	802.11b	-	Vertical Front	0.5	6	0	0.134
4	802.11b	-	Vertical Back	0.5	6	0	0.00646
5	802.11b	-	Tip Mode	0.5	6	0	0.017
101	802.11n	HT20	Horizontal Up	0.5	6	0+1+2	0.188
102	802.11n	HT20	Horizontal Down	0.5	6	0+1+2	0.145
6	802.11n	HT20	Vertical Front	0.5	6	0+1+2	<b>0.189</b>
103	802.11n	HT20	Vertical Back	0.5	6	0+1+2	0.131
104	802.11n	HT20	Tip Mode	0.5	6	0+1+2	0.019
11	802.11a	-	Horizontal Up	0.5	40	0	0.167
12	802.11a	-	Horizontal Down	0.5	40	0	0.066
13	802.11a	-	Vertical Front	0.5	40	0	0.383
14	802.11a	-	Vertical Back	0.5	40	0	0.014
15	802.11a	-	Tip Mode	0.5	40	0	0.016
105	802.11n	HT40	Horizontal Up	0.5	46	0+1+2	0.17
106	802.11n	HT40	Horizontal Down	0.5	46	0+1+2	0.038
19	802.11n	HT40	Vertical Front	0.5	46	0+1+2	0.161
107	802.11n	HT40	Vertical Back	0.5	46	0+1+2	0.209
108	802.11n	HT40	Tip Mode	0.5	46	0+1+2	0.013
68	802.11a	-	Horizontal Up	0.5	64	0	0.453
69	802.11a	-	Horizontal Down	0.5	64	0	0.169
60	802.11a	-	Vertical Front	0.5	64	0	1.01
71	802.11a	-	Vertical Back	0.5	64	0	0.052
72	802.11a	-	Tip Mode	0.5	64	0	0.054
88	802.11a	-	Vertical Front	0.5	52	0	1.04
109	802.11n	HT40	Horizontal Up	0.5	62	0+1+2	0.753
110	802.11n	HT40	Horizontal Down	0.5	62	0+1+2	0.2
29	802.11n	HT40	Vertical Front	0.5	62	0+1+2	0.67
111	802.11n	HT40	Vertical Back	0.5	62	0+1+2	0.733
112	802.11n	HT40	Tip Mode	0.5	62	0+1+2	0.057

#### Note:

1. For WLAN 2.4G, SAR testing for 802.11g and 802.11n HT40 is not required because the maximum power of 802.11g is lower than 802.11b and 802.11n HT40 is lower than 802.11n HT20.
2. For WLAN 5G, SAR testing for 802.11n HT20 is not required because the maximum power of 802.11n HT20 is lower than 802.11n HT40.
3. SAR testing for other channels is not required when the SAR value of maximum output power channel is less than 0.8 W/kg per KDB 248227.



## FCC/IC SAR Test Report

Plot No.	Band	Mode	Test Position	Separation Distance (cm)	Channel	Tx Antenna	SAR-1g (W/kg)
73	802.11a	-	Horizontal Up	0.5	100	0	0.389
74	802.11a	-	Horizontal Down	0.5	100	0	0.16
63	802.11a	-	Vertical Front	0.5	100	0	<b>1.11</b>
76	802.11a	-	Vertical Back	0.5	100	0	0.072
77	802.11a	-	Tip Mode	0.5	100	0	0.041
65	802.11a	-	Vertical Front	0.5	116	0	1.04
89	802.11a	-	Vertical Front	0.5	132	0	0.887
123	802.11n	HT40	Horizontal Up	0.5	102	0+1+2	0.494
124	802.11n	HT40	Horizontal Down	0.5	102	0+1+2	0.109
42	802.11n	HT40	Vertical Front	0.5	102	0+1+2	0.485
125	802.11n	HT40	Vertical Back	0.5	102	0+1+2	0.431
126	802.11n	HT40	Tip Mode	0.5	102	0+1+2	0.034
45	802.11a	-	Horizontal Up	0.5	149	0	0.387
46	802.11a	-	Horizontal Down	0.5	149	0	0.173
47	802.11a	-	Vertical Front	0.5	149	0	0.89
48	802.11a	-	Vertical Back	0.5	149	0	0.111
49	802.11a	-	Tip Mode	0.5	149	0	0.076
50	802.11a	-	Vertical Front	0.5	157	0	0.765
51	802.11a	-	Vertical Front	0.5	161	0	0.715
52	802.11a	-	Vertical Front	0.5	165	0	0.618
127	802.11n	HT40	Horizontal Up	0.5	159	0+1+2	0.337
128	802.11n	HT40	Horizontal Down	0.5	159	0+1+2	0.121
54	802.11n	HT40	Vertical Front	0.5	159	0+1+2	0.398
129	802.11n	HT40	Vertical Back	0.5	159	0+1+2	0.311
130	802.11n	HT40	Tip Mode	0.5	159	0+1+2	0.068

**Note:**

1. For WLAN 5G, SAR testing for 802.11n HT20 is not required because the maximum power of 802.11n HT20 is lower than 802.11n HT40.
2. SAR testing for other channels is not required when the SAR value of maximum output power channel is less than 0.8 W/kg per KDB 248227.

**Test Engineer :** Match Tsui

**5. Calibration of Test Equipment**

Equipment	Manufacturer	Model	SN	Cal. Date	Cal. Interval
Dosimetric E-Field Probe	SPEAG	EX3DV4	3650	Oct. 26, 2011	Annual
System Validation Kit	SPEAG	D2450V2	716	Jan. 26, 2011	Annual
System Validation Kit	SPEAG	D5GHzV2	1019	Jan. 25, 2011	Annual
Data Acquisition Electronics	SPEAG	DAE4	579	Sep. 23, 2011	Annual
Data Acquisition Electronics	SPEAG	DAE4	1277	Jul. 29, 2011	Annual
SAM Phantom	SPEAG	QD000P40CD	TP-1652	N/A	N/A
SAM Phantom	SPEAG	QD000P40CD	TP-1654	N/A	N/A
SAM Phantom	SPEAG	QD000P40CD	TP-1485	N/A	N/A
SAM Phantom	SPEAG	QD000P40CD	TP-1202	N/A	N/A
SAM Phantom	SPEAG	QD000P40CD	TP-1653	N/A	N/A
ELI Phantom	SPEAG	QDOVA001B	TP-1039	N/A	N/A
ELI Phantom	SPEAG	QDOVA001B	TP-1043	N/A	N/A
ENA Series Network Analyzer	Agilent	E5071C	MY46104190	Apr. 15, 2011	Annual
Signal Generator	Agilent	E8257C	MY43320668	Dec. 20, 2011	Annual
Power Meter	Anritsu	ML2487A	6K00001571	May 25, 2011	Annual
Power Sensor	Anritsu	MA2491A	030954	May 25, 2011	Annual
Dielectric Probe Kit	Agilent	85070D	N/A	N/A	N/A

## 6. Measurement Uncertainty

Error Description	Uncertainty Value (±%)	Probability Distribution	Divisor	C <sub>i</sub> (1g)	Standard Uncertainty (1g)	V <sub>i</sub>
<b>Measurement System</b>						
Probe Calibration	6.0	Normal	1	1	± 6.0 %	∞
Axial Isotropy	4.7	Rectangular	√3	0.7	± 1.9 %	∞
Hemispherical Isotropy	9.6	Rectangular	√3	0.7	± 3.9 %	∞
Boundary Effects	1.0	Rectangular	√3	1	± 0.6 %	∞
Linearity	4.7	Rectangular	√3	1	± 2.7 %	∞
System Detection Limits	1.0	Rectangular	√3	1	± 0.6 %	∞
Readout Electronics	0.6	Normal	1	1	± 0.6 %	∞
Response Time	0.0	Rectangular	√3	1	± 0.0 %	∞
Integration Time	1.7	Rectangular	√3	1	± 1.0 %	∞
RF Ambient Noise	3.0	Rectangular	√3	1	± 1.7 %	∞
RF Ambient Reflections	3.0	Rectangular	√3	1	± 1.7 %	∞
Probe Positioner	0.5	Rectangular	√3	1	± 0.3 %	∞
Probe Positioning	2.9	Rectangular	√3	1	± 1.7 %	∞
Max. SAR Eval.	2.3	Rectangular	√3	1	± 1.3 %	∞
<b>Test Sample Related</b>						
Device Positioning	3.9	Normal	1	1	± 3.9 %	31
Device Holder	2.7	Normal	1	1	± 2.7 %	19
Power Drift	5.0	Rectangular	√3	1	± 2.9 %	∞
<b>Phantom and Setup</b>						
Phantom Uncertainty	4.0	Rectangular	√3	1	± 2.3 %	∞
Liquid Conductivity (Target)	5.0	Rectangular	√3	0.64	± 1.8 %	∞
Liquid Conductivity (Meas.)	5.0	Normal	1	0.64	± 3.2 %	29
Liquid Permittivity (Target)	5.0	Rectangular	√3	0.6	± 1.7 %	∞
Liquid Permittivity (Meas.)	5.0	Normal	1	0.6	± 3.0 %	29
<b>Combined Standard Uncertainty</b>					± 11.7 %	
<b>Expanded Uncertainty (K=2)</b>					<b>± 23.4 %</b>	

**Uncertainty budget for frequency range 300 MHz to 3 GHz**



# FCC/IC SAR Test Report

Error Description	Uncertainty Value (±%)	Probability Distribution	Divisor	Ci (1g)	Standard Uncertainty (1g)	Vi
<b>Measurement System</b>						
Probe Calibration	6.55	Normal	1	1	± 6.55 %	∞
Axial Isotropy	4.7	Rectangular	√3	0.7	± 1.9 %	∞
Hemispherical Isotropy	9.6	Rectangular	√3	0.7	± 3.9 %	∞
Boundary Effects	2.0	Rectangular	√3	1	± 1.2 %	∞
Linearity	4.7	Rectangular	√3	1	± 2.7 %	∞
System Detection Limits	1.0	Rectangular	√3	1	± 0.6 %	∞
Readout Electronics	0.3	Normal	1	1	± 0.3 %	∞
Response Time	0.8	Rectangular	√3	1	± 0.5 %	∞
Integration Time	2.6	Rectangular	√3	1	± 1.5 %	∞
RF Ambient Noise	3.0	Rectangular	√3	1	± 1.7 %	∞
RF Ambient Reflections	3.0	Rectangular	√3	1	± 1.7 %	∞
Probe Positioner	0.8	Rectangular	√3	1	± 0.5 %	∞
Probe Positioning	9.9	Rectangular	√3	1	± 5.7 %	∞
Max. SAR Eval.	4.0	Rectangular	√3	1	± 2.3 %	∞
<b>Test Sample Related</b>						
Device Positioning	3.9	Normal	1	1	± 3.9 %	31
Device Holder	2.7	Normal	1	1	± 2.7 %	19
Power Drift	5.0	Rectangular	√3	1	± 2.9 %	∞
<b>Phantom and Setup</b>						
Phantom Uncertainty	4.0	Rectangular	√3	1	± 2.3 %	∞
Liquid Conductivity (Target)	5.0	Rectangular	√3	0.64	± 1.8 %	∞
Liquid Conductivity (Meas.)	5.0	Normal	1	0.64	± 3.2 %	30
Liquid Permittivity (Target)	5.0	Rectangular	√3	0.6	± 1.7 %	∞
Liquid Permittivity (Meas.)	5.0	Normal	1	0.6	± 3.0 %	30
<b>Combined Standard Uncertainty</b>					± 13.4 %	
<b>Expanded Uncertainty (K=2)</b>					<b>± 26.8 %</b>	

Uncertainty budget for frequency range 3 GHz to 6 GHz



A D T

## **7. Information on the Testing Laboratories**

We, Bureau Veritas Consumer Products Services (H.K.) Ltd., Taoyuan Branch, were founded in 1988 to provide our best service in EMC, Radio, Telecom and Safety consultation. Our laboratories are accredited and approved according to ISO/IEC 17025.

Copies of accreditation and authorization certificates of our laboratories obtained from approval agencies can be downloaded from our web site. If you have any comments, please feel free to contact us at the following:

**Taiwan HwaYa EMC/RF/Safety/Telecom Lab:**

Add: No. 19, Hwa Ya 2nd Rd, Wen Hwa Vil., Kwei Shan Hsiang, Taoyuan Hsien 333, Taiwan, R.O.C.

Tel: 886-3-318-3232

Fax: 886-3-318-5050

**Taiwan LinKo EMC/RF Lab:**

Add: No. 47, 14th Ling, Chia Pau Vil., Linkou Dist., New Taipei City 244, Taiwan, R.O.C.

Tel: 886-2-2605-2180

Fax: 886-2-2605-1924

**Taiwan HsinChu EMC/RF Lab:**

Add: No. 81-1, Lu Liao Keng, 9<sup>th</sup> Ling, Wu Lung Vil., Chiung Lin Township, Hsinchu County 307, Taiwan, R.O.C.

Tel: 886-3-593-5343

Fax: 886-3-593-5342

**Email:** [service.adt@tw.bureauveritas.com](mailto:service.adt@tw.bureauveritas.com)

**Web Site:** [www.adt.com.tw](http://www.adt.com.tw)

The road map of all our labs can be found in our web site also.

---END---





## **Appendix A. SAR Plots of System Verification**

The plots for system verification are shown as follows.

## System Check\_B2450\_111201

**DUT: Dipole 2450 MHz; Type: D2450V2; SN: 716**

Communication System: CW; Frequency: 2450 MHz; Duty Cycle: 1:1

Medium: B2450\_1201 Medium parameters used:  $f = 2450$  MHz;  $\sigma = 1.97$  mho/m;  $\epsilon_r = 51.2$ ;  $\rho = 1000$  kg/m<sup>3</sup>

Ambient Temperature : 22.8 °C ; Liquid Temperature : 21.6 °C

DASY4 Configuration:

- Probe: EX3DV4 - SN3650; ConvF(6.89, 6.89, 6.89); Calibrated: 2011/10/26
- Sensor-Surface: 2mm (Mechanical Surface Detection)
- Electronics: DAE4 Sn1277; Calibrated: 2011/07/29
- Phantom: SAM Phantom\_Left; Type: SAM V4.0; Serial: TP 1652
- Measurement SW: DASY4, V4.7 Build 80; Postprocessing SW: SEMCAD, V1.8 Build 186

**Pin=250mW/Area Scan (61x61x1):** Measurement grid: dx=15mm, dy=15mm

Maximum value of SAR (interpolated) = 21.4 mW/g

**Pin=250mW/Zoom Scan (5x5x7)/Cube 0:** Measurement grid: dx=8mm, dy=8mm, dz=5mm

Reference Value = 103.2 V/m; Power Drift = 0.006 dB

Peak SAR (extrapolated) = 28.1 W/kg

**SAR(1 g) = 13.6 mW/g; SAR(10 g) = 6.28 mW/g**

Maximum value of SAR (measured) = 20.5 mW/g

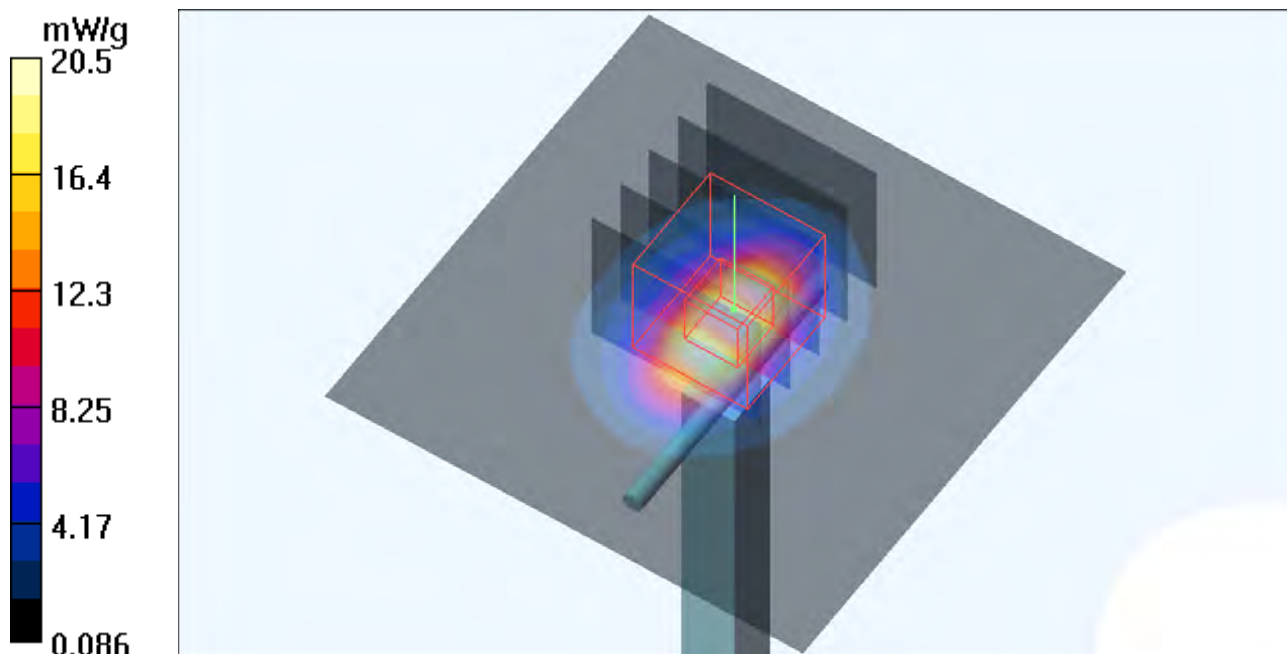

## System Check\_B2450\_120207

**DUT: Dipole 2450 MHz; Type: D2450V2; SN: 716**

Communication System: CW; Frequency: 2450 MHz; Duty Cycle: 1:1

Medium: B2450\_0207 Medium parameters used:  $f = 2450$  MHz;  $\sigma = 1.97$  mho/m;  $\epsilon_r = 50.9$ ;  $\rho = 1000$  kg/m<sup>3</sup>

Ambient Temperature : 21.5 °C; Liquid Temperature : 20.6 °C

DASY4 Configuration:

- Probe: EX3DV4 - SN3650; ConvF(6.89, 6.89, 6.89); Calibrated: 2011/10/26
- Sensor-Surface: 2mm (Mechanical Surface Detection)
- Electronics: DAE3 Sn579; Calibrated: 2011/09/23
- Phantom: SAM Phantom\_Front; Type: SAM V4.0; Serial: TP 1654
- Measurement SW: DASY4, V4.7 Build 80; Postprocessing SW: SEMCAD, V1.8 Build 186

**Pin=250mW/Area Scan (61x61x1):** Measurement grid: dx=15mm, dy=15mm

Maximum value of SAR (interpolated) = 20.7 mW/g

**Pin=250mW/Zoom Scan (5x5x7)/Cube 0:** Measurement grid: dx=8mm, dy=8mm, dz=5mm

Reference Value = 102.0 V/m; Power Drift = 0.034 dB

Peak SAR (extrapolated) = 27.0 W/kg

**SAR(1 g) = 13.1 mW/g; SAR(10 g) = 6.07 mW/g**

Maximum value of SAR (measured) = 19.6 mW/g

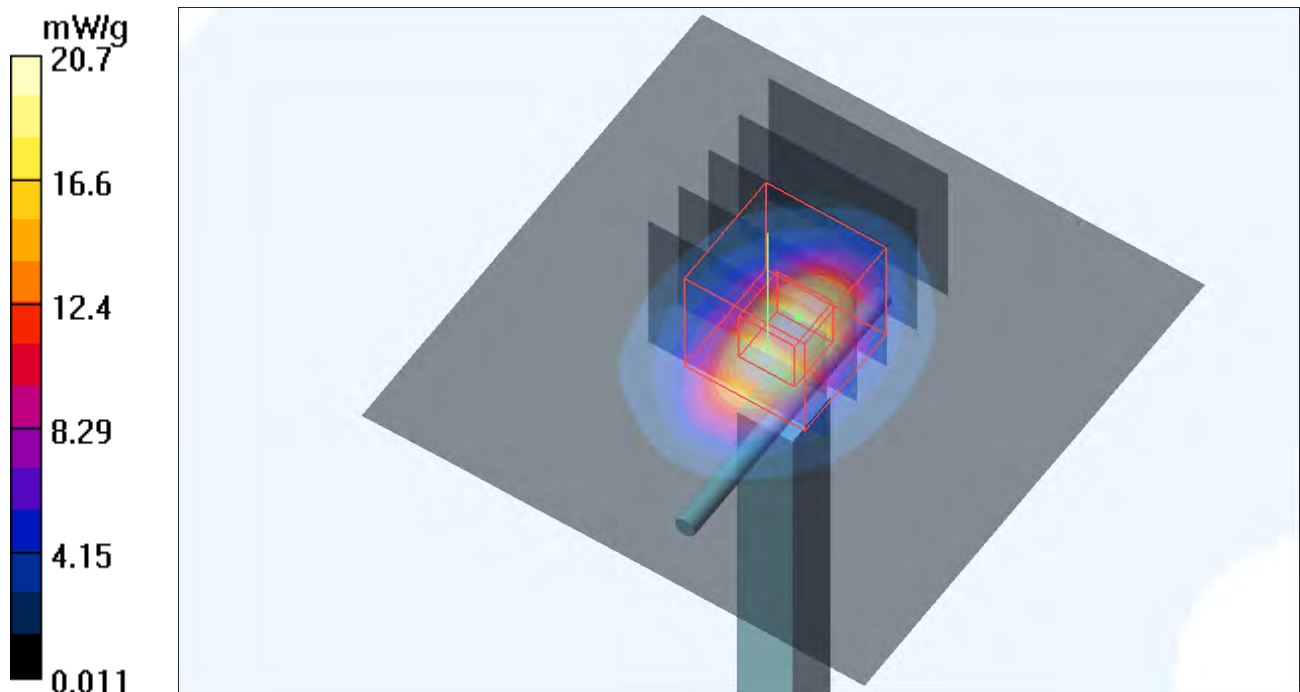

## System Check\_B5200\_111213

**DUT: Dipole 5 GHz; Type: D5GHzV2; SN: 1019**

Communication System: CW; Frequency: 5200 MHz; Duty Cycle: 1:1

Medium: B5G\_1213 Medium parameters used:  $f = 5200$  MHz;  $\sigma = 5.18$  mho/m;  $\epsilon_r = 47.8$ ;  $\rho = 1000$  kg/m<sup>3</sup>

Ambient Temperature : 22.3 °C ; Liquid Temperature : 21.1 °C

DASY4 Configuration:

- Probe: EX3DV4 - SN3650; ConvF(4.28, 4.28, 4.28); Calibrated: 2011/10/26
- Sensor-Surface: 2mm (Mechanical Surface Detection)
- Electronics: DAE4 Sn1277; Calibrated: 2011/07/29
- Phantom: SAM Phantom\_Left; Type: SAM V4.0; Serial: TP 1652
- Measurement SW: DASY4, V4.7 Build 80; Postprocessing SW: SEMCAD, V1.8 Build 186

**Pin=100mW/Area Scan (91x91x1):** Measurement grid: dx=10mm, dy=10mm

Maximum value of SAR (interpolated) = 16.8 mW/g

**Pin=100mW/Zoom Scan (7x7x9)/Cube 0:** Measurement grid: dx=4mm,

dy=4mm, dz=2.5mm

Reference Value = 61.1 V/m; Power Drift = 0.068 dB

Peak SAR (extrapolated) = 29.0 W/kg

**SAR(1 g) = 7.99 mW/g; SAR(10 g) = 2.35 mW/g**

Maximum value of SAR (measured) = 16.6 mW/g

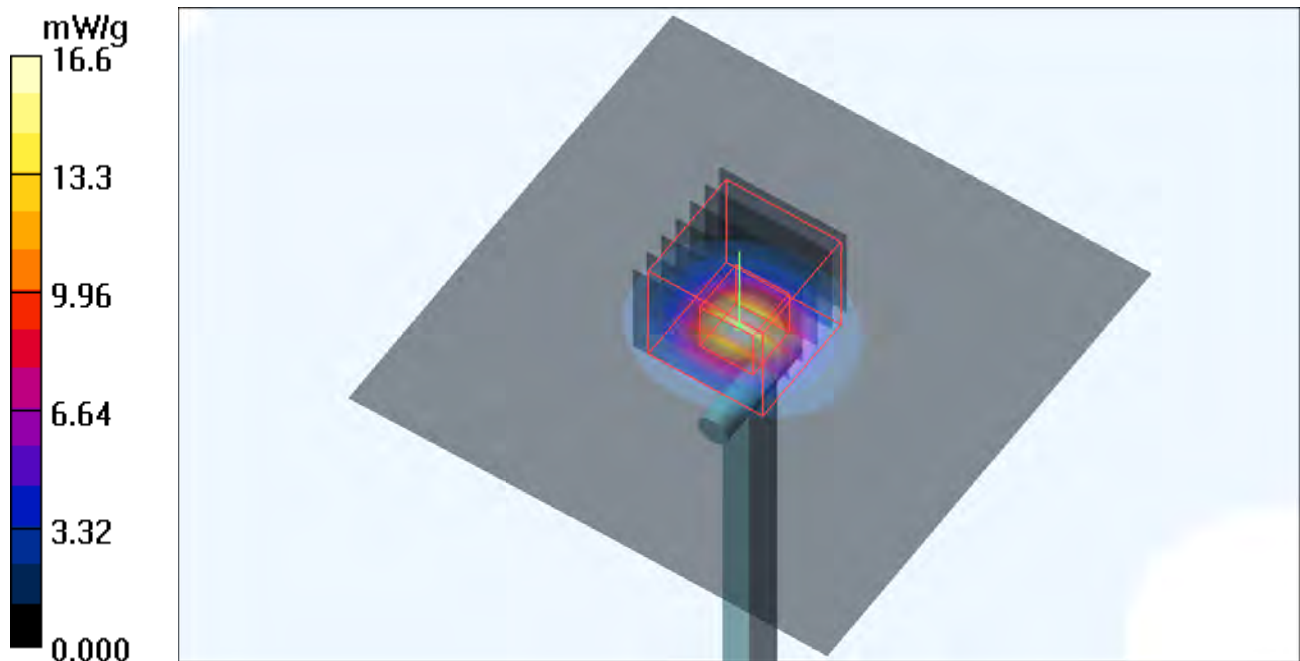

## System Check\_B5200\_111221

**DUT: Dipole 5 GHz; Type: D5GHzV2; SN: 1019**

Communication System: CW; Frequency: 5200 MHz; Duty Cycle: 1:1

Medium: B5G\_1221 Medium parameters used:  $f = 5200$  MHz;  $\sigma = 5.196$  mho/m;  $\epsilon_r = 48.174$ ;  $\rho = 1000$  kg/m<sup>3</sup>

Ambient Temperature : 22.4 °C; Liquid Temperature : 21.4 °C

DASY5 Configuration:

- Probe: EX3DV4 - SN3650; ConvF(4.28, 4.28, 4.28); Calibrated: 2011/10/26
- Sensor-Surface: 2mm (Mechanical Surface Detection)
- Electronics: DAE4 Sn1277; Calibrated: 2011/07/29
- Phantom: SAM Phantom\_Front; Type: SAM; Serial: TP-1485
- Measurement SW: DASY52, Version 52.6 (2); SEMCAD X Version 14.4.5 (3634)

**Pin=100mW/Area Scan (91x91x1):** Measurement grid: dx=10mm, dy=10mm  
Maximum value of SAR (interpolated) = 15.755 mW/g

**Pin=100mW/Zoom Scan (7x7x9)/Cube 0:** Measurement grid: dx=4mm, dy=4mm, dz=2.5mm

Reference Value = 59.540 V/m; Power Drift = 0.08 dB

Peak SAR (extrapolated) = 27.032 W/kg

**SAR(1 g) = 7.53 mW/g; SAR(10 g) = 2.23 mW/g**

Maximum value of SAR (measured) = 15.604 mW/g

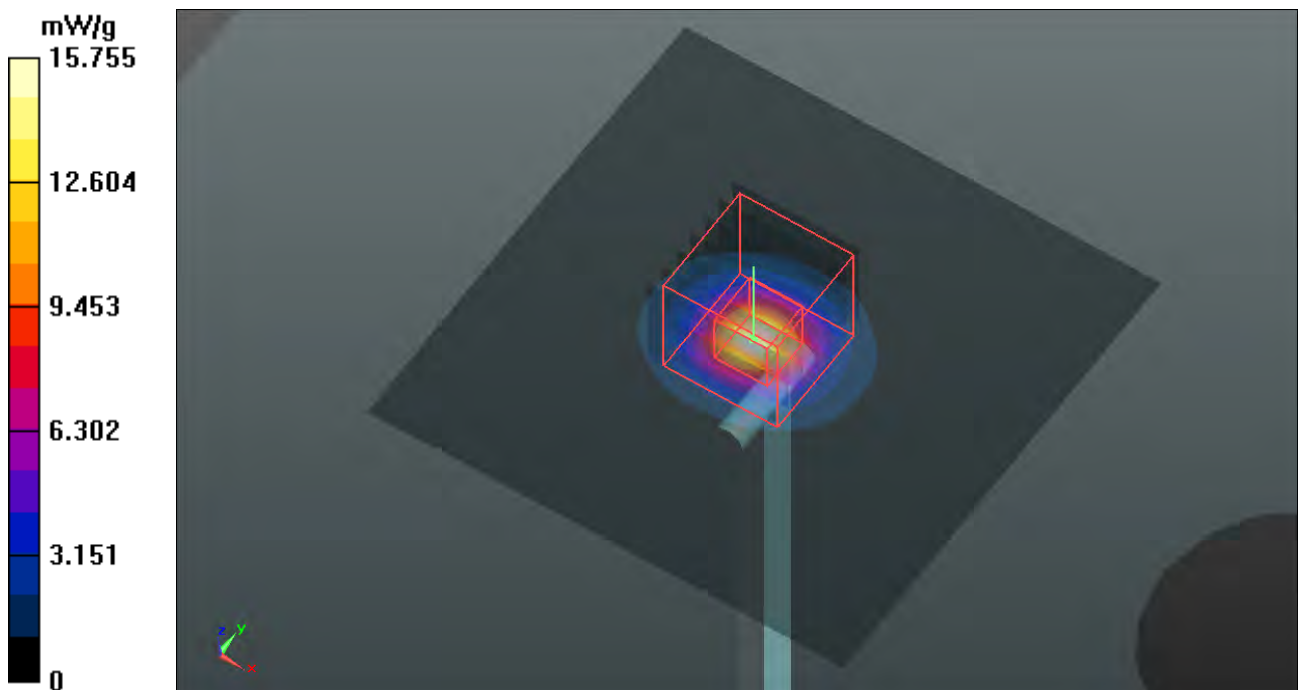

## System Check\_B5200\_120206

**DUT: Dipole 5 GHz; Type: D5GHzV2; SN: 1019**

Communication System: CW; Frequency: 5200 MHz; Duty Cycle: 1:1

Medium: B5G\_0206 Medium parameters used:  $f = 5200$  MHz;  $\sigma = 5.17$  mho/m;  $\epsilon_r = 47.5$ ;  $\rho = 1000$  kg/m<sup>3</sup>

Ambient Temperature : 21.7 °C ; Liquid Temperature : 20.7 °C

DASY4 Configuration:

- Probe: EX3DV4 - SN3650; ConvF(4.28, 4.28, 4.28); Calibrated: 2011/10/26
- Sensor-Surface: 2mm (Mechanical Surface Detection)
- Electronics: DAE3 Sn579; Calibrated: 2011/09/23
- Phantom: SAM Phantom\_Left; Type: SAM V4.0; Serial: TP 1652
- Measurement SW: DASY4, V4.7 Build 80; Postprocessing SW: SEMCAD, V1.8 Build 186

**Pin=100mW, f=5200 MHz/Area Scan (91x91x1):** Measurement grid: dx=10mm, dy=10mm  
Maximum value of SAR (interpolated) = 16.8 mW/g

**Pin=100mW, f=5200 MHz/Zoom Scan (7x7x9)/Cube 0:** Measurement grid: dx=4mm, dy=4mm, dz=2.5mm

Reference Value = 61.1 V/m; Power Drift = 0.068 dB

Peak SAR (extrapolated) = 28.7 W/kg

**SAR(1 g) = 7.98 mW/g; SAR(10 g) = 2.35 mW/g**

Maximum value of SAR (measured) = 16.5 mW/g

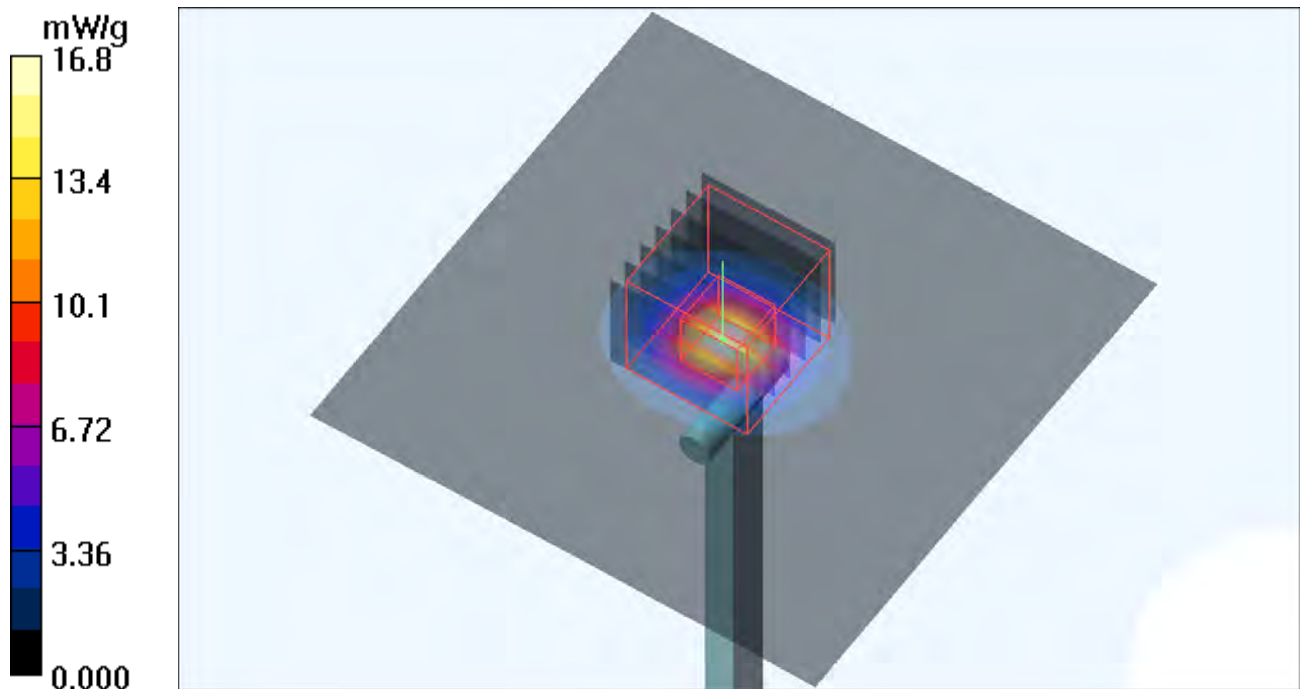

## System Check\_B5500\_111213

**DUT: Dipole 5 GHz; Type: D5GHzV2; SN: 1019**

Communication System: CW; Frequency: 5500 MHz; Duty Cycle: 1:1

Medium: B5G\_1213 Medium parameters used:  $f = 5500$  MHz;  $\sigma = 5.68$  mho/m;  $\epsilon_r = 47.8$ ;  $\rho = 1000$  kg/m<sup>3</sup>

Ambient Temperature : 22.3 °C; Liquid Temperature : 21.1 °C

DASY4 Configuration:

- Probe: EX3DV4 - SN3650; ConvF(3.73, 3.73, 3.73); Calibrated: 2011/10/26
- Sensor-Surface: 2mm (Mechanical Surface Detection)
- Electronics: DAE4 Sn1277; Calibrated: 2011/07/29
- Phantom: SAM Phantom\_Left; Type: SAM V4.0; Serial: TP 1652
- Measurement SW: DASY4, V4.7 Build 80; Postprocessing SW: SEMCAD, V1.8 Build 186

**Pin=100mW/Area Scan (91x91x1):** Measurement grid: dx=10mm, dy=10mm

Maximum value of SAR (interpolated) = 18.2 mW/g

**Pin=100mW/Zoom Scan (7x7x9)/Cube 0:** Measurement grid: dx=4mm, dy=4mm, dz=2.5mm

Reference Value = 61.9 V/m; Power Drift = 0.026 dB

Peak SAR (extrapolated) = 30.2 W/kg

**SAR(1 g) = 8.32 mW/g; SAR(10 g) = 2.41 mW/g**

Maximum value of SAR (measured) = 17.7 mW/g

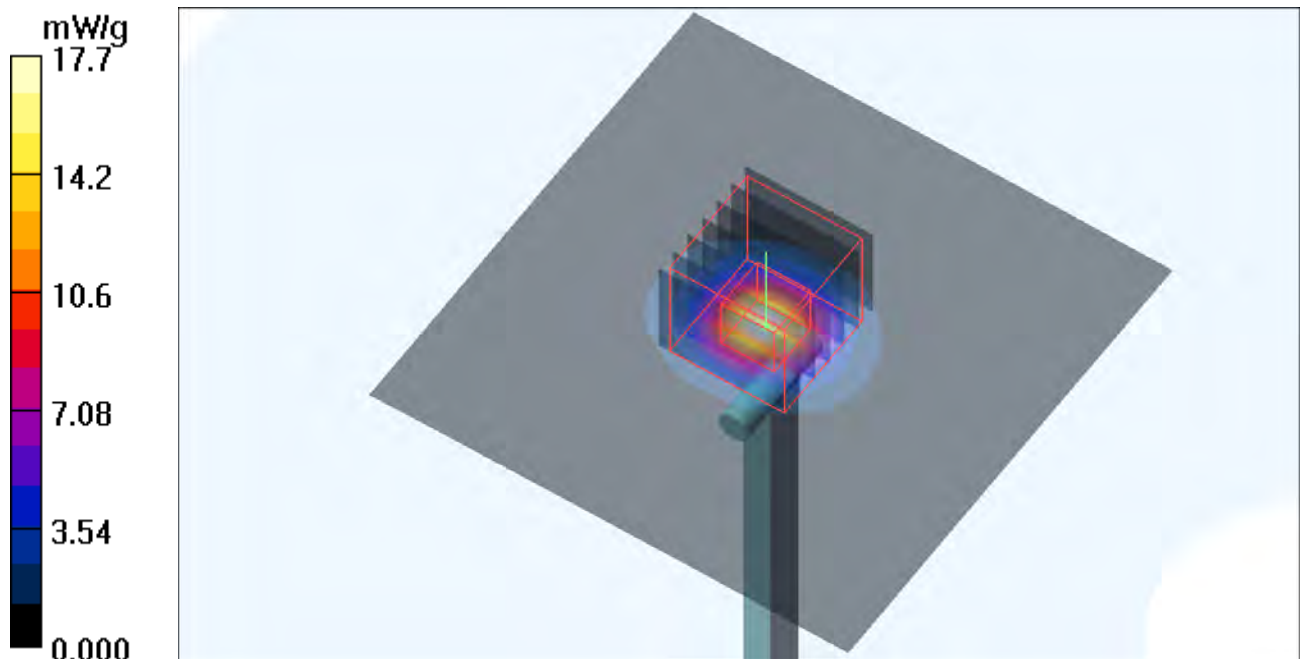



## System Check\_B5500\_111221

**DUT: Dipole 5 GHz; Type: D5GHzV2; SN: 1019**

Communication System: CW; Frequency: 5500 MHz; Duty Cycle: 1:1

Medium: B5G\_1221 Medium parameters used:  $f = 5500$  MHz;  $\sigma = 5.699$  mho/m;  $\epsilon_r = 48.07$ ;  $\rho = 1000$  kg/m<sup>3</sup>

Ambient Temperature : 22.5 °C ; Liquid Temperature : 21.4 °C

DASY5 Configuration:

- Probe: EX3DV4 - SN3650; ConvF(3.73, 3.73, 3.73); Calibrated: 2011/10/26
- Sensor-Surface: 2mm (Mechanical Surface Detection)
- Electronics: DAE4 Sn1277; Calibrated: 2011/07/29
- Phantom: SAM Phantom\_Front; Type: SAM; Serial: TP-1485
- Measurement SW: DASY52, Version 52.6 (2); SEMCAD X Version 14.4.5 (3634)

**Pin=100mW/Area Scan (91x91x1):** Measurement grid: dx=10mm, dy=10mm  
Maximum value of SAR (interpolated) = 17.557 mW/g

**Pin=100mW/Zoom Scan (7x7x9)/Cube 0:** Measurement grid: dx=4mm, dy=4mm, dz=2.5mm

Reference Value = 60.697 V/m; Power Drift = 0.03 dB

Peak SAR (extrapolated) = 28.963 W/kg

**SAR(1 g) = 8.04 mW/g; SAR(10 g) = 2.33 mW/g**

Maximum value of SAR (measured) = 16.847 mW/g

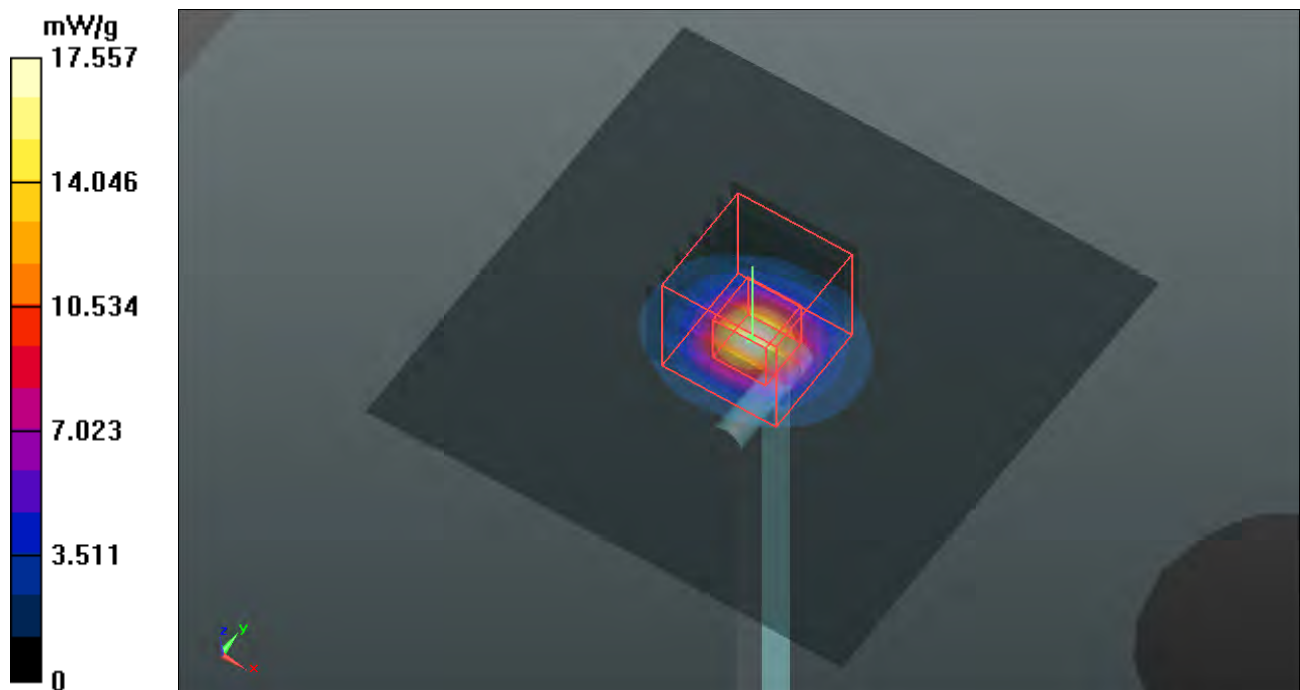



## System Check\_B5500\_120206

**DUT: Dipole 5 GHz; Type: D5GHzV2; SN: 1019**

Communication System: CW; Frequency: 5500 MHz; Duty Cycle: 1:1

Medium: B5G\_0206 Medium parameters used:  $f = 5500$  MHz;  $\sigma = 5.66$  mho/m;  $\epsilon_r = 47.4$ ;  $\rho = 1000$  kg/m<sup>3</sup>

Ambient Temperature : 21.7 °C ; Liquid Temperature : 20.7 °C

DASY4 Configuration:

- Probe: EX3DV4 - SN3650; ConvF(3.73, 3.73, 3.73); Calibrated: 2011/10/26
- Sensor-Surface: 2mm (Mechanical Surface Detection)
- Electronics: DAE3 Sn579; Calibrated: 2011/09/23
- Phantom: SAM Phantom\_Left; Type: SAM V4.0; Serial: TP 1652
- Measurement SW: DASY4, V4.7 Build 80; Postprocessing SW: SEMCAD, V1.8 Build 186

**Pin=100mW, f=5500 MHz/Area Scan (91x91x1):** Measurement grid: dx=10mm, dy=10mm  
Maximum value of SAR (interpolated) = 18.2 mW/g

**Pin=100mW, f=5500 MHz/Zoom Scan (7x7x9)/Cube 0:** Measurement grid: dx=4mm, dy=4mm, dz=2.5mm

Reference Value = 61.9 V/m; Power Drift = 0.026 dB

Peak SAR (extrapolated) = 29.9 W/kg

**SAR(1 g) = 8.31 mW/g; SAR(10 g) = 2.41 mW/g**

Maximum value of SAR (measured) = 17.6 mW/g

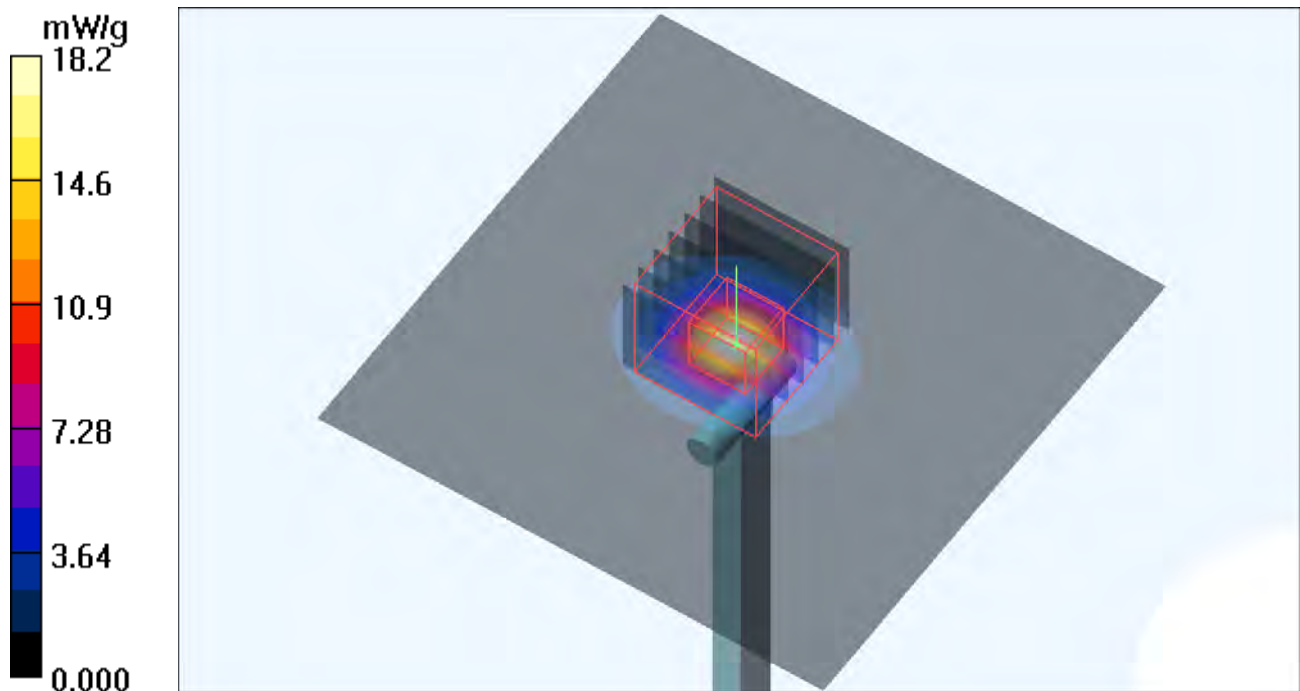

## System Check\_B5800\_111206

**DUT: Dipole 5 GHz; Type: D5GHzV2; SN: 1019**

Communication System: CW; Frequency: 5800 MHz; Duty Cycle: 1:1

Medium: B5G\_1206 Medium parameters used:  $f = 5800$  MHz;  $\sigma = 6.25$  mho/m;  $\epsilon_r = 46.7$ ;  $\rho = 1000$  kg/m<sup>3</sup>

Ambient Temperature : 22.4 °C ; Liquid Temperature : 21.3 °C

DASY4 Configuration:

- Probe: EX3DV4 - SN3650; ConvF(3.81, 3.81, 3.81); Calibrated: 2011/10/26
- Sensor-Surface: 2mm (Mechanical Surface Detection)
- Electronics: DAE4 Sn1277; Calibrated: 2011/07/29
- Phantom: Flat Phantom ELI4.0; Type: QDOVA001BA; Serial: SN:1039
- Measurement SW: DASY4, V4.7 Build 80; Postprocessing SW: SEMCAD, V1.8 Build 186

**Pin=100mW/Area Scan (91x91x1):** Measurement grid: dx=10mm, dy=10mm

Maximum value of SAR (interpolated) = 16.7 mW/g

**Pin=100mW/Zoom Scan (7x7x9)/Cube 0:** Measurement grid: dx=4mm,

dy=4mm, dz=2.5mm

Reference Value = 57.6 V/m; Power Drift = 0.021 dB

Peak SAR (extrapolated) = 30.0 W/kg

**SAR(1 g) = 7.85 mW/g; SAR(10 g) = 2.28 mW/g**

Maximum value of SAR (measured) = 16.6 mW/g

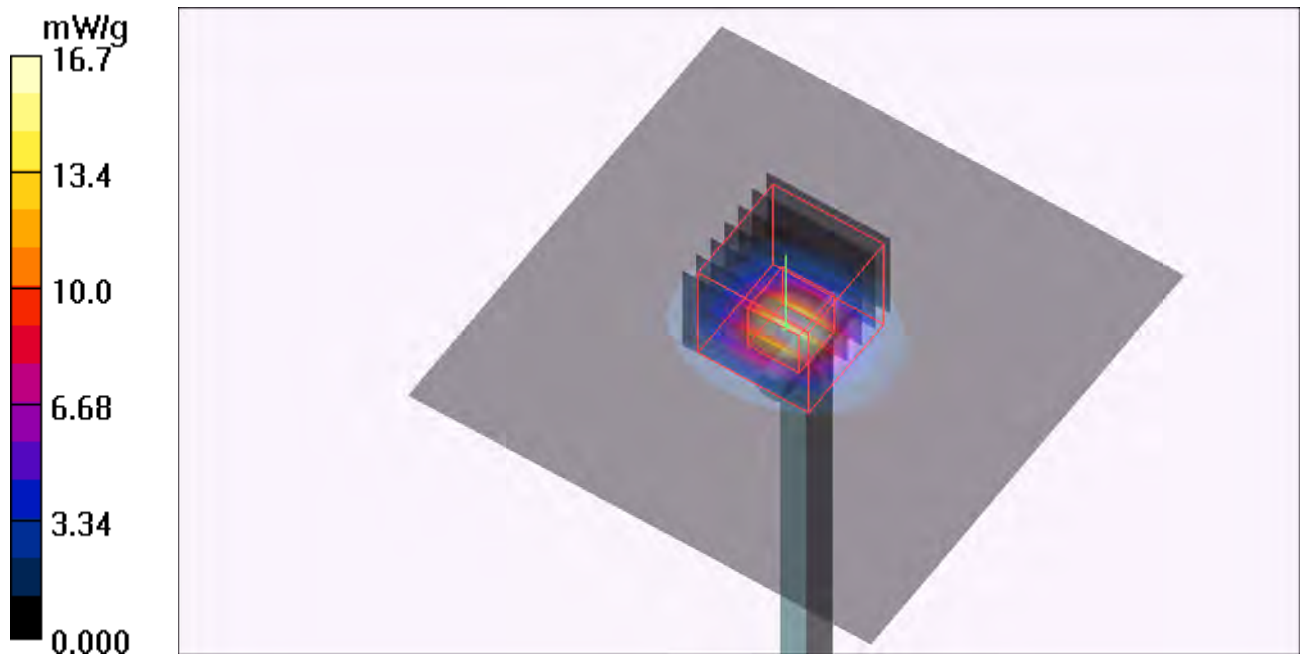

## System Check\_B5800\_111213

**DUT: Dipole 5 GHz; Type: D5GHzV2; SN: 1019**

Communication System: CW; Frequency: 5800 MHz; Duty Cycle: 1:1

Medium: B5G\_1213 Medium parameters used:  $f = 5800$  MHz;  $\sigma = 6.26$  mho/m;  $\epsilon_r = 47.1$ ;  $\rho = 1000$  kg/m<sup>3</sup>

Ambient Temperature : 22.3 °C; Liquid Temperature : 21.1 °C

DASY4 Configuration:

- Probe: EX3DV4 - SN3650; ConvF(3.81, 3.81, 3.81); Calibrated: 2011/10/26
- Sensor-Surface: 2mm (Mechanical Surface Detection)
- Electronics: DAE4 Sn1277; Calibrated: 2011/07/29
- Phantom: SAM Phantom\_Left; Type: SAM V4.0; Serial: TP 1652
- Measurement SW: DASY4, V4.7 Build 80; Postprocessing SW: SEMCAD, V1.8 Build 186

**Pin=100mW/Area Scan (91x91x1):** Measurement grid: dx=10mm, dy=10mm

Maximum value of SAR (interpolated) = 15.8 mW/g

**Pin=100mW/Zoom Scan (7x7x9)/Cube 0:** Measurement grid: dx=4mm, dy=4mm, dz=2.5mm

Reference Value = 55.9 V/m; Power Drift = 0.047 dB

Peak SAR (extrapolated) = 28.2 W/kg

**SAR(1 g) = 7.39 mW/g; SAR(10 g) = 2.15 mW/g**

Maximum value of SAR (measured) = 15.7 mW/g

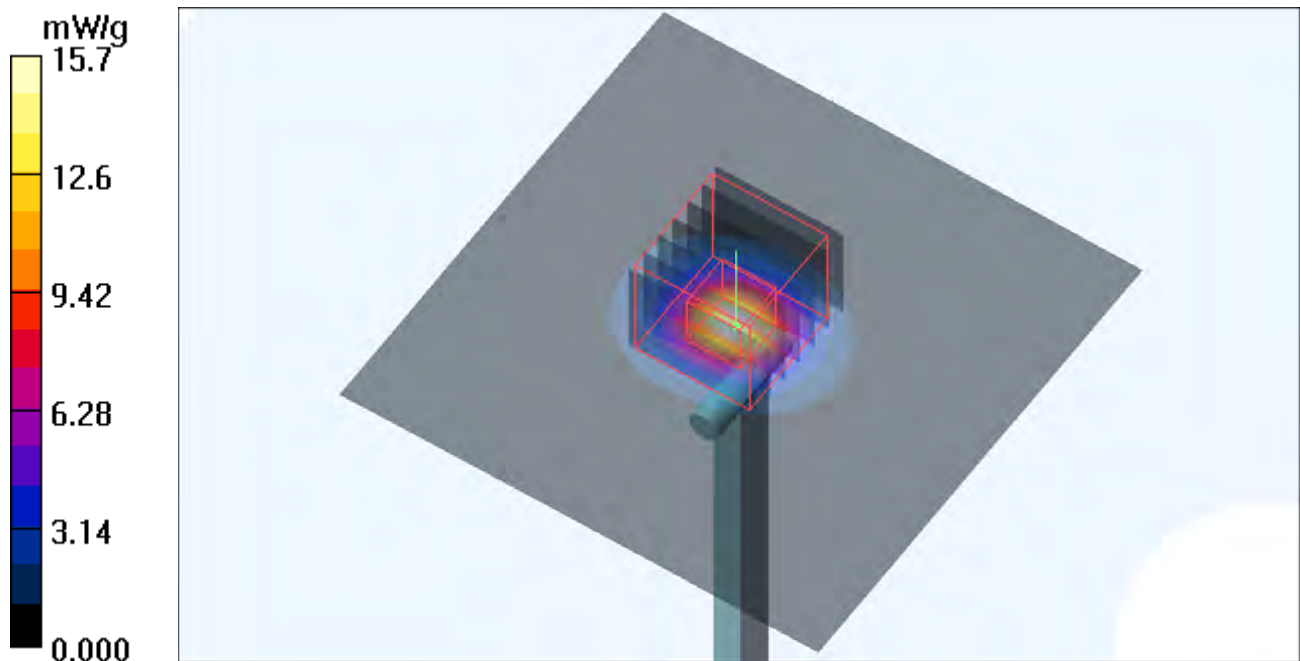

## System Check\_B5800\_120206

**DUT: Dipole 5 GHz; Type: D5GHzV2; SN: 1019**

Communication System: CW; Frequency: 5800 MHz; Duty Cycle: 1:1

Medium: B5G\_0206 Medium parameters used:  $f = 5800$  MHz;  $\sigma = 6.25$  mho/m;  $\epsilon_r = 46.7$ ;  $\rho = 1000$  kg/m<sup>3</sup>

Ambient Temperature : 21.7 °C; Liquid Temperature : 20.7 °C

DASY4 Configuration:

- Probe: EX3DV4 - SN3650; ConvF(3.81, 3.81, 3.81); Calibrated: 2011/10/26
- Sensor-Surface: 2mm (Mechanical Surface Detection)
- Electronics: DAE3 Sn579; Calibrated: 2011/09/23
- Phantom: SAM Phantom\_Left; Type: SAM V4.0; Serial: TP 1652
- Measurement SW: DASY4, V4.7 Build 80; Postprocessing SW: SEMCAD, V1.8 Build 186

**Pin=100mW, f=5800 MHz/Area Scan (91x91x1):** Measurement grid: dx=10mm, dy=10mm  
Maximum value of SAR (interpolated) = 15.9 mW/g

**Pin=100mW, f=5800 MHz/Zoom Scan (7x7x9)/Cube 0:** Measurement grid: dx=4mm, dy=4mm, dz=2.5mm

Reference Value = 55.9 V/m; Power Drift = 0.047 dB

Peak SAR (extrapolated) = 28.1 W/kg

**SAR(1 g) = 7.4 mW/g; SAR(10 g) = 2.16 mW/g**

Maximum value of SAR (measured) = 15.6 mW/g

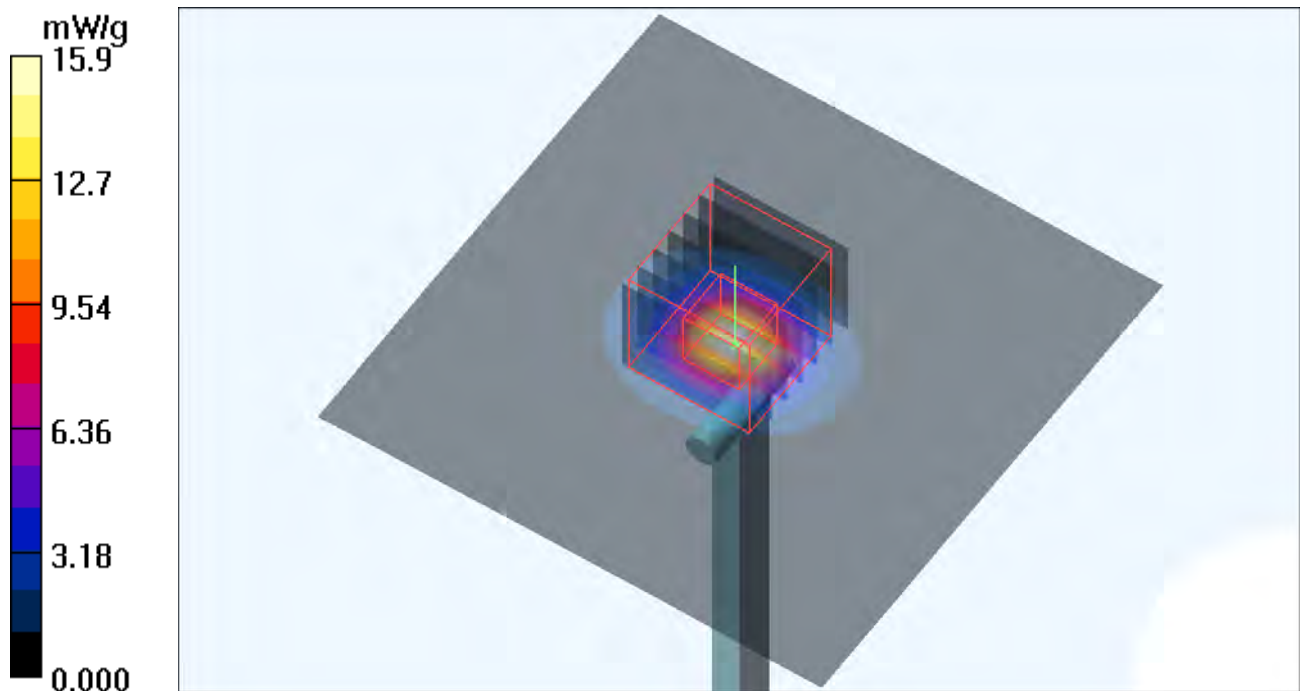



A D T

## **Appendix B. SAR Plots of SAR Measurement**

The plots for SAR measurement are shown as follows.

## P01 802.11b\_Horizontal Up\_0.5cm\_Ch06\_ANT 0

**DUT: 111122C09**

Communication System: 802.11b; Frequency: 2437 MHz; Duty Cycle: 1:1

Medium: B2450\_1201 Medium parameters used:  $f = 2437$  MHz;  $\sigma = 1.96$  mho/m;  $\epsilon_r = 51.3$ ;  $\rho = 1000$  kg/m<sup>3</sup>

Ambient Temperature : 22.8 °C ; Liquid Temperature : 21.6 °C

DASY4 Configuration:

- Probe: EX3DV4 - SN3650; ConvF(6.89, 6.89, 6.89); Calibrated: 2011/10/26
- Sensor-Surface: 2mm (Mechanical Surface Detection)
- Electronics: DAE4 Sn1277; Calibrated: 2011/07/29
- Phantom: SAM Phantom\_Left; Type: SAM V4.0; Serial: TP 1652
- Measurement SW: DASY4, V4.7 Build 80; Postprocessing SW: SEMCAD, V1.8 Build 186

**Ch06/Area Scan (81x31x1):** Measurement grid: dx=20mm, dy=20mm

Maximum value of SAR (interpolated) = 0.194 mW/g

**Ch06/Zoom Scan (5x5x7)/Cube 0:** Measurement grid: dx=8mm, dy=8mm, dz=5mm

Reference Value = 3.79 V/m; Power Drift = -0.041 dB

Peak SAR (extrapolated) = 0.276 W/kg

**SAR(1 g) = 0.119 mW/g; SAR(10 g) = 0.053 mW/g**

Maximum value of SAR (measured) = 0.196 mW/g

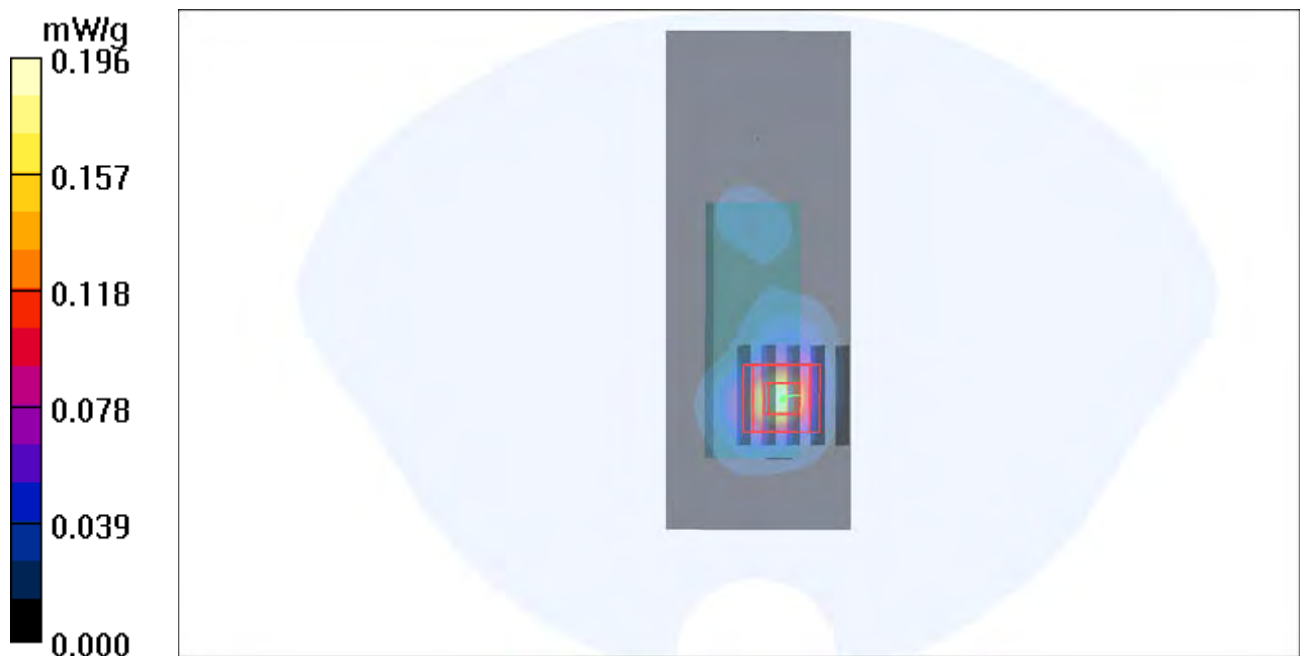

## P02 802.11b\_Horizontal Down\_0.5cm\_Ch06\_ANT 0

**DUT: 111122C09**

Communication System: 802.11b; Frequency: 2437 MHz; Duty Cycle: 1:1

Medium: B2450\_1201 Medium parameters used:  $f = 2437$  MHz;  $\sigma = 1.96$  mho/m;  $\epsilon_r = 51.3$ ;  $\rho = 1000$  kg/m<sup>3</sup>

Ambient Temperature : 22.8 °C ; Liquid Temperature : 21.6 °C

DASY4 Configuration:

- Probe: EX3DV4 - SN3650; ConvF(6.89, 6.89, 6.89); Calibrated: 2011/10/26
- Sensor-Surface: 2mm (Mechanical Surface Detection)
- Electronics: DAE4 Sn1277; Calibrated: 2011/07/29
- Phantom: SAM Phantom\_Left; Type: SAM V4.0; Serial: TP 1652
- Measurement SW: DASY4, V4.7 Build 80; Postprocessing SW: SEMCAD, V1.8 Build 186

**Ch06/Area Scan (81x31x1):** Measurement grid: dx=20mm, dy=20mm

Maximum value of SAR (interpolated) = 0.174 mW/g

**Ch06/Zoom Scan (5x5x7)/Cube 0:** Measurement grid: dx=8mm, dy=8mm, dz=5mm

Reference Value = 6.23 V/m; Power Drift = -0.179 dB

Peak SAR (extrapolated) = 0.229 W/kg

**SAR(1 g) = 0.108 mW/g; SAR(10 g) = 0.051 mW/g**

Maximum value of SAR (measured) = 0.158 mW/g

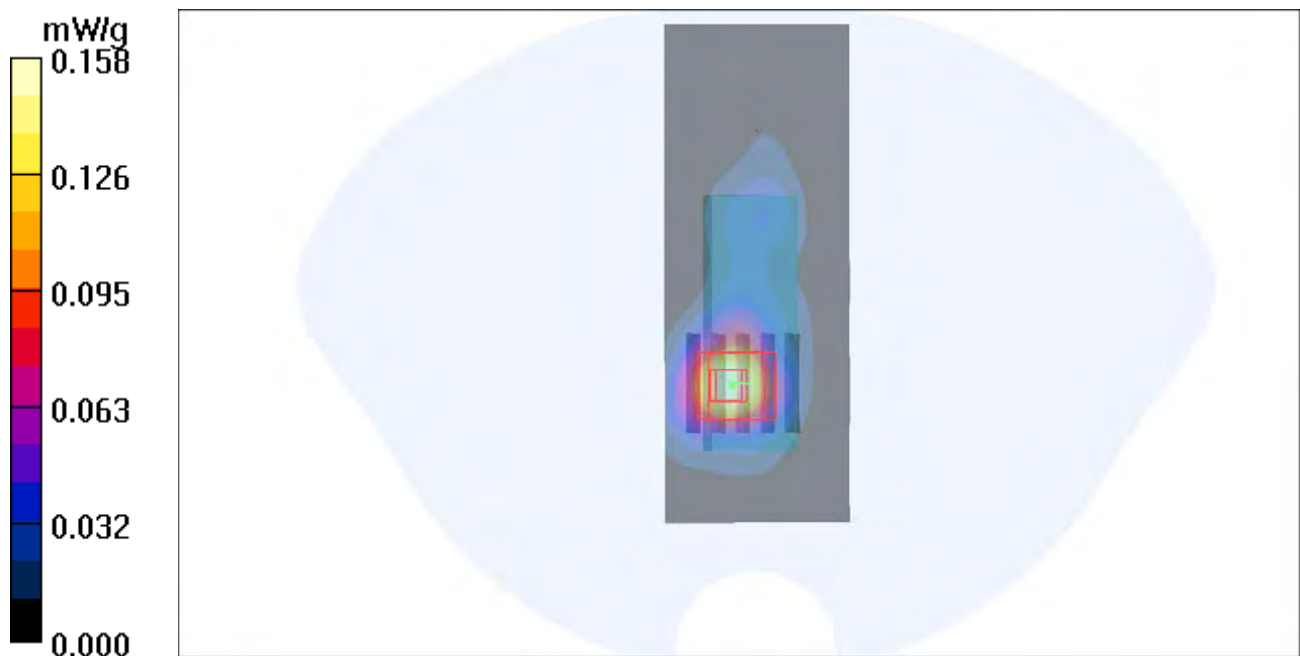

### P03 802.11b\_Verical Front\_0.5cm\_Ch06\_ANT 0

**DUT: 111122C09**

Communication System: 802.11b; Frequency: 2437 MHz; Duty Cycle: 1:1

Medium: B2450\_1201 Medium parameters used:  $f = 2437$  MHz;  $\sigma = 1.96$  mho/m;  $\epsilon_r = 51.3$ ;  $\rho = 1000$  kg/m<sup>3</sup>

Ambient Temperature : 22.8 °C ; Liquid Temperature : 21.6 °C

DASY4 Configuration:

- Probe: EX3DV4 - SN3650; ConvF(6.89, 6.89, 6.89); Calibrated: 2011/10/26
- Sensor-Surface: 2mm (Mechanical Surface Detection)
- Electronics: DAE4 Sn1277; Calibrated: 2011/07/29
- Phantom: SAM Phantom\_Left; Type: SAM V4.0; Serial: TP 1652
- Measurement SW: DASY4, V4.7 Build 80; Postprocessing SW: SEMCAD, V1.8 Build 186

**Ch06/Area Scan (31x111x1):** Measurement grid: dx=20mm, dy=20mm

Maximum value of SAR (interpolated) = 0.110 mW/g

**Ch06/Zoom Scan (5x5x7)/Cube 0:** Measurement grid: dx=8mm, dy=8mm, dz=5mm

Reference Value = 6.78 V/m; Power Drift = -0.075 dB

Peak SAR (extrapolated) = 0.302 W/kg

**SAR(1 g) = 0.134 mW/g; SAR(10 g) = 0.058 mW/g**

Maximum value of SAR (measured) = 0.219 mW/g

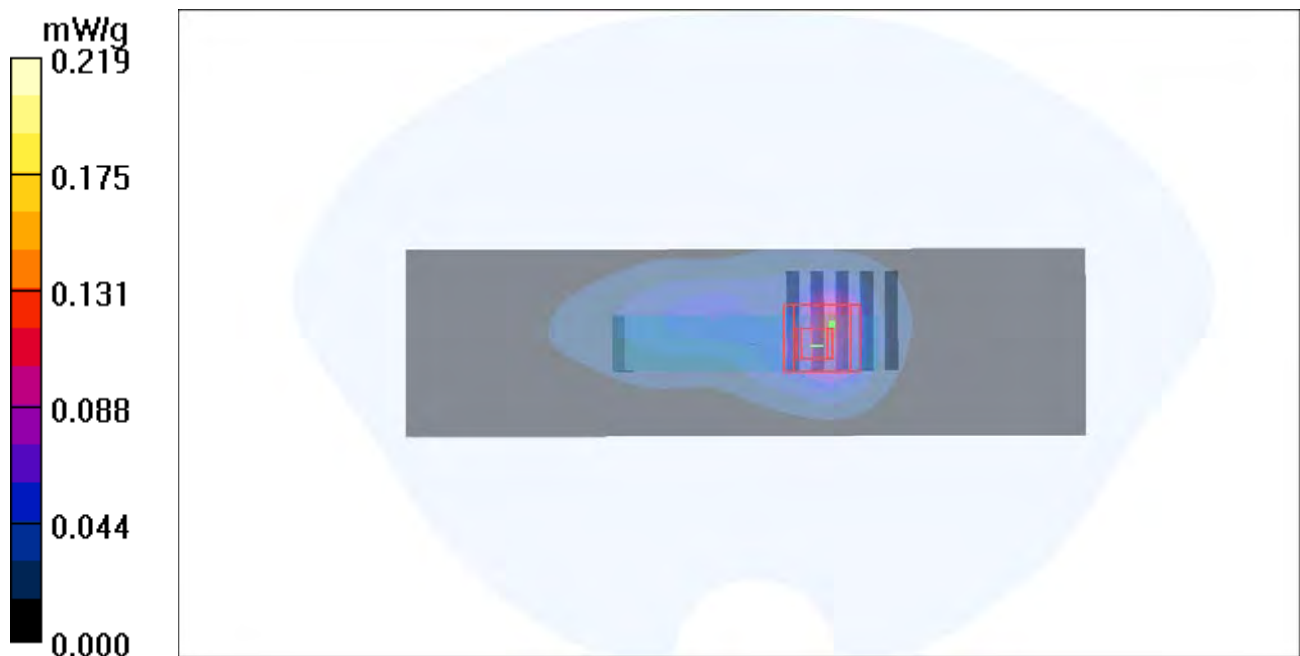



## P04 802.11b\_Verical Back\_0.5cm\_Ch06\_ANT 0

**DUT: 111122C09**

Communication System: 802.11b; Frequency: 2437 MHz; Duty Cycle: 1:1

Medium: B2450\_1201 Medium parameters used:  $f = 2437$  MHz;  $\sigma = 1.96$  mho/m;  $\epsilon_r = 51.3$ ;  $\rho = 1000$  kg/m<sup>3</sup>

Ambient Temperature : 22.8 °C ; Liquid Temperature : 21.6 °C

DASY4 Configuration:

- Probe: EX3DV4 - SN3650; ConvF(6.89, 6.89, 6.89); Calibrated: 2011/10/26
- Sensor-Surface: 2mm (Mechanical Surface Detection)
- Electronics: DAE4 Sn1277; Calibrated: 2011/07/29
- Phantom: SAM Phantom\_Left; Type: SAM V4.0; Serial: TP 1652
- Measurement SW: DASY4, V4.7 Build 80; Postprocessing SW: SEMCAD, V1.8 Build 186

**Ch06/Area Scan (41x111x1):** Measurement grid: dx=20mm, dy=20mm

Maximum value of SAR (interpolated) = 0.018 mW/g

**Ch06/Zoom Scan (5x5x7)/Cube 0:** Measurement grid: dx=8mm, dy=8mm, dz=5mm

Reference Value = 0.000 V/m; Power Drift = 0.110 dB

Peak SAR (extrapolated) = 0.024 W/kg

**SAR(1 g) = 0.00646 mW/g; SAR(10 g) = 0.00276 mW/g**

Maximum value of SAR (measured) = 0.010 mW/g

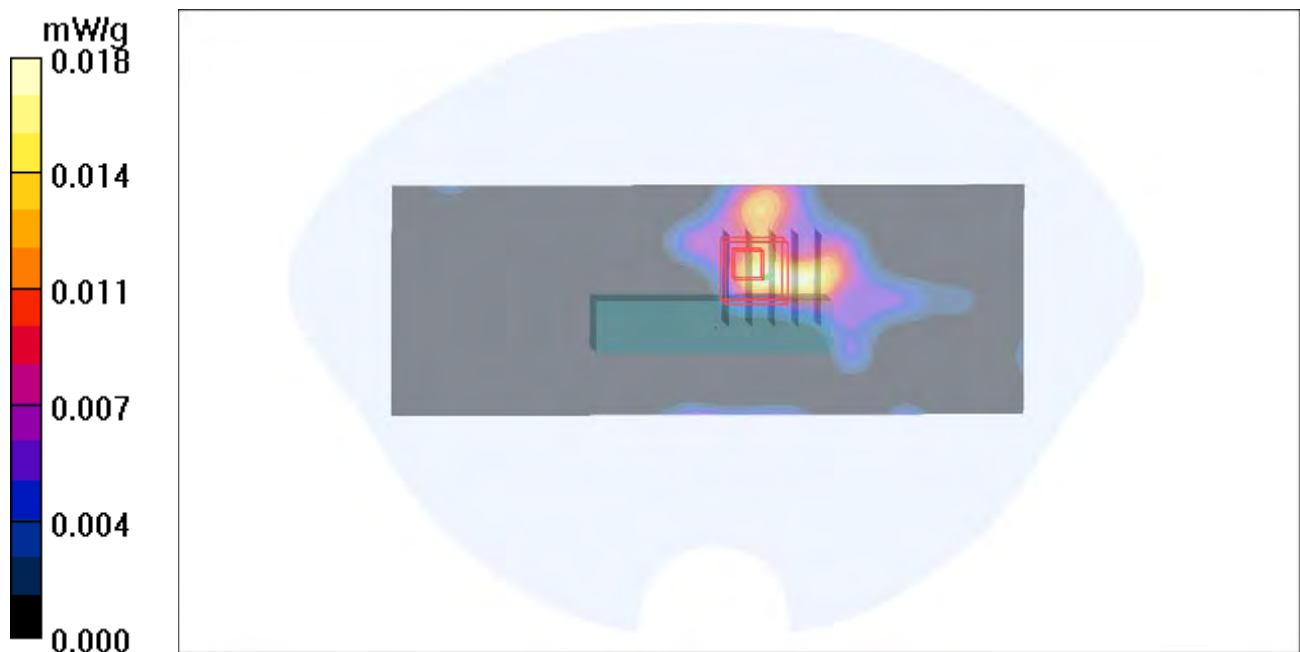

## P05 802.11b\_Tip\_0.5cm\_Ch06\_ANT 0

**DUT: 111122C09**

Communication System: 802.11b; Frequency: 2437 MHz; Duty Cycle: 1:1

Medium: B2450\_1201 Medium parameters used:  $f = 2437$  MHz;  $\sigma = 1.96$  mho/m;  $\epsilon_r = 51.3$ ;  $\rho = 1000$  kg/m<sup>3</sup>

Ambient Temperature : 22.8 °C ; Liquid Temperature : 21.6 °C

DASY4 Configuration:

- Probe: EX3DV4 - SN3650; ConvF(6.89, 6.89, 6.89); Calibrated: 2011/10/26
- Sensor-Surface: 2mm (Mechanical Surface Detection)
- Electronics: DAE4 Sn1277; Calibrated: 2011/07/29
- Phantom: SAM Phantom\_Left; Type: SAM V4.0; Serial: TP 1652
- Measurement SW: DASY4, V4.7 Build 80; Postprocessing SW: SEMCAD, V1.8 Build 186

**Ch06/Area Scan (31x61x1):** Measurement grid: dx=20mm, dy=20mm

Maximum value of SAR (interpolated) = 0.030 mW/g

**Ch06/Zoom Scan (5x5x7)/Cube 0:** Measurement grid: dx=8mm, dy=8mm, dz=5mm

Reference Value = 2.91 V/m; Power Drift = 0.094 dB

Peak SAR (extrapolated) = 0.063 W/kg

**SAR(1 g) = 0.017 mW/g; SAR(10 g) = 0.00912 mW/g**

Maximum value of SAR (measured) = 0.025 mW/g

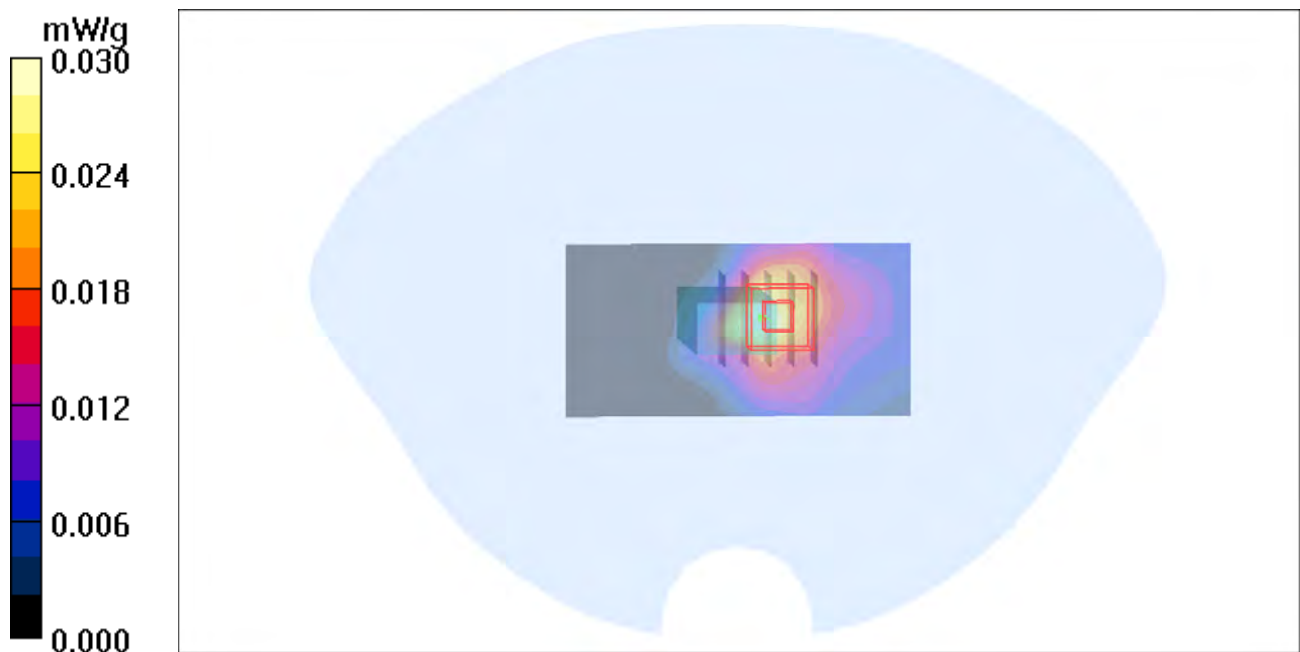

## P101 802.11n\_HT20\_Horizontal Up\_0.5cm\_Ch6\_ANT 0+1+2

**DUT: 111122C09**

Communication System: 802.11n\_20MHz; Frequency: 2437 MHz; Duty Cycle: 1:1

Medium: B2450\_0207 Medium parameters used:  $f = 2437$  MHz;  $\sigma = 1.95$  mho/m;  $\epsilon_r = 51$ ;  $\rho = 1000$  kg/m<sup>3</sup>

Ambient Temperature : 21.5 °C; Liquid Temperature : 20.6 °C

DASY4 Configuration:

- Probe: EX3DV4 - SN3650; ConvF(6.89, 6.89, 6.89); Calibrated: 2011/10/26
- Sensor-Surface: 2mm (Mechanical Surface Detection)
- Electronics: DAE3 Sn579; Calibrated: 2011/09/23
- Phantom: SAM Phantom\_Front; Type: SAM V4.0; Serial: TP 1654
- Measurement SW: DASY4, V4.7 Build 80; Postprocessing SW: SEMCAD, V1.8 Build 186

**Ch6/Area Scan (61x31x1):** Measurement grid: dx=20mm, dy=20mm

Maximum value of SAR (interpolated) = 0.315 mW/g

**Ch6/Zoom Scan (5x5x7)/Cube 0:** Measurement grid: dx=8mm, dy=8mm, dz=5mm

Reference Value = 6.18 V/m; Power Drift = 0.108 dB

Peak SAR (extrapolated) = 0.366 W/kg

**SAR(1 g) = 0.188 mW/g; SAR(10 g) = 0.096 mW/g**

Maximum value of SAR (measured) = 0.250 mW/g

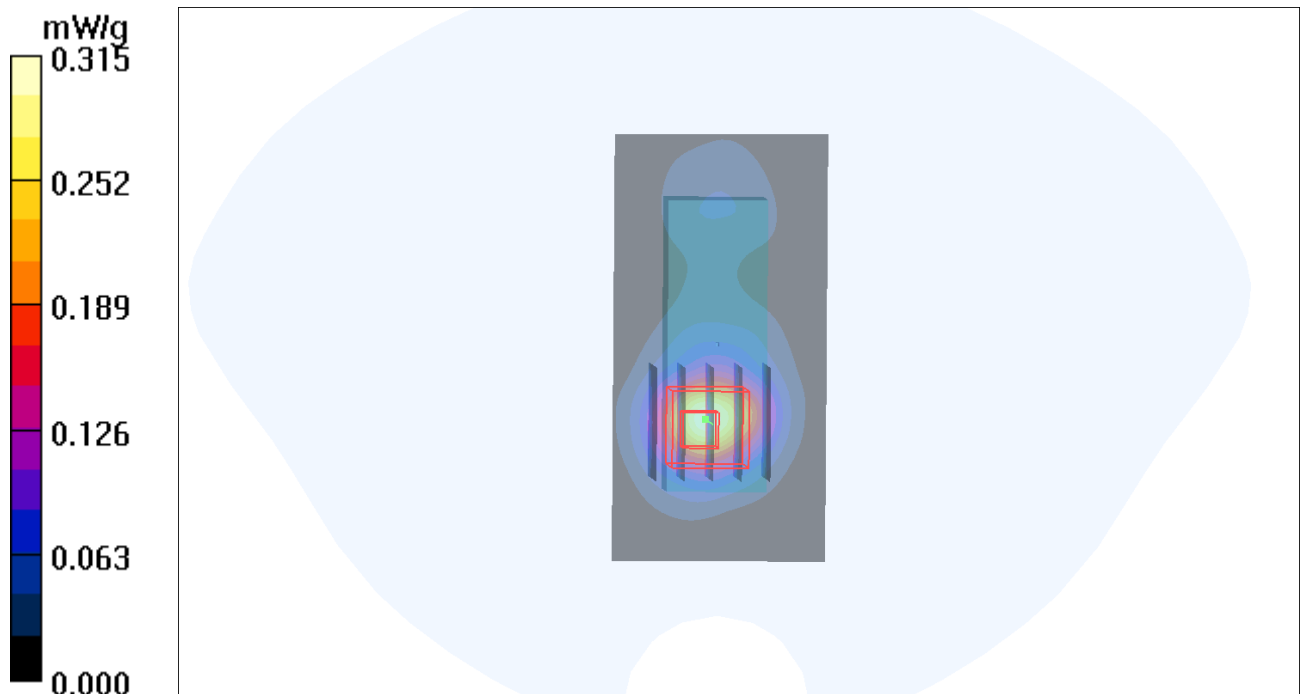

### P102 802.11n\_HT20\_Horizontal\_Down\_0.5cm\_Ch6\_ANT 0+1+2

**DUT: 111122C09**

Communication System: 802.11n\_20MHz; Frequency: 2437 MHz; Duty Cycle: 1:1

Medium: B2450\_0207 Medium parameters used:  $f = 2437$  MHz;  $\sigma = 1.95$  mho/m;  $\epsilon_r = 51$ ;  $\rho = 1000$  kg/m<sup>3</sup>

Ambient Temperature : 21.5 °C; Liquid Temperature : 20.6 °C

DASY4 Configuration:

- Probe: EX3DV4 - SN3650; ConvF(6.89, 6.89, 6.89); Calibrated: 2011/10/26
- Sensor-Surface: 2mm (Mechanical Surface Detection)
- Electronics: DAE3 Sn579; Calibrated: 2011/09/23
- Phantom: SAM Phantom\_Front; Type: SAM V4.0; Serial: TP 1654
- Measurement SW: DASY4, V4.7 Build 80; Postprocessing SW: SEMCAD, V1.8 Build 186

**Ch6/Area Scan (61x31x1):** Measurement grid: dx=20mm, dy=20mm

Maximum value of SAR (interpolated) = 0.263 mW/g

**Ch6/Zoom Scan (5x5x7)/Cube 0:** Measurement grid: dx=8mm, dy=8mm, dz=5mm

Reference Value = 8.11 V/m; Power Drift = -0.193 dB

Peak SAR (extrapolated) = 0.267 W/kg

**SAR(1 g) = 0.145 mW/g; SAR(10 g) = 0.078 mW/g**

Maximum value of SAR (measured) = 0.197 mW/g

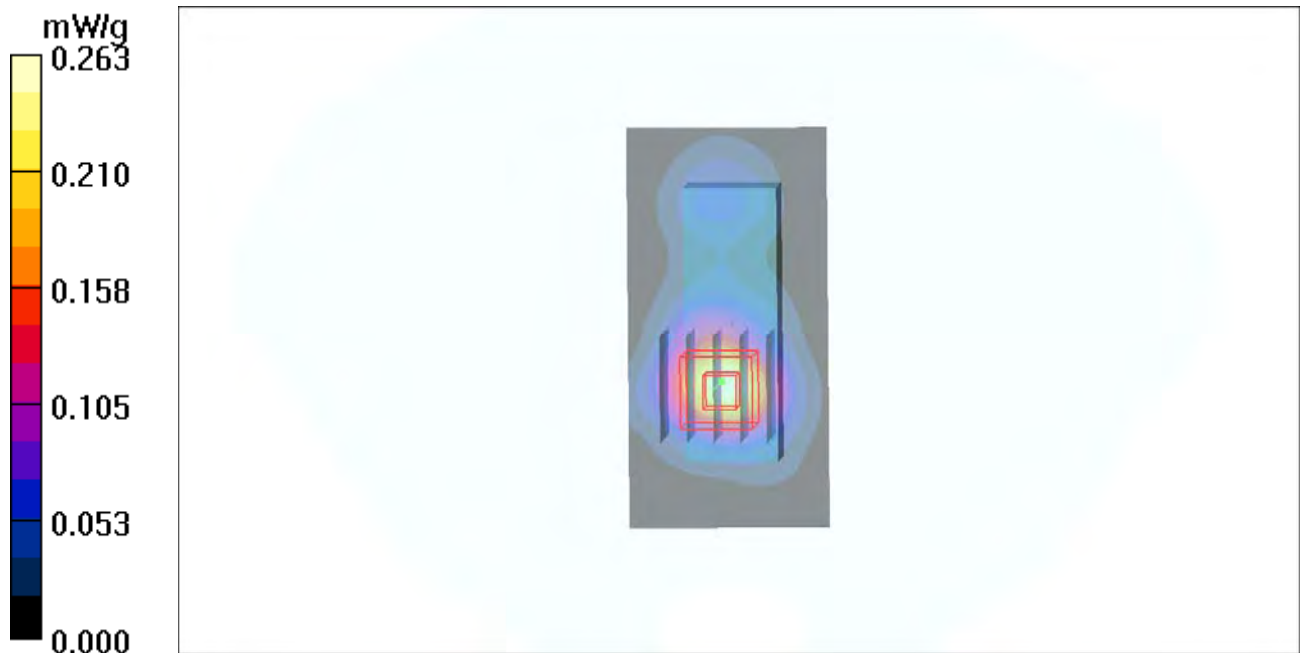

### P06 802.11n\_HT20\_Vertical Front\_0.5cm\_Ch06\_ANT 0+1+2

**DUT: 111122C09**

Communication System: 802.11b; Frequency: 2437 MHz; Duty Cycle: 1:1

Medium: B2450\_1201 Medium parameters used:  $f = 2437$  MHz;  $\sigma = 1.96$  mho/m;  $\epsilon_r = 51.3$ ;  $\rho = 1000$  kg/m<sup>3</sup>

Ambient Temperature : 22.8 °C; Liquid Temperature : 21.6 °C

DASY4 Configuration:

- Probe: EX3DV4 - SN3650; ConvF(6.89, 6.89, 6.89); Calibrated: 2011/10/26
- Sensor-Surface: 2mm (Mechanical Surface Detection)
- Electronics: DAE4 Sn1277; Calibrated: 2011/07/29
- Phantom: SAM Phantom\_Left; Type: SAM V4.0; Serial: TP 1652
- Measurement SW: DASY4, V4.7 Build 80; Postprocessing SW: SEMCAD, V1.8 Build 186

**Ch06/Area Scan (31x111x1):** Measurement grid: dx=20mm, dy=20mm

Maximum value of SAR (interpolated) = 0.160 mW/g

**Ch06/Zoom Scan (5x5x7)/Cube 0:** Measurement grid: dx=8mm, dy=8mm, dz=5mm

Reference Value = 8.39 V/m; Power Drift = -0.080 dB

Peak SAR (extrapolated) = 0.433 W/kg

**SAR(1 g) = 0.189 mW/g; SAR(10 g) = 0.082 mW/g**

Maximum value of SAR (measured) = 0.303 mW/g

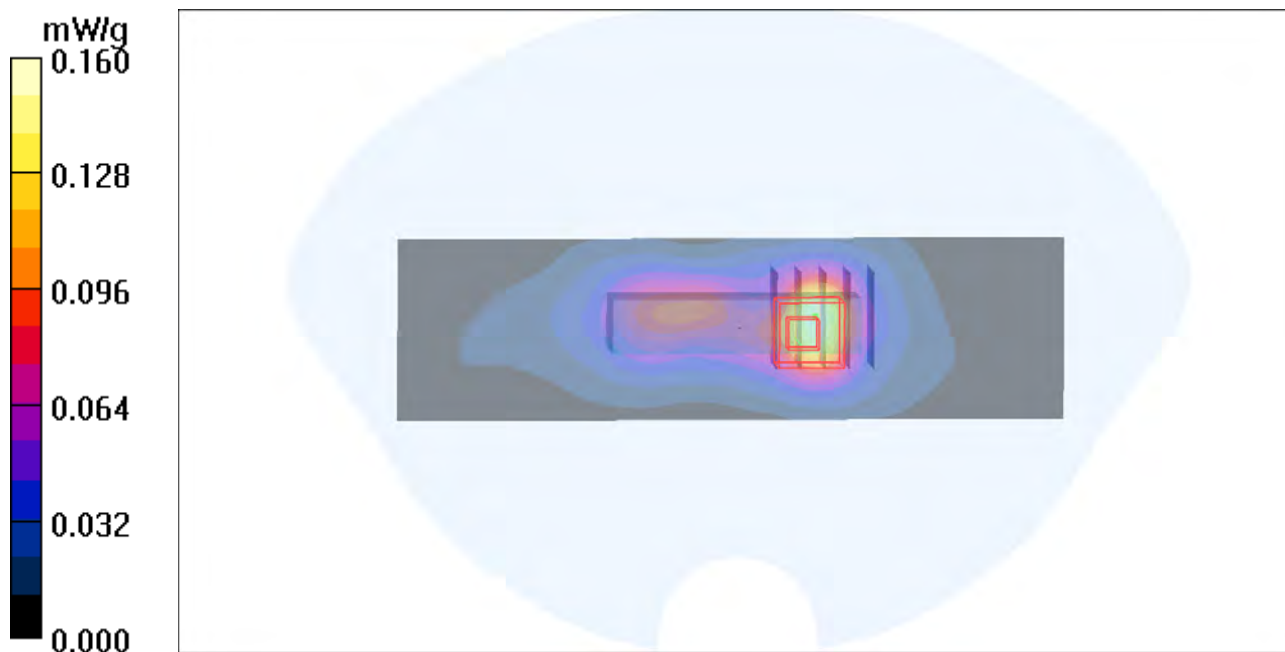

# 1g/10g Averaged SAR

SAR; Zoom Scan: Value Along Z, X=1, Y=1

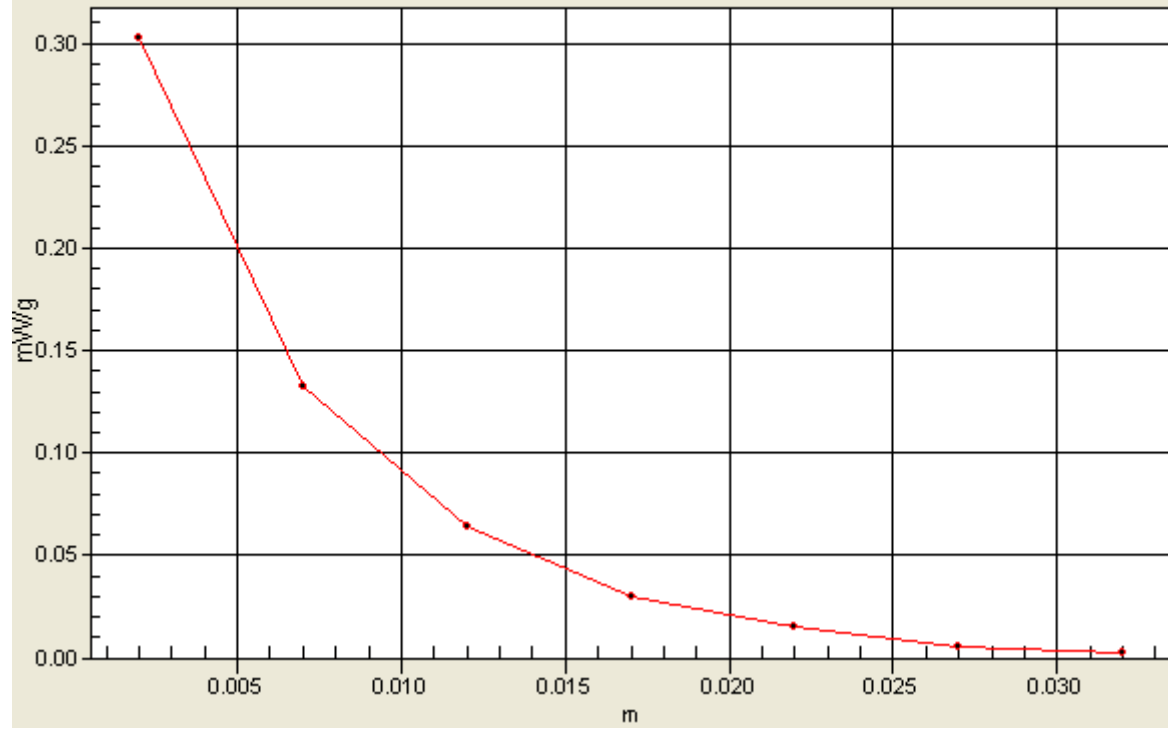

### P103 802.11n\_HT20\_Vertical Back\_0.5cm\_Ch6\_ANT 0+1+2

**DUT: 111122C09**

Communication System: 802.11n\_20MHz; Frequency: 2437 MHz; Duty Cycle: 1:1

Medium: B2450\_0207 Medium parameters used:  $f = 2437$  MHz;  $\sigma = 1.95$  mho/m;  $\epsilon_r = 51$ ;  $\rho = 1000$  kg/m<sup>3</sup>

Ambient Temperature : 21.4 °C ; Liquid Temperature : 20.6 °C

DASY4 Configuration:

- Probe: EX3DV4 - SN3650; ConvF(6.89, 6.89, 6.89); Calibrated: 2011/10/26
- Sensor-Surface: 2mm (Mechanical Surface Detection)
- Electronics: DAE3 Sn579; Calibrated: 2011/09/23
- Phantom: SAM Phantom\_Front; Type: SAM V4.0; Serial: TP 1654
- Measurement SW: DASY4, V4.7 Build 80; Postprocessing SW: SEMCAD, V1.8 Build 186

**Ch6/Area Scan (41x61x1):** Measurement grid: dx=20mm, dy=20mm

Maximum value of SAR (interpolated) = 0.215 mW/g

**Ch6/Zoom Scan (5x5x7)/Cube 0:** Measurement grid: dx=8mm, dy=8mm, dz=5mm

Reference Value = 7.31 V/m; Power Drift = -0.148 dB

Peak SAR (extrapolated) = 0.281 W/kg

**SAR(1 g) = 0.131 mW/g; SAR(10 g) = 0.061 mW/g**

Maximum value of SAR (measured) = 0.203 mW/g

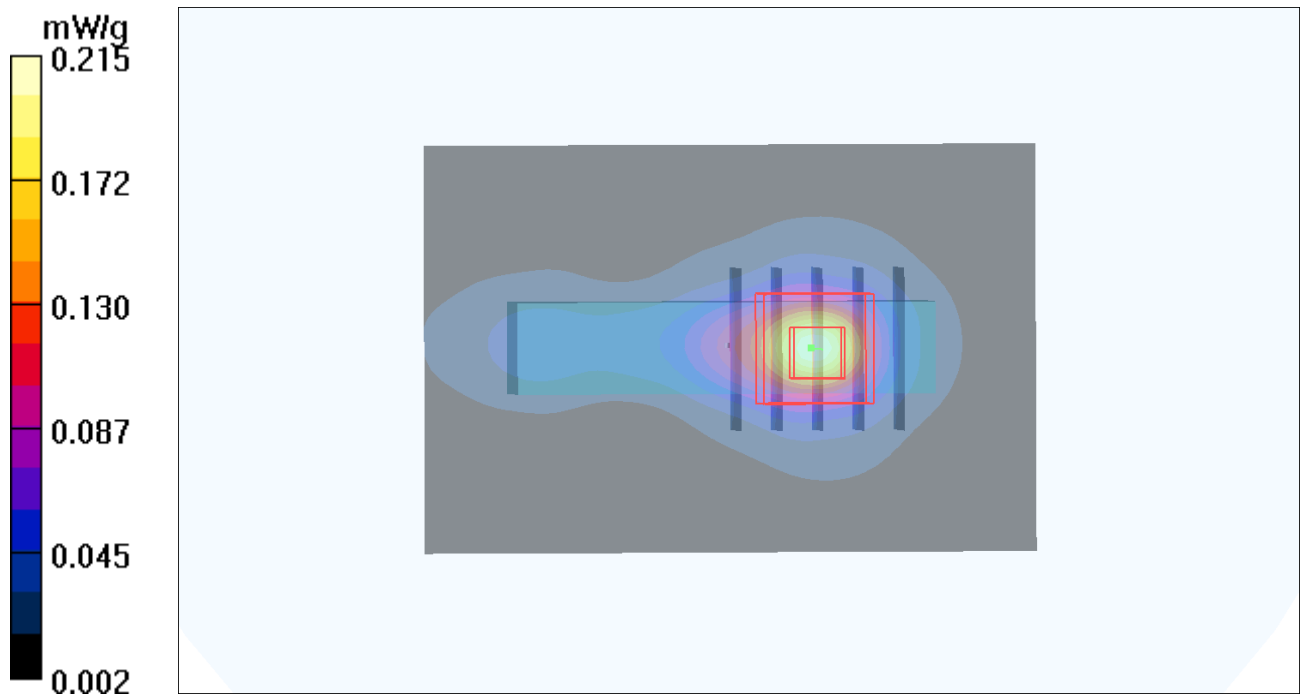

## P104 802.11n\_HT20\_Tip Mode\_0.5cm\_Ch6\_ANT 0+1+2

**DUT: 111122C09**

Communication System: 802.11n\_20MHz; Frequency: 2437 MHz; Duty Cycle: 1:1

Medium: B2450\_0207 Medium parameters used:  $f = 2437$  MHz;  $\sigma = 1.95$  mho/m;  $\epsilon_r = 51$ ;  $\rho = 1000$  kg/m<sup>3</sup>

Ambient Temperature : 21.4 °C; Liquid Temperature : 20.6 °C

DASY4 Configuration:

- Probe: EX3DV4 - SN3650; ConvF(6.89, 6.89, 6.89); Calibrated: 2011/10/26
- Sensor-Surface: 2mm (Mechanical Surface Detection)
- Electronics: DAE3 Sn579; Calibrated: 2011/09/23
- Phantom: SAM Phantom\_Front; Type: SAM V4.0; Serial: TP 1654
- Measurement SW: DASY4, V4.7 Build 80; Postprocessing SW: SEMCAD, V1.8 Build 186

**Ch6/Area Scan (41x41x1):** Measurement grid: dx=20mm, dy=20mm

Maximum value of SAR (interpolated) = 0.023 mW/g

**Ch6/Zoom Scan (5x5x7)/Cube 0:** Measurement grid: dx=8mm, dy=8mm, dz=5mm

Reference Value = 3.36 V/m; Power Drift = -0.058 dB

Peak SAR (extrapolated) = 0.037 W/kg

**SAR(1 g) = 0.019 mW/g; SAR(10 g) = 0.011 mW/g**

Maximum value of SAR (measured) = 0.026 mW/g





## P11 802.11a\_Horizontal Up\_0.5cm\_Ch40\_ANT 0

**DUT: 111122C09**

Communication System: 802.11a; Frequency: 5200 MHz; Duty Cycle: 1:1

Medium: B5G\_1213 Medium parameters used:  $f = 5200$  MHz;  $\sigma = 5.18$  mho/m;  $\epsilon_r = 47.8$ ;  $\rho = 1000$  kg/m<sup>3</sup>

Ambient Temperature : 22.3 °C ; Liquid Temperature : 21.1 °C

DASY4 Configuration:

- Probe: EX3DV4 - SN3650; ConvF(4.28, 4.28, 4.28); Calibrated: 2011/10/26
- Sensor-Surface: 2mm (Mechanical Surface Detection)
- Electronics: DAE4 Sn1277; Calibrated: 2011/07/29
- Phantom: SAM Phantom\_Left; Type: SAM V4.0; Serial: TP 1652
- Measurement SW: DASY4, V4.7 Build 80; Postprocessing SW: SEMCAD, V1.8 Build 186

**Ch40/Area Scan (121x61x1):** Measurement grid: dx=10mm, dy=10mm

Maximum value of SAR (interpolated) = 0.425 mW/g

**Ch40/Zoom Scan (7x7x9)/Cube 0:** Measurement grid: dx=4mm, dy=4mm, dz=2.5mm

Reference Value = 8.27 V/m; Power Drift = -0.163 dB

Peak SAR (extrapolated) = 0.587 W/kg

**SAR(1 g) = 0.167 mW/g; SAR(10 g) = 0.048 mW/g**

Maximum value of SAR (measured) = 0.342 mW/g

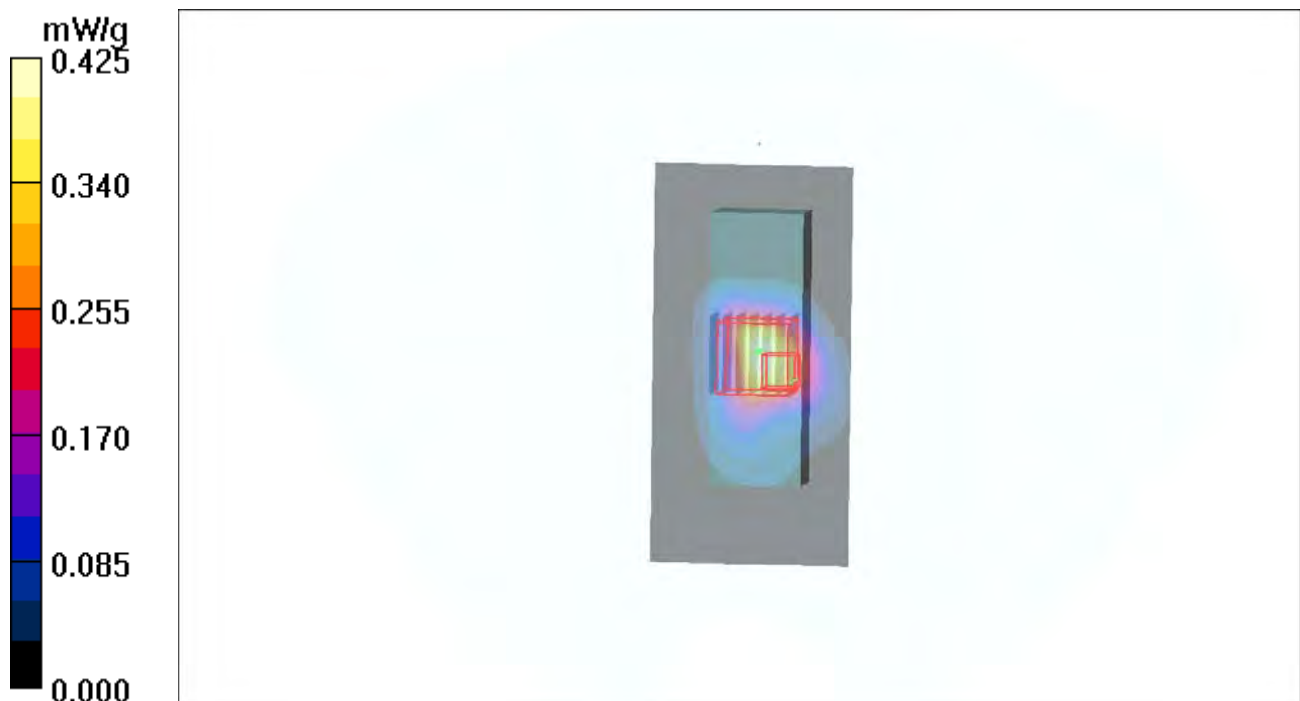

## P12 802.11a\_Horizontal Down\_0.5cm\_Ch40\_ANT 0

**DUT: 111122C09**

Communication System: 802.11a; Frequency: 5200 MHz; Duty Cycle: 1:1

Medium: B5G\_1213 Medium parameters used:  $f = 5200$  MHz;  $\sigma = 5.18$  mho/m;  $\epsilon_r = 47.8$ ;  $\rho = 1000$  kg/m<sup>3</sup>

Ambient Temperature : 22.3 °C ; Liquid Temperature : 21.1 °C

DASY4 Configuration:

- Probe: EX3DV4 - SN3650; ConvF(4.28, 4.28, 4.28); Calibrated: 2011/10/26
- Sensor-Surface: 2mm (Mechanical Surface Detection)
- Electronics: DAE4 Sn1277; Calibrated: 2011/07/29
- Phantom: SAM Phantom\_Left; Type: SAM V4.0; Serial: TP 1652
- Measurement SW: DASY4, V4.7 Build 80; Postprocessing SW: SEMCAD, V1.8 Build 186

**Ch40/Area Scan (121x61x1):** Measurement grid: dx=10mm, dy=10mm

Maximum value of SAR (interpolated) = 0.131 mW/g

**Ch40/Zoom Scan (7x7x9)/Cube 0:** Measurement grid: dx=4mm, dy=4mm, dz=2.5mm

Reference Value = 3.24 V/m; Power Drift = -0.145 dB

Peak SAR (extrapolated) = 0.337 W/kg

**SAR(1 g) = 0.066 mW/g; SAR(10 g) = 0.014 mW/g**

Maximum value of SAR (measured) = 0.156 mW/g

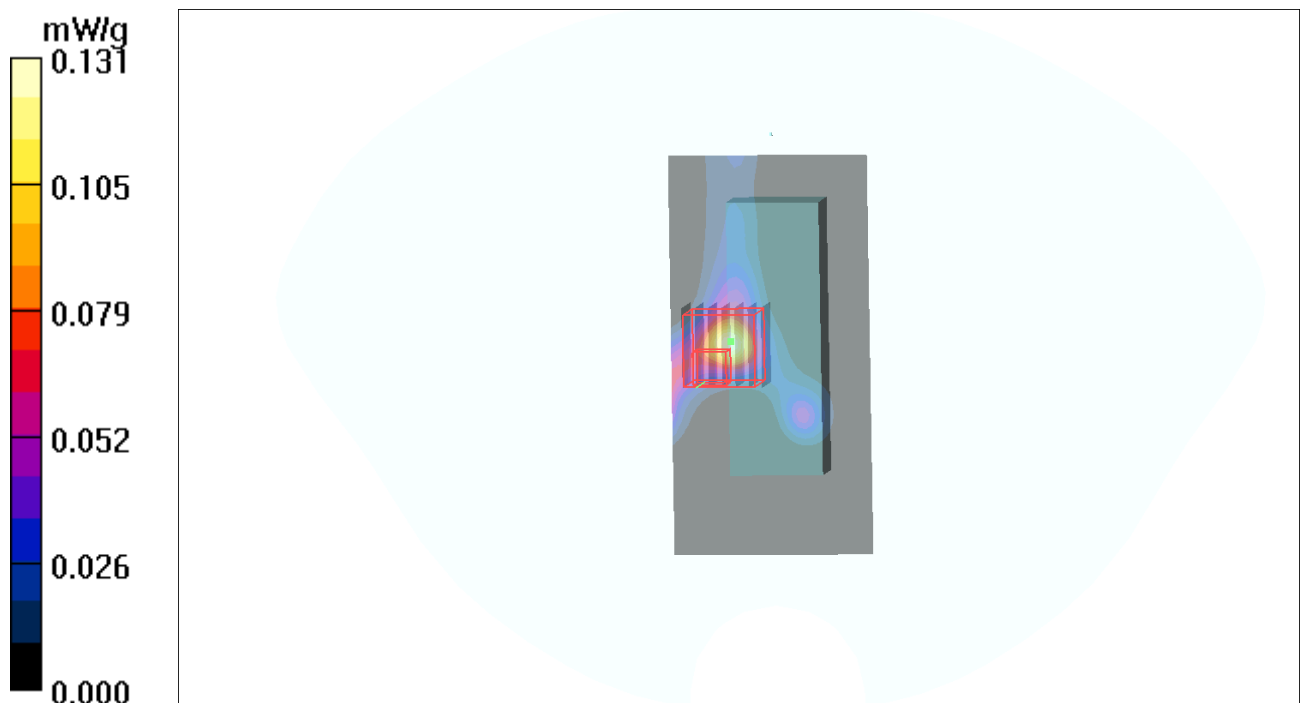

### P13 802.11a\_Verical Front\_0.5cm\_Ch40\_ANT 0

**DUT: 111122C09**

Communication System: 802.11a; Frequency: 5200 MHz; Duty Cycle: 1:1

Medium: B5G\_1213 Medium parameters used:  $f = 5200$  MHz;  $\sigma = 5.18$  mho/m;  $\epsilon_r = 47.8$ ;  $\rho = 1000$  kg/m<sup>3</sup>

Ambient Temperature : 22.3 °C ; Liquid Temperature : 21.1 °C

DASY4 Configuration:

- Probe: EX3DV4 - SN3650; ConvF(4.28, 4.28, 4.28); Calibrated: 2011/10/26
- Sensor-Surface: 2mm (Mechanical Surface Detection)
- Electronics: DAE4 Sn1277; Calibrated: 2011/07/29
- Phantom: SAM Phantom\_Left; Type: SAM V4.0; Serial: TP 1652
- Measurement SW: DASY4, V4.7 Build 80; Postprocessing SW: SEMCAD, V1.8 Build 186

**Ch40/Area Scan (81x121x1):** Measurement grid: dx=10mm, dy=10mm

Maximum value of SAR (interpolated) = 0.558 mW/g

**Ch40/Zoom Scan (7x7x9)/Cube 0:** Measurement grid: dx=4mm, dy=4mm, dz=2.5mm

Reference Value = 10.9 V/m; Power Drift = -0.183 dB

Peak SAR (extrapolated) = 1.43 W/kg

**SAR(1 g) = 0.383 mW/g; SAR(10 g) = 0.084 mW/g**

Maximum value of SAR (measured) = 0.854 mW/g

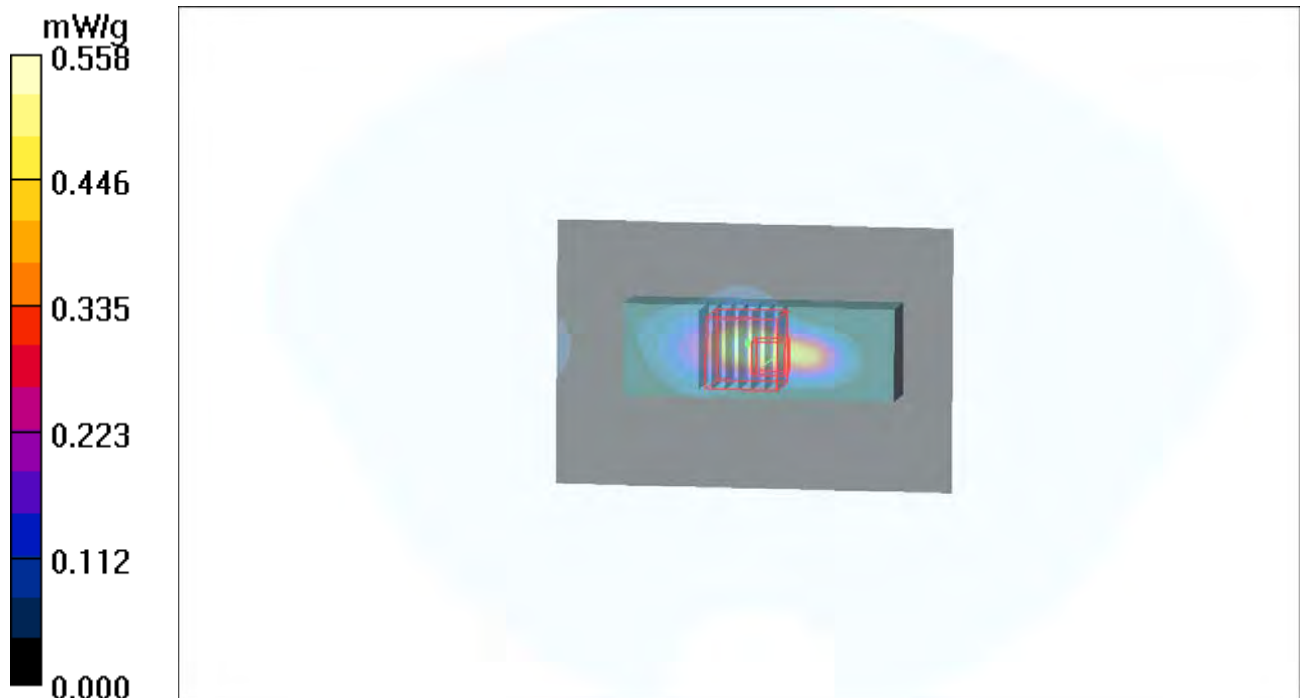

## P14 802.11a\_Verical Back\_0.5cm\_Ch40\_ANT 0

**DUT: 111122C09**

Communication System: 802.11a; Frequency: 5200 MHz; Duty Cycle: 1:1

Medium: B5G\_1213 Medium parameters used:  $f = 5200$  MHz;  $\sigma = 5.18$  mho/m;  $\epsilon_r = 47.8$ ;  $\rho = 1000$  kg/m<sup>3</sup>

Ambient Temperature : 22.3 °C; Liquid Temperature : 21.1 °C

DASY4 Configuration:

- Probe: EX3DV4 - SN3650; ConvF(4.28, 4.28, 4.28); Calibrated: 2011/10/26
- Sensor-Surface: 2mm (Mechanical Surface Detection)
- Electronics: DAE4 Sn1277; Calibrated: 2011/07/29
- Phantom: SAM Phantom\_Left; Type: SAM V4.0; Serial: TP 1652
- Measurement SW: DASY4, V4.7 Build 80; Postprocessing SW: SEMCAD, V1.8 Build 186

**Ch40/Area Scan (81x121x1):** Measurement grid: dx=10mm, dy=10mm

Maximum value of SAR (interpolated) = 0.031 mW/g

**Ch40/Zoom Scan (7x7x9)/Cube 0:** Measurement grid: dx=4mm, dy=4mm, dz=2.5mm

Reference Value = 0.000 V/m; Power Drift = 0.000 dB

Peak SAR (extrapolated) = 0.142 W/kg

**SAR(1 g) = 0.014 mW/g; SAR(10 g) = 0.00367 mW/g**

Maximum value of SAR (measured) = 0.032 mW/g

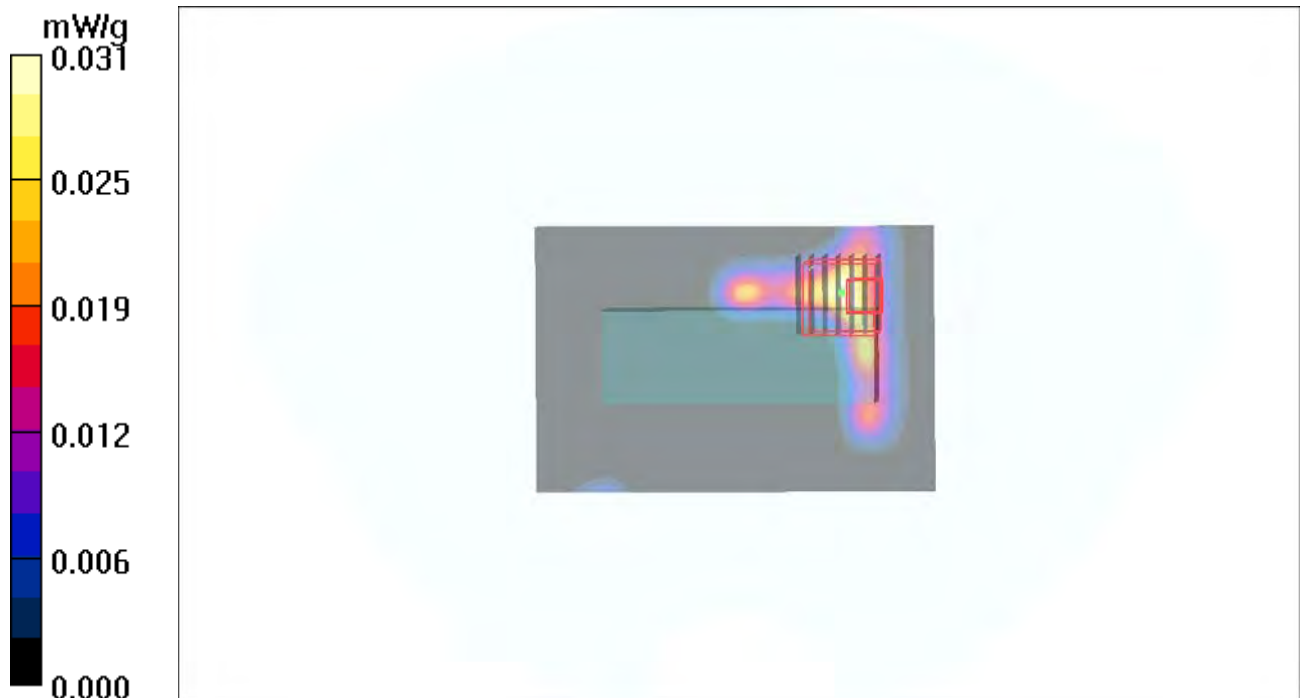

## P15 802.11a\_Tip Mode\_0.5cm\_Ch40\_ANT 0

**DUT: 111122C09**

Communication System: 802.11a; Frequency: 5200 MHz; Duty Cycle: 1:1

Medium: B5G\_1213 Medium parameters used:  $f = 5200$  MHz;  $\sigma = 5.18$  mho/m;  $\epsilon_r = 47.8$ ;  $\rho = 1000$  kg/m<sup>3</sup>

Ambient Temperature : 22.3 °C ; Liquid Temperature : 21.1 °C

DASY4 Configuration:

- Probe: EX3DV4 - SN3650; ConvF(4.28, 4.28, 4.28); Calibrated: 2011/10/26
- Sensor-Surface: 2mm (Mechanical Surface Detection)
- Electronics: DAE4 Sn1277; Calibrated: 2011/07/29
- Phantom: SAM Phantom\_Left; Type: SAM V4.0; Serial: TP 1652
- Measurement SW: DASY4, V4.7 Build 80; Postprocessing SW: SEMCAD, V1.8 Build 186

**Ch40/Area Scan (81x81x1):** Measurement grid: dx=10mm, dy=10mm

Maximum value of SAR (interpolated) = 0.015 mW/g

**Ch40/Zoom Scan (7x7x9)/Cube 0:** Measurement grid: dx=4mm, dy=4mm, dz=2.5mm

Reference Value = 1.88 V/m; Power Drift = 0.145 dB

Peak SAR (extrapolated) = 0.156 W/kg

**SAR(1 g) = 0.016 mW/g; SAR(10 g) = 0.00375 mW/g**

Maximum value of SAR (measured) = 0.032 mW/g

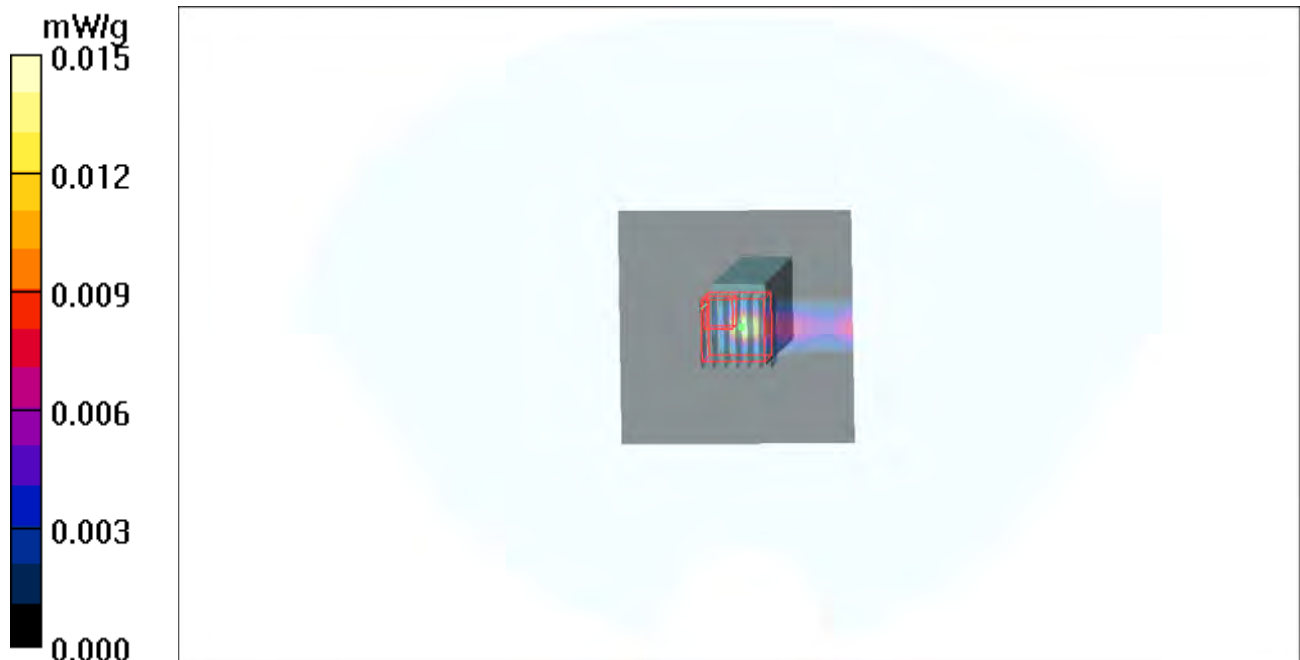

## P105 802.11n\_HT40\_Horizontal Up\_0.5cm\_Ch46\_ANT 0+1+2

**DUT: 111122C09**

Communication System: 802.11aN\_40MHz; Frequency: 5230 MHz; Duty Cycle: 1:1

Medium: B5G\_0206 Medium parameters used:  $f = 5230$  MHz;  $\sigma = 5.24$  mho/m;  $\epsilon_r = 47.4$ ;  $\rho = 1000$  kg/m<sup>3</sup>

Ambient Temperature : 21.6 °C; Liquid Temperature : 20.7 °C

DASY4 Configuration:

- Probe: EX3DV4 - SN3650; ConvF(4.28, 4.28, 4.28); Calibrated: 2011/10/26
- Sensor-Surface: 2mm (Mechanical Surface Detection)
- Electronics: DAE3 Sn579; Calibrated: 2011/09/23
- Phantom: SAM Phantom\_Left; Type: SAM V4.0; Serial: TP 1652
- Measurement SW: DASY4, V4.7 Build 80; Postprocessing SW: SEMCAD, V1.8 Build 186

**Ch46/Area Scan (121x61x1):** Measurement grid: dx=10mm, dy=10mm

Maximum value of SAR (interpolated) = 0.422 mW/g

**Ch46/Zoom Scan (7x7x9)/Cube 0:** Measurement grid: dx=4mm, dy=4mm, dz=2.5mm

Reference Value = 8.57 V/m; Power Drift = -0.159 dB

Peak SAR (extrapolated) = 0.583 W/kg

**SAR(1 g) = 0.170 mW/g; SAR(10 g) = 0.056 mW/g**

Maximum value of SAR (measured) = 0.342 mW/g

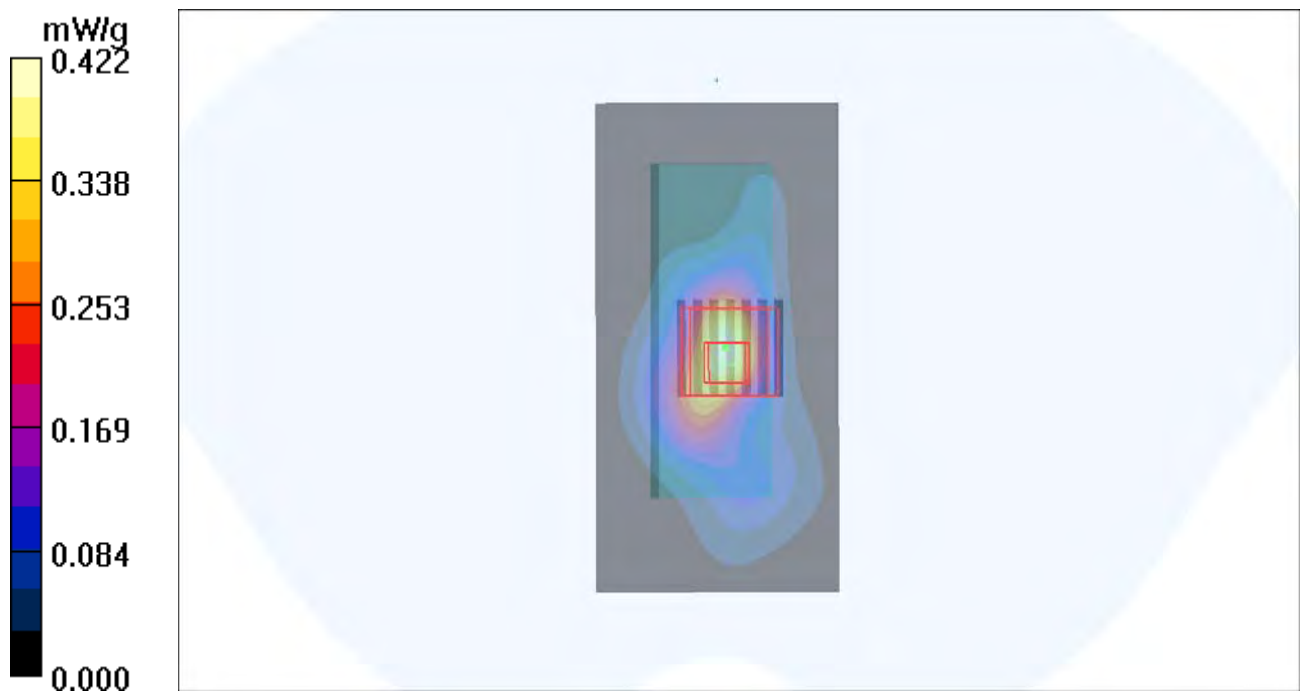

## P106 802.11n\_HT40\_Horizontal\_Down\_0.5cm\_Ch46\_ANT 0+1+2

**DUT: 111122C09**

Communication System: 802.11aN\_40MHz; Frequency: 5230 MHz; Duty Cycle: 1:1

Medium: B5G\_0206 Medium parameters used:  $f = 5230$  MHz;  $\sigma = 5.24$  mho/m;  $\epsilon_r = 47.4$ ;  $\rho = 1000$  kg/m<sup>3</sup>

Ambient Temperature : 21.6 °C; Liquid Temperature : 20.7 °C

DASY4 Configuration:

- Probe: EX3DV4 - SN3650; ConvF(4.28, 4.28, 4.28); Calibrated: 2011/10/26
- Sensor-Surface: 2mm (Mechanical Surface Detection)
- Electronics: DAE3 Sn579; Calibrated: 2011/09/23
- Phantom: SAM Phantom\_Left; Type: SAM V4.0; Serial: TP 1652
- Measurement SW: DASY4, V4.7 Build 80; Postprocessing SW: SEMCAD, V1.8 Build 186

**Ch46/Area Scan (121x61x1):** Measurement grid: dx=10mm, dy=10mm

Maximum value of SAR (interpolated) = 0.105 mW/g

**Ch46/Zoom Scan (7x7x9)/Cube 0:** Measurement grid: dx=4mm, dy=4mm, dz=2.5mm

Reference Value = 4.31 V/m; Power Drift = -0.17 dB

Peak SAR (extrapolated) = 0.207 W/kg

**SAR(1 g) = 0.038 mW/g; SAR(10 g) = 0.013 mW/g**

Maximum value of SAR (measured) = 0.075 mW/g

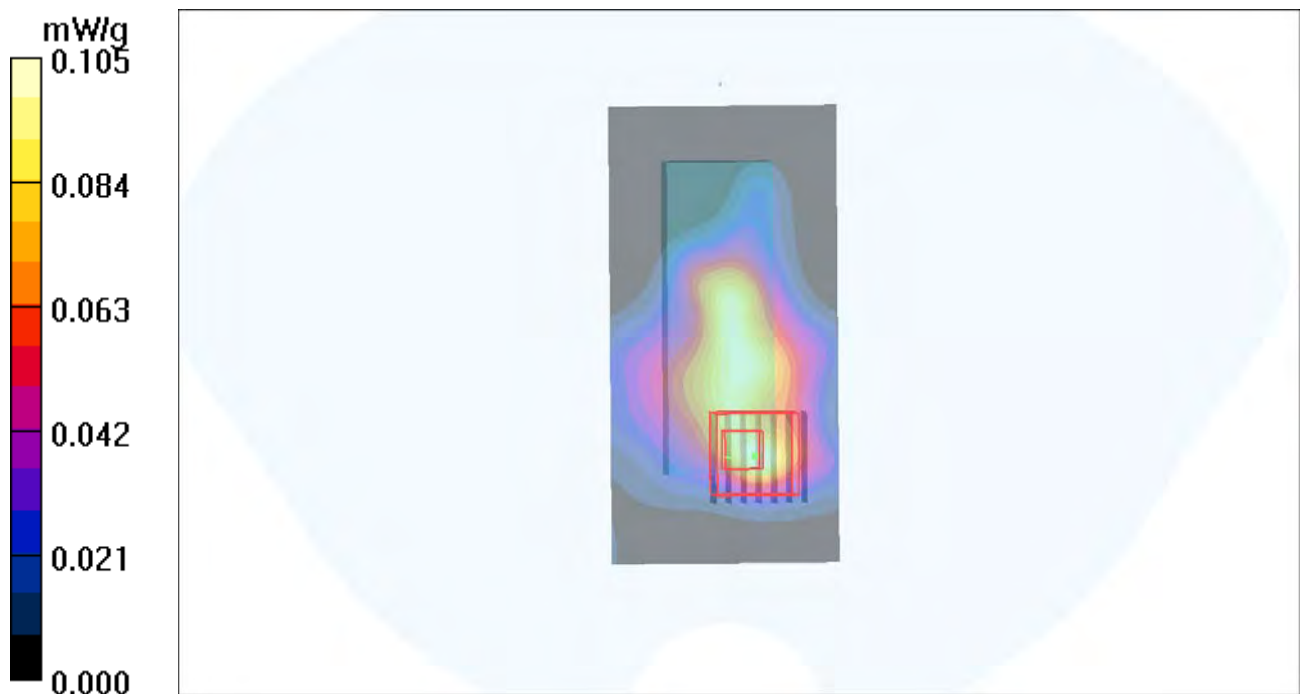

## P19 802.11n\_HT40\_Vertical Front\_0.5cm\_Ch46\_ANT 0+1+2

**DUT: 111122C09**

Communication System: 802.11aN\_40MHz; Frequency: 5230 MHz; Duty Cycle: 1:1

Medium: B5G\_1213 Medium parameters used:  $f = 5230$  MHz;  $\sigma = 5.25$  mho/m;  $\epsilon_r = 47.8$ ;  $\rho = 1000$  kg/m<sup>3</sup>

Ambient Temperature : 22.1 °C; Liquid Temperature : 21.1 °C

DASY4 Configuration:

- Probe: EX3DV4 - SN3650; ConvF(4.28, 4.28, 4.28); Calibrated: 2011/10/26
- Sensor-Surface: 2mm (Mechanical Surface Detection)
- Electronics: DAE4 Sn1277; Calibrated: 2011/07/29
- Phantom: SAM Phantom\_Left; Type: SAM V4.0; Serial: TP 1652
- Measurement SW: DASY4, V4.7 Build 80; Postprocessing SW: SEMCAD, V1.8 Build 186

**Ch46/Area Scan (81x121x1):** Measurement grid: dx=10mm, dy=10mm

Maximum value of SAR (interpolated) = 0.239 mW/g

**Ch46/Zoom Scan (7x7x9)/Cube 0:** Measurement grid: dx=4mm, dy=4mm, dz=2.5mm

Reference Value = 6.76 V/m; Power Drift = -0.178 dB

Peak SAR (extrapolated) = 0.630 W/kg

**SAR(1 g) = 0.161 mW/g; SAR(10 g) = 0.043 mW/g**

Maximum value of SAR (measured) = 0.355 mW/g

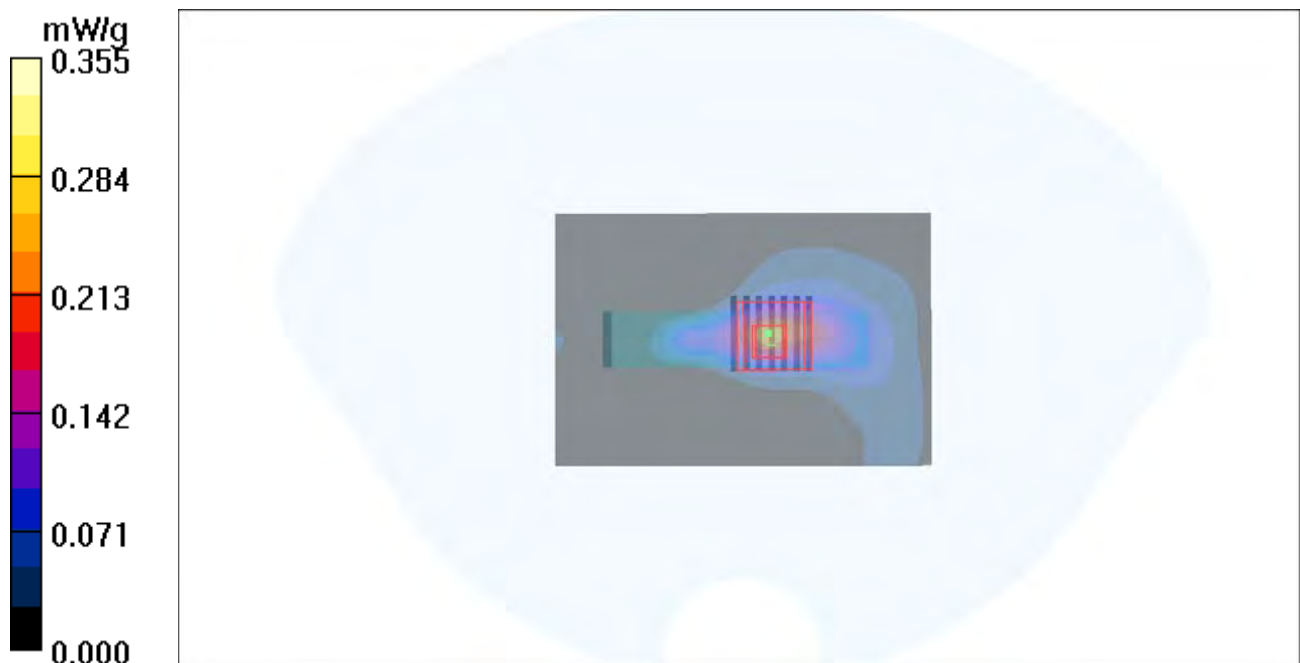



### P107 802.11n\_HT40\_Vertical Back\_0.5cm\_Ch46\_ANT 0+1+2

**DUT: 111122C09**

Communication System: 802.11aN\_40MHz; Frequency: 5230 MHz; Duty Cycle: 1:1

Medium: B5G\_0206 Medium parameters used:  $f = 5230$  MHz;  $\sigma = 5.24$  mho/m;  $\epsilon_r = 47.4$ ;  $\rho = 1000$  kg/m<sup>3</sup>

Ambient Temperature : 21.7 °C; Liquid Temperature : 20.7 °C

DASY4 Configuration:

- Probe: EX3DV4 - SN3650; ConvF(4.28, 4.28, 4.28); Calibrated: 2011/10/26
- Sensor-Surface: 2mm (Mechanical Surface Detection)
- Electronics: DAE3 Sn579; Calibrated: 2011/09/23
- Phantom: SAM Phantom\_Left; Type: SAM V4.0; Serial: TP 1652
- Measurement SW: DASY4, V4.7 Build 80; Postprocessing SW: SEMCAD, V1.8 Build 186

**Ch46/Area Scan (81x121x1):** Measurement grid: dx=10mm, dy=10mm

Maximum value of SAR (interpolated) = 0.552 mW/g

**Ch46/Zoom Scan (7x7x9)/Cube 0:** Measurement grid: dx=4mm, dy=4mm, dz=2.5mm

Reference Value = 13.1 V/m; Power Drift = -0.17 dB

Peak SAR (extrapolated) = 1.08 W/kg

**SAR(1 g) = 0.209 mW/g; SAR(10 g) = 0.051 mW/g**

Maximum value of SAR (measured) = 0.430 mW/g

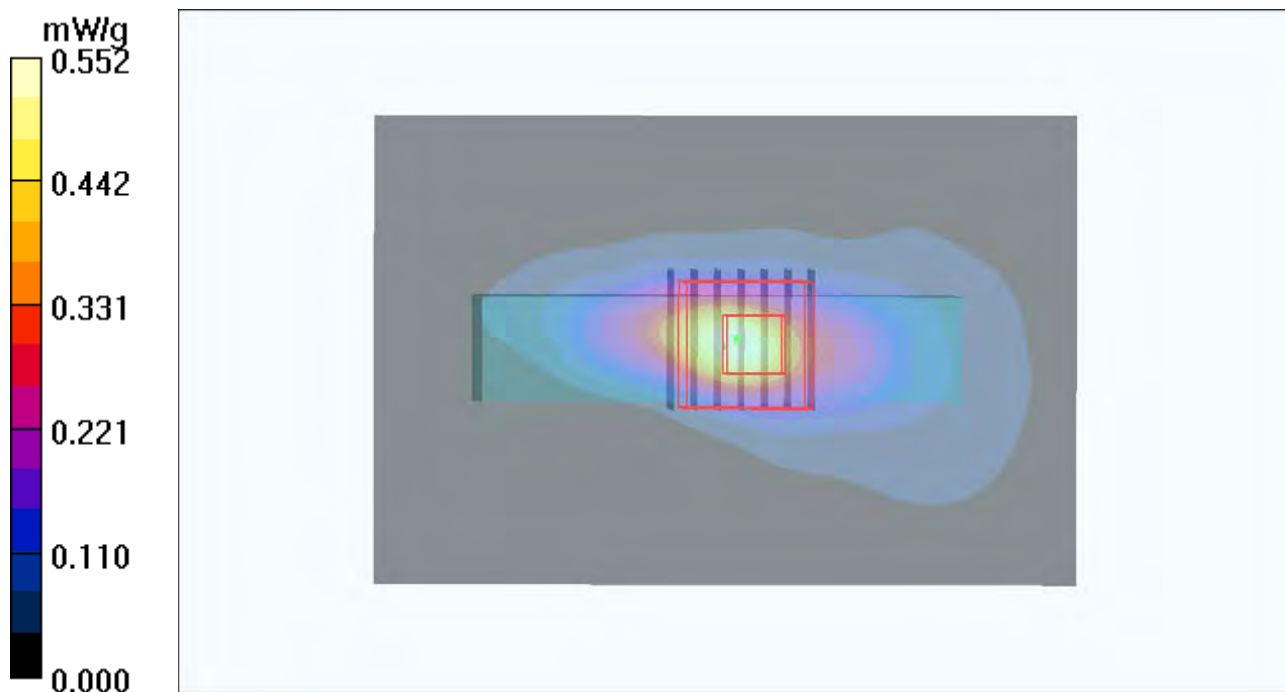

### P108 802.11n\_HT40\_Tip Mode\_0.5cm\_Ch46\_ANT 0+1+2

**DUT: 111122C09**

Communication System: 802.11aN\_40MHz; Frequency: 5230 MHz; Duty Cycle: 1:1

Medium: B5G\_0206 Medium parameters used:  $f = 5230$  MHz;  $\sigma = 5.24$  mho/m;  $\epsilon_r = 47.4$ ;  $\rho = 1000$  kg/m<sup>3</sup>

Ambient Temperature : 21.7 °C ; Liquid Temperature : 20.7 °C

DASY4 Configuration:

- Probe: EX3DV4 - SN3650; ConvF(4.28, 4.28, 4.28); Calibrated: 2011/10/26
- Sensor-Surface: 2mm (Mechanical Surface Detection)
- Electronics: DAE3 Sn579; Calibrated: 2011/09/23
- Phantom: SAM Phantom\_Left; Type: SAM V4.0; Serial: TP 1652
- Measurement SW: DASY4, V4.7 Build 80; Postprocessing SW: SEMCAD, V1.8 Build 186

**Ch46/Area Scan (81x81x1):** Measurement grid: dx=10mm, dy=10mm

Maximum value of SAR (interpolated) = 0.060 mW/g

**Ch46/Zoom Scan (7x7x9)/Cube 0:** Measurement grid: dx=4mm, dy=4mm, dz=2.5mm

Reference Value = 2.92 V/m; Power Drift = -0.18 dB

Peak SAR (extrapolated) = 0.130 W/kg

**SAR(1 g) = 0.013 mW/g; SAR(10 g) = 0.00409 mW/g**

Maximum value of SAR (measured) = 0.029 mW/g

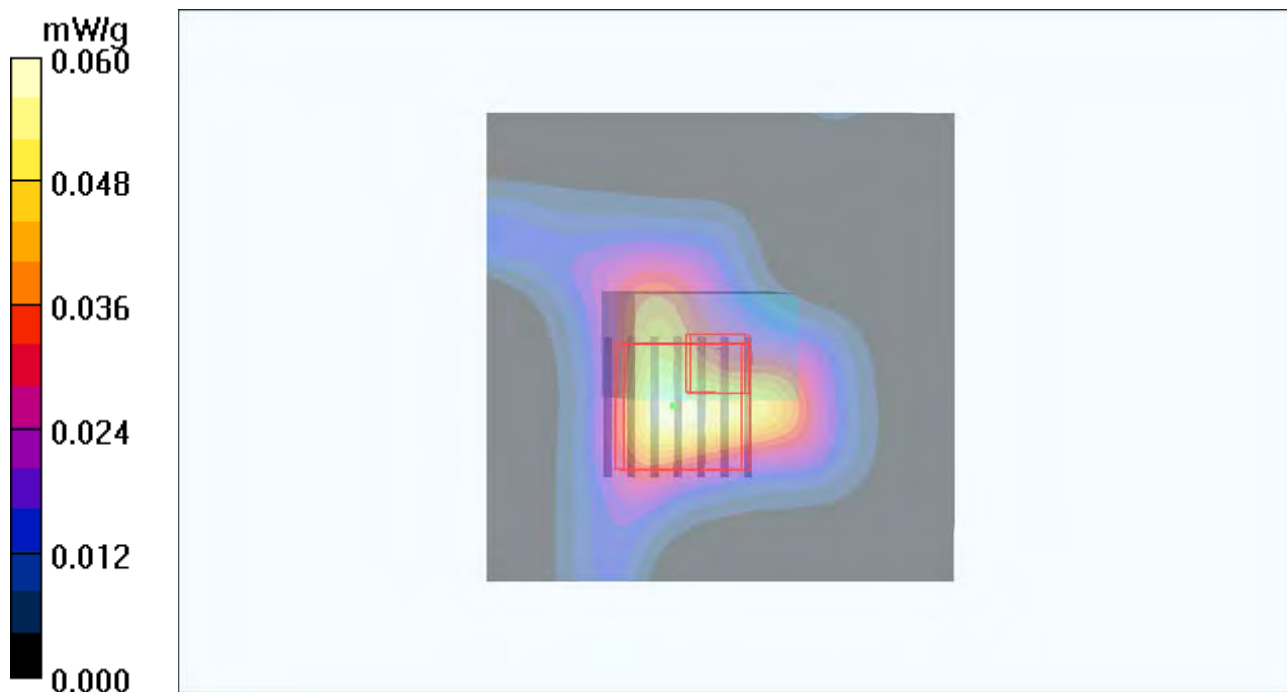

## P68 802.11a\_Horizontal Up\_0.5cm\_Ch64\_ANT 0

**DUT: 111122C09**

Communication System: 802.11a; Frequency: 5320 MHz; Duty Cycle: 1:1

Medium: B5G\_1213 Medium parameters used:  $f = 5320$  MHz;  $\sigma = 5.36$  mho/m;  $\epsilon_r = 48$ ;  $\rho = 1000$  kg/m<sup>3</sup>

Ambient Temperature : 22.1 °C; Liquid Temperature : 21.1 °C

DASY4 Configuration:

- Probe: EX3DV4 - SN3650; ConvF(4.11, 4.11, 4.11); Calibrated: 2011/10/26
- Sensor-Surface: 2mm (Mechanical Surface Detection)
- Electronics: DAE4 Sn1277; Calibrated: 2011/07/29
- Phantom: SAM Phantom\_Left; Type: SAM V4.0; Serial: TP 1652
- Measurement SW: DASY4, V4.7 Build 80; Postprocessing SW: SEMCAD, V1.8 Build 186

**Ch64/Area Scan (121x61x1):** Measurement grid: dx=10mm, dy=10mm

Maximum value of SAR (interpolated) = 0.919 mW/g

**Ch64/Zoom Scan (7x7x9)/Cube 0:** Measurement grid: dx=4mm, dy=4mm, dz=2.5mm

Reference Value = 13.2 V/m; Power Drift = -0.15 dB

Peak SAR (extrapolated) = 1.67 W/kg

**SAR(1 g) = 0.453 mW/g; SAR(10 g) = 0.152 mW/g**

Maximum value of SAR (measured) = 0.899 mW/g

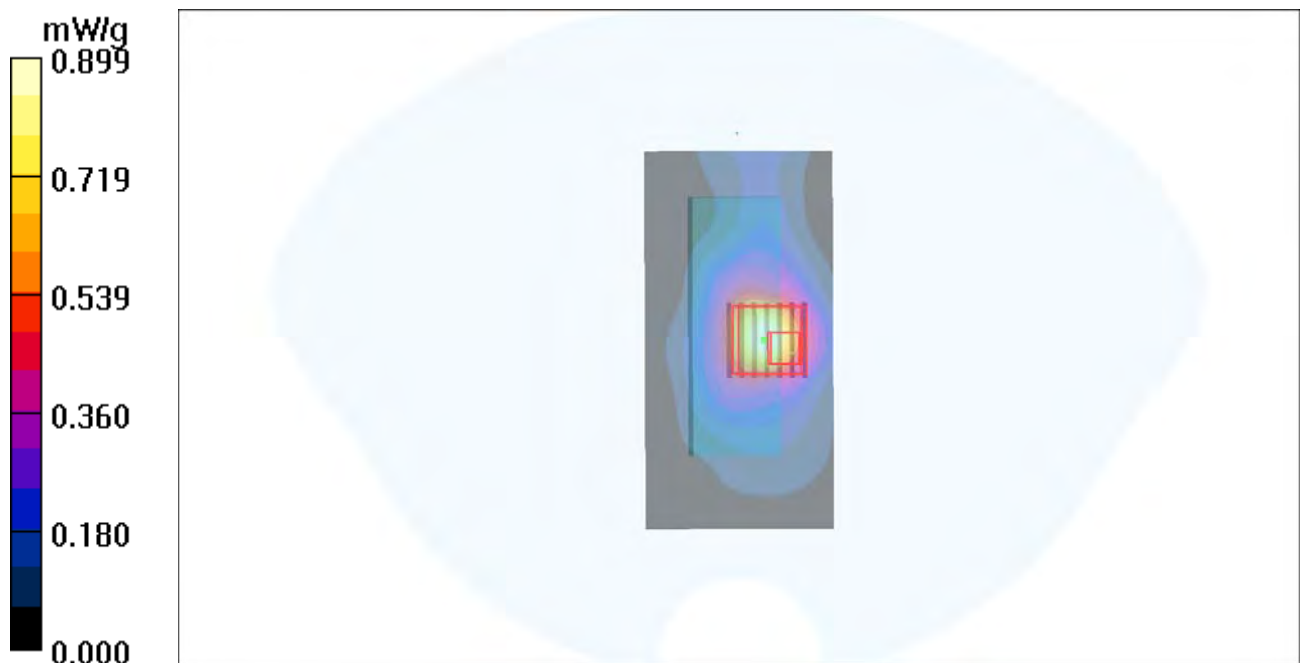

## P69 802.11a\_Horizontal Down\_0.5cm\_Ch64\_ANT 0

**DUT: 111122C09**

Communication System: 802.11a; Frequency: 5320 MHz; Duty Cycle: 1:1

Medium: B5G\_1213 Medium parameters used:  $f = 5320$  MHz;  $\sigma = 5.36$  mho/m;  $\epsilon_r = 48$ ;  $\rho = 1000$  kg/m<sup>3</sup>

Ambient Temperature : 22.3 °C ; Liquid Temperature : 21.1 °C

DASY4 Configuration:

- Probe: EX3DV4 - SN3650; ConvF(4.11, 4.11, 4.11); Calibrated: 2011/10/26
- Sensor-Surface: 2mm (Mechanical Surface Detection)
- Electronics: DAE4 Sn1277; Calibrated: 2011/07/29
- Phantom: SAM Phantom\_Left; Type: SAM V4.0; Serial: TP 1652
- Measurement SW: DASY4, V4.7 Build 80; Postprocessing SW: SEMCAD, V1.8 Build 186

**Ch64/Area Scan (121x61x1):** Measurement grid: dx=10mm, dy=10mm

Maximum value of SAR (interpolated) = 0.313 mW/g

**Ch64/Zoom Scan (7x7x9)/Cube 0:** Measurement grid: dx=4mm, dy=4mm, dz=2.5mm

Reference Value = 7.12 V/m; Power Drift = -0.18 dB

Peak SAR (extrapolated) = 0.703 W/kg

**SAR(1 g) = 0.169 mW/g; SAR(10 g) = 0.043 mW/g**

Maximum value of SAR (measured) = 0.395 mW/g

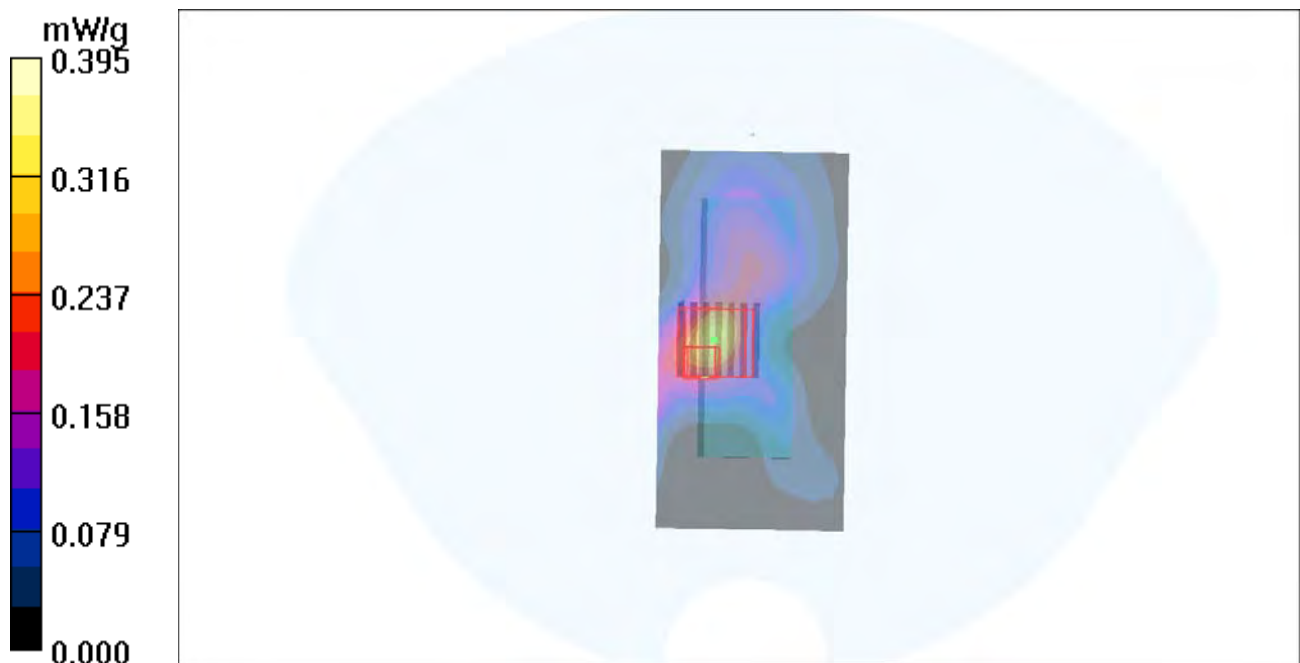

### P60 802.11a\_Vertical Front\_0.5cm\_Ch64\_ANT 0

**DUT: 111122C09**

Communication System: 802.11a; Frequency: 5320 MHz; Duty Cycle: 1:1

Medium: B5G\_1213 Medium parameters used:  $f = 5320$  MHz;  $\sigma = 5.36$  mho/m;  $\epsilon_r = 48$ ;  $\rho = 1000$  kg/m<sup>3</sup>

Ambient Temperature : 22.3 °C ; Liquid Temperature : 21.1 °C

DASY4 Configuration:

- Probe: EX3DV4 - SN3650; ConvF(4.11, 4.11, 4.11); Calibrated: 2011/10/26
- Sensor-Surface: 2mm (Mechanical Surface Detection)
- Electronics: DAE4 Sn1277; Calibrated: 2011/07/29
- Phantom: SAM Phantom\_Left; Type: SAM V4.0; Serial: TP 1652
- Measurement SW: DASY4, V4.7 Build 80; Postprocessing SW: SEMCAD, V1.8 Build 186

**Ch64/Area Scan (81x121x1):** Measurement grid: dx=10mm, dy=10mm

Maximum value of SAR (interpolated) = 1.74 mW/g

**Ch64/Zoom Scan (7x7x9)/Cube 0:** Measurement grid: dx=4mm, dy=4mm, dz=2.5mm

Reference Value = 19.8 V/m; Power Drift = -0.14 dB

Peak SAR (extrapolated) = 3.75 W/kg

**SAR(1 g) = 1.01 mW/g; SAR(10 g) = 0.289 mW/g**

Maximum value of SAR (measured) = 2.02 mW/g

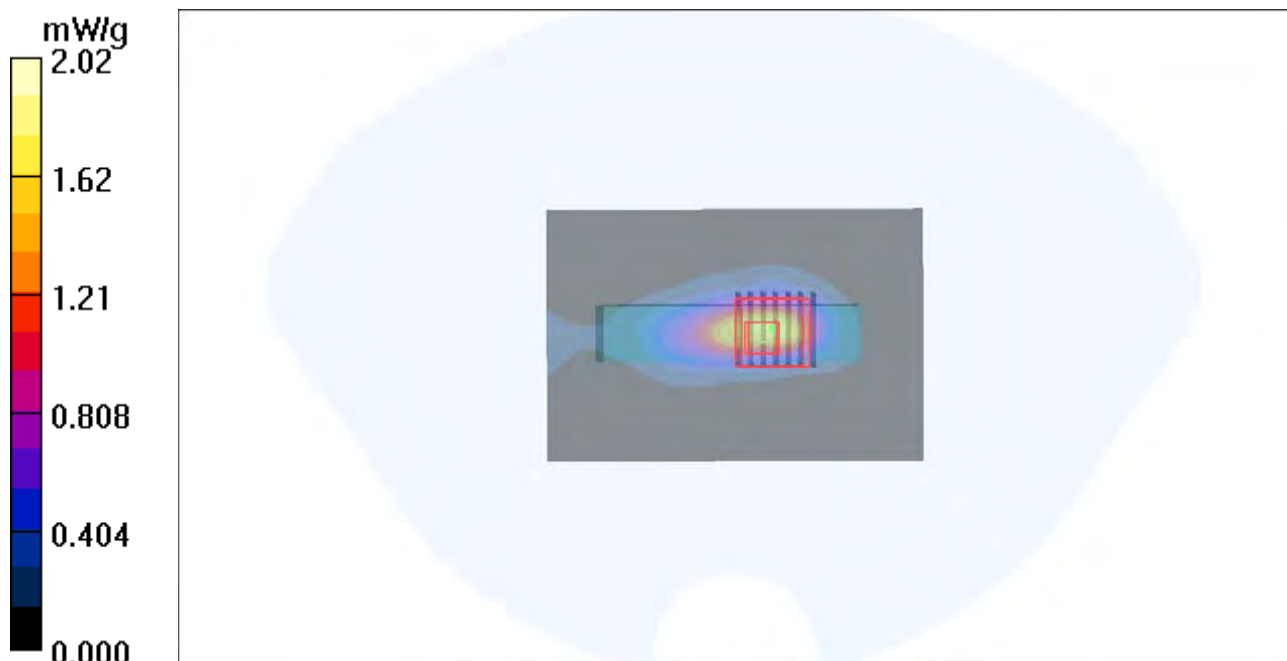

**P71 802.11a\_Verical Back\_0.5cm\_Ch64\_ANT 0**

**DUT: 111122C09**

Communication System: 802.11a; Frequency: 5320 MHz;Duty Cycle: 1:1

Medium: B5G\_1213 Medium parameters used:  $f = 5320$  MHz;  $\sigma = 5.36$  mho/m;  $\epsilon_r = 48$ ;  $\rho = 1000$  kg/m<sup>3</sup>

Ambient Temperature : 22.1 °C ; Liquid Temperature : 21.1 °C

DASY4 Configuration:

- Probe: EX3DV4 - SN3650; ConvF(4.11, 4.11, 4.11); Calibrated: 2011/10/26
- Sensor-Surface: 2mm (Mechanical Surface Detection)
- Electronics: DAE4 Sn1277; Calibrated: 2011/07/29
- Phantom: SAM Phantom\_Left; Type: SAM V4.0; Serial: TP 1652
- Measurement SW: DASY4, V4.7 Build 80; Postprocessing SW: SEMCAD, V1.8 Build 186

**Ch64/Area Scan (101x121x1):** Measurement grid: dx=10mm, dy=10mm

Maximum value of SAR (interpolated) = 0.125 mW/g

**Ch64/Zoom Scan (7x7x9)/Cube 0:** Measurement grid: dx=4mm, dy=4mm, dz=2.5mm

Reference Value = 1.41 V/m; Power Drift = -0.154 dB

Peak SAR (extrapolated) = 0.144 W/kg

**SAR(1 g) = 0.052 mW/g; SAR(10 g) = 0.019 mW/g**

Maximum value of SAR (measured) = 0.114 mW/g

**Ch64/Zoom Scan (7x7x9)/Cube 1:** Measurement grid: dx=4mm, dy=4mm, dz=2.5mm

Reference Value = 1.41 V/m; Power Drift = -0.154 dB

Peak SAR (extrapolated) = 0.341 W/kg

**SAR(1 g) = 0.035 mW/g; SAR(10 g) = 0.016 mW/g**

Maximum value of SAR (measured) = 0.087 mW/g

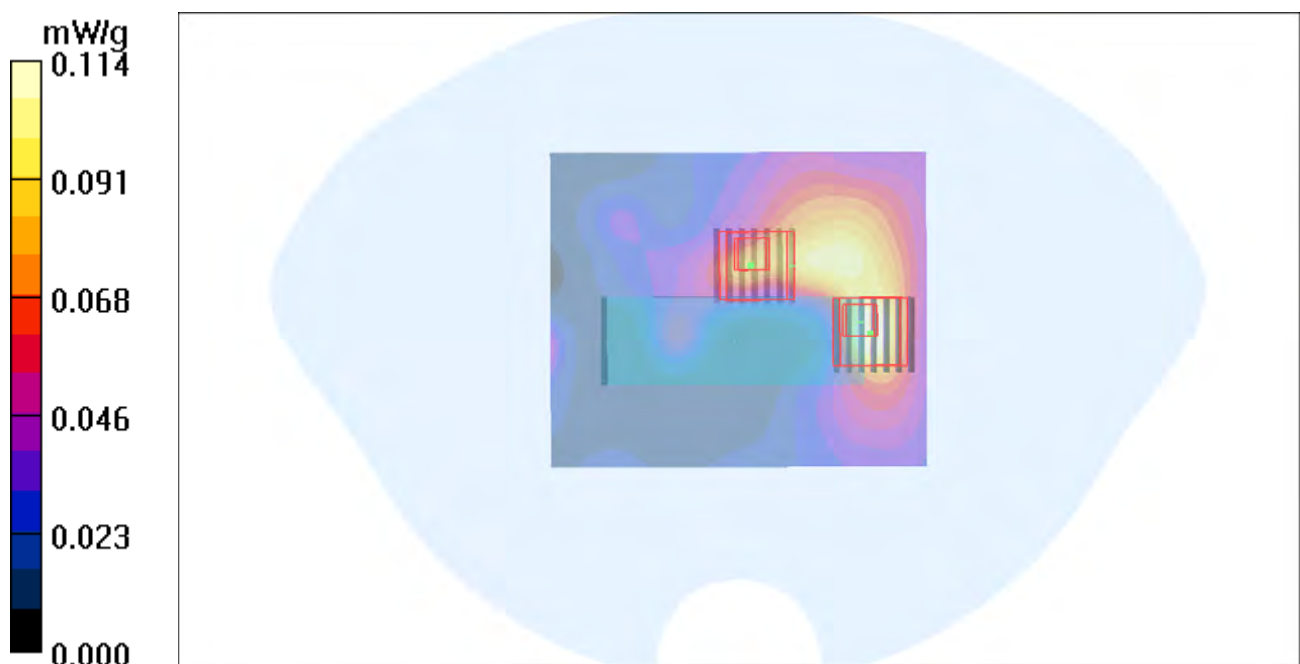

## P72 802.11a\_Tip Mode\_0.5cm\_Ch64\_ANT 0

**DUT: 111122C09**

Communication System: 802.11a; Frequency: 5320 MHz; Duty Cycle: 1:1

Medium: B5G\_1213 Medium parameters used:  $f = 5320$  MHz;  $\sigma = 5.36$  mho/m;  $\epsilon_r = 48$ ;  $\rho = 1000$  kg/m<sup>3</sup>

Ambient Temperature : 22.3 °C ; Liquid Temperature : 21.1 °C

DASY4 Configuration:

- Probe: EX3DV4 - SN3650; ConvF(4.11, 4.11, 4.11); Calibrated: 2011/10/26
- Sensor-Surface: 2mm (Mechanical Surface Detection)
- Electronics: DAE4 Sn1277; Calibrated: 2011/07/29
- Phantom: SAM Phantom\_Left; Type: SAM V4.0; Serial: TP 1652
- Measurement SW: DASY4, V4.7 Build 80; Postprocessing SW: SEMCAD, V1.8 Build 186

**Ch64/Area Scan (81x81x1):** Measurement grid: dx=10mm, dy=10mm

Maximum value of SAR (interpolated) = 0.100 mW/g

**Ch64/Zoom Scan (7x7x9)/Cube 0:** Measurement grid: dx=4mm, dy=4mm, dz=2.5mm

Reference Value = 3.11 V/m; Power Drift = -0.152 dB

Peak SAR (extrapolated) = 0.212 W/kg

**SAR(1 g) = 0.054 mW/g; SAR(10 g) = 0.020 mW/g**

Maximum value of SAR (measured) = 0.109 mW/g

**Ch64/Zoom Scan (7x7x9)/Cube 1:** Measurement grid: dx=4mm, dy=4mm, dz=2.5mm

Reference Value = 3.11 V/m; Power Drift = -0.152 dB

Peak SAR (extrapolated) = 0.301 W/kg

**SAR(1 g) = 0.036 mW/g; SAR(10 g) = 0.013 mW/g**

Maximum value of SAR (measured) = 0.089 mW/g



## P88 802.11a\_Verical Front\_0.5cm\_Ch52\_ANT 0

**DUT: 111122C09**

Communication System: WLAN 5G; Frequency: 5260 MHz; Duty Cycle: 1:1

Medium: B5G\_1221 Medium parameters used:  $f = 5260$  MHz;  $\sigma = 5.329$  mho/m;  $\epsilon_r = 48.215$ ;  $\rho = 1000$  kg/m<sup>3</sup>

Ambient Temperature : 22.4 °C ; Liquid Temperature : 21.4 °C

DASY5 Configuration:

- Probe: EX3DV4 - SN3650; ConvF(4.11, 4.11, 4.11); Calibrated: 2011/10/26
- Sensor-Surface: 2mm (Mechanical Surface Detection)
- Electronics: DAE4 Sn1277; Calibrated: 2011/07/29
- Phantom: SAM Phantom\_Front; Type: SAM; Serial: TP-1485
- Measurement SW: DASY52, Version 52.6 (2); SEMCAD X Version 14.4.5 (3634)

**Ch52/Area Scan (81x121x1):** Measurement grid: dx=10mm, dy=10mm

Maximum value of SAR (interpolated) = 1.741 mW/g

**Ch52/Zoom Scan (7x7x9)/Cube 0:** Measurement grid: dx=4mm, dy=4mm, dz=2.5mm

Reference Value = 12.750 V/m; Power Drift = -0.09 dB

Peak SAR (extrapolated) = 4.077 W/kg

**SAR(1 g) = 1.04 mW/g; SAR(10 g) = 0.259 mW/g**

Maximum value of SAR (measured) = 2.148 mW/g

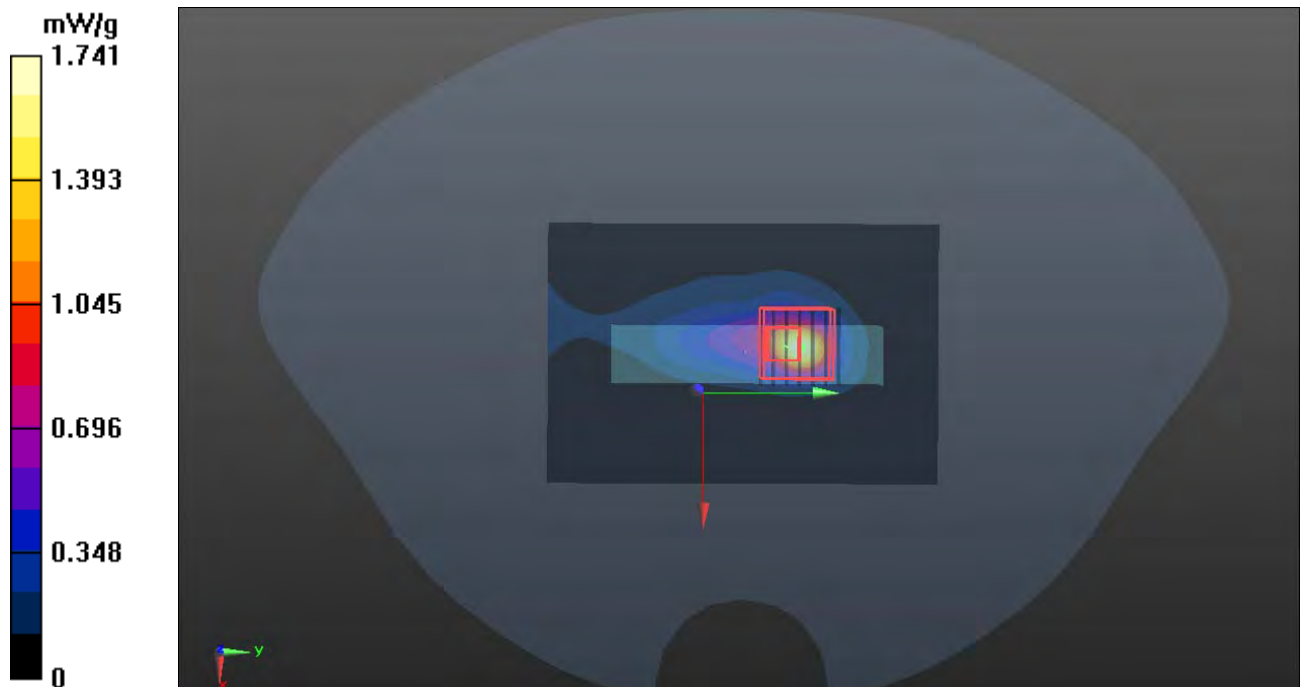



## P109 802.11n\_HT40\_Horizontal Up\_0.5cm\_Ch62\_ANT 0+1+2

**DUT: 111122C09**

Communication System: 802.11aN\_40MHz; Frequency: 5310 MHz; Duty Cycle: 1:1

Medium: B5G\_0206 Medium parameters used:  $f = 5310$  MHz;  $\sigma = 5.34$  mho/m;  $\epsilon_r = 47.6$ ;  $\rho = 1000$  kg/m<sup>3</sup>

Ambient Temperature : 21.6 °C; Liquid Temperature : 20.7 °C

DASY4 Configuration:

- Probe: EX3DV4 - SN3650; ConvF(4.11, 4.11, 4.11); Calibrated: 2011/10/26
- Sensor-Surface: 2mm (Mechanical Surface Detection)
- Electronics: DAE3 Sn579; Calibrated: 2011/09/23
- Phantom: SAM Phantom\_Left; Type: SAM V4.0; Serial: TP 1652
- Measurement SW: DASY4, V4.7 Build 80; Postprocessing SW: SEMCAD, V1.8 Build 186

**Ch62/Area Scan (121x61x1):** Measurement grid: dx=10mm, dy=10mm

Maximum value of SAR (interpolated) = 1.66 mW/g

**Ch62/Zoom Scan (7x7x9)/Cube 0:** Measurement grid: dx=4mm, dy=4mm, dz=2.5mm

Reference Value = 19.6 V/m; Power Drift = -0.17 dB

Peak SAR (extrapolated) = 2.62 W/kg

**SAR(1 g) = 0.753 mW/g; SAR(10 g) = 0.266 mW/g**

Maximum value of SAR (measured) = 1.43 mW/g

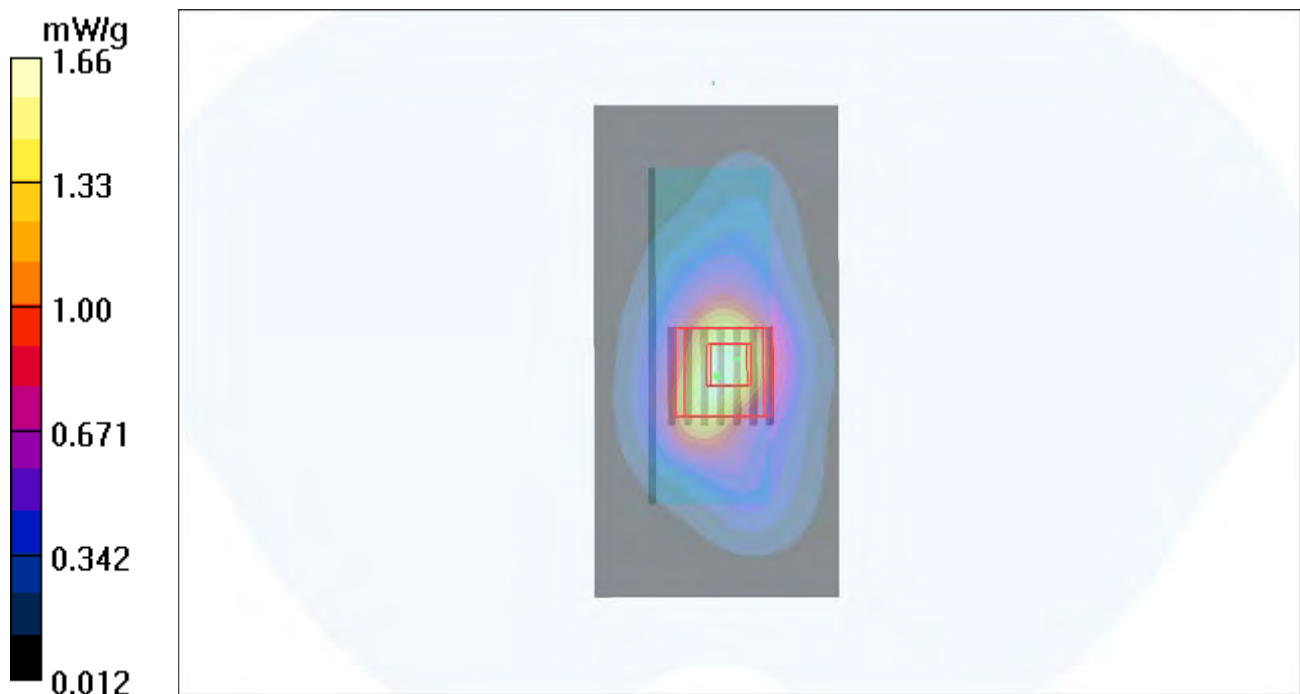

## P110 802.11n\_HT40\_Horizontal\_Down\_0.5cm\_Ch62\_ANT 0+1+2

**DUT: 111122C09**

Communication System: 802.11aN\_40MHz; Frequency: 5310 MHz; Duty Cycle: 1:1

Medium: B5G\_0206 Medium parameters used:  $f = 5310$  MHz;  $\sigma = 5.34$  mho/m;  $\epsilon_r = 47.6$ ;  $\rho = 1000$  kg/m<sup>3</sup>

Ambient Temperature : 21.6 °C; Liquid Temperature : 20.7 °C

DASY4 Configuration:

- Probe: EX3DV4 - SN3650; ConvF(4.11, 4.11, 4.11); Calibrated: 2011/10/26
- Sensor-Surface: 2mm (Mechanical Surface Detection)
- Electronics: DAE3 Sn579; Calibrated: 2011/09/23
- Phantom: SAM Phantom\_Left; Type: SAM V4.0; Serial: TP 1652
- Measurement SW: DASY4, V4.7 Build 80; Postprocessing SW: SEMCAD, V1.8 Build 186

**Ch62/Area Scan (121x61x1):** Measurement grid: dx=10mm, dy=10mm

Maximum value of SAR (interpolated) = 0.434 mW/g

**Ch62/Zoom Scan (7x7x9)/Cube 0:** Measurement grid: dx=4mm, dy=4mm, dz=2.5mm

Reference Value = 8.65 V/m; Power Drift = -0.182 dB

Peak SAR (extrapolated) = 0.840 W/kg

**SAR(1 g) = 0.200 mW/g; SAR(10 g) = 0.069 mW/g**

Maximum value of SAR (measured) = 0.476 mW/g

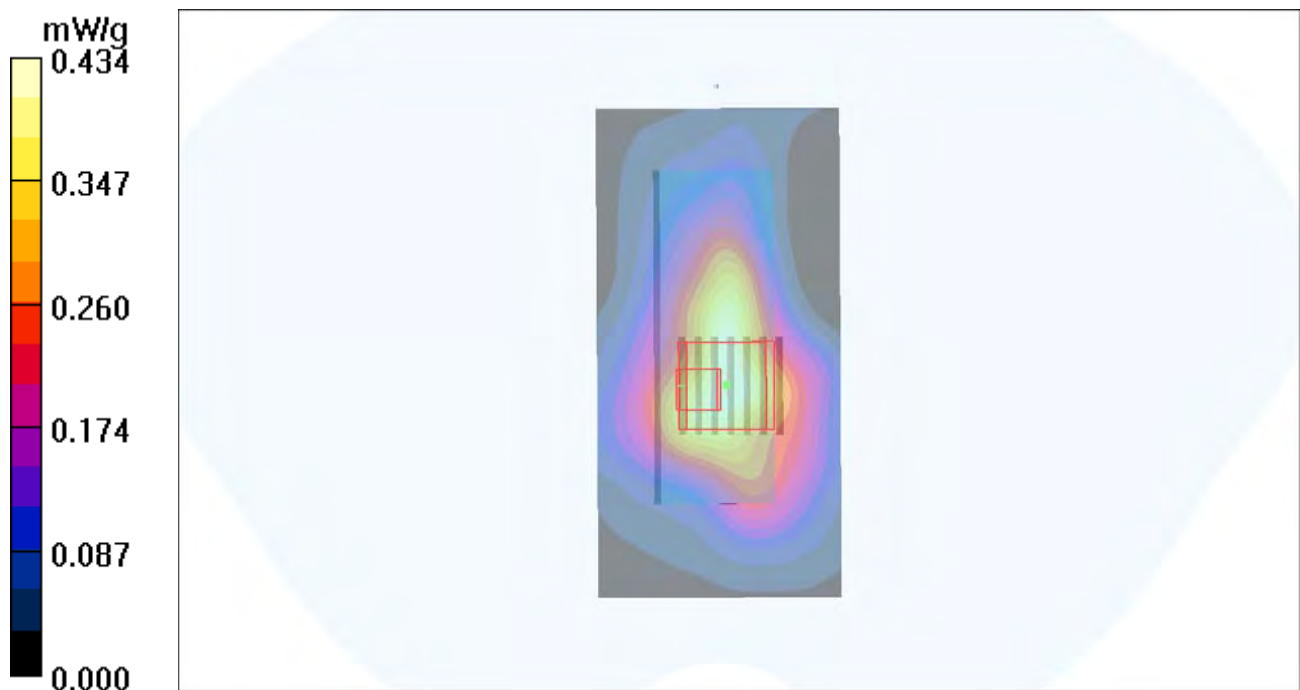

## P29 802.11n\_HT40\_Verical Front\_0.5cm\_Ch62\_ANT 0+1+2

**DUT: 111122C09**

Communication System: 802.11aN\_40MHz; Frequency: 5310 MHz; Duty Cycle: 1:1

Medium: B5G\_1213 Medium parameters used:  $f = 5310$  MHz;  $\sigma = 5.35$  mho/m;  $\epsilon_r = 48$ ;  $\rho = 1000$  kg/m<sup>3</sup>

Ambient Temperature : 22.2 °C ; Liquid Temperature : 21.1 °C

DASY4 Configuration:

- Probe: EX3DV4 - SN3650; ConvF(4.11, 4.11, 4.11); Calibrated: 2011/10/26
- Sensor-Surface: 2mm (Mechanical Surface Detection)
- Electronics: DAE4 Sn1277; Calibrated: 2011/07/29
- Phantom: SAM Phantom\_Left; Type: SAM V4.0; Serial: TP 1652
- Measurement SW: DASY4, V4.7 Build 80; Postprocessing SW: SEMCAD, V1.8 Build 186

**Ch62/Area Scan (81x121x1):** Measurement grid: dx=10mm, dy=10mm

Maximum value of SAR (interpolated) = 0.831 mW/g

**Ch62/Zoom Scan (7x7x9)/Cube 0:** Measurement grid: dx=4mm, dy=4mm, dz=2.5mm

Reference Value = 13.5 V/m; Power Drift = -0.169 dB

Peak SAR (extrapolated) = 2.55 W/kg

**SAR(1 g) = 0.670 mW/g; SAR(10 g) = 0.197 mW/g**

Maximum value of SAR (measured) = 1.40 mW/g

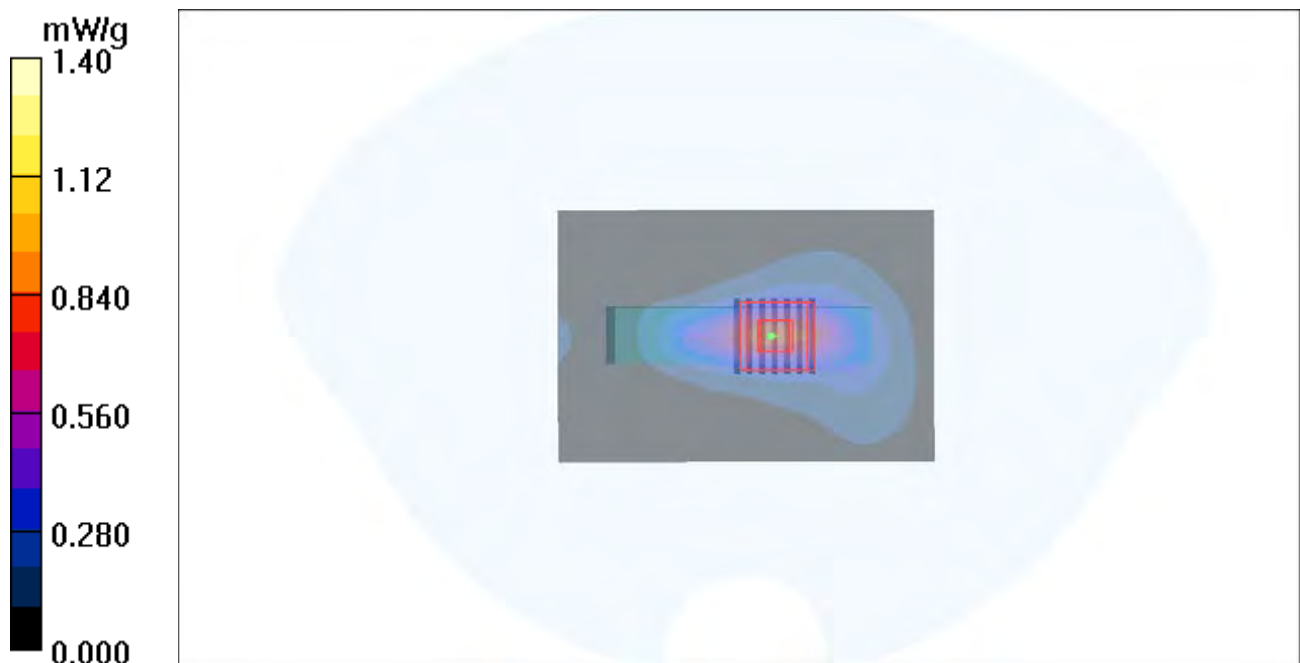

### P111 802.11n\_HT40\_Vertical Back\_0.5cm\_Ch62\_ANT 0+1+2

**DUT: 111122C09**

Communication System: 802.11aN\_40MHz; Frequency: 5310 MHz; Duty Cycle: 1:1

Medium: B5G\_0206 Medium parameters used:  $f = 5310$  MHz;  $\sigma = 5.34$  mho/m;  $\epsilon_r = 47.6$ ;  $\rho = 1000$  kg/m<sup>3</sup>

Ambient Temperature : 21.6 °C; Liquid Temperature : 20.7 °C

DASY4 Configuration:

- Probe: EX3DV4 - SN3650; ConvF(4.11, 4.11, 4.11); Calibrated: 2011/10/26
- Sensor-Surface: 2mm (Mechanical Surface Detection)
- Electronics: DAE3 Sn579; Calibrated: 2011/09/23
- Phantom: SAM Phantom\_Left; Type: SAM V4.0; Serial: TP 1652
- Measurement SW: DASY4, V4.7 Build 80; Postprocessing SW: SEMCAD, V1.8 Build 186

**Ch62/Area Scan (81x121x1):** Measurement grid: dx=10mm, dy=10mm

Maximum value of SAR (interpolated) = 1.38 mW/g

**Ch62/Zoom Scan (7x7x9)/Cube 0:** Measurement grid: dx=4mm, dy=4mm, dz=2.5mm

Reference Value = 18.4 V/m; Power Drift = -0.177 dB

Peak SAR (extrapolated) = 3.12 W/kg

**SAR(1 g) = 0.733 mW/g; SAR(10 g) = 0.198 mW/g**

Maximum value of SAR (measured) = 1.52 mW/g

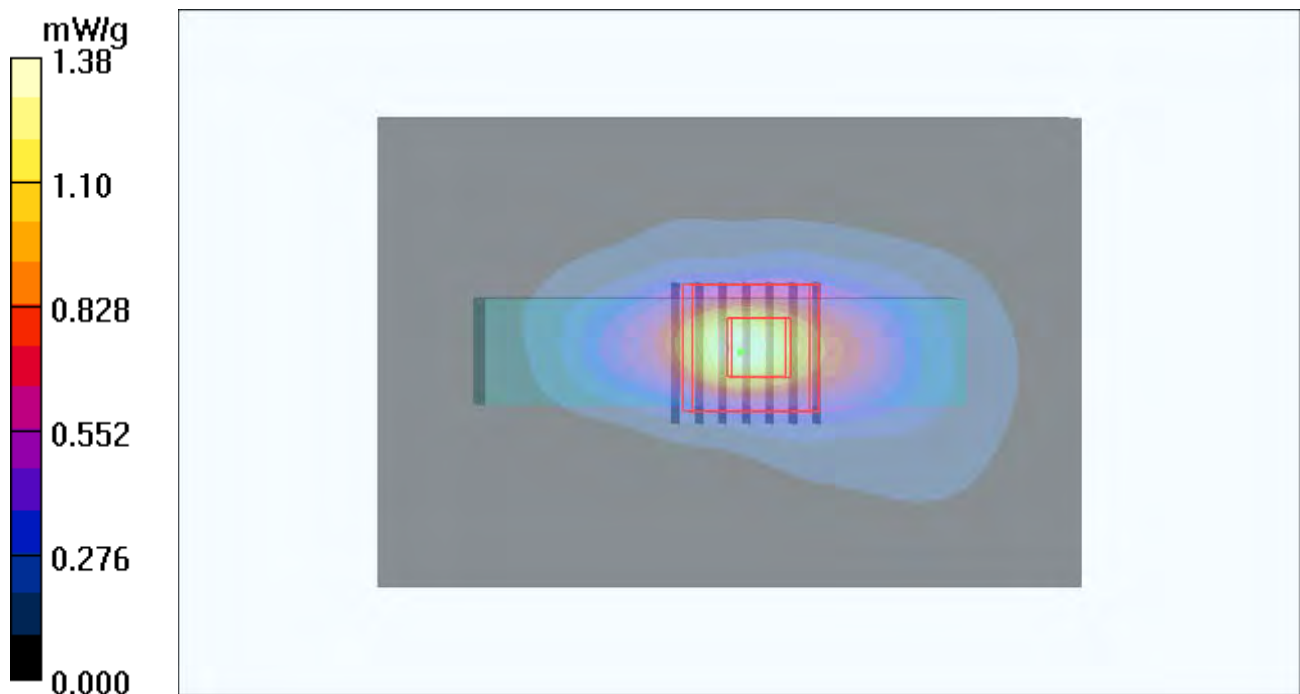

### P112 802.11n\_HT40\_Tip Mode\_0.5cm\_Ch62\_ANT 0+1+2

**DUT: 111122C09**

Communication System: 802.11aN\_40MHz; Frequency: 5310 MHz; Duty Cycle: 1:1

Medium: B5G\_0206 Medium parameters used:  $f = 5310$  MHz;  $\sigma = 5.34$  mho/m;  $\epsilon_r = 47.6$ ;  $\rho = 1000$  kg/m<sup>3</sup>

Ambient Temperature : 21.6 °C ; Liquid Temperature : 20.7 °C

DASY4 Configuration:

- Probe: EX3DV4 - SN3650; ConvF(4.11, 4.11, 4.11); Calibrated: 2011/10/26
- Sensor-Surface: 2mm (Mechanical Surface Detection)
- Electronics: DAE3 Sn579; Calibrated: 2011/09/23
- Phantom: SAM Phantom\_Left; Type: SAM V4.0; Serial: TP 1652
- Measurement SW: DASY4, V4.7 Build 80; Postprocessing SW: SEMCAD, V1.8 Build 186

**Ch62/Area Scan (81x81x1):** Measurement grid: dx=10mm, dy=10mm

Maximum value of SAR (interpolated) = 0.109 mW/g

**Ch62/Zoom Scan (7x7x9)/Cube 0:** Measurement grid: dx=4mm, dy=4mm, dz=2.5mm

Reference Value = 5.13 V/m; Power Drift = -0.149 dB

Peak SAR (extrapolated) = 0.218 W/kg

**SAR(1 g) = 0.057 mW/g; SAR(10 g) = 0.023 mW/g**

Maximum value of SAR (measured) = 0.111 mW/g

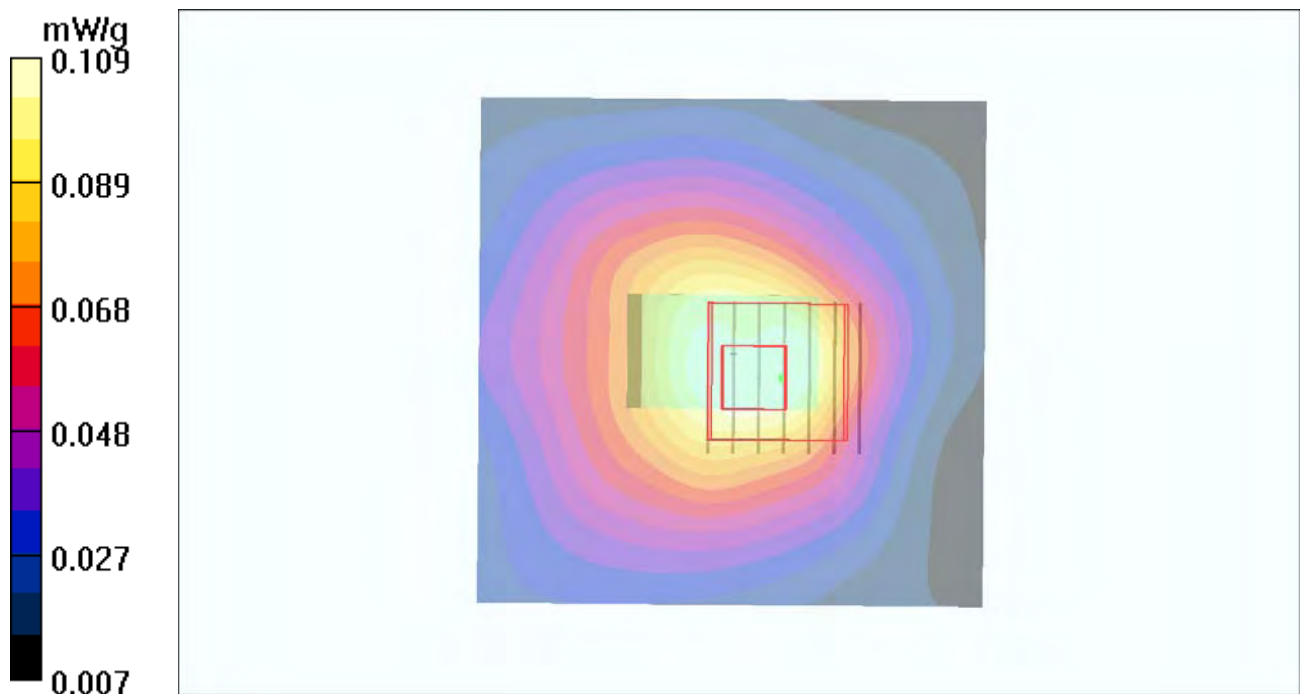

### P73 802.11a\_Horizontal Up\_0.5cm\_Ch100\_ANT 0

**DUT: 111122C09**

Communication System: 802.11a; Frequency: 5500 MHz; Duty Cycle: 1:1

Medium: B5G\_1213 Medium parameters used:  $f = 5500$  MHz;  $\sigma = 5.68$  mho/m;  $\epsilon_r = 47.8$ ;  $\rho = 1000$  kg/m<sup>3</sup>

Ambient Temperature : 22.2 °C ; Liquid Temperature : 21.1 °C

DASY4 Configuration:

- Probe: EX3DV4 - SN3650; ConvF(3.73, 3.73, 3.73); Calibrated: 2011/10/26
- Sensor-Surface: 2mm (Mechanical Surface Detection)
- Electronics: DAE4 Sn1277; Calibrated: 2011/07/29
- Phantom: SAM Phantom\_Left; Type: SAM V4.0; Serial: TP 1652
- Measurement SW: DASY4, V4.7 Build 80; Postprocessing SW: SEMCAD, V1.8 Build 186

**Ch100/Area Scan (121x61x1):** Measurement grid: dx=10mm, dy=10mm

Maximum value of SAR (interpolated) = 0.798 mW/g

**Ch100/Zoom Scan (7x7x9)/Cube 0:** Measurement grid: dx=4mm, dy=4mm, dz=2.5mm

Reference Value = 13.3 V/m; Power Drift = -0.104 dB

Peak SAR (extrapolated) = 1.43 W/kg

**SAR(1 g) = 0.389 mW/g; SAR(10 g) = 0.132 mW/g**

Maximum value of SAR (measured) = 0.817 mW/g

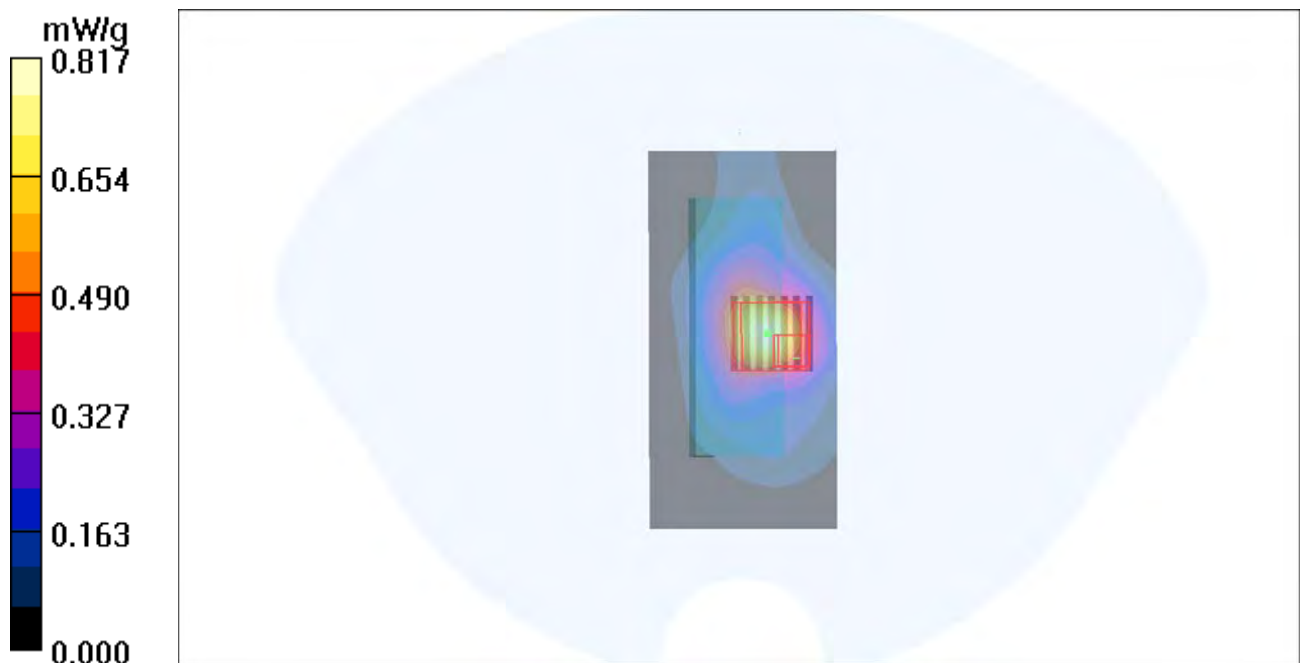

### P74 802.11a\_Horizontal Down\_0.5cm\_Ch100\_ANT 0

**DUT: 111122C09**

Communication System: 802.11a; Frequency: 5500 MHz; Duty Cycle: 1:1

Medium: B5G\_1213 Medium parameters used:  $f = 5500$  MHz;  $\sigma = 5.68$  mho/m;  $\epsilon_r = 47.8$ ;  $\rho = 1000$  kg/m<sup>3</sup>

Ambient Temperature : 22.1 °C ; Liquid Temperature : 21.1 °C

DASY4 Configuration:

- Probe: EX3DV4 - SN3650; ConvF(3.73, 3.73, 3.73); Calibrated: 2011/10/26
- Sensor-Surface: 2mm (Mechanical Surface Detection)
- Electronics: DAE4 Sn1277; Calibrated: 2011/07/29
- Phantom: SAM Phantom\_Left; Type: SAM V4.0; Serial: TP 1652
- Measurement SW: DASY4, V4.7 Build 80; Postprocessing SW: SEMCAD, V1.8 Build 186

**Ch100/Area Scan (121x61x1):** Measurement grid: dx=10mm, dy=10mm

Maximum value of SAR (interpolated) = 0.233 mW/g

**Ch100/Zoom Scan (7x7x9)/Cube 0:** Measurement grid: dx=4mm, dy=4mm, dz=2.5mm

Reference Value = 5.33 V/m; Power Drift = -0.127 dB

Peak SAR (extrapolated) = 0.612 W/kg

**SAR(1 g) = 0.160 mW/g; SAR(10 g) = 0.045 mW/g**

Maximum value of SAR (measured) = 0.347 mW/g

**Ch100/Zoom Scan (7x7x9)/Cube 1:** Measurement grid: dx=4mm, dy=4mm, dz=2.5mm

Reference Value = 5.33 V/m; Power Drift = -0.127 dB

Peak SAR (extrapolated) = 0.459 W/kg

**SAR(1 g) = 0.070 mW/g; SAR(10 g) = 0.024 mW/g**

Maximum value of SAR (measured) = 0.165 mW/g

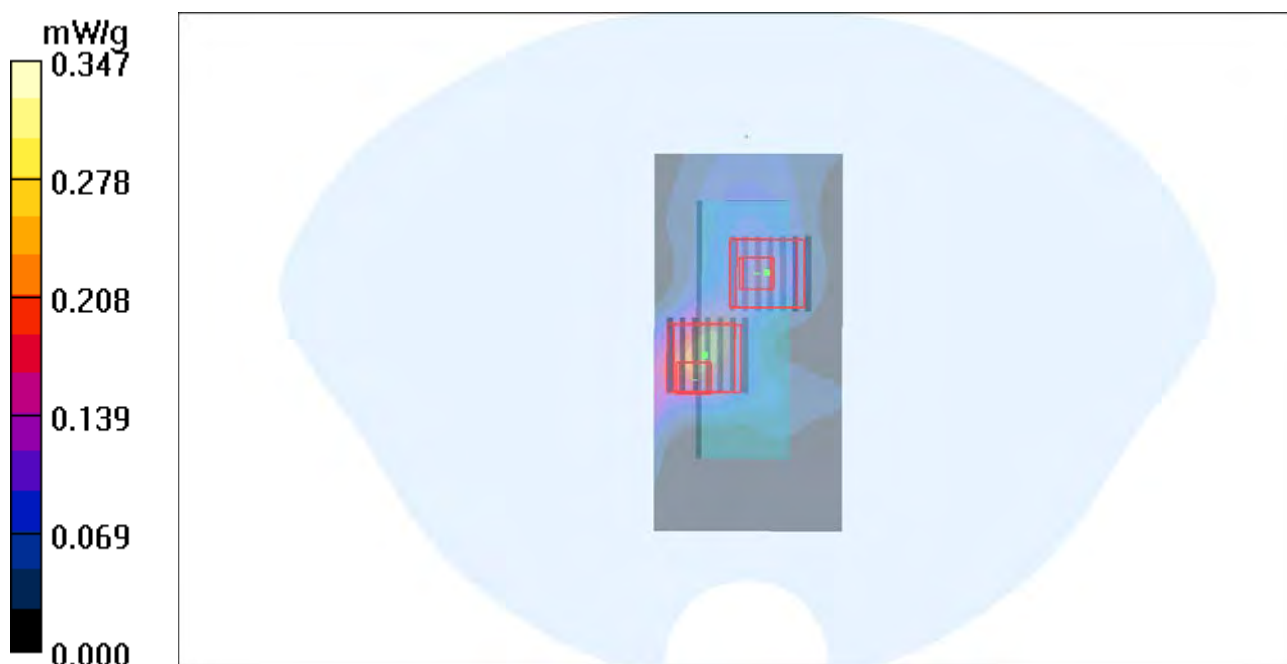

### P63 802.11a\_Vertical Front\_0.5cm\_Ch100\_ANT 0

**DUT: 111122C09**

Communication System: 802.11a; Frequency: 5500 MHz; Duty Cycle: 1:1

Medium: B5G\_1213 Medium parameters used:  $f = 5500$  MHz;  $\sigma = 5.68$  mho/m;  $\epsilon_r = 47.8$ ;  $\rho = 1000$  kg/m<sup>3</sup>

Ambient Temperature : 22.2 °C; Liquid Temperature : 21.1 °C

DASY4 Configuration:

- Probe: EX3DV4 - SN3650; ConvF(3.73, 3.73, 3.73); Calibrated: 2011/10/26
- Sensor-Surface: 2mm (Mechanical Surface Detection)
- Electronics: DAE4 Sn1277; Calibrated: 2011/07/29
- Phantom: SAM Phantom\_Left; Type: SAM V4.0; Serial: TP 1652
- Measurement SW: DASY4, V4.7 Build 80; Postprocessing SW: SEMCAD, V1.8 Build 186

**Ch100/Area Scan (81x121x1):** Measurement grid: dx=10mm, dy=10mm

Maximum value of SAR (interpolated) = 2.42 mW/g

**Ch100/Zoom Scan (7x7x9)/Cube 0:** Measurement grid: dx=4mm, dy=4mm, dz=2.5mm

Reference Value = 20.3 V/m; Power Drift = -0.12 dB

Peak SAR (extrapolated) = 4.16 W/kg

**SAR(1 g) = 1.11 mW/g; SAR(10 g) = 0.317 mW/g**

Maximum value of SAR (measured) = 2.16 mW/g

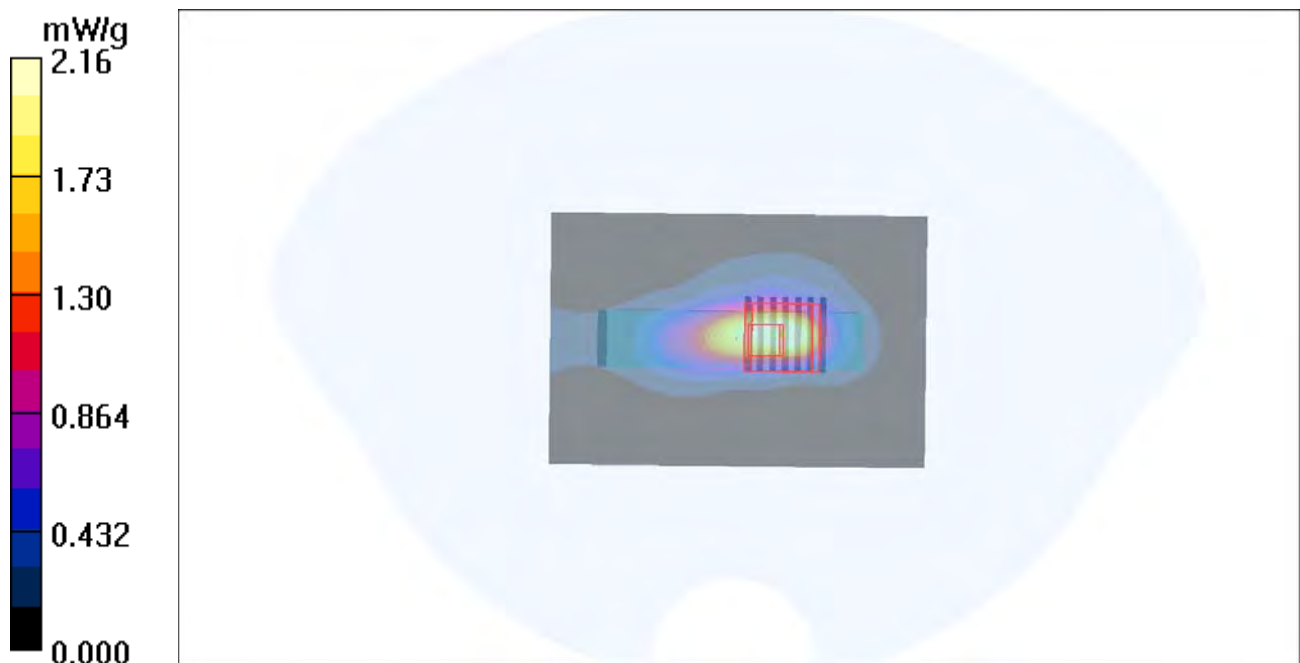



# 1g/10g Averaged SAR

SAR; Zoom Scan: Value Along Z, X=3, Y=2

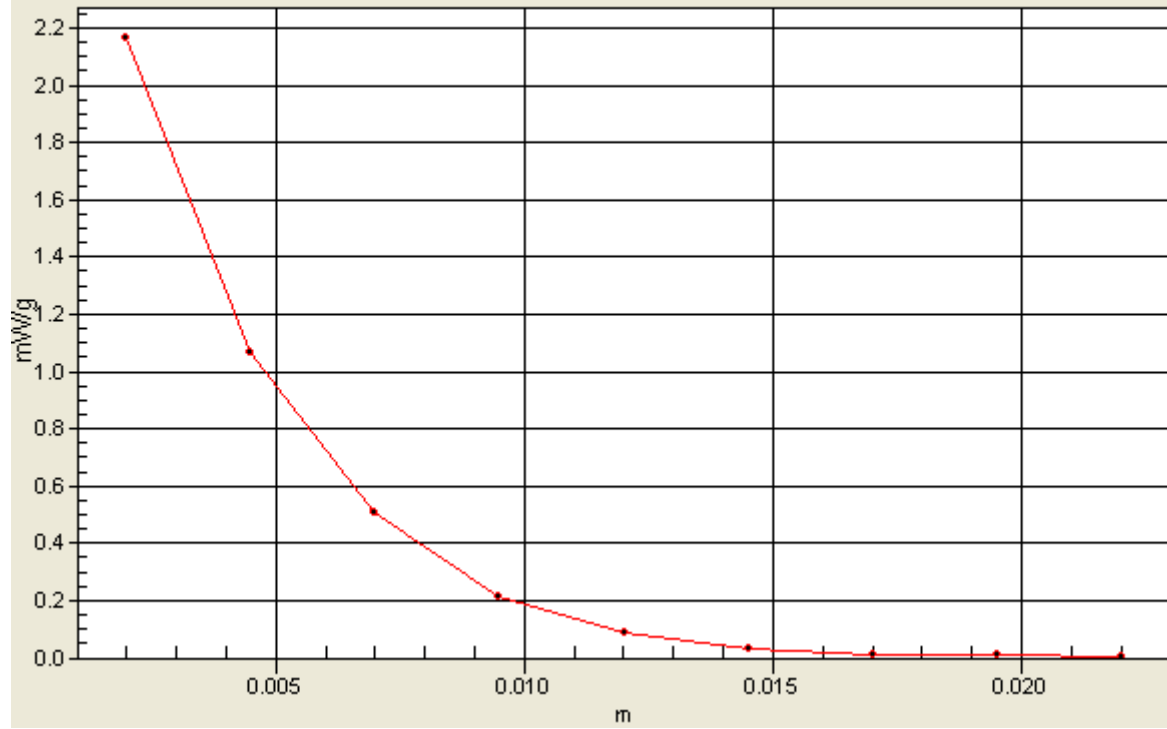

## P76 802.11a\_Verical Back\_0.5cm\_Ch100\_ANT 0

**DUT: 111122C09**

Communication System: 802.11a; Frequency: 5500 MHz; Duty Cycle: 1:1

Medium: B5G\_1213 Medium parameters used:  $f = 5500$  MHz;  $\sigma = 5.68$  mho/m;  $\epsilon_r = 47.8$ ;  $\rho = 1000$  kg/m<sup>3</sup>

Ambient Temperature : 22.2 °C ; Liquid Temperature : 21.1 °C

DASY4 Configuration:

- Probe: EX3DV4 - SN3650; ConvF(3.73, 3.73, 3.73); Calibrated: 2011/10/26
- Sensor-Surface: 2mm (Mechanical Surface Detection)
- Electronics: DAE4 Sn1277; Calibrated: 2011/07/29
- Phantom: SAM Phantom\_Left; Type: SAM V4.0; Serial: TP 1652
- Measurement SW: DASY4, V4.7 Build 80; Postprocessing SW: SEMCAD, V1.8 Build 186

**Ch100/Area Scan (101x121x1):** Measurement grid: dx=10mm, dy=10mm

Maximum value of SAR (interpolated) = 0.130 mW/g

**Ch100/Zoom Scan (7x7x9)/Cube 0:** Measurement grid: dx=4mm, dy=4mm, dz=2.5mm

Reference Value = 1.84 V/m; Power Drift = -0.143 dB

Peak SAR (extrapolated) = 0.539 W/kg

**SAR(1 g) = 0.072 mW/g; SAR(10 g) = 0.024 mW/g**

Maximum value of SAR (measured) = 0.146 mW/g

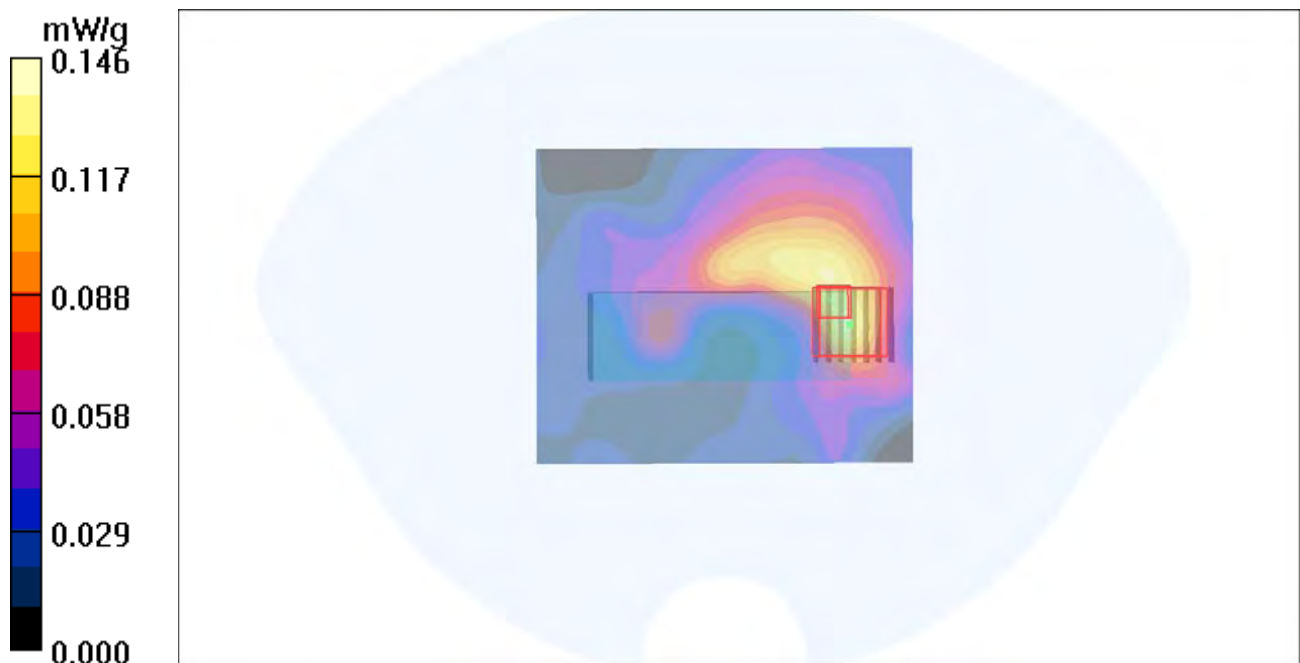

**P77 802.11a\_Tip Mode\_0.5cm\_Ch100\_ANT 0**

**DUT: 111122C09**

Communication System: 802.11a; Frequency: 5500 MHz; Duty Cycle: 1:1

Medium: B5G\_1213 Medium parameters used:  $f = 5500$  MHz;  $\sigma = 5.68$  mho/m;  $\epsilon_r = 47.8$ ;  $\rho = 1000$  kg/m<sup>3</sup>

Ambient Temperature : 22.3 °C ; Liquid Temperature : 21.1 °C

DASY4 Configuration:

- Probe: EX3DV4 - SN3650; ConvF(3.73, 3.73, 3.73); Calibrated: 2011/10/26
- Sensor-Surface: 2mm (Mechanical Surface Detection)
- Electronics: DAE4 Sn1277; Calibrated: 2011/07/29
- Phantom: SAM Phantom\_Left; Type: SAM V4.0; Serial: TP 1652
- Measurement SW: DASY4, V4.7 Build 80; Postprocessing SW: SEMCAD, V1.8 Build 186

**Ch100/Area Scan (81x81x1):** Measurement grid: dx=10mm, dy=10mm

Maximum value of SAR (interpolated) = 0.094 mW/g

**Ch100/Zoom Scan (7x7x9)/Cube 0:** Measurement grid: dx=4mm, dy=4mm, dz=2.5mm

Reference Value = 3.23 V/m; Power Drift = -0.155 dB

Peak SAR (extrapolated) = 0.119 W/kg

**SAR(1 g) = 0.041 mW/g; SAR(10 g) = 0.016 mW/g**

Maximum value of SAR (measured) = 0.110 mW/g

**Ch100/Zoom Scan (7x7x9)/Cube 1:** Measurement grid: dx=4mm, dy=4mm, dz=2.5mm

Reference Value = 3.23 V/m; Power Drift = -0.155 dB

Peak SAR (extrapolated) = 0.301 W/kg

**SAR(1 g) = 0.037 mW/g; SAR(10 g) = 0.014 mW/g**

Maximum value of SAR (measured) = 0.089 mW/g



## P65 802.11a\_Vertical Front\_0.5cm\_Ch116\_ANT 0

**DUT: 111122C09**

Communication System: 802.11a; Frequency: 5580 MHz; Duty Cycle: 1:1

Medium: B5G\_1213 Medium parameters used:  $f = 5580$  MHz;  $\sigma = 5.79$  mho/m;  $\epsilon_r = 47.3$ ;  $\rho = 1000$  kg/m<sup>3</sup>

Ambient Temperature : 22.2 °C; Liquid Temperature : 21.1 °C

DASY4 Configuration:

- Probe: EX3DV4 - SN3650; ConvF(3.57, 3.57, 3.57); Calibrated: 2011/10/26
- Sensor-Surface: 2mm (Mechanical Surface Detection)
- Electronics: DAE4 Sn1277; Calibrated: 2011/07/29
- Phantom: SAM Phantom\_Left; Type: SAM V4.0; Serial: TP 1652
- Measurement SW: DASY4, V4.7 Build 80; Postprocessing SW: SEMCAD, V1.8 Build 186

**Ch116/Area Scan (81x121x1):** Measurement grid: dx=10mm, dy=10mm

Maximum value of SAR (interpolated) = 2.69 mW/g

**Ch116/Zoom Scan (7x7x9)/Cube 0:** Measurement grid: dx=4mm, dy=4mm, dz=2.5mm

Reference Value = 21.9 V/m; Power Drift = -0.19 dB

Peak SAR (extrapolated) = 4.00 W/kg

**SAR(1 g) = 1.04 mW/g; SAR(10 g) = 0.296 mW/g**

Maximum value of SAR (measured) = 2.03 mW/g

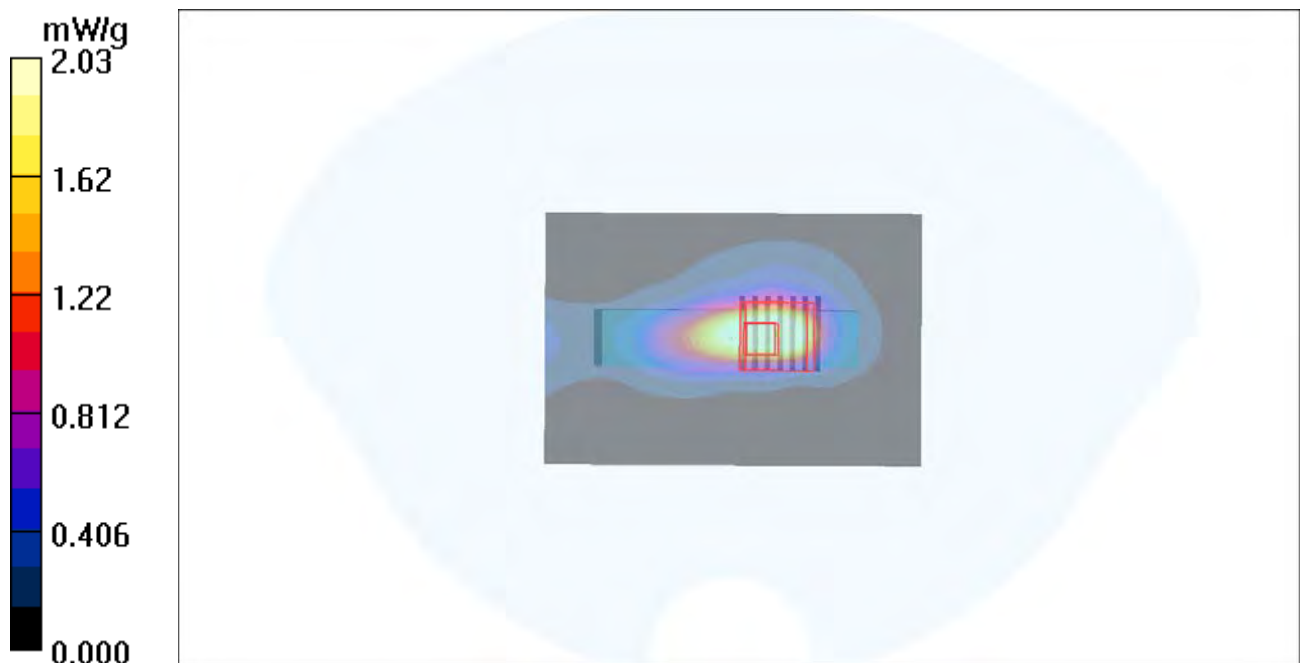

### P89 802.11a\_Vertical Front\_0.5cm\_Ch132\_ANT 0

**DUT: 111122C09**

Communication System: WLAN 5G; Frequency: 5660 MHz; Duty Cycle: 1:1

Medium: B5G\_1221 Medium parameters used:  $f = 5660$  MHz;  $\sigma = 5.98$  mho/m;  $\epsilon_r = 47.471$ ;  $\rho = 1000$  kg/m<sup>3</sup>

Ambient Temperature : 22.5 °C ; Liquid Temperature : 21.4 °C

DASY5 Configuration:

- Probe: EX3DV4 - SN3650; ConvF(3.57, 3.57, 3.57); Calibrated: 2011/10/26
- Sensor-Surface: 2mm (Mechanical Surface Detection)
- Electronics: DAE4 Sn1277; Calibrated: 2011/07/29
- Phantom: SAM Phantom\_Front; Type: SAM; Serial: TP-1485
- Measurement SW: DASY52, Version 52.6 (2); SEMCAD X Version 14.4.5 (3634)

**Ch132/Area Scan (81x121x1):** Measurement grid: dx=10mm, dy=10mm

Maximum value of SAR (interpolated) = 1.201 mW/g

**Ch132/Zoom Scan (7x7x9)/Cube 0:** Measurement grid: dx=4mm, dy=4mm, dz=2.5mm

Reference Value = 11.405 V/m; Power Drift = -0.14 dB

Peak SAR (extrapolated) = 3.581 W/kg

**SAR(1 g) = 0.887 mW/g; SAR(10 g) = 0.239 mW/g**

Maximum value of SAR (measured) = 1.976 mW/g

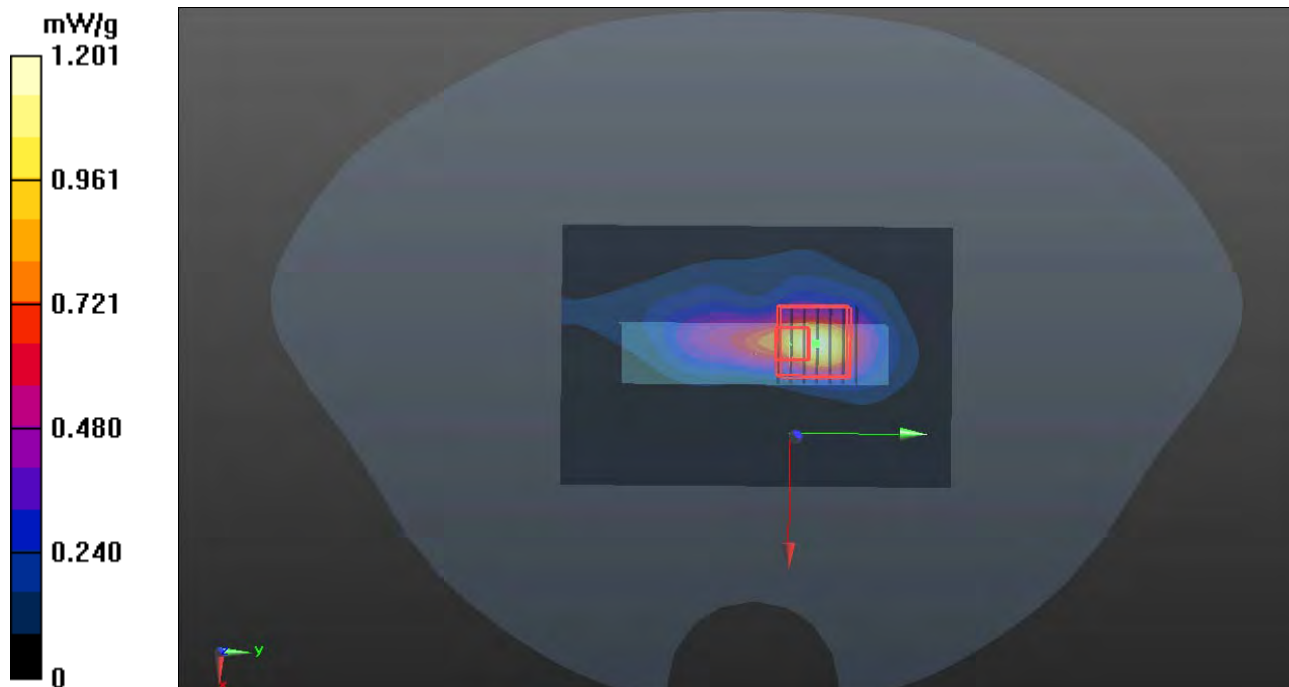

### P123 802.11n\_HT40\_Horizontal Up\_0.5cm\_Ch102\_ANT 0+1+2

**DUT: 111122C09**

Communication System: 802.11aN\_40MHz; Frequency: 5510 MHz; Duty Cycle: 1:1

Medium: B5G\_0206 Medium parameters used:  $f = 5510$  MHz;  $\sigma = 5.68$  mho/m;  $\epsilon_r = 47.4$ ;  $\rho = 1000$  kg/m<sup>3</sup>

Ambient Temperature : 21.5 °C; Liquid Temperature : 20.7 °C

DASY4 Configuration:

- Probe: EX3DV4 - SN3650; ConvF(3.73, 3.73, 3.73); Calibrated: 2011/10/26
- Sensor-Surface: 2mm (Mechanical Surface Detection)
- Electronics: DAE3 Sn579; Calibrated: 2011/09/23
- Phantom: SAM Phantom\_Left; Type: SAM V4.0; Serial: TP 1652
- Measurement SW: DASY4, V4.7 Build 80; Postprocessing SW: SEMCAD, V1.8 Build 186

**Ch102/Area Scan (121x61x1):** Measurement grid: dx=10mm, dy=10mm

Maximum value of SAR (interpolated) = 0.973 mW/g

**Ch102/Zoom Scan (7x7x9)/Cube 0:** Measurement grid: dx=4mm, dy=4mm, dz=2.5mm

Reference Value = 14.7 V/m; Power Drift = -0.124 dB

Peak SAR (extrapolated) = 1.79 W/kg

**SAR(1 g) = 0.494 mW/g; SAR(10 g) = 0.173 mW/g**

Maximum value of SAR (measured) = 0.984 mW/g

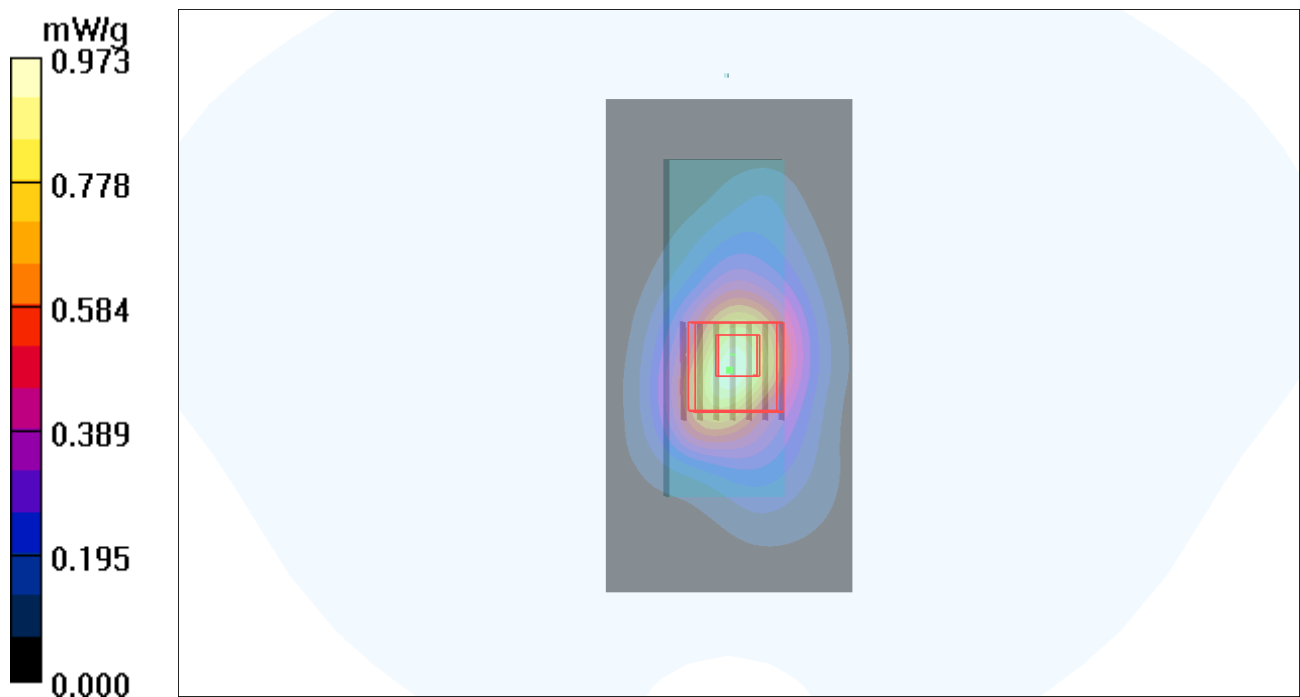

### P124 802.11n\_HT40\_Horizontal\_Down\_0.5cm\_Ch102\_ANT 0+1+2

**DUT: 111122C09**

Communication System: 802.11aN\_40MHz; Frequency: 5510 MHz; Duty Cycle: 1:1

Medium: B5G\_0206 Medium parameters used:  $f = 5510$  MHz;  $\sigma = 5.68$  mho/m;  $\epsilon_r = 47.4$ ;  $\rho = 1000$  kg/m<sup>3</sup>

Ambient Temperature : 21.6 °C; Liquid Temperature : 20.7 °C

DASY4 Configuration:

- Probe: EX3DV4 - SN3650; ConvF(3.73, 3.73, 3.73); Calibrated: 2011/10/26
- Sensor-Surface: 2mm (Mechanical Surface Detection)
- Electronics: DAE3 Sn579; Calibrated: 2011/09/23
- Phantom: SAM Phantom\_Left; Type: SAM V4.0; Serial: TP 1652
- Measurement SW: DASY4, V4.7 Build 80; Postprocessing SW: SEMCAD, V1.8 Build 186

**Ch102/Area Scan (121x61x1):** Measurement grid: dx=10mm, dy=10mm

Maximum value of SAR (interpolated) = 0.272 mW/g

**Ch102/Zoom Scan (7x7x9)/Cube 0:** Measurement grid: dx=4mm, dy=4mm, dz=2.5mm

Reference Value = 7.17 V/m; Power Drift = -0.16 dB

Peak SAR (extrapolated) = 0.471 W/kg

**SAR(1 g) = 0.109 mW/g; SAR(10 g) = 0.041 mW/g**

Maximum value of SAR (measured) = 0.271 mW/g

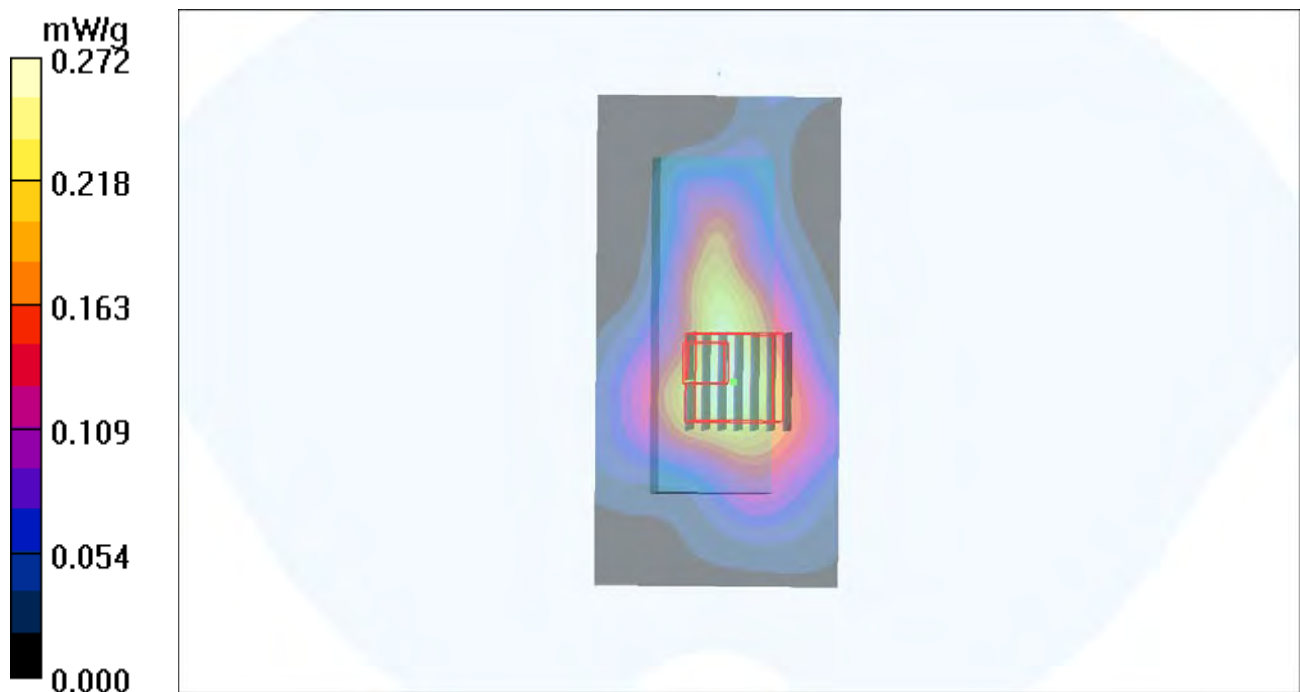

## P42 802.11n\_HT40\_Vertical Front\_0.5cm\_Ch102\_ANT 0+1+2

**DUT: 111122C09**

Communication System: 802.11aN\_40MHz; Frequency: 5510 MHz; Duty Cycle: 1:1

Medium: B5G\_1213 Medium parameters used:  $f = 5510$  MHz;  $\sigma = 5.69$  mho/m;  $\epsilon_r = 47.8$ ;  $\rho = 1000$  kg/m<sup>3</sup>

Ambient Temperature : 22.3 °C ; Liquid Temperature : 21.1 °C

DASY4 Configuration:

- Probe: EX3DV4 - SN3650; ConvF(3.73, 3.73, 3.73); Calibrated: 2011/10/26
- Sensor-Surface: 2mm (Mechanical Surface Detection)
- Electronics: DAE4 Sn1277; Calibrated: 2011/07/29
- Phantom: SAM Phantom\_Left; Type: SAM V4.0; Serial: TP 1652
- Measurement SW: DASY4, V4.7 Build 80; Postprocessing SW: SEMCAD, V1.8 Build 186

**Ch102/Area Scan (81x121x1):** Measurement grid: dx=10mm, dy=10mm

Maximum value of SAR (interpolated) = 0.757 mW/g

**Ch102/Zoom Scan (7x7x9)/Cube 0:** Measurement grid: dx=4mm, dy=4mm, dz=2.5mm

Reference Value = 11.7 V/m; Power Drift = -0.181 dB

Peak SAR (extrapolated) = 1.96 W/kg

**SAR(1 g) = 0.485 mW/g; SAR(10 g) = 0.149 mW/g**

Maximum value of SAR (measured) = 1.07 mW/g

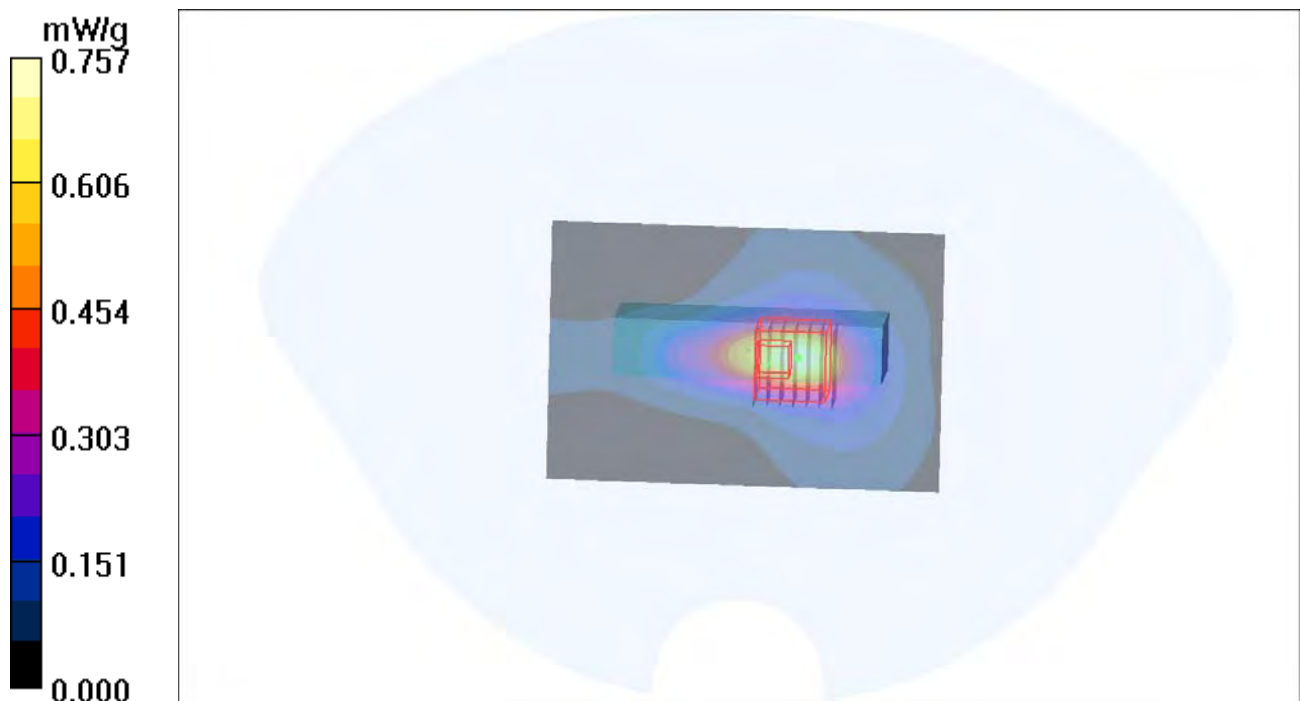



### P125 802.11n\_HT40\_Vertical Back\_0.5cm\_Ch102\_ANT 0+1+2

**DUT: 111122C09**

Communication System: 802.11aN\_40MHz; Frequency: 5510 MHz; Duty Cycle: 1:1

Medium: B5G\_0206 Medium parameters used:  $f = 5510$  MHz;  $\sigma = 5.68$  mho/m;  $\epsilon_r = 47.4$ ;  $\rho = 1000$  kg/m<sup>3</sup>

Ambient Temperature : 21.6 °C ; Liquid Temperature : 20.7 °C

DASY4 Configuration:

- Probe: EX3DV4 - SN3650; ConvF(3.73, 3.73, 3.73); Calibrated: 2011/10/26
- Sensor-Surface: 2mm (Mechanical Surface Detection)
- Electronics: DAE3 Sn579; Calibrated: 2011/09/23
- Phantom: SAM Phantom\_Left; Type: SAM V4.0; Serial: TP 1652
- Measurement SW: DASY4, V4.7 Build 80; Postprocessing SW: SEMCAD, V1.8 Build 186

**Ch62/Area Scan (81x121x1):** Measurement grid: dx=10mm, dy=10mm

Maximum value of SAR (interpolated) = 0.789 mW/g

**Ch62/Zoom Scan (7x7x9)/Cube 0:** Measurement grid: dx=4mm, dy=4mm, dz=2.5mm

Reference Value = 13.2 V/m; Power Drift = -0.105 dB

Peak SAR (extrapolated) = 1.81 W/kg

**SAR(1 g) = 0.431 mW/g; SAR(10 g) = 0.119 mW/g**

Maximum value of SAR (measured) = 0.920 mW/g

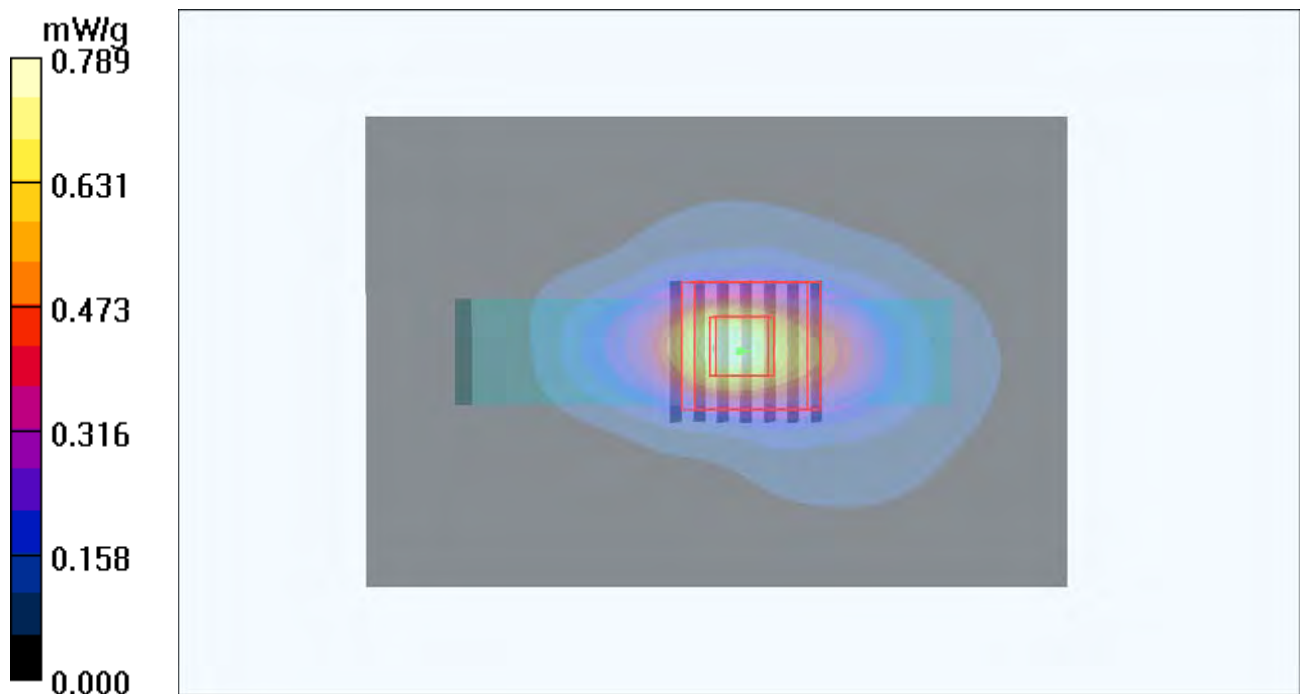

## P126 802.11n\_HT40\_Tip Mode\_0.5cm\_Ch102\_ANT 0+1+2

**DUT: 111122C09**

Communication System: 802.11aN\_40MHz; Frequency: 5510 MHz; Duty Cycle: 1:1

Medium: B5G\_0206 Medium parameters used:  $f = 5510$  MHz;  $\sigma = 5.68$  mho/m;  $\epsilon_r = 47.4$ ;  $\rho = 1000$  kg/m<sup>3</sup>

Ambient Temperature : 21.7 °C; Liquid Temperature : 20.7 °C

DASY4 Configuration:

- Probe: EX3DV4 - SN3650; ConvF(3.73, 3.73, 3.73); Calibrated: 2011/10/26
- Sensor-Surface: 2mm (Mechanical Surface Detection)
- Electronics: DAE3 Sn579; Calibrated: 2011/09/23
- Phantom: SAM Phantom\_Left; Type: SAM V4.0; Serial: TP 1652
- Measurement SW: DASY4, V4.7 Build 80; Postprocessing SW: SEMCAD, V1.8 Build 186

**Ch102/Area Scan (81x81x1):** Measurement grid: dx=10mm, dy=10mm

Maximum value of SAR (interpolated) = 0.067 mW/g

**Ch102/Zoom Scan (7x7x9)/Cube 0:** Measurement grid: dx=4mm, dy=4mm, dz=2.5mm

Reference Value = 3.82 V/m; Power Drift = -0.129 dB

Peak SAR (extrapolated) = 0.151 W/kg

**SAR(1 g) = 0.034 mW/g; SAR(10 g) = 0.012 mW/g**

Maximum value of SAR (measured) = 0.078 mW/g

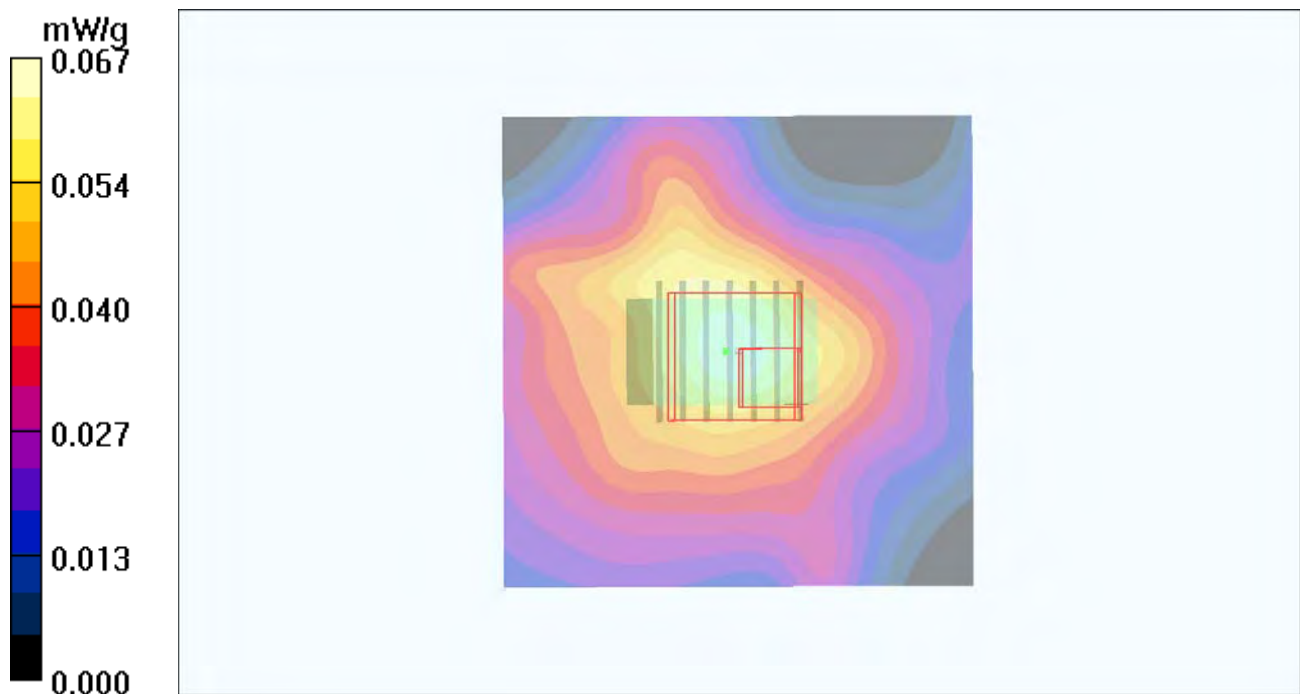

## P45 802.11a\_Horizontal Up\_0.5cm\_Ch149\_ANT 0

**DUT: 111122C09**

Communication System: 802.11a; Frequency: 5745 MHz; Duty Cycle: 1:1

Medium: B5G\_1206 Medium parameters used:  $f = 5745$  MHz;  $\sigma = 6.24$  mho/m;  $\epsilon_r = 46.6$ ;  $\rho = 1000$  kg/m<sup>3</sup>

Ambient Temperature : 22.5 °C ; Liquid Temperature : 21.3 °C

DASY4 Configuration:

- Probe: EX3DV4 - SN3650; ConvF(3.81, 3.81, 3.81); Calibrated: 2011/10/26
- Sensor-Surface: 2mm (Mechanical Surface Detection)
- Electronics: DAE4 Sn1277; Calibrated: 2011/07/29
- Phantom: Flat Phantom ELI4.0; Type: QDOVA001BA; Serial: SN:1039
- Measurement SW: DASY4, V4.7 Build 80; Postprocessing SW: SEMCAD, V1.8 Build 186

**Ch149/Area Scan (141x61x1):** Measurement grid: dx=10mm, dy=10mm

Maximum value of SAR (interpolated) = 0.610 mW/g

**Ch149/Zoom Scan (7x7x9)/Cube 0:** Measurement grid: dx=4mm, dy=4mm, dz=2.5mm

Reference Value = 7.84 V/m; Power Drift = -0.151 dB

Peak SAR (extrapolated) = 1.50 W/kg

**SAR(1 g) = 0.387 mW/g; SAR(10 g) = 0.101 mW/g**

Maximum value of SAR (measured) = 0.881 mW/g

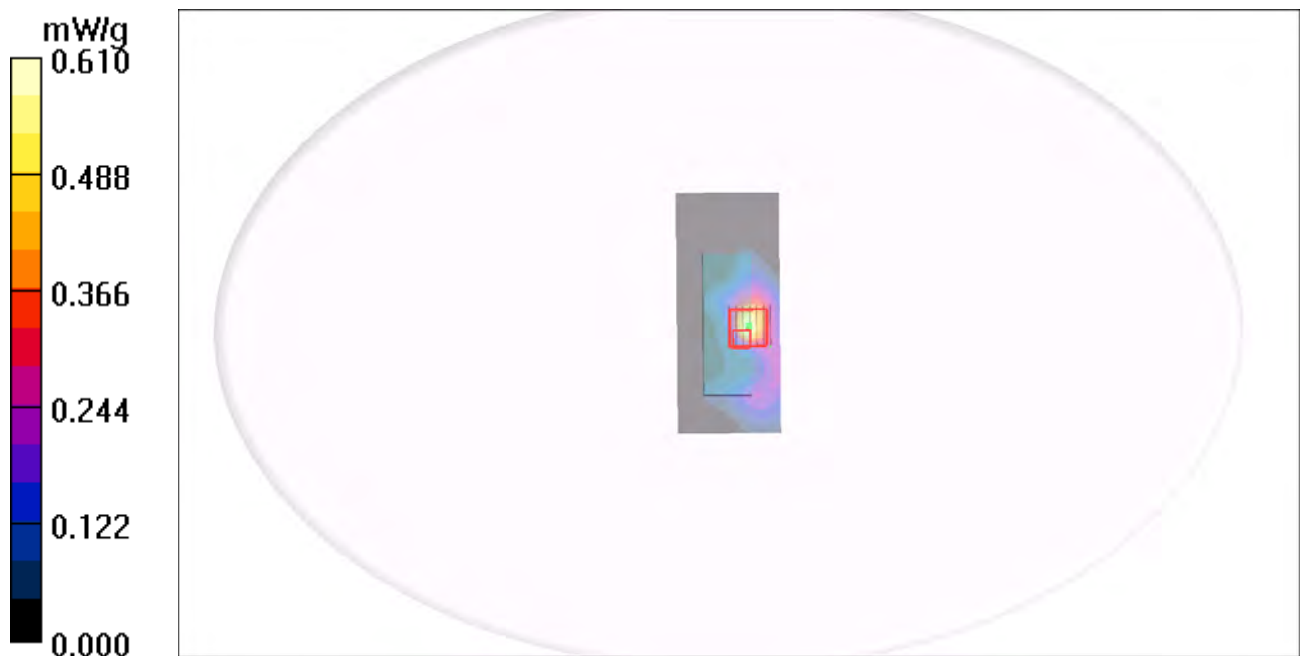

## P46 802.11a\_Horizontal Down\_0.5cm\_Ch149\_ANT 0

**DUT: 111122C09**

Communication System: 802.11a; Frequency: 5745 MHz; Duty Cycle: 1:1

Medium: B5G\_1206 Medium parameters used:  $f = 5745$  MHz;  $\sigma = 6.24$  mho/m;  $\epsilon_r = 46.6$ ;  $\rho = 1000$  kg/m<sup>3</sup>

Ambient Temperature : 22.4 °C ; Liquid Temperature : 21.3 °C

DASY4 Configuration:

- Probe: EX3DV4 - SN3650; ConvF(3.81, 3.81, 3.81); Calibrated: 2011/10/26
- Sensor-Surface: 2mm (Mechanical Surface Detection)
- Electronics: DAE4 Sn1277; Calibrated: 2011/07/29
- Phantom: Flat Phantom ELI4.0; Type: QDOVA001BA; Serial: SN:1039
- Measurement SW: DASY4, V4.7 Build 80; Postprocessing SW: SEMCAD, V1.8 Build 186

**Ch149/Area Scan (141x61x1):** Measurement grid: dx=10mm, dy=10mm

Maximum value of SAR (interpolated) = 0.346 mW/g

**Ch149/Zoom Scan (7x7x9)/Cube 0:** Measurement grid: dx=4mm, dy=4mm, dz=2.5mm

Reference Value = 5.74 V/m; Power Drift = -0.03 dB

Peak SAR (extrapolated) = 0.686 W/kg

**SAR(1 g) = 0.173 mW/g; SAR(10 g) = 0.052 mW/g**

Maximum value of SAR (measured) = 0.386 mW/g

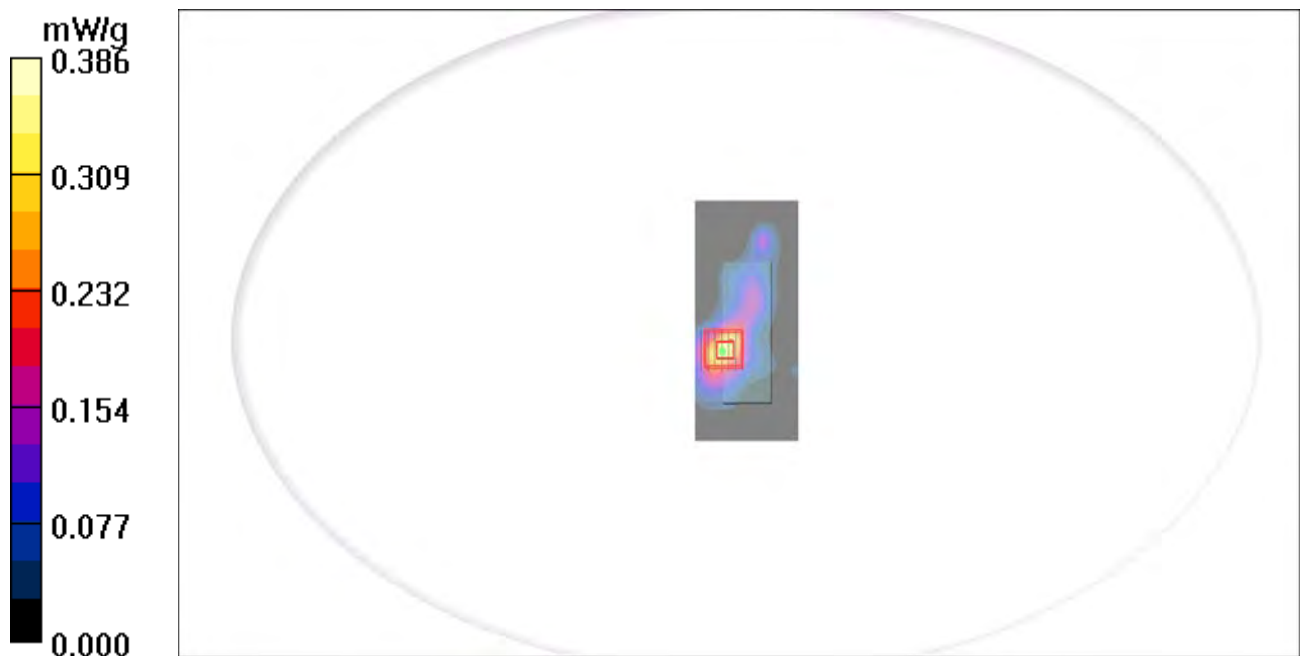

## P47 802.11a\_Vertical Front\_0.5cm\_Ch149\_ANT 0

**DUT: 111122C09**

Communication System: 802.11a; Frequency: 5745 MHz; Duty Cycle: 1:1

Medium: B5G\_1206 Medium parameters used:  $f = 5745$  MHz;  $\sigma = 6.24$  mho/m;  $\epsilon_r = 46.6$ ;  $\rho = 1000$  kg/m<sup>3</sup>

Ambient Temperature : 22.4 °C ; Liquid Temperature : 21.3 °C

DASY4 Configuration:

- Probe: EX3DV4 - SN3650; ConvF(3.81, 3.81, 3.81); Calibrated: 2011/10/26
- Sensor-Surface: 2mm (Mechanical Surface Detection)
- Electronics: DAE4 Sn1277; Calibrated: 2011/07/29
- Phantom: Flat Phantom ELI4.0; Type: QDOVA001BA; Serial: SN:1039
- Measurement SW: DASY4, V4.7 Build 80; Postprocessing SW: SEMCAD, V1.8 Build 186

**Ch149/Area Scan (61x141x1):** Measurement grid: dx=10mm, dy=10mm

Maximum value of SAR (interpolated) = 0.926 mW/g

**Ch149/Zoom Scan (7x7x9)/Cube 0:** Measurement grid: dx=4mm, dy=4mm, dz=2.5mm

Reference Value = 17.8 V/m; Power Drift = -0.043 dB

Peak SAR (extrapolated) = 3.72 W/kg

**SAR(1 g) = 0.890 mW/g; SAR(10 g) = 0.256 mW/g**

Maximum value of SAR (measured) = 1.95 mW/g

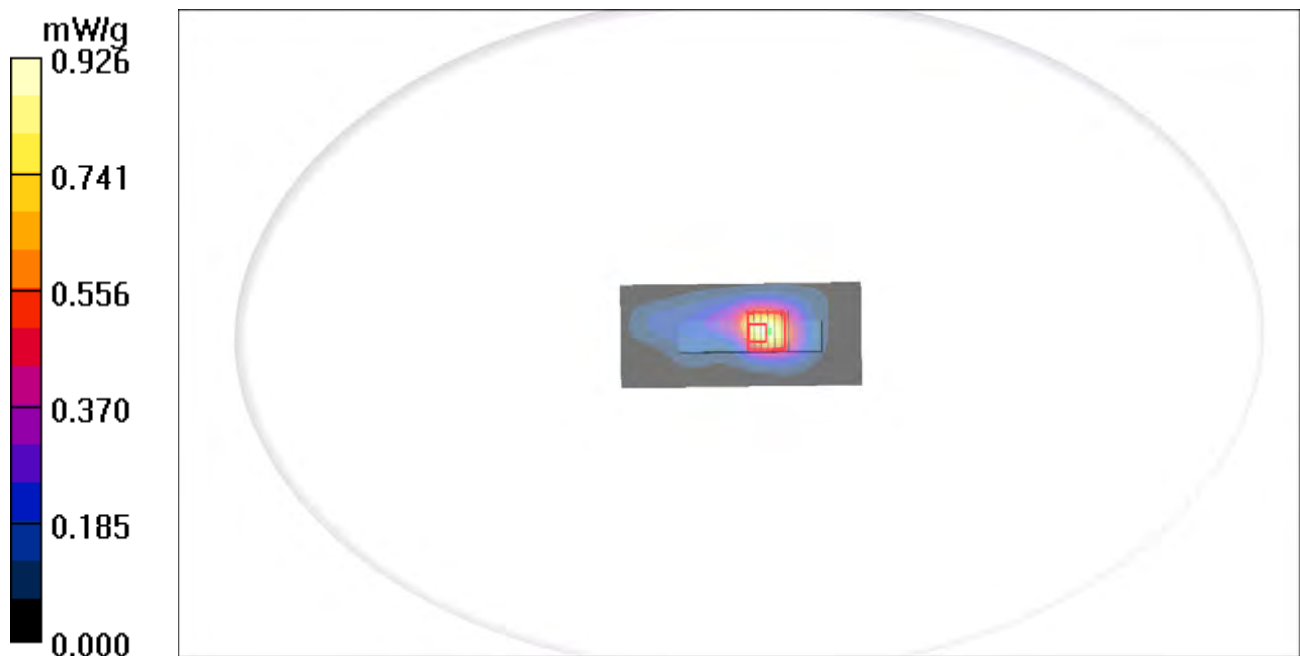

## P48 802.11a\_Verical Back\_0.5cm\_Ch149\_ANT 0

**DUT: 111122C09**

Communication System: 802.11a; Frequency: 5745 MHz; Duty Cycle: 1:1

Medium: B5G\_1206 Medium parameters used:  $f = 5745$  MHz;  $\sigma = 6.24$  mho/m;  $\epsilon_r = 46.6$ ;  $\rho = 1000$  kg/m<sup>3</sup>

Ambient Temperature : 22.4 °C; Liquid Temperature : 21.3 °C

DASY4 Configuration:

- Probe: EX3DV4 - SN3650; ConvF(3.81, 3.81, 3.81); Calibrated: 2011/10/26
- Sensor-Surface: 2mm (Mechanical Surface Detection)
- Electronics: DAE4 Sn1277; Calibrated: 2011/07/29
- Phantom: Flat Phantom ELI4.0; Type: QDOVA001BA; Serial: SN:1039
- Measurement SW: DASY4, V4.7 Build 80; Postprocessing SW: SEMCAD, V1.8 Build 186

**Ch149/Area Scan (61x181x1):** Measurement grid: dx=10mm, dy=10mm

Maximum value of SAR (interpolated) = 0.257 mW/g

**Ch149/Zoom Scan (7x7x9)/Cube 0:** Measurement grid: dx=4mm, dy=4mm, dz=2.5mm

Reference Value = 0.885 V/m; Power Drift = -0.10 dB

Peak SAR (extrapolated) = 0.427 W/kg

**SAR(1 g) = 0.111 mW/g; SAR(10 g) = 0.037 mW/g**

Maximum value of SAR (measured) = 0.246 mW/g



## P49 802.11a\_Tip Mode\_0.5cm\_Ch149\_ANT 0

**DUT: 111122C09**

Communication System: 802.11a; Frequency: 5745 MHz; Duty Cycle: 1:1

Medium: B5G\_1206 Medium parameters used:  $f = 5745$  MHz;  $\sigma = 6.24$  mho/m;  $\epsilon_r = 46.6$ ;  $\rho = 1000$  kg/m<sup>3</sup>

Ambient Temperature : 22.4 °C ; Liquid Temperature : 21.3 °C

DASY4 Configuration:

- Probe: EX3DV4 - SN3650; ConvF(3.81, 3.81, 3.81); Calibrated: 2011/10/26
- Sensor-Surface: 2mm (Mechanical Surface Detection)
- Electronics: DAE4 Sn1277; Calibrated: 2011/07/29
- Phantom: Flat Phantom ELI4.0; Type: QDOVA001BA; Serial: SN:1039
- Measurement SW: DASY4, V4.7 Build 80; Postprocessing SW: SEMCAD, V1.8 Build 186

**Ch149/Area Scan (61x81x1):** Measurement grid: dx=10mm, dy=10mm

Maximum value of SAR (interpolated) = 0.170 mW/g

**Ch149/Zoom Scan (7x7x9)/Cube 0:** Measurement grid: dx=4mm, dy=4mm, dz=2.5mm

Reference Value = 3.30 V/m; Power Drift = -0.12 dB

Peak SAR (extrapolated) = 0.525 W/kg

**SAR(1 g) = 0.076 mW/g; SAR(10 g) = 0.030 mW/g**

Maximum value of SAR (measured) = 0.179 mW/g

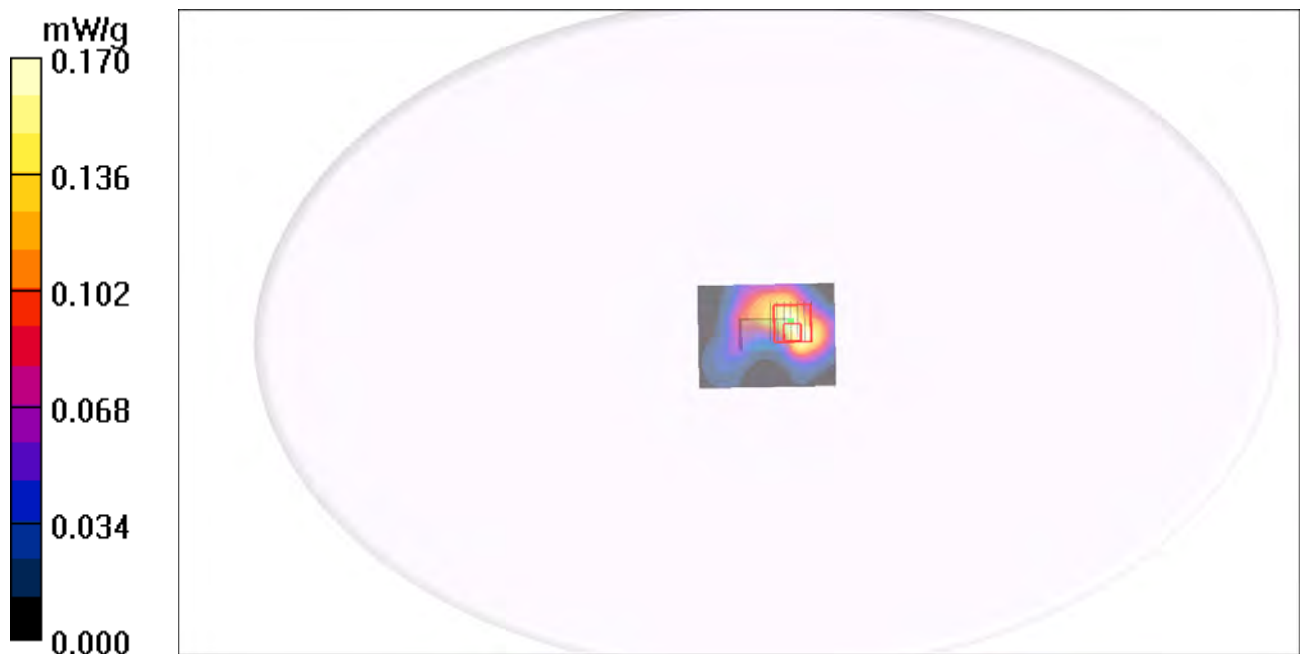

## P50 802.11a\_Vertical Front\_0.5cm\_Ch157\_ANT 0

**DUT: 111122C09**

Communication System: 802.11a; Frequency: 5785 MHz; Duty Cycle: 1:1

Medium: B5G\_1213 Medium parameters used:  $f = 5785$  MHz;  $\sigma = 6.27$  mho/m;  $\epsilon_r = 47.2$ ;  $\rho = 1000$  kg/m<sup>3</sup>

Ambient Temperature : 22.3 °C; Liquid Temperature : 21.1 °C

DASY4 Configuration:

- Probe: EX3DV4 - SN3650; ConvF(3.81, 3.81, 3.81); Calibrated: 2011/10/26
- Sensor-Surface: 2mm (Mechanical Surface Detection)
- Electronics: DAE4 Sn1277; Calibrated: 2011/07/29
- Phantom: SAM Phantom\_Left; Type: SAM V4.0; Serial: TP 1652
- Measurement SW: DASY4, V4.7 Build 80; Postprocessing SW: SEMCAD, V1.8 Build 186

**Ch157/Area Scan (81x121x1):** Measurement grid: dx=10mm, dy=10mm

Maximum value of SAR (interpolated) = 1.13 mW/g

**Ch157/Zoom Scan (7x7x9)/Cube 0:** Measurement grid: dx=4mm, dy=4mm, dz=2.5mm

Reference Value = 12.8 V/m; Power Drift = 0.151 dB

Peak SAR (extrapolated) = 3.16 W/kg

**SAR(1 g) = 0.765 mW/g; SAR(10 g) = 0.220 mW/g**

Maximum value of SAR (measured) = 1.64 mW/g

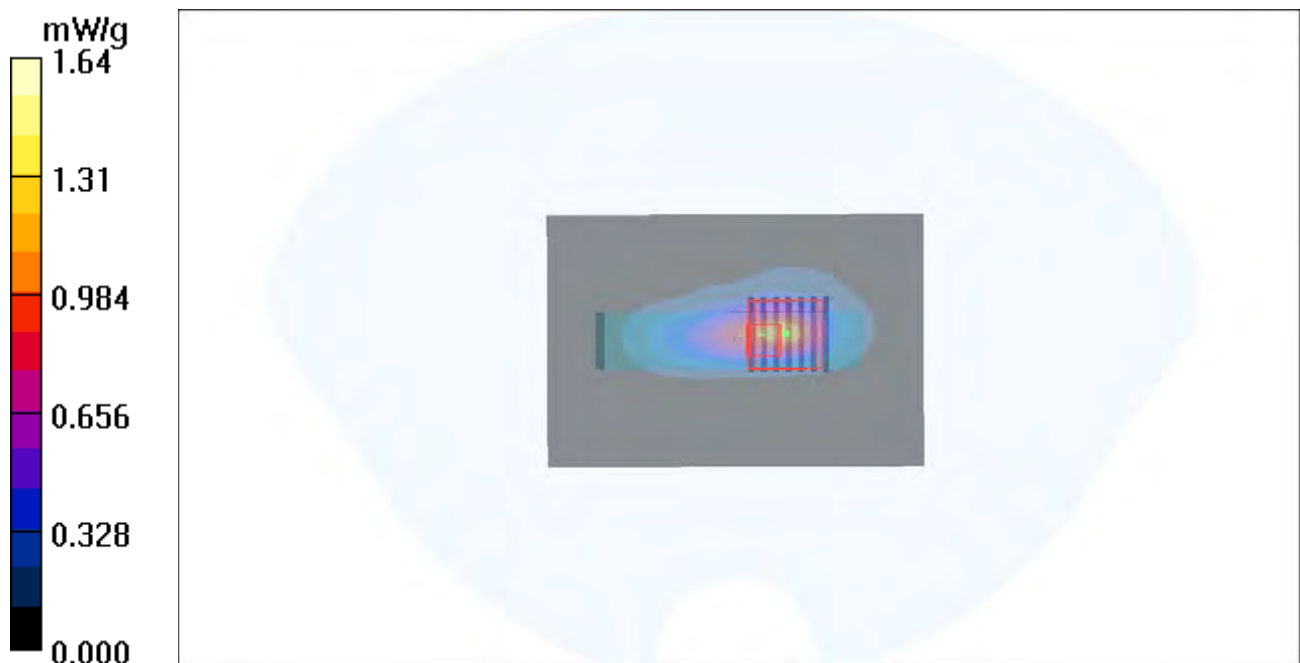



## P51 802.11a\_Verical Front\_0.5cm\_Ch161\_ANT 0

**DUT: 111122C09**

Communication System: 802.11a; Frequency: 5805 MHz; Duty Cycle: 1:1

Medium: B5G\_1213 Medium parameters used:  $f = 5805$  MHz;  $\sigma = 6.26$  mho/m;  $\epsilon_r = 47$ ;  $\rho = 1000$  kg/m<sup>3</sup>

Ambient Temperature : 22.3 °C; Liquid Temperature : 21.1 °C

DASY4 Configuration:

- Probe: EX3DV4 - SN3650; ConvF(3.81, 3.81, 3.81); Calibrated: 2011/10/26
- Sensor-Surface: 2mm (Mechanical Surface Detection)
- Electronics: DAE4 Sn1277; Calibrated: 2011/07/29
- Phantom: SAM Phantom\_Left; Type: SAM V4.0; Serial: TP 1652
- Measurement SW: DASY4, V4.7 Build 80; Postprocessing SW: SEMCAD, V1.8 Build 186

**Ch161/Area Scan (81x121x1):** Measurement grid: dx=10mm, dy=10mm

Maximum value of SAR (interpolated) = 1.24 mW/g

**Ch161/Zoom Scan (7x7x9)/Cube 0:** Measurement grid: dx=4mm, dy=4mm, dz=2.5mm

Reference Value = 13.6 V/m; Power Drift = -0.168 dB

Peak SAR (extrapolated) = 2.98 W/kg

**SAR(1 g) = 0.715 mW/g; SAR(10 g) = 0.206 mW/g**

Maximum value of SAR (measured) = 1.56 mW/g



## P52 802.11a\_Verical Front\_0.5cm\_Ch165\_ANT 0

**DUT: 111122C09**

Communication System: 802.11a; Frequency: 5825 MHz; Duty Cycle: 1:1

Medium: B5G\_1213 Medium parameters used:  $f = 5825$  MHz;  $\sigma = 6.3$  mho/m;  $\epsilon_r = 46.9$ ;  $\rho = 1000$  kg/m<sup>3</sup>

Ambient Temperature : 22.2 °C; Liquid Temperature : 21.1 °C

DASY4 Configuration:

- Probe: EX3DV4 - SN3650; ConvF(3.81, 3.81, 3.81); Calibrated: 2011/10/26
- Sensor-Surface: 2mm (Mechanical Surface Detection)
- Electronics: DAE4 Sn1277; Calibrated: 2011/07/29
- Phantom: SAM Phantom\_Left; Type: SAM V4.0; Serial: TP 1652
- Measurement SW: DASY4, V4.7 Build 80; Postprocessing SW: SEMCAD, V1.8 Build 186

**Ch165/Area Scan (81x121x1):** Measurement grid: dx=10mm, dy=10mm

Maximum value of SAR (interpolated) = 1.12 mW/g

**Ch165/Zoom Scan (7x7x9)/Cube 0:** Measurement grid: dx=4mm, dy=4mm, dz=2.5mm

Reference Value = 12.6 V/m; Power Drift = -0.135 dB

Peak SAR (extrapolated) = 2.66 W/kg

**SAR(1 g) = 0.618 mW/g; SAR(10 g) = 0.179 mW/g**

Maximum value of SAR (measured) = 1.45 mW/g

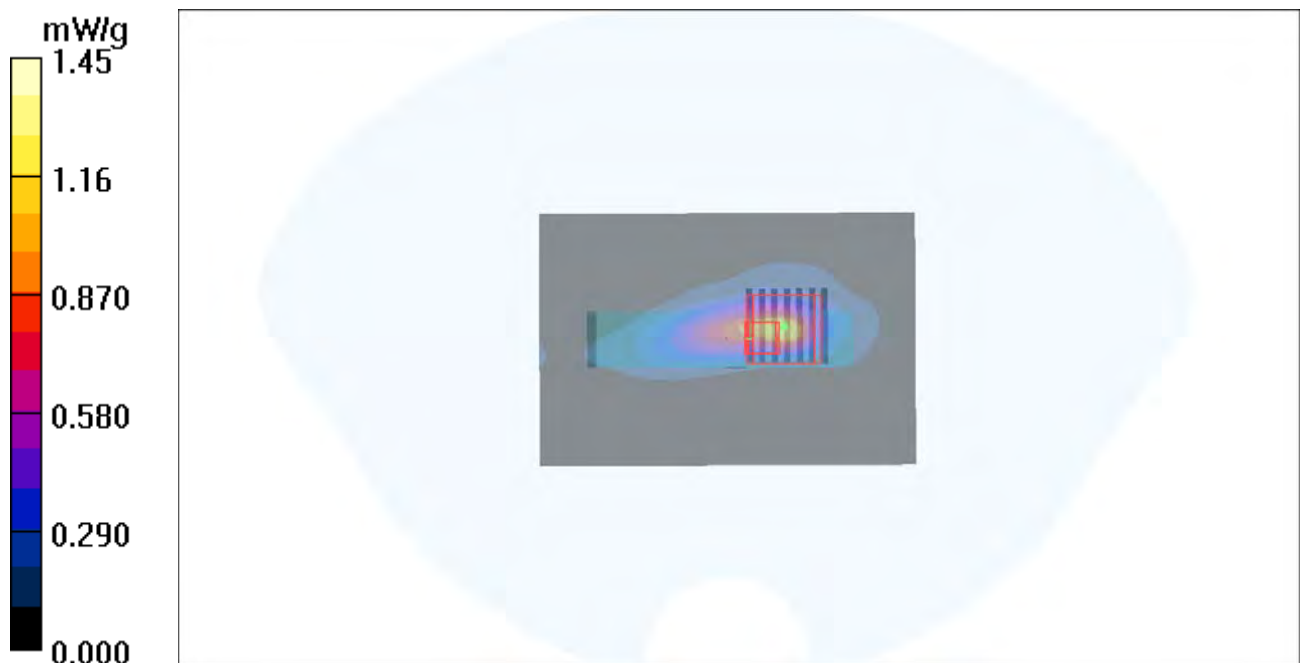

## P127 802.11n\_HT40\_Horizontal Up\_0.5cm\_Ch159\_ANT 0+1+2

**DUT: 111122C09**

Communication System: 802.11aN\_40MHz; Frequency: 5795 MHz; Duty Cycle: 1:1

Medium: B5G\_0206 Medium parameters used:  $f = 5795$  MHz;  $\sigma = 6.26$  mho/m;  $\epsilon_r = 46.7$ ;  $\rho = 1000$  kg/m<sup>3</sup>

Ambient Temperature : 21.6 °C; Liquid Temperature : 20.7 °C

DASY4 Configuration:

- Probe: EX3DV4 - SN3650; ConvF(3.81, 3.81, 3.81); Calibrated: 2011/10/26
- Sensor-Surface: 2mm (Mechanical Surface Detection)
- Electronics: DAE3 Sn579; Calibrated: 2011/09/23
- Phantom: SAM Phantom\_Left; Type: SAM V4.0; Serial: TP 1652
- Measurement SW: DASY4, V4.7 Build 80; Postprocessing SW: SEMCAD, V1.8 Build 186

**Ch159/Area Scan (121x61x1):** Measurement grid: dx=10mm, dy=10mm

Maximum value of SAR (interpolated) = 0.962 mW/g

**Ch159/Zoom Scan (7x7x9)/Cube 0:** Measurement grid: dx=4mm, dy=4mm, dz=2.5mm

Reference Value = 13.0 V/m; Power Drift = -0.12 dB

Peak SAR (extrapolated) = 1.83 W/kg

**SAR(1 g) = 0.337 mW/g; SAR(10 g) = 0.137 mW/g**

Maximum value of SAR (measured) = 0.915 mW/g

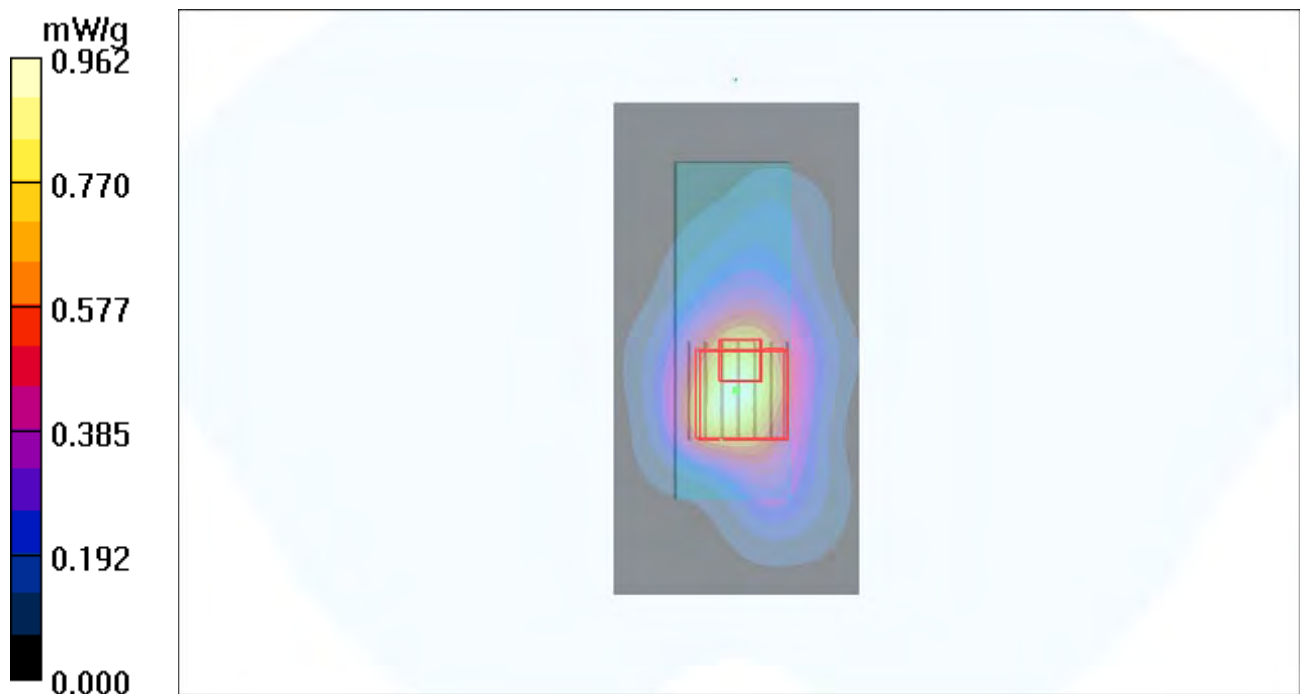

## P128 802.11n\_HT40\_Horizontal\_Down\_0.5cm\_Ch159\_ANT 0+1+2

**DUT: 111122C09**

Communication System: 802.11aN\_40MHz; Frequency: 5795 MHz; Duty Cycle: 1:1

Medium: B5G\_0206 Medium parameters used:  $f = 5795$  MHz;  $\sigma = 6.26$  mho/m;  $\epsilon_r = 46.7$ ;  $\rho = 1000$  kg/m<sup>3</sup>

Ambient Temperature : 21.6 °C; Liquid Temperature : 20.7 °C

DASY4 Configuration:

- Probe: EX3DV4 - SN3650; ConvF(3.81, 3.81, 3.81); Calibrated: 2011/10/26
- Sensor-Surface: 2mm (Mechanical Surface Detection)
- Electronics: DAE3 Sn579; Calibrated: 2011/09/23
- Phantom: SAM Phantom\_Left; Type: SAM V4.0; Serial: TP 1652
- Measurement SW: DASY4, V4.7 Build 80; Postprocessing SW: SEMCAD, V1.8 Build 186

**Ch159/Area Scan (121x61x1):** Measurement grid: dx=10mm, dy=10mm

Maximum value of SAR (interpolated) = 0.319 mW/g

**Ch159/Zoom Scan (7x7x9)/Cube 0:** Measurement grid: dx=4mm, dy=4mm, dz=2.5mm

Reference Value = 7.04 V/m; Power Drift = -0.155 dB

Peak SAR (extrapolated) = 0.649 W/kg

**SAR(1 g) = 0.121 mW/g; SAR(10 g) = 0.038 mW/g**

Maximum value of SAR (measured) = 0.281 mW/g

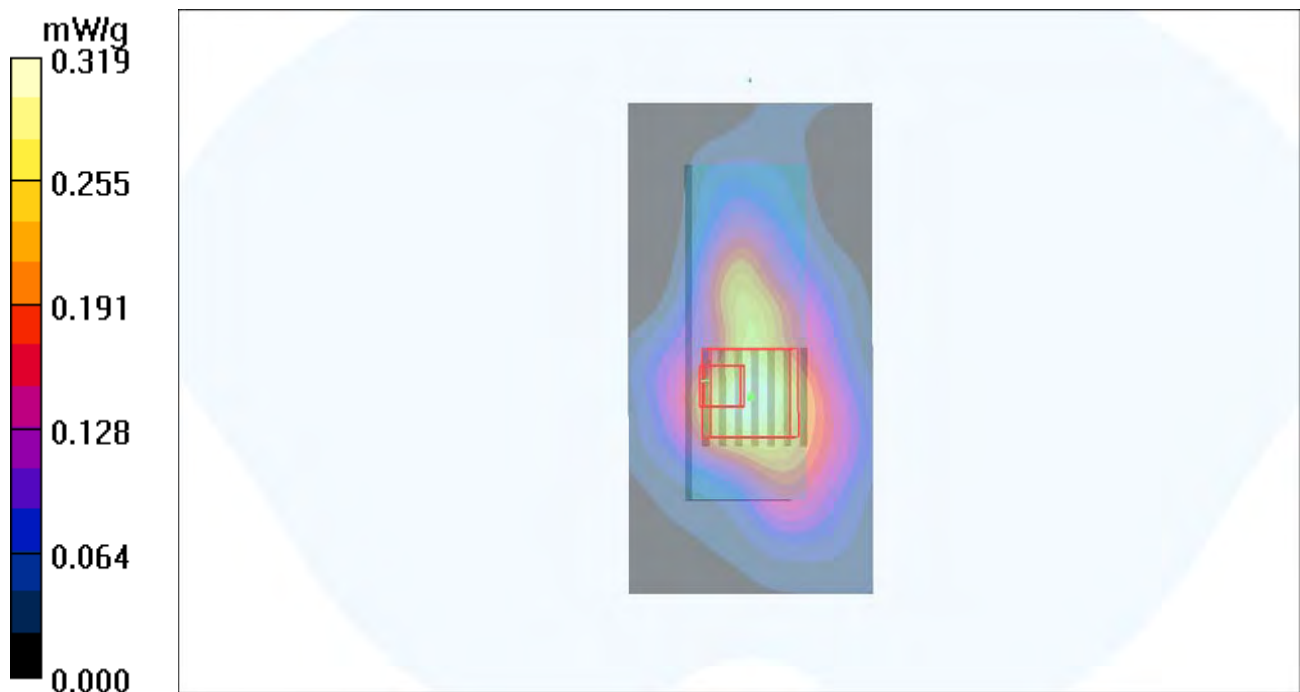

## P54 802.11n\_HT40\_Veritical Front\_0.5cm\_Ch159\_ANT 0+1+2

**DUT: 111122C09**

Communication System: 802.11aN\_40MHz; Frequency: 5795 MHz; Duty Cycle: 1:1

Medium: B5G\_1213 Medium parameters used:  $f = 5795$  MHz;  $\sigma = 6.26$  mho/m;  $\epsilon_r = 47.1$ ;  $\rho = 1000$  kg/m<sup>3</sup>

Ambient Temperature : 22.1 °C; Liquid Temperature : 21.1 °C

DASY4 Configuration:

- Probe: EX3DV4 - SN3650; ConvF(3.81, 3.81, 3.81); Calibrated: 2011/10/26
- Sensor-Surface: 2mm (Mechanical Surface Detection)
- Electronics: DAE4 Sn1277; Calibrated: 2011/07/29
- Phantom: SAM Phantom\_Left; Type: SAM V4.0; Serial: TP 1652
- Measurement SW: DASY4, V4.7 Build 80; Postprocessing SW: SEMCAD, V1.8 Build 186

**Ch159/Area Scan (81x121x1):** Measurement grid: dx=10mm, dy=10mm

Maximum value of SAR (interpolated) = 0.753 mW/g

**Ch159/Zoom Scan (7x7x9)/Cube 0:** Measurement grid: dx=4mm, dy=4mm, dz=2.5mm

Reference Value = 11.0 V/m; Power Drift = -0.13 dB

Peak SAR (extrapolated) = 1.76 W/kg

**SAR(1 g) = 0.398 mW/g; SAR(10 g) = 0.132 mW/g**

Maximum value of SAR (measured) = 0.926 mW/g

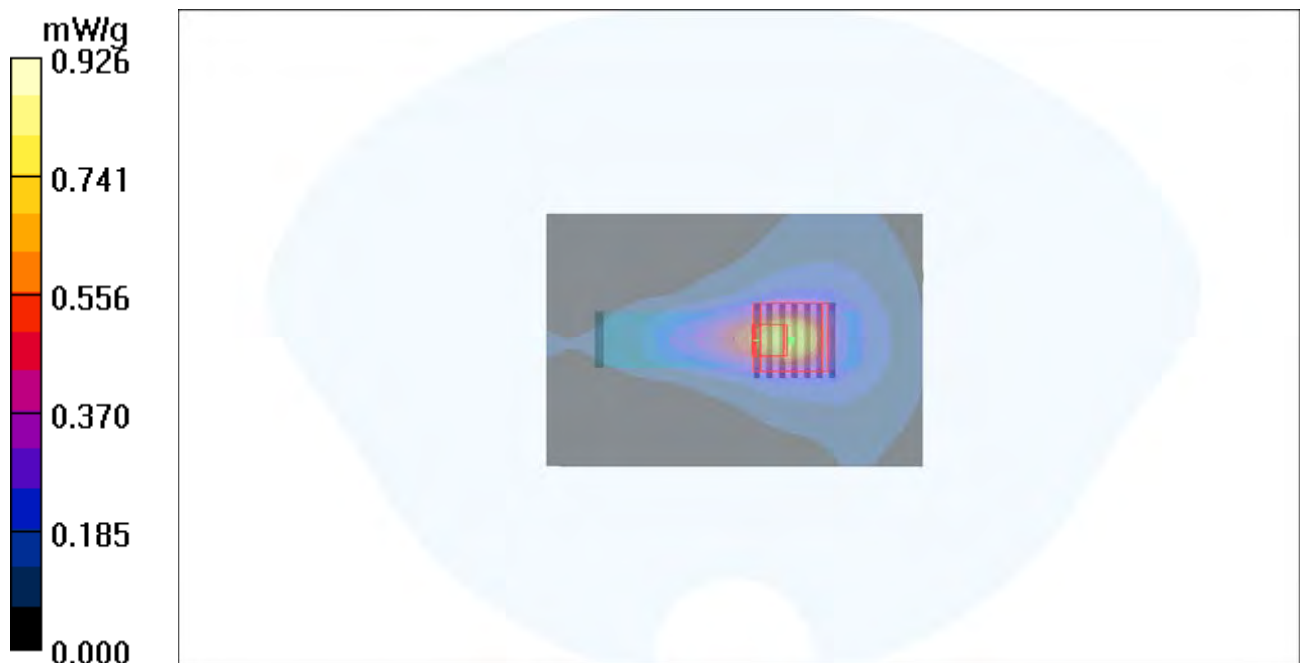

### P129 802.11n\_HT40\_Vertical Back\_0.5cm\_Ch159\_ANT 0+1+2

**DUT: 111122C09**

Communication System: 802.11aN\_40MHz; Frequency: 5795 MHz; Duty Cycle: 1:1

Medium: B5G\_0206 Medium parameters used:  $f = 5795$  MHz;  $\sigma = 6.26$  mho/m;  $\epsilon_r = 46.7$ ;  $\rho = 1000$  kg/m<sup>3</sup>

Ambient Temperature : 21.6 °C ; Liquid Temperature : 20.7 °C

DASY4 Configuration:

- Probe: EX3DV4 - SN3650; ConvF(3.81, 3.81, 3.81); Calibrated: 2011/10/26
- Sensor-Surface: 2mm (Mechanical Surface Detection)
- Electronics: DAE3 Sn579; Calibrated: 2011/09/23
- Phantom: SAM Phantom\_Left; Type: SAM V4.0; Serial: TP 1652
- Measurement SW: DASY4, V4.7 Build 80; Postprocessing SW: SEMCAD, V1.8 Build 186

**Ch159/Area Scan (81x121x1):** Measurement grid: dx=10mm, dy=10mm

Maximum value of SAR (interpolated) = 0.795 mW/g

**Ch159/Zoom Scan (7x7x9)/Cube 0:** Measurement grid: dx=4mm, dy=4mm, dz=2.5mm

Reference Value = 12.2 V/m; Power Drift = -0.182 dB

Peak SAR (extrapolated) = 1.42 W/kg

**SAR(1 g) = 0.311 mW/g; SAR(10 g) = 0.099 mW/g**

Maximum value of SAR (measured) = 0.647 mW/g

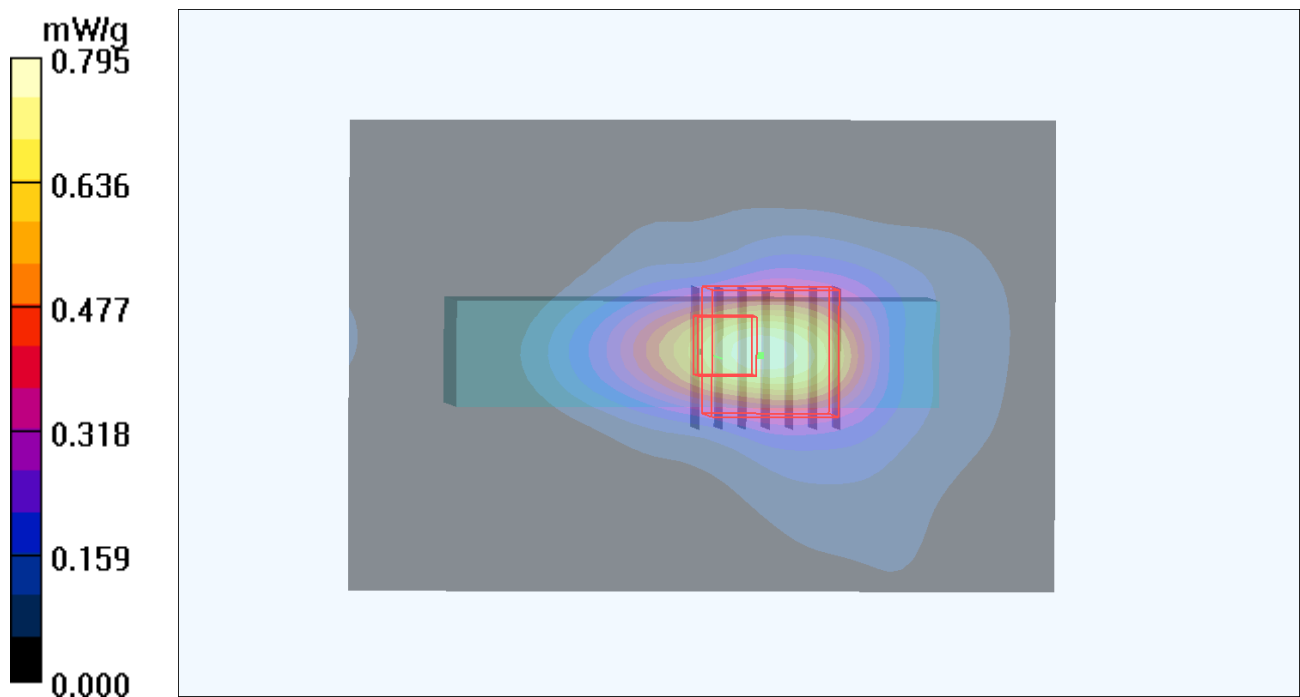

## P130 802.11n\_HT40\_Tip Mode\_0.5cm\_Ch159\_ANT 0+1+2

**DUT: 111122C09**

Communication System: 802.11aN\_40MHz; Frequency: 5795 MHz; Duty Cycle: 1:1

Medium: B5G\_0206 Medium parameters used:  $f = 5795$  MHz;  $\sigma = 6.26$  mho/m;  $\epsilon_r = 46.7$ ;  $\rho = 1000$  kg/m<sup>3</sup>

Ambient Temperature : 21.7 °C ; Liquid Temperature : 20.7 °C

DASY4 Configuration:

- Probe: EX3DV4 - SN3650; ConvF(3.81, 3.81, 3.81); Calibrated: 2011/10/26
- Sensor-Surface: 2mm (Mechanical Surface Detection)
- Electronics: DAE3 Sn579; Calibrated: 2011/09/23
- Phantom: SAM Phantom\_Left; Type: SAM V4.0; Serial: TP 1652
- Measurement SW: DASY4, V4.7 Build 80; Postprocessing SW: SEMCAD, V1.8 Build 186

**Ch159/Area Scan (81x81x1):** Measurement grid: dx=10mm, dy=10mm

Maximum value of SAR (interpolated) = 0.112 mW/g

**Ch159/Zoom Scan (7x7x9)/Cube 0:** Measurement grid: dx=4mm, dy=4mm, dz=2.5mm

Reference Value = 4.99 V/m; Power Drift = -0.103 dB

Peak SAR (extrapolated) = 0.233 W/kg

**SAR(1 g) = 0.068 mW/g; SAR(10 g) = 0.022 mW/g**

Maximum value of SAR (measured) = 0.132 mW/g

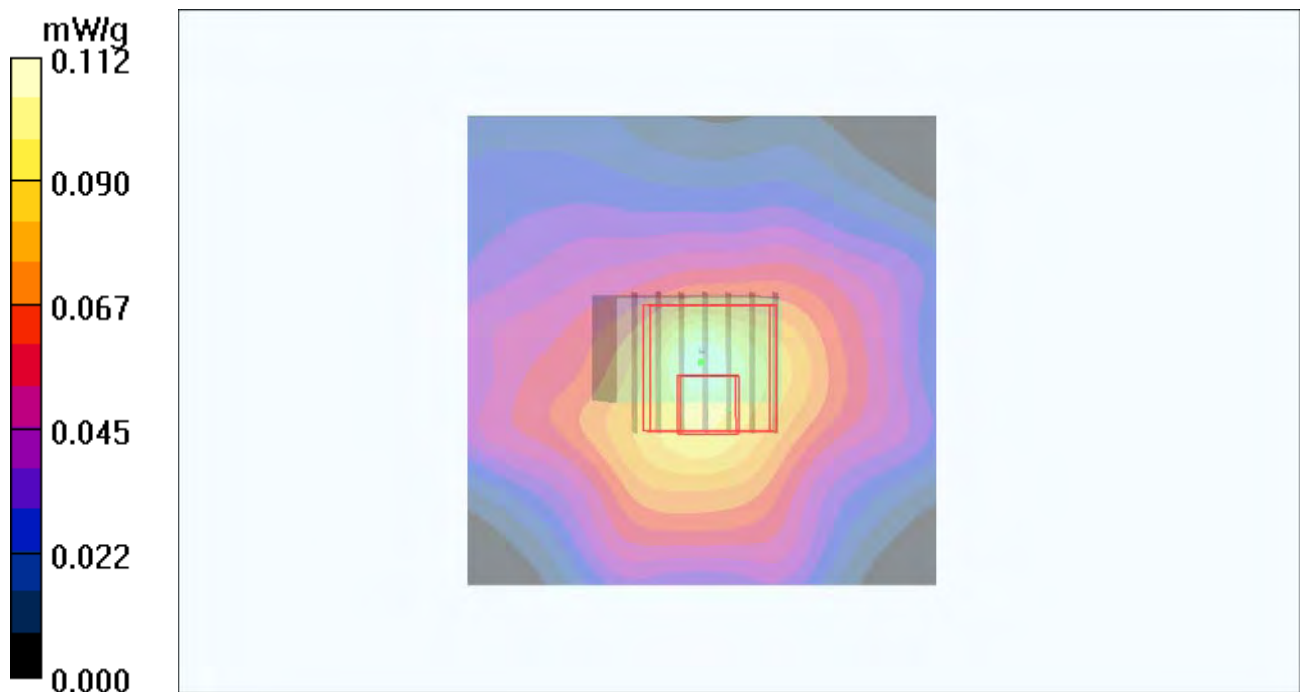



A D T

## **Appendix C. Calibration Certificate for Probe and Dipole**

The SPEAG calibration certificates are shown as follows.



**Calibration Laboratory of  
Schmid & Partner  
Engineering AG**  
Zeughausstrasse 43, 8004 Zurich, Switzerland



**S** Schweizerischer Kalibrierdienst  
**S** Service suisse d'étalonnage  
**S** Servizio svizzero di taratura  
**S** Swiss Calibration Service

Accredited by the Swiss Accreditation Service (SAS)  
The Swiss Accreditation Service is one of the signatories to the EA  
Multilateral Agreement for the recognition of calibration certificates

Accreditation No.: **SCS 108**

Client **B.V. ADT (Auden)**

Certificate No: **EX3-3650\_Oct11**

**CALIBRATION CERTIFICATE**

Object **EX3DV4 - SN:3650**

Calibration procedure(s) **QA CAL-01 v8, QA CAL-14 v3, QA CAL-23 v4, QA CAL-25 v4  
Calibration procedure for dosimetric E-field probes**

Calibration date: **October 26, 2011**

This calibration certificate documents the traceability to national standards, which realize the physical units of measurements (SI).  
The measurements and the uncertainties with confidence probability are given on the following pages and are part of the certificate.

All calibrations have been conducted in the closed laboratory facility: environment temperature (22 ± 3)°C and humidity < 70%.

Calibration Equipment used (M&TE critical for calibration)

Primary Standards	ID	Cal Date (Certificate No.)	Scheduled Calibration
Power meter E4419B	GB41293874	31-Mar-11 (No. 217-01372)	Apr-12
Power sensor E4412A	MY41498087	31-Mar-11 (No. 217-01372)	Apr-12
Reference 3 dB Attenuator	SN: S5054 (3c)	29-Mar-11 (No. 217-01369)	Apr-12
Reference 20 dB Attenuator	SN: S5086 (20b)	29-Mar-11 (No. 217-01367)	Apr-12
Reference 30 dB Attenuator	SN: S5129 (30b)	29-Mar-11 (No. 217-01370)	Apr-12
Reference Probe ES3DV2	SN: 3013	29-Dec-10 (No. ES3-3013_Dec10)	Dec-11
DAE4	SN: 654	3-May-11 (No. DAE4-654_May11)	May-12
Secondary Standards	ID	Check Date (in house)	Scheduled Check
RF generator HP 8648C	US3642U01700	4-Aug-99 (in house check Apr-11)	In house check: Apr-13
Network Analyzer HP 8753E	US37390585	18-Oct-01 (in house check Oct-11)	In house check: Oct-12

	Name	Function	Signature
Calibrated by:	Jeton Kastrati	Laboratory Technician	
Approved by:	Katja Pokovic	Technical Manager	

Issued: October 27, 2011

This calibration certificate shall not be reproduced except in full without written approval of the laboratory.



Accredited by the Swiss Accreditation Service (SAS)

Accreditation No.: **SCS 108**

The Swiss Accreditation Service is one of the signatories to the EA  
Multilateral Agreement for the recognition of calibration certificates

### Glossary:

TSL	tissue simulating liquid
NORM <sub>x,y,z</sub>	sensitivity in free space
ConvF	sensitivity in TSL / NORM <sub>x,y,z</sub>
DCP	diode compression point
CF	crest factor (1/duty_cycle) of the RF signal
A, B, C	modulation dependent linearization parameters
Polarization $\varphi$	$\varphi$ rotation around probe axis
Polarization $\vartheta$	$\vartheta$ rotation around an axis that is in the plane normal to probe axis (at measurement center), i.e., $\vartheta = 0$ is normal to probe axis

### Calibration is Performed According to the Following Standards:

- IEEE Std 1528-2003, "IEEE Recommended Practice for Determining the Peak Spatial-Averaged Specific Absorption Rate (SAR) in the Human Head from Wireless Communications Devices: Measurement Techniques", December 2003
- IEC 62209-1, "Procedure to measure the Specific Absorption Rate (SAR) for hand-held devices used in close proximity to the ear (frequency range of 300 MHz to 3 GHz)", February 2005

### Methods Applied and Interpretation of Parameters:

- NORM<sub>x,y,z</sub>**: Assessed for E-field polarization  $\vartheta = 0$  ( $f \leq 900$  MHz in TEM-cell;  $f > 1800$  MHz: R22 waveguide). NORM<sub>x,y,z</sub> are only intermediate values, i.e., the uncertainties of NORM<sub>x,y,z</sub> does not affect the E<sup>2</sup>-field uncertainty inside TSL (see below ConvF).
- NORM(f)<sub>x,y,z</sub> = NORM<sub>x,y,z</sub> \* frequency\_response** (see Frequency Response Chart). This linearization is implemented in DASY4 software versions later than 4.2. The uncertainty of the frequency response is included in the stated uncertainty of ConvF.
- DCP<sub>x,y,z</sub>**: DCP are numerical linearization parameters assessed based on the data of power sweep with CW signal (no uncertainty required). DCP does not depend on frequency nor media.
- PAR**: PAR is the Peak to Average Ratio that is not calibrated but determined based on the signal characteristics
- A<sub>x,y,z</sub>; B<sub>x,y,z</sub>; C<sub>x,y,z</sub>; VR<sub>x,y,z</sub>**: A, B, C are numerical linearization parameters assessed based on the data of power sweep for specific modulation signal. The parameters do not depend on frequency nor media. VR is the maximum calibration range expressed in RMS voltage across the diode.
- ConvF and Boundary Effect Parameters**: Assessed in flat phantom using E-field (or Temperature Transfer Standard for  $f \leq 800$  MHz) and inside waveguide using analytical field distributions based on power measurements for  $f > 800$  MHz. The same setups are used for assessment of the parameters applied for boundary compensation (alpha, depth) of which typical uncertainty values are given. These parameters are used in DASY4 software to improve probe accuracy close to the boundary. The sensitivity in TSL corresponds to NORM<sub>x,y,z</sub> \* ConvF whereby the uncertainty corresponds to that given for ConvF. A frequency dependent ConvF is used in DASY version 4.4 and higher which allows extending the validity from  $\pm 50$  MHz to  $\pm 100$  MHz.
- Spherical isotropy (3D deviation from isotropy)**: in a field of low gradients realized using a flat phantom exposed by a patch antenna.
- Sensor Offset**: The sensor offset corresponds to the offset of virtual measurement center from the probe tip (on probe axis). No tolerance required.

# Probe EX3DV4

## SN:3650

Manufactured: March 18, 2008  
Calibrated: October 26, 2011

Calibrated for DASYS/EASY Systems  
(Note: non-compatible with DASYS2 system!)

## DASY/EASY - Parameters of Probe: EX3DV4 - SN:3650

### Basic Calibration Parameters

	Sensor X	Sensor Y	Sensor Z	Unc (k=2)
Norm ( $\mu\text{V}/(\text{V}/\text{m})^2$ ) <sup>A</sup>	0.36	0.37	0.46	$\pm 10.1 \%$
DCP (mV) <sup>B</sup>	98.5	94.0	98.2	

### Modulation Calibration Parameters

UID	Communication System Name	PAR		A dB	B dB	C dB	VR mV	Unc <sup>E</sup> (k=2)
10000	CW	0.00	X	0.00	0.00	1.00	94.9	$\pm 2.5 \%$
			Y	0.00	0.00	1.00	90.7	
			Z	0.00	0.00	1.00	114.0	

The reported uncertainty of measurement is stated as the standard uncertainty of measurement multiplied by the coverage factor  $k=2$ , which for a normal distribution corresponds to a coverage probability of approximately 95%.

<sup>A</sup> The uncertainties of NormX,Y,Z do not affect the  $E^2$ -field uncertainty inside TSL (see Pages 5 and 6).

<sup>B</sup> Numerical linearization parameter: uncertainty not required.

<sup>E</sup> Uncertainty is determined using the max. deviation from linear response applying rectangular distribution and is expressed for the square of the field value.

## DASY/EASY - Parameters of Probe: EX3DV4 - SN:3650

### Calibration Parameter Determined in Head Tissue Simulating Media

f (MHz) <sup>C</sup>	Relative Permittivity <sup>F</sup>	Conductivity (S/m) <sup>F</sup>	ConvF X	ConvF Y	ConvF Z	Alpha	Depth (mm)	Unct. (k=2)
750	41.9	0.89	9.20	9.20	9.20	0.79	0.69	± 12.0 %
835	41.5	0.90	8.87	8.87	8.87	0.79	0.69	± 12.0 %
1450	40.5	1.20	8.32	8.32	8.32	0.79	0.65	± 12.0 %
1750	40.1	1.37	7.92	7.92	7.92	0.70	0.63	± 12.0 %
1950	40.0	1.40	7.40	7.40	7.40	0.79	0.54	± 12.0 %
2450	39.2	1.80	6.80	6.80	6.80	0.59	0.62	± 12.0 %
2600	39.0	1.96	6.68	6.68	6.68	0.50	0.74	± 12.0 %
5200	36.0	4.66	5.05	5.05	5.05	0.35	1.80	± 13.1 %
5300	35.9	4.76	4.71	4.71	4.71	0.40	1.80	± 13.1 %
5500	35.6	4.96	4.56	4.56	4.56	0.45	1.80	± 13.1 %
5600	35.5	5.07	4.42	4.42	4.42	0.45	1.80	± 13.1 %
5800	35.3	5.27	4.30	4.30	4.30	0.50	1.80	± 13.1 %

<sup>C</sup> Frequency validity of ± 100 MHz only applies for DASY v4.4 and higher (see Page 2), else it is restricted to ± 50 MHz. The uncertainty is the RSS of the ConvF uncertainty at calibration frequency and the uncertainty for the indicated frequency band.

<sup>F</sup> At frequencies below 3 GHz, the validity of tissue parameters ( $\epsilon$  and  $\sigma$ ) can be relaxed to ± 10% if liquid compensation formula is applied to measured SAR values. At frequencies above 3 GHz, the validity of tissue parameters ( $\epsilon$  and  $\sigma$ ) is restricted to ± 5%. The uncertainty is the RSS of the ConvF uncertainty for indicated target tissue parameters.

## DASY/EASY - Parameters of Probe: EX3DV4 - SN:3650

### Calibration Parameter Determined in Body Tissue Simulating Media

f (MHz) <sup>C</sup>	Relative Permittivity <sup>F</sup>	Conductivity (S/m) <sup>F</sup>	ConvF X	ConvF Y	ConvF Z	Alpha	Depth (mm)	Unct. (k=2)
750	55.5	0.96	9.21	9.21	9.21	0.78	0.69	± 12.0 %
835	55.2	0.97	9.12	9.12	9.12	0.79	0.67	± 12.0 %
1450	54.0	1.30	8.09	8.09	8.09	0.79	0.63	± 12.0 %
1750	53.4	1.49	7.49	7.49	7.49	0.79	0.64	± 12.0 %
1950	53.3	1.52	7.46	7.46	7.46	0.79	0.65	± 12.0 %
2450	52.7	1.95	6.89	6.89	6.89	0.79	0.60	± 12.0 %
2600	52.5	2.16	6.79	6.79	6.79	0.72	0.58	± 12.0 %
5200	49.0	5.30	4.28	4.28	4.28	0.50	1.95	± 13.1 %
5300	48.9	5.42	4.11	4.11	4.11	0.50	1.95	± 13.1 %
5500	48.6	5.65	3.73	3.73	3.73	0.60	1.95	± 13.1 %
5600	48.5	5.77	3.57	3.57	3.57	0.60	1.95	± 13.1 %
5800	48.2	6.00	3.81	3.81	3.81	0.60	1.95	± 13.1 %

<sup>C</sup> Frequency validity of ± 100 MHz only applies for DASY v4.4 and higher (see Page 2), else it is restricted to ± 50 MHz. The uncertainty is the RSS of the ConvF uncertainty at calibration frequency and the uncertainty for the indicated frequency band.

<sup>F</sup> At frequencies below 3 GHz, the validity of tissue parameters ( $\epsilon$  and  $\sigma$ ) can be relaxed to ± 10% if liquid compensation formula is applied to measured SAR values. At frequencies above 3 GHz, the validity of tissue parameters ( $\epsilon$  and  $\sigma$ ) is restricted to ± 5%. The uncertainty is the RSS of the ConvF uncertainty for indicated target tissue parameters.

### Frequency Response of E-Field (TEM-Cell:ifi110 EXX, Waveguide: R22)

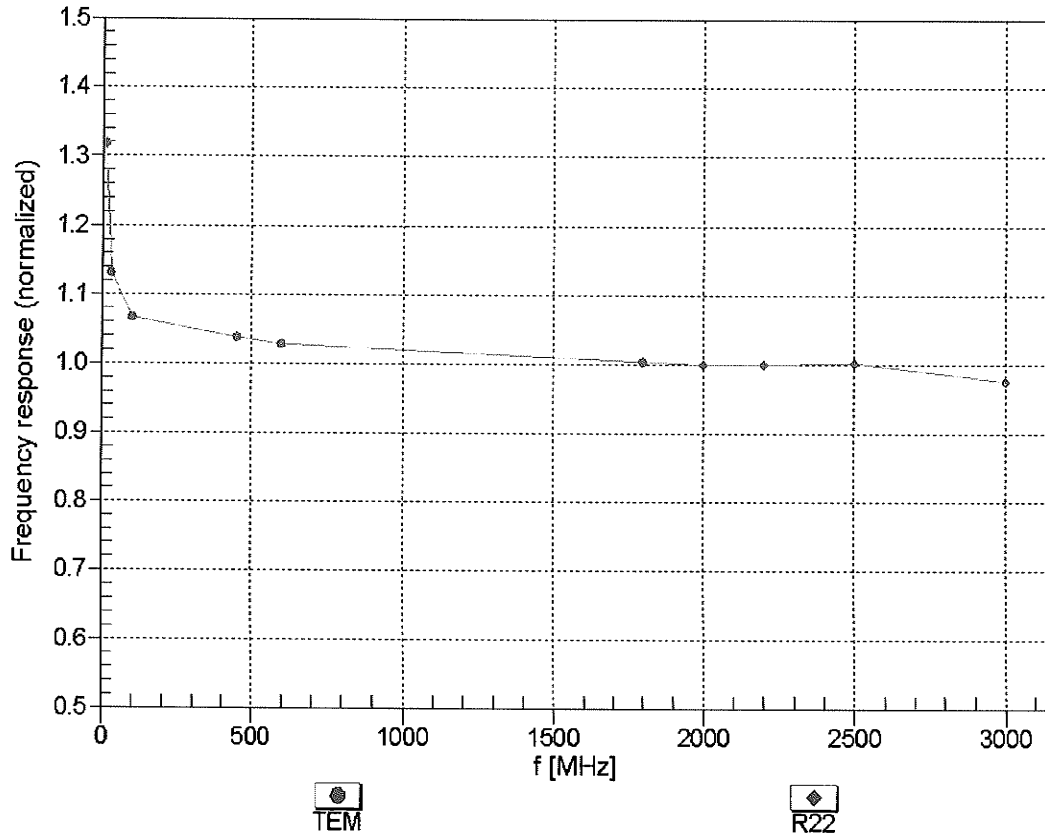

Uncertainty of Frequency Response of E-field:  $\pm 6.3\%$  (k=2)

### Receiving Pattern ( $\phi$ ), $\theta = 0^\circ$

f=600 MHz, TEM

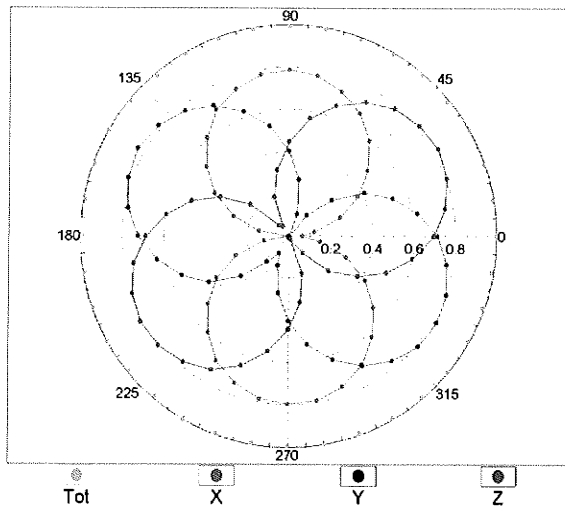

f=1800 MHz, R22

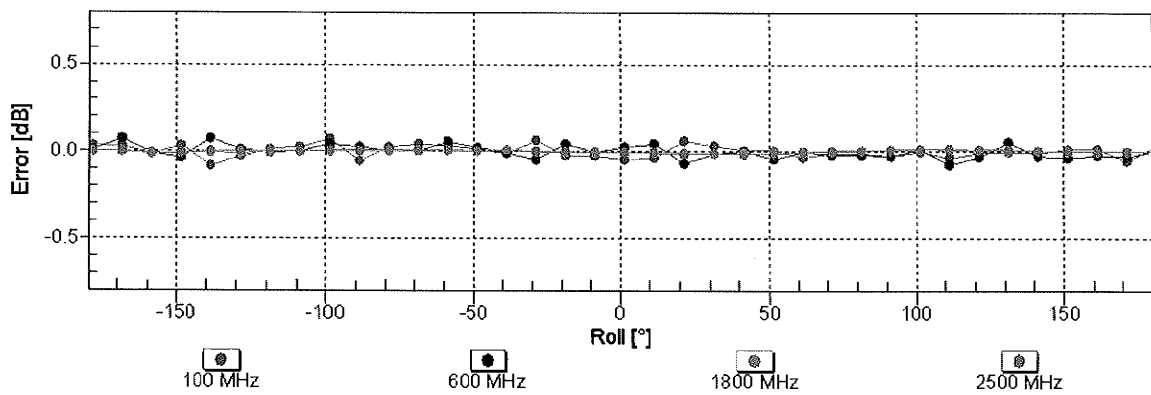
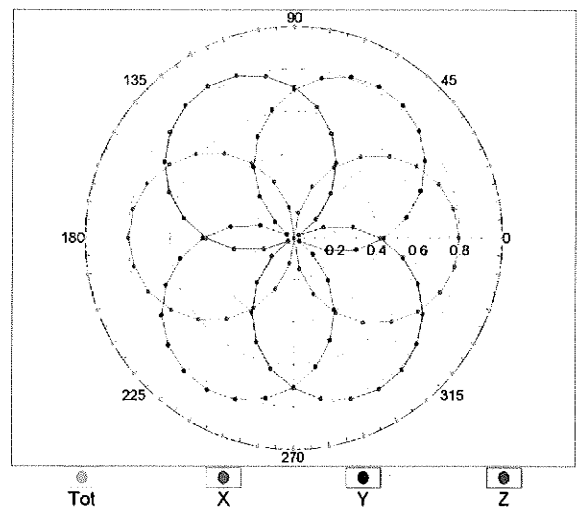

Uncertainty of Axial Isotropy Assessment:  $\pm 0.5\%$  ( $k=2$ )



## Dynamic Range $f(SAR_{head})$ (TEM cell, $f = 900$ MHz)

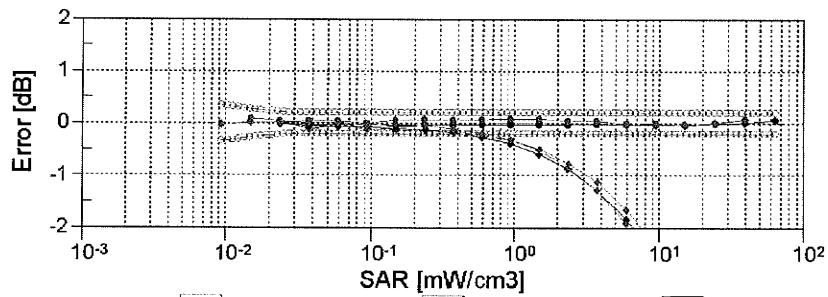
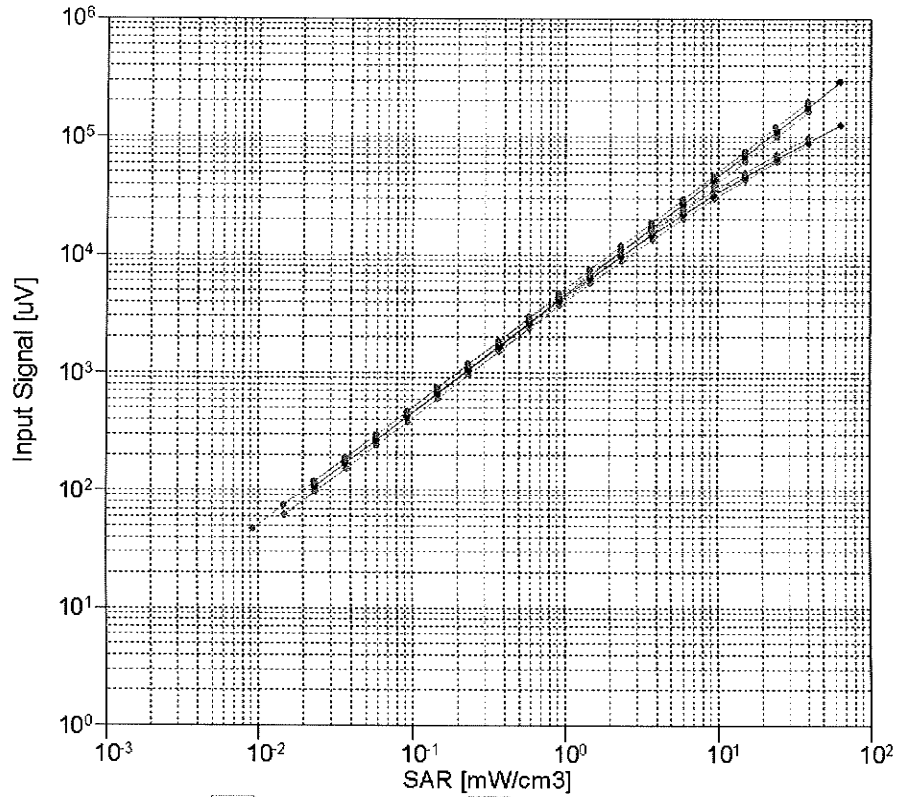

**Uncertainty of Linearity Assessment: ± 0.6% (k=2)**

# Conversion Factor Assessment

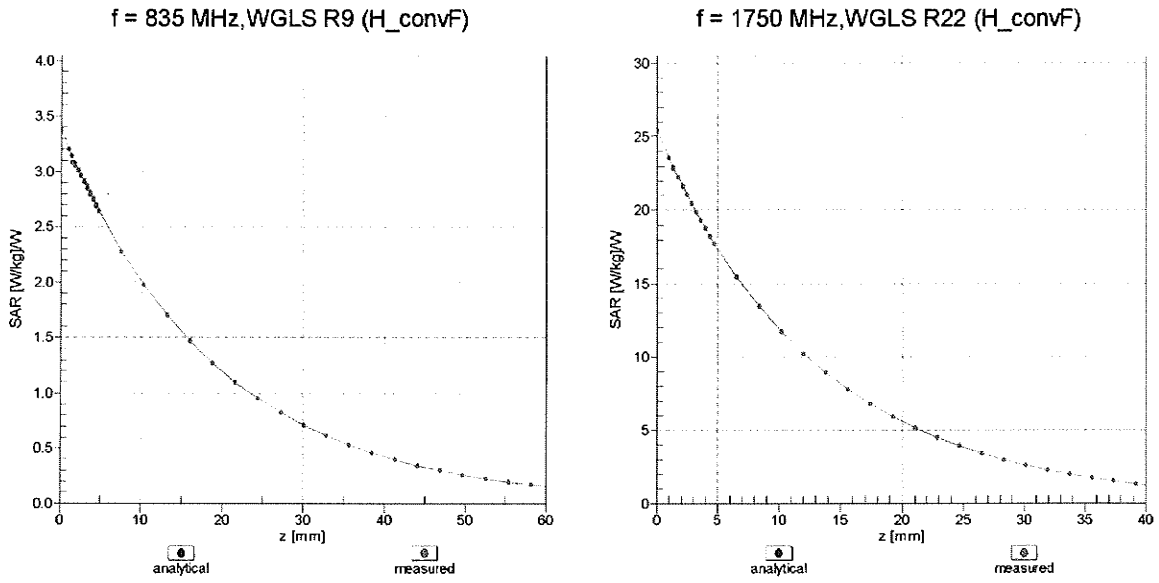

## Deviation from Isotropy in Liquid

Error ( $\phi, \theta$ ), f = 900 MHz

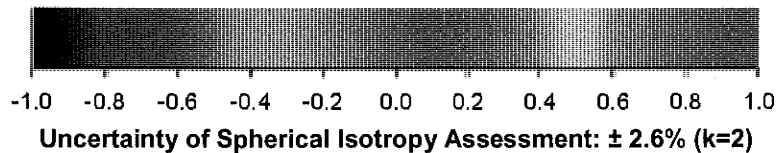
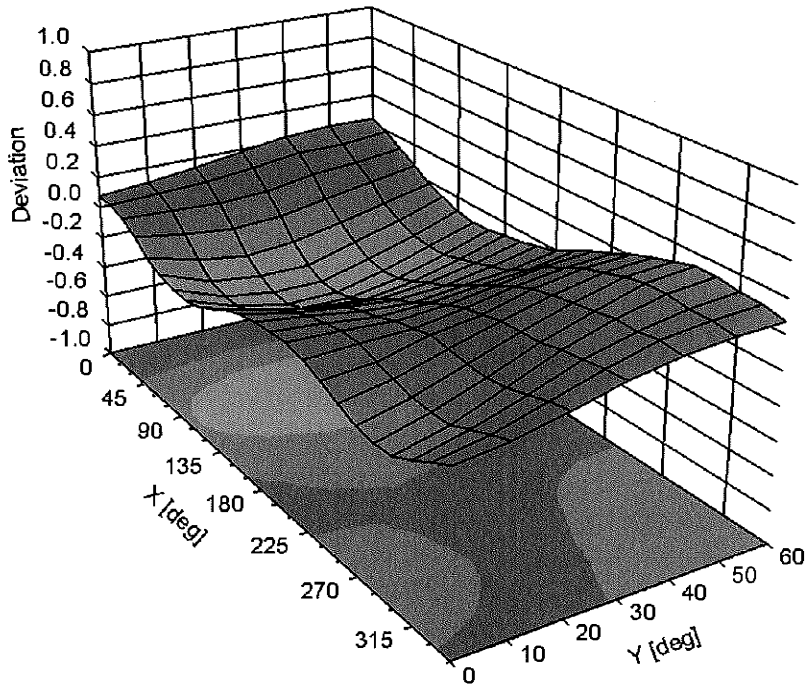

Uncertainty of Spherical Isotropy Assessment:  $\pm 2.6\%$  (k=2)

**DASY/EASY - Parameters of Probe: EX3DV4 - SN:3650****Other Probe Parameters**

Sensor Arrangement	Triangular
Connector Angle (°)	Not applicable
Mechanical Surface Detection Mode	enabled
Optical Surface Detection Mode	disabled
Probe Overall Length	337 mm
Probe Body Diameter	10 mm
Tip Length	9 mm
Tip Diameter	2.5 mm
Probe Tip to Sensor X Calibration Point	1 mm
Probe Tip to Sensor Y Calibration Point	1 mm
Probe Tip to Sensor Z Calibration Point	1 mm
Recommended Measurement Distance from Surface	2 mm



Accredited by the Swiss Accreditation Service (SAS)  
The Swiss Accreditation Service is one of the signatories to the EA  
Multilateral Agreement for the recognition of calibration certificates

Accreditation No.: **SCS 108**

Client **B.V. ADT (Auden)**

Certificate No: **D2450V2-716\_Jan11**

## CALIBRATION CERTIFICATE

Object **D2450V2 - SN: 716**

Calibration procedure(s) **QA CAL-05.v8  
Calibration procedure for dipole validation kits**

Calibration date: **January 26, 2011**

This calibration certificate documents the traceability to national standards, which realize the physical units of measurements (SI).  
The measurements and the uncertainties with confidence probability are given on the following pages and are part of the certificate.

All calibrations have been conducted in the closed laboratory facility: environment temperature  $(22 \pm 3)^\circ\text{C}$  and humidity  $< 70\%$ .

Calibration Equipment used (M&TE critical for calibration)

Primary Standards	ID #	Cal Date (Certificate No.)	Scheduled Calibration
Power meter EPM-442A	GB37480704	06-Oct-10 (No. 217-01266)	Oct-11
Power sensor HP 8481A	US37292783	06-Oct-10 (No. 217-01266)	Oct-11
Reference 20 dB Attenuator	SN: 5086 (20g)	30-Mar-10 (No. 217-01158)	Mar-11
Type-N mismatch combination	SN: 5047.2 / 06327	30-Mar-10 (No. 217-01162)	Mar-11
Reference Probe ES3DV3	SN: 3205	30-Apr-10 (No. ES3-3205_Apr10)	Apr-11
DAE4	SN: 601	10-Jun-10 (No. DAE4-601_Jun10)	Jun-11
Secondary Standards	ID #	Check Date (in house)	Scheduled Check
Power sensor HP 8481A	MY41092317	18-Oct-02 (in house check Oct-09)	In house check: Oct-11
RF generator R&S SMT-06	100005	4-Aug-99 (in house check Oct-09)	In house check: Oct-11
Network Analyzer HP 8753E	US37390585 S4206	18-Oct-01 (in house check Oct-10)	In house check: Oct-11

Calibrated by:	Name	Function	Signature
	Dimce Iliev	Laboratory Technician	
Approved by:	Katja Pokovic	Technical Manager	

Issued: January 27, 2011

This calibration certificate shall not be reproduced except in full without written approval of the laboratory.



Accredited by the Swiss Accreditation Service (SAS)  
The Swiss Accreditation Service is one of the signatories to the EA  
Multilateral Agreement for the recognition of calibration certificates

Accreditation No.: **SCS 108**

### Glossary:

TSL	tissue simulating liquid
ConvF	sensitivity in TSL / NORM x,y,z
N/A	not applicable or not measured

### Calibration is Performed According to the Following Standards:

- IEEE Std 1528-2003, "IEEE Recommended Practice for Determining the Peak Spatial-Averaged Specific Absorption Rate (SAR) in the Human Head from Wireless Communications Devices: Measurement Techniques", December 2003
- IEC 62209-1, "Procedure to measure the Specific Absorption Rate (SAR) for hand-held devices used in close proximity to the ear (frequency range of 300 MHz to 3 GHz)", February 2005
- Federal Communications Commission Office of Engineering & Technology (FCC OET), "Evaluating Compliance with FCC Guidelines for Human Exposure to Radiofrequency Electromagnetic Fields; Additional Information for Evaluating Compliance of Mobile and Portable Devices with FCC Limits for Human Exposure to Radiofrequency Emissions", Supplement C (Edition 01-01) to Bulletin 65

### Additional Documentation:

- DASY4/5 System Handbook

### Methods Applied and Interpretation of Parameters:

- Measurement Conditions:* Further details are available from the Validation Report at the end of the certificate. All figures stated in the certificate are valid at the frequency indicated.
- Antenna Parameters with TSL:* The dipole is mounted with the spacer to position its feed point exactly below the center marking of the flat phantom section, with the arms oriented parallel to the body axis.
- Feed Point Impedance and Return Loss:* These parameters are measured with the dipole positioned under the liquid filled phantom. The impedance stated is transformed from the measurement at the SMA connector to the feed point. The Return Loss ensures low reflected power. No uncertainty required.
- Electrical Delay:* One-way delay between the SMA connector and the antenna feed point. No uncertainty required.
- SAR measured:* SAR measured at the stated antenna input power.
- SAR normalized:* SAR as measured, normalized to an input power of 1 W at the antenna connector.
- SAR for nominal TSL parameters:* The measured TSL parameters are used to calculate the nominal SAR result.

## Measurement Conditions

DASY system configuration, as far as not given on page 1.

DASY Version	DASY5	V52.6
Extrapolation	Advanced Extrapolation	
Phantom	Modular Flat Phantom V5.0	
Distance Dipole Center - TSL	10 mm	with Spacer
Zoom Scan Resolution	dx, dy, dz = 5 mm	
Frequency	2450 MHz $\pm$ 1 MHz	

## Head TSL parameters

The following parameters and calculations were applied.

	Temperature	Permittivity	Conductivity
Nominal Head TSL parameters	22.0 °C	39.2	1.80 mho/m
Measured Head TSL parameters	(22.0 $\pm$ 0.2) °C	37.9 $\pm$ 6 %	1.74 mho/m $\pm$ 6 %
Head TSL temperature during test	(20.5 $\pm$ 0.2) °C	----	----

## SAR result with Head TSL

SAR averaged over 1 cm <sup>3</sup> (1 g) of Head TSL	Condition	
SAR measured	250 mW input power	13.6 mW / g
SAR normalized	normalized to 1W	54.4 mW / g
SAR for nominal Head TSL parameters	normalized to 1W	<b>54.8 mW / g <math>\pm</math> 17.0 % (k=2)</b>

SAR averaged over 10 cm <sup>3</sup> (10 g) of Head TSL	condition	
SAR measured	250 mW input power	6.37 mW / g
SAR normalized	normalized to 1W	25.5 mW / g
SAR for nominal Head TSL parameters	normalized to 1W	<b>25.5 mW / g <math>\pm</math> 16.5 % (k=2)</b>

## Body TSL parameters

The following parameters and calculations were applied.

	Temperature	Permittivity	Conductivity
Nominal Body TSL parameters	22.0 °C	52.7	1.95 mho/m
Measured Body TSL parameters	(22.0 ± 0.2) °C	52.5 ± 6 %	1.96 mho/m ± 6 %
Body TSL temperature during test	(20.8 ± 0.2) °C	----	----

## SAR result with Body TSL

SAR averaged over 1 cm <sup>3</sup> (1 g) of Body TSL	Condition	
SAR measured	250 mW input power	13.4 mW / g
SAR normalized	normalized to 1W	53.6 mW / g
SAR for nominal Body TSL parameters	normalized to 1W	<b>53.3 mW / g ± 17.0 % (k=2)</b>

SAR averaged over 10 cm <sup>3</sup> (10 g) of Body TSL	condition	
SAR measured	250 mW input power	6.22 mW / g
SAR normalized	normalized to 1W	24.9 mW / g
SAR for nominal Body TSL parameters	normalized to 1W	<b>24.8 mW / g ± 16.5 % (k=2)</b>

## Appendix

### Antenna Parameters with Head TSL

Impedance, transformed to feed point	55.0 $\Omega$ + 2.1 j $\Omega$
Return Loss	- 25.7 dB

### Antenna Parameters with Body TSL

Impedance, transformed to feed point	50.1 $\Omega$ + 4.4 j $\Omega$
Return Loss	- 27.2 dB

### General Antenna Parameters and Design

Electrical Delay (one direction)	1.143 ns
----------------------------------	----------

After long term use with 100W radiated power, only a slight warming of the dipole near the feedpoint can be measured.

The dipole is made of standard semirigid coaxial cable. The center conductor of the feeding line is directly connected to the second arm of the dipole. The antenna is therefore short-circuited for DC-signals.

No excessive force must be applied to the dipole arms, because they might bend or the soldered connections near the feedpoint may be damaged.

### Additional EUT Data

Manufactured by	SPEAG
Manufactured on	September 10, 2002



## DASY5 Validation Report for Head TSL

Date/Time: 24.01.2011 13:05:38

Test Laboratory: SPEAG, Zurich, Switzerland

**DUT: Dipole 2450 MHz; Type: D2450V2; Serial: D2450V2 - SN:716**

Communication System: CW; Frequency: 2450 MHz; Duty Cycle: 1:1

Medium: HSL U12 BB

Medium parameters used:  $f = 2450$  MHz;  $\sigma = 1.75$  mho/m;  $\epsilon_r = 38.1$ ;  $\rho = 1000$  kg/m<sup>3</sup>

Phantom section: Flat Section

Measurement Standard: DASY5 (IEEE/IEC/ANSI C63.19-2007)

DASY5 Configuration:

- Probe: ES3DV3 - SN3205; ConvF(4.53, 4.53, 4.53); Calibrated: 30.04.2010
- Sensor-Surface: 3mm (Mechanical Surface Detection)
- Electronics: DAE4 Sn601; Calibrated: 10.06.2010
- Phantom: Flat Phantom 5.0 (front); Type: QD000P50AA; Serial: 1001
- Measurement SW: DASY52, V52.6.1 Build (408)
- Postprocessing SW: SEMCAD X, V14.4.2 Build (2595)

**Pin=250 mW /d=10mm, dist=3.0mm (ES-Probe)/Zoom Scan (7x7x7) /Cube 0:** Measurement grid: dx=5mm, dy=5mm, dz=5mm

Reference Value = 103.2 V/m; Power Drift = 0.05 dB

Peak SAR (extrapolated) = 27.976 W/kg

**SAR(1 g) = 13.6 mW/g; SAR(10 g) = 6.37 mW/g**

Maximum value of SAR (measured) = 17.366 mW/g

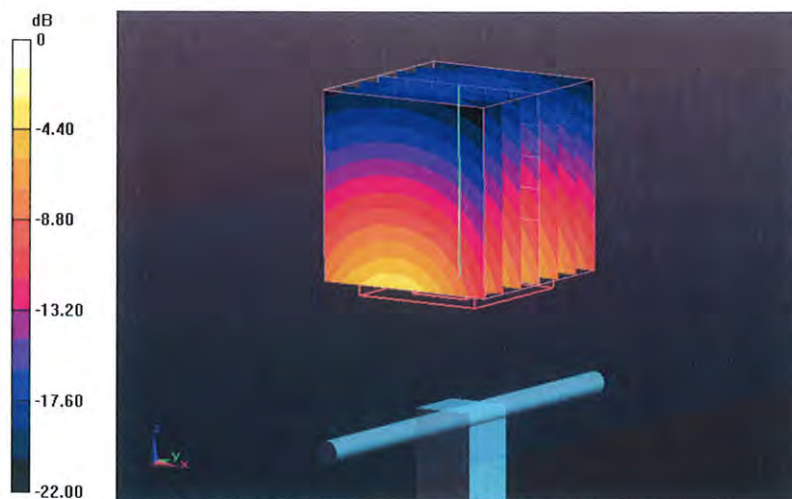

0 dB = 17.370mW/g

# Impedance Measurement Plot for Head TSL

24 Jan 2011 10:25:33

CH1 S11 1 U FS 4: 55.020  $\Omega$  2.0840  $\Omega$  135.38 pF 2 450.000 000 MHz

\*  
De l  
CΔ

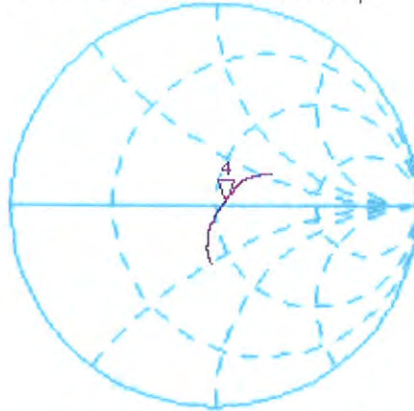

Avg  
16  
↑

CH2 S11 LOG 5 dB/REF -20 dB 4:-25.719 dB 2 450.000 000 MHz

CΔ  
Avg  
16  
↑



## DASY5 Validation Report for Body TSL

Date/Time: 26.01.2011 13:56:41

Test Laboratory: SPEAG, Zurich, Switzerland

**DUT: Dipole 2450 MHz; Type: D2450V2; Serial: D2450V2 - SN:716**

Communication System: CW; Frequency: 2450 MHz; Duty Cycle: 1:1

Medium: MSL U12 BB

Medium parameters used:  $f = 2450$  MHz;  $\sigma = 1.97$  mho/m;  $\epsilon_r = 52.7$ ;  $\rho = 1000$  kg/m<sup>3</sup>

Phantom section: Flat Section

Measurement Standard: DASY5 (IEEE/IEC/ANSI C63.19-2007)

DASY5 Configuration:

- Probe: ES3DV3 - SN3205; ConvF(4.31, 4.31, 4.31); Calibrated: 30.04.2010
- Sensor-Surface: 3mm (Mechanical Surface Detection)
- Electronics: DAE4 Sn601; Calibrated: 10.06.2010
- Phantom: Flat Phantom 5.0 (back); Type: QD000P50AA; Serial: 1002
- Measurement SW: DASY52, V52.6.1 Build (408)
- Postprocessing SW: SEMCAD X, V14.4.2 Build (2595)

**Pin=250 mW /d=10mm, dist=3.0mm (ES-Probe)/Zoom Scan (7x7x7) /Cube 0:** Measurement grid: dx=5mm, dy=5mm, dz=5mm

Reference Value = 97.445 V/m; Power Drift = -0.06 dB

Peak SAR (extrapolated) = 28.276 W/kg

**SAR(1 g) = 13.4 mW/g; SAR(10 g) = 6.22 mW/g**

Maximum value of SAR (measured) = 17.680 mW/g

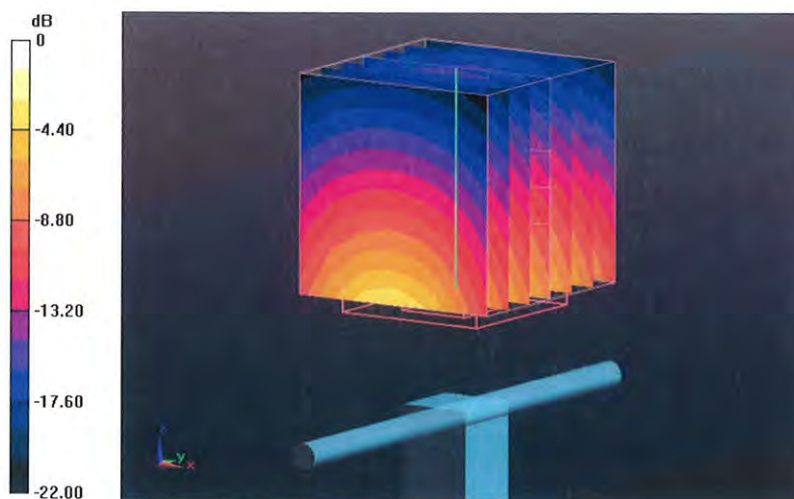



# Impedance Measurement Plot for Body TSL

26 Jan 2011 10:53:07

[CH1] S11 1 U FS 4: 50.141  $\Omega$  4.3887  $\Omega$  285.09  $\mu\text{H}$  2 450.000 000 MHz

\*  
Del  
CA

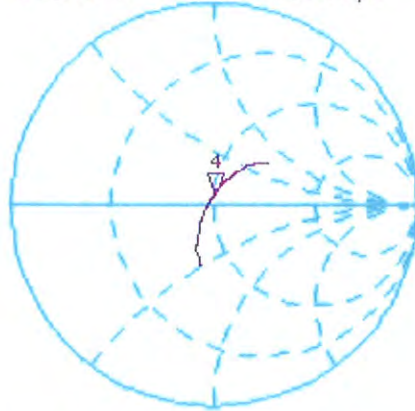

Avg  
16  
↑

CH2 S11 LOG 5 dB/REF -20 dB 4:-27.158 dB 2 450.000 000 MHz

CA  
Avg  
16  
↑



START 2 250.000 000 MHz

STOP 2 650.000 000 MHz



Accredited by the Swiss Accreditation Service (SAS)  
The Swiss Accreditation Service is one of the signatories to the EA  
Multilateral Agreement for the recognition of calibration certificates

Accreditation No.: **SCS 108**

Client **B.V. ADT (Auden)**

Certificate No: **D5GHzV2-1019\_Jan11**

## CALIBRATION CERTIFICATE

Object **D5GHzV2 - SN: 1019**

Calibration procedure(s) **QA CAL-22.v1**  
**Calibration procedure for dipole validation kits between 3-6 GHz**

Calibration date: **January 25, 2011**

This calibration certificate documents the traceability to national standards, which realize the physical units of measurements (SI).  
The measurements and the uncertainties with confidence probability are given on the following pages and are part of the certificate.

All calibrations have been conducted in the closed laboratory facility: environment temperature (22 ± 3)°C and humidity < 70%.



Calibration Equipment used (M&TE critical for calibration)

Primary Standards	ID #	Cal Date (Certificate No.)	Scheduled Calibration
Power meter EPM-442A	GB37480704	06-Oct-10 (No. 217-01266)	Oct-11
Power sensor HP 8481A	US37292783	06-Oct-10 (No. 217-01266)	Oct-11
Reference 20 dB Attenuator	SN: 5086 (20g)	30-Mar-10 (No. 217-01158)	Mar-11
Type-N mismatch combination	SN: 5047.2 / 06327	30-Mar-10 (No. 217-01162)	Mar-11
Reference Probe EX3DV4	SN: 3503	05-Mar-10 (No. EX3-3503_Mar10)	Mar-11
DAE4	SN: 60i	10-Jun-10 (No. DAE4-60i_Jun10)	Jun-11
Secondary Standards	ID #	Check Date (in house)	Scheduled Check
Power sensor HP 8481A	MY41092317	18-Oct-02 (in house check Oct-09)	In house check: Oct-11
RF generator R&S SMT-06	100005	4-Aug-99 (in house check Oct-09)	In house check: Oct-11
Network Analyzer HP 8753E	US37390585 S4206	18-Oct-01 (in house check Oct-10)	In house check: Oct-11

Calibrated by: **Jeton Kastrati**      Name: **Jeton Kastrati**      Function: **Laboratory Technician**

Approved by: **Katja Pokovic**      Name: **Katja Pokovic**      Function: **Technical Manager**

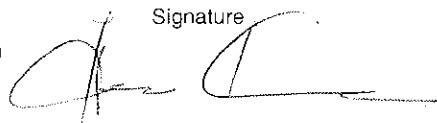
Signature

Issued: January 25, 2011

This calibration certificate shall not be reproduced except in full without written approval of the laboratory.



Accredited by the Swiss Accreditation Service (SAS)  
The Swiss Accreditation Service is one of the signatories to the EA  
Multilateral Agreement for the recognition of calibration certificates

Accreditation No.: **SCS 108**

### Glossary:

TSL	tissue simulating liquid
ConvF	sensitivity in TSL / NORM x,y,z
N/A	not applicable or not measured

### Calibration is Performed According to the Following Standards:

- a) IEC 62209-2, "Evaluation of Human Exposure to Radio Frequency Fields from Handheld and Body-Mounted Wireless Communication Devices in the Frequency Range of 30 MHz to 6 GHz: Human models, Instrumentation, and Procedures"; Part 2: "Procedure to determine the Specific Absorption Rate (SAR) for including accessories and multiple transmitters", March 2010
- b) Federal Communications Commission Office of Engineering & Technology (FCC OET), "Evaluating Compliance with FCC Guidelines for Human Exposure to Radiofrequency Electromagnetic Fields; Additional Information for Evaluating Compliance of Mobile and Portable Devices with FCC Limits for Human Exposure to Radiofrequency Emissions", Supplement C (Edition 01-01) to Bulletin 65

### Additional Documentation:

- c) DASY4/5 System Handbook

### Methods Applied and Interpretation of Parameters:

- *Measurement Conditions:* Further details are available from the Validation Report at the end of the certificate. All figures stated in the certificate are valid at the frequency indicated.
- *Antenna Parameters with TSL:* The dipole is mounted with the spacer to position its feed point exactly below the center marking of the flat phantom section, with the arms oriented parallel to the body axis.
- *Feed Point Impedance and Return Loss:* These parameters are measured with the dipole positioned under the liquid filled phantom. The impedance stated is transformed from the measurement at the SMA connector to the feed point. The Return Loss ensures low reflected power. No uncertainty required.
- *Electrical Delay:* One-way delay between the SMA connector and the antenna feed point. No uncertainty required.
- *SAR measured:* SAR measured at the stated antenna input power.
- *SAR normalized:* SAR as measured, normalized to an input power of 1 W at the antenna connector.
- *SAR for nominal TSL parameters:* The measured TSL parameters are used to calculate the nominal SAR result.

## Measurement Conditions

DASY system configuration, as far as not given on page 1.

DASY Version	DASY5	V52.6
Extrapolation	Advanced Extrapolation	
Phantom	Modular Flat Phantom V5.0	
Distance Dipole Center - TSL	10 mm	with Spacer
Area Scan resolution	dx, dy = 10 mm	
Zoom Scan Resolution	dx, dy = 4.0 mm, dz = 2.0 mm	
Frequency	5200 MHz ± 1 MHz 5500 MHz ± 1 MHz 5800 MHz ± 1 MHz	

## Head TSL parameters at 5200 MHz

The following parameters and calculations were applied.

	Temperature	Permittivity	Conductivity
Nominal Head TSL parameters	22.0 °C	36.0	4.66 mho/m
Measured Head TSL parameters	(22.0 ± 0.2) °C	35.3 ± 6 %	4.50 mho/m ± 6 %
Head TSL temperature during test	(21.8 ± 0.2) °C	----	----

## SAR result with Head TSL at 5200 MHz

SAR averaged over 1 cm <sup>3</sup> (1 g) of Head TSL	condition	
SAR measured	100 mW input power	8.21 mW / g
SAR normalized	normalized to 1W	82.1 mW / g
SAR for nominal Head TSL parameters	normalized to 1W	<b>81.8 mW / g ± 19.9 % (k=2)</b>

SAR averaged over 10 cm <sup>3</sup> (10 g) of Head TSL	condition	
SAR measured	100 mW input power	2.32 mW / g
SAR normalized	normalized to 1W	23.2 mW / g
SAR for nominal Head TSL parameters	normalized to 1W	<b>23.1 mW / g ± 19.5 % (k=2)</b>

### Head TSL parameters at 5500 MHz

The following parameters and calculations were applied.

	Temperature	Permittivity	Conductivity
Nominal Head TSL parameters	22.0 °C	35.6	4.96 mho/m
Measured Head TSL parameters	(22.0 ± 0.2) °C	36.2 ± 6 %	4.86 mho/m ± 6 %
Head TSL temperature during test	(21.8 ± 0.2) °C	----	----

### SAR result with Head TSL at 5500 MHz

SAR averaged over 1 cm <sup>3</sup> (1 g) of Head TSL	condition	
SAR measured	100 mW input power	8.87 mW / g
SAR normalized	normalized to 1W	88.7 mW / g
SAR for nominal Head TSL parameters	normalized to 1W	<b>88.9 mW / g ± 19.9 % (k=2)</b>

SAR averaged over 10 cm <sup>3</sup> (10 g) of Head TSL	condition	
SAR measured	100 mW input power	2.49 mW / g
SAR normalized	normalized to 1W	24.9 mW / g
SAR for nominal Head TSL parameters	normalized to 1W	<b>24.9 mW / g ± 19.5 % (k=2)</b>

### Head TSL parameters at 5800 MHz

The following parameters and calculations were applied.

	Temperature	Permittivity	Conductivity
Nominal Head TSL parameters	22.0 °C	35.3	5.27 mho/m
Measured Head TSL parameters	(22.0 ± 0.2) °C	35.5 ± 6 %	5.17 mho/m ± 6 %
Head TSL temperature during test	(21.8 ± 0.2) °C	----	----

### SAR result with Head TSL at 5800 MHz

SAR averaged over 1 cm <sup>3</sup> (1 g) of Head TSL	condition	
SAR measured	100 mW input power	8.32 mW / g
SAR normalized	normalized to 1W	83.2 mW / g
SAR for nominal Head TSL parameters	normalized to 1W	<b>83.2 mW / g ± 19.9 % (k=2)</b>

SAR averaged over 10 cm <sup>3</sup> (10 g) of Head TSL	condition	
SAR measured	100 mW input power	2.33 mW / g
SAR normalized	normalized to 1W	23.3 mW / g
SAR for nominal Head TSL parameters	normalized to 1W	<b>23.3 mW / g ± 19.5 % (k=2)</b>



### Body TSL parameters at 5200 MHz

The following parameters and calculations were applied.

	Temperature	Permittivity	Conductivity
Nominal Body TSL parameters	22.0 °C	49.0	5.30 mho/m
Measured Body TSL parameters	(22.0 ± 0.2) °C	47.2 ± 6 %	5.37 mho/m ± 6 %
Body TSL temperature during test	(21.5 ± 0.2) °C	----	----

### SAR result with Body TSL at 5200 MHz

SAR averaged over 1 cm <sup>3</sup> (1 g) of Body TSL	condition	
SAR measured	100 mW input power	7.77 mW / g
SAR normalized	normalized to 1W	77.7 mW / g
SAR for nominal Body TSL parameters	normalized to 1W	<b>77.1 mW / g ± 19.9 % (k=2)</b>

SAR averaged over 10 cm <sup>3</sup> (10 g) of Body TSL	condition	
SAR measured	100 mW input power	2.15 mW / g
SAR normalized	normalized to 1W	21.5 mW / g
SAR for nominal Body TSL parameters	normalized to 1W	<b>21.3 mW / g ± 19.5 % (k=2)</b>

### Body TSL parameters at 5500 MHz

The following parameters and calculations were applied.

	Temperature	Permittivity	Conductivity
Nominal Body TSL parameters	22.0 °C	48.6	5.65 mho/m
Measured Body TSL parameters	(22.0 ± 0.2) °C	46.6 ± 6 %	5.75 mho/m ± 6 %
Body TSL temperature during test	(21.5 ± 0.2) °C	----	----

### SAR result with Body TSL at 5500 MHz

SAR averaged over 1 cm <sup>3</sup> (1 g) of Body TSL	condition	
SAR measured	100 mW input power	8.31 mW / g
SAR normalized	normalized to 1W	83.1 mW / g
SAR for nominal Body TSL parameters	normalized to 1W	<b>82.4 mW / g ± 19.9 % (k=2)</b>

SAR averaged over 10 cm <sup>3</sup> (10 g) of Body TSL	condition	
SAR measured	100 mW input power	2.29 mW / g
SAR normalized	normalized to 1W	22.9 mW / g
SAR for nominal Body TSL parameters	normalized to 1W	<b>22.7 mW / g ± 19.5 % (k=2)</b>

## Body TSL parameters at 5800 MHz

The following parameters and calculations were applied.

	Temperature	Permittivity	Conductivity
Nominal Body TSL parameters	22.0 °C	48.2	6.00 mho/m
Measured Body TSL parameters	(22.0 ± 0.2) °C	46.1 ± 6 %	6.14 mho/m ± 6 %
Body TSL temperature during test	(21.5 ± 0.2) °C	----	----

## SAR result with Body TSL at 5800 MHz

SAR averaged over 1 cm <sup>3</sup> (1 g) of Body TSL	condition	
SAR measured	100 mW input power	7.40 mW / g
SAR normalized	normalized to 1W	74.0 mW / g
SAR for nominal Body TSL parameters	normalized to 1W	<b>73.4 mW / g ± 19.9 % (k=2)</b>

SAR averaged over 10 cm <sup>3</sup> (10 g) of Body TSL	condition	
SAR measured	100 mW input power	2.02 mW / g
SAR normalized	normalized to 1W	20.2 mW / g
SAR for nominal Body TSL parameters	normalized to 1W	<b>20.0 mW / g ± 19.5 % (k=2)</b>

## Appendix

### Antenna Parameters with Head TSL at 5200 MHz

Impedance, transformed to feed point	51.9 $\Omega$ - 8.4 j $\Omega$
Return Loss	-21.5 dB

### Antenna Parameters with Head TSL at 5500 MHz

Impedance, transformed to feed point	51.4 $\Omega$ - 2.1 j $\Omega$
Return Loss	-31.9 dB

### Antenna Parameters with Head TSL at 5800 MHz

Impedance, transformed to feed point	56.3 $\Omega$ + 2.6 j $\Omega$
Return Loss	-23.9 dB

### Antenna Parameters with Body TSL at 5200 MHz

Impedance, transformed to feed point	51.8 $\Omega$ - 6.7 j $\Omega$
Return Loss	-23.3 dB

### Antenna Parameters with Body TSL at 5500 MHz

Impedance, transformed to feed point	51.6 $\Omega$ - 0.4 j $\Omega$
Return Loss	-36.0 dB

### Antenna Parameters with Body TSL at 5800 MHz

Impedance, transformed to feed point	56.4 $\Omega$ + 3.9 j $\Omega$
Return Loss	-23.1 dB

## General Antenna Parameters and Design

Electrical Delay (one direction)	1.204 ns
----------------------------------	----------

After long term use with 40 W radiated power, only a slight warming of the dipole near the feedpoint can be measured.

The dipole is made of standard semirigid coaxial cable. The center conductor of the feeding line is directly connected to the second arm of the dipole. The antenna is therefore short-circuited for DC-signals.

No excessive force must be applied to the dipole arms, because they might bend or the soldered connections near the feedpoint may be damaged.

## Additional EUT Data

Manufactured by	SPEAG
Manufactured on	February 05, 2004

## DASY5 Validation Report for Head TSL

Date/Time: 25.01.2011 15:44:08

Test Laboratory: SPEAG, Zurich, Switzerland

**DUT: Dipole 5GHz; Type: D5GHz; Serial: D5GHzV2 - SN:1019**

Communication System: CW; Frequency: 5200 MHz, Frequency: 5500 MHz, Frequency: 5800 MHz; Duty Cycle: 1:1

Medium: HSL 5000

Medium parameters used:  $f = 5200$  MHz;  $\sigma = 4.51$  mho/m;  $\epsilon_r = 35.3$ ;  $\rho = 1000$  kg/m<sup>3</sup>,

Medium parameters used:  $f = 5500$  MHz;  $\sigma = 4.87$  mho/m;  $\epsilon_r = 36.2$ ;  $\rho = 1000$  kg/m<sup>3</sup>,

Medium parameters used:  $f = 5800$  MHz;  $\sigma = 5.18$  mho/m;  $\epsilon_r = 35.5$ ;  $\rho = 1000$  kg/m<sup>3</sup>

Phantom section: Flat Section

Measurement Standard: DASY5 (IEEE/IEC/ANSI C63.19-2007)

DASY5 Configuration:

- Probe: EX3DV4 - SN3503; ConvF(5.36, 5.36, 5.36), ConvF(4.85, 4.85, 4.85), ConvF(4.74, 4.74, 4.74); Calibrated: 05.03.2010
- Sensor-Surface: 2mm (Mechanical Surface Detection)
- Electronics: DAE4 Sn601; Calibrated: 10.06.2010
- Phantom: Flat Phantom 5.0 (front); Type: QD000P50AA; Serial: 1001
- Measurement SW: DASY52, V52.6.1 Build (408)
- Postprocessing SW: SEMCAD X, V14.4.2 Build (2595)

**Pin=100mW/d=10mm, f=5200 MHz/Zoom Scan (4x4x2mm), dist=2mm (8x8x6)/Cube 0:** Measurement grid: dx=4mm, dy=4mm, dz=2mm

Reference Value = 63.766 V/m; Power Drift = 0.13 dB

Peak SAR (extrapolated) = 31.432 W/kg

**SAR(1 g) = 8.21 mW/g; SAR(10 g) = 2.32 mW/g**

Maximum value of SAR (measured) = 16.241 mW/g

**Pin=100mW/d=10mm, f=5500 MHz/Zoom Scan (4x4x2mm), dist=2mm (8x8x6)/Cube 0:** Measurement grid: dx=4mm, dy=4mm, dz=2mm

Reference Value = 64.225 V/m; Power Drift = 0.13 dB

Peak SAR (extrapolated) = 36.205 W/kg

**SAR(1 g) = 8.87 mW/g; SAR(10 g) = 2.49 mW/g**

Maximum value of SAR (measured) = 17.917 mW/g

**Pin=100mW/d=10mm, f=5800 MHz/Zoom Scan (4x4x2mm), dist=2mm (8x8x6)/Cube 0:** Measurement grid: dx=4mm, dy=4mm, dz=4mm

Reference Value = 60.818 V/m; Power Drift = 0.12 dB

Peak SAR (extrapolated) = 37.120 W/kg

**SAR(1 g) = 8.32 mW/g; SAR(10 g) = 2.33 mW/g**

Maximum value of SAR (measured) = 16.571 mW/g

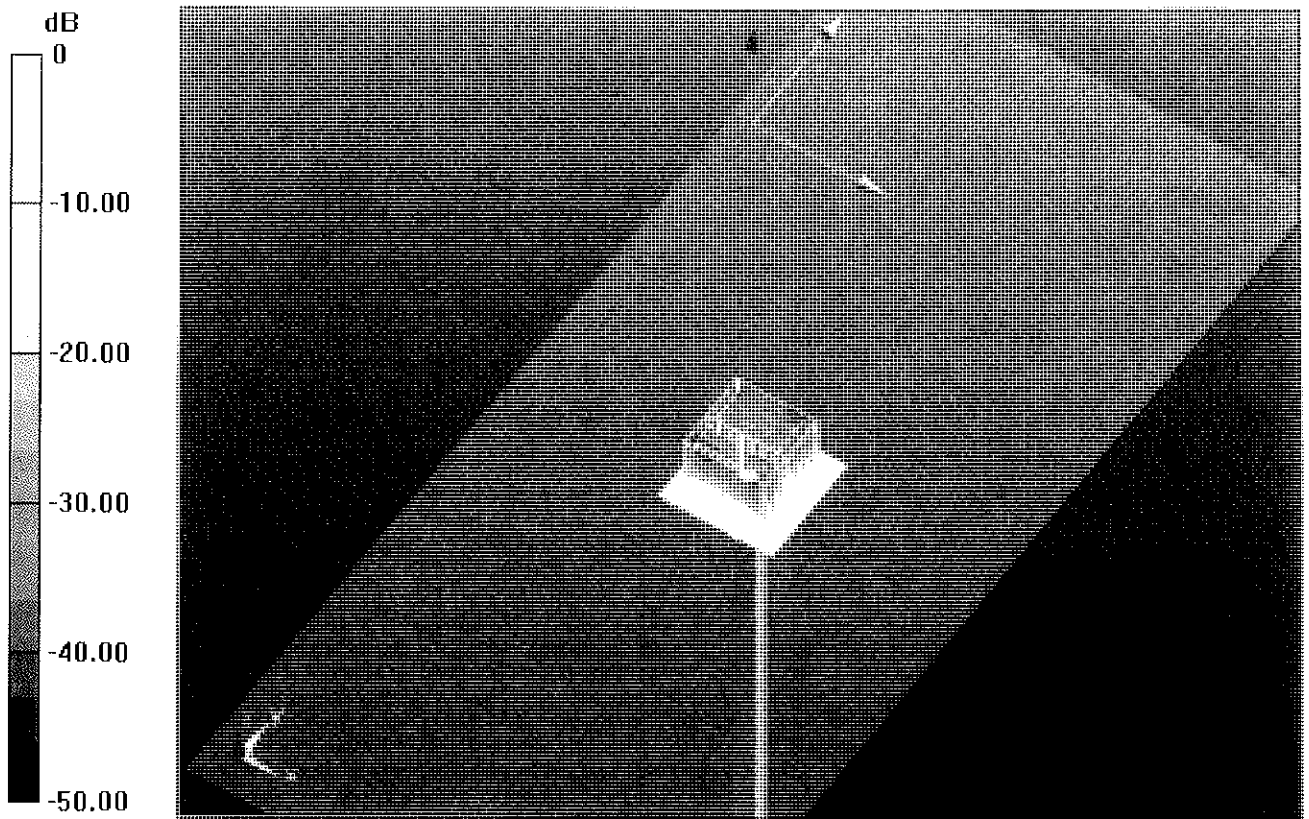

0 dB = 16.570mW/g

# Impedance Measurement Plot for Head TSL

17 Jan 2011 17:42:04

CH1 S11 1 U FS 1: 51.904  $\Omega$  -8.3555  $\Omega$  3.6631 pF 5 200.000 000 MHz

\*  
Gel  
Cor  
Avg  
16  
↑

CH1 Markers  
2: 51.426  $\Omega$   
-2.1426  $\Omega$   
5.50000 GHz  
3: 55.254  $\Omega$   
2.5820  $\Omega$   
5.00000 GHz

CH2 S11 LOG 5 dB/REF -20 dB 1:-21.534 dB 5 200.000 000 MHz

Cor  
Avg  
16  
↑

CH2 Markers  
2:-31.912 dB  
5.50000 GHz  
3:-23.923 dB  
5.00000 GHz

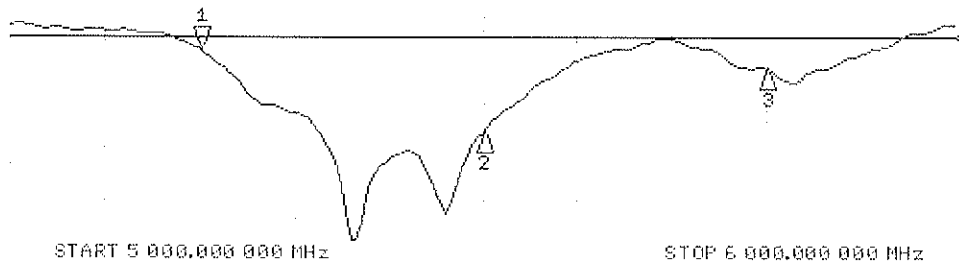

## DASY5 Validation Report for Body TSL

Date/Time: 19.01.2011 11:41:41

Test Laboratory: SPEAG, Zurich, Switzerland

### DUT: Dipole 5GHz; Type: D5GHz; Serial: D5GHzV2 - SN:1019

Communication System: CW; Frequency: 5200 MHz, Frequency: 5500 MHz, Frequency: 5800 MHz; Duty Cycle: 1:1

Medium: MSL 5000 MHz

Medium parameters used:  $f = 5200$  MHz;  $\sigma = 5.4$  mho/m;  $\epsilon_r = 47.2$ ;  $\rho = 1000$  kg/m<sup>3</sup>,

Medium parameters used:  $f = 5500$  MHz;  $\sigma = 5.78$  mho/m;  $\epsilon_r = 46.6$ ;  $\rho = 1000$  kg/m<sup>3</sup>,

Medium parameters used:  $f = 5800$  MHz;  $\sigma = 6.18$  mho/m;  $\epsilon_r = 46.1$ ;  $\rho = 1000$  kg/m<sup>3</sup>

Phantom section: Flat Section

Measurement Standard: DASY5 (IEEE/IEC/ANSI C63.19-2007)

#### DASY5 Configuration:

- Probe: EX3DV4 - SN3503; ConvF(4.88, 4.88, 4.88), ConvF(4.37, 4.37, 4.37), ConvF(4.57, 4.57, 4.57); Calibrated: 05.03.2010
- Sensor-Surface: 2mm (Mechanical Surface Detection)
- Electronics: DAE4 Sn601; Calibrated: 10.06.2010
- Phantom: Flat Phantom 5.0 (back); Type: QD000P50AA; Serial: 1002
- Measurement SW: DASY52, V52.6.1 Build (408)
- Postprocessing SW: SEMCAD X, V14.4.2 Build (2595)

**Pin=100mW/d=10mm, f=5200 MHz/Zoom Scan (4x4x2mm), dist=2mm (8x8x6)/Cube 0:** Measurement grid: dx=4mm, dy=4mm, dz=2mm

Reference Value = 60.081 V/m; Power Drift = -0.06 dB

Peak SAR (extrapolated) = 30.750 W/kg

**SAR(1 g) = 7.77 mW/g; SAR(10 g) = 2.15 mW/g**

Maximum value of SAR (measured) = 15.289 mW/g

**Pin=100mW/d=10mm, f=5500 MHz/Zoom Scan (4x4x2mm), dist=2mm (8x8x6)/Cube 0:** Measurement grid: dx=4mm, dy=4mm, dz=2mm

Reference Value = 60.368 V/m; Power Drift = 0.01 dB

Peak SAR (extrapolated) = 35.267 W/kg

**SAR(1 g) = 8.31 mW/g; SAR(10 g) = 2.29 mW/g**

Maximum value of SAR (measured) = 16.599 mW/g

**Pin=100mW/d=10mm, f=5800 MHz/Zoom Scan (4x4x2mm), dist=2mm (8x8x6)/Cube 0:** Measurement grid: dx=4mm, dy=4mm, dz=4mm

Reference Value = 54.998 V/m; Power Drift = -0.0083 dB

Peak SAR (extrapolated) = 35.336 W/kg

**SAR(1 g) = 7.4 mW/g; SAR(10 g) = 2.02 mW/g**

Maximum value of SAR (measured) = 14.674 mW/g



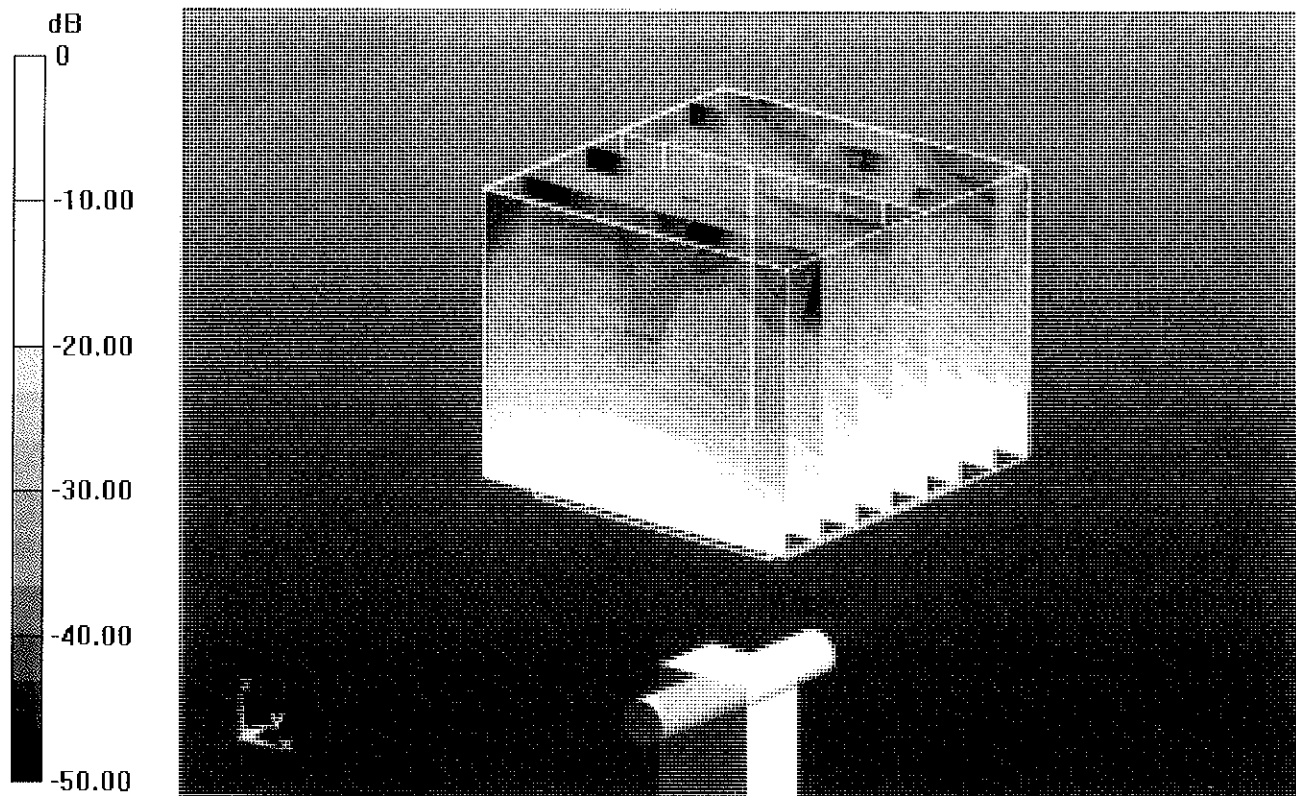

0 dB = 14.670mW/g

# Impedance Measurement Plot for Body TSL

19 Jan 2011 09:35:32

CH1 S11 1 U FS 1: 51.754  $\Omega$  -6.7227  $\Omega$  4.5528 pF 5 200.000 000 MHz

\*

Del

Cor

avg  
16

CH1 Markers

2: 51.551  $\Omega$   
-417.97  $\Omega$   
5.50000 GHz  
3: 56.357  $\Omega$   
3.9434  $\Omega$   
5.00000 GHz

CH2 S11 LOG 5 dB/REF -20 dB 1: -23.328 dB 5 200.000 000 MHz

Cor

avg  
16

CH2 Markers

2: -36.029 dB  
5.50000 GHz  
3: -23.065 dB  
5.00000 GHz

