



A D T

# FCC TEST REPORT (15.407)

**REPORT NO.:** RF990527C07-1

**MODEL NO.:** WNHD3004

**FCC ID:** PY309400127

**RECEIVED:** May 27, 2010

**TESTED:** Jun. 02 ~ Jul. 26, 2010

**ISSUED:** Jul. 28, 2010

**APPLICANT:** Netgear Incorporated

**ADDRESS:** 350 East Plumeria Drive San Jose, CA 95134  
U.S.A

**ISSUED BY:** Bureau Veritas Consumer Products Services  
(H.K.) Ltd., Taoyuan Branch

**LAB ADDRESS:** No. 47, 14th Ling, Chia Pau Tsuen, Lin Kou  
Hsiang, Taipei Hsien 244, Taiwan, R.O.C.

**TEST LOCATION:** No. 19, Hwa Ya 2nd Rd, Wen Hwa Tsuen, Kwei  
Shan Hsiang, Taoyuan Hsien 333, Taiwan, R.O.C.

This test report consists of 71 pages in total. It may be duplicated completely for legal use with the approval of the applicant. It should not be reproduced except in full, without the written approval of our laboratory. The client should not use it to claim product certification, approval, or endorsement by TAF or any government agency. The test results in the report only apply to the tested sample.





## TABLE OF CONTENTS

1.	CERTIFICATION.....	4
2.	SUMMARY OF TEST RESULTS .....	5
2.1	MEASUREMENT UNCERTAINTY.....	5
3.	GENERAL INFORMATION.....	6
3.1	GENERAL DESCRIPTION OF EUT .....	6
3.2	DESCRIPTION OF TEST MODES .....	8
3.2.1	CONFIGURATION OF SYSTEM UNDER TEST .....	8
3.2.2	TEST MODE APPLICABILITY AND TESTED CHANNEL DETAIL .....	9
3.3	GENERAL DESCRIPTION OF APPLIED STANDARDS .....	11
3.4	DESCRIPTION OF SUPPORT UNITS .....	11
4.	TEST TYPES AND RESULTS .....	12
4.1	RADIATED EMISSION MEASUREMENT .....	12
4.1.1	LIMITS OF RADIATED EMISSION MEASUREMENT.....	12
4.1.2	LIMITS OF UNWANTED EMISSION OUT OF THE RESTRICTED BANDS .....	12
4.1.3	TEST INSTRUMENTS.....	13
4.1.4	TEST PROCEDURES .....	14
4.1.5	DEVIATION FROM TEST STANDARD.....	14
4.1.6	TEST SETUP .....	15
4.1.7	EUT OPERATING CONDITION.....	15
4.1.8	TEST RESULTS .....	16
4.2	CONDUCTED EMISSION MEASUREMENT .....	26
4.2.1	LIMITS OF CONDUCTED EMISSION MEASUREMENT.....	26
4.2.2	TEST INSTRUMENTS.....	26
4.2.3	TEST PROCEDURES .....	27
4.2.4	DEVIATION FROM TEST STANDARD.....	27
4.2.5	TEST SETUP .....	28
4.2.6	EUT OPERATING CONDITIONS .....	28
4.2.7	TEST RESULTS .....	29
4.3	MAXIMUM CONDUCTED OUTPUT POWER MEASUREMENT .....	33
4.3.1	LIMITS OF MAXIMUM CONDUCTED OUTPUT POWER MEASUREMENT.....	33
4.3.2	TEST INSTRUMENTS.....	33
4.3.3	TEST PROCEDURE.....	34
4.3.4	DEVIATION FROM TEST STANDARD.....	34
4.3.5	TEST SETUP .....	34
4.3.6	EUT OPERATING CONDITIONS .....	34
4.3.7	TEST RESULTS .....	35



A D T

4.4	PEAK POWER EXCURSION MEASUREMENT .....	39
4.4.1	LIMITS OF PEAK POWER EXCURSION MEASUREMENT .....	39
4.4.2	TEST INSTRUMENTS.....	39
4.4.3	TEST PROCEDURE.....	39
4.4.4	DEVIATION FROM TEST STANDARD.....	40
4.4.5	TEST SETUP .....	40
4.4.6	EUT OPERATING CONDITIONS .....	40
4.4.7	TEST RESULTS .....	41
4.5	PEAK POWER SPECTRAL DENSITY MEASUREMENT .....	47
4.5.1	LIMITS OF PEAK POWER SPECTRAL DENSITY MEASUREMENT .....	47
4.5.2	TEST INSTRUMENTS.....	47
4.5.3	TEST PROCEDURES .....	47
4.5.4	DEVIATION FROM TEST STANDARD.....	48
4.5.5	TEST SETUP .....	48
4.5.6	EUT OPERATING CONDITIONS .....	48
4.5.7	TEST RESULTS .....	49
4.6	FREQUENCY STABILITY.....	52
4.6.1	LIMITS OF FREQUENCY STABILITY MEASUREMENT .....	52
4.6.2	TEST INSTRUMENTS.....	52
4.6.3	TEST PROCEDURE.....	52
4.6.4	DEVIATION FROM TEST STANDARD.....	53
4.6.5	TEST SETUP .....	53
4.6.6	EUT OPERATING CONDITION.....	53
4.6.7	TEST RESULTS .....	54
4.7	BAND EDGES MEASUREMENT .....	55
4.7.1	TEST INSTRUMENTS.....	55
4.7.2	TEST PROCEDURE.....	56
4.7.3	EUT OPERATING CONDITION.....	56
4.7.4	TEST RESULTS .....	57
5.	PHOTOGRAPHS OF THE TEST CONFIGURATION.....	69
6.	INFORMATION ON THE TESTING LABORATORIES .....	70
7.	APPENDIX A - MODIFICATIONS RECORDERS FOR ENGINEERING CHANGES TO THE EUT BY THE LAB.....	71



A D T

## 1. CERTIFICATION

**PRODUCT:** High-Performance Wireless-N HD Home Theater Adapter  
**MODEL NO.:** WNHD3004  
**BRAND:** NETGEAR  
**APPLICANT:** Netgear Incorporated  
**TEST SAMPLE:** ENGINEERING SAMPLE  
**TESTED:** Jun. 02 ~ Jul. 26, 2010  
**STANDARDS:** **FCC Part 15, Subpart E (Section 15.407)**  
ANSI C63.4-2003

The above equipment (Model: WNHD3004) has been tested by **Bureau Veritas Consumer Products Services (H.K.) Ltd., Taoyuan Branch**, and found compliance with the requirement of the above standards. The test record, data evaluation & Equipment Under Test (EUT) configurations represented herein are true and accurate accounts of the measurements of the sample's EMC characteristics under the conditions specified in this report.

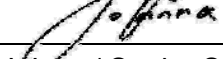
**PREPARED BY** :  , **DATE** : Jul. 28, 2010  
Joanna Wang / Senior Specialist

**TECHNICAL ACCEPTANCE** :  , **DATE** : Jul. 28, 2010  
Responsible for RF Long Chen / Senior Engineer

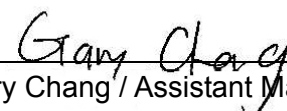
**APPROVED BY** :  , **DATE** : Jul. 28, 2010  
Gary Chang / Assistant Manager



## 2. SUMMARY OF TEST RESULTS

The EUT has been tested according to the following specifications:

APPLIED STANDARD: FCC PART 15, SUBPART E (SECTION 15.407)			
STANDARD SECTION	TEST TYPE AND LIMIT	RESULT	REMARK
15.407(b)(5)	AC Power Conducted Emission	PASS	Meet the requirement of limit. Minimum passing margin is -3.41dB at 0.250MHz.
15.407(b)(1/2/3) (b)(5)	Electric Field Strength Spurious Emissions, 30MHz ~ 40000MHz	PASS	Meet the requirement of limit. Minimum passing margin is -1.2dB at 5140.00MHz.
15.407(a)(1/2/3)	Peak Transmit Power	PASS	Meet the requirement of limit.
15.407(a)(6)	Peak Power Excursion	PASS	Meet the requirement of limit.
15.407(a)(1/2/3)	Peak Power Spectral Density	PASS	Meet the requirement of limit.
15.407(g)	Frequency Stability	PASS	Meet the requirement of limit.
15.203	Antenna Requirement	PASS	No antenna connector is used.
2.1091	Radiofrequency Radiation Exposure Evaluation	PASS	Meet the requirement of limit.

### 2.1 MEASUREMENT UNCERTAINTY

Where relevant, the following measurement uncertainty levels have been estimated for tests performed on the EUT as specified in CISPR 16-4-2:

MEASUREMENT	FREQUENCY	UNCERTAINTY
Conducted emissions	9kHz~30MHz	2.44dB
Radiated emissions	30MHz ~ 200MHz	2.93dB
	200MHz ~1000MHz	2.95dB
	1GHz ~ 18GHz	2.26dB
	18GHz ~ 40GHz	1.94dB

This uncertainty represents an expanded uncertainty expressed at approximately the 95% confidence level using a coverage factor of  $k = 2$ .



### 3. GENERAL INFORMATION

#### 3.1 GENERAL DESCRIPTION OF EUT

<b>PRODUCT</b>	High-Performance Wireless-N HD Home Theater Adapter
<b>MODEL NO.</b>	WNHD3004
<b>FCC ID</b>	PY309400127
<b>NOMINAL VOLTAGE</b>	12Vdc
<b>MODULATION TYPE</b>	64QAM, 16QAM, QPSK, BPSK for OFDM
<b>MODULATION TECHNOLOGY</b>	OFDM
<b>TRANSFER RATE</b>	802.11a: 54.0/ 48.0/ 36.0/ 24.0/ 18.0/ 12.0/ 9.0/ 6.0Mbps 802.11n: up to 300.0Mbps
<b>OPERATING FREQUENCY</b>	5180.0 ~ 5240.0MHz
<b>NUMBER OF CHANNEL</b>	4 for 802.11a, 802.11n (20MHz) 2 for 802.11n (40MHz)
<b>OUTPUT POWER</b>	38.1mW
<b>ANTENNA TYPE</b>	Beta-2 cut antenna with 4dBi gain
<b>ANTENNA CONNECTER</b>	NA
<b>DATA CABLE</b>	NA
<b>I/O PORTS</b>	RJ45
<b>ACCESSORY DEVICES</b>	Adapter

**NOTE:**

1. The EUT is a High-Performance Wireless-N HD Home Theater Adapter. The test data are separated into following test reports:

	<b>TEST STANDARD</b>	<b>REFERENCE REPORT</b>
<b>WLAN 802.11a, 802.11n (5745~5805 MHz)</b>	FCC Part 15, Subpart C (Section 15.247)	RF990527C07
<b>WLAN 802.11a, 802.11n (5180~ 5240MHz)</b>	FCC Part 15, Subpart E (Section 15.407)	RF990527C07-1

2. The frequency bands used in this EUT are listed as follows:

<b>Frequency Band (MHz)</b>	<b>5180~5240</b>	<b>5745~5805</b>
<b>802.11a</b>	√	√
<b>802.11n (20MHz)</b>	√	√
<b>802.11n (40MHz)</b>	√	√

3. The EUT incorporates a MIMO function. Physically, the EUT provides four completed transmitters and four receivers.

<b>MODULATION MODE</b>	<b>TX FUNCTION</b>
802.11a	4TX
802.11n (20MHz)	4TX
802.11n (40MHz)	4TX

4. The EUT was powered by the following adapters.

<b>ADAPTER 1</b>	
<b>BRAND</b>	NETGEAR
<b>MODEL</b>	MT12-Y120100-A1
<b>INPUT POWER</b>	100-120Vac, 60Hz, 0.3A
<b>OUTPUT POWER</b>	12Vdc, 1.0A
<b>POEWR LINE</b>	1.8m non-shielded cable without core

<b>ADAPTER 2</b>	
<b>BRAND</b>	NETGEAR
<b>MODEL</b>	T012LF1209 16100-2LF
<b>INPUT POWER</b>	100-120Vac, 50/60Hz, 0.5A
<b>OUTPUT POWER</b>	12Vdc, 1.0A
<b>POEWR LINE</b>	1.8m non-shielded cable without core

5. The above EUT information was declared by manufacturer and for more detailed features description, please refer to the manufacturer's specifications or user's manual.

### 3.2 DESCRIPTION OF TEST MODES

4 channels are provided for 802.11a and 802.11n (20MHz):

CHANNEL	FREQUENCY	CHANNEL	FREQUENCY
36	5180MHz	44	5220MHz
40	5200MHz	48	5240MHz

2 channels are provided for 802.11n (40MHz):

CHANNEL	FREQUENCY	CHANNEL	FREQUENCY
38	5190MHz	46	5230MHz

#### 3.2.1 CONFIGURATION OF SYSTEM UNDER TEST

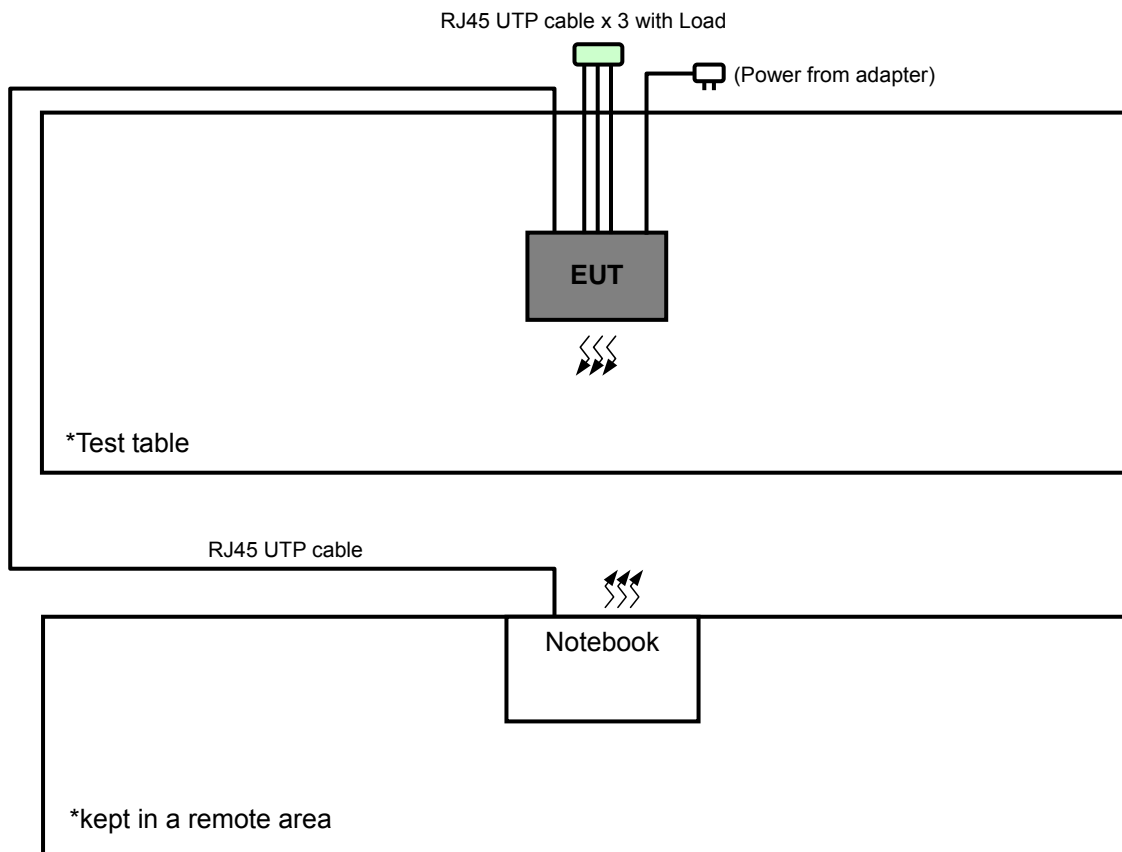





### 3.2.2 TEST MODE APPLICABILITY AND TESTED CHANNEL DETAIL

EUT CONFIGURE MODE	APPLICABLE TO				DESCRIPTION
	RE≥1G	RE<1G	PLC	APCM	
A	√	√	√	√	Adapter 1: MT12-Y120100-A1
B	-	√	√	-	Adapter 2: T012LF1209 16100-2LF

Where **RE≥1G**: Radiated Emission above 1GHz      **RE<1G**: Radiated Emission below 1GHz  
**PLC**: Power Line Conducted Emission      **APCM**: Antenna Port Conducted Measurement

**NOTE:** “-” means no effect.

#### RADIATED EMISSION TEST (ABOVE 1GHz):

- Pre-Scan has been conducted to determine the worst-case mode from all possible combinations between available modulations, data rates, XYZ axis and antenna ports (if EUT with antenna diversity architecture).
- Following channel(s) was (were) selected for the final test as listed below.

EUT CONFIGURE MODE	MODE	AVAILABLE CHANNEL	TESTED CHANNEL	MODULATION TECHNOLOGY	MODULATION TYPE	DATA RATE (Mbps)	AXIS
A	802.11a	36 to 48	36, 40, 48	OFDM	BPSK	6.0	Z
A	802.11n (20MHz)	36 to 48	36, 40, 48	OFDM	BPSK	7.2	Z
A	802.11n (40MHz)	38 to 46	38, 46	OFDM	BPSK	15.0	Z

#### RADIATED EMISSION TEST (BELOW 1GHz):

- Pre-Scan has been conducted to determine the worst-case mode from all possible combinations between available modulations, data rates, XYZ axis and antenna ports (if EUT with antenna diversity architecture).
- Following channel(s) was (were) selected for the final test as listed below.

EUT CONFIGURE MODE	MODE	AVAILABLE CHANNEL	TESTED CHANNEL	MODULATION TECHNOLOGY	MODULATION TYPE	DATA RATE (Mbps)	AXIS
A, B	802.11n (40MHz)	38 to 46	46	OFDM	BPSK	15.0	Z

#### POWER LINE CONDUCTED EMISSION TEST:

- Pre-Scan has been conducted to determine the worst-case mode from all possible combinations between available modulations, data rates and antenna ports (if EUT with antenna diversity architecture).
- Following channel(s) was (were) selected for the final test as listed below.

EUT CONFIGURE MODE	MODE	AVAILABLE CHANNEL	TESTED CHANNEL	MODULATION TECHNOLOGY	MODULATION TYPE	DATA RATE (Mbps)
A, B	802.11n (40MHz)	38 to 46	46	OFDM	BPSK	15.0



**BANDEDGE MEASUREMENT:**

- Pre-Scan has been conducted to determine the worst-case mode from all possible combinations between available modulations, data rates, XYZ axis and antenna ports (if EUT with antenna diversity architecture).
- Following channel(s) was (were) selected for the final test as listed below.

EUT CONFIGURE MODE	MODE	AVAILABLE CHANNEL	TESTED CHANNEL	MODULATION TECHNOLOGY	MODULATION TYPE	DATA RATE (Mbps)	AXIS
A	802.11a	36 to 48	36, 48	OFDM	BPSK	6.0	Z
A	802.11n (20MHz)	36 to 48	36, 48	OFDM	BPSK	7.2	Z
A	802.11n (40MHz)	38 to 46	38, 46	OFDM	BPSK	15.0	Z

**ANTENNA PORT CONDUCTED MEASUREMENT:**

- This item includes all test value of each mode, but only includes spectrum plot of worst value of each mode.
- Pre-Scan has been conducted to determine the worst-case mode from all possible combinations between available modulations, data rates and antenna ports (if EUT with antenna diversity architecture).
- Following channel(s) was (were) selected for the final test as listed below.

EUT CONFIGURE MODE	MODE	AVAILABLE CHANNEL	TESTED CHANNEL	MODULATION TECHNOLOGY	MODULATION TYPE	DATA RATE (Mbps)
A	802.11a	36 to 48	36, 40, 48	OFDM	BPSK	6.0
A	802.11n (20MHz)	36 to 48	36, 40, 48	OFDM	BPSK	7.2
A	802.11n (40MHz)	38 to 46	38, 46	OFDM	BPSK	15.0

**TEST CONDITION:**

APPLICABLE TO	ENVIRONMENTAL CONDITIONS	INPUT POWER	TESTED BY
RE≥1G	25deg. C, 65%RH, 1000hPa	120Vac, 60Hz	Mark Liao
RE<1G	26deg. C, 66%RH, 1007hPa	120Vac, 60Hz	Antony Lee
PLC	22deg. C, 65%RH, 1006hPa	120Vac, 60Hz	Daniel Lin
APCM	25deg. C, 65%RH, 1006hPa	120Vac, 60Hz	Mark Liao



### 3.3 GENERAL DESCRIPTION OF APPLIED STANDARDS

The EUT is a RF Product. According to the specifications of the manufacturer, it must comply with the requirements of the following standards:

#### FCC Part 15, Subpart E (15.407)

#### ANSI C63.4-2003

All test items have been performed and recorded as per the above standards.

**NOTE:** The EUT is also considered as a kind of computer peripheral, because the connection to computer is necessary for typical use. It has been verified to comply with the requirements of FCC Part 15, Subpart B, Class B (DoC). The test report has been issued separately.

### 3.4 DESCRIPTION OF SUPPORT UNITS

The EUT has been tested as an independent unit together with other necessary accessories or support units. The following support units or accessories were used to form a representative test configuration during the tests.

NO.	PRODUCT	BRAND	MODEL NO.	SERIAL NO.	FCC ID
1	NOTEBOOK	DELL	D600	CN-0C3038-48643 -3A8-8646	QDS-BRCM1005-D

NO.	SIGNAL CABLE DESCRIPTION OF THE ABOVE SUPPORT UNITS
1	10m UTP RJ45 cable

**NOTE:** 1. All power cords of the above support units are non shielded (1.8m).  
2. Item 1 acted as a communication partner to transfer data.



## 4. TEST TYPES AND RESULTS

### 4.1 RADIATED EMISSION MEASUREMENT

#### 4.1.1 LIMITS OF RADIATED EMISSION MEASUREMENT

Emissions radiated outside of the specified bands, shall be according to the general radiated limits in 15.209 as following:

FREQUENCIES (MHz)	FIELD STRENGTH (microvolts/meter)	MEASUREMENT DISTANCE (meters)
0.009 ~ 0.490	2400/F(kHz)	300
0.490 ~ 1.705	24000/F(kHz)	30
1.705 ~ 30.0	30	30
30 ~ 88	100	3
88 ~ 216	150	3
216 ~ 960	200	3
Above 960	500	3

**NOTE:**

1. The lower limit shall apply at the transition frequencies.
2. Emission level (dBuV/m) = 20 log Emission level (uV/m).
3. As shown in 15.35(b), for frequencies above 1000MHz, the field strength limits are based on average detector, however, the peak field strength of any emission shall not exceed the maximum permitted average limits, specified above by more than 20dB under any condition of modulation.

#### 4.1.2 LIMITS OF UNWANTED EMISSION OUT OF THE RESTRICTED BANDS

FREQUENCIES (MHz)	EIRP LIMIT (dBm)	EQUIVALENT FIELD STRENGTH AT 3m (dBµV/m) *NOTE 3
	PK	PK
5150 ~ 5250	-27	68.3

**NOTE:** The following formula is used to convert the equipment isotropic radiated power (eirp) to field strength:

$$E = \frac{1000000\sqrt{30P}}{3} \mu\text{V/m, where P is the eirp (Watts).$$



A D T

#### 4.1.3 TEST INSTRUMENTS

DESCRIPTION & MANUFACTURER	MODEL NO.	SERIAL NO.	DATE OF CALIBRATION	DUE DATE OF CALIBRATION
Test Receiver ROHDE & SCHWARZ	ESIB7	100188	Dec. 21, 2009	Dec. 20, 2010
Spectrum Analyzer ROHDE & SCHWARZ	FSP40	100041	Jul. 09, 2010	Jul. 08, 2011
BILOG Antenna SCHWARZBECK	VULB9168	9168-156	Apr. 30, 2010	Apr. 29, 2011
HORN Antenna SCHWARZBECK	BBHA 9120 D	9120D-563	Aug. 10, 2009	Aug. 09, 2010
HORN Antenna SCHWARZBECK	BBHA 9170	BBHA9170242	Dec. 25, 2009	Dec. 24, 2010
Preamplifier Agilent	8449B	3008A01910	Sep. 11, 2009	Sep. 10, 2010
Preamplifier Agilent	8447D	2944A10638	Dec. 21, 2009	Dec. 20, 2010
RF signal cable HUBER+SUHNNER	SUCOFLEX 104	218190/4 231241/4	May 14, 2010	May 13, 2011
RF signal cable Worken	8D-FB	Cable-HYCH9-01	Aug. 17, 2009	Aug. 16, 2010
Software	ADT_Radiated_ V7.6.15.9.2	NA	NA	NA
Antenna Tower EMCO	2070/2080	512.835.4684	NA	NA
Turn Table EMCO	2087-2.03	NA	NA	NA
Antenna Tower & Turn Table Controller EMCO	2090	NA	NA	NA
26GHz ~ 40GHz Amplifier	EM26400	07026401	Aug. 27, 2009	Aug. 26, 2010

- NOTE:**
1. The calibration interval of the above test instruments is 12 months and the calibrations are traceable to NML/ROC and NIST/USA.
  2. The test was performed in HwaYa Chamber 9.
  3. The horn antenna and HP preamplifier (model: 8449B) are used only for the measurement of emission frequency above 1GHz if tested.
  4. The FCC Site Registration No. is 460141.
  5. The IC Site Registration No. is IC 7450F-4.



#### 4.1.4 TEST PROCEDURES

- a. The EUT was placed on the top of a rotating table 0.8 meters above the ground at a 3 meter semi-anechoic chamber. The table was rotated 360 degrees to determine the position of the highest radiation.
- b. The EUT was set 3 meters away from the interference-receiving antenna, which was mounted on the top of a variable-height antenna tower.
- c. The antenna is a broadband antenna, and its height is varied from one meter to four meters above the ground to determine the maximum value of the field strength. Both horizontal and vertical polarizations of the antenna are set to make the measurement.
- d. For each suspected emission, the EUT was arranged to its worst case and then the antenna was tuned to heights from 1 meter to 4 meters and the rotatable table was turned from 0 degrees to 360 degrees to find the maximum reading.
- e. The test-receiver system was set to Peak Detect Function and Specified Bandwidth with Maximum Hold Mode.
- f. If the emission level of the EUT in peak mode was 10dB lower than the limit specified, then testing could be stopped and the peak values of the EUT would be reported. Otherwise the emissions that did not have 10dB margin would be re-tested one by one using peak, quasi-peak or average method as specified and then reported in a data sheet.

**NOTE:**

1. The resolution bandwidth and video bandwidth of test receiver/spectrum analyzer is 120kHz for Peak detection (PK) and Quasi-peak detection (QP) at frequency below 1GHz.
2. The resolution bandwidth of test receiver/spectrum analyzer is 1MHz and video bandwidth is 3MHz for Peak detection at frequency above 1GHz.
3. The resolution bandwidth of test receiver/spectrum analyzer is 1MHz and the video bandwidth is 10Hz for Average detection (AV) at frequency above 1GHz.
4. All modes of operation were investigated and the worst-case emissions are reported.

#### 4.1.5 DEVIATION FROM TEST STANDARD

No deviation.

#### 4.1.6 TEST SETUP

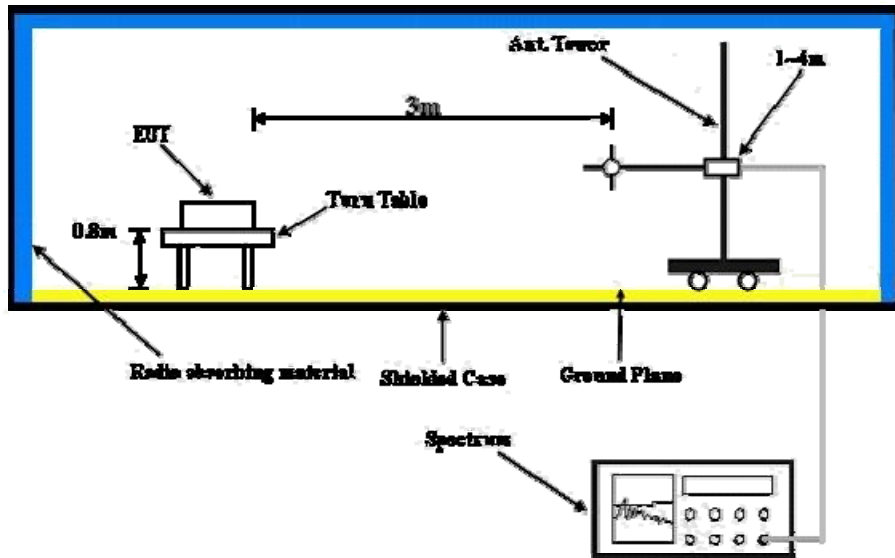

For the actual test configuration, please refer to the attached file (Test Setup Photo).

#### 4.1.7 EUT OPERATING CONDITION

- Placed the EUT on the testing table.
- Prepared notebook system to act as a communication partner and placed them outside of testing area.
- The communication partner connected with EUT via RJ45 UTP cable and run a test program (provided by manufacturer) to enable EUT under transmission condition continuously at specific channel frequency.



A D T

#### 4.1.8 TEST RESULTS

##### ABOVE 1GHz WORST-CASE DATA : 802.11a

EUT TEST CONDITION		MEASUREMENT DETAIL	
CHANNEL	Channel 36	FREQUENCY RANGE	1 ~ 40GHz
INPUT POWER	120Vac, 60 Hz	DETECTOR FUNCTION	Peak (PK) Average (AV)
ENVIRONMENTAL CONDITIONS	25deg. C, 65%RH 1000 hPa	TESTED BY	Mark Liao

ANTENNA POLARITY & TEST DISTANCE: HORIZONTAL AT 3 M								
NO.	FREQ. (MHz)	EMISSION LEVEL (dBuV/m)	LIMIT (dBuV/m)	MARGIN (dB)	ANTENNA HEIGHT (m)	TABLE ANGLE (Degree)	RAW VALUE (dBuV)	CORRECTION FACTOR (dB/m)
1	5150.00	57.2 PK	74.0	-16.8	1.12 H	79	18.20	39.00
2	5150.00	44.3 AV	54.0	-9.7	1.12 H	79	5.30	39.00
3	*5180.00	106.8 PK			1.10 H	119	67.80	39.00
4	*5180.00	96.0 AV			1.10 H	119	57.00	39.00
5	#10360.00	58.8 PK	68.3	-29.5	1.39 H	225	10.10	48.70
ANTENNA POLARITY & TEST DISTANCE: VERTICAL AT 3 M								
NO.	FREQ. (MHz)	EMISSION LEVEL (dBuV/m)	LIMIT (dBuV/m)	MARGIN (dB)	ANTENNA HEIGHT (m)	TABLE ANGLE (Degree)	RAW VALUE (dBuV)	CORRECTION FACTOR (dB/m)
1	5140.00	61.9 PK	74.0	-12.1	1.07 V	85	23.00	38.90
2	5140.00	52.8 AV	54.0	-1.2	1.07 V	85	13.90	38.90
3	*5180.00	111.2 PK			1.17 V	80	72.20	39.00
4	*5180.00	100.0 AV			1.17 V	80	61.00	39.00
5	#10360.00	59.4 PK	68.3	-28.9	1.00 V	325	10.70	48.70

- REMARKS:**
1. Emission level (dBuV/m) = Raw Value (dBuV) + Correction Factor (dB/m).
  2. Correction Factor (dB/m) = Antenna Factor (dB/m) + Cable Factor (dB).
  3. The other emission levels were very low against the limit.
  4. Margin value = Emission level – Limit value.
  5. " \* " : Fundamental frequency.
  6. "#": The radiated frequency is out the restricted band.





A D T

EUT TEST CONDITION		MEASUREMENT DETAIL	
CHANNEL	Channel 40	FREQUENCY RANGE	1 ~ 40GHz
INPUT POWER	120Vac, 60 Hz	DETECTOR FUNCTION	Peak (PK) Average (AV)
ENVIRONMENTAL CONDITIONS	25deg. C, 65%RH 1000 hPa	TESTED BY	Mark Liao

ANTENNA POLARITY & TEST DISTANCE: HORIZONTAL AT 3 M								
NO.	FREQ. (MHz)	EMISSION LEVEL (dBuV/m)	LIMIT (dBuV/m)	MARGIN (dB)	ANTENNA HEIGHT (m)	TABLE ANGLE (Degree)	RAW VALUE (dBuV)	CORRECTION FACTOR (dB/m)
1	*5200.00	106.2 PK			1.10 H	127	67.20	39.00
2	*5200.00	95.5 AV			1.10 H	127	56.50	39.00
3	#10400.00	59.0 PK	68.3	-29.3	1.35 H	188	10.30	48.70
ANTENNA POLARITY & TEST DISTANCE: VERTICAL AT 3 M								
NO.	FREQ. (MHz)	EMISSION LEVEL (dBuV/m)	LIMIT (dBuV/m)	MARGIN (dB)	ANTENNA HEIGHT (m)	TABLE ANGLE (Degree)	RAW VALUE (dBuV)	CORRECTION FACTOR (dB/m)
1	*5200.00	111.7 PK			1.15 V	76	72.70	39.00
2	*5200.00	100.6 AV			1.15 V	76	61.60	39.00
3	#10400.00	59.7 PK	68.3	-28.6	1.02 V	310	11.00	48.70

- REMARKS:**
1. Emission level (dBuV/m) = Raw Value (dBuV) + Correction Factor (dB/m).
  2. Correction Factor (dB/m) = Antenna Factor (dB/m) + Cable Factor (dB).
  3. The other emission levels were very low against the limit.
  4. Margin value = Emission level – Limit value.
  5. “ \* “: Fundamental frequency.
  6. “#”: The radiated frequency is out the restricted band.



A D T

EUT TEST CONDITION		MEASUREMENT DETAIL	
CHANNEL	Channel 48	FREQUENCY RANGE	1 ~ 40GHz
INPUT POWER	120Vac, 60 Hz	DETECTOR FUNCTION	Peak (PK) Average (AV)
ENVIRONMENTAL CONDITIONS	25deg. C, 65%RH 1000 hPa	TESTED BY	Mark Liao

ANTENNA POLARITY & TEST DISTANCE: HORIZONTAL AT 3 M								
NO.	FREQ. (MHz)	EMISSION LEVEL (dBuV/m)	LIMIT (dBuV/m)	MARGIN (dB)	ANTENNA HEIGHT (m)	TABLE ANGLE (Degree)	RAW VALUE (dBuV)	CORRECTION FACTOR (dB/m)
1	*5240.00	107.5 PK			1.11 H	125	68.40	39.10
2	*5240.00	96.7 AV			1.11 H	125	57.60	39.10
3	5360.00	55.9 PK	74.0	-18.1	1.08 H	96	16.60	39.30
4	5360.00	44.1 AV	54.0	-9.9	1.08 H	96	4.80	39.30
5	#10480.00	60.9 PK	68.3	-27.4	1.12 H	222	12.00	48.90
ANTENNA POLARITY & TEST DISTANCE: VERTICAL AT 3 M								
NO.	FREQ. (MHz)	EMISSION LEVEL (dBuV/m)	LIMIT (dBuV/m)	MARGIN (dB)	ANTENNA HEIGHT (m)	TABLE ANGLE (Degree)	RAW VALUE (dBuV)	CORRECTION FACTOR (dB/m)
1	*5240.00	111.7 PK			1.16 V	113	72.60	39.10
2	*5240.00	100.8 AV			1.16 V	113	61.70	39.10
3	5360.00	60.6 PK	74.0	-13.4	1.11 V	83	21.30	39.30
4	5360.00	48.8 AV	54.0	-5.2	1.11 V	83	9.50	39.30
5	#10480.00	63.3 PK	68.3	-25.0	1.21 V	305	14.40	48.90

- REMARKS:**
1. Emission level (dBuV/m) = Raw Value (dBuV) + Correction Factor (dB/m).
  2. Correction Factor (dB/m) = Antenna Factor (dB/m) + Cable Factor (dB).
  3. The other emission levels were very low against the limit.
  4. Margin value = Emission level – Limit value.
  5. “ \* “: Fundamental frequency.
  6. “#”: The radiated frequency is out the restricted band.



A D T

802.11n (20MHz)

EUT TEST CONDITION		MEASUREMENT DETAIL	
CHANNEL	Channel 36	FREQUENCY RANGE	1 ~ 40GHz
INPUT POWER	120Vac, 60 Hz	DETECTOR FUNCTION	Peak (PK) Average (AV)
ENVIRONMENTAL CONDITIONS	25deg. C, 65%RH 1000 hPa	TESTED BY	Mark Liao

ANTENNA POLARITY & TEST DISTANCE: HORIZONTAL AT 3 M								
NO.	FREQ. (MHz)	EMISSION LEVEL (dBuV/m)	LIMIT (dBuV/m)	MARGIN (dB)	ANTENNA HEIGHT (m)	TABLE ANGLE (Degree)	RAW VALUE (dBuV)	CORRECTION FACTOR (dB/m)
1	5150.00	56.9 PK	74.0	-17.1	1.10 H	83	17.90	39.00
2	5150.00	44.5 AV	54.0	-9.5	1.10 H	83	5.50	39.00
3	*5180.00	107.1 PK			1.00 H	126	68.10	39.00
4	*5180.00	94.6 AV			1.00 H	126	55.60	39.00
5	#10360.00	57.9 PK	68.3	-30.4	1.35 H	238	9.20	48.70
ANTENNA POLARITY & TEST DISTANCE: VERTICAL AT 3 M								
NO.	FREQ. (MHz)	EMISSION LEVEL (dBuV/m)	LIMIT (dBuV/m)	MARGIN (dB)	ANTENNA HEIGHT (m)	TABLE ANGLE (Degree)	RAW VALUE (dBuV)	CORRECTION FACTOR (dB/m)
1	5140.00	61.0 PK	74.0	-13.0	1.00 V	339	22.10	38.90
2	5140.00	52.7 AV	54.0	-1.3	1.00 V	339	13.80	38.90
3	*5180.00	112.4 PK			1.00 V	189	73.40	39.00
4	*5180.00	99.5 AV			1.00 V	189	60.50	39.00
5	#10360.00	58.6 PK	68.3	-29.7	1.00 V	331	9.90	48.70

- REMARKS:**
1. Emission level (dBuV/m) = Raw Value (dBuV) + Correction Factor (dB/m).
  2. Correction Factor (dB/m) = Antenna Factor (dB/m) + Cable Factor (dB).
  3. The other emission levels were very low against the limit.
  4. Margin value = Emission level – Limit value.
  5. “ \* “: Fundamental frequency.
  6. “#”:The radiated frequency is out the restricted band.



A D T

EUT TEST CONDITION		MEASUREMENT DETAIL	
CHANNEL	Channel 40	FREQUENCY RANGE	1 ~ 40GHz
INPUT POWER	120Vac, 60 Hz	DETECTOR FUNCTION	Peak (PK) Average (AV)
ENVIRONMENTAL CONDITIONS	25deg. C, 65%RH 1000 hPa	TESTED BY	Mark Liao

ANTENNA POLARITY & TEST DISTANCE: HORIZONTAL AT 3 M								
NO.	FREQ. (MHz)	EMISSION LEVEL (dBuV/m)	LIMIT (dBuV/m)	MARGIN (dB)	ANTENNA HEIGHT (m)	TABLE ANGLE (Degree)	RAW VALUE (dBuV)	CORRECTION FACTOR (dB/m)
1	*5200.00	106.8 PK			1.06 H	131	67.80	39.00
2	*5200.00	94.7 AV			1.06 H	131	55.70	39.00
3	#10400.00	58.9 PK	68.3	-29.4	1.33 H	185	10.20	48.70
ANTENNA POLARITY & TEST DISTANCE: VERTICAL AT 3 M								
NO.	FREQ. (MHz)	EMISSION LEVEL (dBuV/m)	LIMIT (dBuV/m)	MARGIN (dB)	ANTENNA HEIGHT (m)	TABLE ANGLE (Degree)	RAW VALUE (dBuV)	CORRECTION FACTOR (dB/m)
1	*5200.00	112.2 PK			1.02 V	301	73.20	39.00
2	*5200.00	99.3 AV			1.02 V	301	60.30	39.00
3	#10400.00	60.3 PK	68.3	-28.0	1.00 V	308	11.60	48.70

- REMARKS:**
1. Emission level (dBuV/m) = Raw Value (dBuV) + Correction Factor (dB/m).
  2. Correction Factor (dB/m) = Antenna Factor (dB/m) + Cable Factor (dB).
  3. The other emission levels were very low against the limit.
  4. Margin value = Emission level – Limit value.
  5. “ \* ”: Fundamental frequency.
  6. “#”: The radiated frequency is out the restricted band.



A D T

EUT TEST CONDITION		MEASUREMENT DETAIL	
CHANNEL	Channel 48	FREQUENCY RANGE	1 ~ 40GHz
INPUT POWER	120Vac, 60 Hz	DETECTOR FUNCTION	Peak (PK) Average (AV)
ENVIRONMENTAL CONDITIONS	25deg. C, 65%RH 1000 hPa	TESTED BY	Mark Liao

ANTENNA POLARITY & TEST DISTANCE: HORIZONTAL AT 3 M								
NO.	FREQ. (MHz)	EMISSION LEVEL (dBuV/m)	LIMIT (dBuV/m)	MARGIN (dB)	ANTENNA HEIGHT (m)	TABLE ANGLE (Degree)	RAW VALUE (dBuV)	CORRECTION FACTOR (dB/m)
1	*5240.00	106.9 PK			1.15 H	132	67.80	39.10
2	*5240.00	94.2 AV			1.15 H	132	55.10	39.10
3	5360.00	56.1 PK	74.0	-17.9	1.05 H	101	16.80	39.30
4	5360.00	43.9 AV	54.0	-10.1	1.05 H	101	4.60	39.30
5	#10480.00	61.3 PK	68.3	-27.0	1.10 H	231	12.40	48.90
ANTENNA POLARITY & TEST DISTANCE: VERTICAL AT 3 M								
NO.	FREQ. (MHz)	EMISSION LEVEL (dBuV/m)	LIMIT (dBuV/m)	MARGIN (dB)	ANTENNA HEIGHT (m)	TABLE ANGLE (Degree)	RAW VALUE (dBuV)	CORRECTION FACTOR (dB/m)
1	*5240.00	111.9 PK			1.02 V	283	72.80	39.10
2	*5240.00	99.1 AV			1.02 V	283	60.00	39.10
3	5360.00	60.9 PK	74.0	-13.1	1.10 V	94	21.60	39.30
4	5360.00	48.8 AV	54.0	-5.2	1.10 V	94	9.50	39.30
5	#10480.00	63.5 PK	68.3	-24.8	1.18 V	300	14.60	48.90

- REMARKS:**
1. Emission level (dBuV/m) = Raw Value (dBuV) + Correction Factor (dB/m).
  2. Correction Factor (dB/m) = Antenna Factor (dB/m) + Cable Factor (dB).
  3. The other emission levels were very low against the limit.
  4. Margin value = Emission level – Limit value.
  5. “ \* “: Fundamental frequency.
  6. “#”: The radiated frequency is out the restricted band.



A D T

802.11n (40MHz)

EUT TEST CONDITION		MEASUREMENT DETAIL	
CHANNEL	Channel 38	FREQUENCY RANGE	1 ~ 40GHz
INPUT POWER	120Vac, 60 Hz	DETECTOR FUNCTION	Peak (PK) Average (AV)
ENVIRONMENTAL CONDITIONS	25deg. C, 65%RH 1000 hPa	TESTED BY	Mark Liao

ANTENNA POLARITY & TEST DISTANCE: HORIZONTAL AT 3 M								
NO.	FREQ. (MHz)	EMISSION LEVEL (dBuV/m)	LIMIT (dBuV/m)	MARGIN (dB)	ANTENNA HEIGHT (m)	TABLE ANGLE (Degree)	RAW VALUE (dBuV)	CORRECTION FACTOR (dB/m)
1	5150.00	57.8 PK	74.0	-16.2	1.12 H	126	18.80	39.00
2	5150.00	45.6 AV	54.0	-8.4	1.12 H	126	6.60	39.00
3	*5190.00	102.1 PK			1.12 H	126	63.10	39.00
4	*5190.00	89.0 AV			1.12 H	126	50.00	39.00
5	#10380.00	57.7 PK	68.3	-30.6	1.12 H	141	9.00	48.70
ANTENNA POLARITY & TEST DISTANCE: VERTICAL AT 3 M								
NO.	FREQ. (MHz)	EMISSION LEVEL (dBuV/m)	LIMIT (dBuV/m)	MARGIN (dB)	ANTENNA HEIGHT (m)	TABLE ANGLE (Degree)	RAW VALUE (dBuV)	CORRECTION FACTOR (dB/m)
1	5150.00	63.8 PK	74.0	-10.2	1.07 V	94	24.80	39.00
2	5150.00	52.2 AV	54.0	-1.8	1.07 V	94	13.20	39.00
3	*5190.00	107.8 PK			1.04 V	82	68.80	39.00
4	*5190.00	94.8 AV			1.04 V	82	55.80	39.00
5	#10380.00	57.6 PK	68.3	-30.7	1.18 V	264	8.90	48.70

- REMARKS:**
1. Emission level (dBuV/m) = Raw Value (dBuV) + Correction Factor (dB/m).
  2. Correction Factor (dB/m) = Antenna Factor (dB/m) + Cable Factor (dB).
  3. The other emission levels were very low against the limit.
  4. Margin value = Emission level – Limit value.
  5. “ \* “: Fundamental frequency.
  6. “#”:The radiated frequency is out the restricted band.



A D T

EUT TEST CONDITION		MEASUREMENT DETAIL	
CHANNEL	Channel 46	FREQUENCY RANGE	1 ~ 40GHz
INPUT POWER	120Vac, 60 Hz	DETECTOR FUNCTION	Peak (PK) Average (AV)
ENVIRONMENTAL CONDITIONS	25deg. C, 65%RH 1000 hPa	TESTED BY	Mark Liao

ANTENNA POLARITY & TEST DISTANCE: HORIZONTAL AT 3 M								
NO.	FREQ. (MHz)	EMISSION LEVEL (dBuV/m)	LIMIT (dBuV/m)	MARGIN (dB)	ANTENNA HEIGHT (m)	TABLE ANGLE (Degree)	RAW VALUE (dBuV)	CORRECTION FACTOR (dB/m)
1	*5230.00	102.9 PK			1.11 H	69	63.80	39.10
2	*5230.00	90.1 AV			1.11 H	69	51.00	39.10
3	5350.00	46.8 PK	74.0	-27.2	1.03 H	182	7.50	39.30
4	5350.00	33.7 AV	54.0	-20.3	1.03 H	182	-5.60	39.30
5	#10460.00	58.5 PK	68.3	-29.8	1.29 H	230	9.60	48.90
ANTENNA POLARITY & TEST DISTANCE: VERTICAL AT 3 M								
NO.	FREQ. (MHz)	EMISSION LEVEL (dBuV/m)	LIMIT (dBuV/m)	MARGIN (dB)	ANTENNA HEIGHT (m)	TABLE ANGLE (Degree)	RAW VALUE (dBuV)	CORRECTION FACTOR (dB/m)
1	*5230.00	107.7 PK			1.16 V	97	68.60	39.10
2	*5230.00	94.9 AV			1.16 V	97	55.80	39.10
3	5350.00	47.1 PK	74.0	-26.9	1.08 V	63	7.80	39.30
4	5350.00	34.1 AV	54.0	-19.9	1.08 V	63	-5.20	39.30
5	#10460.00	58.4 PK	68.3	-29.9	1.17 V	281	9.50	48.90

- REMARKS:**
1. Emission level (dBuV/m) = Raw Value (dBuV) + Correction Factor (dB/m).
  2. Correction Factor (dB/m) = Antenna Factor (dB/m) + Cable Factor (dB).
  3. The other emission levels were very low against the limit.
  4. Margin value = Emission level – Limit value.
  5. “ \* “: Fundamental frequency.
  6. “#”: The radiated frequency is out the restricted band.



A D T

**BELOW 1GHz WORST-CASE DATA : 802.11n (40MHz)**

EUT TEST CONDITION		MEASUREMENT DETAIL	
CHANNEL	Channel 46	FREQUENCY RANGE	Below 1000MHz
INPUT POWER	120Vac, 60 Hz	DETECTOR FUNCTION	Quasi-Peak
ENVIRONMENTAL CONDITIONS	26deg. C, 66%RH 1007 hPa	TESTED BY	Antony Lee
TEST MODE	A		

ANTENNA POLARITY & TEST DISTANCE: HORIZONTAL AT 3 M								
NO.	FREQ. (MHz)	EMISSION LEVEL (dBuV/m)	LIMIT (dBuV/m)	MARGIN (dB)	ANTENNA HEIGHT (m)	TABLE ANGLE (Degree)	RAW VALUE (dBuV)	CORRECTION FACTOR (dB/m)
1	166.00	30.6 QP	43.5	-12.9	2.00 H	277	17.30	13.30
2	375.98	33.2 QP	46.0	-12.8	1.00 H	214	17.70	15.50
3	401.26	38.4 QP	46.0	-7.6	1.00 H	211	22.20	16.20
4	475.14	32.5 QP	46.0	-13.5	2.00 H	73	14.00	18.50
5	722.07	31.7 QP	46.0	-14.3	1.00 H	214	8.40	23.30
6	842.61	30.0 QP	46.0	-16.0	1.00 H	10	4.40	25.60

ANTENNA POLARITY & TEST DISTANCE: VERTICAL AT 3 M								
NO.	FREQ. (MHz)	EMISSION LEVEL (dBuV/m)	LIMIT (dBuV/m)	MARGIN (dB)	ANTENNA HEIGHT (m)	TABLE ANGLE (Degree)	RAW VALUE (dBuV)	CORRECTION FACTOR (dB/m)
1	101.84	38.1 QP	43.5	-5.4	1.00 V	241	28.50	9.60
2	350.71	33.5 QP	46.0	-12.5	1.25 V	175	18.60	14.90
3	401.26	41.2 QP	46.0	-4.8	1.50 V	241	25.00	16.20
4	475.14	31.4 QP	46.0	-14.6	1.00 V	115	12.90	18.50
5	601.52	30.9 QP	46.0	-15.1	1.00 V	301	8.90	22.00
6	842.61	32.5 QP	46.0	-13.5	1.25 V	124	6.90	25.60

- REMARKS:**
1. Emission level (dBuV/m) = Raw Value (dBuV) + Correction Factor (dB/m).
  2. Correction Factor (dB/m) = Antenna Factor (dB/m) + Cable Factor (dB).
  3. The other emission levels were very low against the limit.
  4. Margin value = Emission level – Limit value.





A D T

EUT TEST CONDITION		MEASUREMENT DETAIL	
CHANNEL	Channel 46	FREQUENCY RANGE	Below 1000MHz
INPUT POWER	120Vac, 60 Hz	DETECTOR FUNCTION	Quasi-Peak
ENVIRONMENTAL CONDITIONS	26deg. C, 66%RH 1007 hPa	TESTED BY	Antony Lee
TEST MODE	B		

ANTENNA POLARITY & TEST DISTANCE: HORIZONTAL AT 3 M								
NO.	FREQ. (MHz)	EMISSION LEVEL (dBuV/m)	LIMIT (dBuV/m)	MARGIN (dB)	ANTENNA HEIGHT (m)	TABLE ANGLE (Degree)	RAW VALUE (dBuV)	CORRECTION FACTOR (dB/m)
1	99.89	30.8 QP	43.5	-12.7	2.00 H	157	21.40	9.40
2	350.71	35.3 QP	46.0	-10.7	1.00 H	208	20.40	14.90
3	401.26	37.1 QP	46.0	-8.9	1.25 H	337	20.90	16.20
4	480.97	33.3 QP	46.0	-12.7	1.50 H	214	14.60	18.70
5	626.80	31.9 QP	46.0	-14.1	1.25 H	208	9.70	22.20
6	722.07	31.2 QP	46.0	-14.8	1.25 H	226	7.90	23.30

ANTENNA POLARITY & TEST DISTANCE: VERTICAL AT 3 M								
NO.	FREQ. (MHz)	EMISSION LEVEL (dBuV/m)	LIMIT (dBuV/m)	MARGIN (dB)	ANTENNA HEIGHT (m)	TABLE ANGLE (Degree)	RAW VALUE (dBuV)	CORRECTION FACTOR (dB/m)
1	30.00	29.0 QP	40.0	-11.0	1.00 V	346	16.70	12.30
2	101.84	37.0 QP	43.5	-6.5	1.25 V	238	27.40	9.60
3	350.71	36.2 QP	46.0	-9.8	1.50 V	94	21.30	14.90
4	401.26	38.4 QP	46.0	-7.6	1.50 V	139	22.20	16.20
5	480.97	34.2 QP	46.0	-11.8	1.00 V	196	15.50	18.70
6	801.78	33.9 QP	46.0	-12.1	1.25 V	124	8.50	25.40
7	842.61	33.2 QP	46.0	-12.8	1.25 V	127	7.60	25.60

- REMARKS:**
1. Emission level (dBuV/m) = Raw Value (dBuV) + Correction Factor (dB/m).
  2. Correction Factor (dB/m) = Antenna Factor (dB/m) + Cable Factor (dB).
  3. The other emission levels were very low against the limit.
  4. Margin value = Emission level – Limit value.



## 4.2 CONDUCTED EMISSION MEASUREMENT

### 4.2.1 LIMITS OF CONDUCTED EMISSION MEASUREMENT

FREQUENCY OF EMISSION (MHz)	CONDUCTED LIMIT (dBµV)	
	Quasi-peak	Average
0.15 ~ 0.5	66 to 56	56 to 46
0.5 ~ 5	56	46
5 ~ 30	60	50

- NOTE:** 1. The lower limit shall apply at the transition frequencies.  
 2. The limit decreases in line with the logarithm of the frequency in the range of 0.15 to 0.50MHz.  
 3. All emanations from a class A/B digital device or system, including any network of conductors and apparatus connected thereto, shall not exceed the level of field strengths specified above.

### 4.2.2 TEST INSTRUMENTS

DESCRIPTION & MANUFACTURER	MODEL NO.	SERIAL NO.	DATE OF CALIBRATION	DUE DATE OF CALIBRATION
Test Receiver ROHDE & SCHWARZ	ESCS30	100291	Dec. 16, 2009	Dec. 15, 2010
RF signal cable Woken	5D-FB	Cable-HYC01-01	Nov. 12, 2009	Nov. 11, 2010
LISN SCHWARZBECK	NNBL 8226-2	8226-142	Jun. 12, 2010	Jun. 12, 2011
LISN ROHDE & SCHWARZ	ESH3-Z5	835239/001	Feb., 10, 2010	Feb. 09, 2011
Software ADT	ADT_Cond_ V7.3.7	NA	NA	NA

- NOTE:** 1. The calibration interval of the above test instruments is 12 months and the calibrations are traceable to NML/ROC and NIST/USA.  
 2. The test was performed in HwaYa Shielded Room 1.  
 3. The VCCI Site Registration No. is C-2040.



#### 4.2.3 TEST PROCEDURES

- a. The EUT was placed 0.4 meters from the conducting wall of the shielded room with EUT being connected to the power mains through a line impedance stabilization network (LISN). Other support units were connected to the power mains through another LISN. The two LISNs provide 50 ohm/ 50uH of coupling impedance for the measuring instrument.
- b. Both lines of the power mains connected to the EUT were checked for maximum conducted interference.
- c. The frequency range from 150kHz to 30MHz was searched. Emission levels under (Limit - 20dB) was not recorded.

**NOTE:** All modes of operation were investigated and the worst-case emissions are reported.

#### 4.2.4 DEVIATION FROM TEST STANDARD

No deviation.

#### 4.2.5 TEST SETUP

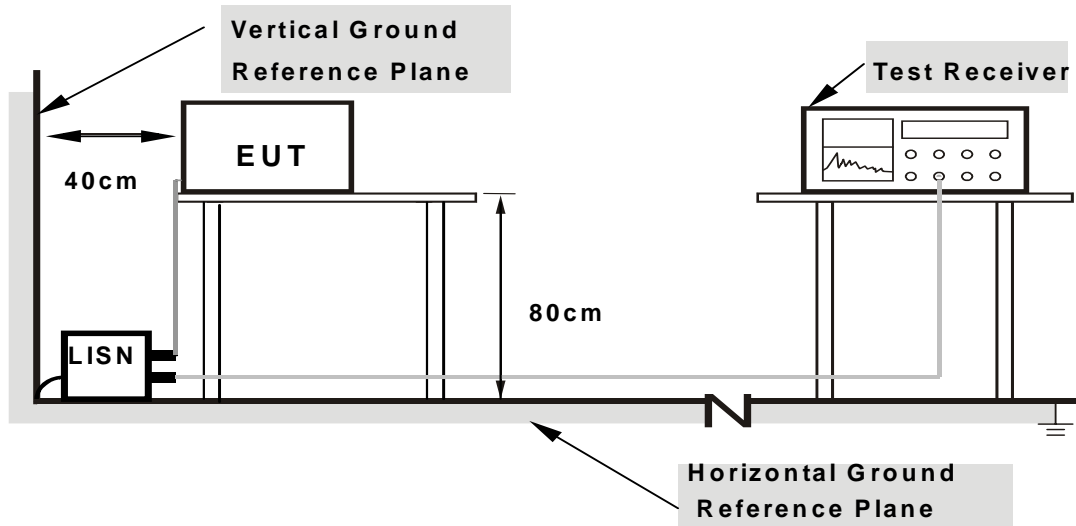

**Note: 1. Support units were connected to second LISN.**

**2. Both of LISNs (AMN) are 80 cm from EUT and at least 80 from other units and other metal planes**

For the actual test configuration, please refer to the attached file (Test Setup Photo).

#### 4.2.6 EUT OPERATING CONDITIONS

Same as 4.1.6.

### 4.2.7 TEST RESULTS

**CONDUCTED WORST-CASE DATA : 802.11n (40MHz)**

<b>PHASE</b>	Line 1	<b>6dB BANDWIDTH</b>	9kHz
<b>TEST MODE</b>	A		

No	Freq. [MHz]	Corr. Factor (dB)	Reading Value [dB (uV)]		Emission Level [dB (uV)]		Limit [dB (uV)]		Margin (dB)	
			Q.P.	AV.	Q.P.	AV.	Q.P.	AV.	Q.P.	AV.
1	0.184	0.11	58.09	48.01	58.20	48.12	64.32	54.32	-6.11	-6.19
2	0.189	0.11	59.91	42.27	60.02	42.38	64.08	54.08	-4.06	-11.70
<b>3</b>	<b>0.250</b>	<b>0.12</b>	<b>58.22</b>	<b>38.49</b>	<b>58.34</b>	<b>38.61</b>	<b>61.75</b>	<b>51.75</b>	<b>-3.41</b>	<b>-13.14</b>
4	0.310	0.12	53.90	37.61	54.02	37.73	59.97	49.97	-5.95	-12.24
5	0.377	0.13	53.61	31.57	53.74	31.70	58.35	48.35	-4.62	-16.66
6	0.435	0.13	51.11	34.07	51.24	34.20	57.15	47.15	-5.91	-12.95
7	0.498	0.14	50.55	31.38	50.69	31.52	56.04	46.04	-5.35	-14.52
8	0.623	0.15	48.75	30.72	48.90	30.87	56.00	46.00	-7.10	-15.13
9	0.744	0.16	47.91	29.38	48.07	29.54	56.00	46.00	-7.93	-16.46
10	0.931	0.17	47.46	29.36	47.63	29.53	56.00	46.00	-8.37	-16.47
11	1.180	0.19	45.35	-	45.54	-	56.00	46.00	-10.46	-

- REMARKS:**
1. Q.P. and AV. are abbreviations of quasi-peak and average individually.
  2. "-": The Quasi-peak reading value also meets average limit and measurement with the average detector is unnecessary.
  3. The emission levels of other frequencies were very low against the limit.
  4. Margin value = Emission level - Limit value
  5. Correction factor = Insertion loss + Cable loss
  6. Emission Level = Correction Factor + Reading Value.

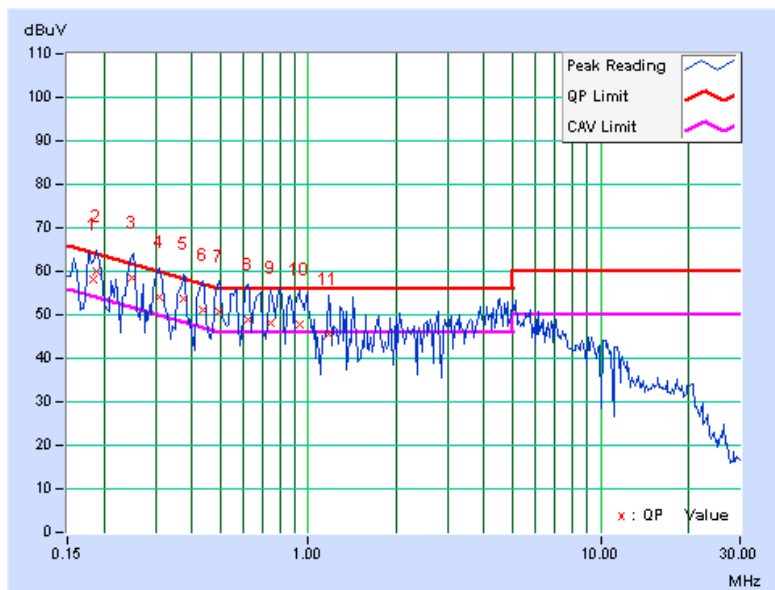

PHASE	Line 2	6dB BANDWIDTH	9kHz
TEST MODE	A		

No	Freq. [MHz]	Corr. Factor (dB)	Reading Value		Emission Level		Limit		Margin	
			[dB (uV)]		[dB (uV)]		[dB (uV)]		(dB)	
			Q.P.	AV.	Q.P.	AV.	Q.P.	AV.	Q.P.	AV.
1	0.181	0.10	58.49	47.50	58.59	47.60	64.43	54.43	-5.84	-6.83
2	0.248	0.10	56.33	39.67	56.43	39.77	61.84	51.84	-5.40	-12.06
3	0.302	0.11	54.56	41.56	54.67	41.67	60.18	50.18	-5.51	-8.51
4	0.373	0.12	51.93	32.41	52.05	32.53	58.44	48.44	-6.39	-15.91
5	0.423	0.12	50.57	36.96	50.69	37.08	57.38	47.38	-6.69	-10.30
6	0.500	0.13	48.52	29.72	48.65	29.85	56.00	46.00	-7.35	-16.15
7	0.552	0.13	47.45	31.42	47.58	31.55	56.00	46.00	-8.42	-14.45
8	0.666	0.14	48.57	32.33	48.71	32.47	56.00	46.00	-7.29	-13.53
9	0.861	0.16	45.85	28.17	46.01	28.33	56.00	46.00	-9.99	-17.67
10	3.633	0.31	44.59	-	44.90	-	56.00	46.00	-11.10	-
11	4.492	0.34	39.92	-	40.26	-	56.00	46.00	-15.74	-

- REMARKS:**
1. Q.P. and AV. are abbreviations of quasi-peak and average individually.
  2. "-": The Quasi-peak reading value also meets average limit and measurement with the average detector is unnecessary.
  3. The emission levels of other frequencies were very low against the limit.
  4. Margin value = Emission level - Limit value
  5. Correction factor = Insertion loss + Cable loss
  6. Emission Level = Correction Factor + Reading Value.

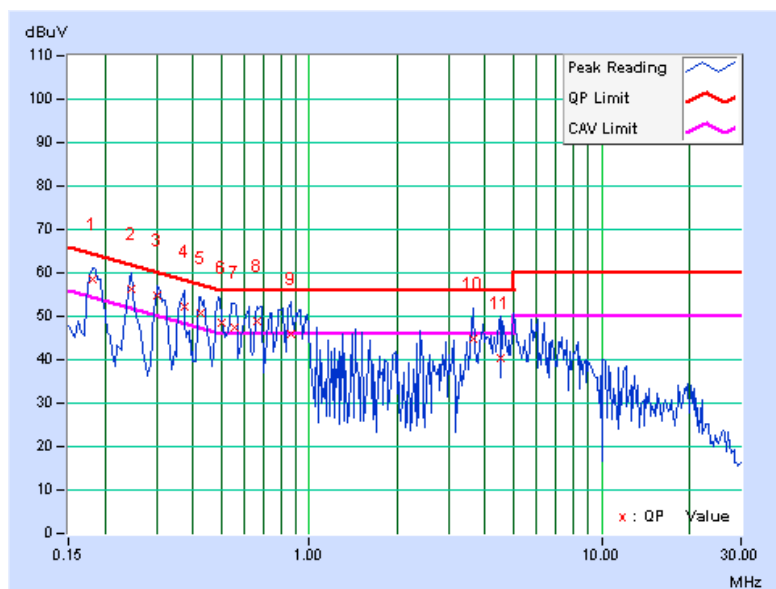



A D T

PHASE	Line 1	6dB BANDWIDTH	9kHz
TEST MODE	B		

No	Freq. [MHz]	Corr. Factor (dB)	Reading Value [dB (uV)]		Emission Level [dB (uV)]		Limit [dB (uV)]		Margin (dB)	
			Q.P.	AV.	Q.P.	AV.	Q.P.	AV.	Q.P.	AV.
1	0.150	0.12	39.79	-	39.91	-	66.00	56.00	-26.09	-
2	0.228	0.11	30.69	-	30.80	-	62.52	52.52	-31.72	-
3	1.883	0.24	26.00	-	26.24	-	56.00	46.00	-29.76	-
4	2.176	0.26	30.16	-	30.42	-	56.00	46.00	-25.58	-
5	2.355	0.27	30.81	-	31.08	-	56.00	46.00	-24.92	-
6	21.660	1.60	24.93	-	26.53	-	60.00	50.00	-33.47	-

- REMARKS:**
1. Q.P. and AV. are abbreviations of quasi-peak and average individually.
  2. "-": The Quasi-peak reading value also meets average limit and measurement with the average detector is unnecessary.
  3. The emission levels of other frequencies were very low against the limit.
  4. Margin value = Emission level - Limit value
  5. Correction factor = Insertion loss + Cable loss
  6. Emission Level = Correction Factor + Reading Value.

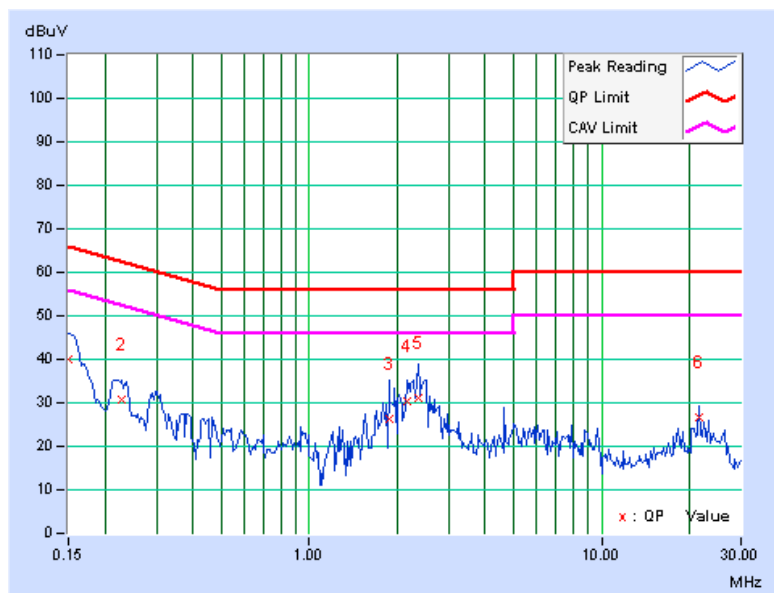



A D T

PHASE	Line 2	6dB BANDWIDTH	9kHz
TEST MODE	B		

No	Freq. [MHz]	Corr. Factor (dB)	Reading Value [dB (uV)]		Emission Level [dB (uV)]		Limit [dB (uV)]		Margin (dB)	
			Q.P.	AV.	Q.P.	AV.	Q.P.	AV.	Q.P.	AV.
1	0.150	0.10	40.33	-	40.43	-	66.00	56.00	-25.57	-
2	0.213	0.10	28.96	-	29.06	-	63.11	53.11	-34.05	-
3	1.313	0.19	21.21	-	21.40	-	56.00	46.00	-34.60	-
4	2.266	0.25	31.21	-	31.46	-	56.00	46.00	-24.54	-
5	2.645	0.27	26.59	-	26.86	-	56.00	46.00	-29.14	-
6	3.063	0.28	21.76	-	22.04	-	56.00	46.00	-33.96	-

- REMARKS:**
1. Q.P. and AV. are abbreviations of quasi-peak and average individually.
  2. "-": The Quasi-peak reading value also meets average limit and measurement with the average detector is unnecessary.
  3. The emission levels of other frequencies were very low against the limit.
  4. Margin value = Emission level - Limit value
  5. Correction factor = Insertion loss + Cable loss
  6. Emission Level = Correction Factor + Reading Value.

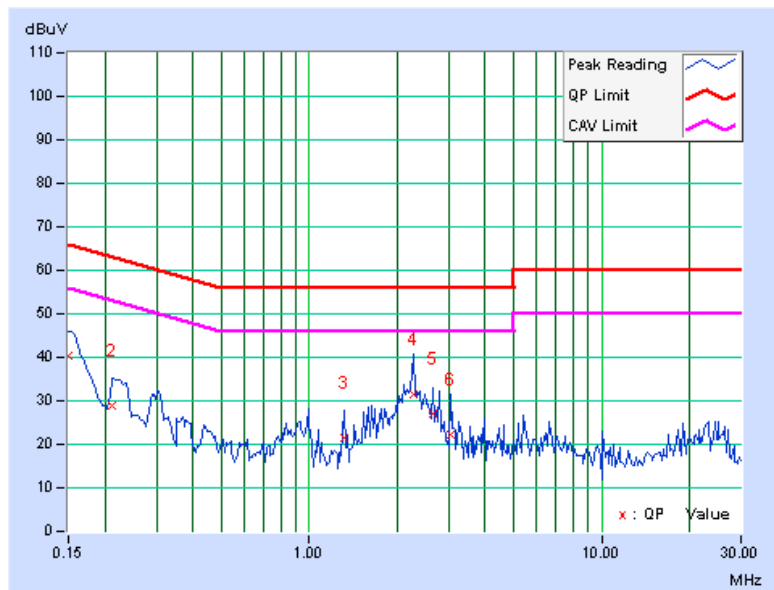





A D T

### 4.3 MAXIMUM CONDUCTED OUTPUT POWER MEASUREMENT

#### 4.3.1 LIMITS OF MAXIMUM CONDUCTED OUTPUT POWER MEASUREMENT

FREQUENCY BAND	LIMIT
5.15 ~ 5.25GHz	The lesser of 50mW (17dBm) or 4dBm + 10logB

**NOTE:** Where B is the 26dB emission bandwidth in MHz.

#### 4.3.2 TEST INSTRUMENTS

##### FOR POWER OUTPUT MEASUREMENT

DESCRIPTION & MANUFACTURER	MODEL NO.	SERIAL NO.	DATE OF CALIBRATION	CALIBRATED UNTIL
High Speed Peak Power Meter	ML2495A	0824012	Aug. 10, 2009	Aug. 09, 2010
Power Sensor	MA2411B	0738138	Aug. 10, 2009	Aug. 09, 2010

**NOTE:**

1. The calibration interval of the above test instruments is 12 months and the calibrations are traceable to NML/ROC and NIST/USA.
2. Measurement Bandwidth of ML2495A is 65MHz greater than 26dB bandwidth of emission.

##### FOR 26dB OCCUPIED BANDWIDTH

DESCRIPTION & MANUFACTURER	MODEL NO.	SERIAL NO.	DATE OF CALIBRATION	DUE DATE OF CALIBRATION
SPECTRUM ANALYZER R&S	FSP40	100040	Jul. 17, 2010	Jul. 16, 2011

**NOTE:** The calibration interval of the above test instruments is 12 months and the calibrations are traceable to NML/ROC and NIST/USA.

### 4.3.3 TEST PROCEDURE

#### FOR POWER OUTPUT MEASUREMENT

A power sensor was used on the output port of the EUT. A power meter was used to read the response of the power sensor. Record the power level.

#### FOR 26dB OCCUPIED BANDWIDTH

The transmitter output was connected to the spectrum analyzer through an attenuator. The bandwidth of the fundamental frequency was measured by spectrum analyzer with 300kHz RBW and 1MHz VBW. The 26dB bandwidth is defined as the total spectrum the power of which is higher than peak power minus 26dB.

### 4.3.4 DEVIATION FROM TEST STANDARD

No deviation.

### 4.3.5 TEST SETUP

#### FOR POWER OUTPUT MEASUREMENT

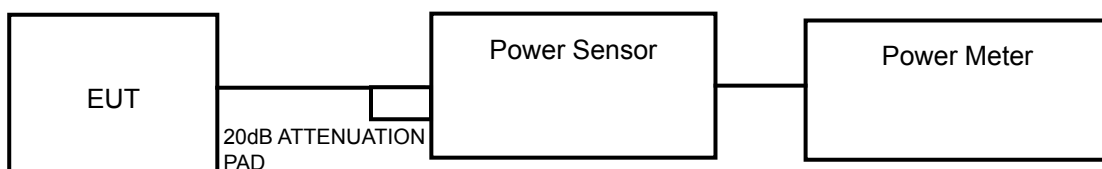

#### FOR 26dB OCCUPIED BANDWIDTH

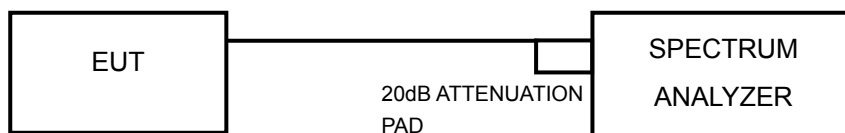

### 4.3.6 EUT OPERATING CONDITIONS

The software provided by client to enable the EUT under transmission condition continuously at specific channel frequencies individually.



### 4.3.7 TEST RESULTS

#### POWER OUTPUT: 802.11a

CHAN.	CHAN. FREQ. (MHz)	POWER OUTPUT (dBm)				TOTAL POWER (mW)	TOTAL POWER (dBm)	POWER LIMIT (dBm)	PASS / FAIL
		CHAIN 0	CHAIN 1	CHAIN 2	CHAIN 3				
36	5180	9.0	9.1	9.6	8.9	33.0	15.2	17	PASS
40	5200	9.1	9.1	9.6	8.8	33.0	15.2	17	PASS
48	5240	9.3	9.1	9.6	8.8	33.3	15.2	17	PASS

#### 802.11n (20MHz)

CHAN.	CHAN. FREQ. (MHz)	POWER OUTPUT (dBm)				TOTAL POWER (mW)	TOTAL POWER (dBm)	POWER LIMIT (dBm)	PASS / FAIL
		CHAIN 0	CHAIN 1	CHAIN 2	CHAIN 3				
36	5180	9.8	9.7	9.1	9.2	35.3	15.5	17	PASS
40	5200	9.4	9.9	9.2	10.1	37.0	15.7	17	PASS
48	5240	9.5	9.8	9.2	9.8	36.3	15.6	17	PASS

#### 802.11n (40MHz)

CHAN.	CHAN. FREQ. (MHz)	POWER OUTPUT (dBm)				TOTAL POWER (mW)	TOTAL POWER (dBm)	POWER LIMIT (dBm)	PASS / FAIL
		CHAIN 0	CHAIN 1	CHAIN 2	CHAIN 3				
38	5190	9.2	9.8	9.6	10.1	37.2	15.7	17	PASS
46	5230	9.6	9.8	9.5	10.2	38.1	15.8	17	PASS



A D T

### 26dB OCCUPIED BANDWIDTH: 802.11a

CHANNEL	CHANNEL FREQUENCY (MHz)	26dBc OCCUPIED BANDWIDTH (MHz)				PASS / FAIL
		CHAIN 0	CHAIN 1	CHAIN 2	CHAIN 3	
36	5180	20.75	20.73	20.47	20.52	PASS
40	5200	20.72	20.77	20.46	20.51	PASS
48	5240	20.63	20.54	20.38	20.39	PASS

### FOR CHAIN 1: CH 40

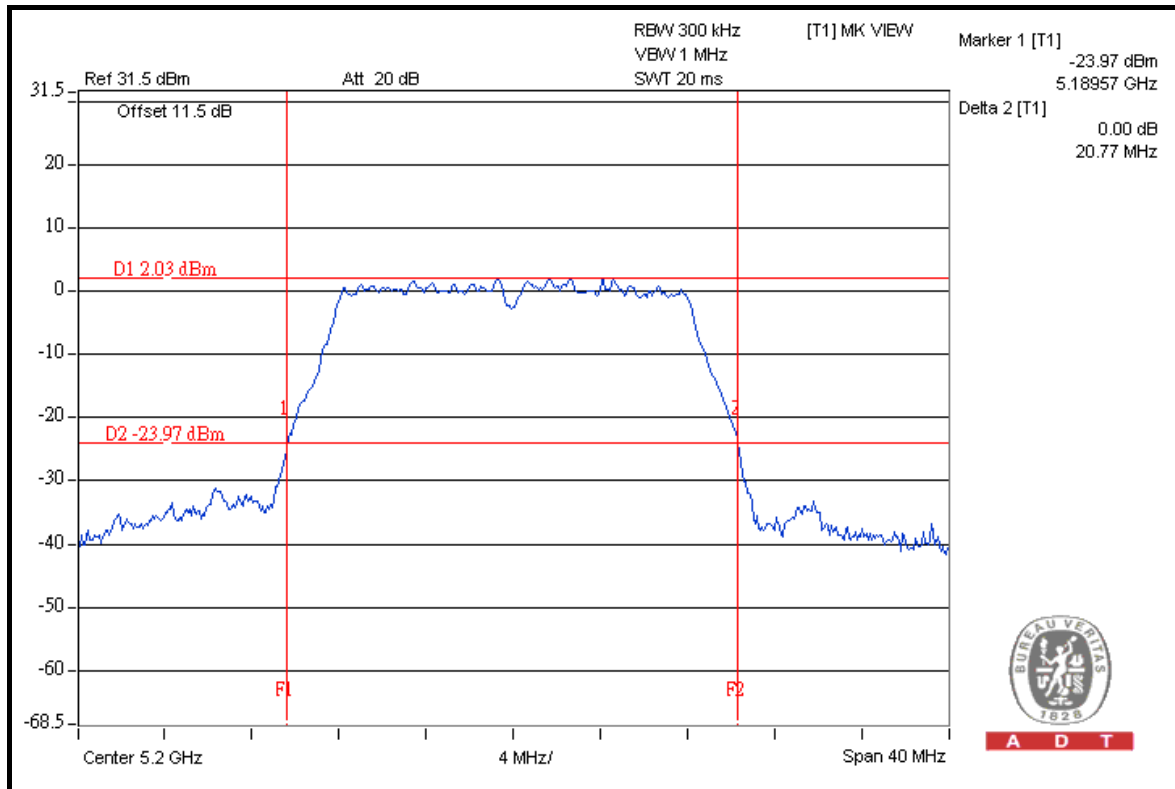

A D T



A D T

### 802.11n (20MHz)

CHANNEL	CHANNEL FREQUENCY (MHz)	26dBc OCCUPIED BANDWIDTH (MHz)				PASS / FAIL
		CHAIN 0	CHAIN 1	CHAIN 2	CHAIN 3	
36	5180	21.11	21.03	21.04	21.10	PASS
40	5200	21.09	21.09	21.09	21.10	PASS
48	5240	20.99	20.89	20.98	20.97	PASS

### FOR CHAIN 0: CH 36

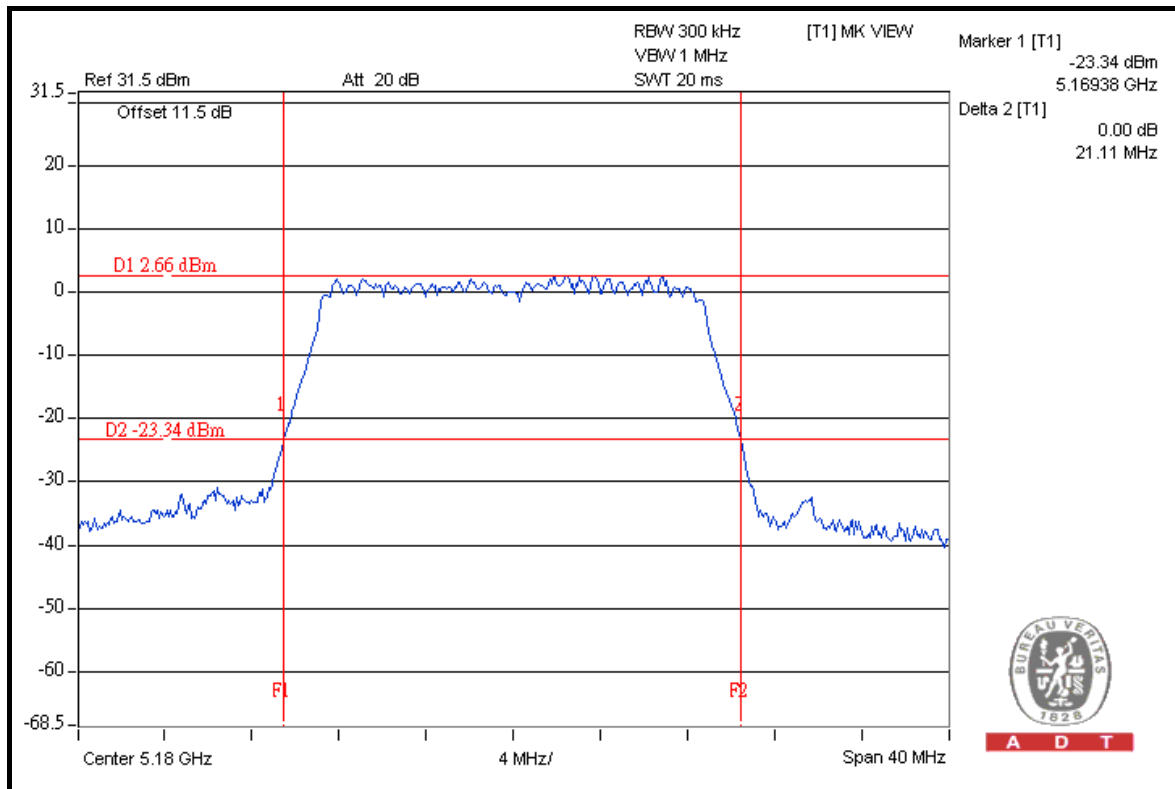



A D T

### 802.11n (40MHz)

CHANNEL	CHANNEL FREQUENCY (MHz)	26dBc OCCUPIED BANDWIDTH (MHz)				PASS / FAIL
		CHAIN 0	CHAIN 1	CHAIN 2	CHAIN 3	
38	5190	41.52	40.59	41.46	41.35	PASS
46	5230	41.32	40.42	41.06	41.15	PASS

### FOR CHAIN 0: CH 38

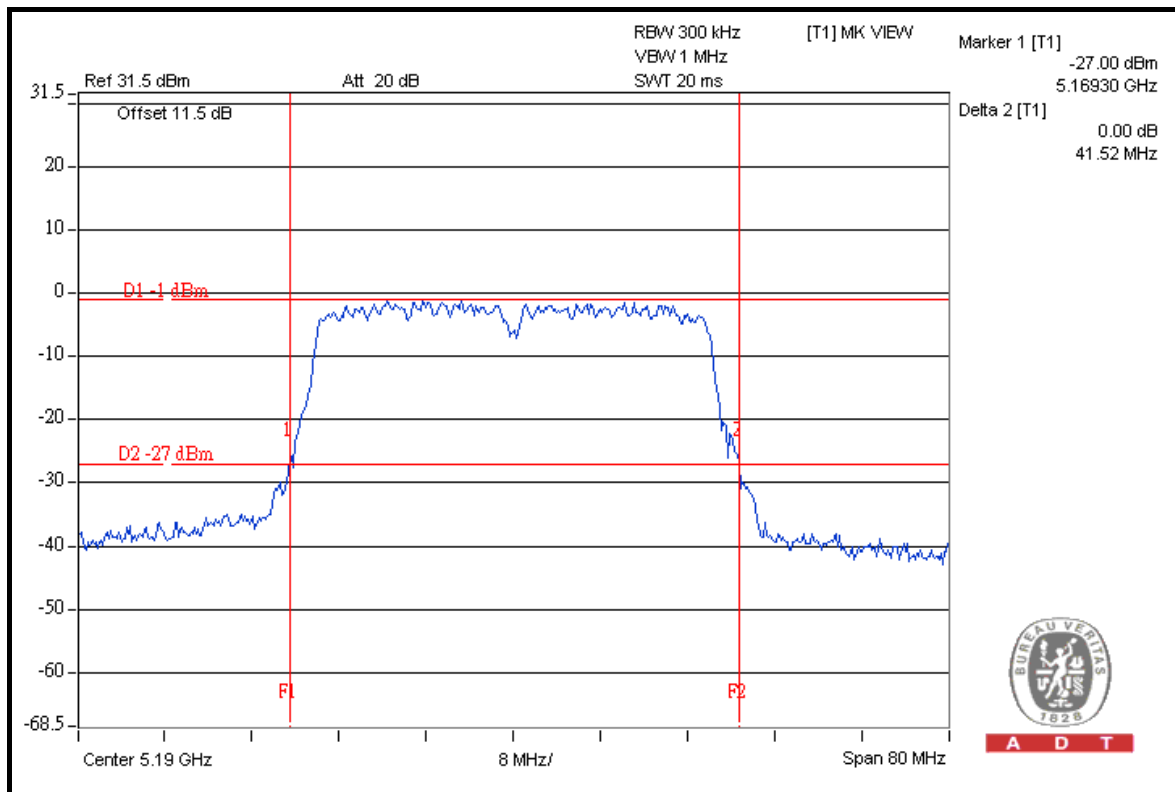



A D T

#### 4.4 PEAK POWER EXCURSION MEASUREMENT

##### 4.4.1 LIMITS OF PEAK POWER EXCURSION MEASUREMENT

FREQUENCY BAND	LIMIT
5.15 ~ 5.25GHz	13dB

##### 4.4.2 TEST INSTRUMENTS

DESCRIPTION & MANUFACTURER	MODEL NO.	SERIAL NO.	DATE OF CALIBRATION	DUE DATE OF CALIBRATION
SPECTRUM ANALYZER R&S	FSP40	100040	Jul. 17, 2010	Jul. 16, 2011

**NOTE:** The calibration interval of the above test instruments is 12 months and the calibrations are traceable to NML/ROC and NIST/USA.

##### 4.4.3 TEST PROCEDURE

- a. The transmitter output was connected to the spectrum analyzer.
- b. Set the spectrum bandwidth span to view the entire spectrum.
- c. Using peak detector and Max-hold function for Trace 1 (RB = 1MHz, VB = 3MHz) and 2 (RB = 1MHz, VB = 300kHz).
- d. The differences between Trace1 and Trace 2 in any 1MHz band at f1 to f2 range were recorded and showed to another trace.

#### 4.4.4 DEVIATION FROM TEST STANDARD

No deviation.

#### 4.4.5 TEST SETUP



#### 4.4.6 EUT OPERATING CONDITIONS

The software provided by client to enable the EUT under transmission condition continuously at specific channel frequencies individually.





#### 4.4.7 TEST RESULTS

##### 802.11a

CHANNEL	CHANNEL FREQUENCY (MHz)	PEAK POWER EXCURSION (dB)				PEAK to AVERAGE EXCURSION LIMIT (dB)	PASS/ FAIL
		CHAIN 0	CHAIN 1	CHAIN 2	CHAIN 3		
36	5180	7.24	7.40	7.73	8.08	13	PASS
40	5200	7.50	8.61	7.46	6.48	13	PASS
48	5240	8.75	7.97	7.76	7.03	13	PASS



A D T

### FOR CHAIN 0: CH 48

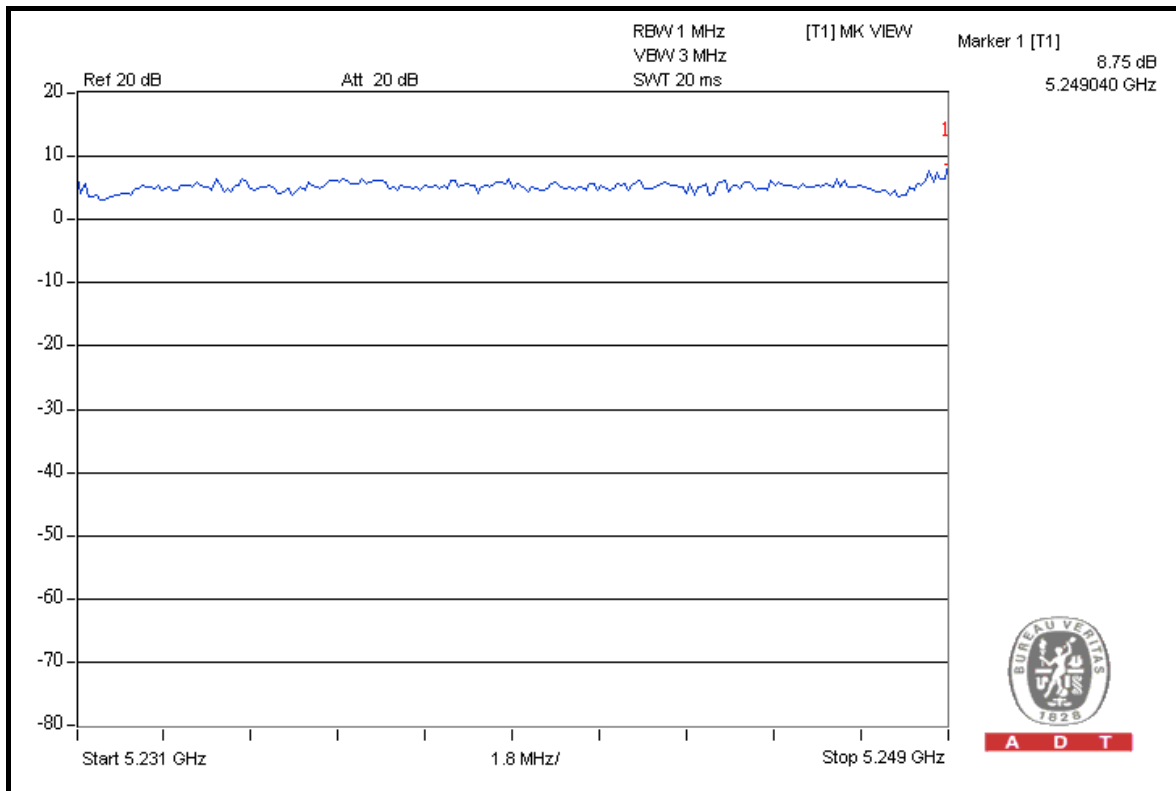
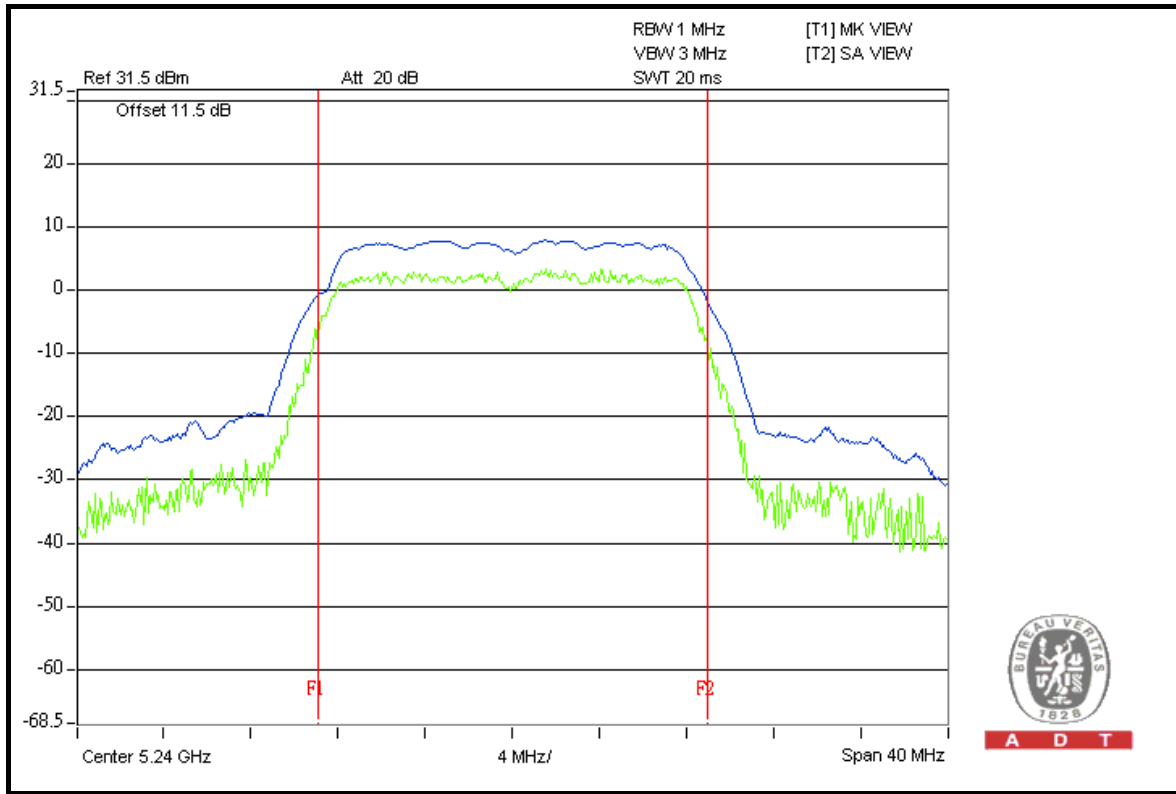



A D T

802.11n (20MHz)

CHANNEL	CHANNEL FREQUENCY (MHz)	PEAK POWER EXCURSION (dB)				PEAK to AVERAGE EXCURSION LIMIT (dB)	PASS/ FAIL
		CHAIN 0	CHAIN 1	CHAIN 2	CHAIN 3		
36	5180	7.51	7.24	7.12	6.91	13	PASS
40	5200	7.15	6.93	7.18	7.61	13	PASS
48	5240	7.39	7.66	7.42	7.24	13	PASS



A D T

### FOR CHAIN 1: CH 48

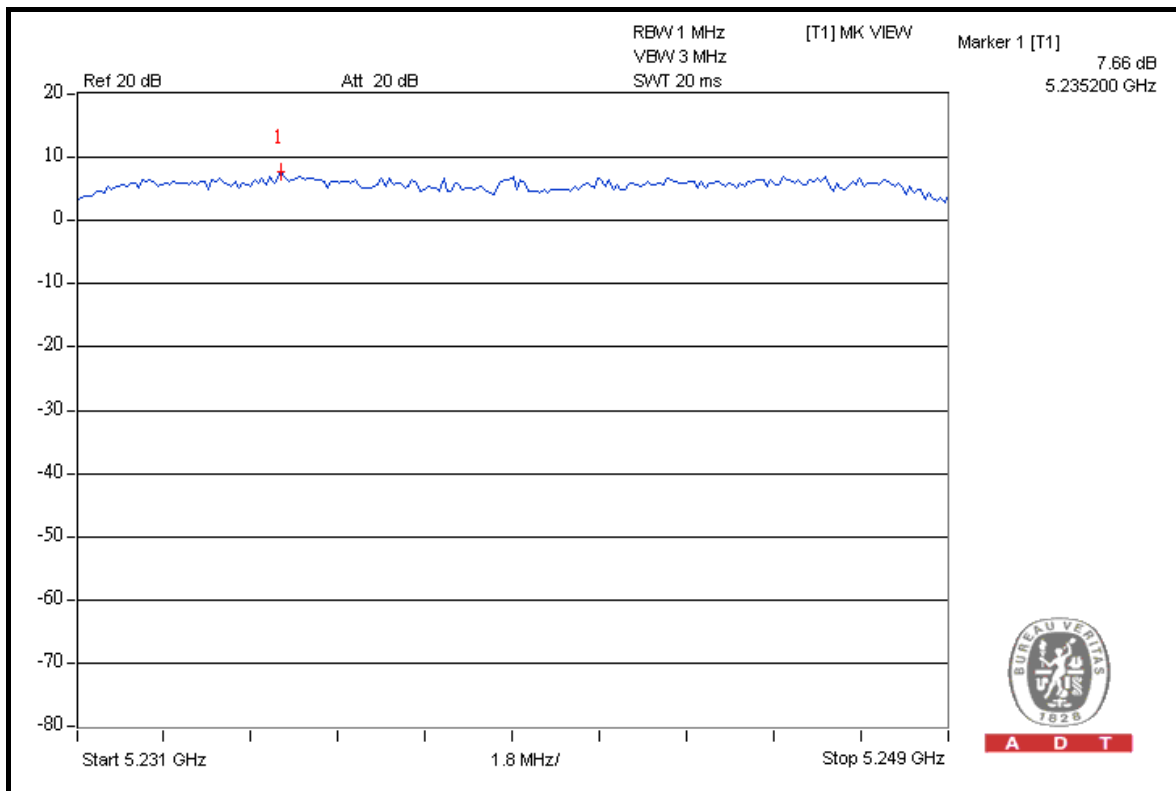
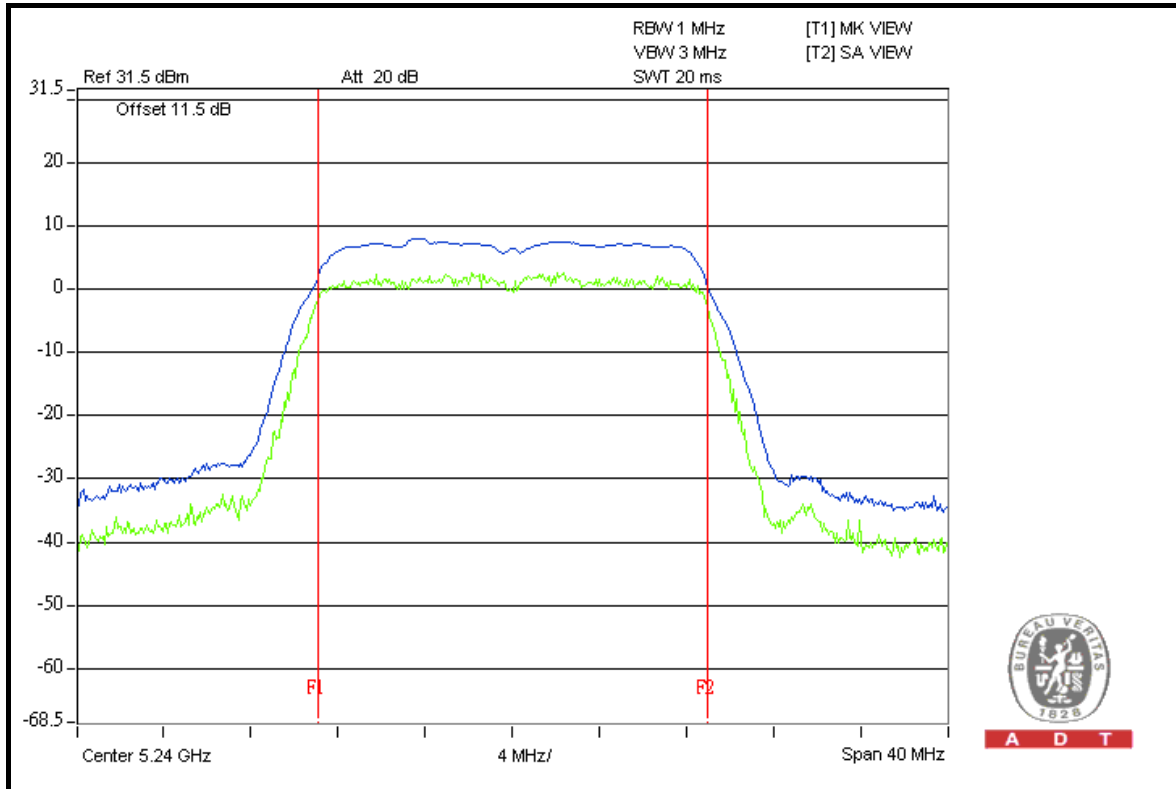



A D T

802.11n (40MHz)

CHANNEL	CHANNEL FREQUENCY (MHz)	PEAK POWER EXCURSION (dB)				PEAK to AVERAGE EXCURSION LIMIT (dB)	PASS/ FAIL
		CHAIN 0	CHAIN 1	CHAIN 2	CHAIN 3		
38	5190	6.75	7.70	6.93	7.59	13	PASS
46	5230	7.03	8.24	7.50	7.93	13	PASS



A D T

### FOR CHAIN 1: CH 46

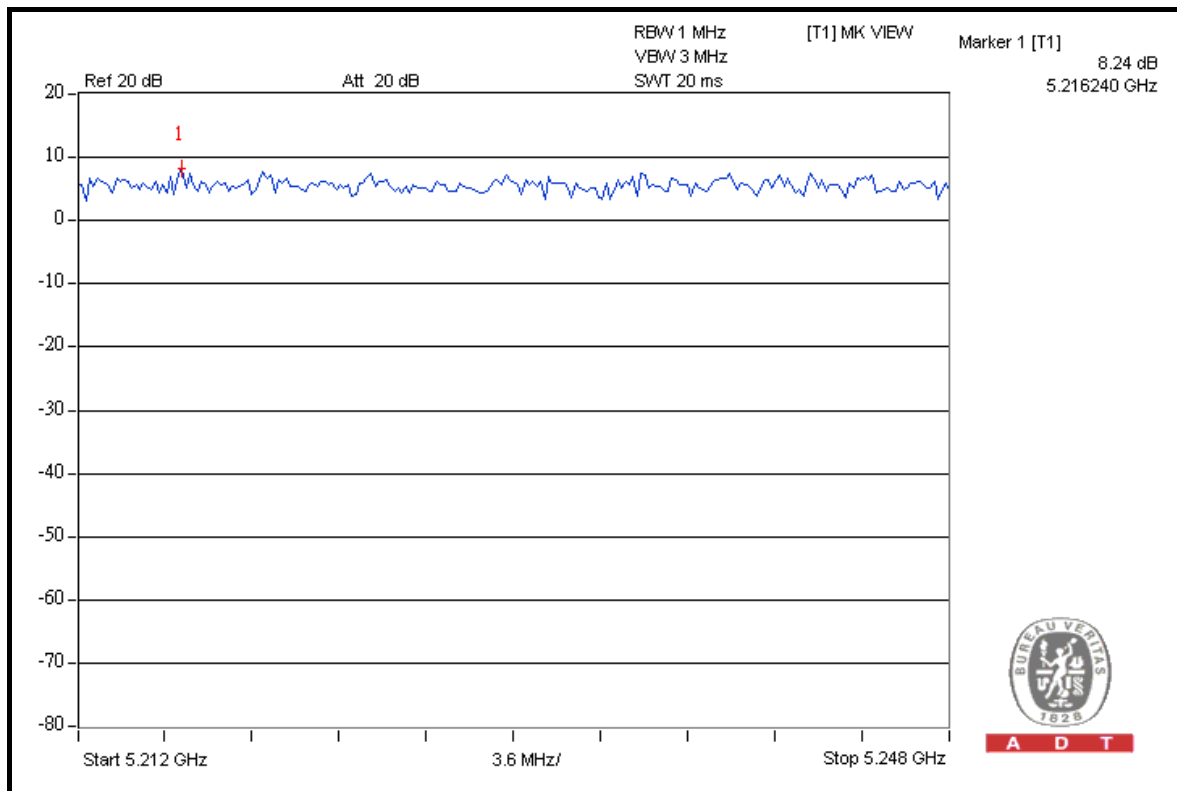
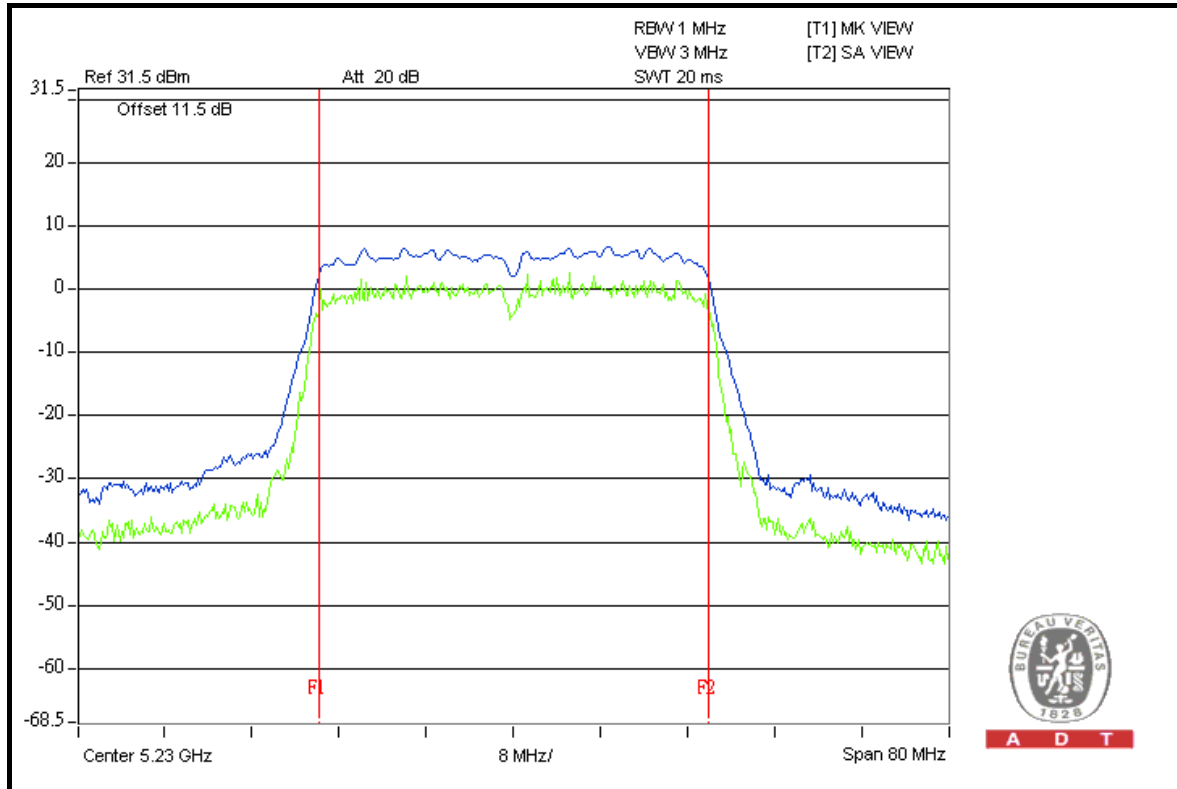



A D T

## 4.5 PEAK POWER SPECTRAL DENSITY MEASUREMENT

### 4.5.1 LIMITS OF PEAK POWER SPECTRAL DENSITY MEASUREMENT

FREQUENCY BAND	LIMIT
5.15 ~ 5.25GHz	4dBm

### 4.5.2 TEST INSTRUMENTS

DESCRIPTION & MANUFACTURER	MODEL NO.	SERIAL NO.	DATE OF CALIBRATION	DUE DATE OF CALIBRATION
SPECTRUM ANALYZER R&S	FSP40	100040	Jul. 17, 2010	Jul. 16, 2011

**NOTE:** The calibration interval of the above test instruments is 12 months and the calibrations are traceable to NML/ROC and NIST/USA.

### 4.5.3 TEST PROCEDURES

- a. The transmitter output was connected to the spectrum analyzer.
- b. Set RBW = 1MHz, VBW = 3MHz. The PPSD is the highest level found across the emission in any 1MHz band.

#### 4.5.4 DEVIATION FROM TEST STANDARD

No deviation

#### 4.5.5 TEST SETUP



#### 4.5.6 EUT OPERATING CONDITIONS

Same as 5.3.6





A D T

### 4.5.7 TEST RESULTS

#### 802.11a

CHAN.	CHAN. FREQ. (MHz)	RF POWER LEVEL IN 3kHz BW (dBm)				TOTAL POWER DENSITY (dBm)	MAX. LIMIT (dBm)	PASS / FAIL
		CHAIN 0	CHAIN 1	CHAIN 2	CHAIN 3			
36	5180	-2.6	-2.4	-2.1	-2.5	3.6	4	PASS
40	5200	-2.7	-2.6	-2.0	-2.4	3.6	4	PASS
48	5240	-2.1	-2.6	-2.0	-2.7	3.7	4	PASS

#### FOR CHAIN 2: CH 48

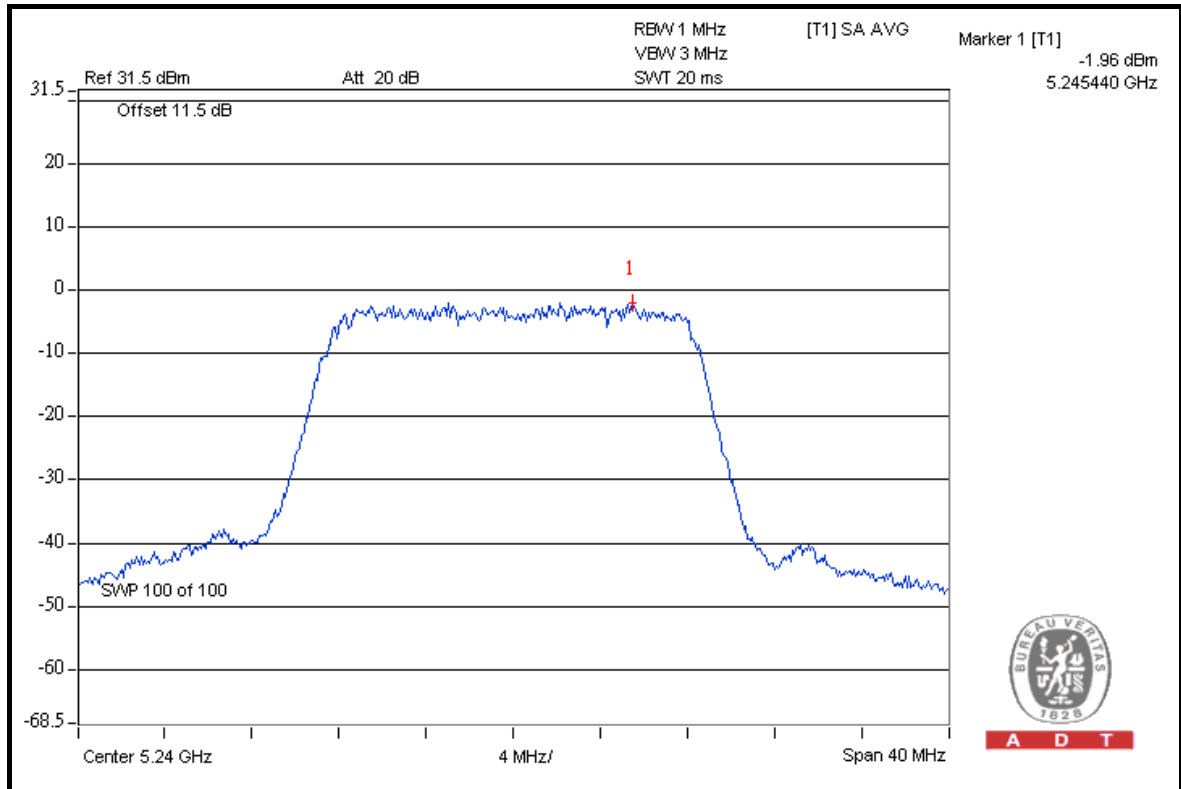

A D T



A D T

### 802.11n (20MHz)

CHAN.	CHAN. FREQ. (MHz)	RF POWER LEVEL IN 3kHz BW (dBm)				TOTAL POWER DENSITY (dBm)	MAX. LIMIT (dBm)	PASS / FAIL
		CHAIN 0	CHAIN 1	CHAIN 2	CHAIN 3			
36	5180	-2.5	-2.9	-3.0	-2.8	3.2	4	PASS
40	5200	-3.0	-3.2	-2.8	-2.1	3.3	4	PASS
48	5240	-3.0	-3.0	-3.1	-2.0	3.3	4	PASS

### FOR CHAIN 3: CH 48

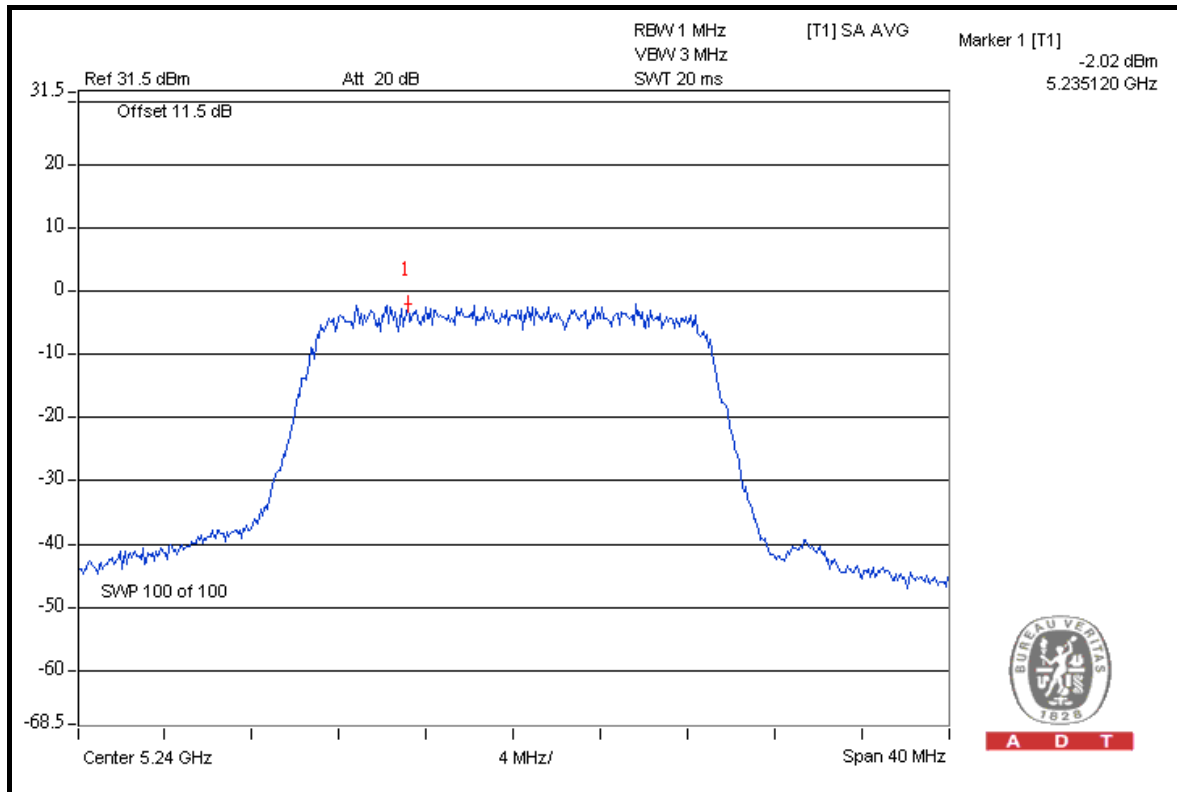



A D T

### 802.11n (40MHz)

CHAN.	CHAN. FREQ. (MHz)	RF POWER LEVEL IN 3kHz BW (dBm)				TOTAL POWER DENSITY (dBm)	MAX. LIMIT (dBm)	PASS / FAIL
		CHAIN 0	CHAIN 1	CHAIN 2	CHAIN 3			
38	5190	-6.9	-5.9	-5.7	-5.5	0.1	4	PASS
46	5230	-6.3	-5.7	-5.8	-5.3	0.3	4	PASS

### FOR CHAIN 3: CH 46

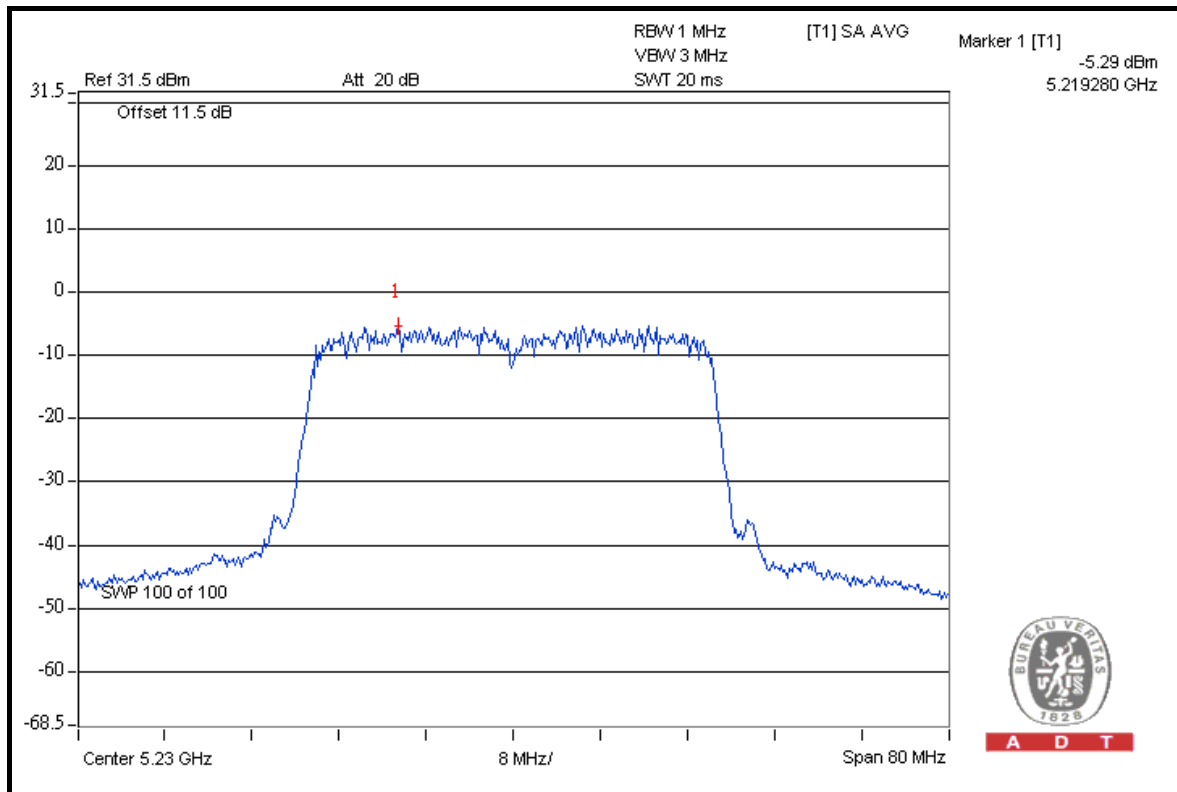

## 4.6 FREQUENCY STABILITY

### 4.6.1 LIMITS OF FREQUENCY STABILITY MEASUREMENT

The frequency tolerance of the carrier signal shall be maintained within +/- 0.02% of the operating frequency over a temperature variation of -30 degrees to 50 degrees C at normal supply voltage, and for a variation in the primary supply voltage from 85% to 115% of the rated supply voltage at a temperature of 20 degrees C.

### 4.6.2 TEST INSTRUMENTS

DESCRIPTION & MANUFACTURER	MODEL NO.	SERIAL NO.	DATE OF CALIBRATION	CALIBRATED UNTIL
SPECTRUM ANALYZER R&S	FSP40	100040	Jul. 17, 2010	Jul. 16, 2011
WIT STANDARD TEMPERATURE AND HUMIDITY CHAMBER	TH-4S-C	W981030	Jun. 28, 2010	Jun. 27, 2011

**NOTE:** The calibration interval of the above test instruments is 12 months and the calibrations are traceable to NML/ROC and NIST/USA.

### 4.6.3 TEST PROCEDURE

- a. The EUT was placed inside the environmental test chamber and powered by nominal DC voltage.
- b. Turn the EUT on and couple its output to a spectrum analyzer.
- c. Turn the EUT off and set the chamber to the highest temperature specified.
- d. Allow sufficient time (approximately 30 min) for the temperature of the chamber to stabilize, turn the EUT on and measure the operating frequency after 2, 5, and 10 minutes.
- e. Repeat step 2 and 3 with the temperature chamber set to the lowest temperature.
- f. The test chamber was allowed to stabilize at +20 degree C for a minimum of 30 minutes. The supply voltage was then adjusted on the EUT from 85% to 115% and the frequency record.

#### 4.6.4 DEVIATION FROM TEST STANDARD

No deviation.

#### 4.6.5 TEST SETUP

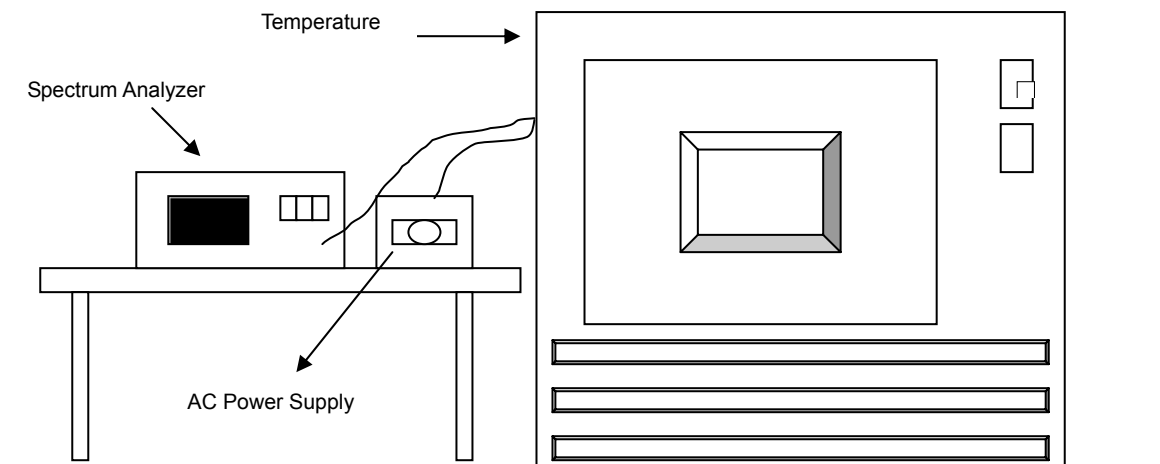

#### 4.6.6 EUT OPERATING CONDITION

Same as Item 4.1.6.



A D T

#### 4.6.7 TEST RESULTS

FREQUENCY STABILITY VERSUS TEMP.									
OPERATING FREQUENCY: 5200MHz									
TEMP. (°C)	POWER SUPPLY (Vdc)	0 MINUTE		2 MINUTE		5 MINUTE		10 MINUTE	
		Measured Frequency	Frequency Drift	Measured Frequency	Frequency Drift	Measured Frequency	Frequency Drift	Measured Frequency	Frequency Drift
		(MHz)	ppm	(MHz)	ppm	(MHz)	ppm	(MHz)	ppm
50	110.0	5199.987916	-2.324	5199.987853	-2.336	5199.987678	-2.370	5199.988214	-2.267
40	110.0	5199.988641	-2.184	5199.988557	-2.201	5199.988283	-2.253	5199.988726	-2.168
30	110.0	5199.989703	-1.980	5199.990088	-1.906	5199.989645	-1.991	5199.990213	-1.882
20	110.0	5199.991186	-1.695	5199.991296	-1.674	5199.991059	-1.719	5199.990678	-1.793
10	110.0	5199.992249	-1.491	5199.992691	-1.406	5199.992419	-1.458	5199.992263	-1.488
0	110.0	5199.991179	-1.696	5199.990686	-1.791	5199.991308	-1.672	5199.990885	-1.753
-10	110.0	5199.989448	-2.029	5199.989611	-1.998	5199.989378	-2.043	5199.989629	-1.994
-20	110.0	5199.988647	-2.183	5199.988926	-2.130	5199.988651	-2.182	5199.988848	-2.145
-30	110.0	5199.987567	-2.391	5199.987674	-2.370	5199.988180	-2.273	5199.988217	-2.266

FREQUENCY STABILITY VERSUS VOLTAGE									
OPERATING FREQUENCY: 5200MHz									
TEMP. (°C)	POWER SUPPLY (Vac)	0 MINUTE		2 MINUTE		5 MINUTE		10 MINUTE	
		Measured Frequency	Frequency Drift	Measured Frequency	Frequency Drift	Measured Frequency	Frequency Drift	Measured Frequency	Frequency Drift
		(MHz)	ppm	(MHz)	ppm	(MHz)	ppm	(MHz)	ppm
20	93.5	5199.990658	-1.797	5199.990326	-1.860	5199.990624	-1.803	5199.990207	-1.883
	110.0	5199.991186	-1.695	5199.991296	-1.674	5199.991059	-1.719	5199.990678	-1.793
	126.5	5199.992462	-1.450	5199.992336	-1.474	5199.992339	-1.473	5199.992928	-1.360



A D T

## 4.7 BAND EDGES MEASUREMENT

### 4.7.1 TEST INSTRUMENTS

DESCRIPTION & MANUFACTURER	MODEL NO.	SERIAL NO.	DATE OF CALIBRATION	DUE DATE OF CALIBRATION
Test Receiver ROHDE & SCHWARZ	ESIB7	100188	Dec. 21, 2009	Dec. 20, 2010
Spectrum Analyzer ROHDE & SCHWARZ	FSP40	100041	Jul. 09, 2010	Jul. 08, 2011
BILOG Antenna SCHWARZBECK	VULB9168	9168-156	Apr. 30, 2010	Apr. 29, 2011
HORN Antenna SCHWARZBECK	BBHA 9120 D	9120D-563	Aug. 10, 2009	Aug. 09, 2010
HORN Antenna SCHWARZBECK	BBHA 9170	BBHA9170242	Dec. 25, 2009	Dec. 24, 2010
Preamplifier Agilent	8449B	3008A01910	Sep. 11, 2009	Sep. 10, 2010
Preamplifier Agilent	8447D	2944A10638	Dec. 21, 2009	Dec. 20, 2010
RF signal cable HUBER+SUHNNER	SUCOFLEX 104	218190/4 231241/4	May 14, 2010	May 13, 2011
RF signal cable Worken	8D-FB	Cable-HYCH9-01	Aug. 17, 2009	Aug. 16, 2010
Software	ADT_Radiated_ V7.6.15.9.2	NA	NA	NA
Antenna Tower EMCO	2070/2080	512.835.4684	NA	NA
Turn Table EMCO	2087-2.03	NA	NA	NA
Antenna Tower & Turn Table Controller EMCO	2090	NA	NA	NA
26GHz ~ 40GHz Amplifier	EM26400	07026401	Aug. 27, 2009	Aug. 26, 2010

**NOTE:** The calibration interval of the above test instruments is 12 months and the calibrations are traceable to NML/ROC and NIST/USA.

#### 4.7.2 TEST PROCEDURE

- a. The EUT was placed on the top of a rotating table 0.8 meters above the ground at a 3 meter semi-anechoic chamber. The table was rotated 360 degrees to determine the position of the highest radiation.
- b. The EUT was set 3 meters away from the interference-receiving antenna, which was mounted on the top of a variable-height antenna tower.
- c. The antenna is a broadband antenna, and its height is varied from one meter to four meters above the ground to determine the maximum value of the field strength. Both horizontal and vertical polarizations of the antenna are set to make the measurement.
- d. For each suspected emission, the EUT was arranged to its worst case and then the antenna was tuned to heights from 1 meter to 4 meters and the rotatable table was turned from 0 degrees to 360 degrees to find the maximum reading.
- e. Set both RBW and VBW of spectrum analyzer to 1MHz and 3MHz with suitable frequency span including 100MHz bandwidth from band edge. The band edges was measured and recorded.

**NOTE:** The resolution bandwidth of test receiver/spectrum analyzer is 1MHz and the video bandwidth is 10Hz for Average detection (AV) at frequency above 1GHz

#### 4.7.3 EUT OPERATING CONDITION

The software provided by client to enable the EUT under transmission condition continuously at specific channel frequencies individually.





#### 4.7.4 TEST RESULTS

For signals in the restricted bands above and below the 5.15 to 5.25GHz allocated band a measurement was made of the amplitude of the spurious emissions with respect to the intentional signals. The relative amplitude, in dBc, was applied to the average and peak field strength of the intentional signal made on the OATS to calculate the field strength of the unintentional signals.

The spectrum plots (Peak RBW = 1MHz, VBW = 3MHz) are attached on the following pages.

#### 802.11a

##### RESTRICT BAND (4500 ~ 5150 MHz)

FREQUENCY (MHz)	FUNDAMENTAL EMISSION (dBuV/m)	DELTA (dB)	MAXIMUM FIELD STRENGTH IN RESTRICT BAND (dBuV/m)	LIMIT (dBuV/m)
5180.00 (PK)	111.2	44.71	66.49	74.00
5180.00 (AV)	100.0	47.20	52.80	54.00

##### RESTRICT BAND (5350 ~ 5460 MHz)

FREQUENCY (MHz)	FUNDAMENTAL EMISSION (dBuV/m)	DELTA (dB)	MAXIMUM FIELD STRENGTH IN RESTRICT BAND (dBuV/m)	LIMIT (dBuV/m)
5240.00 (PK)	111.7	43.56	68.14	74.00
5240.00 (AV)	100.8	48.13	52.67	54.00

**NOTE:**

1. Delta = Amplitude between the peak of the fundamental and the peak of the band edge emission. Please check following 3 pages.
2. Maximum field strength in restrict band = Fundamental emission – Delta.



A D T

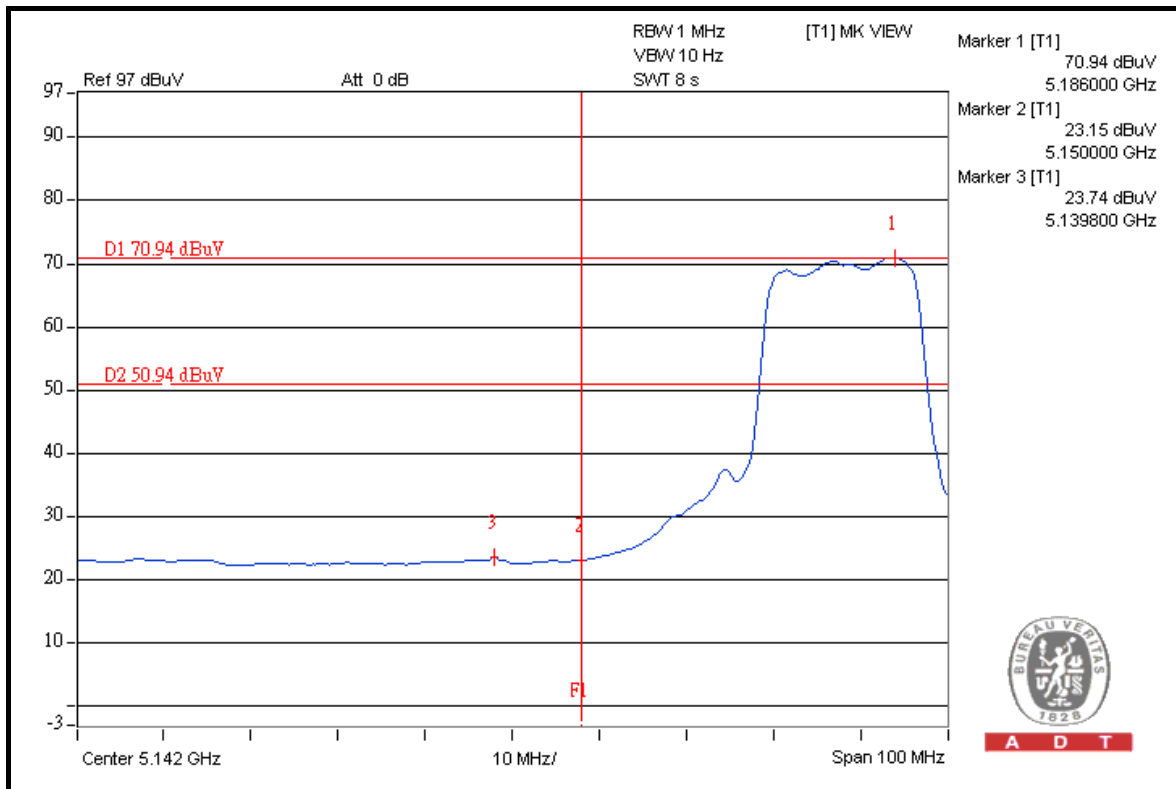
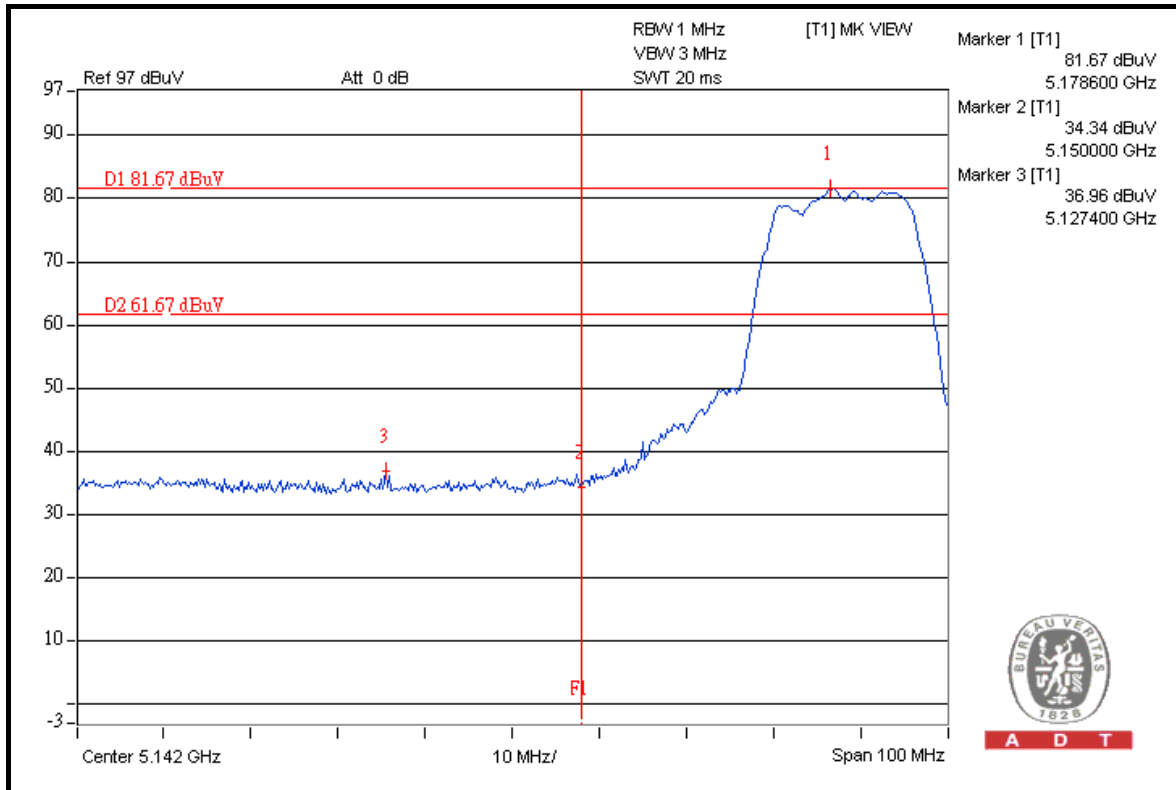



A D T

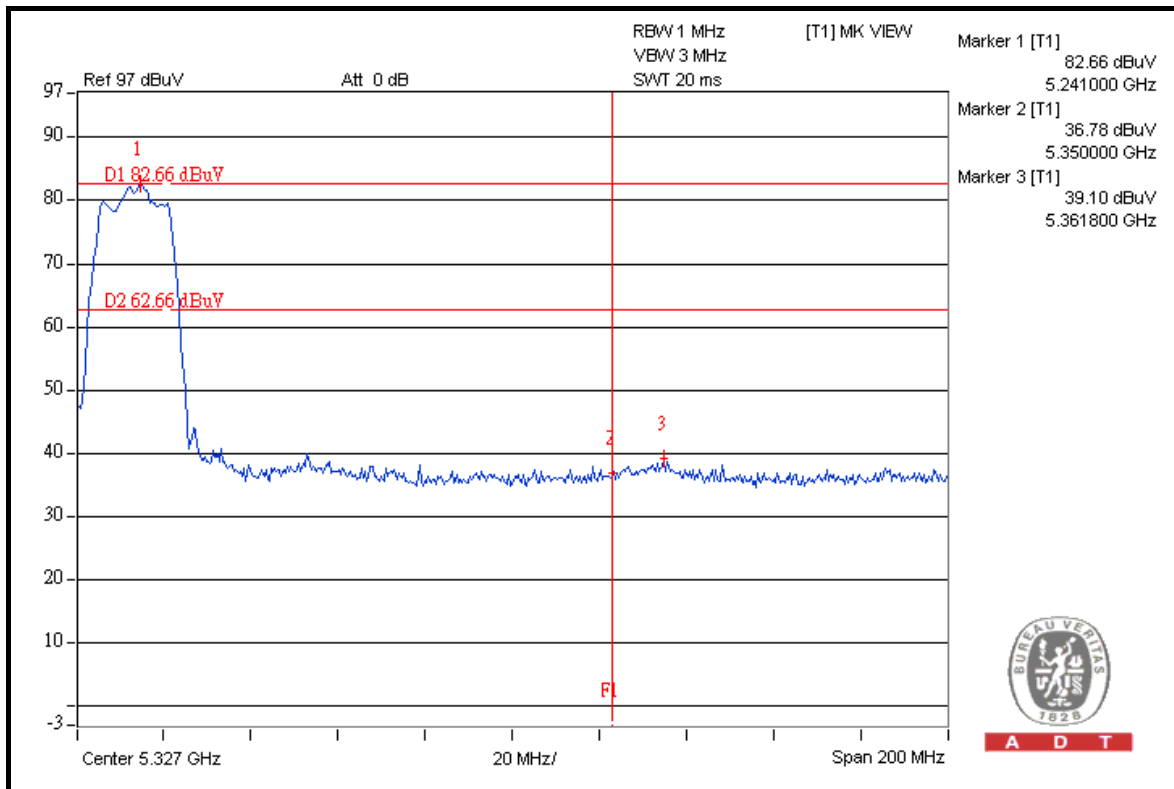
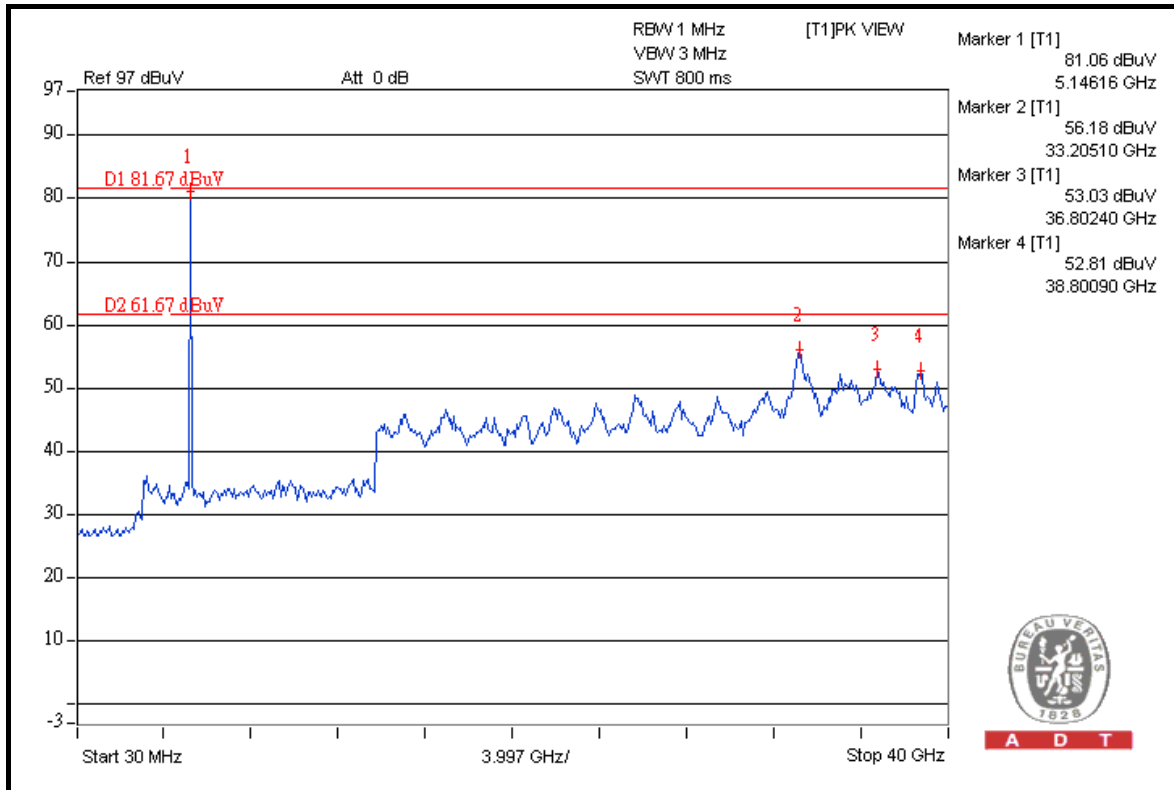



A D T

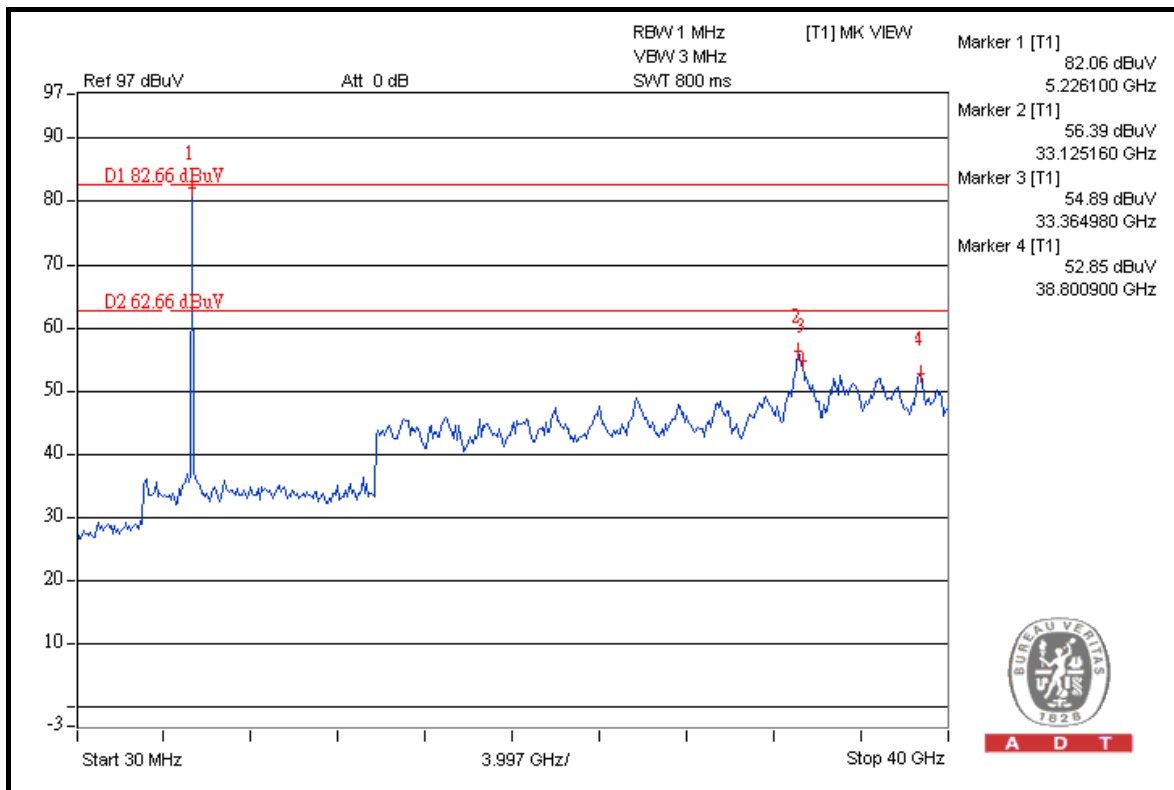
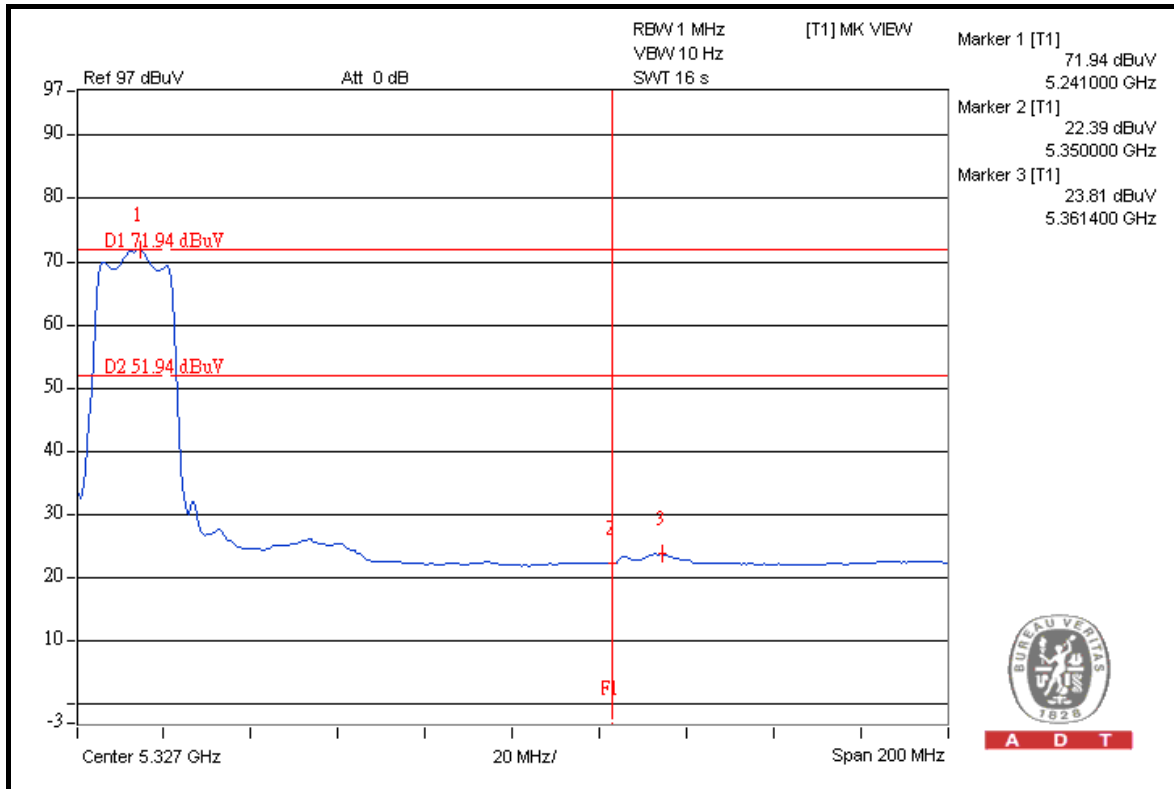



A D T

## 802.11n (20MHz)

### RESTRICT BAND (4500 ~ 5150 MHz)

FREQUENCY (MHz)	FUNDAMENTAL EMISSION (dBuV/m)	DELTA (dB)	MAXIMUM FIELD STRENGTH IN RESTRICT BAND (dBuV/m)	LIMIT (dBuV/m)
5180.00 (PK)	112.4	45.23	67.17	74.00
5180.00 (AV)	99.5	46.44	53.06	54.00

### RESTRICT BAND (5350 ~ 5460 MHz)

FREQUENCY (MHz)	FUNDAMENTAL EMISSION (dBuV/m)	DELTA (dB)	MAXIMUM FIELD STRENGTH IN RESTRICT BAND (dBuV/m)	LIMIT (dBuV/m)
5240.00 (PK)	111.9	45.49	66.41	74.00
5240.00 (AV)	99.1	46.37	52.73	54.00

#### NOTE:

1. Delta = Amplitude between the peak of the fundamental and the peak of the band edge emission. Please check following 3 pages.
2. Maximum field strength in restrict band = Fundamental emission – Delta.



A D T

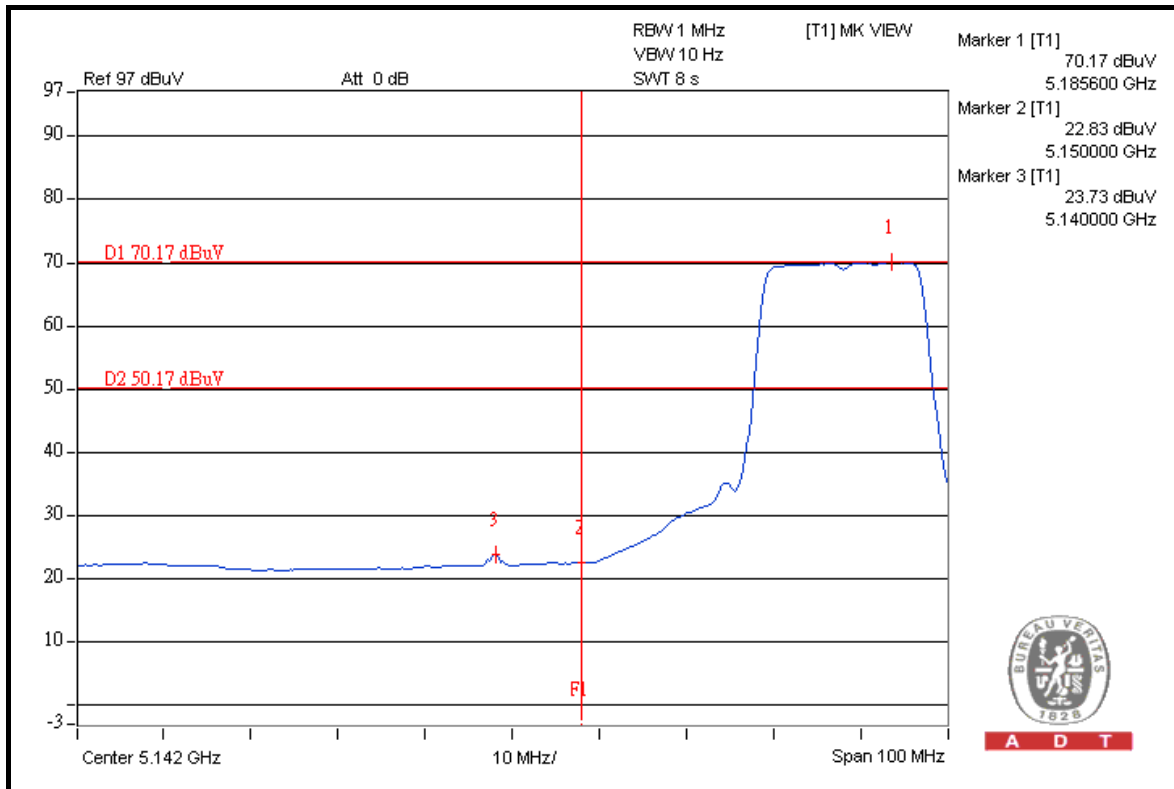
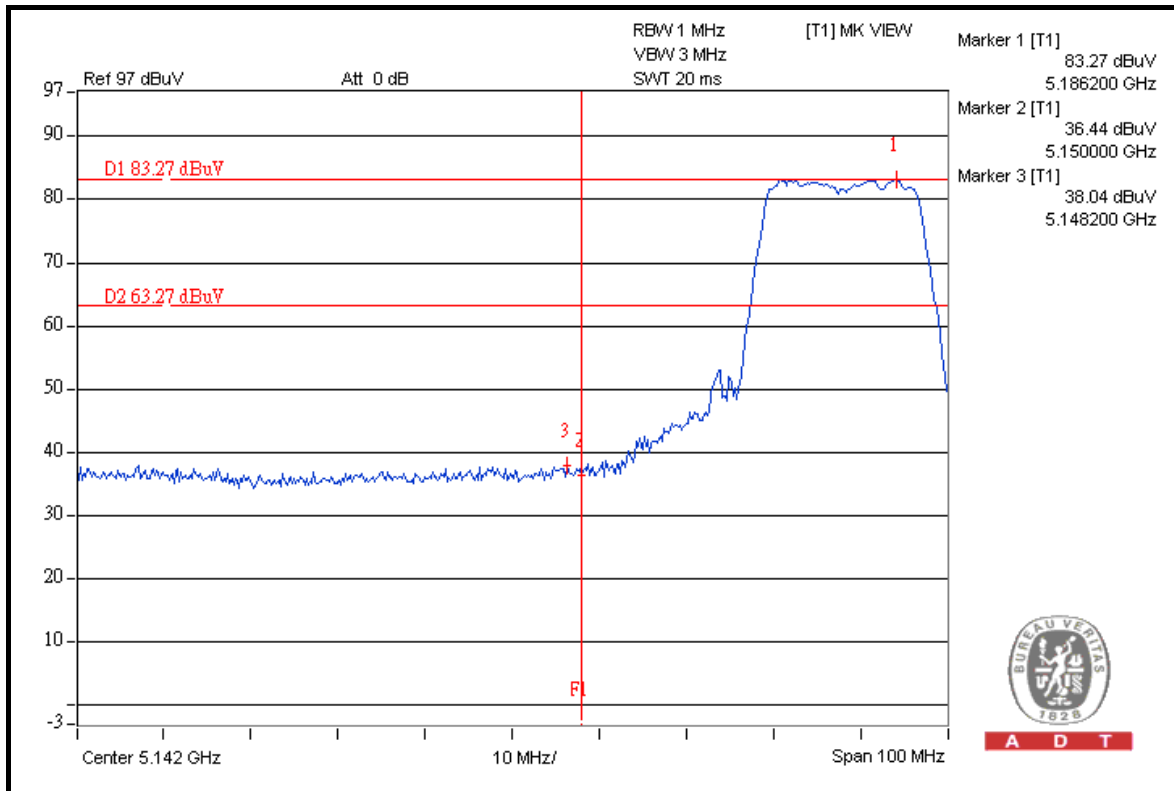



A D T

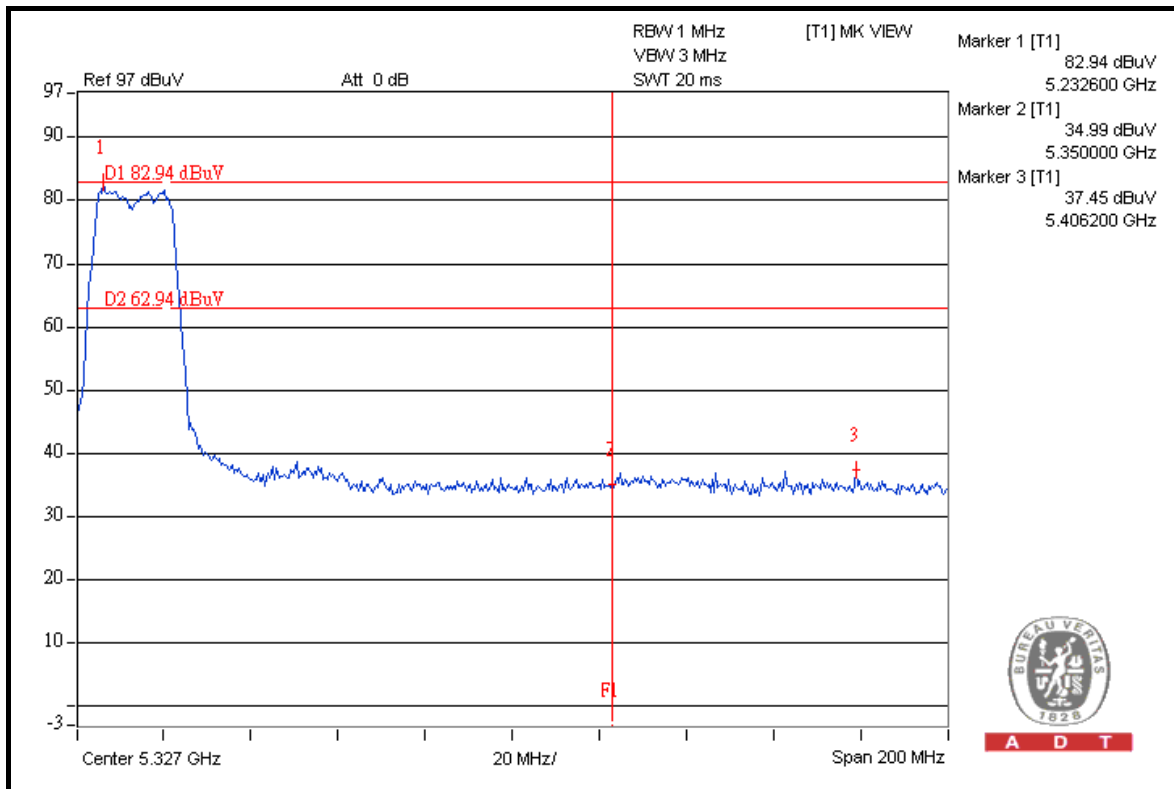
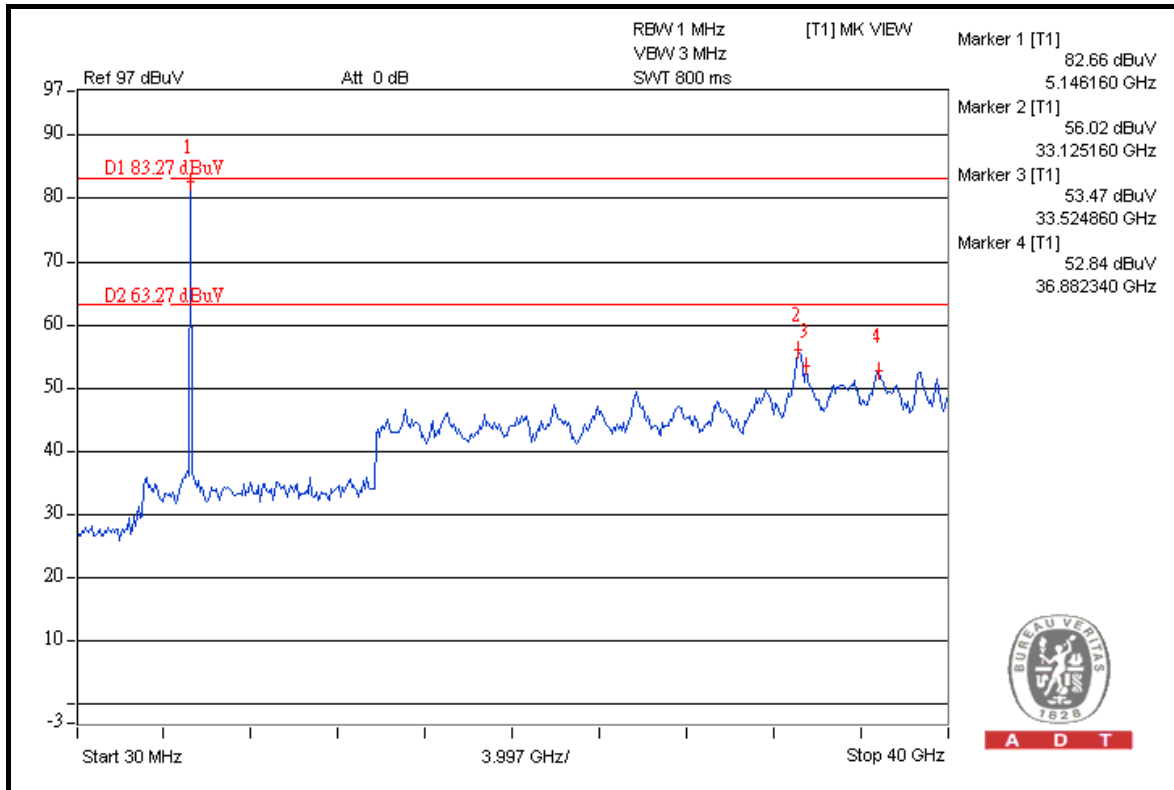



A D T

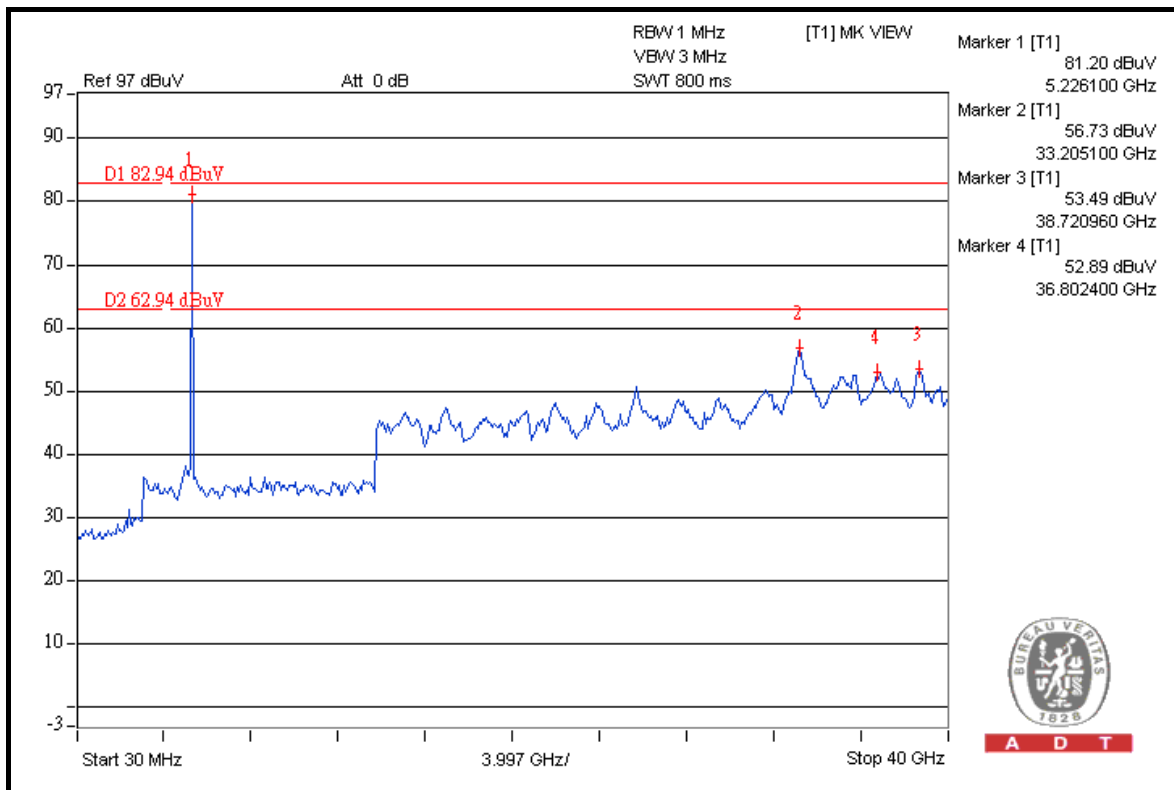
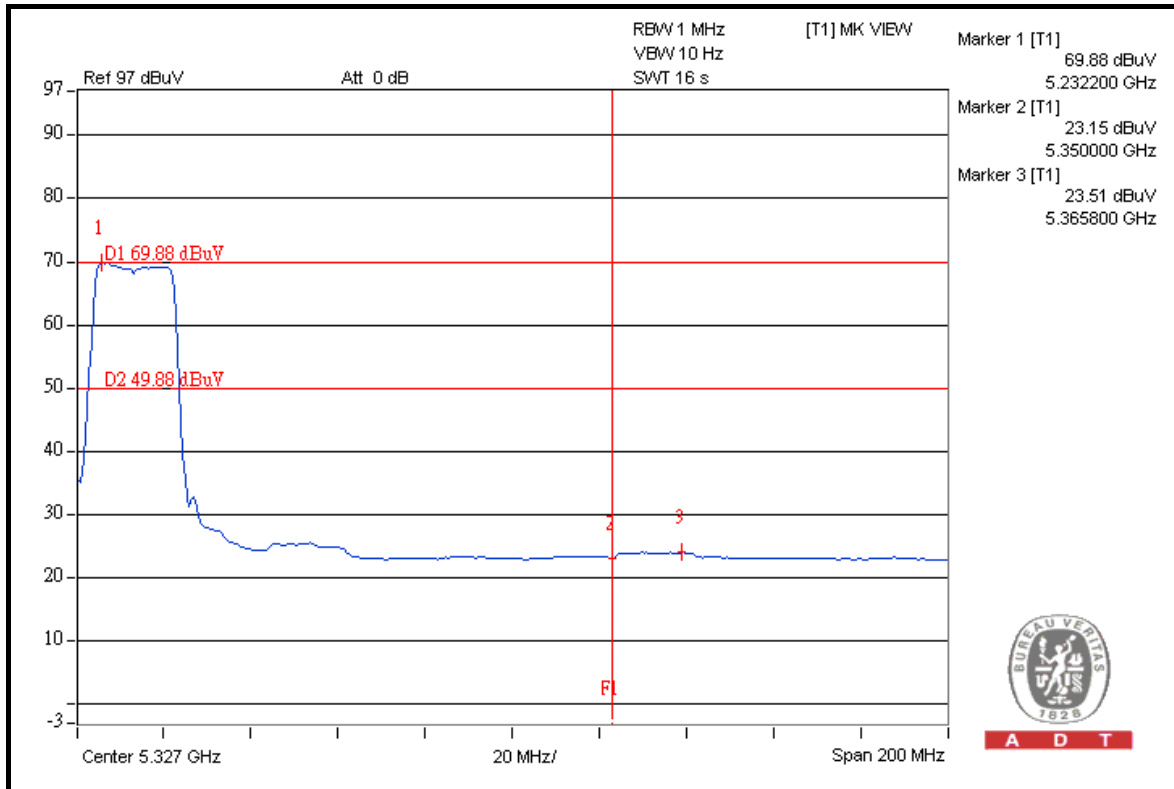





A D T

## 802.11n (40MHz)

### RESTRICT BAND (4500 ~ 5150 MHz)

FREQUENCY (MHz)	FUNDAMENTAL EMISSION (dBuV/m)	DELTA (dB)	MAXIMUM FIELD STRENGTH IN RESTRICT BAND (dBuV/m)	LIMIT (dBuV/m)
5190.00 (PK)	107.8	42.57	65.23	74.00
5190.00 (AV)	94.8	42.25	52.55	54.00

### RESTRICT BAND (5350 ~ 5460 MHz)

FREQUENCY (MHz)	FUNDAMENTAL EMISSION (dBuV/m)	DELTA (dB)	MAXIMUM FIELD STRENGTH IN RESTRICT BAND (dBuV/m)	LIMIT (dBuV/m)
5230.00 (PK)	107.7	45.15	62.55	74.00
5230.00 (AV)	94.9	41.98	52.92	54.00

#### NOTE:

1. Delta = Amplitude between the peak of the fundamental and the peak of the band edge emission. Please check following 3 pages.
2. Maximum field strength in restrict band = Fundamental emission – Delta.



A D T

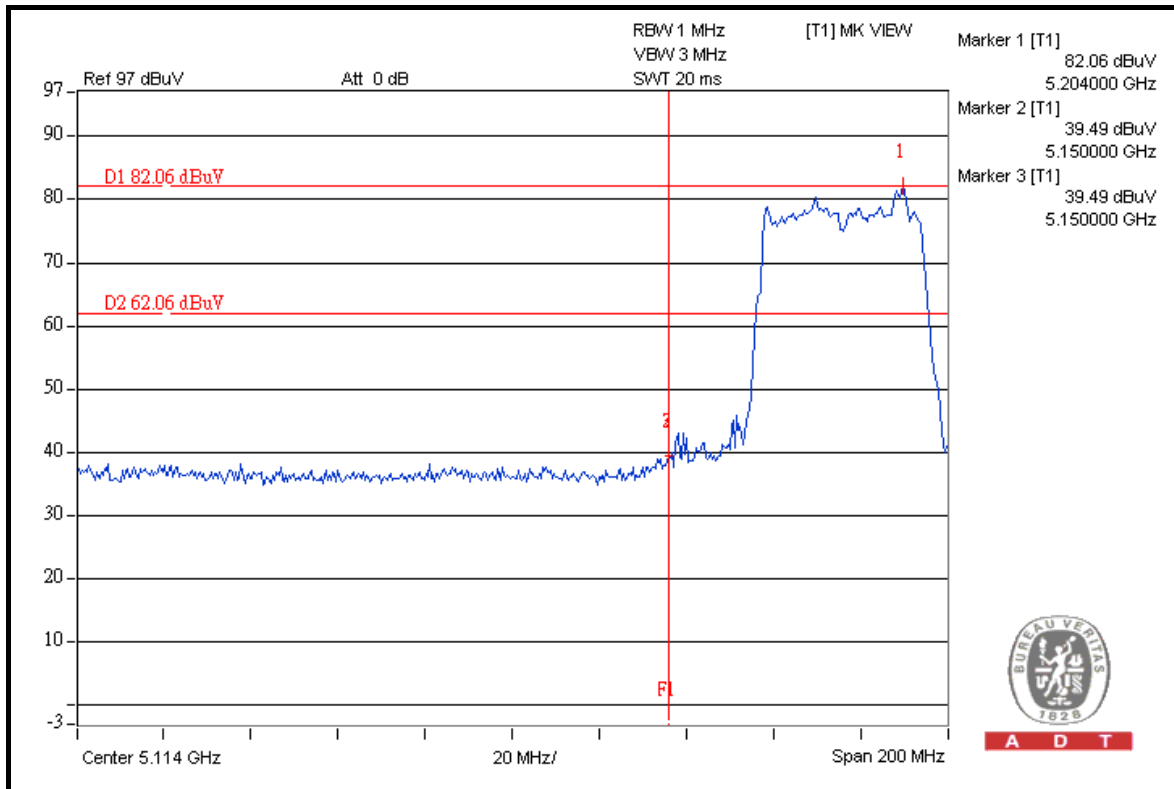

A D T

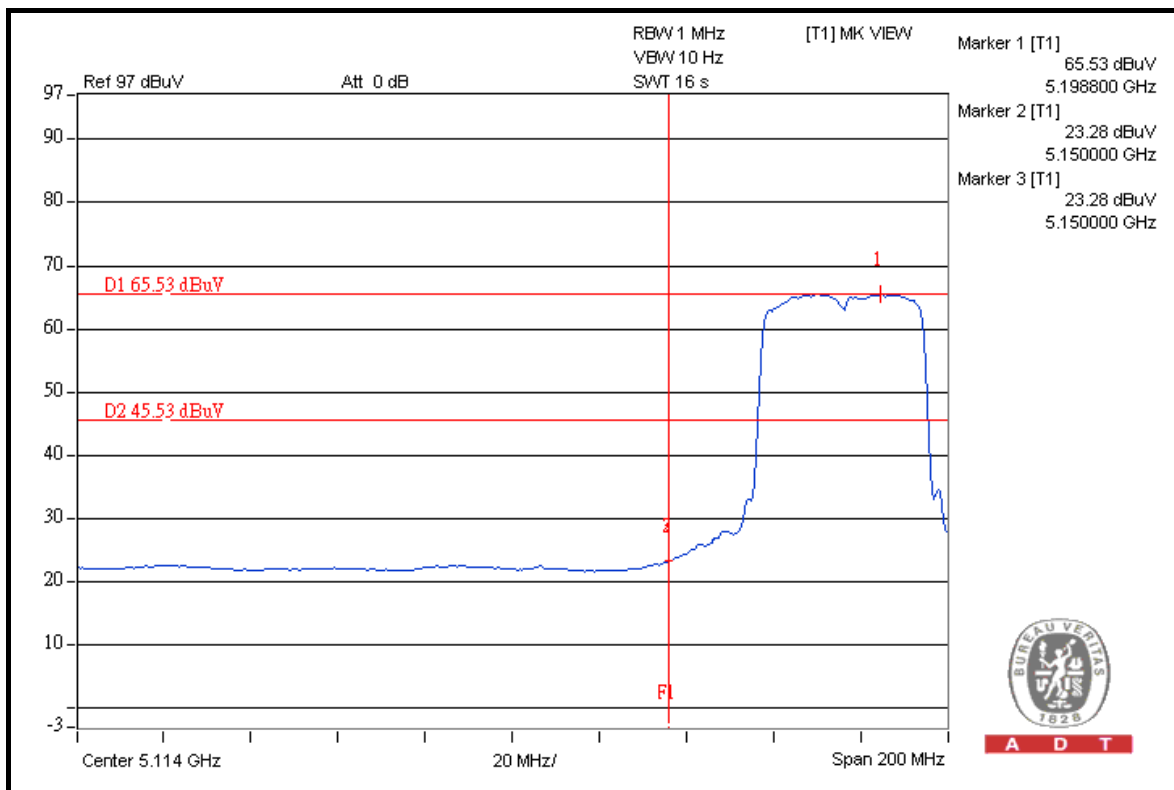

A D T



A D T

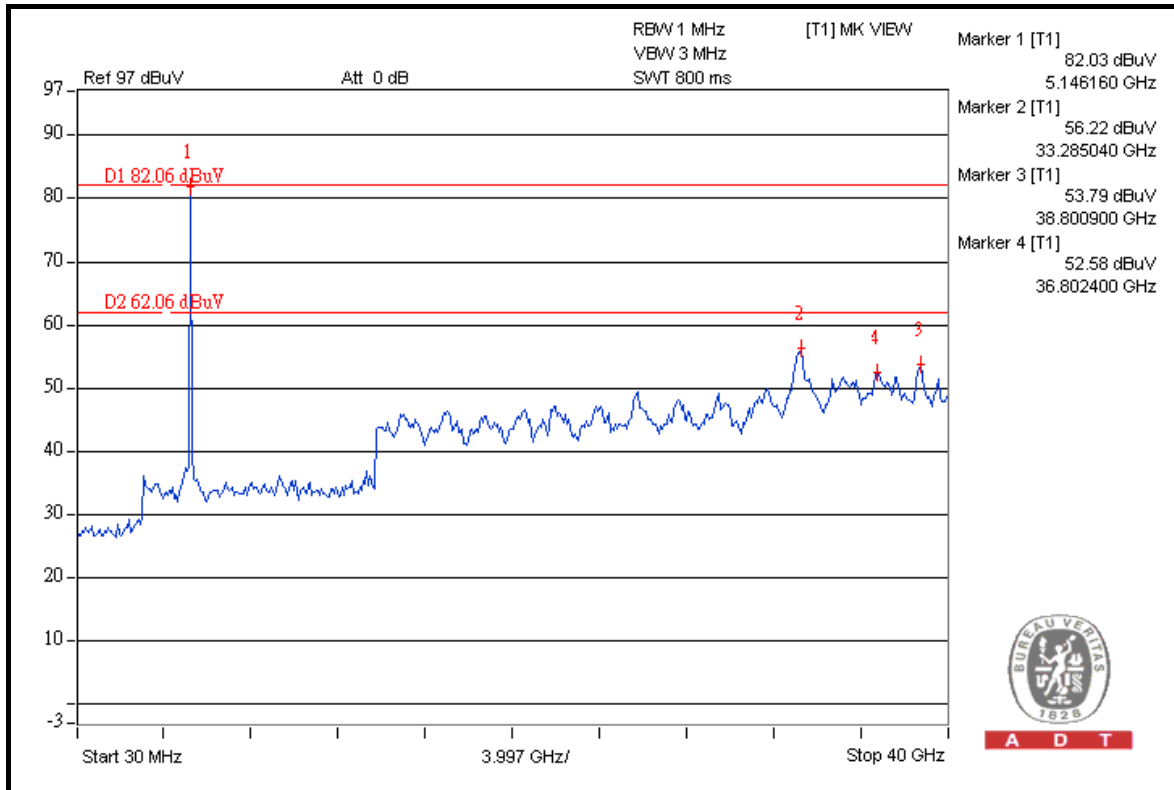

A D T

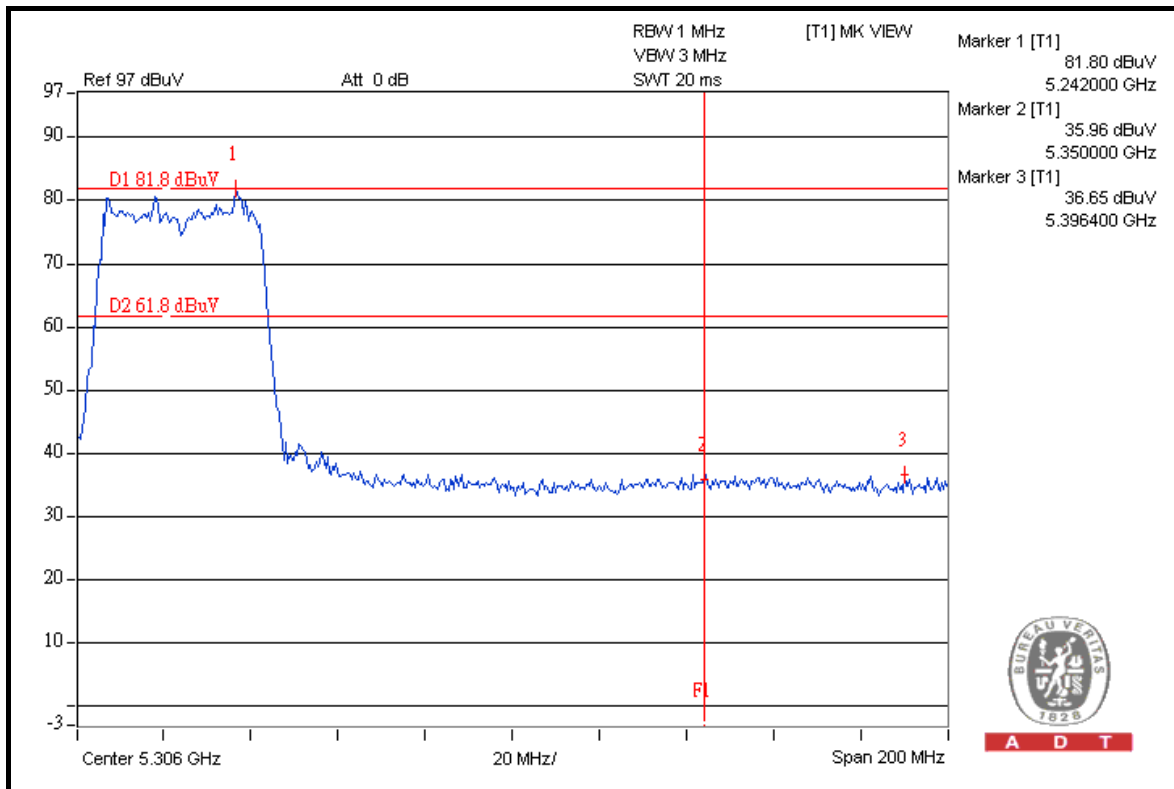

A D T



A D T

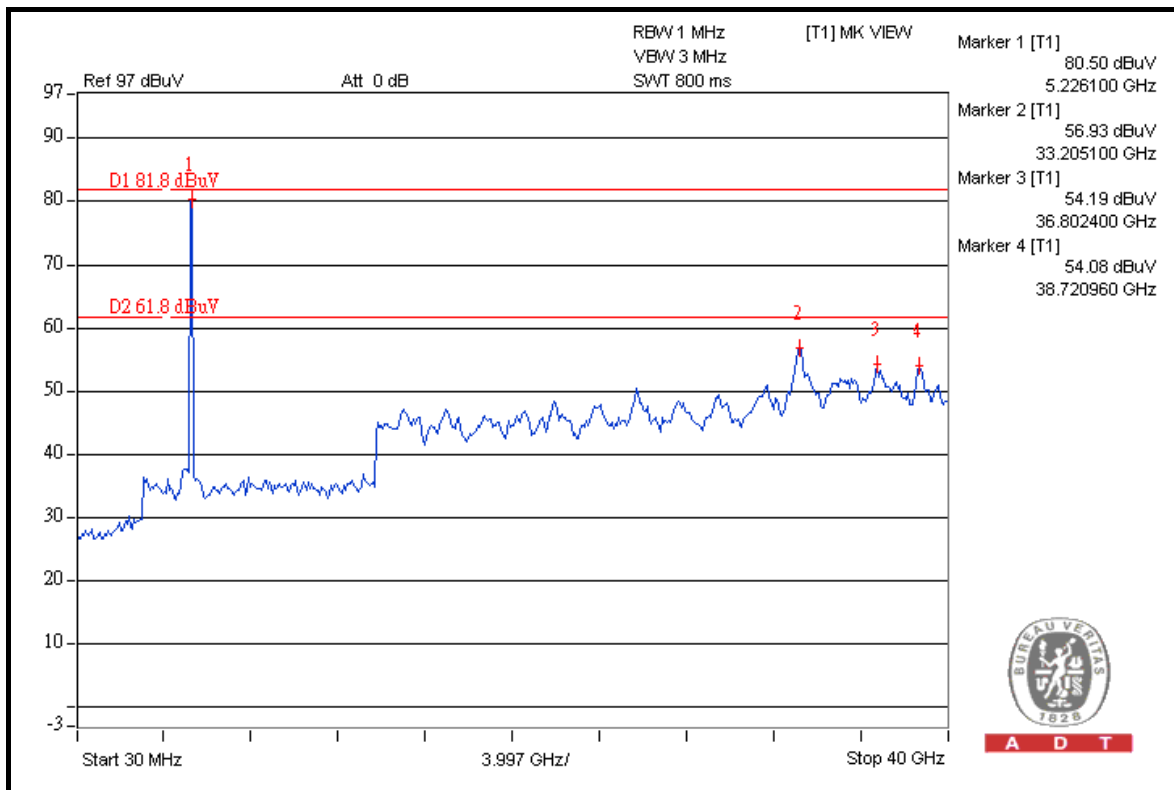
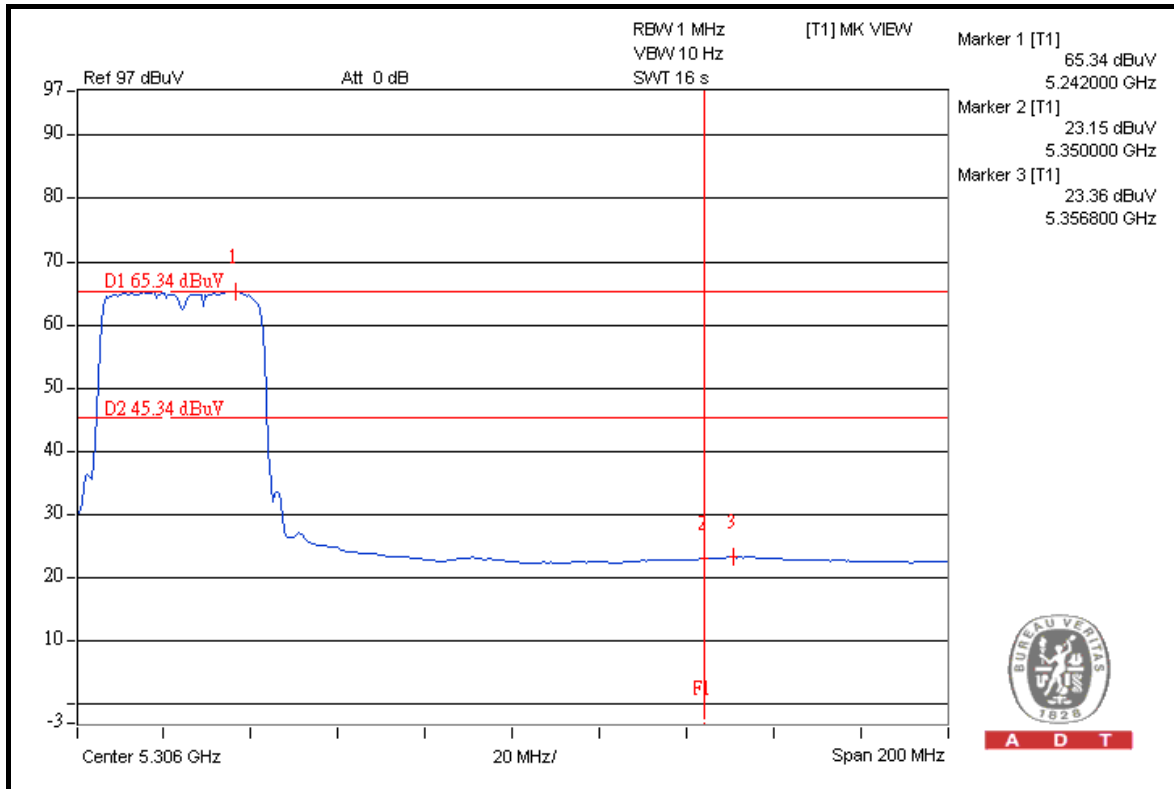



A D T

## 5. PHOTOGRAPHS OF THE TEST CONFIGURATION

Please refer to the attached file (Test Setup Photo).



A D T

## 6. INFORMATION ON THE TESTING LABORATORIES

We, Bureau Veritas Consumer Products Services (H.K.) Ltd., Taoyuan Branch, were founded in 1988 to provide our best service in EMC, Radio, Telecom and Safety consultation. Our laboratories are accredited and approved according to ISO/IEC 17025.

Copies of accreditation certificates of our laboratories obtained from approval agencies can be downloaded from our web site:

[www.adt.com.tw/index.5/phtml](http://www.adt.com.tw/index.5/phtml). If you have any comments, please feel free to contact us at the following:

**Linko EMC/RF Lab:**

Tel: 886-2-26052180

Fax: 886-2-26051924

**Hsin Chu EMC/RF Lab:**

Tel: 886-3-5935343

Fax: 886-3-5935342

**Hwa Ya EMC/RF/Safety Telecom Lab:**

Tel: 886-3-3183232

Fax: 886-3-3185050

**Web Site:** [www.adt.com.tw](http://www.adt.com.tw)

The address and road map of all our labs can be found in our web site also.



A D T

## **7. APPENDIX A - MODIFICATIONS RECORDERS FOR ENGINEERING CHANGES TO THE EUT BY THE LAB**

No any modifications are made to the EUT by the lab during the test.

**---END---**