



A D T

FCC TEST REPORT (15.407)

REPORT NO.: RF980618L05D

MODEL NO.: WNDR3700v2

(refer to item 3.1 for more detail)

FCC ID: PY308300092

RECEIVED: Sep. 01, 2010

TESTED: Sep. 03 ~ Sep. 13, 2010

ISSUED: Nov. 11, 2010

APPLICANT: NETGEAR, INC.

ADDRESS: 350 East Plumeria Drive San Jose, CA 95134

ISSUED BY: Bureau Veritas Consumer Products Services
(H.K.) Ltd., Taoyuan Branch

LAB ADDRESS: No. 47, 14th Ling, Chia Pau Tsuen, Lin Kou
Hsiang, Taipei Hsien 244, Taiwan, R.O.C.

TEST LOCATION: No. 19, Hwa Ya 2nd Rd, Wen Hwa Tsuen, Kwei
Shan Hsiang, Taoyuan Hsien 333, Taiwan,
R.O.C.

This test report consists of 104 pages. It may be duplicated completely for legal use with the approval of the applicant. It should not be reproduced except in full, without the written approval of our laboratory. The client should not use it to claim product certification, approval, or endorsement by TAF or any government agency. The test results in the report only apply to the tested sample.





TABLE OF CONTENTS

1.	CERTIFICATION.....	4
2.	SUMMARY OF TEST RESULTS	5
2.1	MEASUREMENT UNCERTAINTY.....	5
3.	GENERAL INFORMATION.....	6
3.1	GENERAL DESCRIPTION OF EUT	6
3.2	DESCRIPTION OF TEST MODES	9
3.2.1	CONFIGURATION OF SYSTEM UNDER TEST	9
3.2.2	TEST MODE APPLICABILITY AND TESTED CHANNEL DETAIL	10
3.3	GENERAL DESCRIPTION OF APPLIED STANDARDS	13
3.4	DESCRIPTION OF SUPPORT UNITS	13
4.	TEST TYPES AND RESULTS	14
4.1	RADIATED EMISSION MEASUREMENT	14
4.1.1	LIMITS OF RADIATED EMISSION MEASUREMENT	14
4.1.2	LIMITS OF UNWANTED EMISSION OUT OF THE RESTRICTED BANDS	14
4.1.3	TEST INSTRUMENTS.....	15
4.1.4	TEST PROCEDURES	17
4.1.5	DEVIATION FROM TEST STANDARD.....	17
4.1.6	TEST SETUP.....	18
4.1.7	EUT OPERATING CONDITION.....	18
4.1.8	TEST RESULTS	19
4.2	CONDUCTED EMISSION MEASUREMENT	41
4.2.1	LIMITS OF CONDUCTED EMISSION MEASUREMENT	41
4.2.2	TEST INSTRUMENTS.....	41
4.2.3	TEST PROCEDURES	42
4.2.4	DEVIATION FROM TEST STANDARD.....	42
4.2.5	TEST SETUP.....	43
4.2.6	EUT OPERATING CONDITIONS	43
4.2.7	TEST RESULTS	44
4.3	MAXIMUM CONDUCTED OUTPUT POWER MEASUREMENT	52
4.3.1	LIMITS OF MAXIMUM CONDUCTED OUTPUT POWER MEASUREMENT.....	52
4.3.2	TEST INSTRUMENTS.....	52
4.3.3	TEST PROCEDURE.....	52
4.3.4	DEVIATION FROM TEST STANDARD.....	52
4.3.5	TEST SETUP.....	53
4.3.6	EUT OPERATING CONDITIONS	53
4.3.7	TEST RESULTS	54
4.4	PEAK POWER EXCURSION MEASUREMENT	60
4.4.1	LIMITS OF PEAK POWER EXCURSION MEASUREMENT	60
4.4.2	TEST INSTRUMENTS.....	60
4.4.3	TEST PROCEDURE.....	60
4.4.4	DEVIATION FROM TEST STANDARD.....	61
4.4.5	TEST SETUP.....	61
4.4.6	EUT OPERATING CONDITIONS	61
4.4.7	TEST RESULTS	62
4.5	PEAK POWER SPECTRAL DENSITY MEASUREMENT	68
4.5.1	LIMITS OF PEAK POWER SPECTRAL DENSITY MEASUREMENT	68
4.5.2	TEST INSTRUMENTS.....	68
4.5.3	TEST PROCEDURES	68



A D T

4.5.4	DEVIATION FROM TEST STANDARD.....	69
4.5.5	TEST SETUP.....	69
4.5.6	EUT OPERATING CONDITIONS	69
4.5.7	TEST RESULTS	70
4.6	FREQUENCY STABILITY.....	73
4.6.1	LIMITS OF FREQUENCY STABILITY MEASUREMENT	73
4.6.2	TEST INSTRUMENTS.....	73
4.6.3	TEST PROCEDURE.....	73
4.6.4	DEVIATION FROM TEST STANDARD.....	74
4.6.5	TEST SETUP.....	74
4.6.6	EUT OPERATING CONDITION.....	74
4.6.7	TEST RESULTS	75
4.7	BAND EDGES MEASUREMENT	76
4.7.1	TEST INSTRUMENTS.....	76
4.7.2	TEST PROCEDURE.....	77
4.7.3	EUT OPERATING CONDITION.....	77
4.7.4	TEST RESULTS	78
5.	PHOTOGRAPHS OF THE TEST CONFIGURATION.....	102
6.	INFORMATION ON THE TESTING LABORATORIES	103
7.	APPENDIX A - MODIFICATIONS RECORDERS FOR ENGINEERING CHANGES TO THE EUT BY THE LAB.....	104



A D T

1. CERTIFICATION

PRODUCT: N600 Wireless Dual Band Gigabit Router
(refer to item 3.1 for more detail)

MODEL NO.: WNDR3700v2 (refer to item 3.1 for more detail)

BRAND: NETGEAR

APPLICANT: NETGEAR, INC.

TEST SAMPLE: ENGINEERING SAMPLE

TESTED: Sep. 03 ~ Sep. 13, 2010

STANDARDS: FCC Part 15, Subpart E (Section 15.407)
ANSI C63.4-2003

The above equipment (Model: WNDR3700v2) has been tested by **Bureau Veritas Consumer Products Services (H.K.) Ltd., Taoyuan Branch**, and found compliance with the requirement of the above standards. The test record, data evaluation & Equipment Under Test (EUT) configurations represented herein are true and accurate accounts of the measurements of the sample's EMC characteristics under the conditions specified in this report.

PREPARED BY : Andrea Hsia , **DATE:** Nov. 11, 2010
Andrea Hsia / Specialist

TECHNICAL ACCEPTANCE : Long Chen , **DATE:** Nov. 11, 2010
Responsible for RF Long Chen / Senior Engineer

APPROVED BY : Gary Chang , **DATE:** Nov. 11, 2010
Gary Chang / Assistant Manager



2. SUMMARY OF TEST RESULTS

The EUT has been tested according to the following specifications:

APPLIED STANDARD: FCC PART 15, SUBPART E (SECTION 15.407)			
STANDARD SECTION	TEST TYPE AND LIMIT	RESULT	REMARK
15.407(b)(5)	AC Power Conducted Emission	PASS	Meet the requirement of limit. Minimum passing margin is -5.35dB at 0.158MHz.
15.407(b/1/2/3) (b)(5)	Electric Field Strength Spurious Emissions, 30MHz ~ 40000MHz	PASS	Meet the requirement of limit. Minimum passing margin is -1.0dB at 5350, 5470.00 & 5725.00MHz.
15.407(a/1/2/3)	Peak Transmit Power	PASS	Meet the requirement of limit.
15.407(a)(6)	Peak Power Excursion	PASS	Meet the requirement of limit.
15.407(a/1/2/3)	Peak Power Spectral Density	PASS	Meet the requirement of limit.
15.407(g)	Frequency Stability	PASS	Meet the requirement of limit.
15.203	Antenna Requirement	PASS	No antenna connector is used.

2.1 MEASUREMENT UNCERTAINTY

Where relevant, the following measurement uncertainty levels have been estimated for tests performed on the EUT as specified in CISPR 16-4-2:

MEASUREMENT	FREQUENCY	UNCERTAINTY
Conducted emissions	9kHz~30MHz	2.44 dB
Radiated emissions	30MHz ~ 200MHz	4.12 dB
	200MHz ~1000MHz	4.12 dB
	1GHz ~ 18GHz	2.26 dB
	18GHz ~ 40GHz	1.94 dB

This uncertainty represents an expanded uncertainty expressed at approximately the 95% confidence level using a coverage factor of $k = 2$.



A D T

3. GENERAL INFORMATION

3.1 GENERAL DESCRIPTION OF EUT

PRODUCT	N600 Wireless Dual Band Gigabit Router (refer to note as below)
MODEL NO.	WNDR3700v2 (refer to note as below)
FCC ID	PY308300092
NOMINAL VOLTAGE	12Vdc
MODULATION TYPE	64QAM, 16QAM, QPSK, BPSK for OFDM
MODULATION TECHNOLOGY	OFDM
TRANSFER RATE	802.11a: 54.0/ 48.0/ 36.0/ 24.0/ 18.0/ 12.0/ 9.0/ 6.0Mbps 802.11n: up to 300.0Mbps
OPERATING FREQUENCY	5260 ~ 5320MHz & 5500 ~ 5700MHz
NUMBER OF CHANNEL	5260 ~ 5320MHz: 4 for 802.11a, 802.11n (20MHz) 2 for 802.11n (40MHz) 5500 ~ 5700MHz: 7 for 802.11a, 802.11n (20MHz) 3 for 802.11n (40MHz)
OUTPUT POWER	182.5mW for 5260 ~ 5320MHz 164.5mW for 5500 ~ 5700MHz
ANTENNA TYPE	Refer to Note as below
ANTENNA CONNECTER	NA
I/O PORTS	USB, RJ45
DATA CABLE	1.5m shielded RJ45 cable without core
ACCESSORY DEVICES	Adapter

NOTE:

1. This report is issued as a supplementary report of BV ADT report no.: RF980618L05A. This report is prepared for class II permissive change. The difference compared with the original report is adding frequency band from 5.26 to 5.32GHz and 5.50 to 5.70GHz by software. Therefore, for 5.26 to 5.32GHz and 5.50 to 5.70GHz band were tested and presented in the report.
2. The EUT is an N600 Wireless Dual Band Gigabit Router. The test data are separated into following test reports.

	TEST STANDARD	REFERENCE REPORT
WLAN 802.11a, 802.11n (5260~5320MHz & 5500 ~5700MHz)	FCC Part 15, Subpart E (Section 15.407)	RF980618L05D
WLAN 802.11a, 802.11n (For DFS report) (5260~5320MHz & 5500~5700MHz)		RF980618L05D-1

3. The frequency bands used in this EUT are listed as follows:

Frequency Band (MHz)	5500~5700	5745~5825
802.11a	√	√
802.11n (20MHz)	√	√
802.11n (40MHz)	√	√



A D T

4. All models are listed as below, different brand names and model names are for marketing purpose

BRAND	MODEL	PRODUCT NAME	REMARK
NETGEAR	WNDR3700v2	N600 Wireless Dual Band Gigabit Router	Black
NETGEAR	WNDRMAC	Wireless Extreme	White (but overlay is different)
NETGEAR	WNDR3800	N600 Wireless Dual Band Gigabit Router - Premium Edition	Black

5. The EUT incorporates a MIMO function. Physically, the EUT provides two completed transmitters and two receivers.

MODULATION MODE	TX FUNCTION
802.11a	2TX
802.11n (20MHz)	2TX
802.11n (40MHz)	2TX

6. The EUT were powered by the following adapter:

ADAPTER 1	
BRAND:	NETGEAR
MODEL:	P030WF120B
P/N:	332-10100-01
INPUT:	100-240Vac, 1.0A, 50/60Hz
OUTPUT:	12Vdc, 2.5A
POWER LINE:	DC 1.8m non-shielded cable without core

ADAPTER 2	
BRAND:	NETGEAR
MODEL:	MU30-5120250-A1
P/N:	332-10100-01
INPUT:	100-240Vac, 0.8A, 50/60Hz
OUTPUT:	12Vdc, 2.5A
POWER LINE:	DC 1.8m non-shielded cable without core



A D T

7. The following antennas are used in this EUT.

Frequency	Type	Gain (dBi)	
		Top antenna	Side antenna
5.0GHz			
5260		2.6	3.1
5280		2.9	3.5
5300		3.0	3.5
5320		3.0	3.5
5500		3.4	3.5
5520		3.5	3.6
5540		3.4	3.4
5560		3.5	3.4
5580		3.5	3.6
5600		3.6	3.6
5620		3.8	3.5
5640		3.8	3.4
5660		3.8	3.2
5680		3.7	2.9
5700		3.9	2.8
5745		3.6	2.5
5765		3.5	2.4
5785		3.4	2.4
5805		3.1	2.5

8. The above EUT information was declared by manufacturer and for more detailed features description, please refer to the manufacturer's specifications or user's manual.

3.2 DESCRIPTION OF TEST MODES

Operated in 5260 ~ 5320MHz

4 channels are provided for 802.11a, 802.11n (20MHz):

CHANNEL	FREQUENCY	CHANNEL	FREQUENCY
52	5260 MHz	60	5300 MHz
56	5280 MHz	64	5320 MHz

2 channels are provided for 802.11n (40MHz):

CHANNEL	FREQUENCY	CHANNEL	FREQUENCY
54	5270 MHz	62	5310 MHz

Operated in 5500 ~ 5700MHz

7 channels are provided for 802.11a, 802.11n (20MHz):

CHANNEL	FREQUENCY	CHANNEL	FREQUENCY
100	5500 MHz	116	5580 MHz
104	5520 MHz	136	5680 MHz
108	5540 MHz	140	5700 MHz
112	5560 MHz		

2 channels are provided for 802.11n (40MHz):

CHANNEL	FREQUENCY	CHANNEL	FREQUENCY
102	5510 MHz	110	5550 MHz

3.2.1 CONFIGURATION OF SYSTEM UNDER TEST

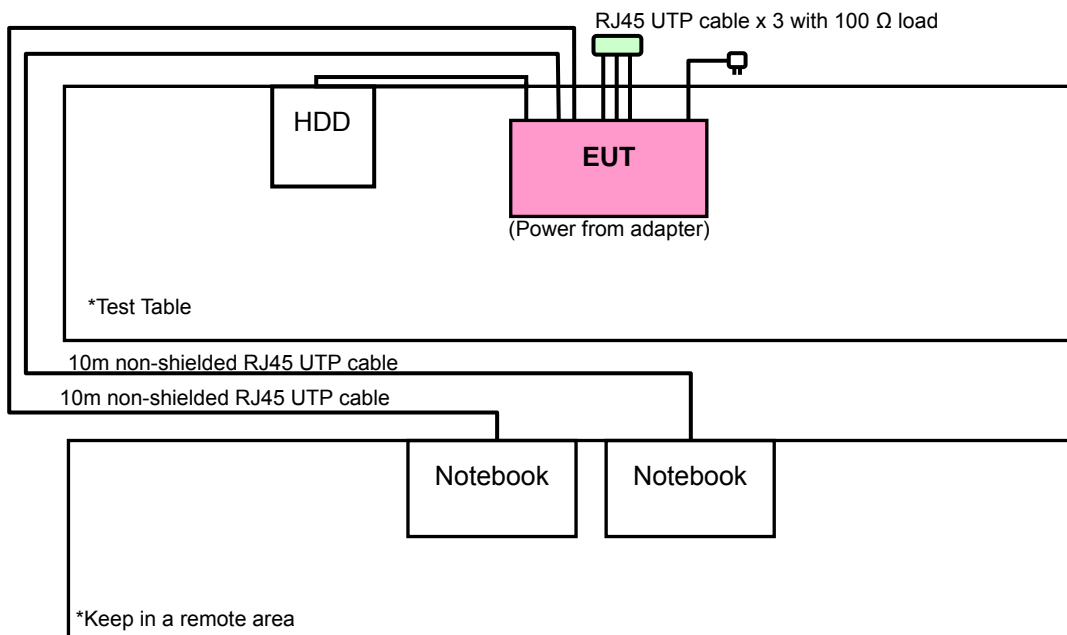



A D T

3.2.2 TEST MODE APPLICABILITY AND TESTED CHANNEL DETAIL

EUT CONFIGURE MODE	APPLICABLE TO				DESCRIPTION
	RE \geq 1G	RE<1G	PLC	APCM	
A	-	√	√	-	Power from AC Adapter 1
B	√	√	√	√	Power from AC Adapter 2

Where **RE \geq 1G**: Radiated Emission above 1GHz **RE<1G**: Radiated Emission below 1GHz
PLC: Power Line Conducted Emission **APCM**: Antenna Port Conducted Measurement

NOTE: "-" means no effect.

RADIATED EMISSION TEST (ABOVE 1GHz):

- Pre-Scan has been conducted to determine the worst-case mode from all possible combinations between available modulations, data rates, XYZ axis and antenna ports (if EUT with antenna diversity architecture).
- Following channel(s) was (were) selected for the final test as listed below.

EUT CONFIGURE MODE	MODE	FREQ. BAND (MHz)	AVAILABLE CHANNEL	TESTED CHANNEL	MODULATION TECHNOLOGY	MODULATION TYPE	DATA RATE (Mbps)	AXIS
B	802.11a	5260-5320	52 to 64	52, 60, 64	OFDM	BPSK	6.0	Z
B	802.11n (20MHz)		52 to 64	52, 60, 64	OFDM	BPSK	7.2	Z
B	802.11n (40MHz)		54 to 62	54, 62	OFDM	BPSK	15.0	Z
B	802.11a	5500-5700	100 to 140	100, 116, 136, 140	OFDM	BPSK	6.0	Z
B	802.11n (20MHz)		100 to 140	100, 116, 136, 140	OFDM	BPSK	7.2	Z
B	802.11n (40MHz)		102 to 110	102, 110	OFDM	BPSK	15.0	Z

RADIATED EMISSION TEST (BELOW 1GHz):

- Pre-Scan has been conducted to determine the worst-case mode from all possible combinations between available modulations, data rates, XYZ axis and antenna ports (if EUT with antenna diversity architecture).
- Following channel(s) was (were) selected for the final test as listed below.

EUT CONFIGURE MODE	MODE	FREQ. BAND (MHz)	AVAILABLE CHANNEL	TESTED CHANNEL	MODULATION TECHNOLOGY	MODULATION TYPE	DATA RATE (Mbps)	AXIS
A, B	802.11a	5260-5320	52 to 64	52	OFDM	BPSK	6.0	Z
A, B	802.11a	5500-5700	100 to 140	100	OFDM	BPSK	6.0	Z



A D T

POWER LINE CONDUCTED EMISSION TEST:

- Pre-Scan has been conducted to determine the worst-case mode from all possible combinations between available modulations, data rates and antenna ports (if EUT with antenna diversity architecture).
- Following channel(s) was (were) selected for the final test as listed below.

EUT CONFIGURE MODE	MODE	FREQ. BAND (MHz)	AVAILABLE CHANNEL	TESTED CHANNEL	MODULATION TECHNOLOGY	MODULATION TYPE	DATA RATE (Mbps)	AXIS
A, B	802.11a	5260-5320	52 to 64	52	OFDM	BPSK	6.0	Z
A, B	802.11a	5500-5700	100 to 140	100	OFDM	BPSK	6.0	Z

BANDEDGE MEASUREMENT:

- Pre-Scan has been conducted to determine the worst-case mode from all possible combinations between available modulations, data rates and antenna ports (if EUT with antenna diversity architecture).
- Following channel(s) was (were) selected for the final test as listed below.

EUT CONFIGURE MODE	MODE	FREQ. BAND (MHz)	AVAILABLE CHANNEL	TESTED CHANNEL	MODULATION TECHNOLOGY	MODULATION TYPE	DATA RATE (Mbps)
B	802.11a	5260-5320	52 to 64	52, 64	OFDM	BPSK	6.0
B	802.11n (20MHz)		52 to 64	52, 64	OFDM	BPSK	7.2
B	802.11n (40MHz)		54 to 62	54, 62	OFDM	BPSK	15.0
B	802.11a	5500-5700	100 to 140	100, 140	OFDM	BPSK	6.0
B	802.11n (20MHz)		100 to 140	100, 140	OFDM	BPSK	7.2
B	802.11n (40MHz)		102 to 110	102, 110	OFDM	BPSK	15.0



ANTENNA PORT CONDUCTED MEASUREMENT:

- This item includes all test value of each mode, but only includes spectrum plot of worst value of each mode.
- Pre-Scan has been conducted to determine the worst-case mode from all possible combinations between available modulations, data rates and antenna ports (if EUT with antenna diversity architecture).
- Following channel(s) was (were) selected for the final test as listed below.

EUT CONFIGURE MODE	MODE	FREQ. BAND (MHz)	AVAILABLE CHANNEL	TESTED CHANNEL	MODULATION TECHNOLOGY	MODULATION TYPE	DATA RATE (Mbps)	AXIS
B	802.11a	5260-5320	52 to 64	52, 60, 64	OFDM	BPSK	6.0	Z
B	802.11n (20MHz)		52 to 64	52, 60, 64	OFDM	BPSK	7.2	Z
B	802.11n (40MHz)		54 to 62	54, 62	OFDM	BPSK	15.0	Z
B	802.11a	5500-5700	100 to 140	100, 116, 136, 140	OFDM	BPSK	6.0	Z
B	802.11n (20MHz)		100 to 140	100, 116, 136, 140	OFDM	BPSK	7.2	Z
B	802.11n (40MHz)		102 to 134	102, 110	OFDM	BPSK	15.0	Z

TEST CONDITION:

APPLICABLE TO	ENVIRONMENTAL CONDITIONS	INPUT POWER	TESTED BY
RE≥1G	26deg. C, 64%RH, 1020 hPa 25deg. C, 65%RH, 1008 hPa	120Vac, 60Hz	Antony Lee, Match Tsui
RE<1G	23deg. C, 71%RH, 1008 hPa	120Vac, 60Hz	Jacky Lee
PLC	20deg. C, 60%RH, 1020 hPa	120Vac, 60Hz	Match Tsui
APCM	26deg. C, 64%RH, 1020 hPa	120Vac, 60Hz	Antony Lee



A D T

3.3 GENERAL DESCRIPTION OF APPLIED STANDARDS

The EUT is a RF Product. According to the specifications of the manufacturer, it must comply with the requirements of the following standards:

FCC Part 15, Subpart E (15.407)

ANSI C63.4-2003

All test items have been performed and recorded as per the above standards.

3.4 DESCRIPTION OF SUPPORT UNITS

The EUT has been tested as an independent unit together with other necessary accessories or support units. The following support units or accessories were used to form a representative test configuration during the tests.

NO.	PRODUCT	BRAND	MODEL NO.	SERIAL NO.	FCC ID
1	EXTERNAL HARD DISK	DELL	RD1000	HK-0XM763-72953-77P-000F	NA
2	NOTEBOOK	DELL	PP05L	12130898320	E2K24CLNS
3	NOTEBOOK	DELL	PP05L	25191592336	E2K24CLNS

NO.	SIGNAL CABLE DESCRIPTION OF THE ABOVE SUPPORT UNITS
1	2 m shielded cable, terminated with USB connector, with core.
2	10m non-shielded RJ45 UTP cable
3	10m non-shielded RJ45 UTP cable

NOTE: 1. All power cords of the above support units are non shielded (1.8m).
2. Item 2 ~ 3 acted as communication partners to transfer data.



4. TEST TYPES AND RESULTS

4.1 RADIATED EMISSION MEASUREMENT

4.1.1 LIMITS OF RADIATED EMISSION MEASUREMENT

Emissions radiated outside of the specified bands, shall be according to the general radiated limits in 15.209 as following:

FREQUENCIES (MHz)	FIELD STRENGTH (microvolts/meter)	MEASUREMENT DISTANCE (meters)
0.009 ~ 0.490	2400/F(kHz)	300
0.490 ~ 1.705	24000/F(kHz)	30
1.705 ~ 30.0	30	30
30 ~ 88	100	3
88 ~ 216	150	3
216 ~ 960	200	3
Above 960	500	3

NOTE:

1. The lower limit shall apply at the transition frequencies.
2. Emission level (dBuV/m) = 20 log Emission level (uV/m).
3. As shown in 15.35(b), for frequencies above 1000MHz, the field strength limits are based on average detector, however, the peak field strength of any emission shall not exceed the maximum permitted average limits, specified above by more than 20dB under any condition of modulation.

4.1.2 LIMITS OF UNWANTED EMISSION OUT OF THE RESTRICTED BANDS

FREQUENCIES (MHz)	EIRP LIMIT (dBm)	EQUIVALENT FIELD STRENGTH AT 3m (dBµV/m) *NOTE 3
	PK	PK
5250 ~ 5350	-27	68.3
5470 ~ 5725	-27	68.3

NOTE: The following formula is used to convert the equipment isotropic radiated power (eirp) to field strength:

$$E = \frac{1000000\sqrt{30P}}{3} \mu\text{V/m, where P is the eirp (Watts).}$$



A D T

4.1.3 TEST INSTRUMENTS

Above 1GHz Test:

DESCRIPTION & MANUFACTURER	MODEL NO.	SERIAL NO.	DATE OF CALIBRATION	DUE DATE OF CALIBRATION
Test Receiver ROHDE & SCHWARZ	ESI7	838496/016	Dec. 29, 2009	Dec. 28, 2010
Spectrum Analyzer ROHDE & SCHWARZ	FSP40	100039	Jan. 11, 2010	Jan. 10, 2011
BILOG Antenna SCHWARZBECK	VULB9168	9168-155	Apr. 28, 2010	Apr. 27, 2011
HORN Antenna SCHWARZBECK	BBHA 9120D	9120D-408	Jan. 05, 2010	Jan. 04, 2011
HORN Antenna SCHWARZBECK	BBHA 9170	BBHA9170242	Dec. 25, 2009	Dec. 24, 2010
Preamplifier Agilent	8449B	3008A01961	Nov. 04, 2009	Nov. 03, 2010
Preamplifier Agilent	8447D	2944A10738	Nov. 04, 2009	Nov. 03, 2010
RF signal cable HUBER+SUHNNER	SUCOFLEX 104	274041/4	Aug. 21, 2010	Aug. 20, 2011
RF signal cable HUBER+SUHNNER	SUCOFLEX 104	283397/4	Aug. 21, 2010	Aug. 20, 2011
Software ADT.	ADT_Radiated_ V7.6.15.9.2	NA	NA	NA
Antenna Tower inn-co GmbH	MA 4000	010303	NA	NA
Antenna Tower Controller inn-co GmbH	CO2000	019303	NA	NA
Turn Table ADT.	TT100.	TT93021704	NA	NA
Turn Table Controller ADT.	SC100.	SC93021704	NA	NA
26GHz ~ 40GHz Amplifier	EM26400	07026401	Aug. 25, 2010	Aug. 24, 2011

- NOTE:**
1. The calibration interval of the above test instruments is 12 months and the calibrations are traceable to NML/ROC and NIST/USA.
 2. The test was performed in HwaYa Chamber 4.
 3. The horn antenna and HP preamplifier (model: 8449B) are used only for the measurement of emission frequency above 1GHz if tested.
 4. The FCC Site Registration No. is 988962.
 5. The IC Site Registration No. is IC7450F-4.



A D T

Below 1GHz Test:

DESCRIPTION & MANUFACTURER	MODEL NO.	SERIAL NO.	DATE OF CALIBRATION	DUE DATE OF CALIBRATION
Test Receiver ROHDE & SCHWARZ	ESIB7	100186	Dec. 11, 2009	Dec. 10, 2010
Test Receiver ROHDE & SCHWARZ	ESIB7	100187	Sep. 18, 2009	Sep. 17, 2010
Spectrum Analyzer ROHDE & SCHWARZ	FSP40	100269	Dec. 31, 2009	Dec. 30, 2010
BILOG Antenna SCHWARZBECK	VULB9168	9168-148	Apr. 27, 2010	Apr. 26, 2011
BILOG Antenna SCHWARZBECK	VULB9168	9168-149	Apr. 27, 2010	Apr. 26, 2011
HORN Antenna EMCO	3115	5623	Jul. 13, 2010	Jul. 12, 2011
Preamplifier Agilent	8447D	2944A10636	Dec. 10, 2009	Dec. 09, 2010
Preamplifier Agilent	8447D	2944A10637	Dec. 10, 2009	Dec. 09, 2010
Preamplifier Agilent	8449B	3008A01959	Dec. 10, 2009	Dec. 09, 2010
RF signal cable Woken	8D-FB	Cable-Hych1-01	Oct. 24, 2009	Oct. 23, 2010
RF signal cable Woken	8D-FB	Cable-Hych1-02	Oct. 24, 2009	Oct. 23, 2010
Software ADT	ADT_Radiated_ V 7.7.03.6	NA	NA	NA
Antenna Tower(V)	MFA-440	9707	NA	NA
Antenna Tower(H)	MFA-440	970705	NA	NA
Turn Table	DS430	50303	NA	NA
Controller	MF7802	074	NA	NA
Controller	MF7802	08093	NA	NA
RF signal cable EAST COST Microwave	HP 160S-29	NA	Feb. 12, 2010	Feb. 11, 2011

- NOTE:**
1. The calibration interval of the above test instruments is 12 months and the calibrations are traceable to NML/ROC and NIST/USA.
 2. The test was performed in HwaYa Chamber 1.
 3. The FCC Site Registration No. is 477732.
 4. The IC Site Registration No. is IC 7450F-1.
 5. The VCCI Site Registration No. is R-1893, G-113.



4.1.4 TEST PROCEDURES

- a. The EUT was placed on the top of a rotating table 0.8 meters above the ground at a 3 & 10 meter semi-anechoic chamber. The table was rotated 360 degrees to determine the position of the highest radiation.
- b. The EUT was set 3 meters away from the interference-receiving antenna, which was mounted on the top of a variable-height antenna tower.
- c. The antenna is a broadband antenna, and its height is varied from one meter to four meters above the ground to determine the maximum value of the field strength. Both horizontal and vertical polarizations of the antenna are set to make the measurement.
- d. For each suspected emission, the EUT was arranged to its worst case and then the antenna was tuned to heights from 1 meter to 4 meters and the rotatable table was turned from 0 degrees to 360 degrees to find the maximum reading.
- e. The test-receiver system was set to Peak Detect Function and Specified Bandwidth with Maximum Hold Mode.
- f. If the emission level of the EUT in peak mode was 10dB lower than the limit specified, then testing could be stopped and the peak values of the EUT would be reported. Otherwise the emissions that did not have 10dB margin would be re-tested one by one using peak, quasi-peak or average method as specified and then reported in a data sheet.

NOTE:

1. The resolution bandwidth and video bandwidth of test receiver/spectrum analyzer is 120kHz for Peak detection (PK) and Quasi-peak detection (QP) at frequency below 1GHz.
2. The resolution bandwidth of test receiver/spectrum analyzer is 1MHz and video bandwidth is 3MHz for Peak detection at frequency above 1GHz.
3. The resolution bandwidth of test receiver/spectrum analyzer is 1MHz and the video bandwidth is 10Hz for Average detection (AV) at frequency above 1GHz.
4. All modes of operation were investigated and the worst-case emissions are reported.

4.1.5 DEVIATION FROM TEST STANDARD

No deviation

4.1.6 TEST SETUP

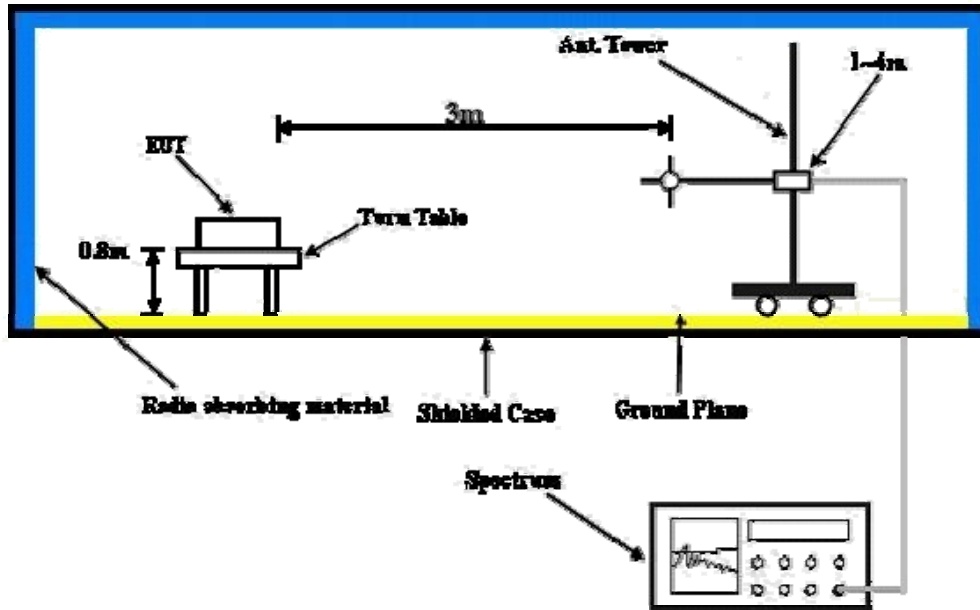

For the actual test configuration, please refer to the attached file (Test Setup Photo).

4.1.7 EUT OPERATING CONDITION

- a. Placed the EUT on the testing table.
- b. Prepared notebook system outside of testing area to act as a communication partners.
- c. The communication partner connected with EUT via a RJ45 UTP cable and run a test program (provided by manufacturer) to enable EUT under transmission condition continuously at specific channel frequency.
- d. The communication partner sent data to EUT by command "PING".



A D T

4.1.8 TEST RESULTS

802.11a

EUT TEST CONDITION		MEASUREMENT DETAIL	
CHANNEL	Channel 52	FREQUENCY RANGE	1 ~ 40GHz
INPUT POWER (SYSTEM)	120Vac, 60 Hz	DETECTOR FUNCTION	Peak (PK) Average (AV)
ENVIRONMENTAL CONDITIONS	25deg. C, 65%RH 1008 hPa	TESTED BY	Match Tsui

ANTENNA POLARITY & TEST DISTANCE: HORIZONTAL AT 3 M								
NO.	FREQ. (MHz)	EMISSION LEVEL (dBuV/m)	LIMIT (dBuV/m)	MARGIN (dB)	ANTENNA HEIGHT (m)	TABLE ANGLE (Degree)	RAW VALUE (dBuV)	CORRECTION FACTOR (dB/m)
1	5150.00	54.7 PK	74.0	-19.3	1.00 H	291	14.00	40.70
2	5150.00	43.6 AV	54.0	-10.4	1.00 H	291	2.90	40.70
3	*5260.00	116.6 PK			1.46 H	273	75.80	40.80
4	*5260.00	103.0 AV			1.46 H	273	62.20	40.80
5	#10520.00	63.9 PK	68.3	-4.4	1.00 H	22	11.80	52.10
6	15780.00	63.5 PK	74.0	-10.5	1.00 H	261	11.00	52.50
7	15780.00	49.6 AV	54.0	-4.4	1.00 H	261	-2.90	52.50
ANTENNA POLARITY & TEST DISTANCE: VERTICAL AT 3 M								
NO.	FREQ. (MHz)	EMISSION LEVEL (dBuV/m)	LIMIT (dBuV/m)	MARGIN (dB)	ANTENNA HEIGHT (m)	TABLE ANGLE (Degree)	RAW VALUE (dBuV)	CORRECTION FACTOR (dB/m)
1	5150.00	61.4 PK	74.0	-12.6	1.00 V	294	20.70	40.70
2	5150.00	48.0 AV	54.0	-6.0	1.00 V	294	7.30	40.70
3	*5260.00	119.2 PK			1.00 V	305	78.40	40.80
4	*5260.00	106.4 AV			1.00 V	305	65.60	40.80
5	#10520.00	66.1 PK	68.3	-2.2	1.00 V	125	14.00	52.10
6	15780.00	64.0 PK	74.0	-10.0	1.00 V	250	11.50	52.50
7	15780.00	50.5 AV	54.0	-3.5	1.00 V	250	-2.00	52.50

- REMARKS:**
1. Emission level (dBuV/m) = Raw Value (dBuV) + Correction Factor (dB/m).
 2. Correction Factor (dB/m) = Antenna Factor (dB/m) + Cable Factor (dB).
 3. The other emission levels were very low against the limit.
 4. Margin value = Emission level – Limit value.
 5. “ * “: Fundamental frequency.
 6. “#”:The radiated frequency is out the restricted band.



A D T

EUT TEST CONDITION		MEASUREMENT DETAIL	
CHANNEL	Channel 60	FREQUENCY RANGE	1 ~ 40GHz
INPUT POWER (SYSTEM)	120Vac, 60 Hz	DETECTOR FUNCTION	Peak (PK) Average (AV)
ENVIRONMENTAL CONDITIONS	25deg. C, 65%RH 1008 hPa	TESTED BY	Match Tsui

ANTENNA POLARITY & TEST DISTANCE: HORIZONTAL AT 3 M								
NO.	FREQ. (MHz)	EMISSION LEVEL (dBuV/m)	LIMIT (dBuV/m)	MARGIN (dB)	ANTENNA HEIGHT (m)	TABLE ANGLE (Degree)	RAW VALUE (dBuV)	CORRECTION FACTOR (dB/m)
1	*5300.00	115.6 PK			1.22 H	296	74.80	40.80
2	*5300.00	102.8 AV			1.22 H	296	62.00	40.80
3	10600.00	64.1 PK	74.0	-9.9	1.00 H	94	11.90	52.20
4	10600.00	49.7 AV	54.0	-4.3	1.00 H	94	-2.50	52.20
ANTENNA POLARITY & TEST DISTANCE: VERTICAL AT 3 M								
NO.	FREQ. (MHz)	EMISSION LEVEL (dBuV/m)	LIMIT (dBuV/m)	MARGIN (dB)	ANTENNA HEIGHT (m)	TABLE ANGLE (Degree)	RAW VALUE (dBuV)	CORRECTION FACTOR (dB/m)
1	*5300.00	118.8 PK			1.00 V	310	78.00	40.80
2	*5300.00	105.7 AV			1.00 V	310	64.90	40.80
3	10600.00	65.4 PK	74.0	-8.6	1.00 V	141	13.20	52.20
4	10600.00	51.7 AV	54.0	-2.3	1.00 V	141	-0.50	52.20

- REMARKS:**
1. Emission level (dBuV/m) = Raw Value (dBuV) + Correction Factor (dB/m).
 2. Correction Factor (dB/m) = Antenna Factor (dB/m) + Cable Factor (dB).
 3. The other emission levels were very low against the limit.
 4. Margin value = Emission level – Limit value.
 5. “ * “: Fundamental frequency.



A D T

EUT TEST CONDITION		MEASUREMENT DETAIL	
CHANNEL	Channel 64	FREQUENCY RANGE	1 ~ 40GHz
INPUT POWER (SYSTEM)	120Vac, 60 Hz	DETECTOR FUNCTION	Peak (PK) Average (AV)
ENVIRONMENTAL CONDITIONS	25deg. C, 65%RH 1008 hPa	TESTED BY	Match Tsui

ANTENNA POLARITY & TEST DISTANCE: HORIZONTAL AT 3 M								
NO.	FREQ. (MHz)	EMISSION LEVEL (dBuV/m)	LIMIT (dBuV/m)	MARGIN (dB)	ANTENNA HEIGHT (m)	TABLE ANGLE (Degree)	RAW VALUE (dBuV)	CORRECTION FACTOR (dB/m)
1	*5320.00	116.1 PK			1.23 H	295	75.20	40.90
2	*5320.00	103.7 AV			1.23 H	295	62.80	40.90
3	5350.00	70.1 PK	74.0	-3.9	1.23 H	295	29.20	40.90
4	5350.00	51.3 AV	54.0	-2.7	1.23 H	295	10.40	40.90
5	10640.00	64.0 PK	74.0	-10.0	1.00 H	125	11.70	52.30
6	10640.00	50.3 AV	54.0	-3.7	1.00 H	125	-2.00	52.30
ANTENNA POLARITY & TEST DISTANCE: VERTICAL AT 3 M								
NO.	FREQ. (MHz)	EMISSION LEVEL (dBuV/m)	LIMIT (dBuV/m)	MARGIN (dB)	ANTENNA HEIGHT (m)	TABLE ANGLE (Degree)	RAW VALUE (dBuV)	CORRECTION FACTOR (dB/m)
1	*5320.00	119.7 PK			1.00 V	308	78.80	40.90
2	*5320.00	107.1 AV			1.00 V	308	66.20	40.90
3	5350.00	72.1 PK	74.0	-1.9	1.00 V	308	31.20	40.90
4	5350.00	52.2 AV	54.0	-1.8	1.00 V	308	11.30	40.90
5	10640.00	64.4 PK	74.0	-9.6	1.00 V	166	12.10	52.30
6	10640.00	50.4 AV	54.0	-3.6	1.00 V	166	-1.90	52.30

- REMARKS:**
1. Emission level (dBuV/m) = Raw Value (dBuV) + Correction Factor (dB/m).
 2. Correction Factor (dB/m) = Antenna Factor (dB/m) + Cable Factor (dB).
 3. The other emission levels were very low against the limit.
 4. Margin value = Emission level – Limit value.
 5. “ * “: Fundamental frequency.



A D T

EUT TEST CONDITION		MEASUREMENT DETAIL	
CHANNEL	Channel 100	FREQUENCY RANGE	1 ~ 40GHz
INPUT POWER (SYSTEM)	120Vac, 60 Hz	DETECTOR FUNCTION	Peak (PK) Average (AV)
ENVIRONMENTAL CONDITIONS	25deg. C, 65%RH 1008 hPa	TESTED BY	Match Tsui

ANTENNA POLARITY & TEST DISTANCE: HORIZONTAL AT 3 M								
NO.	FREQ. (MHz)	EMISSION LEVEL (dBuV/m)	LIMIT (dBuV/m)	MARGIN (dB)	ANTENNA HEIGHT (m)	TABLE ANGLE (Degree)	RAW VALUE (dBuV)	CORRECTION FACTOR (dB/m)
1	5460.00	59.7 PK	74.0	-14.3	1.05 H	135	18.60	41.10
2	5460.00	46.7 AV	54.0	-7.3	1.05 H	135	5.60	41.10
3	#5470.00	67.1 PK	68.3	-1.2	1.05 H	135	26.00	41.10
4	*5500.00	115.4 PK			1.07 H	146	74.30	41.10
5	*5500.00	103.9 AV			1.07 H	146	62.80	41.10
6	#16500.00	66.9 PK	68.3	-1.4	1.20 H	117	13.40	53.50
ANTENNA POLARITY & TEST DISTANCE: VERTICAL AT 3 M								
NO.	FREQ. (MHz)	EMISSION LEVEL (dBuV/m)	LIMIT (dBuV/m)	MARGIN (dB)	ANTENNA HEIGHT (m)	TABLE ANGLE (Degree)	RAW VALUE (dBuV)	CORRECTION FACTOR (dB/m)
1	5460.00	59.8 PK	74.0	-14.2	1.00 V	106	18.70	41.10
2	5460.00	47.5 AV	54.0	-6.5	1.00 V	106	6.40	41.10
3	#5470.00	67.3 PK	68.3	-1.0	1.00 V	117	26.20	41.10
4	*5500.00	117.1 PK			1.00 V	107	76.00	41.10
5	*5500.00	105.0 AV			1.00 V	107	63.90	41.10
6	#16500.00	65.4 PK	68.3	-2.9	1.02 V	36	11.90	53.50

- REMARKS:**
1. Emission level (dBuV/m) = Raw Value (dBuV) + Correction Factor (dB/m).
 2. Correction Factor (dB/m) = Antenna Factor (dB/m) + Cable Factor (dB).
 3. The other emission levels were very low against the limit.
 4. Margin value = Emission level – Limit value.
 5. “ * “: Fundamental frequency.
 6. “#”:The radiated frequency is out the restricted band.



A D T

EUT TEST CONDITION		MEASUREMENT DETAIL	
CHANNEL	Channel 116	FREQUENCY RANGE	1 ~ 40GHz
INPUT POWER (SYSTEM)	120Vac, 60 Hz	DETECTOR FUNCTION	Peak (PK) Average (AV)
ENVIRONMENTAL CONDITIONS	25deg. C, 65%RH 1008 hPa	TESTED BY	Match Tsui

ANTENNA POLARITY & TEST DISTANCE: HORIZONTAL AT 3 M								
NO.	FREQ. (MHz)	EMISSION LEVEL (dBuV/m)	LIMIT (dBuV/m)	MARGIN (dB)	ANTENNA HEIGHT (m)	TABLE ANGLE (Degree)	RAW VALUE (dBuV)	CORRECTION FACTOR (dB/m)
1	*5580.00	113.8 PK			1.01 H	126	72.50	41.30
2	*5580.00	101.6 AV			1.01 H	126	60.30	41.30
3	#16740.00	65.6 PK	68.3	-2.7	1.09 H	82	11.10	54.50
ANTENNA POLARITY & TEST DISTANCE: VERTICAL AT 3 M								
NO.	FREQ. (MHz)	EMISSION LEVEL (dBuV/m)	LIMIT (dBuV/m)	MARGIN (dB)	ANTENNA HEIGHT (m)	TABLE ANGLE (Degree)	RAW VALUE (dBuV)	CORRECTION FACTOR (dB/m)
1	*5580.00	115.9 PK			1.05 V	100	74.60	41.30
2	*5580.00	103.6 AV			1.05 V	100	62.30	41.30
3	#16740.00	65.3 PK	68.3	-3.0	1.40 V	249	10.80	54.50

- REMARKS:**
1. Emission level (dBuV/m) = Raw Value (dBuV) + Correction Factor (dB/m).
 2. Correction Factor (dB/m) = Antenna Factor (dB/m) + Cable Factor (dB).
 3. The other emission levels were very low against the limit.
 4. Margin value = Emission level – Limit value.
 5. “ * “: Fundamental frequency.
 6. “#”:The radiated frequency is out the restricted band.



A D T

EUT TEST CONDITION		MEASUREMENT DETAIL	
CHANNEL	Channel 136	FREQUENCY RANGE	1 ~ 40GHz
INPUT POWER (SYSTEM)	120Vac, 60 Hz	DETECTOR FUNCTION	Peak (PK) Average (AV)
ENVIRONMENTAL CONDITIONS	25deg. C, 65%RH 1008 hPa	TESTED BY	Match Tsui

ANTENNA POLARITY & TEST DISTANCE: HORIZONTAL AT 3 M								
NO.	FREQ. (MHz)	EMISSION LEVEL (dBuV/m)	LIMIT (dBuV/m)	MARGIN (dB)	ANTENNA HEIGHT (m)	TABLE ANGLE (Degree)	RAW VALUE (dBuV)	CORRECTION FACTOR (dB/m)
1	*5680.00	114.0 PK			1.06 H	149	72.50	41.50
2	*5680.00	100.7 AV			1.06 H	149	59.20	41.50
3	#16800.00	66.8 PK	68.3	-1.5	1.21 H	150	11.80	55.00
ANTENNA POLARITY & TEST DISTANCE: VERTICAL AT 3 M								
NO.	FREQ. (MHz)	EMISSION LEVEL (dBuV/m)	LIMIT (dBuV/m)	MARGIN (dB)	ANTENNA HEIGHT (m)	TABLE ANGLE (Degree)	RAW VALUE (dBuV)	CORRECTION FACTOR (dB/m)
1	*5680.00	116.3 PK			1.06 V	102	74.80	41.50
2	*5680.00	103.8 AV			1.06 V	102	62.30	41.50
3	#16800.00	66.3 PK	68.3	-2.0	1.32 V	172	11.30	55.00

- REMARKS:**
1. Emission level (dBuV/m) = Raw Value (dBuV) + Correction Factor (dB/m).
 2. Correction Factor (dB/m) = Antenna Factor (dB/m) + Cable Factor (dB).
 3. The other emission levels were very low against the limit.
 4. Margin value = Emission level – Limit value.
 5. “ * “: Fundamental frequency.
 6. “#”:The radiated frequency is out the restricted band.



A D T

EUT TEST CONDITION		MEASUREMENT DETAIL	
CHANNEL	Channel 140	FREQUENCY RANGE	1 ~ 40GHz
INPUT POWER (SYSTEM)	120Vac, 60 Hz	DETECTOR FUNCTION	Peak (PK) Average (AV)
ENVIRONMENTAL CONDITIONS	25deg. C, 65%RH 1008 hPa	TESTED BY	Match Tsui

ANTENNA POLARITY & TEST DISTANCE: HORIZONTAL AT 3 M								
NO.	FREQ. (MHz)	EMISSION LEVEL (dBuV/m)	LIMIT (dBuV/m)	MARGIN (dB)	ANTENNA HEIGHT (m)	TABLE ANGLE (Degree)	RAW VALUE (dBuV)	CORRECTION FACTOR (dB/m)
1	*5700.00	113.0 PK			1.00 H	134	71.40	41.60
2	*5700.00	100.4 AV			1.00 H	134	58.80	41.60
3	#5725.00	67.2 PK	68.3	-1.1	1.00 H	128	25.60	41.60
4	#17100.00	66.0 PK	68.3	-2.3	1.06 H	53	10.00	56.00
ANTENNA POLARITY & TEST DISTANCE: VERTICAL AT 3 M								
NO.	FREQ. (MHz)	EMISSION LEVEL (dBuV/m)	LIMIT (dBuV/m)	MARGIN (dB)	ANTENNA HEIGHT (m)	TABLE ANGLE (Degree)	RAW VALUE (dBuV)	CORRECTION FACTOR (dB/m)
1	*5700.00	115.9 PK			1.05 V	102	74.30	41.60
2	*5700.00	103.5 AV			1.05 V	102	61.90	41.60
3	#5725.00	67.3 PK	68.3	-1.0	1.12 V	103	25.70	41.60
4	#17100.00	66.2 PK	68.3	-2.1	1.00 V	117	10.20	56.00

- REMARKS:**
1. Emission level (dBuV/m) = Raw Value (dBuV) + Correction Factor (dB/m).
 2. Correction Factor (dB/m) = Antenna Factor (dB/m) + Cable Factor (dB).
 3. The other emission levels were very low against the limit.
 4. Margin value = Emission level – Limit value.
 5. “ * “: Fundamental frequency.
 6. “#”: The radiated frequency is out the restricted band.



A D T

802.11n (20MHz)

EUT TEST CONDITION		MEASUREMENT DETAIL	
CHANNEL	Channel 52	FREQUENCY RANGE	1 ~ 40GHz
INPUT POWER (SYSTEM)	120Vac, 60 Hz	DETECTOR FUNCTION	Peak (PK) Average (AV)
ENVIRONMENTAL CONDITIONS	25deg. C, 65%RH 1008 hPa	TESTED BY	Match Tsui

ANTENNA POLARITY & TEST DISTANCE: HORIZONTAL AT 3 M								
NO.	FREQ. (MHz)	EMISSION LEVEL (dBuV/m)	LIMIT (dBuV/m)	MARGIN (dB)	ANTENNA HEIGHT (m)	TABLE ANGLE (Degree)	RAW VALUE (dBuV)	CORRECTION FACTOR (dB/m)
1	5150.00	58.2 PK	74.0	-15.8	1.00 H	130	17.50	40.70
2	5150.00	47.7 AV	54.0	-6.3	1.00 H	130	7.00	40.70
3	*5260.00	118.1 PK			1.00 H	128	77.30	40.80
4	*5260.00	105.9 AV			1.00 H	128	65.10	40.80
5	15780.00	63.5 PK	74.0	-10.5	1.34 H	77	11.00	52.50
6	15780.00	49.3 AV	54.0	-4.7	1.34 H	77	-3.20	52.50
ANTENNA POLARITY & TEST DISTANCE: VERTICAL AT 3 M								
NO.	FREQ. (MHz)	EMISSION LEVEL (dBuV/m)	LIMIT (dBuV/m)	MARGIN (dB)	ANTENNA HEIGHT (m)	TABLE ANGLE (Degree)	RAW VALUE (dBuV)	CORRECTION FACTOR (dB/m)
1	5150.00	59.7 PK	74.0	-14.3	1.05 V	109	19.00	40.70
2	5150.00	48.0 AV	54.0	-6.0	1.05 V	109	7.30	40.70
3	*5260.00	120.1 PK			1.05 V	109	79.30	40.80
4	*5260.00	107.0 AV			1.05 V	109	66.20	40.80
5	15780.00	64.2 PK	74.0	-9.8	1.19 V	219	11.70	52.50
6	15780.00	49.5 AV	54.0	-4.5	1.19 V	219	-3.00	52.50

- REMARKS:**
1. Emission level (dBuV/m) = Raw Value (dBuV) + Correction Factor (dB/m).
 2. Correction Factor (dB/m) = Antenna Factor (dB/m) + Cable Factor (dB).
 3. The other emission levels were very low against the limit.
 4. Margin value = Emission level – Limit value.
 5. “ * “: Fundamental frequency.



A D T

EUT TEST CONDITION		MEASUREMENT DETAIL	
CHANNEL	Channel 60	FREQUENCY RANGE	1 ~ 40GHz
INPUT POWER (SYSTEM)	120Vac, 60 Hz	DETECTOR FUNCTION	Peak (PK) Average (AV)
ENVIRONMENTAL CONDITIONS	25deg. C, 65%RH 1008 hPa	TESTED BY	Match Tsui

ANTENNA POLARITY & TEST DISTANCE: HORIZONTAL AT 3 M								
NO.	FREQ. (MHz)	EMISSION LEVEL (dBuV/m)	LIMIT (dBuV/m)	MARGIN (dB)	ANTENNA HEIGHT (m)	TABLE ANGLE (Degree)	RAW VALUE (dBuV)	CORRECTION FACTOR (dB/m)
1	*5300.00	117.3 PK			1.28 H	123	76.50	40.80
2	*5300.00	104.8 AV			1.28 H	123	64.00	40.80
3	15900.00	63.5 PK	74.0	-10.5	1.18 H	81	11.40	52.10
4	15900.00	49.7 AV	54.0	-4.3	1.18 H	81	-2.40	52.10
ANTENNA POLARITY & TEST DISTANCE: VERTICAL AT 3 M								
NO.	FREQ. (MHz)	EMISSION LEVEL (dBuV/m)	LIMIT (dBuV/m)	MARGIN (dB)	ANTENNA HEIGHT (m)	TABLE ANGLE (Degree)	RAW VALUE (dBuV)	CORRECTION FACTOR (dB/m)
1	*5300.00	118.9 PK			1.03 V	109	78.10	40.80
2	*5300.00	106.0 AV			1.03 V	109	65.20	40.80
3	15900.00	62.8 PK	74.0	-11.2	1.27 V	244	10.70	52.10
4	15900.00	48.8 AV	54.0	-5.2	1.27 V	244	-3.30	52.10

- REMARKS:**
1. Emission level (dBuV/m) = Raw Value (dBuV) + Correction Factor (dB/m).
 2. Correction Factor (dB/m) = Antenna Factor (dB/m) + Cable Factor (dB).
 3. The other emission levels were very low against the limit.
 4. Margin value = Emission level – Limit value.
 5. “ * “: Fundamental frequency.



A D T

EUT TEST CONDITION		MEASUREMENT DETAIL	
CHANNEL	Channel 64	FREQUENCY RANGE	1 ~ 40GHz
INPUT POWER (SYSTEM)	120Vac, 60 Hz	DETECTOR FUNCTION	Peak (PK) Average (AV)
ENVIRONMENTAL CONDITIONS	25deg. C, 65%RH 1008 hPa	TESTED BY	Match Tsui

ANTENNA POLARITY & TEST DISTANCE: HORIZONTAL AT 3 M								
NO.	FREQ. (MHz)	EMISSION LEVEL (dBuV/m)	LIMIT (dBuV/m)	MARGIN (dB)	ANTENNA HEIGHT (m)	TABLE ANGLE (Degree)	RAW VALUE (dBuV)	CORRECTION FACTOR (dB/m)
1	*5320.00	115.5 PK			1.01 H	144	74.60	40.90
2	*5320.00	103.2 AV			1.01 H	144	62.30	40.90
3	5350.00	68.3 PK	74.0	-5.7	1.00 H	146	27.40	40.90
4	5350.00	50.8 AV	54.0	-3.2	1.00 H	146	9.90	40.90
5	15960.00	63.8 PK	74.0	-10.2	1.01 H	43	11.50	52.30
6	15960.00	49.4 AV	54.0	-4.6	1.01 H	43	-2.90	52.30
ANTENNA POLARITY & TEST DISTANCE: VERTICAL AT 3 M								
NO.	FREQ. (MHz)	EMISSION LEVEL (dBuV/m)	LIMIT (dBuV/m)	MARGIN (dB)	ANTENNA HEIGHT (m)	TABLE ANGLE (Degree)	RAW VALUE (dBuV)	CORRECTION FACTOR (dB/m)
1	*5320.00	118.3 PK			1.02 V	108	77.40	40.90
2	*5320.00	105.0 AV			1.02 V	108	64.10	40.90
3	5350.00	73.0 PK	74.0	-1.0	1.01 V	108	32.10	40.90
4	5350.00	51.6 AV	54.0	-2.4	1.01 V	108	10.70	40.90
5	15960.00	63.0 PK	74.0	-11.0	1.07 V	339	10.70	52.30
6	15960.00	49.1 AV	54.0	-4.9	1.07 V	339	-3.20	52.30

- REMARKS:**
1. Emission level (dBuV/m) = Raw Value (dBuV) + Correction Factor (dB/m).
 2. Correction Factor (dB/m) = Antenna Factor (dB/m) + Cable Factor (dB).
 3. The other emission levels were very low against the limit.
 4. Margin value = Emission level – Limit value.
 5. “ * “: Fundamental frequency.



A D T

EUT TEST CONDITION		MEASUREMENT DETAIL	
CHANNEL	Channel 100	FREQUENCY RANGE	1 ~ 40GHz
INPUT POWER (SYSTEM)	120Vac, 60 Hz	DETECTOR FUNCTION	Peak (PK) Average (AV)
ENVIRONMENTAL CONDITIONS	25deg. C, 65%RH 1008 hPa	TESTED BY	Match Tsui

ANTENNA POLARITY & TEST DISTANCE: HORIZONTAL AT 3 M								
NO.	FREQ. (MHz)	EMISSION LEVEL (dBuV/m)	LIMIT (dBuV/m)	MARGIN (dB)	ANTENNA HEIGHT (m)	TABLE ANGLE (Degree)	RAW VALUE (dBuV)	CORRECTION FACTOR (dB/m)
1	5460.00	59.5 PK	74.0	-14.5	1.04 H	133	18.40	41.10
2	5460.00	46.2 AV	54.0	-7.8	1.04 H	133	5.10	41.10
3	#5470.00	66.9 PK	68.3	-1.4	1.07 H	154	25.80	41.10
4	*5500.00	114.2 PK			1.08 H	149	73.10	41.10
5	*5500.00	102.8 AV			1.08 H	149	61.70	41.10
6	#16500.00	66.6 PK	68.3	-1.7	1.19 H	120	13.10	53.50
ANTENNA POLARITY & TEST DISTANCE: VERTICAL AT 3 M								
NO.	FREQ. (MHz)	EMISSION LEVEL (dBuV/m)	LIMIT (dBuV/m)	MARGIN (dB)	ANTENNA HEIGHT (m)	TABLE ANGLE (Degree)	RAW VALUE (dBuV)	CORRECTION FACTOR (dB/m)
1	5460.00	59.4 PK	74.0	-14.6	1.00 V	111	18.30	41.10
2	5460.00	47.4 AV	54.0	-6.6	1.00 V	111	6.30	41.10
3	#5470.00	67.3 PK	68.3	-1.0	1.01 V	117	26.20	41.10
4	*5500.00	116.6 PK			1.00 V	108	75.50	41.10
5	*5500.00	106.3 AV			1.00 V	108	65.20	41.10
6	#16500.00	65.2 PK	68.3	-3.1	1.12 V	64	11.70	53.50

- REMARKS:**
1. Emission level (dBuV/m) = Raw Value (dBuV) + Correction Factor (dB/m).
 2. Correction Factor (dB/m) = Antenna Factor (dB/m) + Cable Factor (dB).
 3. The other emission levels were very low against the limit.
 4. Margin value = Emission level – Limit value.
 5. “ * “: Fundamental frequency.
 6. “#”: The radiated frequency is out the restricted band.



A D T

EUT TEST CONDITION		MEASUREMENT DETAIL	
CHANNEL	Channel 116	FREQUENCY RANGE	1 ~ 40GHz
INPUT POWER (SYSTEM)	120Vac, 60 Hz	DETECTOR FUNCTION	Peak (PK) Average (AV)
ENVIRONMENTAL CONDITIONS	25deg. C, 65%RH 1008 hPa	TESTED BY	Match Tsui

ANTENNA POLARITY & TEST DISTANCE: HORIZONTAL AT 3 M								
NO.	FREQ. (MHz)	EMISSION LEVEL (dBuV/m)	LIMIT (dBuV/m)	MARGIN (dB)	ANTENNA HEIGHT (m)	TABLE ANGLE (Degree)	RAW VALUE (dBuV)	CORRECTION FACTOR (dB/m)
1	*5580.00	114.0 PK			1.00 H	132	72.70	41.30
2	*5580.00	101.6 AV			1.00 H	132	60.30	41.30
3	#16740.00	65.2 PK	68.3	-3.1	1.01 H	88	10.70	54.50
ANTENNA POLARITY & TEST DISTANCE: VERTICAL AT 3 M								
NO.	FREQ. (MHz)	EMISSION LEVEL (dBuV/m)	LIMIT (dBuV/m)	MARGIN (dB)	ANTENNA HEIGHT (m)	TABLE ANGLE (Degree)	RAW VALUE (dBuV)	CORRECTION FACTOR (dB/m)
1	*5580.00	116.3 PK			1.04 V	104	75.00	41.30
2	*5580.00	104.1 AV			1.04 V	104	62.80	41.30
3	#16740.00	64.9 PK	68.3	-3.4	1.39 V	250	10.40	54.50

- REMARKS:**
1. Emission level (dBuV/m) = Raw Value (dBuV) + Correction Factor (dB/m).
 2. Correction Factor (dB/m) = Antenna Factor (dB/m) + Cable Factor (dB).
 3. The other emission levels were very low against the limit.
 4. Margin value = Emission level – Limit value.
 5. “ * “: Fundamental frequency.
 6. “#”:The radiated frequency is out the restricted band.



A D T

EUT TEST CONDITION		MEASUREMENT DETAIL	
CHANNEL	Channel 136	FREQUENCY RANGE	1 ~ 40GHz
INPUT POWER (SYSTEM)	120Vac, 60 Hz	DETECTOR FUNCTION	Peak (PK) Average (AV)
ENVIRONMENTAL CONDITIONS	25deg. C, 65%RH 1008 hPa	TESTED BY	Match Tsui

ANTENNA POLARITY & TEST DISTANCE: HORIZONTAL AT 3 M								
NO.	FREQ. (MHz)	EMISSION LEVEL (dBuV/m)	LIMIT (dBuV/m)	MARGIN (dB)	ANTENNA HEIGHT (m)	TABLE ANGLE (Degree)	RAW VALUE (dBuV)	CORRECTION FACTOR (dB/m)
1	*5680.00	114.0 PK			1.06 H	154	72.50	41.50
2	*5680.00	101.1 AV			1.06 H	154	59.60	41.50
3	#16800.00	66.4 PK	68.3	-1.9	1.21 H	149	11.40	55.00
ANTENNA POLARITY & TEST DISTANCE: VERTICAL AT 3 M								
NO.	FREQ. (MHz)	EMISSION LEVEL (dBuV/m)	LIMIT (dBuV/m)	MARGIN (dB)	ANTENNA HEIGHT (m)	TABLE ANGLE (Degree)	RAW VALUE (dBuV)	CORRECTION FACTOR (dB/m)
1	*5680.00	116.8 PK			1.08 V	103	75.30	41.50
2	*5680.00	104.2 AV			1.08 V	103	62.70	41.50
3	#16800.00	66.1 PK	68.3	-2.2	1.29 V	188	11.10	55.00

- REMARKS:**
1. Emission level (dBuV/m) = Raw Value (dBuV) + Correction Factor (dB/m).
 2. Correction Factor (dB/m) = Antenna Factor (dB/m) + Cable Factor (dB).
 3. The other emission levels were very low against the limit.
 4. Margin value = Emission level – Limit value.
 5. “ * “: Fundamental frequency.
 6. “#” :The radiated frequency is out the restricted band.



A D T

EUT TEST CONDITION		MEASUREMENT DETAIL	
CHANNEL	Channel 140	FREQUENCY RANGE	1 ~ 40GHz
INPUT POWER (SYSTEM)	120Vac, 60 Hz	DETECTOR FUNCTION	Peak (PK) Average (AV)
ENVIRONMENTAL CONDITIONS	25deg. C, 65%RH 1008 hPa	TESTED BY	Match Tsui

ANTENNA POLARITY & TEST DISTANCE: HORIZONTAL AT 3 M								
NO.	FREQ. (MHz)	EMISSION LEVEL (dBuV/m)	LIMIT (dBuV/m)	MARGIN (dB)	ANTENNA HEIGHT (m)	TABLE ANGLE (Degree)	RAW VALUE (dBuV)	CORRECTION FACTOR (dB/m)
1	*5700.00	113.2 PK			1.02 H	133	71.60	41.60
2	*5700.00	100.6 AV			1.02 H	133	59.00	41.60
3	#5725.00	66.9 PK	68.3	-1.4	1.03 H	135	25.30	41.60
4	#17100.00	65.7 PK	68.3	-2.6	1.04 H	69	9.70	56.00
ANTENNA POLARITY & TEST DISTANCE: VERTICAL AT 3 M								
NO.	FREQ. (MHz)	EMISSION LEVEL (dBuV/m)	LIMIT (dBuV/m)	MARGIN (dB)	ANTENNA HEIGHT (m)	TABLE ANGLE (Degree)	RAW VALUE (dBuV)	CORRECTION FACTOR (dB/m)
1	*5700.00	115.3 PK			1.04 V	109	73.70	41.60
2	*5700.00	102.8 AV			1.04 V	109	61.20	41.60
3	#5725.00	67.1 PK	68.3	-1.2	1.04 V	110	25.50	41.60
4	#17100.00	66.1 PK	68.3	-2.2	1.01 V	113	10.10	56.00

- REMARKS:**
1. Emission level (dBuV/m) = Raw Value (dBuV) + Correction Factor (dB/m).
 2. Correction Factor (dB/m) = Antenna Factor (dB/m) + Cable Factor (dB).
 3. The other emission levels were very low against the limit.
 4. Margin value = Emission level – Limit value.
 5. “ * “: Fundamental frequency.
 6. “#”:The radiated frequency is out the restricted band.



A D T

802.11n (40MHz)

EUT TEST CONDITION		MEASUREMENT DETAIL	
CHANNEL	Channel 54	FREQUENCY RANGE	1 ~ 40GHz
INPUT POWER (SYSTEM)	120Vac, 60 Hz	DETECTOR FUNCTION	Peak (PK) Average (AV)
ENVIRONMENTAL CONDITIONS	25deg. C, 65%RH 1008 hPa	TESTED BY	Match Tsui

ANTENNA POLARITY & TEST DISTANCE: HORIZONTAL AT 3 M								
NO.	FREQ. (MHz)	EMISSION LEVEL (dBuV/m)	LIMIT (dBuV/m)	MARGIN (dB)	ANTENNA HEIGHT (m)	TABLE ANGLE (Degree)	RAW VALUE (dBuV)	CORRECTION FACTOR (dB/m)
1	5150.00	58.7 PK	74.0	-15.3	1.00 H	129	18.00	40.70
2	5150.00	47.0 AV	54.0	-7.0	1.00 H	129	6.30	40.70
3	*5270.00	114.3 PK			1.00 H	131	73.50	40.80
4	*5270.00	101.0 AV			1.00 H	131	60.20	40.80
5	15810.00	62.6 PK	74.0	-11.4	1.10 H	46	10.20	52.40
6	15810.00	49.1 AV	54.0	-4.9	1.10 H	46	-3.30	52.40
ANTENNA POLARITY & TEST DISTANCE: VERTICAL AT 3 M								
NO.	FREQ. (MHz)	EMISSION LEVEL (dBuV/m)	LIMIT (dBuV/m)	MARGIN (dB)	ANTENNA HEIGHT (m)	TABLE ANGLE (Degree)	RAW VALUE (dBuV)	CORRECTION FACTOR (dB/m)
1	5150.00	58.9 PK	74.0	-15.1	1.04 V	108	18.20	40.70
2	5150.00	47.3 AV	54.0	-6.7	1.04 V	108	6.60	40.70
3	*5270.00	116.2 PK			1.04 V	108	75.40	40.80
4	*5270.00	102.8 AV			1.04 V	108	62.00	40.80
5	15810.00	62.6 PK	74.0	-11.4	1.04 V	208	10.20	52.40
6	15810.00	48.7 AV	54.0	-5.3	1.04 V	208	-3.70	52.40

- REMARKS:**
1. Emission level (dBuV/m) = Raw Value (dBuV) + Correction Factor (dB/m).
 2. Correction Factor (dB/m) = Antenna Factor (dB/m) + Cable Factor (dB).
 3. The other emission levels were very low against the limit.
 4. Margin value = Emission level – Limit value.
 5. “ * “: Fundamental frequency.



A D T

EUT TEST CONDITION		MEASUREMENT DETAIL	
CHANNEL	Channel 62	FREQUENCY RANGE	1 ~ 40GHz
INPUT POWER (SYSTEM)	120Vac, 60 Hz	DETECTOR FUNCTION	Peak (PK) Average (AV)
ENVIRONMENTAL CONDITIONS	25deg. C, 65%RH 1008 hPa	TESTED BY	Match Tsui

ANTENNA POLARITY & TEST DISTANCE: HORIZONTAL AT 3 M								
NO.	FREQ. (MHz)	EMISSION LEVEL (dBuV/m)	LIMIT (dBuV/m)	MARGIN (dB)	ANTENNA HEIGHT (m)	TABLE ANGLE (Degree)	RAW VALUE (dBuV)	CORRECTION FACTOR (dB/m)
1	*5310.00	110.1 PK			1.01 H	131	69.20	40.90
2	*5310.00	96.2 AV			1.01 H	131	55.30	40.90
3	5350.00	70.8 PK	74.0	-3.2	1.00 H	129	29.90	40.90
4	5350.00	50.4 AV	54.0	-3.6	1.00 H	129	9.50	40.90
5	15930.00	63.4 PK	74.0	-10.6	1.03 H	199	11.20	52.20
6	15930.00	49.8 AV	54.0	-4.2	1.03 H	199	-2.40	52.20
ANTENNA POLARITY & TEST DISTANCE: VERTICAL AT 3 M								
NO.	FREQ. (MHz)	EMISSION LEVEL (dBuV/m)	LIMIT (dBuV/m)	MARGIN (dB)	ANTENNA HEIGHT (m)	TABLE ANGLE (Degree)	RAW VALUE (dBuV)	CORRECTION FACTOR (dB/m)
1	*5310.00	113.5 PK			1.03 V	108	72.60	40.90
2	*5310.00	99.6 AV			1.03 V	108	58.70	40.90
3	5350.00	72.1 PK	74.0	-1.9	1.00 V	106	31.20	40.90
4	5350.00	52.9 AV	54.0	-1.1	1.00 V	106	12.00	40.90
5	15930.00	62.9 PK	74.0	-11.1	1.04 V	200	10.70	52.20
6	15930.00	49.0 AV	54.0	-5.0	1.04 V	200	-3.20	52.20

- REMARKS:**
1. Emission level (dBuV/m) = Raw Value (dBuV) + Correction Factor (dB/m).
 2. Correction Factor (dB/m) = Antenna Factor (dB/m) + Cable Factor (dB).
 3. The other emission levels were very low against the limit.
 4. Margin value = Emission level – Limit value.
 5. “ * “: Fundamental frequency.



A D T

EUT TEST CONDITION		MEASUREMENT DETAIL	
CHANNEL	Channel 102	FREQUENCY RANGE	1 ~ 40GHz
INPUT POWER (SYSTEM)	120Vac, 60 Hz	DETECTOR FUNCTION	Peak (PK) Average (AV)
ENVIRONMENTAL CONDITIONS	25deg. C, 65%RH 1008 hPa	TESTED BY	Match Tsui

ANTENNA POLARITY & TEST DISTANCE: HORIZONTAL AT 3 M								
NO.	FREQ. (MHz)	EMISSION LEVEL (dBuV/m)	LIMIT (dBuV/m)	MARGIN (dB)	ANTENNA HEIGHT (m)	TABLE ANGLE (Degree)	RAW VALUE (dBuV)	CORRECTION FACTOR (dB/m)
1	5460.00	60.4 PK	74.0	-13.6	1.01 H	110	19.30	41.10
2	5460.00	44.6 AV	54.0	-9.4	1.01 H	110	3.50	41.10
3	#5470.00	66.7 PK	68.3	-1.6	1.01 H	110	25.60	41.10
4	*5510.00	108.5 PK			1.01 H	110	67.30	41.20
5	*5510.00	94.3 AV			1.01 H	110	53.10	41.20
6	#16530.00	64.2 PK	68.3	-4.1	1.11 H	50	10.60	53.60
ANTENNA POLARITY & TEST DISTANCE: VERTICAL AT 3 M								
NO.	FREQ. (MHz)	EMISSION LEVEL (dBuV/m)	LIMIT (dBuV/m)	MARGIN (dB)	ANTENNA HEIGHT (m)	TABLE ANGLE (Degree)	RAW VALUE (dBuV)	CORRECTION FACTOR (dB/m)
1	5460.00	63.2 PK	74.0	-10.8	1.00 V	115	22.10	41.10
2	5460.00	47.3 AV	54.0	-6.7	1.00 V	115	6.20	41.10
3	#5470.00	67.3 PK	68.3	-1.0	1.00 V	115	26.20	41.10
4	*5510.00	110.4 PK			1.00 V	108	69.20	41.20
5	*5510.00	96.5 AV			1.00 V	108	55.30	41.20
6	#16530.00	63.8 PK	68.3	-4.5	1.03 V	211	10.20	53.60

- REMARKS:**
1. Emission level (dBuV/m) = Raw Value (dBuV) + Correction Factor (dB/m).
 2. Correction Factor (dB/m) = Antenna Factor (dB/m) + Cable Factor (dB).
 3. The other emission levels were very low against the limit.
 4. Margin value = Emission level – Limit value.
 5. “ * “: Fundamental frequency.
 6. “#”: The radiated frequency is out the restricted band.



A D T

EUT TEST CONDITION		MEASUREMENT DETAIL	
CHANNEL	Channel 110	FREQUENCY RANGE	1 ~ 40GHz
INPUT POWER (SYSTEM)	120Vac, 60 Hz	DETECTOR FUNCTION	Peak (PK) Average (AV)
ENVIRONMENTAL CONDITIONS	25deg. C, 65%RH 1008 hPa	TESTED BY	Match Tsui

ANTENNA POLARITY & TEST DISTANCE: HORIZONTAL AT 3 M								
NO.	FREQ. (MHz)	EMISSION LEVEL (dBuV/m)	LIMIT (dBuV/m)	MARGIN (dB)	ANTENNA HEIGHT (m)	TABLE ANGLE (Degree)	RAW VALUE (dBuV)	CORRECTION FACTOR (dB/m)
1	*5550.00	113.1 PK			1.05 H	135	71.90	41.20
2	*5550.00	99.2 AV			1.05 H	135	58.00	41.20
3	#5725.00	59.1 PK	68.3	-9.2	1.04 H	133	17.50	41.60
4	#16650.00	64.8 PK	68.3	-3.5	1.03 H	210	10.80	54.00
ANTENNA POLARITY & TEST DISTANCE: VERTICAL AT 3 M								
NO.	FREQ. (MHz)	EMISSION LEVEL (dBuV/m)	LIMIT (dBuV/m)	MARGIN (dB)	ANTENNA HEIGHT (m)	TABLE ANGLE (Degree)	RAW VALUE (dBuV)	CORRECTION FACTOR (dB/m)
1	*5550.00	116.8 PK			1.00 V	108	75.60	41.20
2	*5550.00	102.8 AV			1.00 V	108	61.60	41.20
3	#5725.00	62.9 PK	68.3	-5.4	1.11 V	102	21.30	41.60
4	#16650.00	66.2 PK	68.3	-2.1	1.02 V	199	12.20	54.00

- REMARKS:**
1. Emission level (dBuV/m) = Raw Value (dBuV) + Correction Factor (dB/m).
 2. Correction Factor (dB/m) = Antenna Factor (dB/m) + Cable Factor (dB).
 3. The other emission levels were very low against the limit.
 4. Margin value = Emission level – Limit value.
 5. “ * “: Fundamental frequency.
 6. “#”:The radiated frequency is out the restricted band.



A D T

FOR FREQUENCY 5260MHz ~ 5320MHz

BELOW 1GHz WORST-CASE DATA : 802.11a

EUT TEST CONDITION		MEASUREMENT DETAIL	
CHANNEL	Channel 52	FREQUENCY RANGE	Below 1000MHz
INPUT POWER (SYSTEM)	120Vac, 60 Hz	DETECTOR FUNCTION	Quasi-Peak
ENVIRONMENTAL CONDITIONS	23deg. C, 71%RH 1008 hPa	TEST MODE	A
TESTED BY	Jacky Lee		

ANTENNA POLARITY & TEST DISTANCE: HORIZONTAL AT 3 M								
NO.	FREQ. (MHz)	EMISSION LEVEL (dBuV/m)	LIMIT (dBuV/m)	MARGIN (dB)	ANTENNA HEIGHT (m)	TABLE ANGLE (Degree)	RAW VALUE (dBuV)	CORRECTION FACTOR (dB/m)
1	199.45	37.6 QP	43.5	-5.9	1.00 H	262	26.52	11.06
2	339.88	38.5 QP	46.0	-7.6	1.00 H	186	22.41	16.04
3	399.44	37.4 QP	46.0	-8.6	1.50 H	356	19.71	17.73
4	500.72	43.2 QP	46.0	-2.8	2.50 H	42	23.28	19.96
5	533.47	40.5 QP	46.0	-5.6	1.00 H	82	19.67	20.78
6	751.28	35.5 QP	46.0	-10.5	1.00 H	162	10.69	24.78
ANTENNA POLARITY & TEST DISTANCE: VERTICAL AT 3 M								
NO.	FREQ. (MHz)	EMISSION LEVEL (dBuV/m)	LIMIT (dBuV/m)	MARGIN (dB)	ANTENNA HEIGHT (m)	TABLE ANGLE (Degree)	RAW VALUE (dBuV)	CORRECTION FACTOR (dB/m)
1	30.00	37.5 QP	40.0	-2.5	1.00 V	156	24.67	12.84
2	59.27	37.1 QP	40.0	-2.9	1.00 V	160	23.98	13.08
3	374.47	35.9 QP	46.0	-10.1	2.00 V	215	18.74	17.18
4	500.42	43.5 QP	46.0	-2.6	2.50 V	40	23.25	20.20
5	533.17	37.3 QP	46.0	-8.7	2.50 V	185	16.36	20.95
6	750.41	36.2 QP	46.0	-9.8	3.50 V	289	11.28	24.95

REMARKS: 1. Emission level (dBuV/m) = Raw Value (dBuV) + Correction Factor (dB/m).

2. Correction Factor (dB/m) = Antenna Factor (dB/m) + Cable Factor (dB).

3. The other emission levels were very low against the limit.

4. Margin value = Emission level – Limit value.



A D T

EUT TEST CONDITION		MEASUREMENT DETAIL	
CHANNEL	Channel 52	FREQUENCY RANGE	Below 1000MHz
INPUT POWER (SYSTEM)	120Vac, 60 Hz	DETECTOR FUNCTION	Quasi-Peak
ENVIRONMENTAL CONDITIONS	23deg. C, 71%RH 1008 hPa	TEST MODE	B
TESTED BY	Jacky Lee		

ANTENNA POLARITY & TEST DISTANCE: HORIZONTAL AT 3 M								
NO.	FREQ. (MHz)	EMISSION LEVEL (dBuV/m)	LIMIT (dBuV/m)	MARGIN (dB)	ANTENNA HEIGHT (m)	TABLE ANGLE (Degree)	RAW VALUE (dBuV)	CORRECTION FACTOR (dB/m)
1	249.34	37.6 QP	46.0	-8.4	1.50 H	187	24.38	13.18
2	375.67	39.7 QP	46.0	-6.3	2.00 H	40	22.62	17.06
3	501.77	44.0 QP	46.0	-2.1	4.00 H	123	23.97	19.98
4	533.57	40.7 QP	46.0	-5.3	1.00 H	140	19.88	20.78
5	625.07	39.7 QP	46.0	-6.3	3.50 H	136	16.85	22.85
6	751.18	36.5 QP	46.0	-9.5	1.00 H	211	11.69	24.78
ANTENNA POLARITY & TEST DISTANCE: VERTICAL AT 3 M								
NO.	FREQ. (MHz)	EMISSION LEVEL (dBuV/m)	LIMIT (dBuV/m)	MARGIN (dB)	ANTENNA HEIGHT (m)	TABLE ANGLE (Degree)	RAW VALUE (dBuV)	CORRECTION FACTOR (dB/m)
1	44.85	36.9 QP	40.0	-3.1	1.00 V	205	22.08	14.80
2	199.82	36.0 QP	43.5	-7.5	1.00 V	343	24.77	11.26
3	375.17	37.6 QP	46.0	-8.4	1.50 V	25	20.36	17.20
4	500.12	40.6 QP	46.0	-5.4	2.00 V	319	20.42	20.19
5	533.17	34.5 QP	46.0	-11.5	2.50 V	193	13.51	20.95
6	751.88	41.2 QP	46.0	-4.8	4.00 V	61	16.19	24.98

- REMARKS:**
1. Emission level (dBuV/m) = Raw Value (dBuV) + Correction Factor (dB/m).
 2. Correction Factor (dB/m) = Antenna Factor (dB/m) + Cable Factor (dB).
 3. The other emission levels were very low against the limit.
 4. Margin value = Emission level – Limit value.



A D T

FOR FREQUENCY 5500MHz ~ 5700MHz

BELOW 1GHz WORST-CASE DATA : 802.11a

EUT TEST CONDITION		MEASUREMENT DETAIL	
CHANNEL	Channel 100	FREQUENCY RANGE	Below 1000MHz
INPUT POWER (SYSTEM)	120Vac, 60 Hz	DETECTOR FUNCTION	Quasi-Peak
ENVIRONMENTAL CONDITIONS	23deg. C, 71%RH 1008 hPa	TEST MODE	A
TESTED BY	Jacky Lee		

ANTENNA POLARITY & TEST DISTANCE: HORIZONTAL AT 3 M								
NO.	FREQ. (MHz)	EMISSION LEVEL (dBuV/m)	LIMIT (dBuV/m)	MARGIN (dB)	ANTENNA HEIGHT (m)	TABLE ANGLE (Degree)	RAW VALUE (dBuV)	CORRECTION FACTOR (dB/m)
1	125.75	36.5 QP	43.5	-7.0	1.00 H	293	23.99	12.49
2	339.68	38.1 QP	46.0	-7.9	1.00 H	192	22.08	16.04
3	375.27	37.7 QP	46.0	-8.4	1.50 H	260	20.60	17.05
4	500.42	42.2 QP	46.0	-3.8	1.50 H	167	22.29	19.95
5	751.38	36.5 QP	46.0	-9.5	1.00 H	182	11.69	24.78
6	875.29	38.5 QP	46.0	-7.6	3.00 H	210	11.60	26.85
ANTENNA POLARITY & TEST DISTANCE: VERTICAL AT 3 M								
NO.	FREQ. (MHz)	EMISSION LEVEL (dBuV/m)	LIMIT (dBuV/m)	MARGIN (dB)	ANTENNA HEIGHT (m)	TABLE ANGLE (Degree)	RAW VALUE (dBuV)	CORRECTION FACTOR (dB/m)
1	30.00	36.8 QP	40.0	-3.2	1.00 V	160	23.94	12.84
2	51.33	35.6 QP	40.0	-4.4	1.00 V	192	21.96	13.67
3	333.25	38.3 QP	46.0	-7.7	2.00 V	223	22.29	16.03
4	500.12	43.2 QP	46.0	-2.8	2.00 V	61	23.00	20.19
5	533.22	37.6 QP	46.0	-8.4	2.50 V	210	16.69	20.95
6	750.64	36.4 QP	46.0	-9.6	3.00 V	294	11.48	24.95

- REMARKS:**
1. Emission level (dBuV/m) = Raw Value (dBuV) + Correction Factor (dB/m).
 2. Correction Factor (dB/m) = Antenna Factor (dB/m) + Cable Factor (dB).
 3. The other emission levels were very low against the limit.
 4. Margin value = Emission level – Limit value.



A D T

EUT TEST CONDITION		MEASUREMENT DETAIL	
CHANNEL	Channel 100	FREQUENCY RANGE	Below 1000MHz
INPUT POWER (SYSTEM)	120Vac, 60 Hz	DETECTOR FUNCTION	Quasi-Peak
ENVIRONMENTAL CONDITIONS	23deg. C, 71%RH 1008 hPa	TEST MODE	B
TESTED BY	Jacky Lee		

ANTENNA POLARITY & TEST DISTANCE: HORIZONTAL AT 3 M								
NO.	FREQ. (MHz)	EMISSION LEVEL (dBuV/m)	LIMIT (dBuV/m)	MARGIN (dB)	ANTENNA HEIGHT (m)	TABLE ANGLE (Degree)	RAW VALUE (dBuV)	CORRECTION FACTOR (dB/m)
1	200.08	38.6 QP	43.5	-4.9	1.50 H	240	27.53	11.03
2	249.84	37.2 QP	46.0	-8.8	1.00 H	193	23.96	13.20
3	500.47	43.0 QP	46.0	-3.0	3.50 H	92	23.06	19.95
4	533.07	40.9 QP	46.0	-5.1	2.00 H	236	20.09	20.77
5	625.07	39.7 QP	46.0	-6.3	3.50 H	136	16.85	22.85
6	1000.00	45.3 QP	54.0	-8.8	1.00 H	55	17.10	28.15
ANTENNA POLARITY & TEST DISTANCE: VERTICAL AT 3 M								
NO.	FREQ. (MHz)	EMISSION LEVEL (dBuV/m)	LIMIT (dBuV/m)	MARGIN (dB)	ANTENNA HEIGHT (m)	TABLE ANGLE (Degree)	RAW VALUE (dBuV)	CORRECTION FACTOR (dB/m)
1	30.00	36.1 QP	40.0	-3.9	1.50 V	315	23.28	12.84
2	56.37	37.9 QP	40.0	-2.1	1.00 V	158	24.63	13.30
3	374.77	39.1 QP	46.0	-6.9	1.50 V	106	21.91	17.19
4	500.42	41.4 QP	46.0	-4.6	3.50 V	236	21.17	20.20
5	533.67	37.7 QP	46.0	-8.3	1.50 V	145	16.70	20.96
6	750.88	43.6 QP	46.0	-2.5	3.50 V	70	18.59	24.96

- REMARKS:**
1. Emission level (dBuV/m) = Raw Value (dBuV) + Correction Factor (dB/m).
 2. Correction Factor (dB/m) = Antenna Factor (dB/m) + Cable Factor (dB).
 3. The other emission levels were very low against the limit.
 4. Margin value = Emission level – Limit value.



A D T

4.2 CONDUCTED EMISSION MEASUREMENT

4.2.1 LIMITS OF CONDUCTED EMISSION MEASUREMENT

FREQUENCY OF EMISSION (MHz)	CONDUCTED LIMIT (dB μ V)	
	Quasi-peak	Average
0.15 ~ 0.5	66 to 56	56 to 46
0.5 ~ 5	56	46
5 ~ 30	60	50

- NOTE:** 1. The lower limit shall apply at the transition frequencies.
2. The limit decreases in line with the logarithm of the frequency in the range of 0.15 to 0.50MHz.
3. All emanations from a class A/B digital device or system, including any network of conductors and apparatus connected thereto, shall not exceed the level of field strengths specified above.

4.2.2 TEST INSTRUMENTS

DESCRIPTION & MANUFACTURER	MODEL NO.	SERIAL NO.	DATE OF CALIBRATION	DUE DATE OF CALIBRATION
Test Receiver ROHDE & SCHWARZ	ESCS30	100291	Dec. 16, 2009	Dec. 15, 2010
RF signal cable Woken	5D-FB	Cable-HYC01-01	Nov. 12, 2009	Nov. 11, 2010
LISN ROHDE & SCHWARZ	ESH3-Z5	100312	Jun. 28, 2010	Jun. 27, 2011
LISN ROHDE & SCHWARZ	ESH3-Z5	835239/001	Feb. 10, 2010	Feb. 09, 2011
Software ADT	ADT_Cond_ V7.3.7	NA	NA	NA

- NOTE:** 1. The calibration interval of the above test instruments is 12 months and the calibrations are traceable to NML/ROC and NIST/USA.
2. The test was performed in HwaYa Shielded Room 1.
3. The VCCI Site Registration No. is C-2040.



A D T

4.2.3 TEST PROCEDURES

- a. The EUT was placed 0.4 meters from the conducting wall of the shielded room with EUT being connected to the power mains through a line impedance stabilization network (LISN). Other support units were connected to the power mains through another LISN. The two LISNs provide 50 ohm/ 50uH of coupling impedance for the measuring instrument.
- b. Both lines of the power mains connected to the EUT were checked for maximum conducted interference.
- c. The frequency range from 150kHz to 30MHz was searched. Emission levels under (Limit - 20dB) was not recorded.

4.2.4 DEVIATION FROM TEST STANDARD

No deviation

4.2.5 TEST SETUP

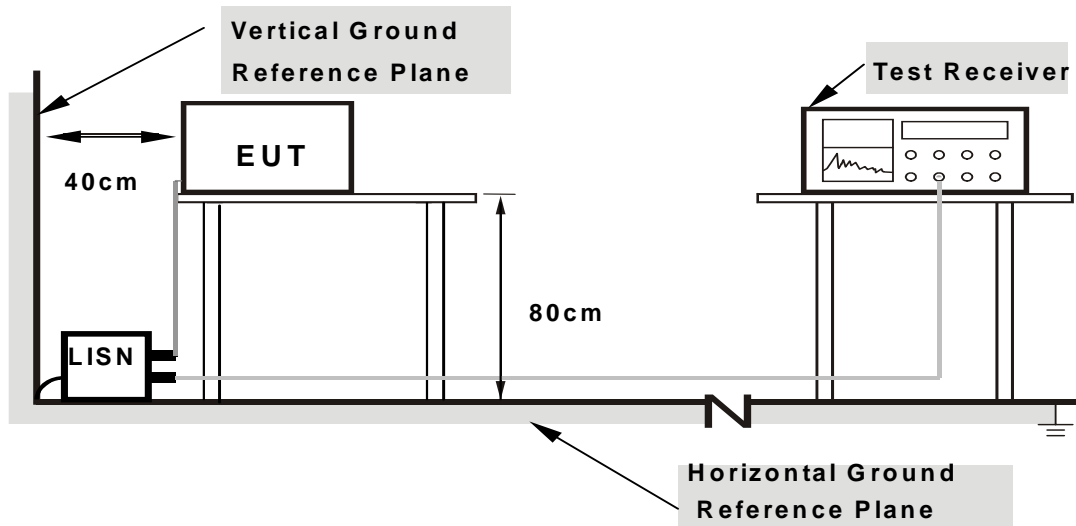

Note: 1.Support units were connected to second LISN.

2.Both of LISNs (AMN) are 80 cm from EUT and at least 80 from other units and other metal planes

For the actual test configuration, please refer to the attached file (Test Setup Photo).

4.2.6 EUT OPERATING CONDITIONS

Same as 4.1.6.



A D T

4.2.7 TEST RESULTS

FOR FREQUENCY 5260MHz ~ 5320MHz

CONDUCTED WORST-CASE DATA : 802.11a

PHASE	Line 1	6dB BANDWIDTH	9kHz
TEST MODE	A		

No	Freq. [MHz]	Corr. Factor (dB)	Reading Value		Emission Level		Limit		Margin	
			[dB (uV)]		[dB (uV)]		[dB (uV)]		(dB)	
			Q.P.	AV.	Q.P.	AV.	Q.P.	AV.	Q.P.	AV.
1	0.158	0.12	46.92	-	47.04	-	65.58	55.58	-18.54	-
2	0.193	0.11	41.70	-	41.81	-	63.91	53.91	-22.10	-
3	0.229	0.11	37.08	-	37.19	-	62.47	52.47	-25.28	-
4	0.595	0.15	29.37	-	29.52	-	56.00	46.00	-26.48	-
5	5.438	0.42	30.01	-	30.43	-	60.00	50.00	-29.57	-
6	23.242	1.69	20.84	-	22.53	-	60.00	50.00	-37.47	-

- REMARKS:**
1. Q.P. and AV. are abbreviations of quasi-peak and average individually.
 2. "-": The Quasi-peak reading value also meets average limit and measurement with the average detector is unnecessary.
 3. The emission levels of other frequencies were very low against the limit.
 4. Margin value = Emission level - Limit value
 5. Correction factor = Insertion loss + Cable loss
 6. Emission Level = Correction Factor + Reading Value.

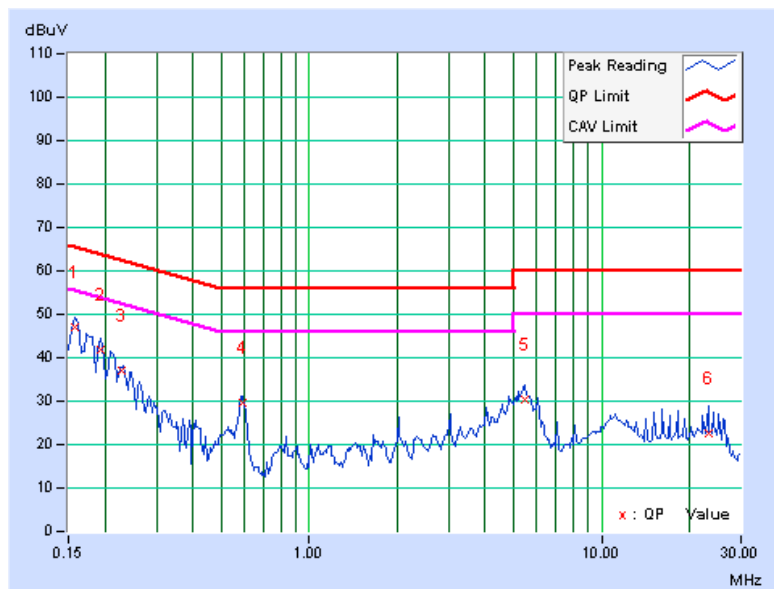



A D T

PHASE	Line 2	6dB BANDWIDTH	9kHz
TEST MODE	A		

No	Freq. [MHz]	Corr. Factor (dB)	Reading Value		Emission Level		Limit		Margin	
			[dB (uV)]		[dB (uV)]		[dB (uV)]		(dB)	
			Q.P.	AV.	Q.P.	AV.	Q.P.	AV.	Q.P.	AV.
1	0.162	0.10	43.63	-	43.73	-	65.38	55.38	-21.65	-
2	0.193	0.10	41.52	-	41.62	-	63.91	53.91	-22.29	-
3	0.228	0.10	37.71	-	37.81	-	62.52	52.52	-24.71	-
4	0.584	0.14	32.64	-	32.78	-	56.00	46.00	-23.22	-
5	5.441	0.38	33.41	-	33.79	-	60.00	50.00	-26.21	-
6	24.266	1.52	21.92	-	23.44	-	60.00	50.00	-36.56	-

- REMARKS:**
1. Q.P. and AV. are abbreviations of quasi-peak and average individually.
 2. "-": The Quasi-peak reading value also meets average limit and measurement with the average detector is unnecessary.
 3. The emission levels of other frequencies were very low against the limit.
 4. Margin value = Emission level - Limit value
 5. Correction factor = Insertion loss + Cable loss
 6. Emission Level = Correction Factor + Reading Value.

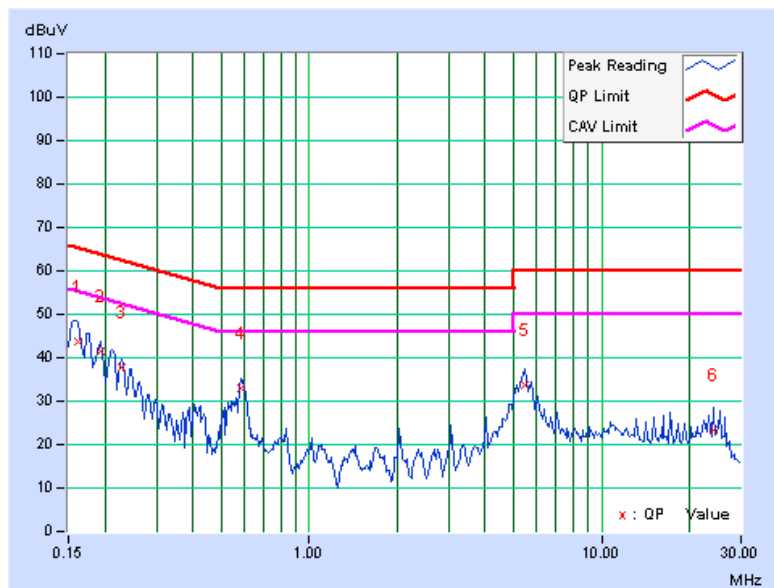



A D T

PHASE	Line 1	6dB BANDWIDTH	9kHz
TEST MODE	B		

No	Freq. [MHz]	Corr. Factor (dB)	Reading Value		Emission Level		Limit		Margin	
			[dB (uV)]		[dB (uV)]		[dB (uV)]		(dB)	
			Q.P.	AV.	Q.P.	AV.	Q.P.	AV.	Q.P.	AV.
1	0.162	0.12	59.20	46.72	59.32	46.84	65.38	55.38	-6.06	-8.54
2	0.213	0.11	52.75	-	52.86	-	63.11	53.11	-10.25	-
3	0.261	0.12	47.50	-	47.62	-	61.41	51.41	-13.80	-
4	0.591	0.15	44.49	-	44.64	-	56.00	46.00	-11.36	-
5	2.813	0.29	33.42	-	33.71	-	56.00	46.00	-22.29	-
6	13.984	0.97	31.24	-	32.21	-	60.00	50.00	-27.79	-

- REMARKS:**
1. Q.P. and AV. are abbreviations of quasi-peak and average individually.
 2. "-": The Quasi-peak reading value also meets average limit and measurement with the average detector is unnecessary.
 3. The emission levels of other frequencies were very low against the limit.
 4. Margin value = Emission level - Limit value
 5. Correction factor = Insertion loss + Cable loss
 6. Emission Level = Correction Factor + Reading Value.

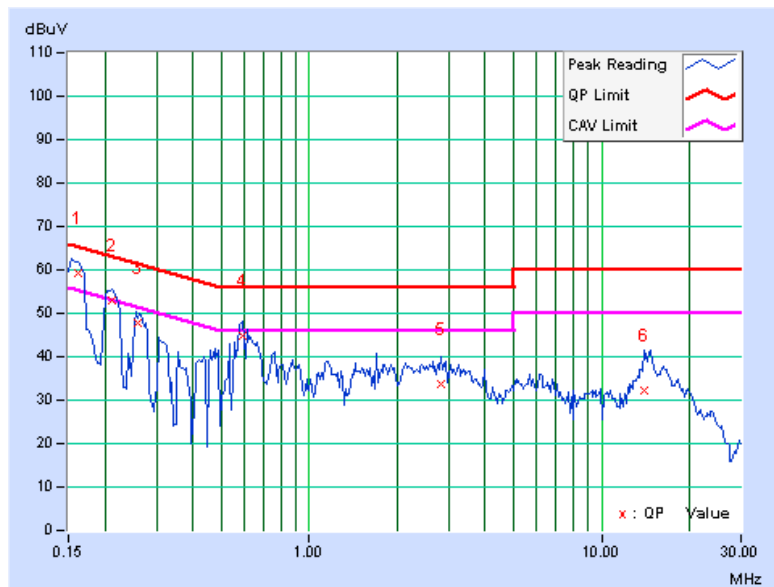



A D T

PHASE	Line 2	6dB BANDWIDTH	9kHz
TEST MODE	B		

No	Freq.	Corr.	Reading Value		Emission Level		Limit		Margin	
	[MHz]	Factor	[dB (uV)]		[dB (uV)]		[dB (uV)]		(dB)	
		(dB)	Q.P.	AV.	Q.P.	AV.	Q.P.	AV.	Q.P.	AV.
1	0.158	0.10	60.13	48.53	60.23	48.63	65.58	55.58	-5.35	-6.95
2	0.213	0.10	52.37	-	52.47	-	63.11	53.11	-10.64	-
3	0.261	0.11	46.48	-	46.59	-	61.41	51.41	-14.83	-
4	0.591	0.14	43.21	-	43.35	-	56.00	46.00	-12.65	-
5	3.121	0.28	32.33	-	32.61	-	56.00	46.00	-23.39	-
6	14.145	0.86	33.27	-	34.13	-	60.00	50.00	-25.87	-

- REMARKS:**
1. Q.P. and AV. are abbreviations of quasi-peak and average individually.
 2. "-": The Quasi-peak reading value also meets average limit and measurement with the average detector is unnecessary.
 3. The emission levels of other frequencies were very low against the limit.
 4. Margin value = Emission level - Limit value
 5. Correction factor = Insertion loss + Cable loss
 6. Emission Level = Correction Factor + Reading Value.

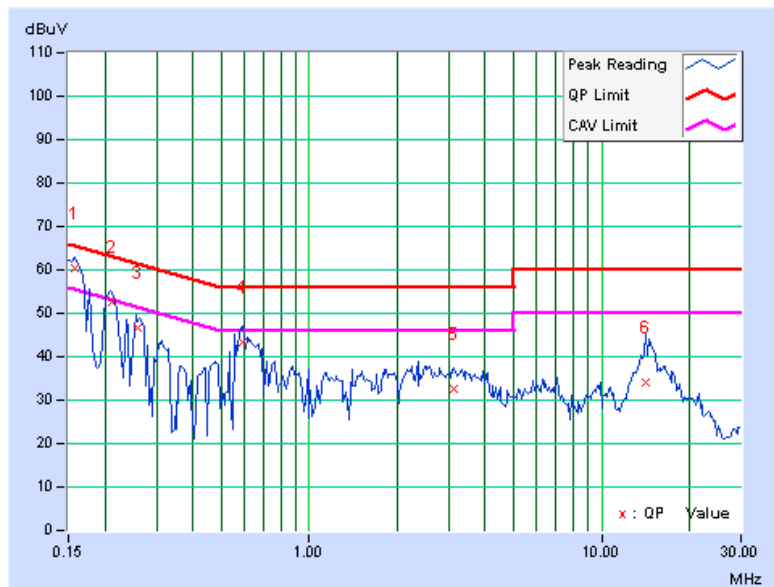



A D T

FOR FREQUENCY 5500MHz ~ 5700MHz

CONDUCTED WORST-CASE DATA : 802.11a

PHASE	Line 1	6dB BANDWIDTH	9kHz
TEST MODE	A		

No	Freq. [MHz]	Corr. Factor (dB)	Reading Value		Emission Level		Limit		Margin	
			[dB (uV)]		[dB (uV)]		[dB (uV)]		(dB)	
			Q.P.	AV.	Q.P.	AV.	Q.P.	AV.	Q.P.	AV.
1	0.158	0.12	46.60	-	46.72	-	65.58	55.58	-18.86	-
2	0.193	0.11	41.56	-	41.67	-	63.91	53.91	-22.24	-
3	0.248	0.11	34.43	-	34.54	-	61.84	51.84	-27.29	-
4	0.595	0.15	29.11	-	29.26	-	56.00	46.00	-26.74	-
5	5.434	0.42	29.99	-	30.41	-	60.00	50.00	-29.59	-
6	24.270	1.75	20.05	-	21.80	-	60.00	50.00	-38.20	-

- REMARKS:**
1. Q.P. and AV. are abbreviations of quasi-peak and average individually.
 2. "-": The Quasi-peak reading value also meets average limit and measurement with the average detector is unnecessary.
 3. The emission levels of other frequencies were very low against the limit.
 4. Margin value = Emission level - Limit value
 5. Correction factor = Insertion loss + Cable loss
 6. Emission Level = Correction Factor + Reading Value.

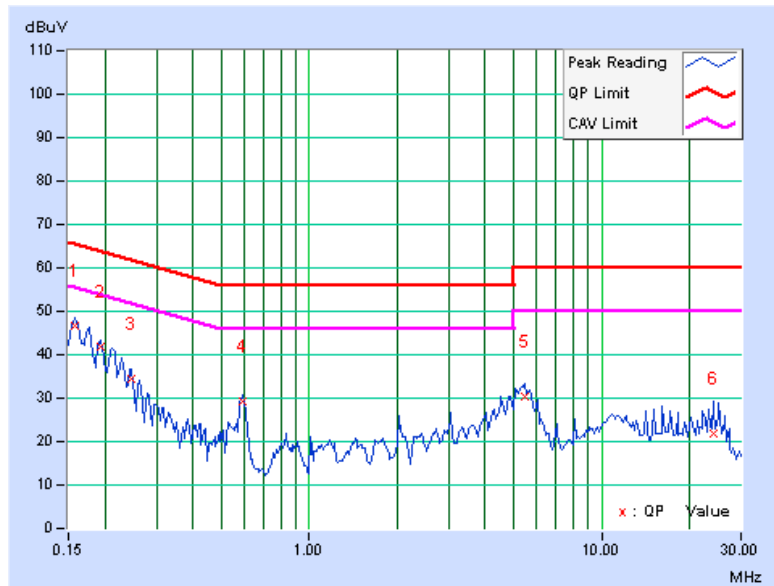



A D T

PHASE	Line 2	6dB BANDWIDTH	9kHz
TEST MODE	A		

No	Freq. [MHz]	Corr. Factor (dB)	Reading Value		Emission Level		Limit		Margin	
			[dB (uV)]		[dB (uV)]		[dB (uV)]		(dB)	
			Q.P.	AV.	Q.P.	AV.	Q.P.	AV.	Q.P.	AV.
1	0.158	0.10	46.47	-	46.57	-	65.58	55.58	-19.01	-
2	0.193	0.10	41.36	-	41.46	-	63.91	53.91	-22.45	-
3	0.248	0.10	34.85	-	34.95	-	61.84	51.84	-26.88	-
4	0.584	0.14	32.82	-	32.96	-	56.00	46.00	-23.04	-
5	5.434	0.38	33.54	-	33.92	-	60.00	50.00	-26.08	-
6	23.309	1.48	24.15	-	25.63	-	60.00	50.00	-34.37	-

- REMARKS:**
1. Q.P. and AV. are abbreviations of quasi-peak and average individually.
 2. "-": The Quasi-peak reading value also meets average limit and measurement with the average detector is unnecessary.
 3. The emission levels of other frequencies were very low against the limit.
 4. Margin value = Emission level - Limit value
 5. Correction factor = Insertion loss + Cable loss
 6. Emission Level = Correction Factor + Reading Value.

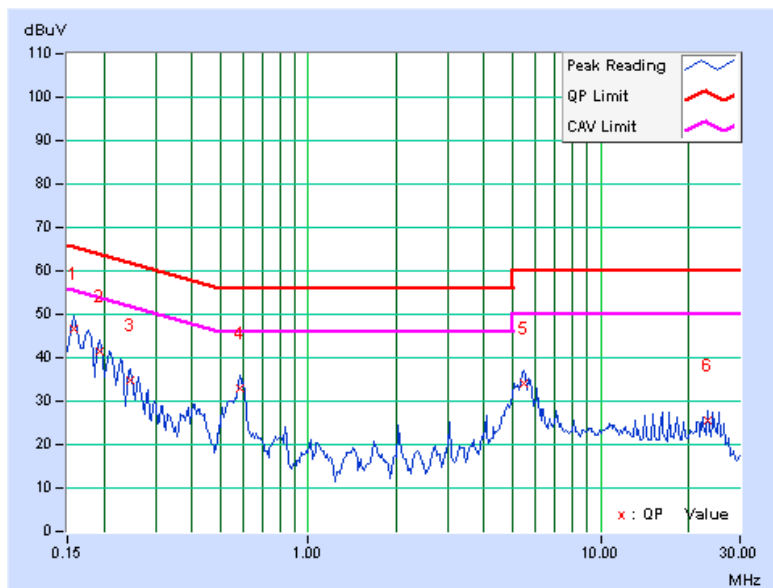



A D T

PHASE	Line 1	6dB BANDWIDTH	9kHz
TEST MODE	B		

No	Freq. [MHz]	Corr. Factor (dB)	Reading Value		Emission Level		Limit		Margin	
			[dB (uV)]		[dB (uV)]		[dB (uV)]		(dB)	
			Q.P.	AV.	Q.P.	AV.	Q.P.	AV.	Q.P.	AV.
1	0.158	0.12	59.63	48.65	59.75	48.77	65.58	55.58	-5.83	-6.81
2	0.213	0.11	52.59	-	52.70	-	63.11	53.11	-10.41	-
3	0.259	0.12	47.26	-	47.38	-	61.45	51.45	-14.08	-
4	0.603	0.15	43.90	-	44.05	-	56.00	46.00	-11.95	-
5	2.879	0.29	33.21	-	33.50	-	56.00	46.00	-22.50	-
6	14.816	1.04	30.56	-	31.60	-	60.00	50.00	-28.40	-

- REMARKS:**
1. Q.P. and AV. are abbreviations of quasi-peak and average individually.
 2. "-": The Quasi-peak reading value also meets average limit and measurement with the average detector is unnecessary.
 3. The emission levels of other frequencies were very low against the limit.
 4. Margin value = Emission level - Limit value
 5. Correction factor = Insertion loss + Cable loss
 6. Emission Level = Correction Factor + Reading Value.

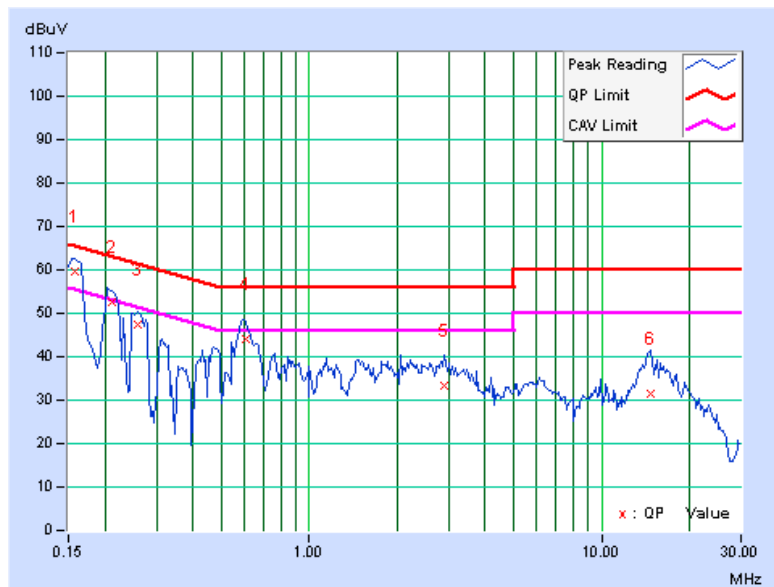



A D T

PHASE	Line 2	6dB BANDWIDTH	9kHz
TEST MODE	B		

No	Freq. [MHz]	Corr. Factor (dB)	Reading Value		Emission Level		Limit		Margin	
			[dB (uV)]		[dB (uV)]		[dB (uV)]		(dB)	
			Q.P.	AV.	Q.P.	AV.	Q.P.	AV.	Q.P.	AV.
1	0.158	0.10	59.83	48.04	59.93	48.14	65.58	55.58	-5.65	-7.44
2	0.213	0.10	52.25	-	52.35	-	63.11	53.11	-10.76	-
3	0.263	0.11	46.01	-	46.12	-	61.33	51.33	-15.21	-
4	0.599	0.14	43.40	-	43.54	-	56.00	46.00	-12.46	-
5	3.387	0.30	30.86	-	31.16	-	56.00	46.00	-24.84	-
6	14.711	0.90	37.60	-	38.50	-	60.00	50.00	-21.50	-

- REMARKS:**
1. Q.P. and AV. are abbreviations of quasi-peak and average individually.
 2. "-": The Quasi-peak reading value also meets average limit and measurement with the average detector is unnecessary.
 3. The emission levels of other frequencies were very low against the limit.
 4. Margin value = Emission level - Limit value
 5. Correction factor = Insertion loss + Cable loss
 6. Emission Level = Correction Factor + Reading Value.

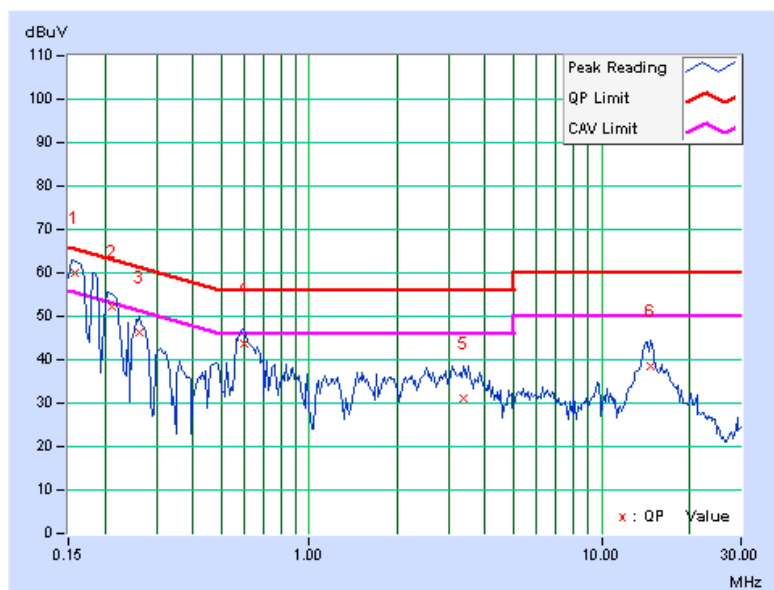



4.3 MAXIMUM CONDUCTED OUTPUT POWER MEASUREMENT

4.3.1 LIMITS OF MAXIMUM CONDUCTED OUTPUT POWER MEASUREMENT

FREQUENCY BAND	LIMIT
5.250 ~ 5.350GHz	The lesser of 250mW (24dBm) or 11dBm + 10logB
5.470 ~ 5.725GHz	The lesser of 250mW (24dBm) or 11dBm + 10logB

NOTE: Where B is the 26dB emission bandwidth in MHz.

4.3.2 TEST INSTRUMENTS

DESCRIPTION & MANUFACTURER	MODEL NO.	SERIAL NO.	DATE OF CALIBRATION	DUE DATE OF CALIBRATION
SPECTRUM ANALYZER	FSP40	100039	Jan. 11, 2010	Jan. 10, 2011

NOTE: The calibration interval of the above test instruments is 12 months and the calibrations are traceable to NML/ROC and NIST/USA.

4.3.3 TEST PROCEDURE

1. Follow DTS measurement (Power Output Option 2), the transmitter output was connected to the spectrum analyzer through an attenuator, the bandwidth of the fundamental frequency was measured with the spectrum analyzer.
2. Set span to encompass the entire emission bandwidth (EBW) of the signal.
3. Set RBW = 1 MHz ;VBW \geq 3 MHz.
4. Use sample detector mode and video trigger with the trigger level set to enable triggering only on full power pulses.
5. Trace average 100 traces in power averaging mode.
6. Compute power by integrating the spectrum across the 26 dB EBW of the signal.
7. Record the power level.

4.3.4 DEVIATION FROM TEST STANDARD

No deviation

4.3.5 TEST SETUP

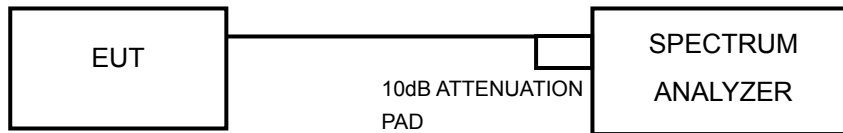

4.3.6 EUT OPERATING CONDITIONS

The software provided by client to enable the EUT under transmission condition continuously at specific channel frequencies individually.



A D T

4.3.7 TEST RESULTS

POWER OUTPUT: 802.11a

CHAN.	CHAN. FREQ. (MHz)	POWER OUTPUT (dBm)		TOTAL POWER (mW)	TOTAL POWER (dBm)	POWER LIMIT (dBm)	PASS / FAIL
		CHAIN 0	CHAIN 1				
52	5260	19.1	19.6	172.5	22.4	24	PASS
60	5300	19.8	19.2	178.7	22.5	24	PASS
64	5320	19.7	19.5	182.5	22.6	24	PASS
100	5500	17.7	17.6	116.4	20.7	24	PASS
116	5580	15.8	16.5	82.7	19.2	24	PASS
136	5680	16.0	16.0	79.6	19.0	24	PASS
140	5700	16.3	16.1	83.4	19.2	24	PASS

FOR CHAIN 0: CH 60

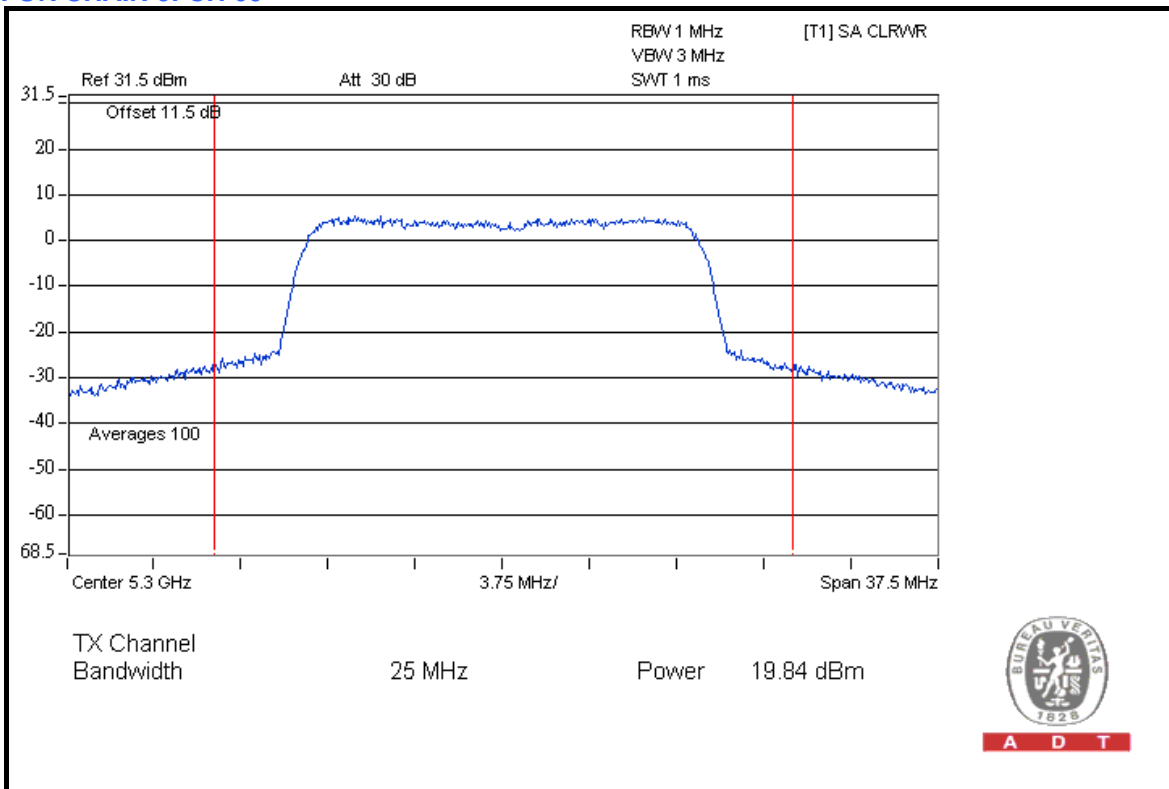

A D T



A D T

802.11n (20MHz)

CHAN.	CHAN. FREQ. (MHz)	POWER OUTPUT (dBm)		TOTAL POWER (mW)	TOTAL POWER (dBm)	POWER LIMIT (dBm)	PASS / FAIL
		CHAIN 0	CHAIN 1				
52	5260	19.6	19.5	180.1	22.6	24	PASS
60	5300	19.6	19.3	176.3	22.5	24	PASS
64	5320	18.4	19.2	152.4	21.8	24	PASS
100	5500	17.6	17.5	113.8	20.6	24	PASS
116	5580	16.2	16.1	82.4	19.2	24	PASS
136	5680	15.8	16.1	78.8	19.0	24	PASS
140	5700	16.5	16.3	87.3	19.4	24	PASS

FOR CHAIN 0: CH 60

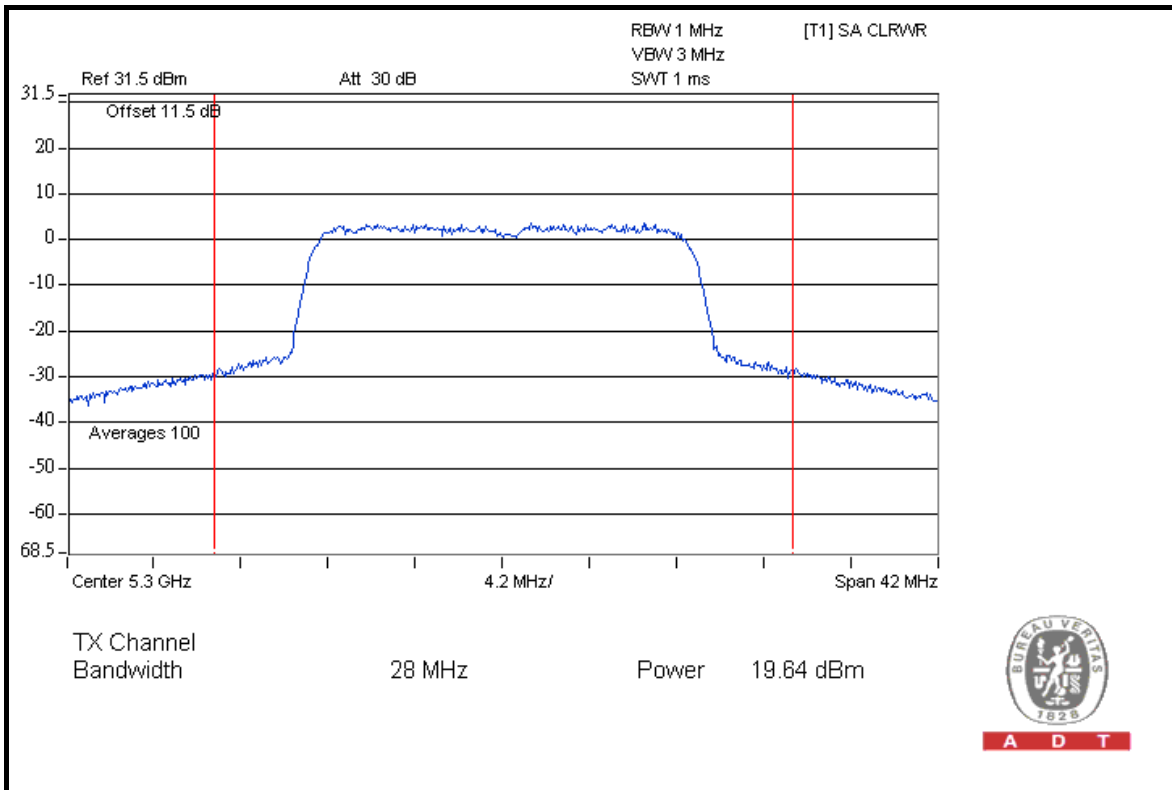

A D T



A D T

802.11n (40MHz)

CHAN.	CHAN. FREQ. (MHz)	POWER OUTPUT (dBm)		TOTAL POWER (mW)	TOTAL POWER (dBm)	POWER LIMIT (dBm)	PASS / FAIL
		CHAIN 0	CHAIN 1				
54	5270	19.8	19.3	180.6	22.6	24	PASS
62	5310	15.5	14.6	64.3	18.1	24	PASS
102	5510	13.3	13.1	41.8	16.2	24	PASS
110	5550	19.3	19.0	164.5	22.2	24	PASS

FOR CHAIN 0: CH 54

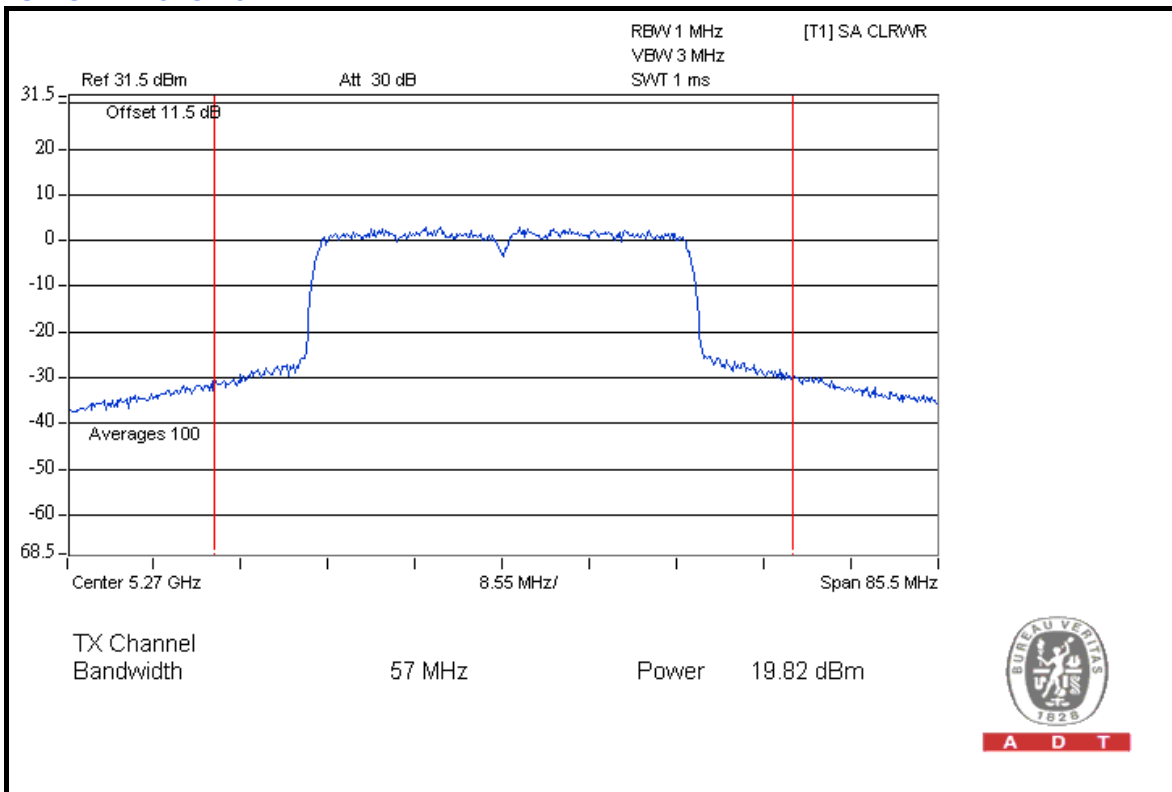

A D T



A D T

26dB OCCUPIED BANDWIDTH: 802.11a

CHANNEL	CHANNEL FREQUENCY (MHz)	26dBc OCCUPIED BANDWIDTH (MHz)		PASS / FAIL
		CHAIN 0	CHAIN 1	
52	5260	26.46	27.64	PASS
60	5300	26.56	25.88	PASS
64	5320	26.00	27.58	PASS
100	5500	25.88	25.32	PASS
116	5580	25.51	23.79	PASS
136	5680	25.67	25.60	PASS
140	5700	25.54	25.02	PASS

FOR CHAIN 1: CH 52

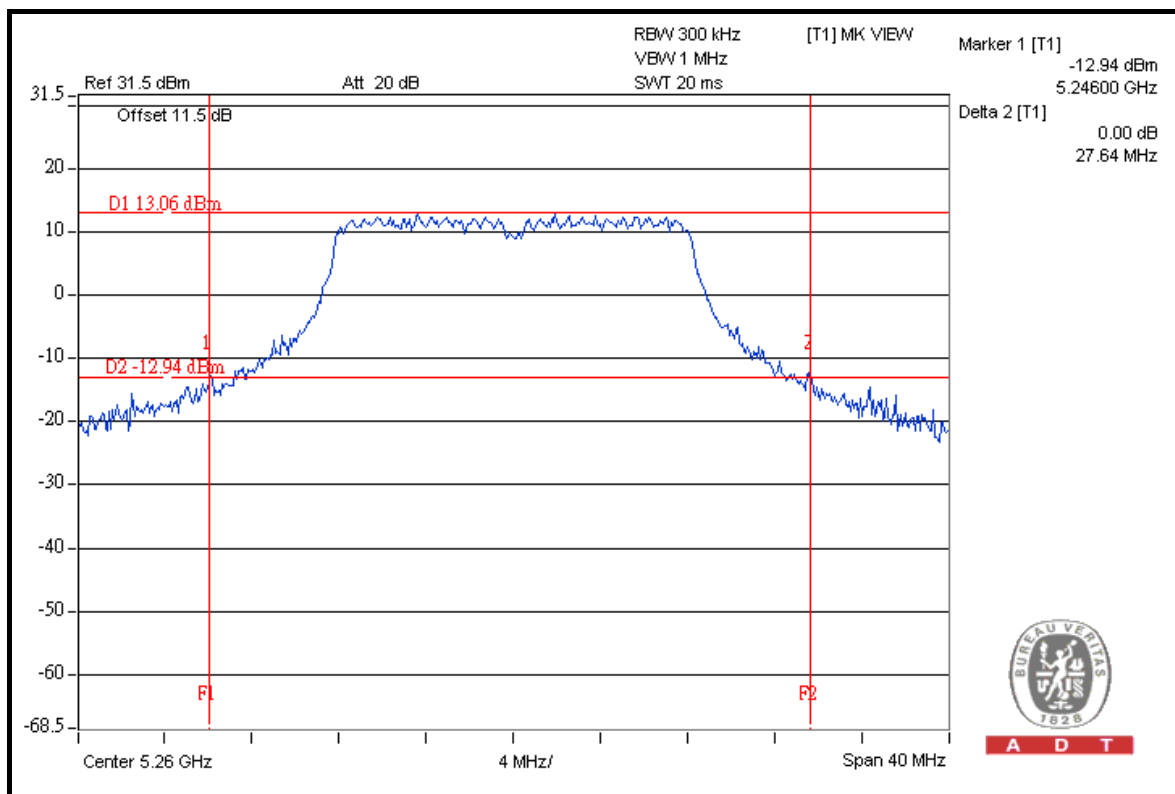



A D T

802.11n (20MHz)

CHANNEL	CHANNEL FREQUENCY (MHz)	26dBc OCCUPIED BANDWIDTH (MHz)		PASS / FAIL
		CHAIN 0	CHAIN 1	
52	5260	26.34	25.27	PASS
60	5300	25.81	26.26	PASS
64	5320	26.37	26.19	PASS
100	5500	25.64	24.36	PASS
116	5580	25.24	24.63	PASS
136	5680	24.88	25.25	PASS
140	5700	25.32	24.75	PASS

FOR CHAIN 0: CH 64

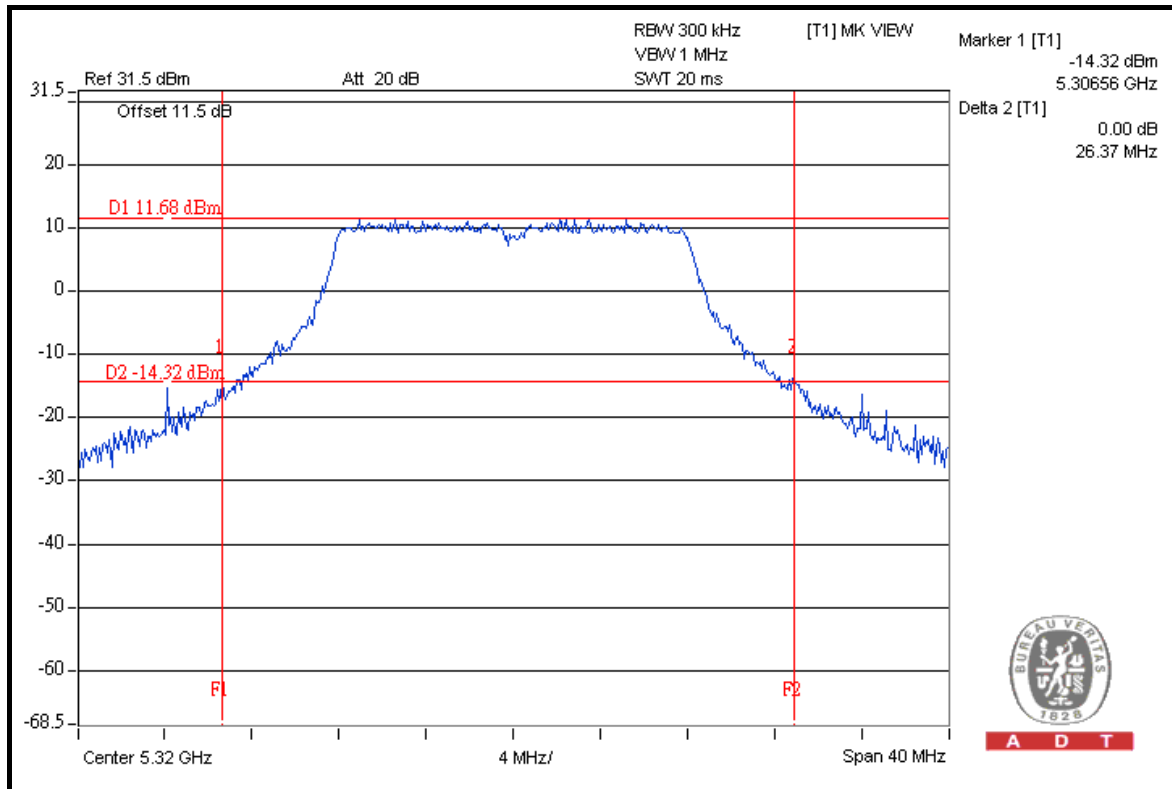



A D T

802.11n (40MHz)

CHANNEL	CHANNEL FREQUENCY (MHz)	26dBc OCCUPIED BANDWIDTH (MHz)		PASS / FAIL
		CHAIN 0	CHAIN 1	
54	5270	55.94	65.17	PASS
62	5310	48.78	48.06	PASS
102	5510	48.62	49.19	PASS
110	5550	64.53	48.92	PASS

FOR CHAIN 1: CH 54

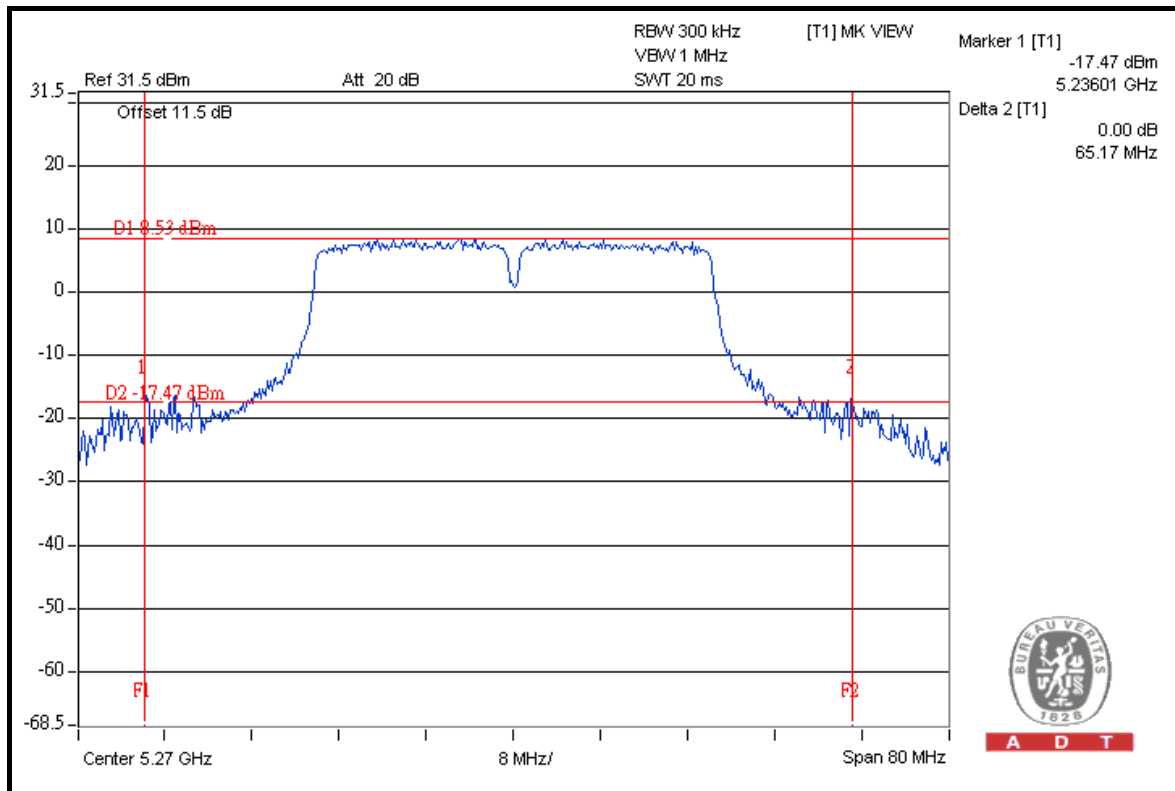



4.4 PEAK POWER EXCURSION MEASUREMENT

4.4.1 LIMITS OF PEAK POWER EXCURSION MEASUREMENT

FREQUENCY BAND	LIMIT
5.250 ~ 5.350GHz	13dB
5.470 ~ 5.725GHz	13dB

4.4.2 TEST INSTRUMENTS

DESCRIPTION & MANUFACTURER	MODEL NO.	SERIAL NO.	DATE OF CALIBRATION	DUE DATE OF CALIBRATION
SPECTRUM ANALYZER	FSP40	100039	Jan. 11, 2010	Jan. 10, 2011

NOTE: The calibration interval of the above test instruments is 12 months and the calibrations are traceable to NML/ROC and NIST/USA.

4.4.3 TEST PROCEDURE

- a. The transmitter output was connected to the spectrum analyzer.
- b. Set the spectrum bandwidth span to view the entire spectrum.
- c. Using peak detector and Max-hold function for Trace 1 (RB = 1MHz, VB = 3MHz) and 2 (RB = 1MHz, VB = 300kHz).
- d. The differences between Trace1 and Trace 2 in any 1MHz band at f1 to f2 range were recorded and showed to another trace.

4.4.4 DEVIATION FROM TEST STANDARD

No deviation

4.4.5 TEST SETUP

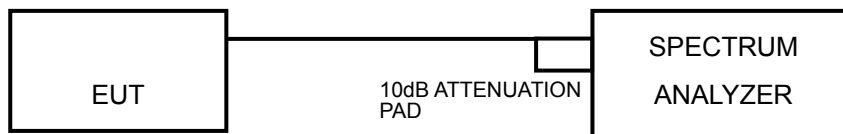

4.4.6 EUT OPERATING CONDITIONS

The software provided by client to enable the EUT under transmission condition continuously at specific channel frequencies individually.



A D T

4.4.7 TEST RESULTS

802.11a

CHANNEL	CHANNEL FREQUENCY (MHz)	PEAK POWER EXCURSION (dB)		PEAK to AVERAGE EXCURSION LIMIT (dB)	PASS/FAIL
		CHAIN 0	CHAIN 1		
52	5260	10.12	8.51	13	PASS
60	5300	8.49	8.59	13	PASS
64	5320	9.72	8.29	13	PASS
100	5500	9.17	8.12	13	PASS
116	5580	8.73	9.11	13	PASS
136	5680	9.06	8.26	13	PASS
140	5700	9.45	8.49	13	PASS



A D T

FOR CHAIN 0: CH 52

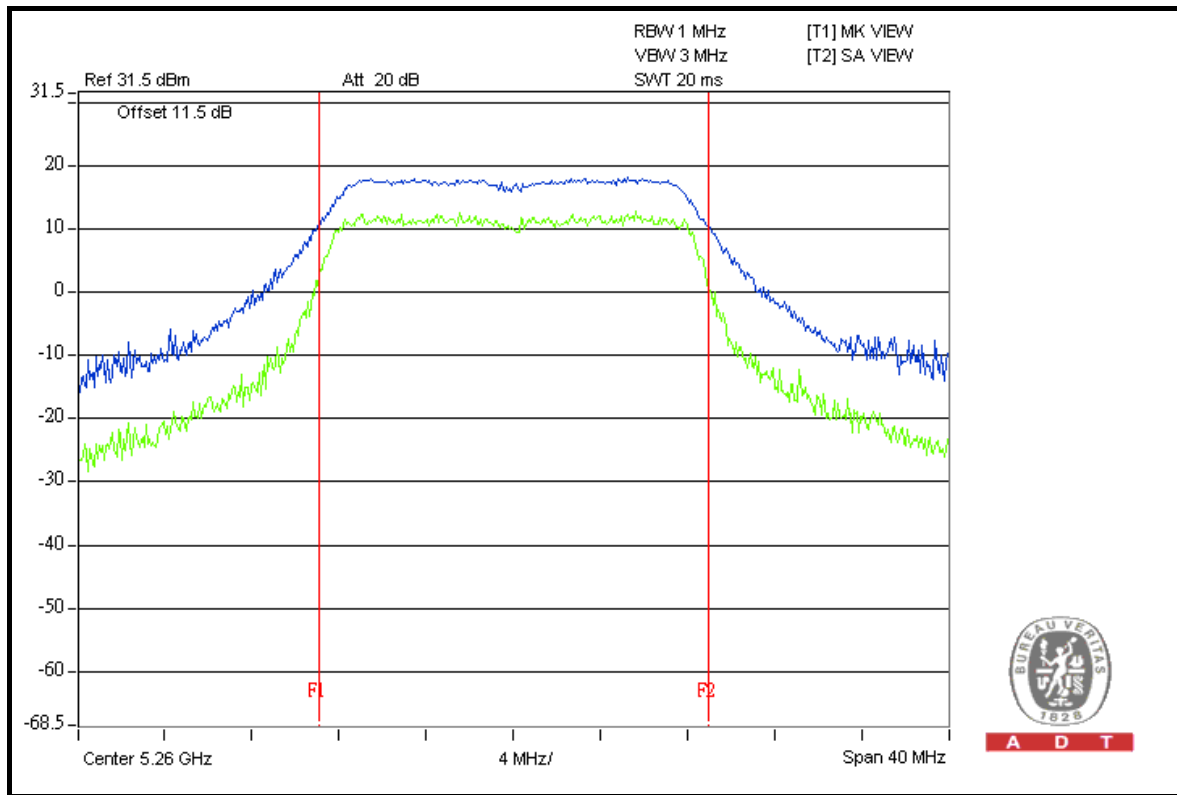

A D T

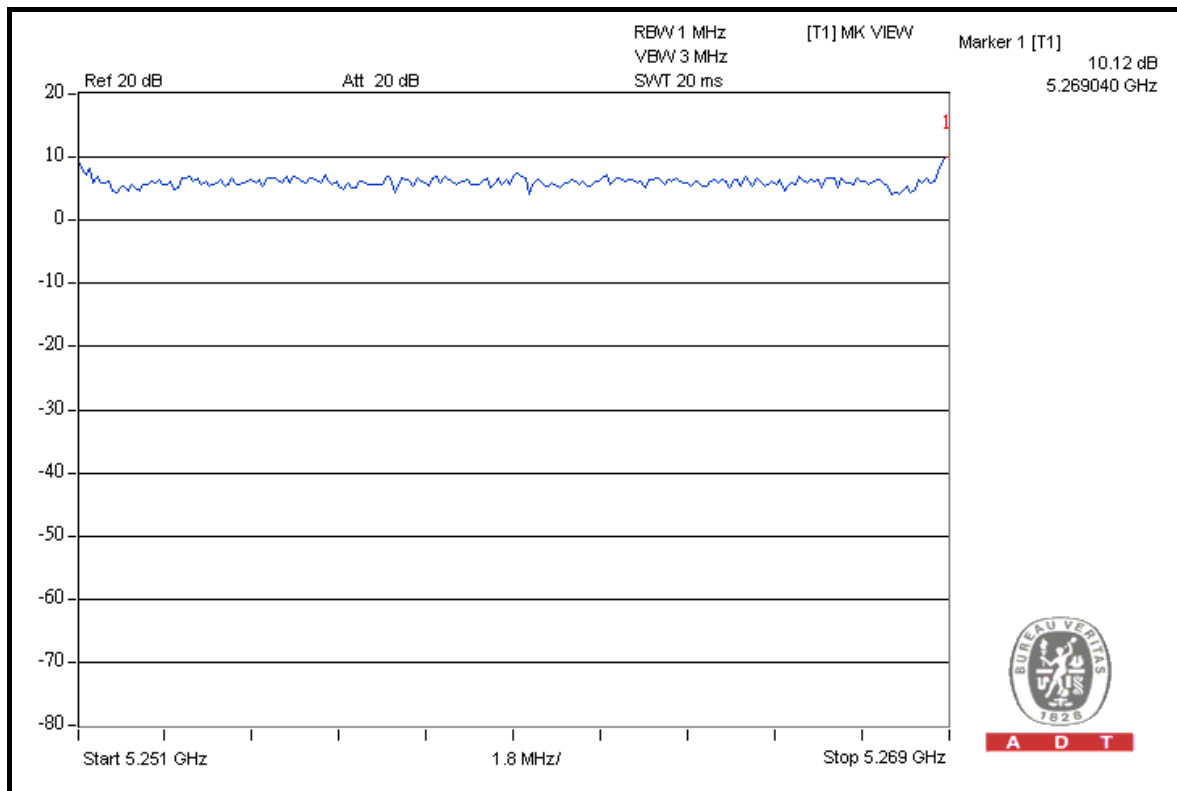

A D T



A D T

802.11n (20MHz)

CHANNEL	CHANNEL FREQUENCY (MHz)	PEAK POWER EXCURSION (dB)		PEAK to AVERAGE EXCURSION LIMIT (dB)	PASS/FAIL
		CHAIN 0	CHAIN 1		
52	5260	9.11	8.58	13	PASS
60	5300	9.29	9.05	13	PASS
64	5320	9.38	8.20	13	PASS
100	5500	9.86	9.21	13	PASS
116	5580	9.68	8.23	13	PASS
136	5680	8.32	9.58	13	PASS
140	5700	8.94	8.94	13	PASS



A D T

FOR CHAIN 0: CH 100

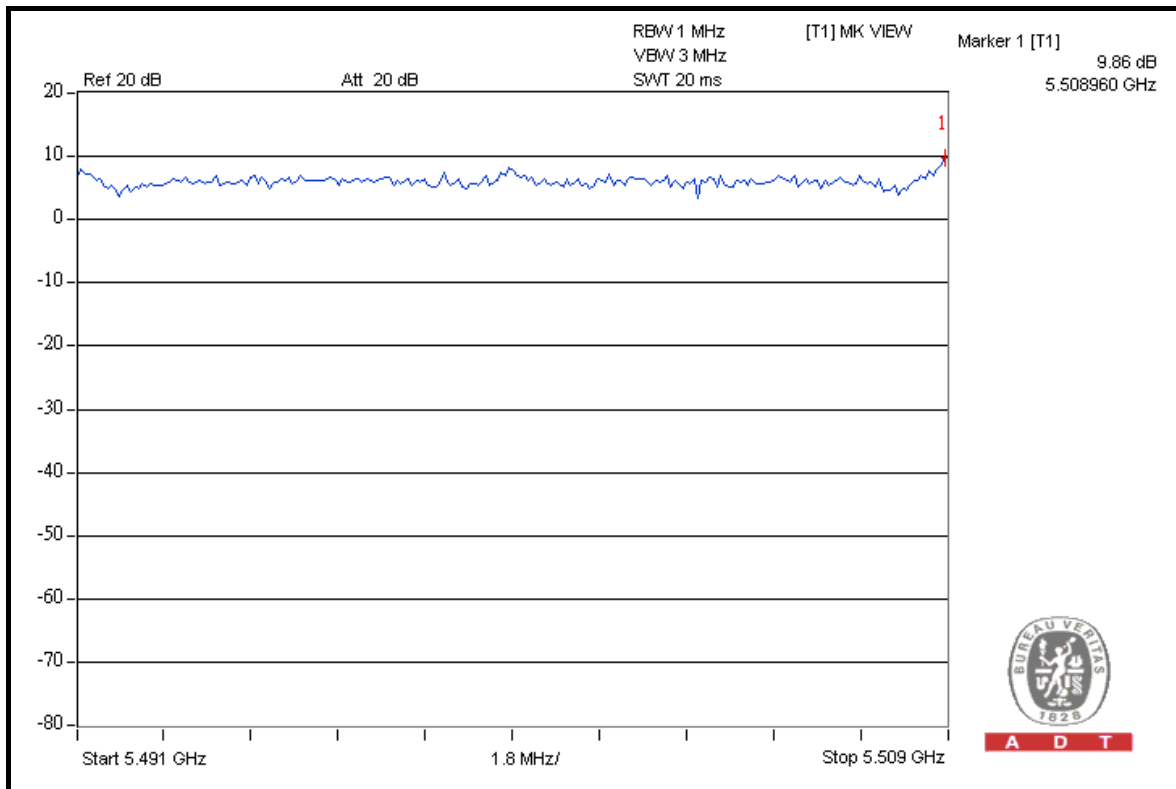
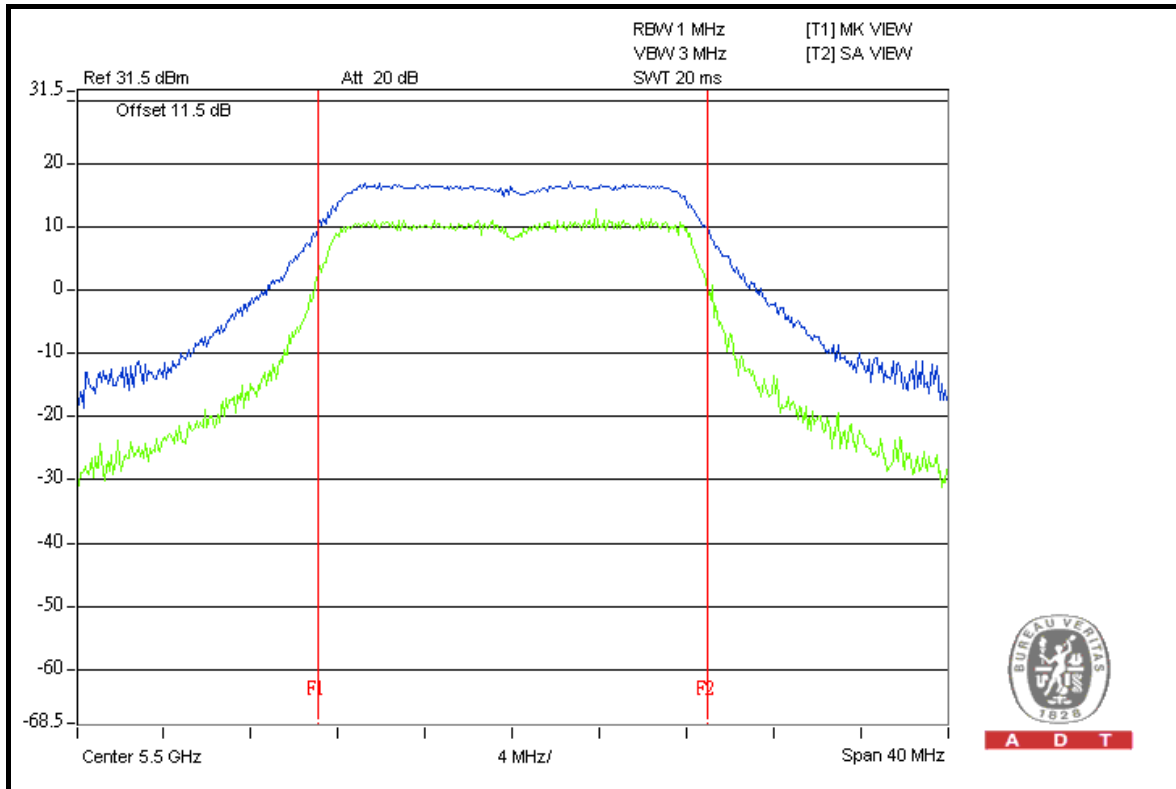



A D T

802.11n (40MHz)

CHANNEL	CHANNEL FREQUENCY (MHz)	PEAK POWER EXCURSION (dB)		PEAK to AVERAGE EXCURSION LIMIT (dB)	PASS/FAIL
		CHAIN 0	CHAIN 1		
54	5270	9.74	9.85	13	PASS
62	5310	8.28	10.34	13	PASS
102	5510	8.48	9.48	13	PASS
110	5550	9.40	10.66	13	PASS



A D T

FOR CHAIN 1: CH 110

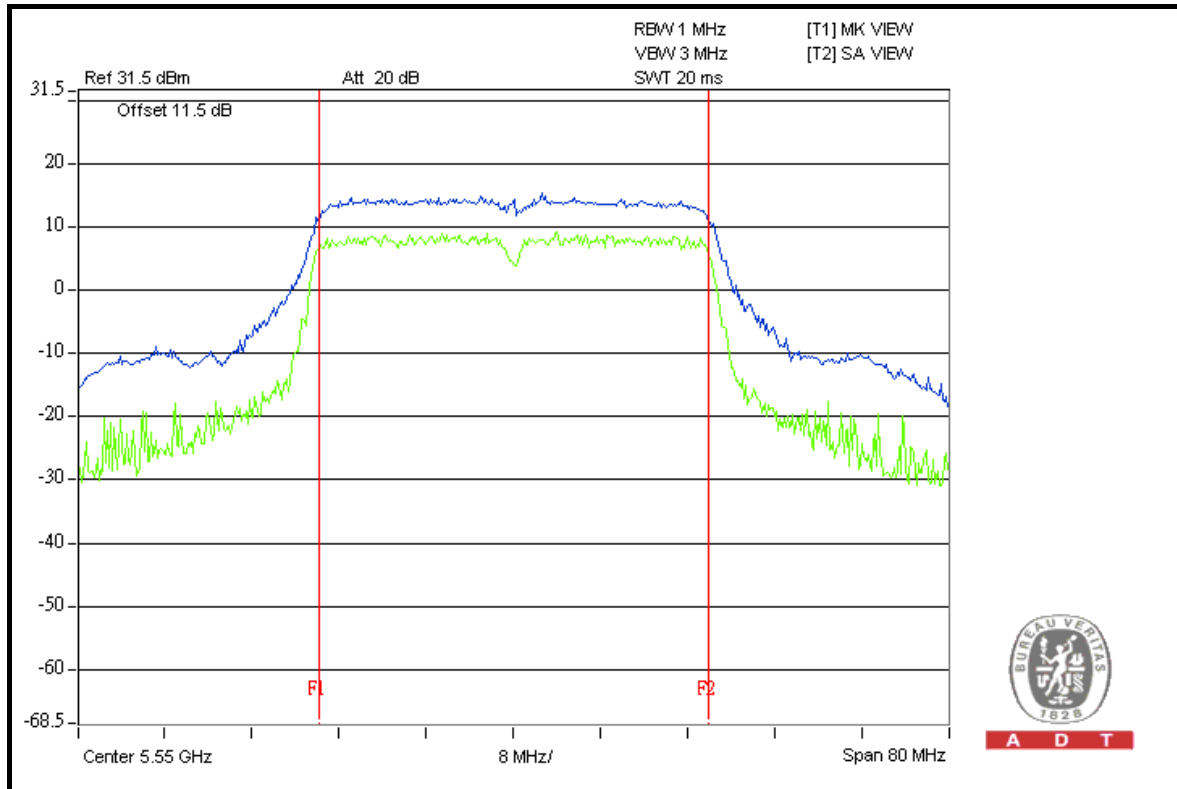

A D T

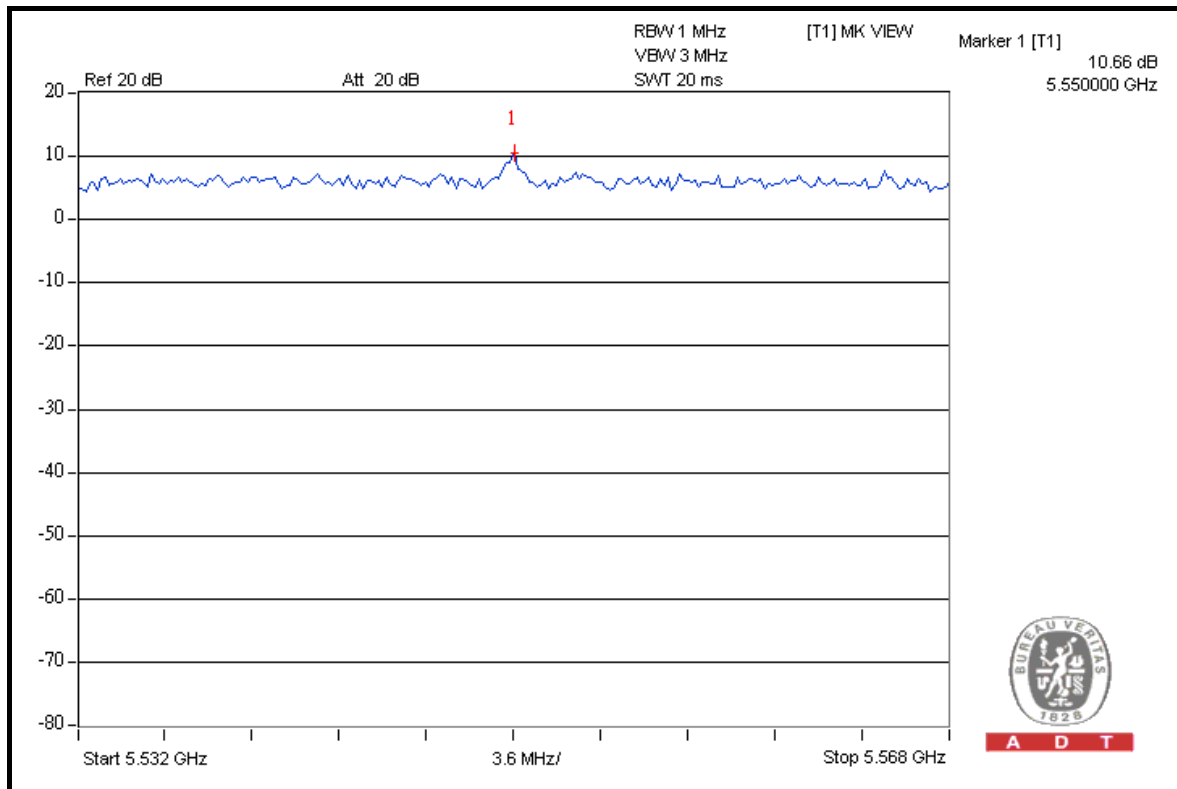

A D T



A D T

4.5 PEAK POWER SPECTRAL DENSITY MEASUREMENT

4.5.1 LIMITS OF PEAK POWER SPECTRAL DENSITY MEASUREMENT

FREQUENCY BAND	LIMIT
5.15 ~ 5.25GHz	4dBm
5.250 ~ 5.350GHz	11dBm
5.470 ~ 5.725GHz	11dBm

4.5.2 TEST INSTRUMENTS

DESCRIPTION & MANUFACTURER	MODEL NO.	SERIAL NO.	DATE OF CALIBRATION	DUE DATE OF CALIBRATION
SPECTRUM ANALYZER	FSP40	100039	Jan. 11, 2010	Jan. 10, 2011

NOTE: The calibration interval of the above test instruments is 12 months and the calibrations are traceable to NML/ROC and NIST/USA.

4.5.3 TEST PROCEDURES

- a. The transmitter output was connected to the spectrum analyzer.
- b. Set RBW = 1MHz, VBW = 3MHz. The PPSD is the highest level found across the emission in any 1MHz band.

4.5.4 DEVIATION FROM TEST STANDARD

No deviation

4.5.5 TEST SETUP

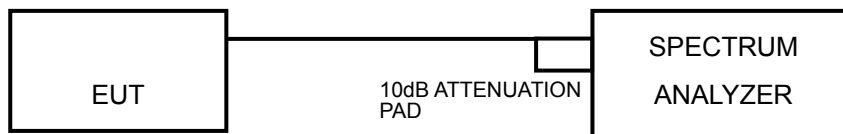

4.5.6 EUT OPERATING CONDITIONS

Same as 5.3.6



A D T

4.5.7 TEST RESULTS

802.11a

CHAN.	CHAN. FREQ. (MHz)	RF POWER LEVEL IN 3kHz BW (dBm)		TOTAL POWER DENSITY (dBm)	MAX. LIMIT (dBm)	PASS / FAIL
		CHAIN 0	CHAIN 1			
52	5260	6.7	7.6	10.2	11	PASS
60	5300	7.1	7.2	10.2	11	PASS
64	5320	6.6	7.6	10.1	11	PASS
100	5500	4.9	5.5	8.2	11	PASS
116	5580	3.9	4.4	7.2	11	PASS
136	5680	3.1	3.9	6.5	11	PASS
140	5700	3.7	4.2	7.0	11	PASS

FOR CHAIN 1: CH 64

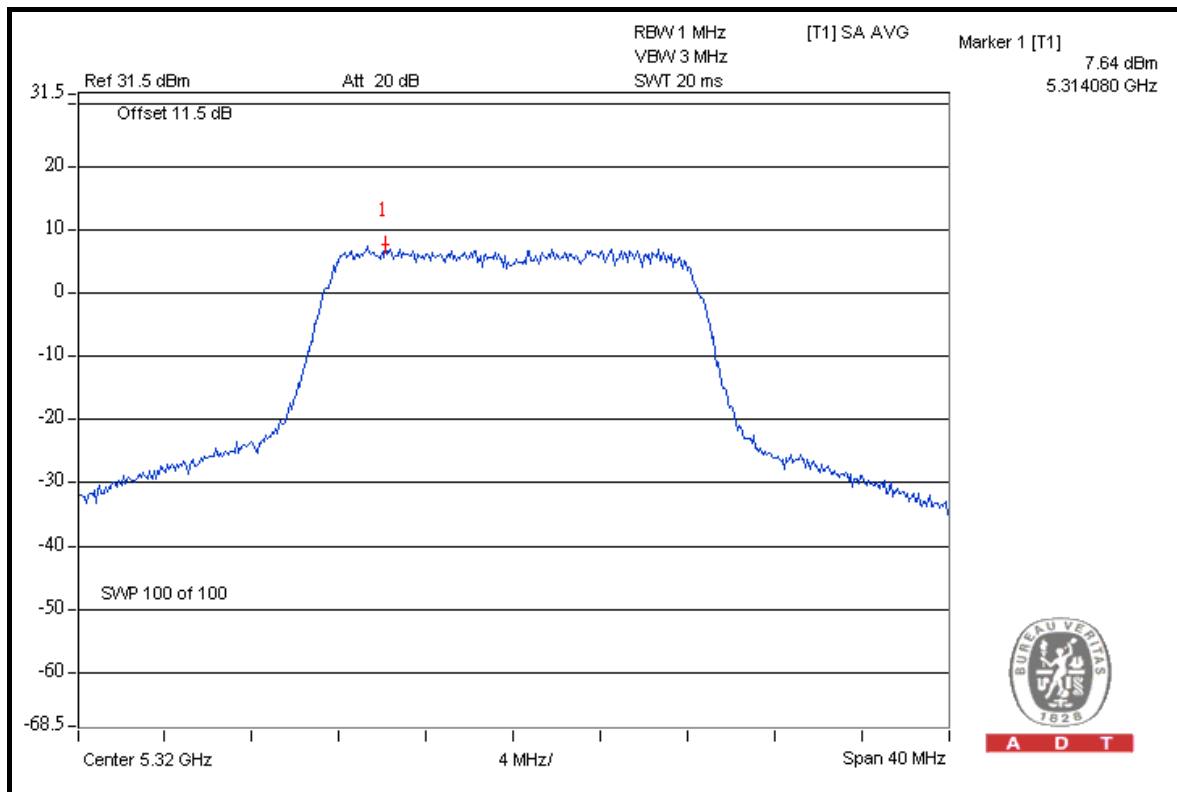

A D T



A D T

802.11n (20MHz)

CHAN.	CHAN. FREQ. (MHz)	RF POWER LEVEL IN 3kHz BW (dBm)		TOTAL POWER DENSITY (dBm)	MAX. LIMIT (dBm)	PASS / FAIL
		CHAIN 0	CHAIN 1			
52	5260	7.8	7.4	10.6	11	PASS
60	5300	7.7	7.3	10.5	11	PASS
64	5320	6.5	7.3	9.9	11	PASS
100	5500	5.8	5.3	8.6	11	PASS
116	5580	4.3	3.9	7.1	11	PASS
136	5680	4.0	4.0	7.0	11	PASS
140	5700	4.7	4.3	7.5	11	PASS

FOR CHAIN 0: CH 52

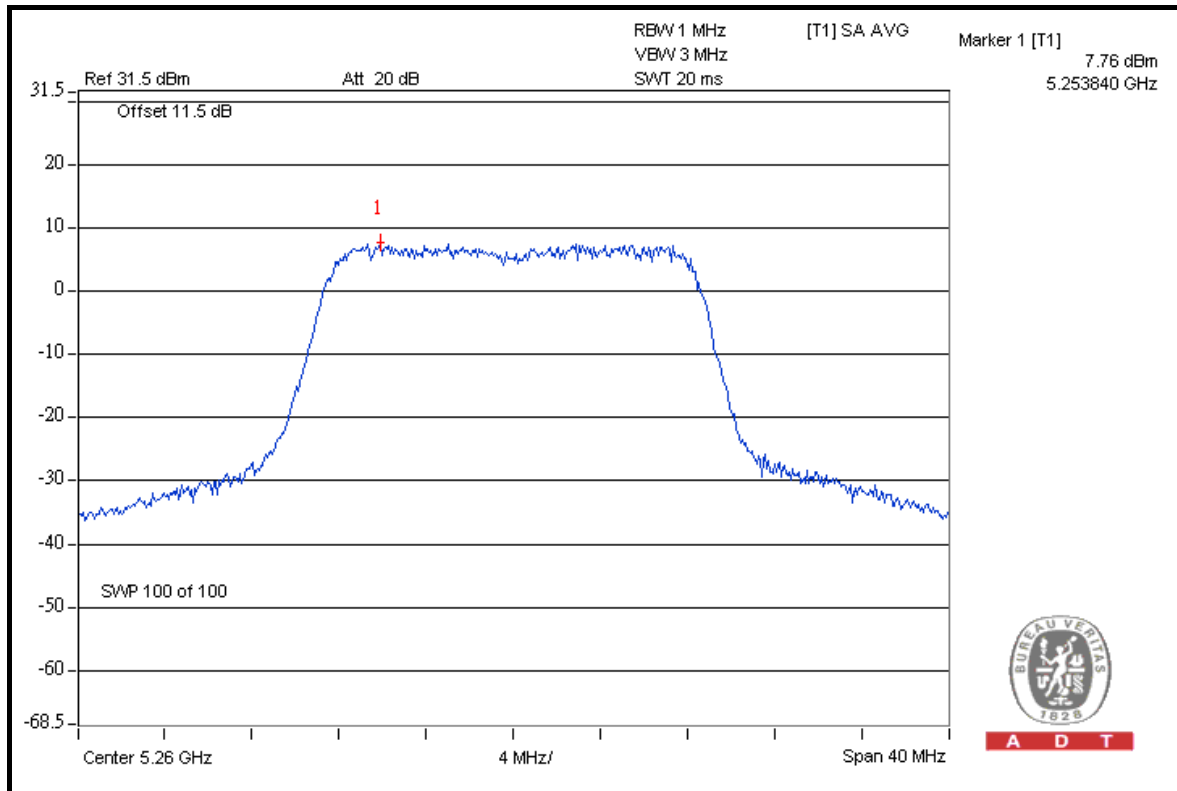

A D T



A D T

802.11n (40MHz)

CHAN.	CHAN. FREQ. (MHz)	RF POWER LEVEL IN 3kHz BW (dBm)		TOTAL POWER DENSITY (dBm)	MAX. LIMIT (dBm)	PASS / FAIL
		CHAIN 0	CHAIN 1			
54	5270	4.3	3.6	7.0	11	PASS
62	5310	-0.4	-1.2	2.2	11	PASS
102	5510	-2.0	-2.7	0.7	11	PASS
110	5550	3.9	3.4	6.7	11	PASS

FOR CHAIN 0: CH 54

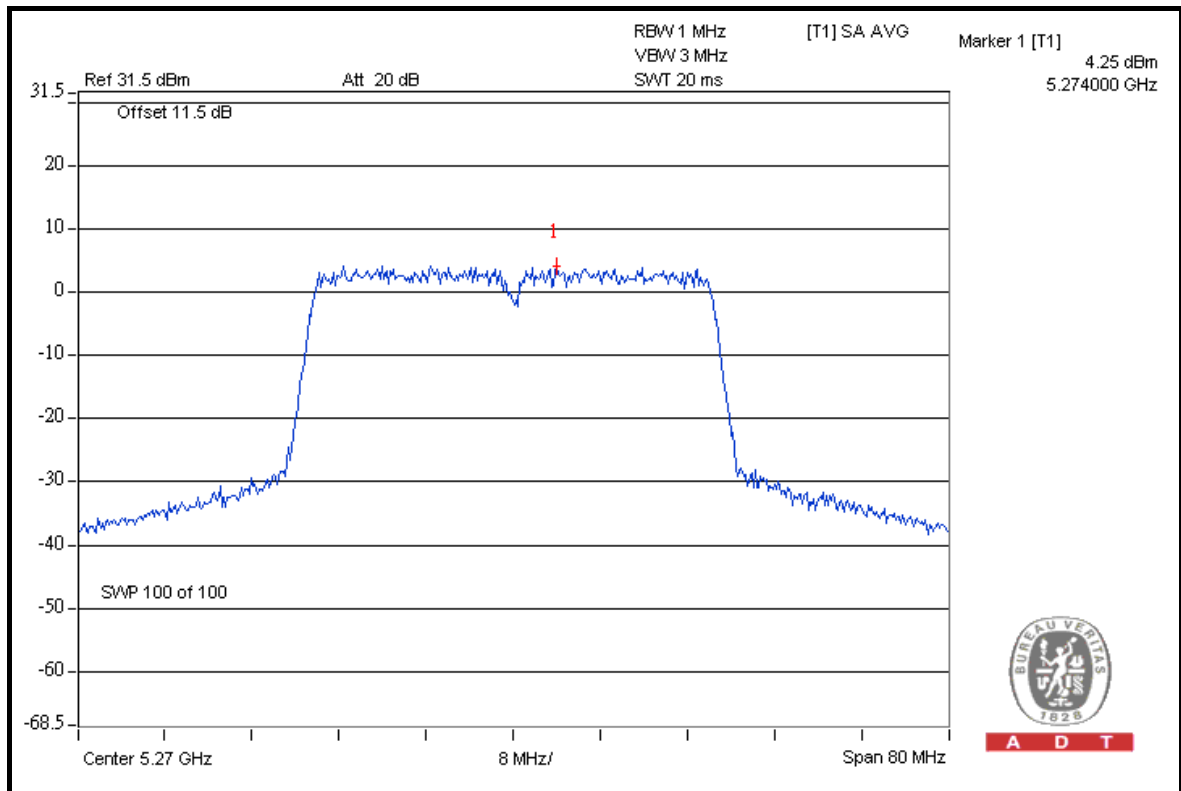



4.6 FREQUENCY STABILITY

4.6.1 LIMITS OF FREQUENCY STABILITY MEASUREMENT

The frequency tolerance of the carrier signal shall be maintained within +/- 0.02% of the operating frequency over a temperature variation of -30 degrees to 50 degrees C at normal supply voltage, and for a variation in the primary supply voltage from 85% to 115% of the rated supply voltage at a temperature of 20 degrees C.

4.6.2 TEST INSTRUMENTS

DESCRIPTION & MANUFACTURER	MODEL NO.	SERIAL NO.	DATE OF CALIBRATION	CALIBRATED UNTIL
R&S SPECTRUM ANALYZER	FSP40	100039	Jan. 11, 2010	Jan. 10, 2011
WIT STANDARD TEMPERATURE AND HUMIDITY CHAMBER	TH-4S-C	W981030	Jun. 28, 2010	Jun. 27, 2011

NOTE: The calibration interval of the above test instruments is 12 months and the calibrations are traceable to NML/ROC and NIST/USA.

4.6.3 TEST PROCEDURE

- a. The EUT was placed inside the environmental test chamber and powered by nominal DC voltage.
- b. Turn the EUT on and couple its output to a spectrum analyzer.
- c. Turn the EUT off and set the chamber to the highest temperature specified.
- d. Allow sufficient time (approximately 30 min) for the temperature of the chamber to stabilize, turn the EUT on and measure the operating frequency after 2, 5, and 10 minutes.
- e. Repeat step 2 and 3 with the temperature chamber set to the lowest temperature.
- f. The test chamber was allowed to stabilize at +20 degree C for a minimum of 30 minutes. The supply voltage was then adjusted on the EUT from 85% to 115% and the frequency record.

4.6.4 DEVIATION FROM TEST STANDARD

No deviation

4.6.5 TEST SETUP

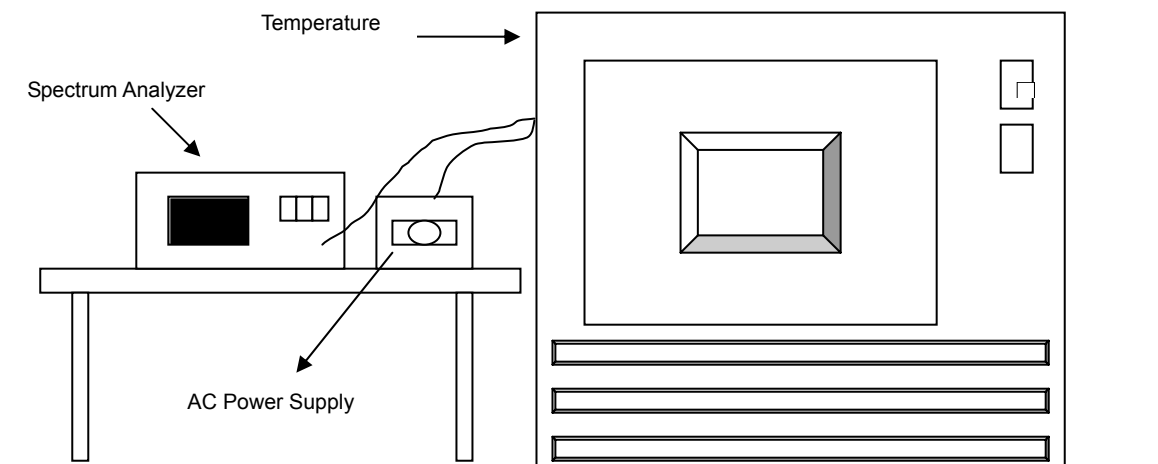

4.6.6 EUT OPERATING CONDITION

Same as Item 4.1.6



A D T

4.6.7 TEST RESULTS

FREQUENCY STABILITY VERSUS TEMP.									
OPERATING FREQUENCY: 5320MHz									
TEMP. (°C)	POWER SUPPLY (Vdc)	0 MINUTE		2 MINUTE		5 MINUTE		10 MINUTE	
		Measured Frequency	Frequency Drift	Measured Frequency	Frequency Drift	Measured Frequency	Frequency Drift	Measured Frequency	Frequency Drift
		(MHz)	ppm	(MHz)	ppm	(MHz)	ppm	(MHz)	ppm
55	110.0	5319.988024	-2.251	5319.988175	-2.223	5319.988396	-2.181	5319.987995	-2.257
50	110.0	5319.988404	-2.180	5319.988393	-2.182	5319.988006	-2.255	5319.988067	-2.243
40	110.0	5319.988466	-2.168	5319.988290	-2.201	5319.987977	-2.260	5319.988631	-2.137
30	110.0	5319.989822	-1.913	5319.989738	-1.929	5319.989618	-1.952	5319.990062	-1.868
20	110.0	5319.991008	-1.690	5319.990817	-1.726	5319.991404	-1.616	5319.990996	-1.692
10	110.0	5319.993184	-1.281	5319.992596	-1.392	5319.992937	-1.328	5319.993084	-1.300
0	110.0	5319.991193	-1.655	5319.990993	-1.693	5319.991430	-1.611	5319.990882	-1.714
-10	110.0	5319.989814	-1.915	5319.989611	-1.953	5319.989425	-1.988	5319.989939	-1.891
-20	110.0	5319.989362	-2.000	5319.989261	-2.019	5319.989175	-2.035	5319.989377	-1.997
-30	110.0	5319.988403	-2.180	5319.988708	-2.123	5319.988301	-2.199	5319.988520	-2.158

FREQUENCY STABILITY VERSUS VOLTAGE									
OPERATING FREQUENCY: 5320MHz									
TEMP. (°C)	POWER SUPPLY (Vac)	0 MINUTE		2 MINUTE		5 MINUTE		10 MINUTE	
		Measured Frequency	Frequency Drift	Measured Frequency	Frequency Drift	Measured Frequency	Frequency Drift	Measured Frequency	Frequency Drift
		(MHz)	ppm	(MHz)	ppm	(MHz)	ppm	(MHz)	ppm
20	93.5	5319.991452	-1.607	5319.991531	-1.592	5319.991823	-1.537	5319.991753	-1.550
	110.0	5319.991008	-1.690	5319.990817	-1.726	5319.991404	-1.616	5319.990996	-1.692
	126.5	5319.991006	-1.691	5319.990889	-1.713	5319.990965	-1.698	5319.991287	-1.638



A D T

4.7 BAND EDGES MEASUREMENT

4.7.1 TEST INSTRUMENTS

DESCRIPTION & MANUFACTURER	MODEL NO.	SERIAL NO.	DATE OF CALIBRATION	DUE DATE OF CALIBRATION
Test Receiver ROHDE & SCHWARZ	ESI7	838496/016	Dec. 29, 2009	Dec. 28, 2010
Spectrum Analyzer ROHDE & SCHWARZ	FSP40	100039	Jan. 11, 2010	Jan. 10, 2011
BILOG Antenna SCHWARZBECK	VULB9168	9168-155	Apr. 28, 2010	Apr. 27, 2011
HORN Antenna SCHWARZBECK	BBHA 9120D	9120D-408	Jan. 05, 2010	Jan. 04, 2011
HORN Antenna SCHWARZBECK	BBHA 9170	BBHA9170242	Dec. 25, 2009	Dec. 24, 2010
Preamplifier Agilent	8449B	3008A01961	Nov. 04, 2009	Nov. 03, 2010
Preamplifier Agilent	8447D	2944A10738	Nov. 04, 2009	Nov. 03, 2010
RF signal cable HUBER+SUHNNER	SUCOFLEX 104	274041/4	Aug. 21, 2010	Aug. 20, 2011
RF signal cable HUBER+SUHNNER	SUCOFLEX 104	283397/4	Aug. 21, 2010	Aug. 20, 2011
Software ADT.	ADT_Radiated_ V7.6.15.9.2	NA	NA	NA
Antenna Tower inn-co GmbH	MA 4000	010303	NA	NA
Antenna Tower Controller inn-co GmbH	CO2000	019303	NA	NA
Turn Table ADT.	TT100.	TT93021704	NA	NA
Turn Table Controller ADT.	SC100.	SC93021704	NA	NA
26GHz ~ 40GHz Amplifier	EM26400	07026401	Aug. 25, 2010	Aug. 24, 2011

NOTE: The calibration interval of the above test instruments is 12 months and the calibrations are traceable to NML/ROC and NIST/USA.



A D T

4.7.2 TEST PROCEDURE

- a. The EUT was placed on the top of a rotating table 0.8 meters above the ground at a 3 meter semi-anechoic chamber. The table was rotated 360 degrees to determine the position of the highest radiation.
- b. The EUT was set 3 meters away from the interference-receiving antenna, which was mounted on the top of a variable-height antenna tower.
- c. The antenna is a broadband antenna, and its height is varied from one meter to four meters above the ground to determine the maximum value of the field strength. Both horizontal and vertical polarizations of the antenna are set to make the measurement.
- d. For each suspected emission, the EUT was arranged to its worst case and then the antenna was tuned to heights from 1 meter to 4 meters and the rotatable table was turned from 0 degrees to 360 degrees to find the maximum reading.
- e. Set both RBW and VBW of spectrum analyzer to 1MHz and 3MHz with suitable frequency span including 100MHz bandwidth from band edge. The band edges was measured and recorded.

NOTE: The resolution bandwidth of test receiver/spectrum analyzer is 1MHz and the video bandwidth is 10Hz for Average detection (AV) at frequency above 1GHz

4.7.3 EUT OPERATING CONDITION

The software provided by client to enable the EUT under transmission condition continuously at specific channel frequencies individually.



4.7.4 TEST RESULTS

For signals in the restricted bands above and below the 5.15 to 5.25GHz allocated band a measurement was made of the amplitude of the spurious emissions with respect to the intentional signals. The relative amplitude, in dBc, was applied to the average and peak filed strength of the intentional signal made on the OATS to calculate the field strength of the unintentional signals.

The spectrum plots (Peak RBW = 1MHz, VBW = 3MHz) are attached on the following pages.

802.11a

FOR 5260-5320MHz BAND:

RESTRICT BAND (4500 ~ 5150 MHz)

FREQUENCY (MHz)	FUNDAMENTAL EMISSION (dBuV/m)	DELTA (dB)	MAXIMUM FIELD STRENGTH IN RESTRICT BAND (dBuV/m)	LIMIT (dBuV/m)
5260.00 (PK)	119.2	51.21	67.99	74.00
5260.00 (AV)	106.4	53.80	52.60	54.00

RESTRICT BAND (5350 ~ 5460 MHz)

FREQUENCY (MHz)	FUNDAMENTAL EMISSION (dBuV/m)	DELTA (dB)	MAXIMUM FIELD STRENGTH IN RESTRICT BAND (dBuV/m)	LIMIT (dBuV/m)
5320.00 (PK)	119.7	47.33	72.37	74.00
5320.00 (AV)	107.1	54.32	52.78	54.00

NOTE:

- Delta = Amplitude between the peak of the fundamental and the peak of the band edge emission. Please check following 3 pages.
- Maximum field strength in restrict band = Fundamental emission – Delta.



A D T

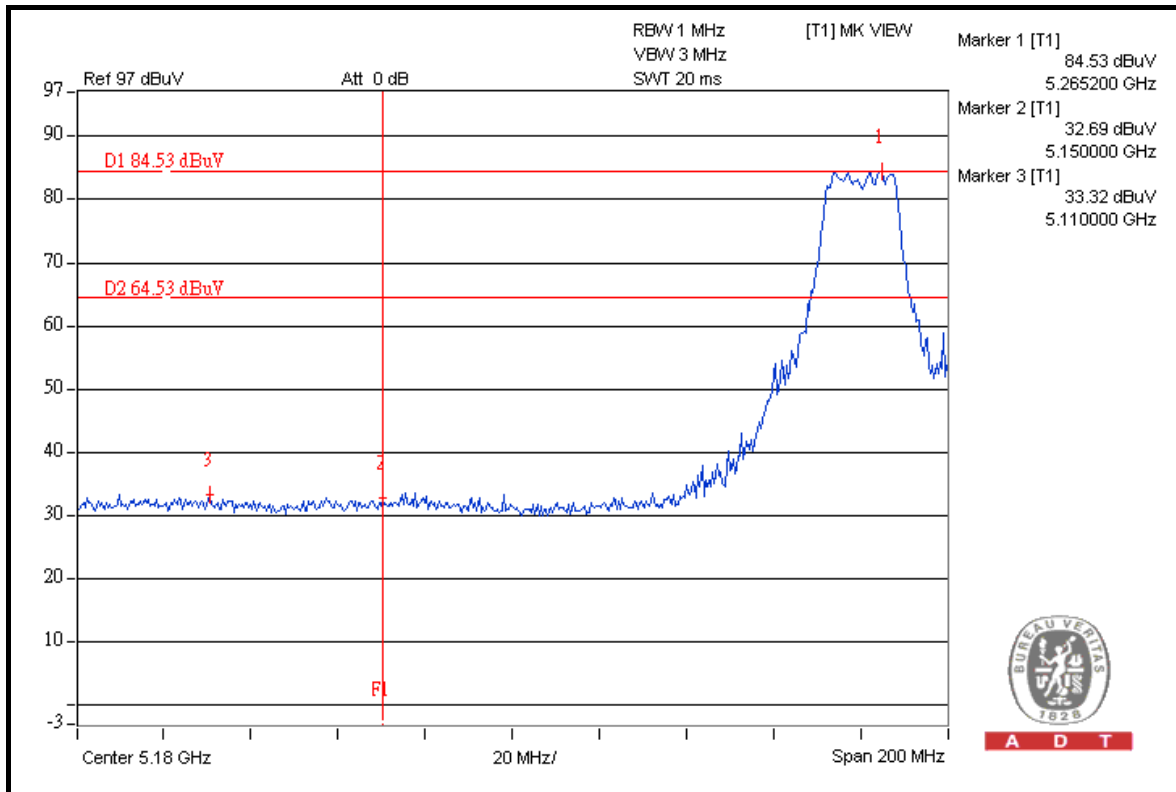

A D T

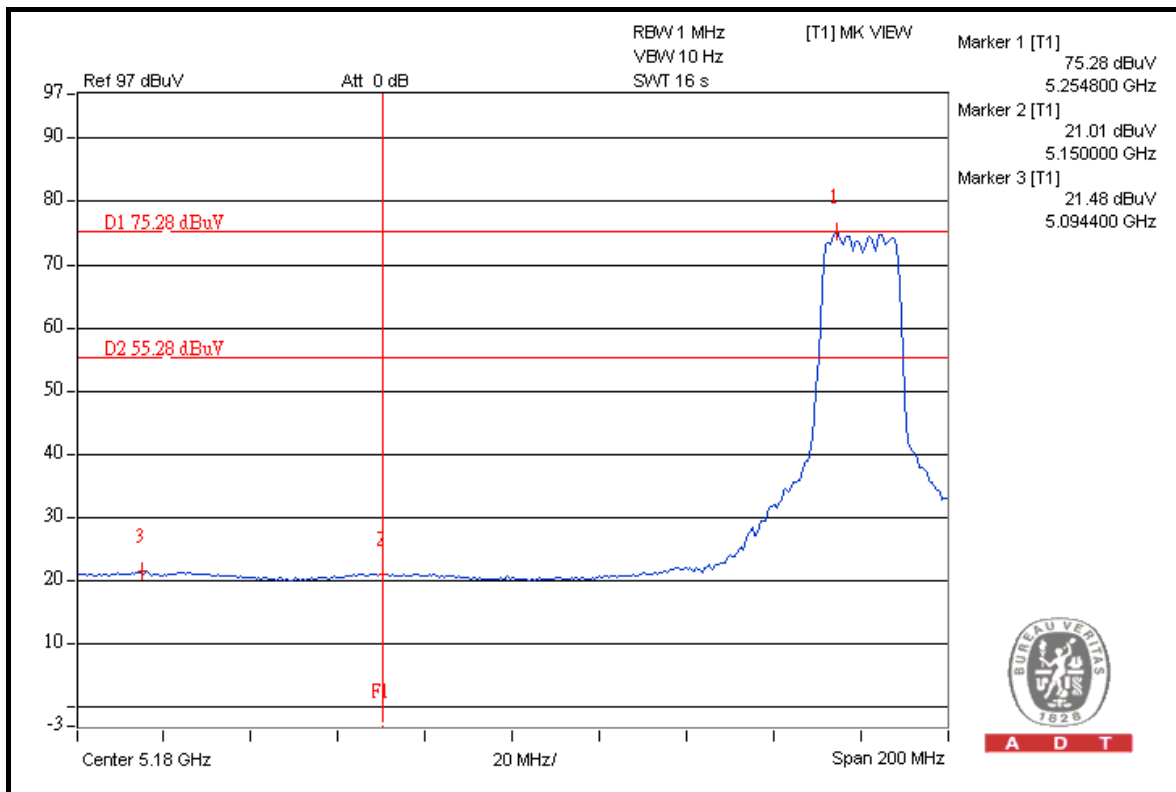

A D T



A D T

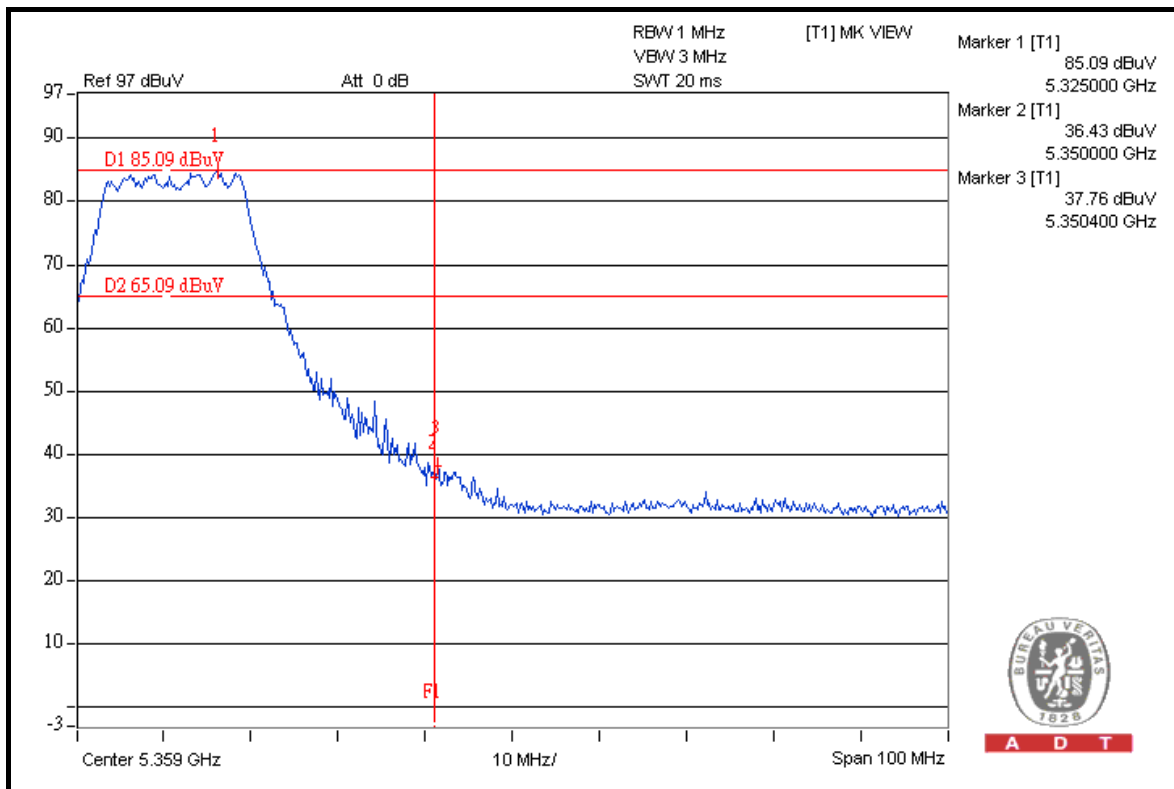
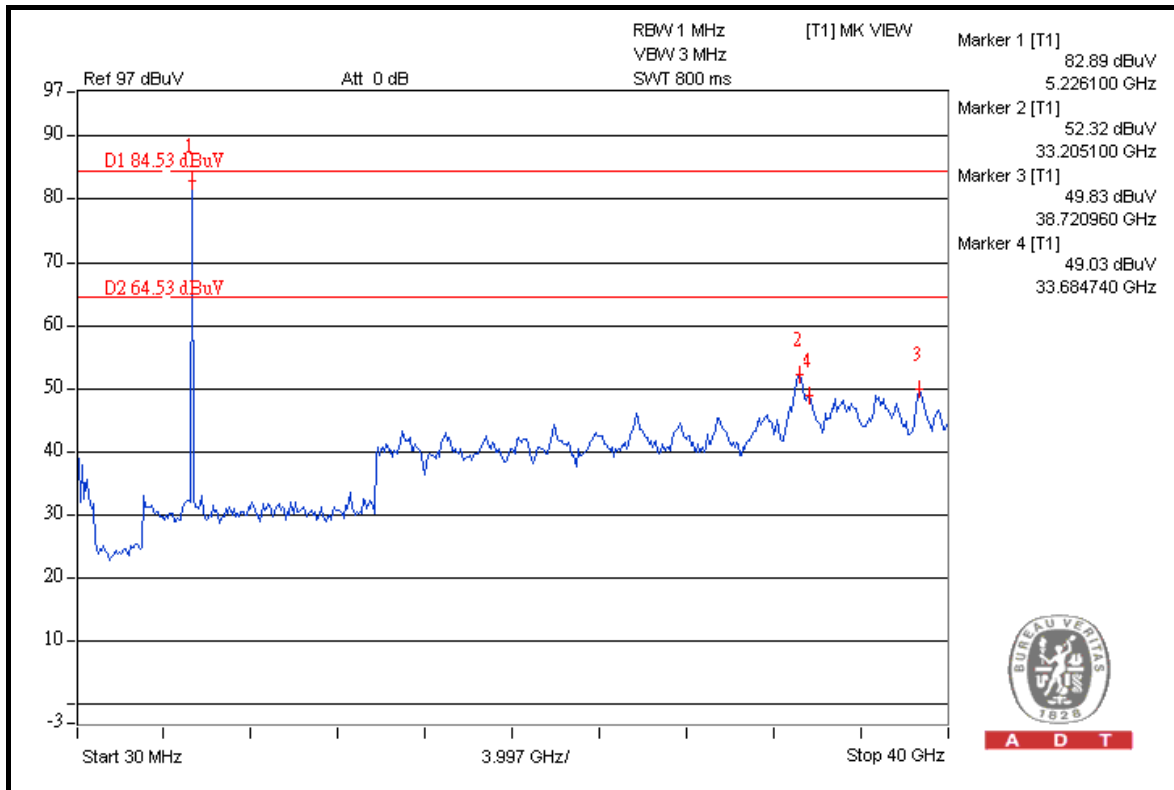



A D T

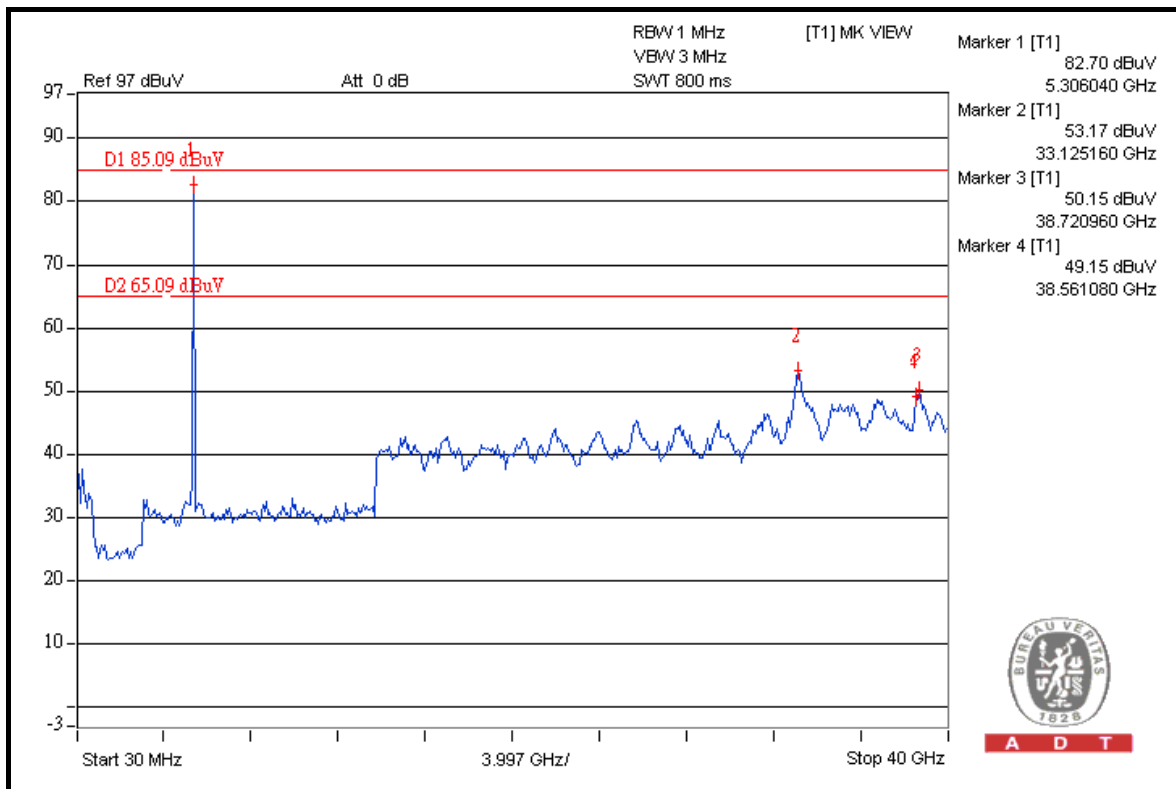
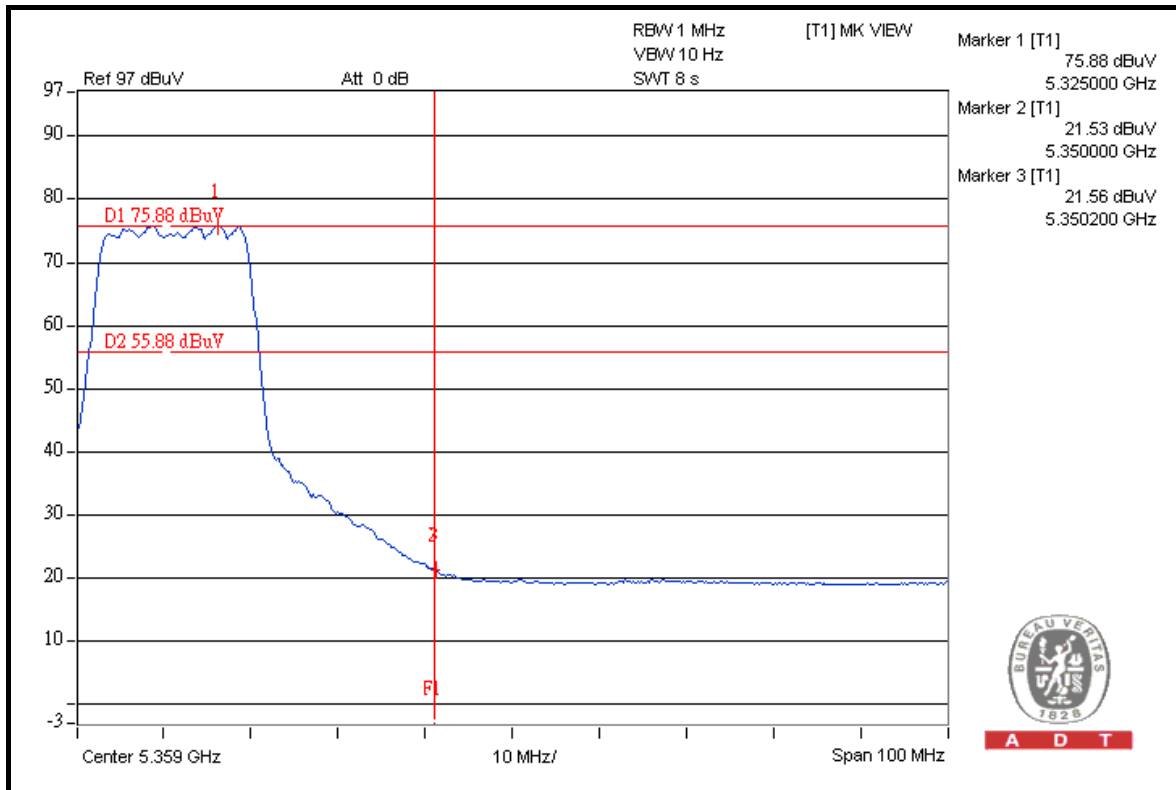



A D T

FOR 5500-5700MHz BAND:

5500MHz

RESTRICT BAND (5350 ~ 5460 MHz)

FREQUENCY (MHz)	FUNDAMENTAL EMISSION (dBuV/m)	DELTA (dB)	MAXIMUM FIELD STRENGTH IN RESTRICT BAND (dBuV/m)	LIMIT (dBuV/m)
5500.00 (PK)	117.1	49.62	67.48	74.00
5500.00 (AV)	105.0	52.26	52.74	54.00

FREQUENCY BAND (5460 ~ 5470 MHz)

FREQUENCY (MHz)	FUNDAMENTAL EMISSION (dBuV/m)	DELTA (dB)	MAXIMUM FIELD STRENGTH (dBuV/m)	LIMIT (dBuV/m)
5500.00 (PK)	117.1	49.34	67.76	68.30

5700MHz

ABOVE 5725 MHz

FREQUENCY (MHz)	FUNDAMENTAL EMISSION (dBuV/m)	DELTA (dB)	MAXIMUM FIELD STRENGTH (dBuV/m)	LIMIT (dBuV/m)
5700.00 (PK)	115.9	48.99	66.91	68.30

NOTE:

1. Delta = Amplitude between the peak of the fundamental and the peak of the band edge emission. Please check following 3 pages.
2. Maximum field strength in restrict band = Fundamental emission – Delta.



A D T

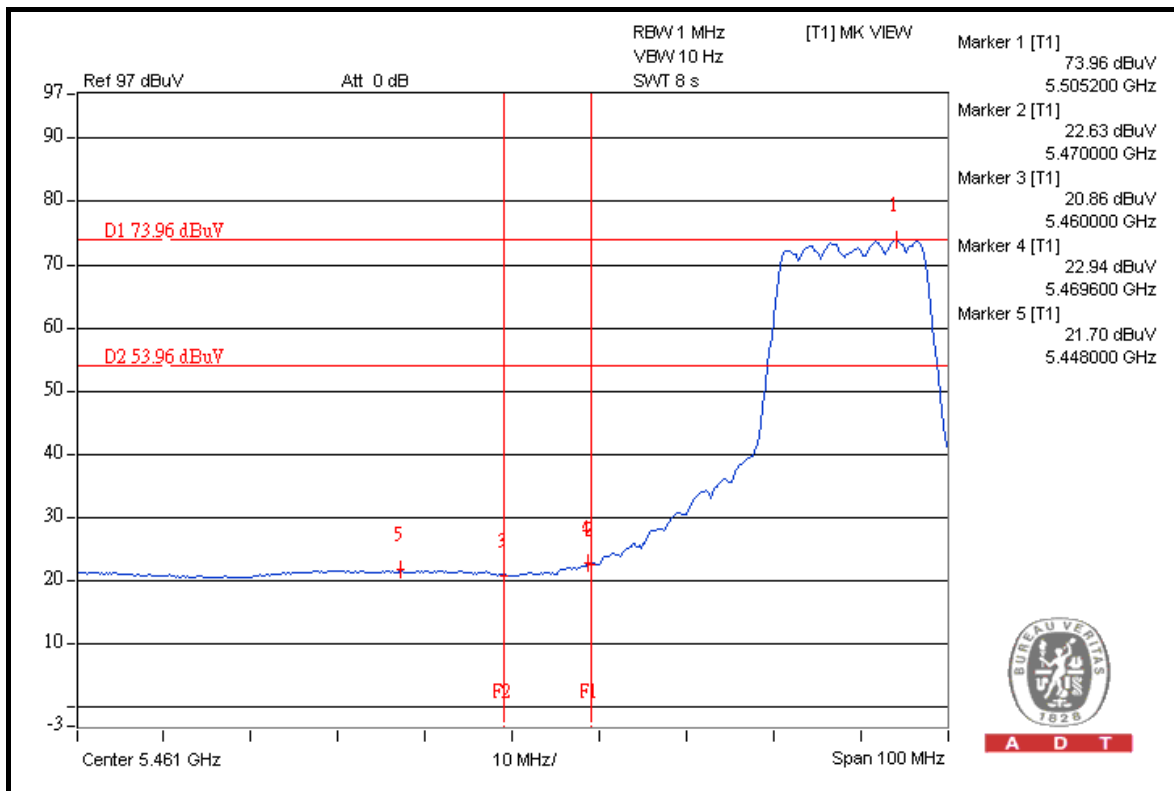
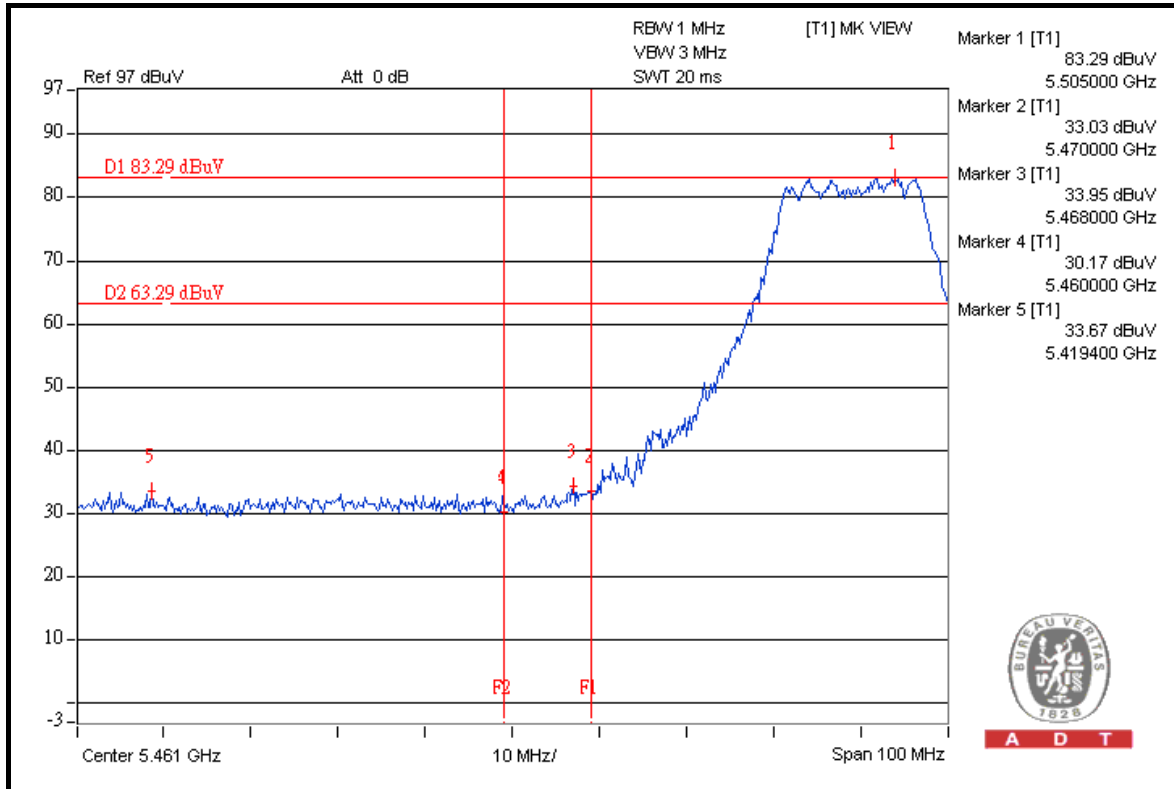



A D T

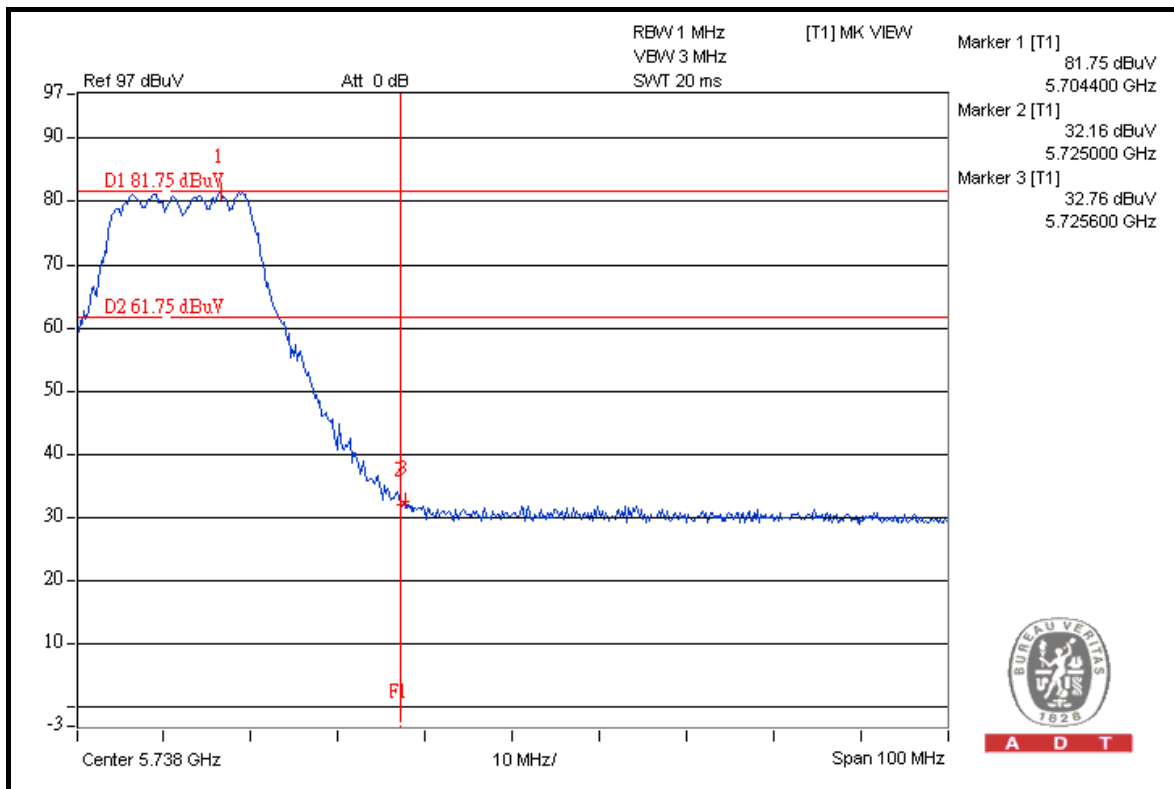
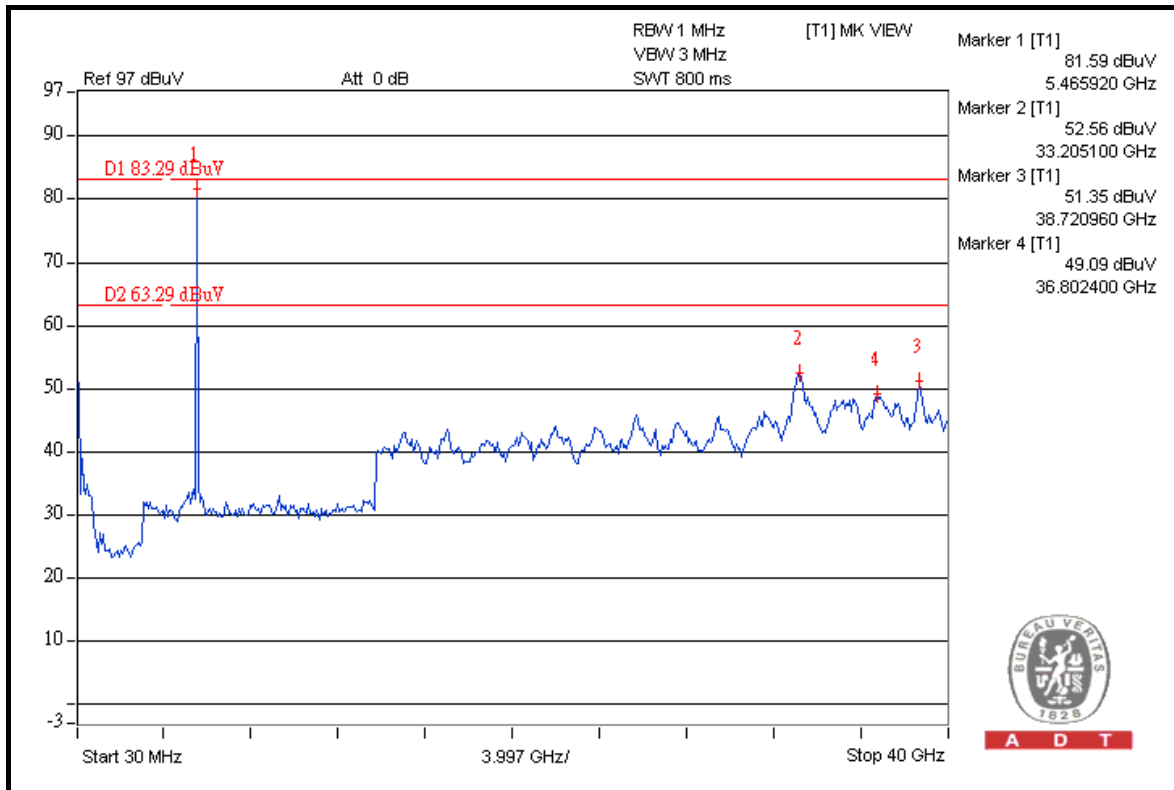



A D T

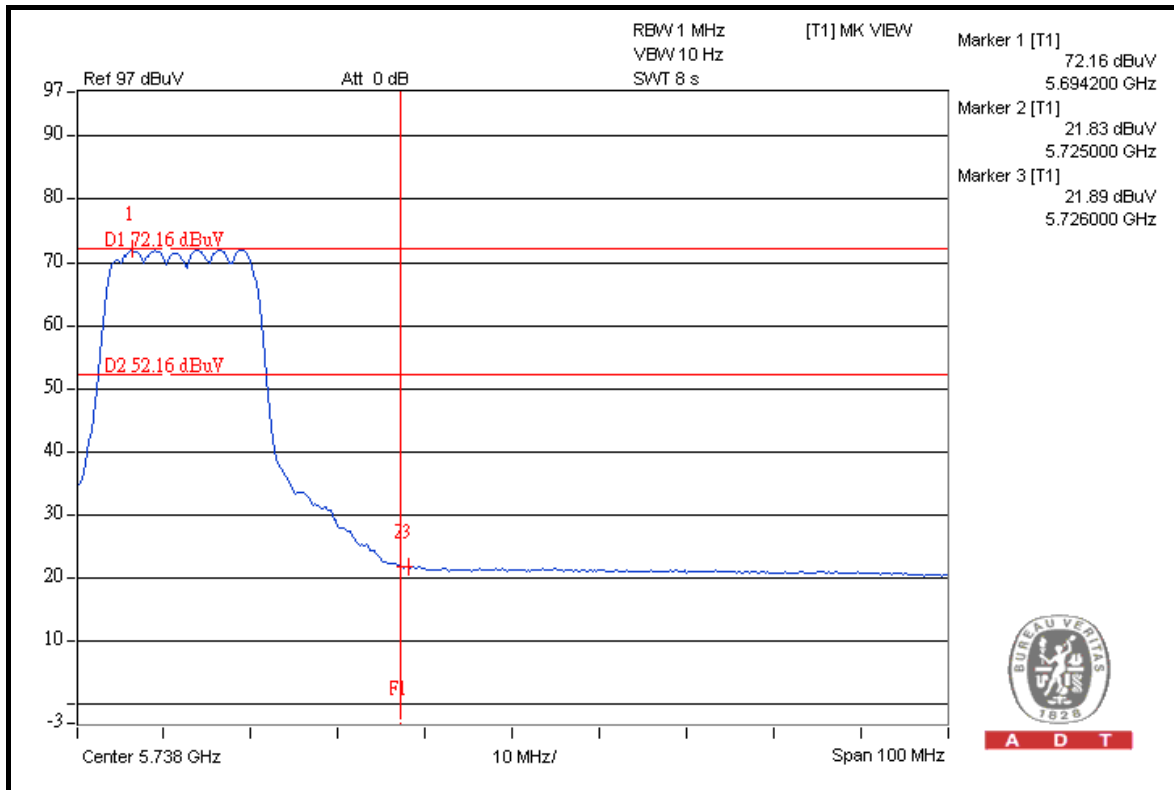

A D T

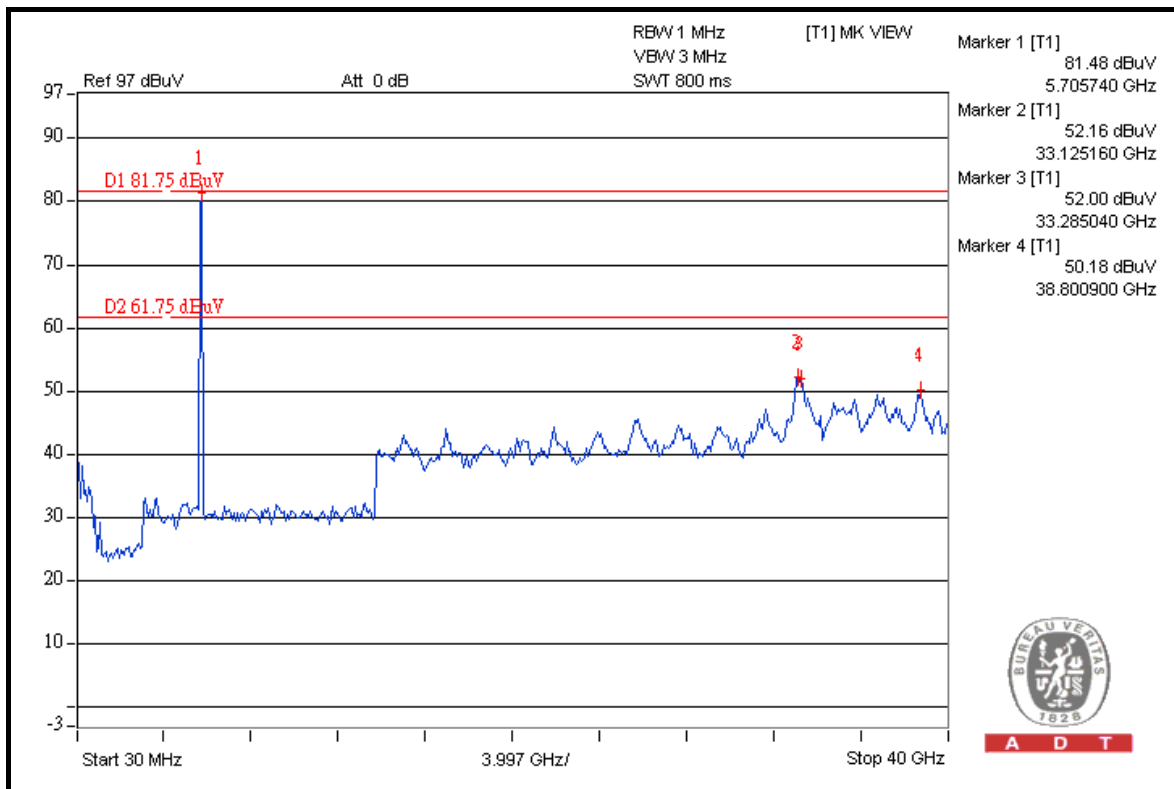

A D T



A D T

802.11n (20MHz)

FOR 5260-5320MHz BAND:

RESTRICT BAND (4500 ~ 5150 MHz)

FREQUENCY (MHz)	FUNDAMENTAL EMISSION (dBuV/m)	DELTA (dB)	MAXIMUM FIELD STRENGTH IN RESTRICT BAND (dBuV/m)	LIMIT (dBuV/m)
5260.00 (PK)	120.1	52.52	67.58	74.00
5260.00 (AV)	107.0	54.20	52.80	54.00

RESTRICT BAND (5350 ~ 5460 MHz)

FREQUENCY (MHz)	FUNDAMENTAL EMISSION (dBuV/m)	DELTA (dB)	MAXIMUM FIELD STRENGTH IN RESTRICT BAND (dBuV/m)	LIMIT (dBuV/m)
5320.00 (PK)	118.3	47.47	70.83	74.00
5320.00 (AV)	105.0	52.67	52.33	54.00

NOTE:

1. Delta = Amplitude between the peak of the fundamental and the peak of the band edge emission. Please check following 3 pages.
2. Maximum field strength in restrict band = Fundamental emission – Delta.



A D T

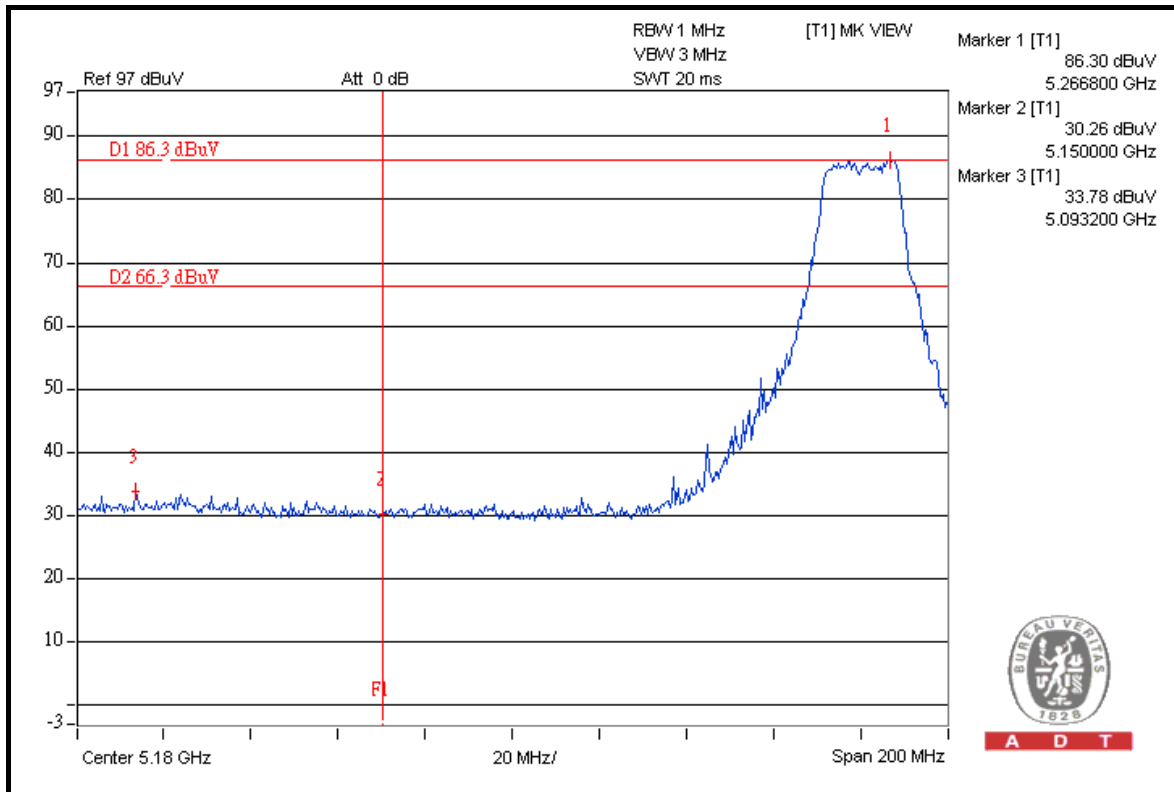

A D T

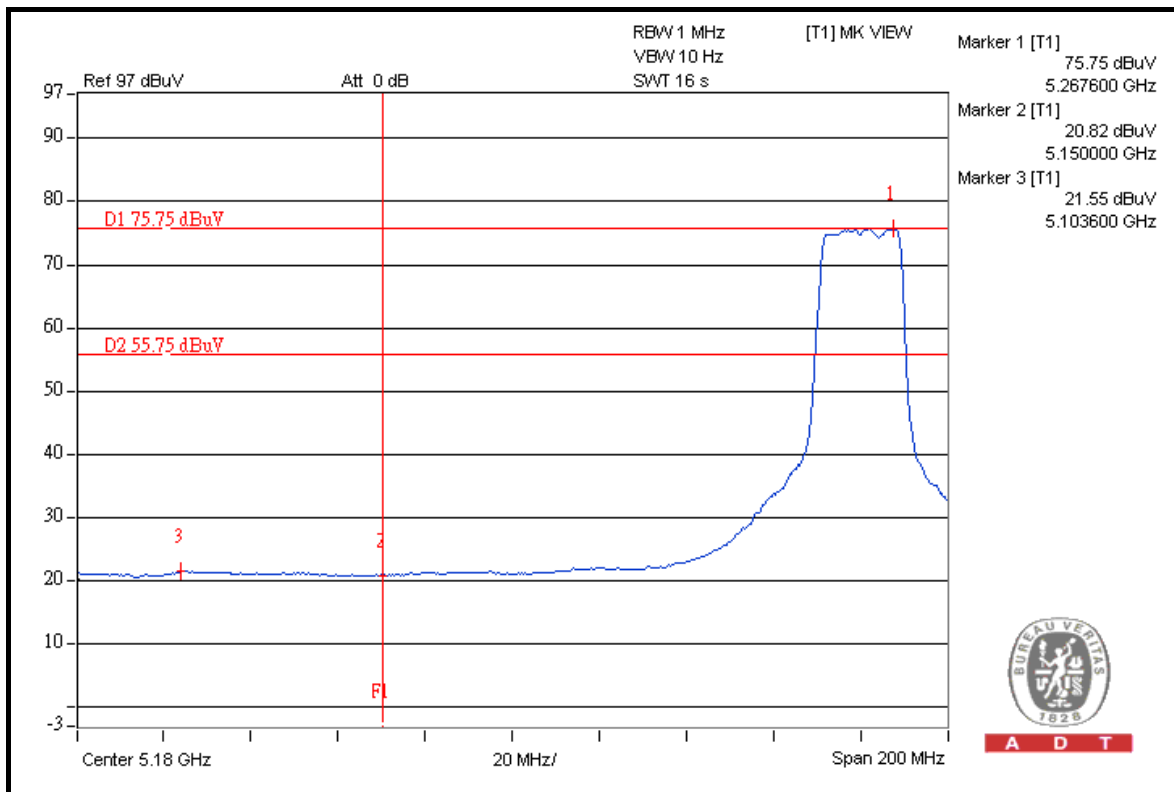

A D T



A D T

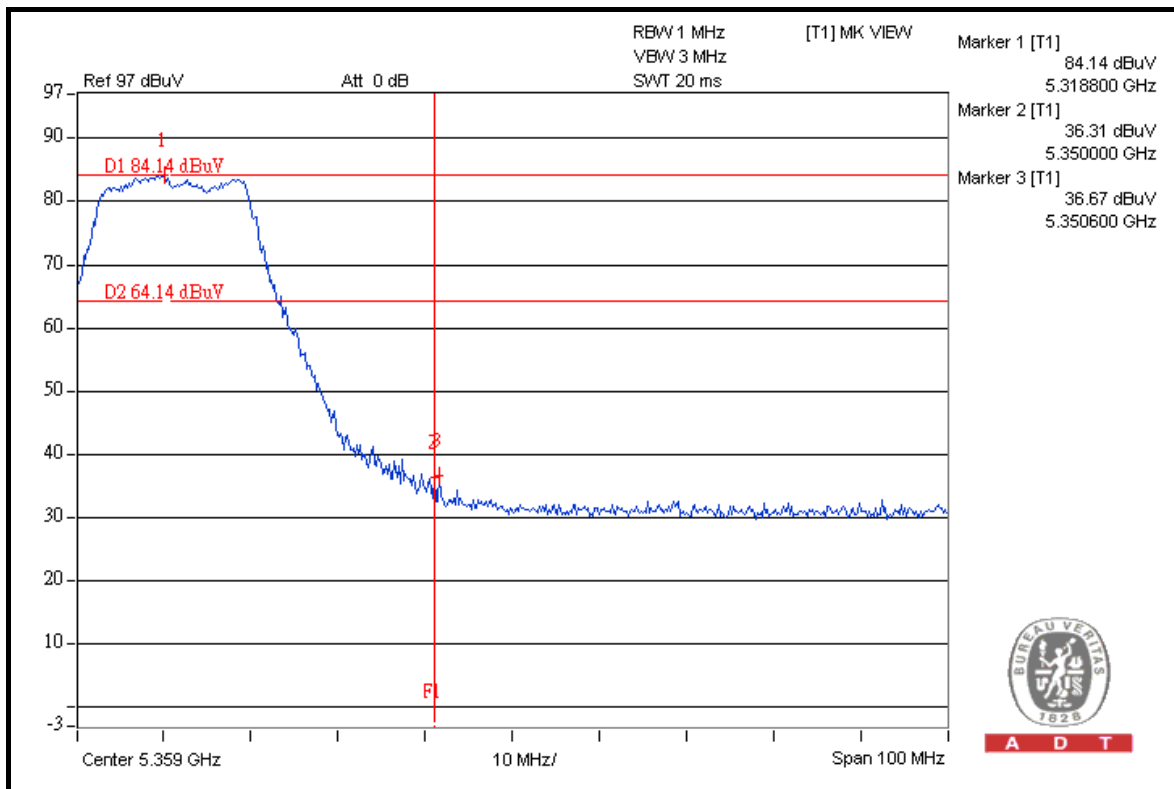
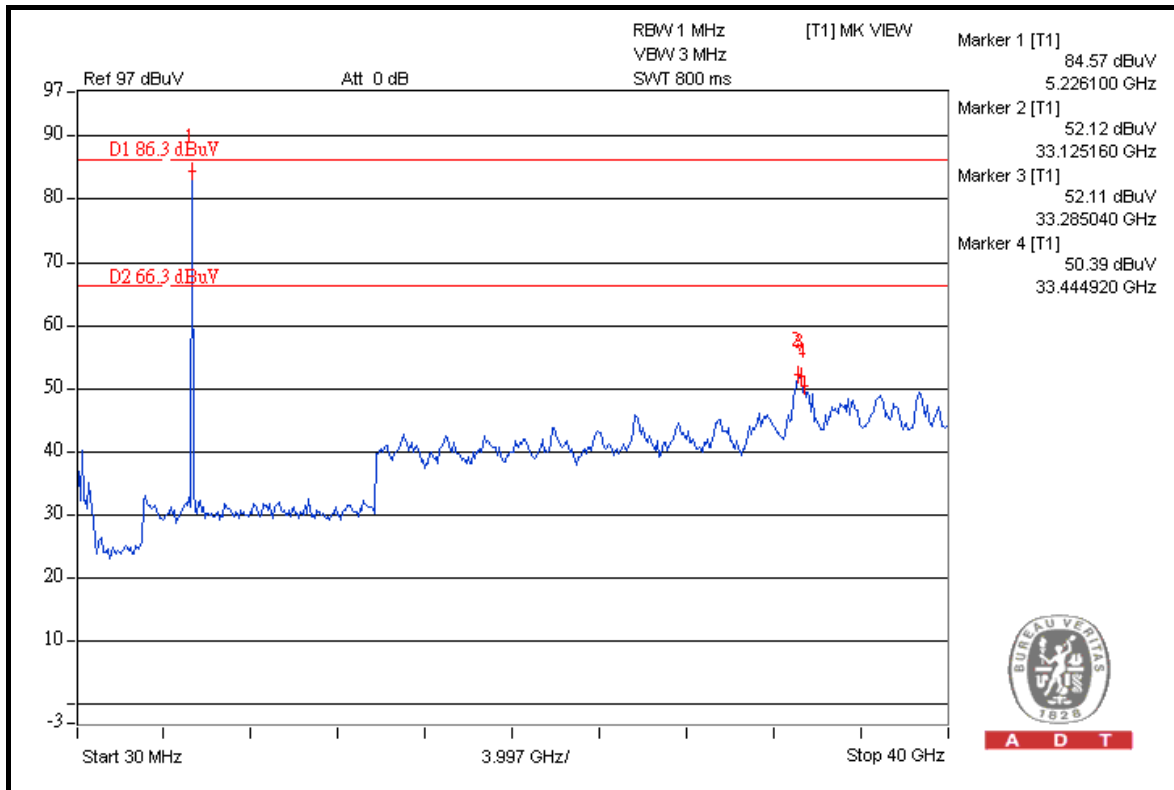



A D T

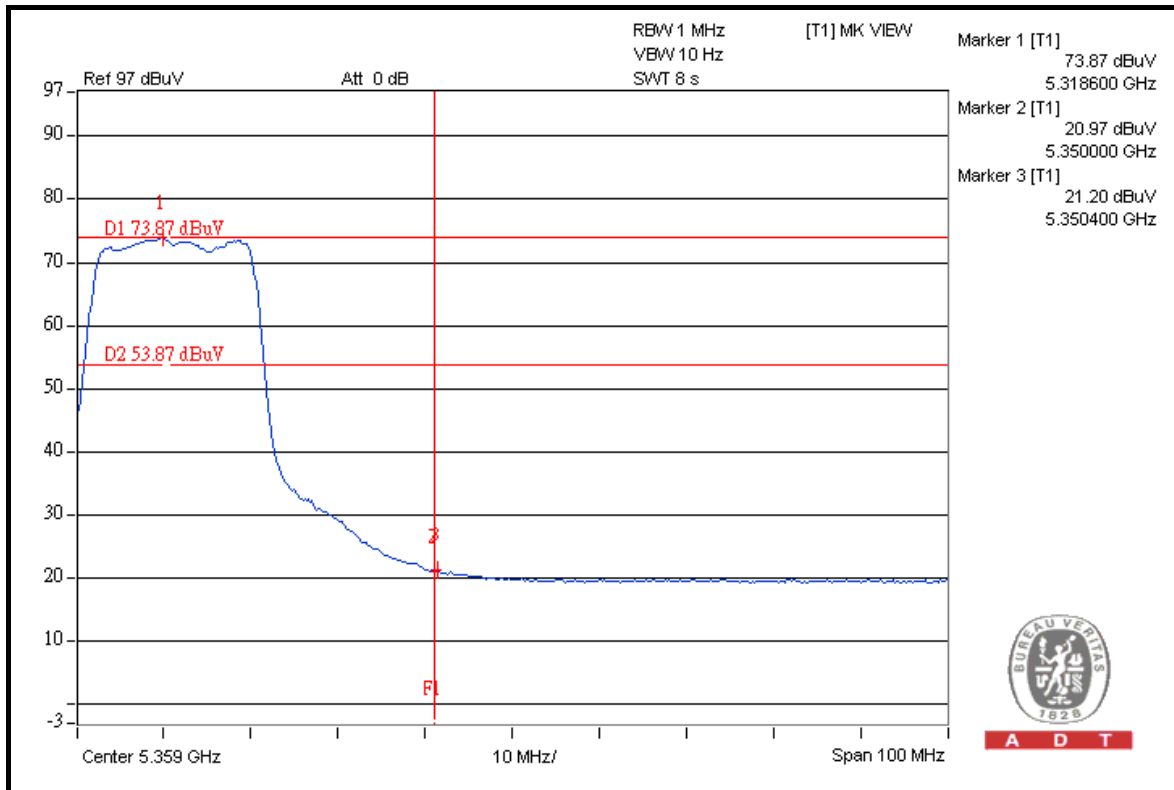

A D T

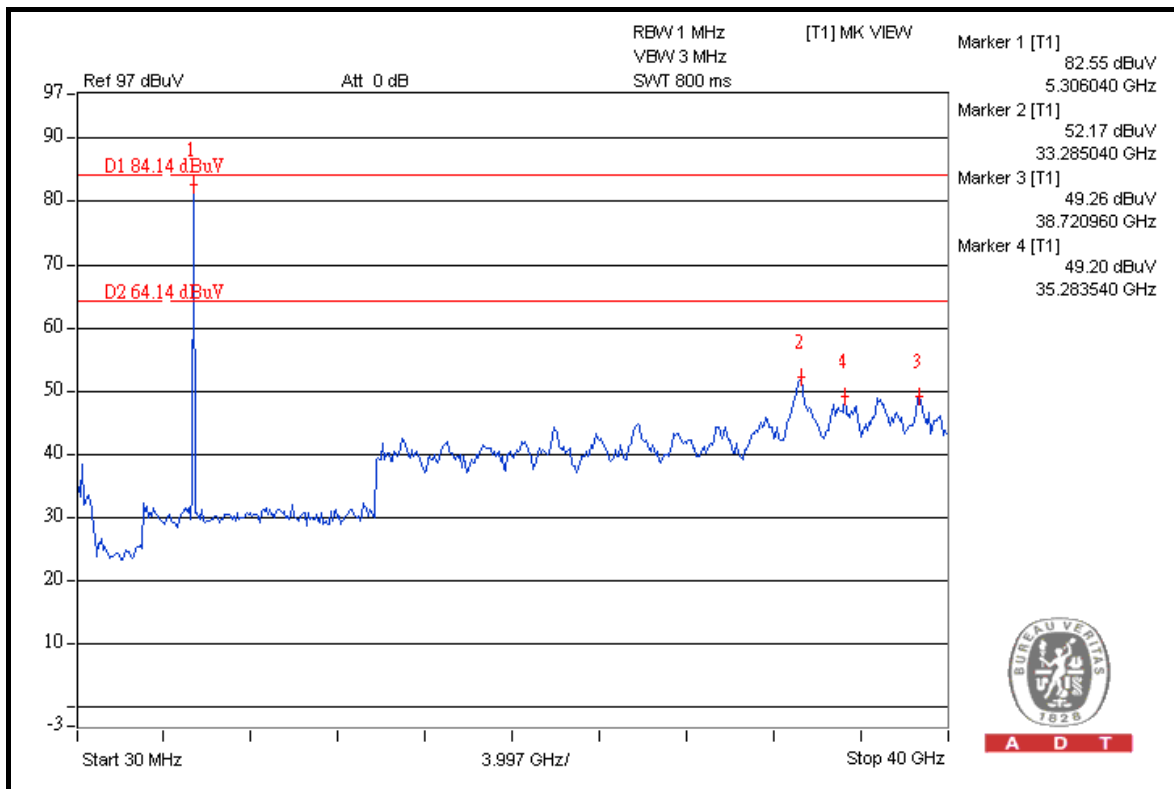

A D T



A D T

FOR 5500-5700MHz BAND:

5500MHz

RESTRICT BAND (5350 ~ 5460 MHz)

FREQUENCY (MHz)	FUNDAMENTAL EMISSION (dBuV/m)	DELTA (dB)	MAXIMUM FIELD STRENGTH IN RESTRICT BAND (dBuV/m)	LIMIT (dBuV/m)
5500.00 (PK)	116.6	50.94	65.66	74.00
5500.00 (AV)	106.3	53.45	52.85	54.00

FREQUENCY BAND (5460 ~ 5470 MHz)

FREQUENCY (MHz)	FUNDAMENTAL EMISSION (dBuV/m)	DELTA (dB)	MAXIMUM FIELD STRENGTH (dBuV/m)	LIMIT (dBuV/m)
5500.00 (PK)	116.6	49.56	67.04	68.30

5700MHz

ABOVE 5725 MHz

FREQUENCY (MHz)	FUNDAMENTAL EMISSION (dBuV/m)	DELTA (dB)	MAXIMUM FIELD STRENGTH (dBuV/m)	LIMIT (dBuV/m)
5700.00 (PK)	115.3	48.14	67.16	68.30

NOTE:

1. Delta = Amplitude between the peak of the fundamental and the peak of the band edge emission. Please check following 3 pages.
2. Maximum field strength in restrict band = Fundamental emission – Delta.



A D T

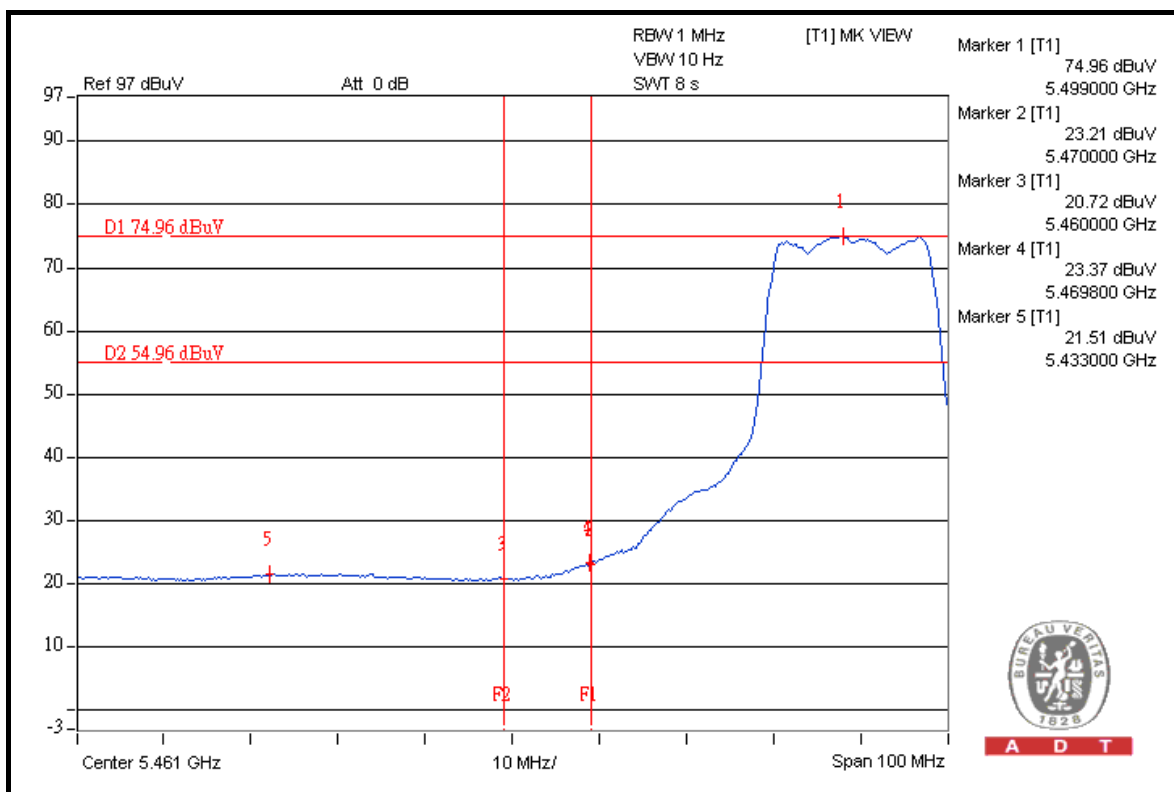
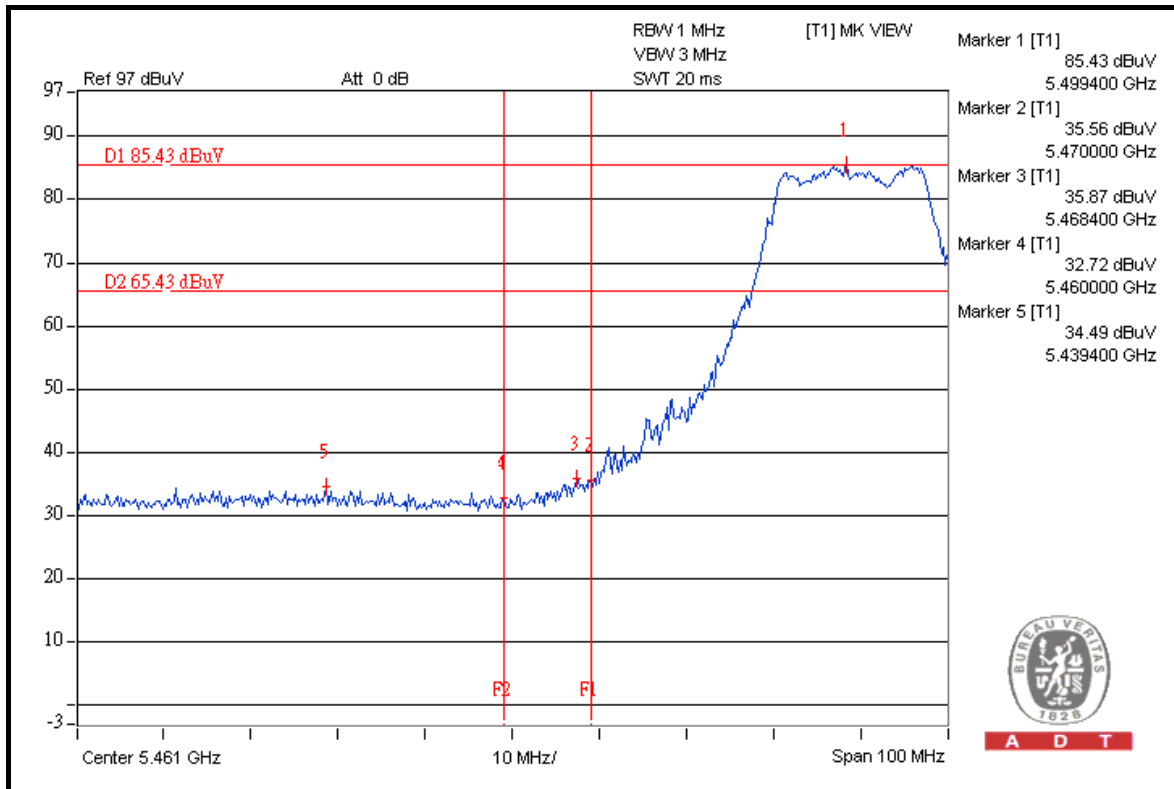



A D T

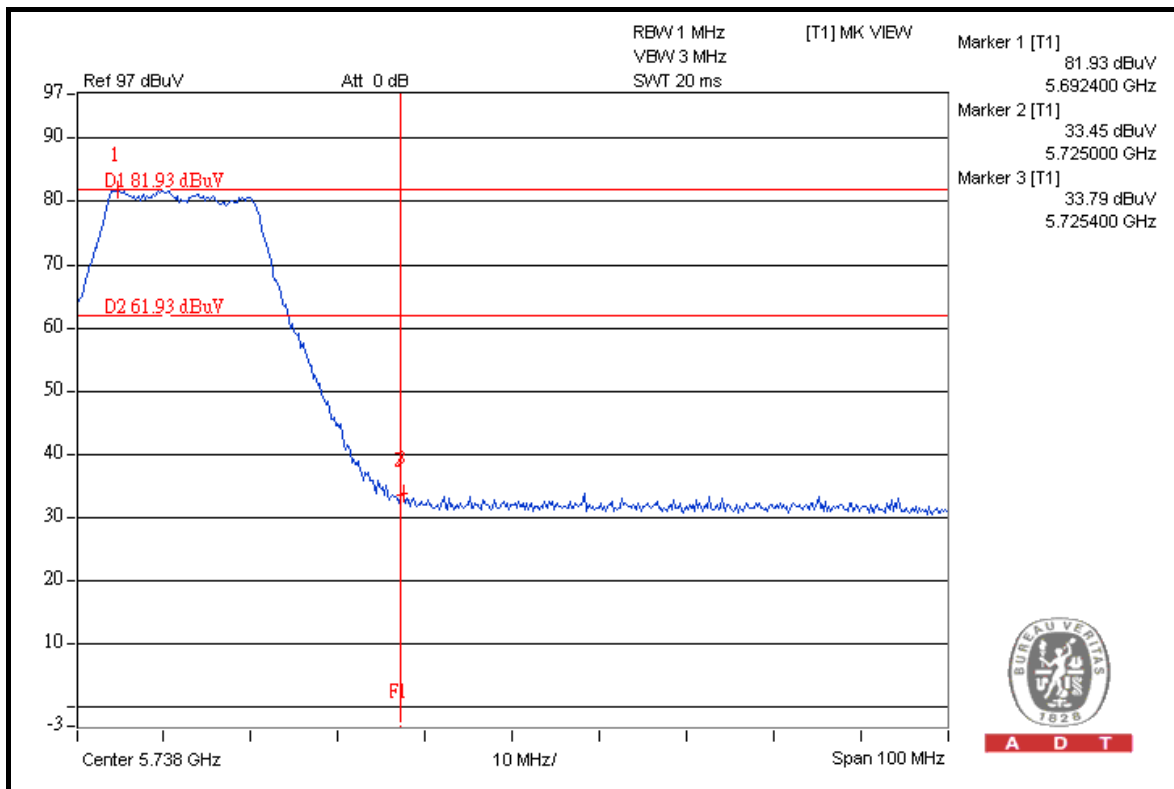
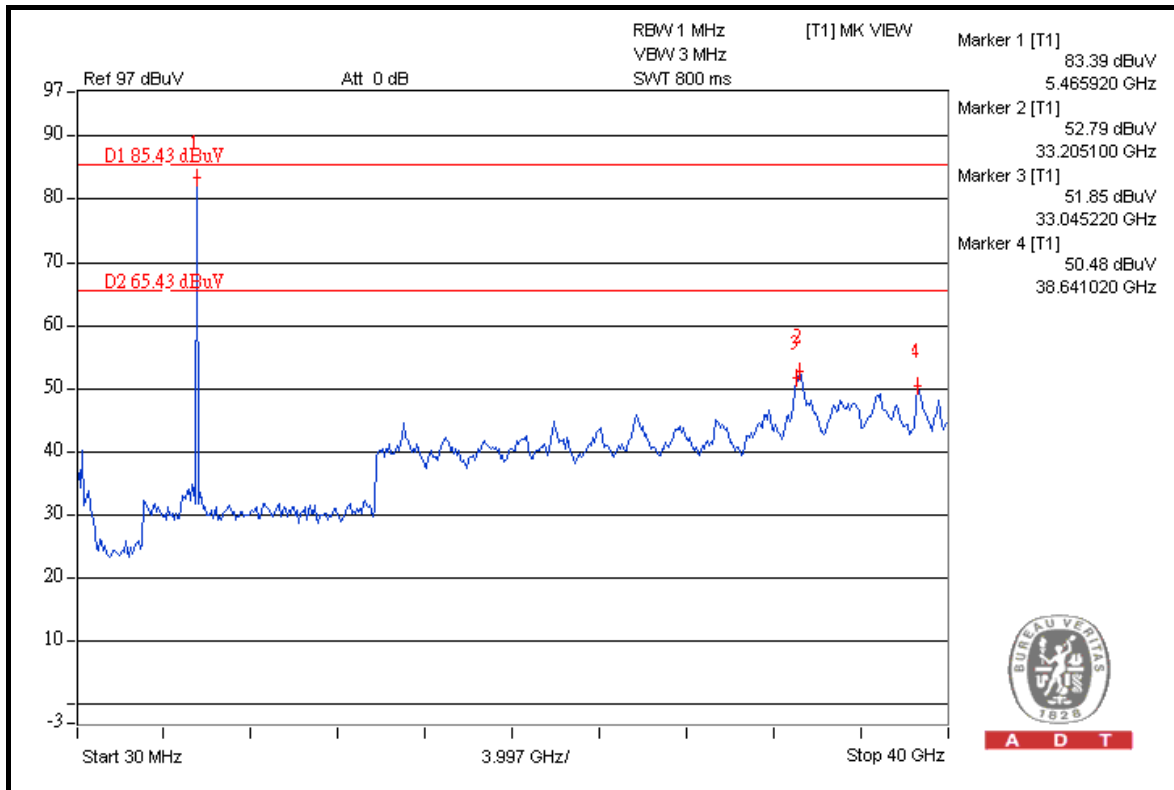



A D T

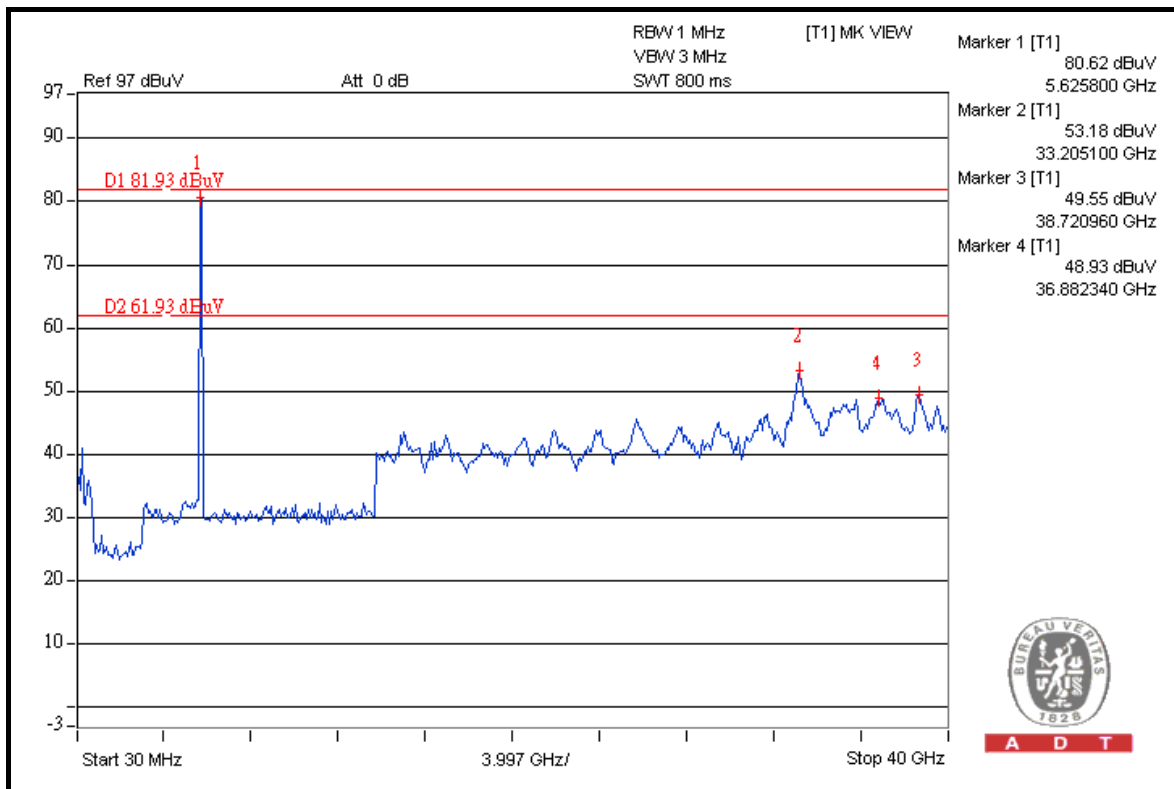
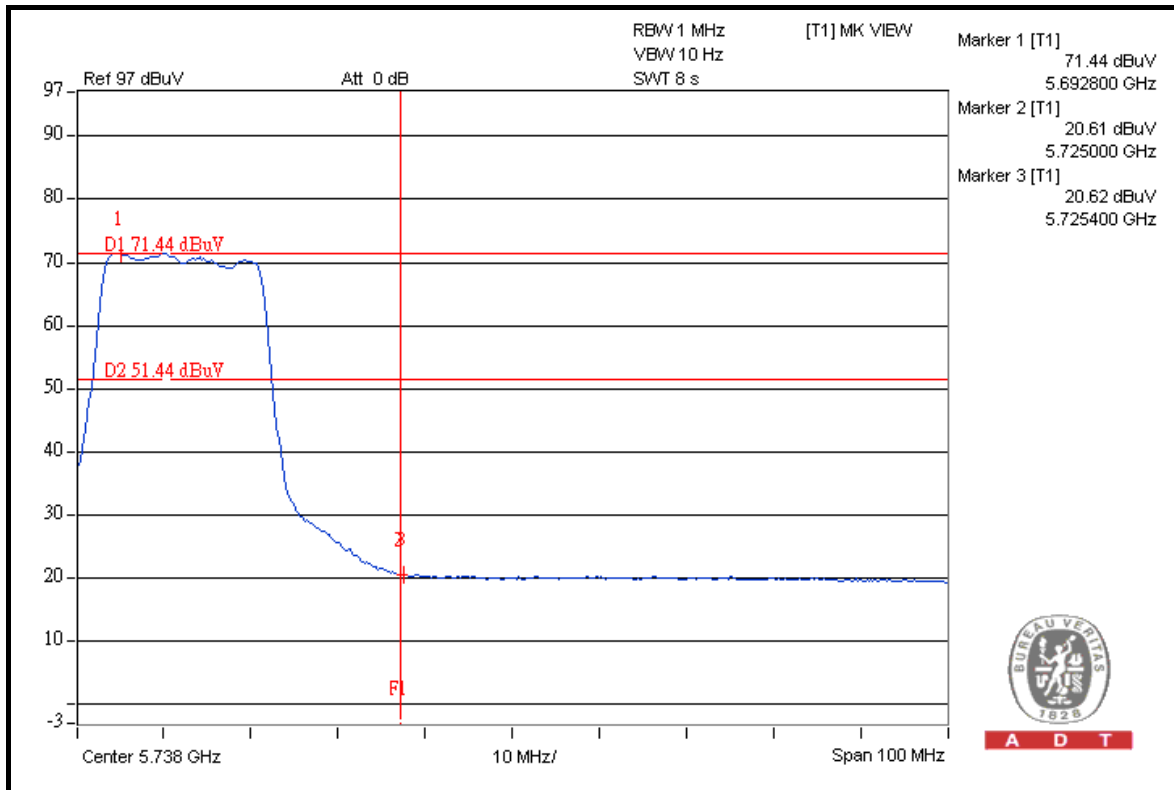



A D T

802.11n (40MHz)

FOR 5260-5320MHz BAND:

RESTRICT BAND (4500 ~ 5150 MHz)

FREQUENCY (MHz)	FUNDAMENTAL EMISSION (dBuV/m)	DELTA (dB)	MAXIMUM FIELD STRENGTH IN RESTRICT BAND (dBuV/m)	LIMIT (dBuV/m)
5270.00 (PK)	116.2	47.95	68.25	74.00
5270.00 (AV)	102.8	49.87	52.93	54.00

RESTRICT BAND (5350 ~ 5460 MHz)

FREQUENCY (MHz)	FUNDAMENTAL EMISSION (dBuV/m)	DELTA (dB)	MAXIMUM FIELD STRENGTH IN RESTRICT BAND (dBuV/m)	LIMIT (dBuV/m)
5310.00 (PK)	113.5	43.02	70.48	74.00
5310.00 (AV)	99.6	46.62	52.98	54.00

NOTE:

1. Delta = Amplitude between the peak of the fundamental and the peak of the band edge emission. Please check following 3 pages.
2. Maximum field strength in restrict band = Fundamental emission – Delta.



A D T

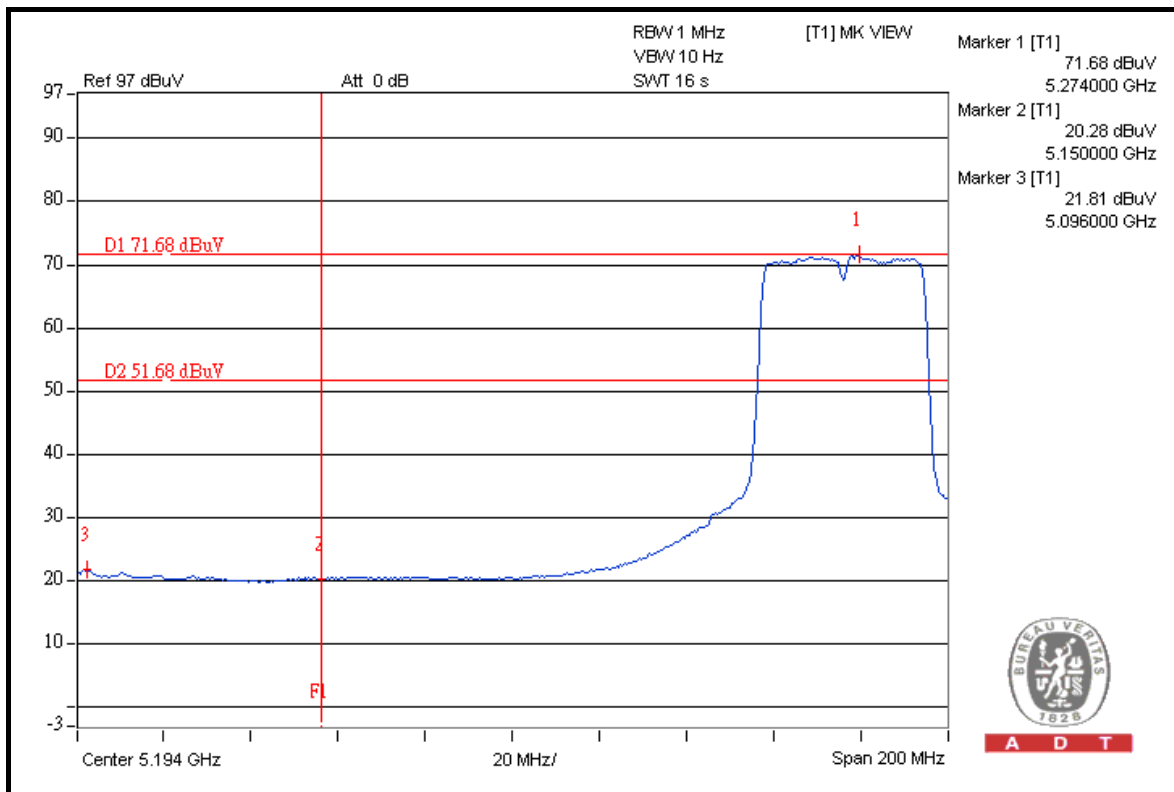
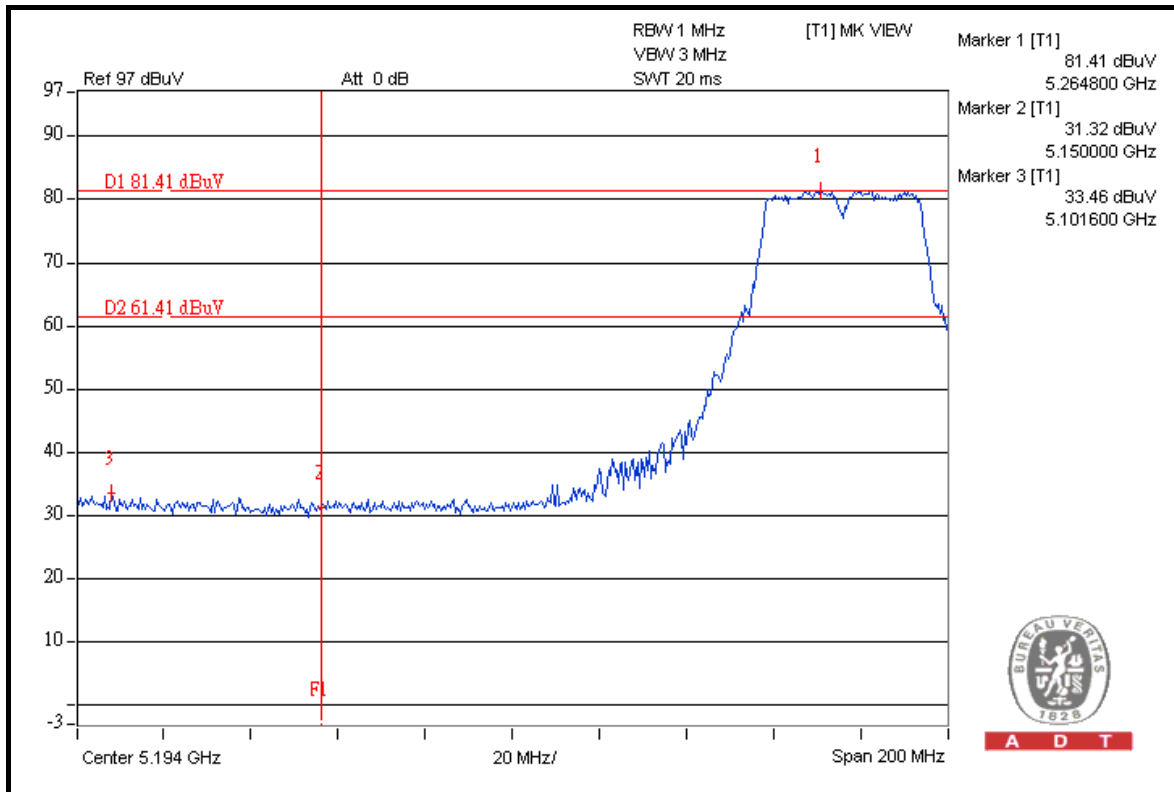



A D T

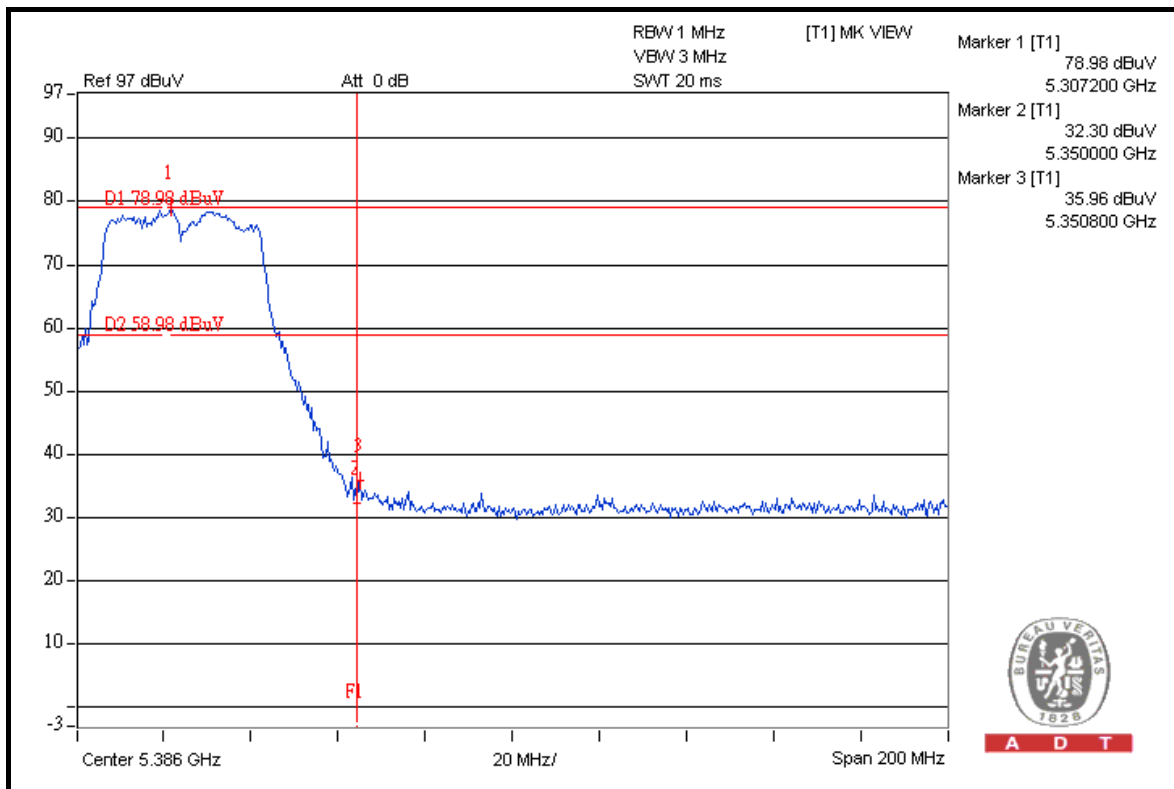
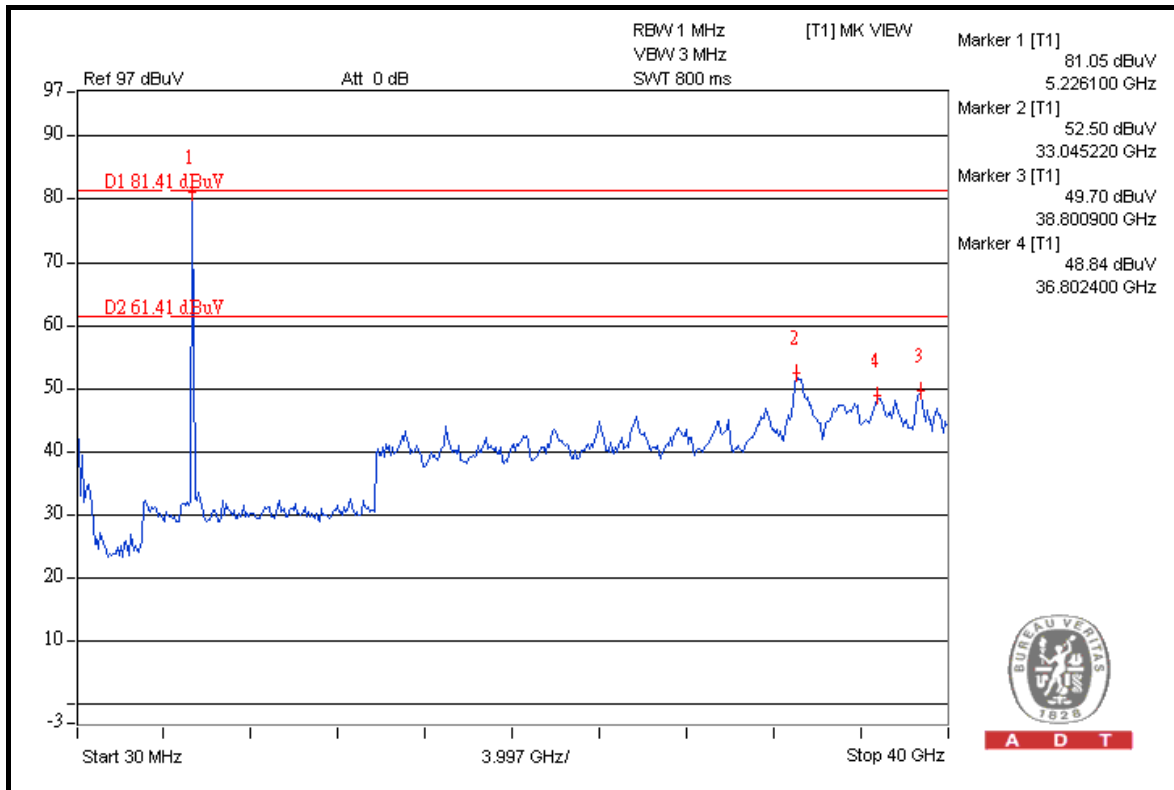



A D T

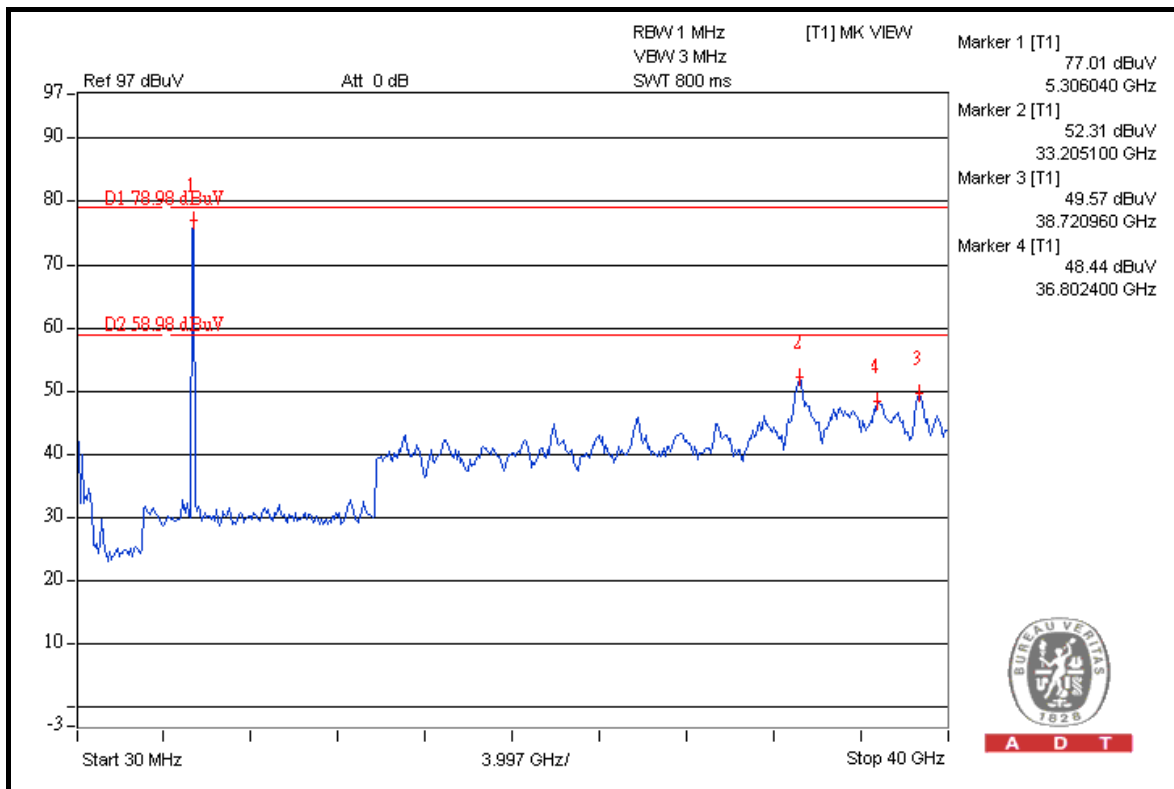
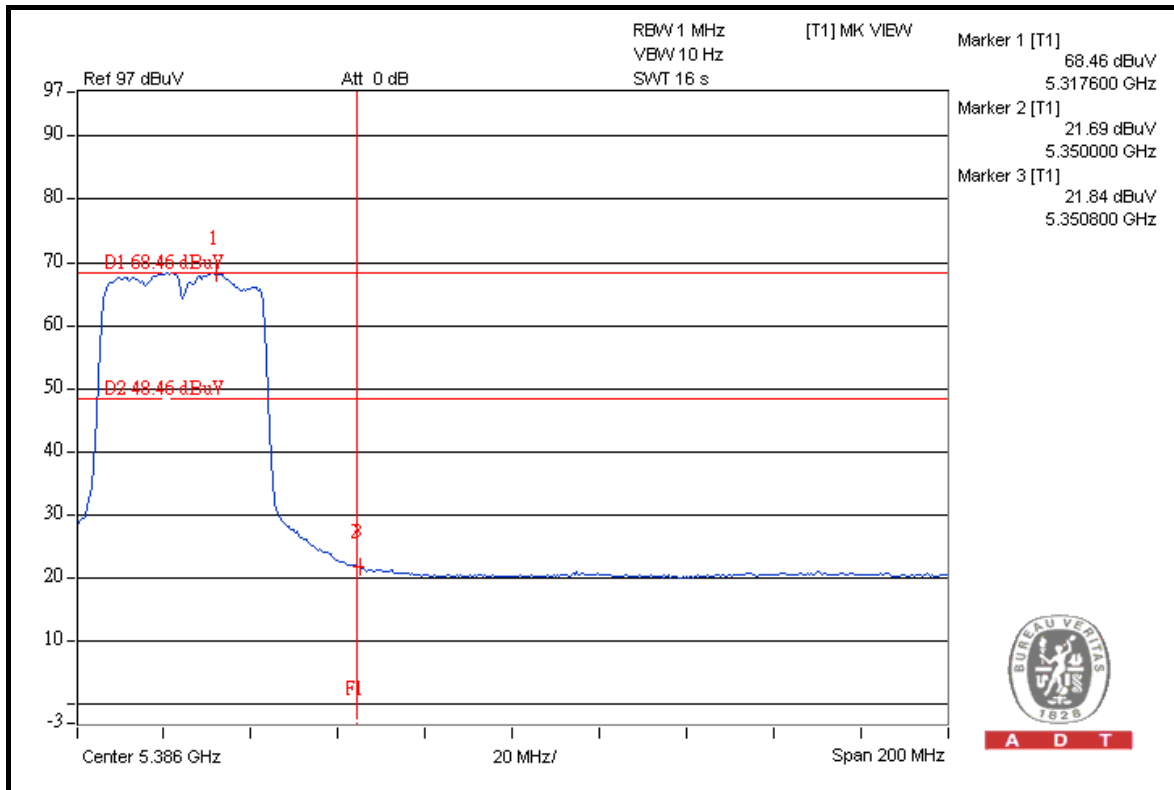



A D T

FOR 5500-5700MHz BAND:

5510MHz

RESTRICT BAND (5350 ~ 5460 MHz)

FREQUENCY (MHz)	FUNDAMENTAL EMISSION (dBuV/m)	DELTA (dB)	MAXIMUM FIELD STRENGTH IN RESTRICT BAND (dBuV/m)	LIMIT (dBuV/m)
5510.00 (PK)	110.4	43.51	66.89	74.00
5510.00 (AV)	96.5	45.45	51.05	54.00

FREQUENCY BAND (5460 ~ 5470 MHz)

FREQUENCY (MHz)	FUNDAMENTAL EMISSION (dBuV/m)	DELTA (dB)	MAXIMUM FIELD STRENGTH (dBuV/m)	LIMIT (dBuV/m)
5510.00 (PK)	110.4	43.23	67.17	68.30

5700MHz

ABOVE 5725 MHz

FREQUENCY (MHz)	FUNDAMENTAL EMISSION (dBuV/m)	DELTA (dB)	MAXIMUM FIELD STRENGTH (dBuV/m)	LIMIT (dBuV/m)
5550.00 (PK)	116.8	49.60	67.20	68.30

NOTE:

1. Delta = Amplitude between the peak of the fundamental and the peak of the band edge emission. Please check following 3 pages.
2. Maximum field strength in restrict band = Fundamental emission – Delta.



A D T

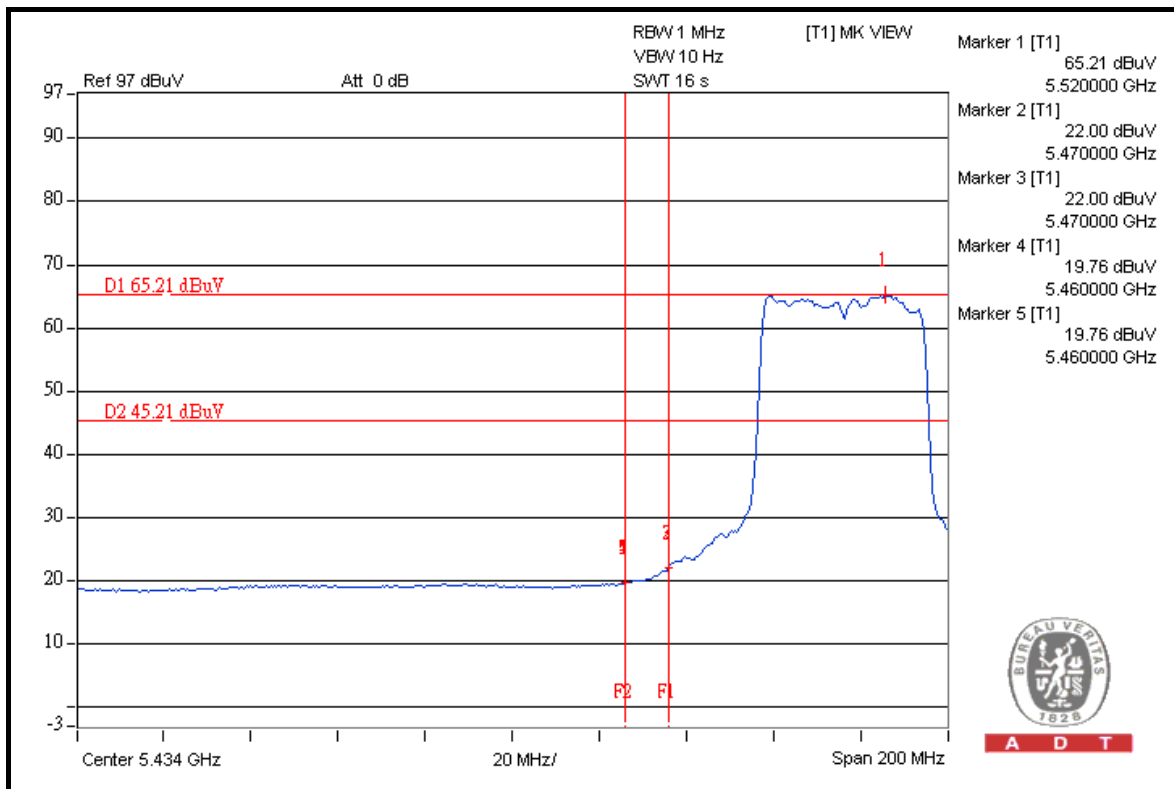
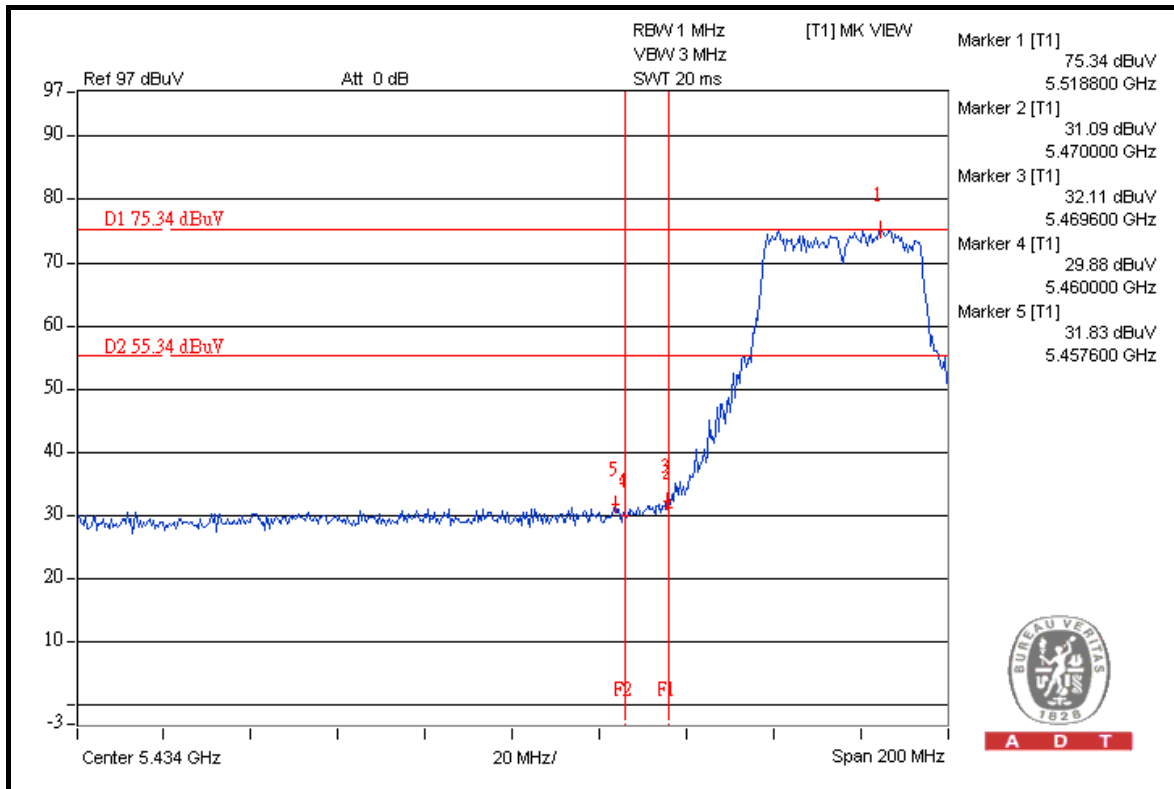



A D T

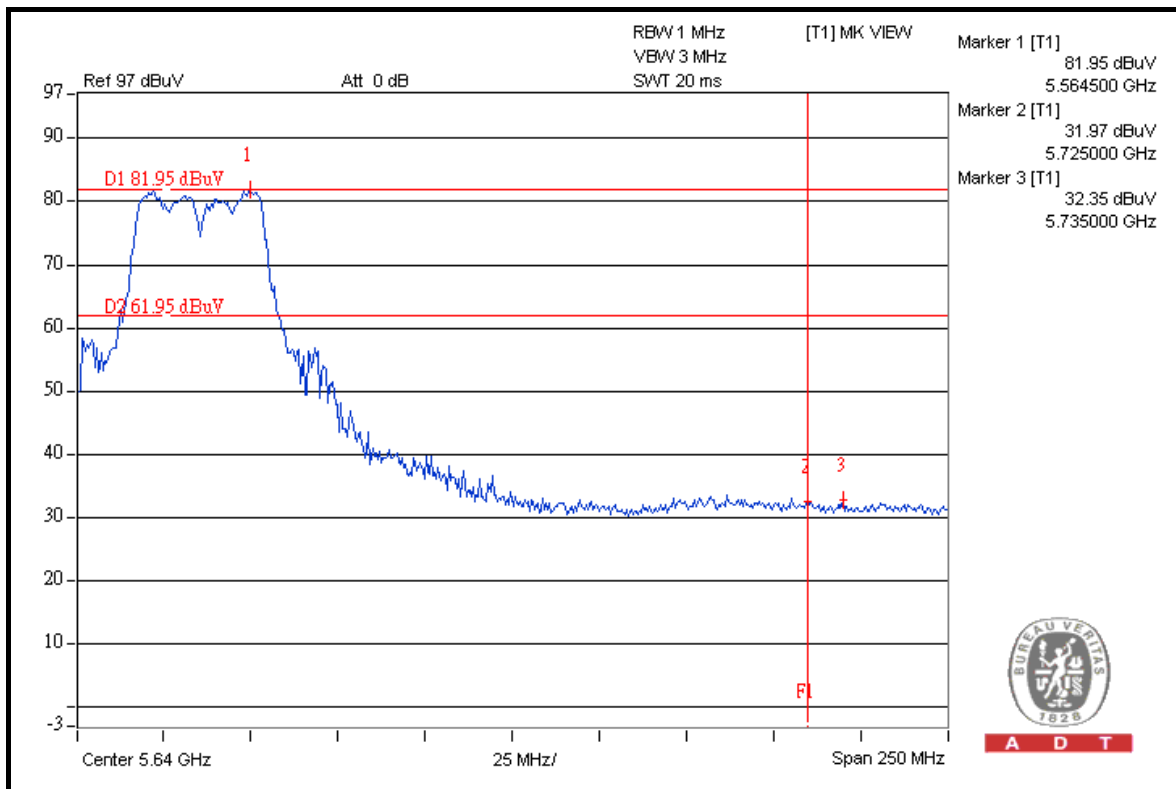
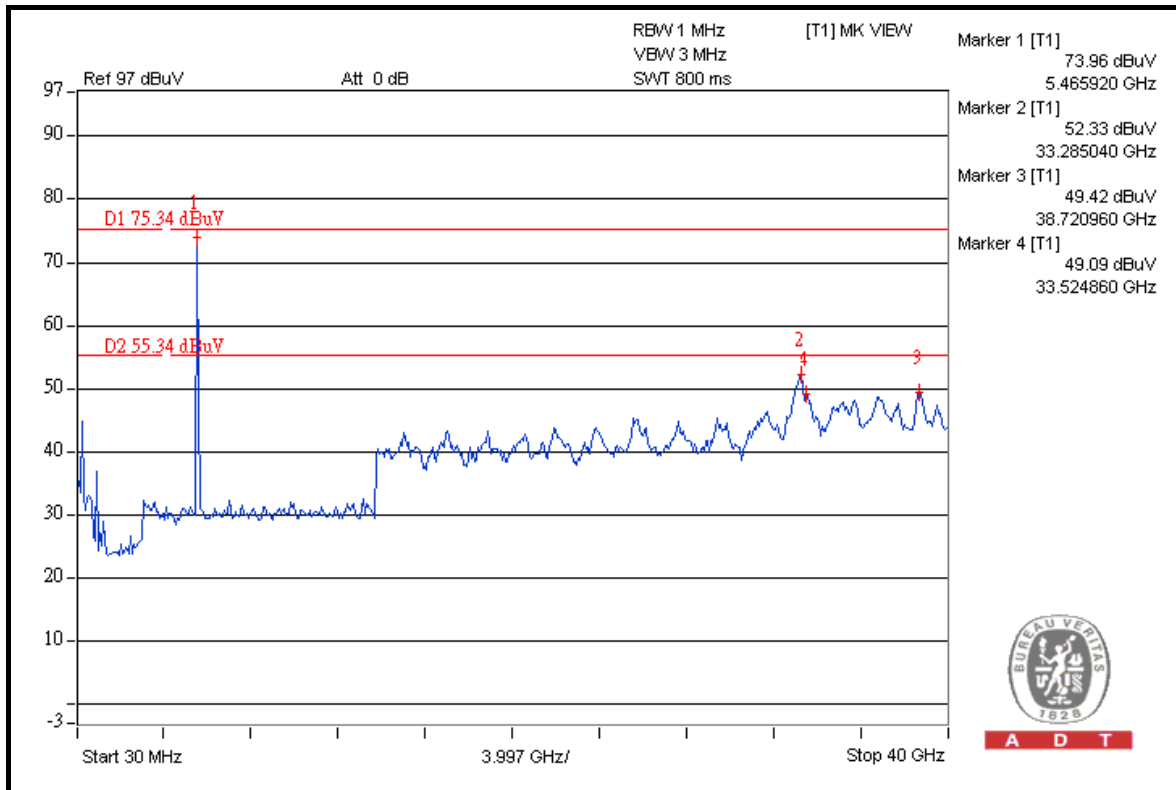



A D T

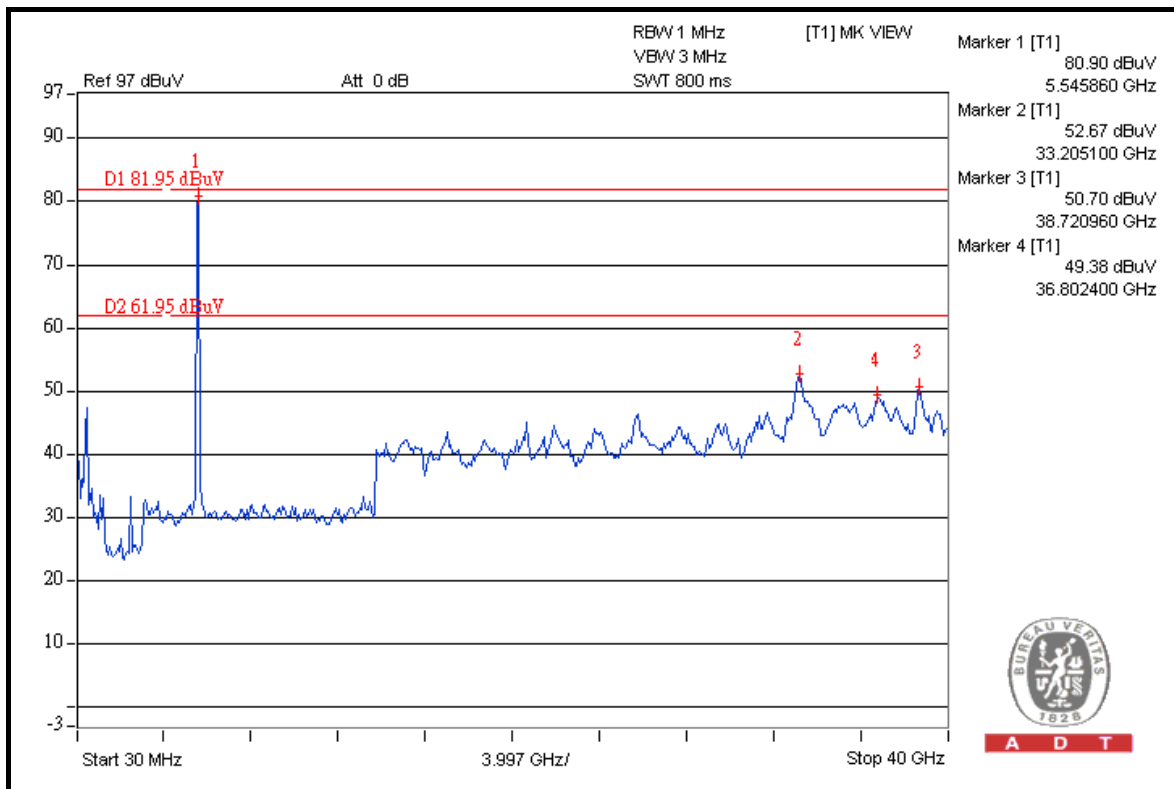
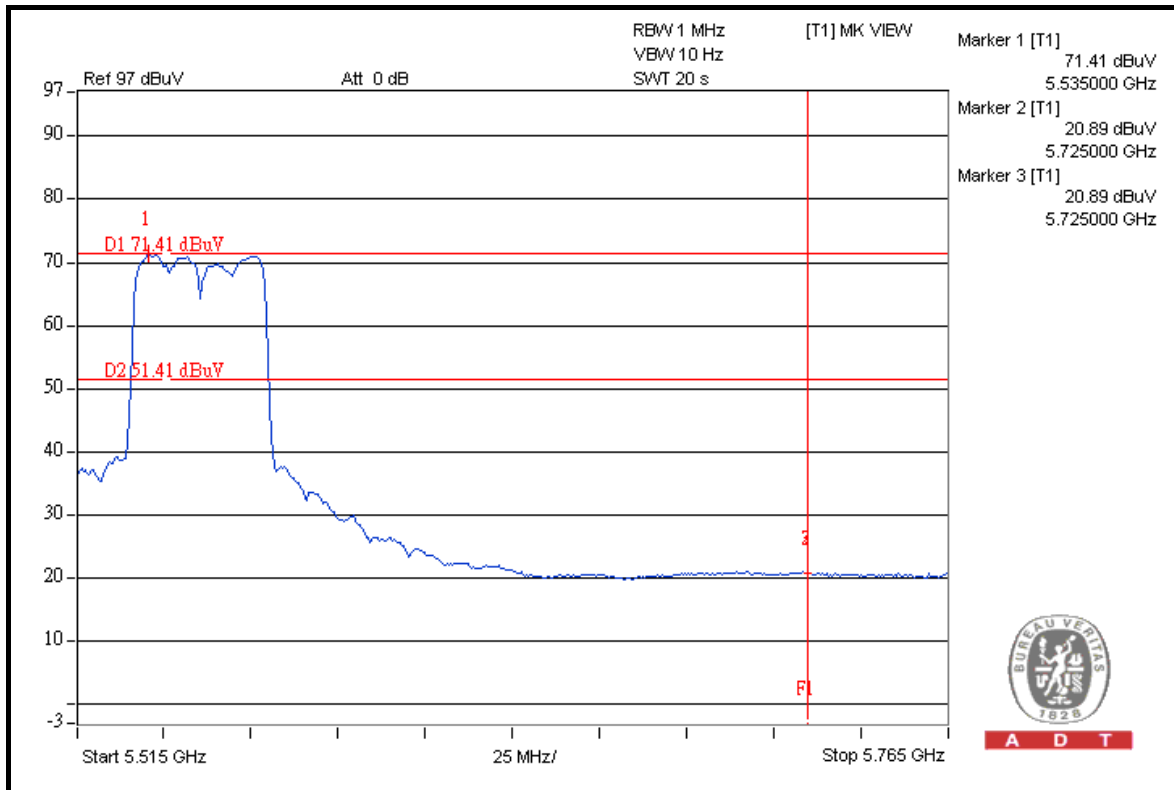



A D T

5. PHOTOGRAPHS OF THE TEST CONFIGURATION

Please refer to the attached file (Test Setup Photo).



A D T

6. INFORMATION ON THE TESTING LABORATORIES

We, Bureau Veritas Consumer Products Services (H.K.) Ltd., Taoyuan Branch, were founded in 1988 to provide our best service in EMC, Radio, Telecom and Safety consultation. Our laboratories are accredited and approved according to ISO/IEC 17025.

Copies of accreditation certificates of our laboratories obtained from approval agencies can be downloaded from our web site:

www.adt.com.tw/index.5/phtml. If you have any comments, please feel free to contact us at the following:

Linko EMC/RF Lab:

Tel: 886-2-26052180

Fax: 886-2-26051924

Hsin Chu EMC/RF Lab:

Tel: 886-3-5935343

Fax: 886-3-5935342

Hwa Ya EMC/RF/Safety Telecom Lab:

Tel: 886-3-3183232

Fax: 886-3-3185050

Web Site: www.adt.com.tw

The address and road map of all our labs can be found in our web site also.



A D T

7. APPENDIX A - MODIFICATIONS RECORDERS FOR ENGINEERING CHANGES TO THE EUT BY THE LAB

No any modifications are made to the EUT by the lab during the test.

---END---