



SPORTON International Inc.

No. 52, Hwa Ya 1st Rd., Kwei-Shan Hsiang, TaoYuan Hsien, Taiwan, R.O.C.
Ph: 886-3-327-3456 / FAX: 886-3-327-0973 / www.sporton.com.tw

FCC RADIO TEST REPORT

Applicant's company	NETGEAR Inc.
Applicant Address	4500 Great America Parkway, Santa Clara, CA 95054, USA
FCC ID	PY307300072
Manufacturer's company	Ambit Microsystems (Shanghai) Ltd.
Manufacturer Address	No. 1925, Nanle Road, Songjiang Export Processing Zone, Shanghai, China

Product Name	RangeMax Duo Wireless-N Router
Brand Name	NETGEAR
Model Name	WNDR3300
Test Rule Part(s)	47 CFR FCC Part 15 Subpart E § 15.407
Test Freq. Range	5150 ~ 5250MHz
Received Date	Nov. 24, 2007
Final Test Date	Dec. 27, 2007
Submission Type	Original Equipment
Operating Mode	Master



Statement

Test result included is only for the Draft n (5150 ~ 5250MHz) of the product.

The test result in this report refers exclusively to the presented test model / sample.

Without written approval of SPORTON International Inc., the test report shall not be reproduced except in full.

The measurements and test results shown in this test report were made in accordance with the procedures and found in compliance with the limit given in **ANSI C63.4-2003** and **47 CFR FCC Part 15 Subpart E**.

The test equipment used to perform the test is calibrated and traceable to NML/ROC.



Table of Contents

1. CERTIFICATE OF COMPLIANCE	1
2. SUMMARY OF THE TEST RESULT	2
3. GENERAL INFORMATION	3
3.1. Product Details.....	3
3.2. Accessories.....	4
3.3. Table for Filed Antenna.....	5
3.4. Table for Carrier Frequencies	6
3.5. Table for Test Modes.....	6
3.6. Table for Testing Locations.....	6
3.7. Table for Supporting Units	7
3.8. Table for Parameters of Test Software Setting	7
3.9. Test Configurations	8
4. TEST RESULT	10
4.1. AC Power Line Conducted Emissions Measurement.....	10
4.2. 99% Occupied Bandwidth Measurement	14
4.3. Maximum Conducted Output Power Measurement.....	19
4.4. Power Spectral Density Measurement	27
4.5. Peak Excursion Measurement.....	32
4.6. Radiated Emissions Measurement	37
4.7. Band Edge Emissions Measurement	53
4.8. Frequency Stability Measurement	58
4.9. Antenna Requirements	60
5. LIST OF MEASURING EQUIPMENTS	61
6. TEST LOCATION.....	63
7. TAF CERTIFICATE OF ACCREDITATION	64
APPENDIX A. PHOTOGRAPHS OF EUT.....	A1 ~ A17
APPENDIX B. TEST PHOTOS.....	B1 ~ B5
APPENDIX C. MPE REPORT	C1 ~ C3



1. CERTIFICATE OF COMPLIANCE

Product Name : RangeMax Duo Wireless-N Router
Brand Name : NETGEAR
Model Name : WNDR3300
Applicant : NETGEAR Inc.
Test Rule Part(s) : 47 CFR FCC Part 15 Subpart E § 15.407

Sporton International as requested by the applicant to evaluate the EMC performance of the product sample received on Nov. 24, 2007 would like to declare that the tested sample has been evaluated and found to be in compliance with the tested rule parts. The data recorded as well as the test configuration specified is true and accurate for showing the sample's EMC nature.



Wayne Hsu

SPORTON INTERNATIONAL INC.

2. SUMMARY OF THE TEST RESULT

Applied Standard: 47 CFR FCC Part 15 Subpart E				
Part	Rule Section	Description of Test	Result	Under Limit
4.1	15.207	AC Power Line Conducted Emissions	Complies	7.81 dB
4.2	15.407(a)	26dB Spectrum Bandwidth	Complies	-
4.3	15.407(a)	Maximum Conducted Output Power	Complies	0.01 dB
4.4	15.407(a)	Power Spectral Density	Complies	5.51 dB
4.5	15.407(a)	Peak Excursion	Complies	6.65 dB
4.6	15.407(b)	Radiated Emissions	Complies	3.11 dB
4.7	15.407(b)	Band Edge Emissions	Complies	0.20 dB
4.8	15.407(g)	Frequency Stability	Complies	-
4.9	15.203	Antenna Requirements	Complies	-

Test Items	Uncertainty	Remark
AC Power Line Conducted Emissions	±2.3dB	Confidence levels of 95%
Maximum Conducted Output Power	±0.5dB	Confidence levels of 95%
Power Spectral Density	±0.5dB	Confidence levels of 95%
Peak Excursion	±0.5dB	Confidence levels of 95%
26dB Spectrum Bandwidth / Frequency Stability	±8.5×10 ⁻⁸	Confidence levels of 95%
Radiated Emissions (9kHz~30MHz)	±0.8dB	Confidence levels of 95%
Radiated Emissions (30MHz~1000MHz)	±1.9dB	Confidence levels of 95%
Radiated / Band Edge Emissions (1GHz~18GHz)	±1.9dB	Confidence levels of 95%
Radiated Emissions (18GHz~40GHz)	±1.9dB	Confidence levels of 95%
Temperature	±0.7°C	Confidence levels of 95%
Humidity	±3.2%	Confidence levels of 95%
DC / AC Power Source	±1.4%	Confidence levels of 95%

3. GENERAL INFORMATION

3.1. Product Details

Items	Description
Product Type	WLAN (2TX, 3RX)
Radio Type	Intentional Transceiver
Power Type	From Adapter
Modulation	see the below table for draft n
Data Modulation	OFDM (BPSK / QPSK / 16QAM / 64QAM)
Data Rate (Mbps)	see the below table for Draft n
Frequency Range	5150 ~ 5250MHz
Channel Number	4 for 20MHz bandwidth ; 2 for 40MHz bandwidth
Channel Band Width (99%)	MCS8 (20MHz) : 17.56 MHz MCS8 (40MHz) : 36.05 MHz
Conducted Output Power	Band 1: MCS8 (20MHz) : 16.07 dBm MCS8 (40MHz) : 15.97 dBm
Carrier Frequencies	Please refer to section 3.4
Antenna	Please refer to section 3.3

Antenna & Band width

Antenna	Single (TX)		Two (TX)	
	20 MHz	40 MHz	20 MHz	40 MHz
802.11a Draft n	X	X	V	V

Draft n spec

MCS Index	Nss	Modulation	R	NBPS	NCBPS		NDBPS		Data rate(Mbps)			
					800nsGI		20MHz	40MHz	20MHz	40MHz	20MHz	40MHz
					20MHz	40MHz						
0	1	BPSK	$\frac{1}{2}$	1	52	108	26	54	6.5	13.5		
1	1	QPSK	$\frac{1}{2}$	2	104	216	52	108	13.0	27.0		
2	1	QPSK	$\frac{3}{4}$	2	104	216	78	162	19.5	40.5		
3	1	16-QAM	$\frac{1}{2}$	4	208	432	104	216	26.0	54.0		
4	1	16-QAM	$\frac{3}{4}$	4	208	432	156	324	39.0	81.0		
5	1	64-QAM	$\frac{2}{3}$	6	312	648	208	432	52.0	108.0		
6	1	64-QAM	$\frac{3}{4}$	6	312	648	234	486	58.5	121.5		
7	1	64-QAM	$\frac{5}{6}$	6	312	648	260	540	65.0	135.0		
8	2	BPSK	$\frac{1}{2}$	1	104	216	52	108	13.0	27.0		
9	2	QPSK	$\frac{1}{2}$	2	208	432	104	216	26.0	54.0		
10	2	QPSK	$\frac{3}{4}$	2	208	432	156	324	39.0	81.0		
11	2	16-QAM	$\frac{1}{2}$	4	416	864	208	432	52.0	108.0		
12	2	16-QAM	$\frac{3}{4}$	4	416	864	312	648	78.0	162.0		
13	2	64-QAM	$\frac{2}{3}$	6	624	1296	416	864	104.0	216.0		
14	2	64-QAM	$\frac{3}{4}$	6	624	1296	468	972	117.0	243.0		
15	2	64-QAM	$\frac{5}{6}$	6	624	1296	520	1080	130.0	270.0		

Symbol	Explanation
NSS	Number of spatial streams
R	Code rate
NBPS	Number of coded bits per single carrier
NCBPS	Number of coded bits per symbol
NDBPS	Number of data bits per symbol
GI	guard interval

3.2. Accessories

Power	Brand	Model	Rating
Adapter 1	NETGEAR	DSA-20P-10 US 120180	Input: 100-240VAC, 50/60Hz, 0.7A Output: 12VDC, 1.5A
Adapter 2	NETGEAR	MU18-2120150-A1	Input: 100-240VAC, 50/60Hz, 0.6A Output: 12VDC, 1.5A

3.3. Table for Filed Antenna

For 5GHz Band

Ant.	Brand	Model Name	Antenna Type	Connector	Gain (dBi)	Remark
3	-	-	Printed Antenna	NA	6.92	TX / RX Ant.
4	-	-	Printed Antenna	NA	6.50	RX Ant.
5	-	-	Printed Antenna	NA	6.92	TX / RX Ant.

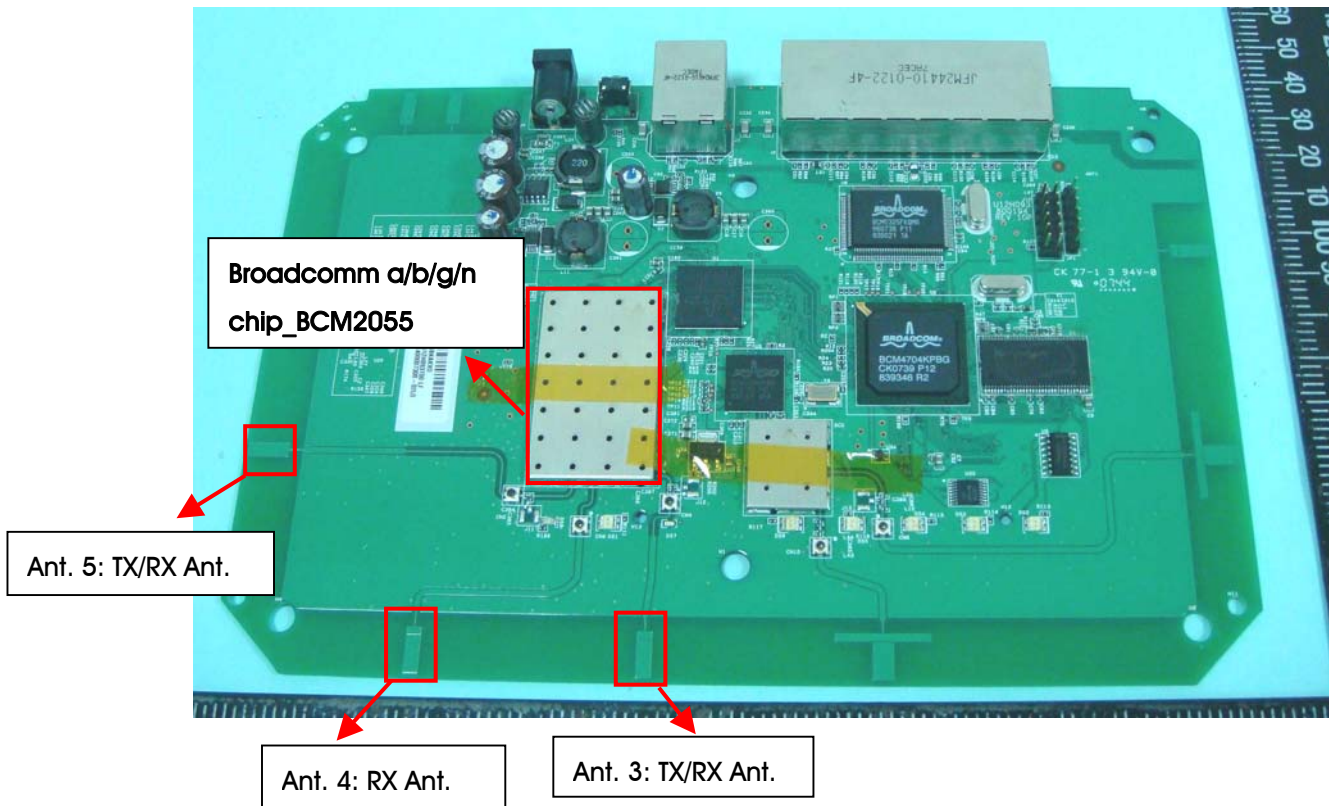

3.4. Table for Carrier Frequencies

There are two bandwidth systems for draft n.

For both 20MHz bandwidth systems, use Channel 36, 40, 44, 48.

For both 40MHz bandwidth systems, use Channel 38, 46.

Frequency Band	Channel No.	Frequency	Channel No.	Frequency
5150~5250 MHz Band 1	36	5180 MHz	44	5220 MHz
	38	5190 MHz	46	5230 MHz
	40	5200 MHz	48	5240 MHz

3.5. Table for Test Modes

Preliminary tests were performed in different data rate to find the worst radiated emission. The data rate shown in the table below is the worst-case rate with respect to the specific test item. Investigation has been done on all the possible configurations for searching the worst cases. The following table is a list of the test modes shown in this test report.

Test Items	Mode		Data Rate	Channel	Antenna
AC Power Conducted Emission	Normal Link		Auto	-	-
Max. Conducted Output Power	MCS8/20MHz	Band 1	13Mbps	36/46/48	N/A
	MCS8/40MHz	Band 1	27Mbps	38/40	N/A
26dB Spectrum Bandwidth 99% Occupied Bandwidth Measurement Power Spectral Density Peak Excursion	MCS8/20MHz	Band 1	13Mbps	36/46/48	N/A
	MCS8/40MHz	Band 1	27Mbps	38/40	N/A
Radiated Emission Below 1GHz	Normal Link		Auto	-	-
Radiated Emission Above 1GHz	MCS8/20MHz	Band 1	13Mbps	36/46/48	3/5
	MCS8/40MHz	Band 1	27Mbps	38/40	3/5
Band Edge Emission	MCS8/20MHz	Band 1	13Mbps	36/46/48	3/5
	MCS8/40MHz	Band 1	27Mbps	38/40	3/5
Frequency Stability	Un-modulation		-	-	N/A

3.6. Table for Testing Locations

Test Site No.	Site Category	Location	FCC Reg. No.	IC File No.	VCCI Reg. No
03CH03-HY	SAC	Hwa Ya	101377	IC 4088	-
CO04-HY	Conduction	Hwa Ya	101377	IC 4088	-
TH01-HY	OVEN Room	Hwa Ya	-	-	-

Open Area Test Site (OATS); Semi Anechoic Chamber (SAC); Fully Anechoic Chamber (FAC).

Please refer section 6 for Test Site Address.

3.7. Table for Supporting Units

Support Unit	Brand	Model	FCC ID
Notebook	DELL	D505	E2K24GBRL
Notebook	DELL	D505	E2K24GBRL
Notebook	DELL	D400	E2K24GBRL

3.8. Table for Parameters of Test Software Setting

During testing, Channel & Power Controlling Software provided by the customer was used to control the operating channel as well as the output power level. The RF output power selection is for the setting of RF output power expected by the customer and is going to be fixed on the firmware of the final end product.

Power Parameters of Draft n MCS8 20MHz

Test Software Version	Telnet		
Frequency	5180 MHz	5200 MHz	5240 MHz
Draft n	3c4a	3d4b	414e

Power Parameters of Draft n MCS8 40MHz

Test Software Version	Telnet	
Frequency	5190 MHz	5230 MHz
Draft n	3b4d	424f

3.9. Test Configurations

3.9.1. Radiation Emissions Test Configuration

Test Configuration: 9KHz~1GHz

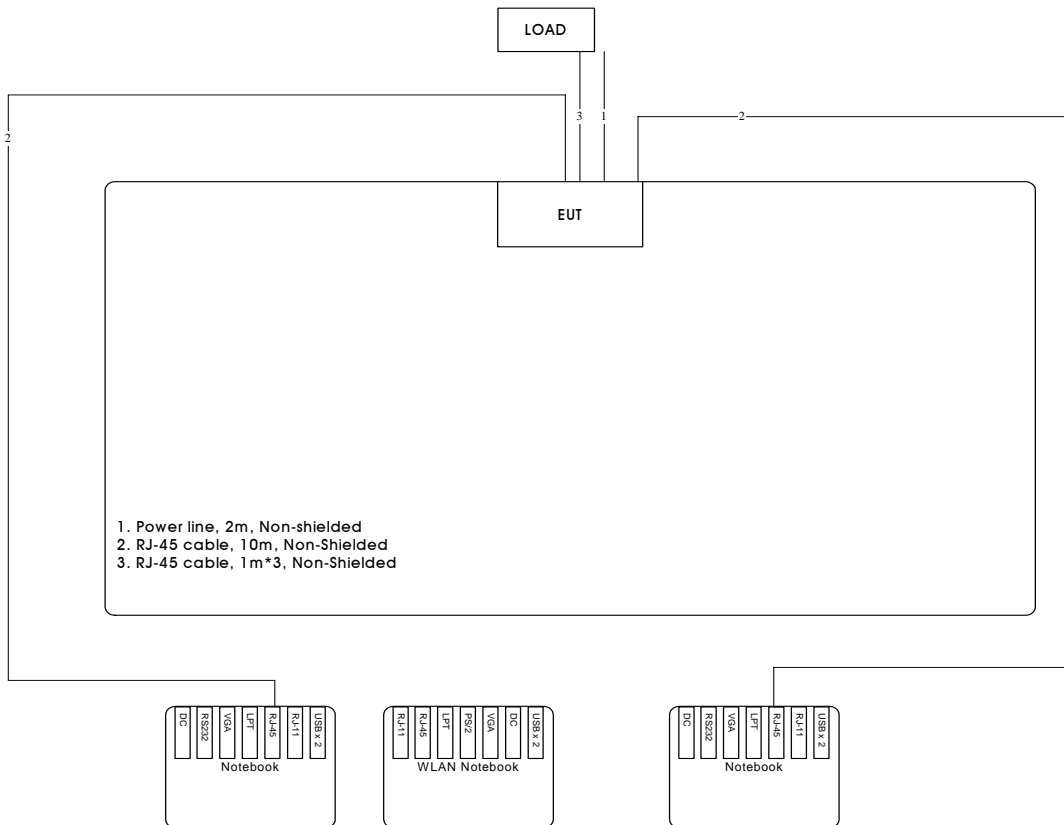

Test Configuration: above 1GHz

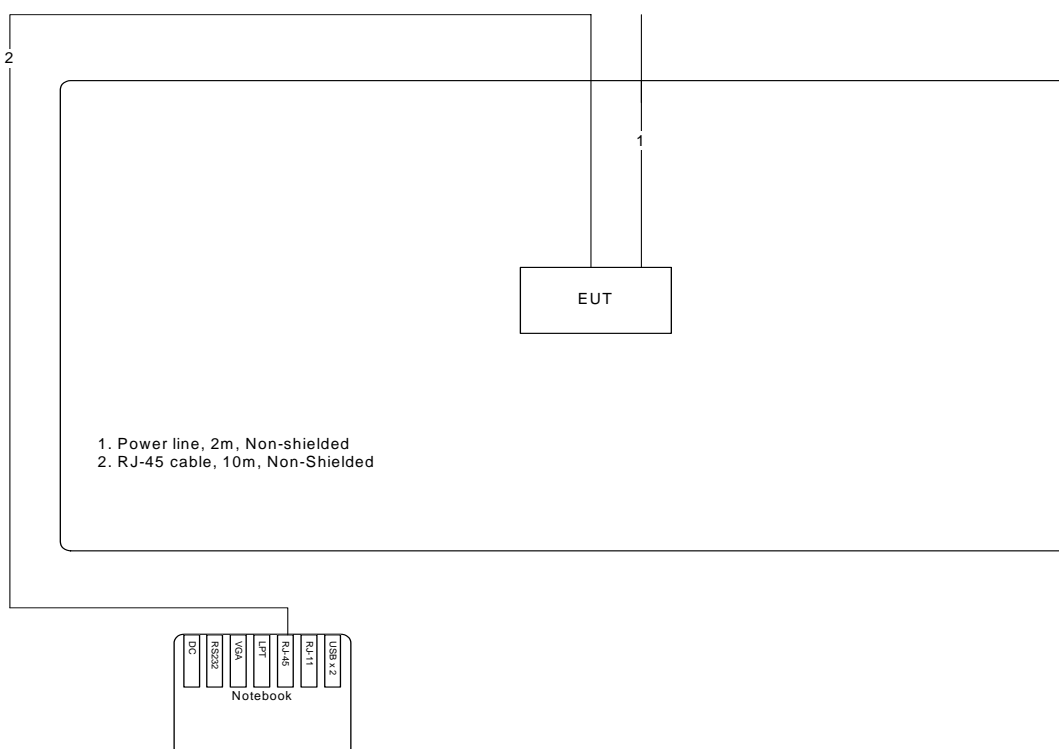

3.9.2. AC Power Line Conduction Emissions Test Configuration

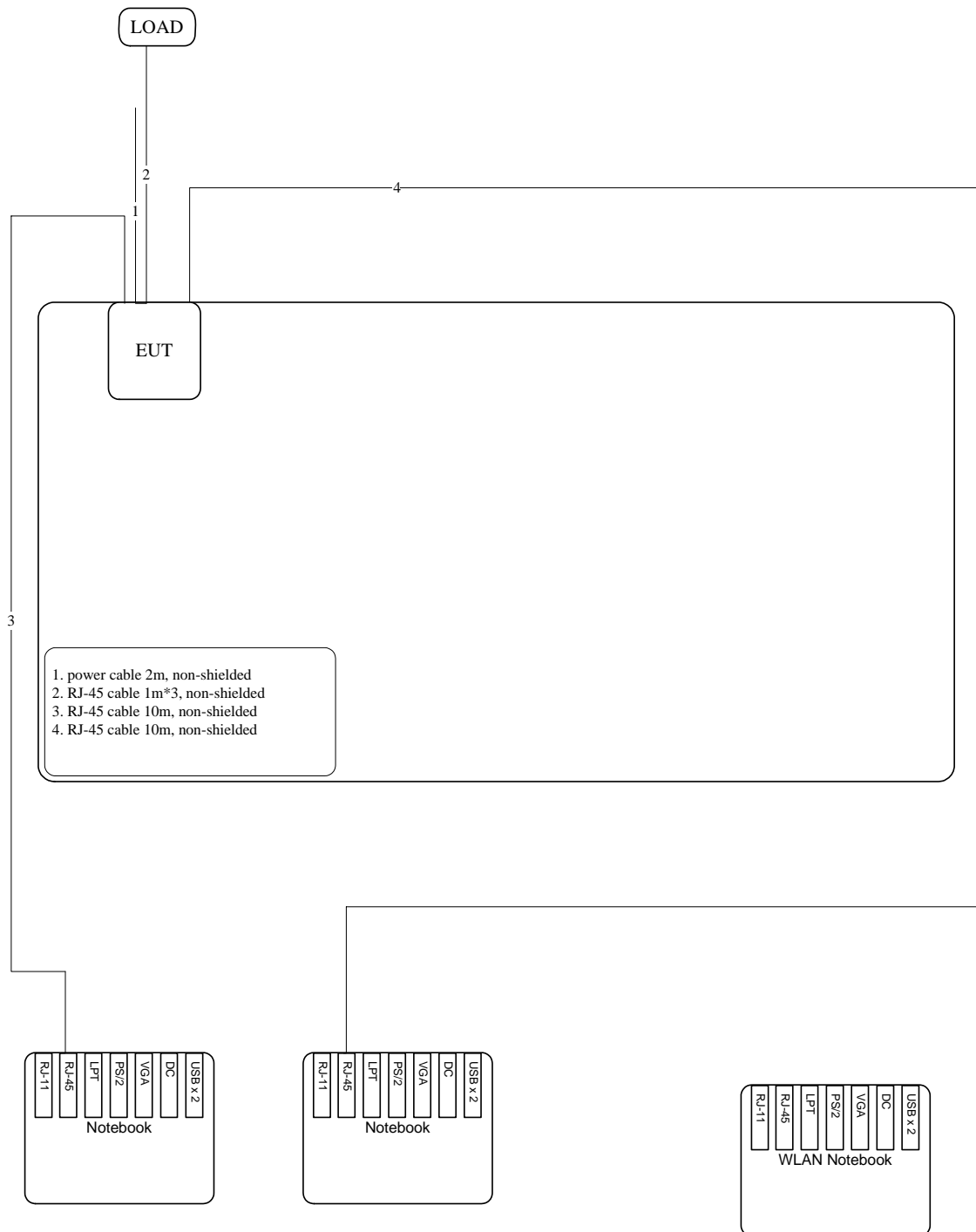

4. TEST RESULT

4.1. AC Power Line Conducted Emissions Measurement

4.1.1. Limit

For this product that is designed to connect to the AC power line, the radio frequency voltage that is conducted back onto the AC power line on any frequency or frequencies within the band 150 kHz to 30 MHz shall not exceed below limits table.

Frequency (MHz)	QP Limit (dBuV)	AV Limit (dBuV)
0.15~0.5	66~56	56~46
0.5~5	56	46
5~30	60	50

4.1.2. Measuring Instruments and Setting

Please refer to section 5 of equipments list in this report. The following table is the setting of the receiver.

Receiver Parameters	Setting
Attenuation	10 dB
Start Frequency	0.15 MHz
Stop Frequency	30 MHz
IF Bandwidth	9 KHz

4.1.3. Test Procedures

1. Configure the EUT according to ANSI C63.4. The EUT or host of EUT has to be placed 0.4 meter far from the conducting wall of the shielding room and at least 80 centimeters from any other grounded conducting surface.
2. Connect EUT or host of EUT to the power mains through a line impedance stabilization network (LISN).
3. All the support units are connected to the other LISNs. The LISN should provide 50uH/50ohms coupling impedance.
4. The frequency range from 150 KHz to 30 MHz was searched.
5. Set the test-receiver system to Peak Detect Function and Specified Bandwidth with Maximum Hold Mode.
6. The measurement has to be done between each power line and ground at the power terminal.

4.1.4. Test Setup Layout

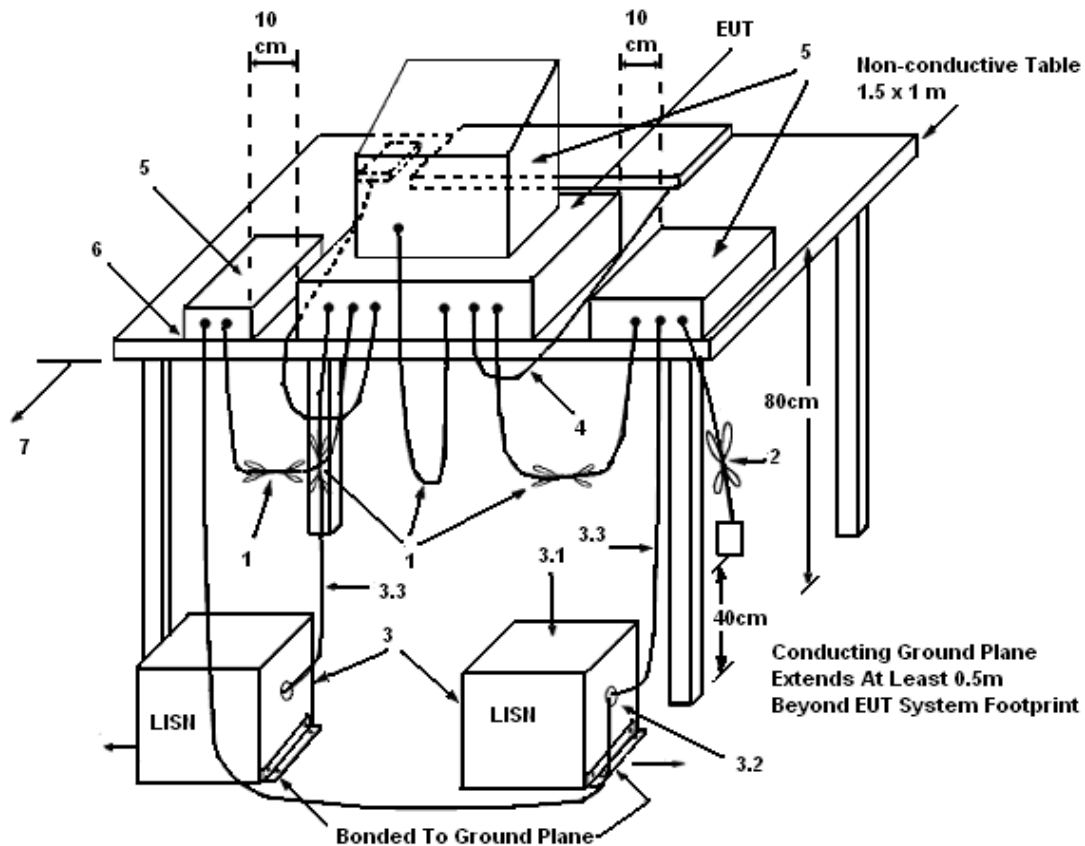

LEGEND:

- (1) Interconnecting cables that hang closer than 40 cm to the ground plane shall be folded back and forth in the center forming a bundle 30 to 40 cm long.
- (2) I/O cables that are not connected to a peripheral shall be bundled in the center. The end of the cable may be terminated, if required, using the correct terminating impedance. The overall length shall not exceed 1 m.
- (3) EUT connected to one LISN. Unused LISN measuring port connectors shall be terminated in 50Ω . LISN can be placed on top of, or immediately beneath, reference ground plane.
 - (3.1) All other equipment powered from additional LISN(s).
 - (3.2) Multiple outlet strip can be used for multiple power cords of non-EUT equipment.
 - (3.3) LISN at least 80 cm from nearest part of EUT chassis.
- (4) Cables of hand-operated devices, such as keyboards, mice, etc., shall be placed as for normal use.
- (5) Non-EUT components of EUT system being tested.
- (6) Rear of EUT, including peripherals, shall all be aligned and flush with rear of tabletop.
- (7) Rear of tabletop shall be 40 cm removed from a vertical conducting plane that is bonded to the ground plane.

4.1.5. Test Deviation

There is no deviation with the original standard.

4.1.6. EUT Operation during Test

The EUT was placed on the test table and programmed in normal function.

4.1.7. Results of AC Power Line Conducted Emissions Measurement

Temperature	23°C	Humidity	54%
Test Engineer	Barry Chen	Phase	Line
Configuration	Normal Link		

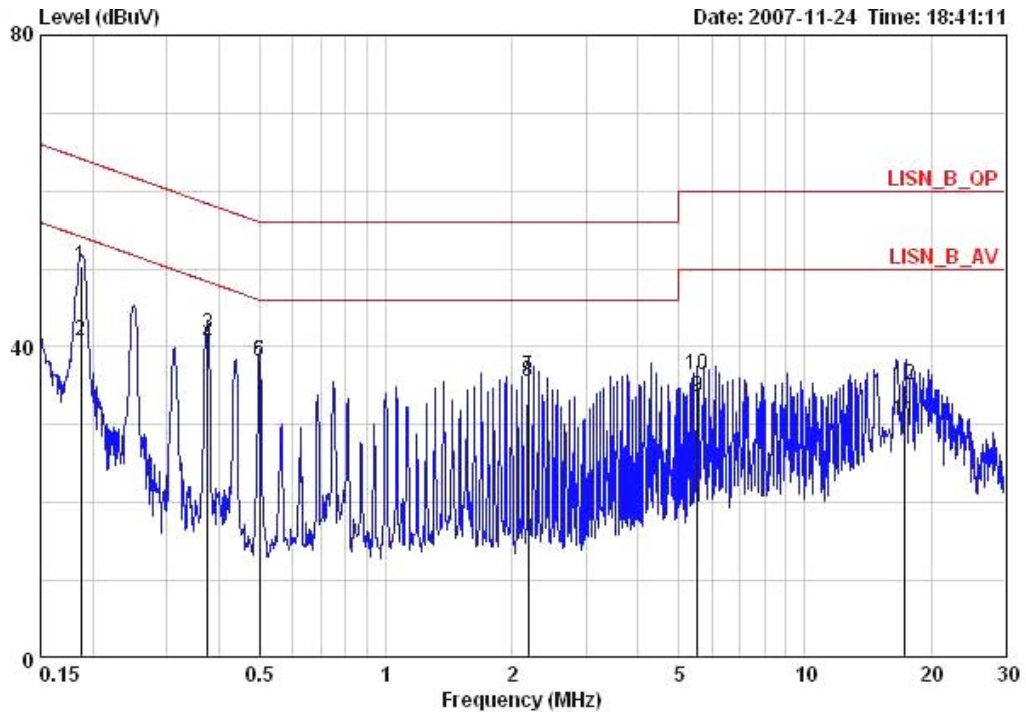

	Freq	Level	Over Limit	Limit Line	Read Level	LISN Factor	Cable Loss	Remark	Pol/Phase
	MHz	dBuV	dB	dBuV	dBuV	dB	dB		
1	0.18699	50.37	-13.80	64.17	50.02	0.15	0.20	QP	LINE
2	0.18699	40.77	-13.40	54.17	40.42	0.15	0.20	AVERAGE	LINE
3	0.37512	41.63	-16.76	58.39	41.33	0.10	0.20	QP	LINE
4	0.37512	40.43	-7.96	48.39	40.13	0.10	0.20	AVERAGE	LINE
5	0.49897	38.20	-17.82	56.02	37.92	0.08	0.20	QP	LINE
6	0.49897	38.17	-7.85	46.02	37.89	0.08	0.20	AVERAGE	LINE
7	2.184	36.20	-19.80	56.00	36.00	0.00	0.20	QP	LINE
8	2.184	35.52	-10.48	46.00	35.32	0.00	0.20	AVERAGE	LINE
9	5.553	33.56	-16.44	50.00	33.23	0.03	0.30	AVERAGE	LINE
10	5.553	36.47	-23.53	60.00	36.14	0.03	0.30	QP	LINE
11	17.286	30.50	-19.50	50.00	29.90	0.10	0.50	AVERAGE	LINE
12	17.286	35.20	-24.80	60.00	34.60	0.10	0.50	QP	LINE

Temperature	23°C	Humidity	54%
Test Engineer	Barry Chen	Phase	Neutral
Configuration	Normal Link		

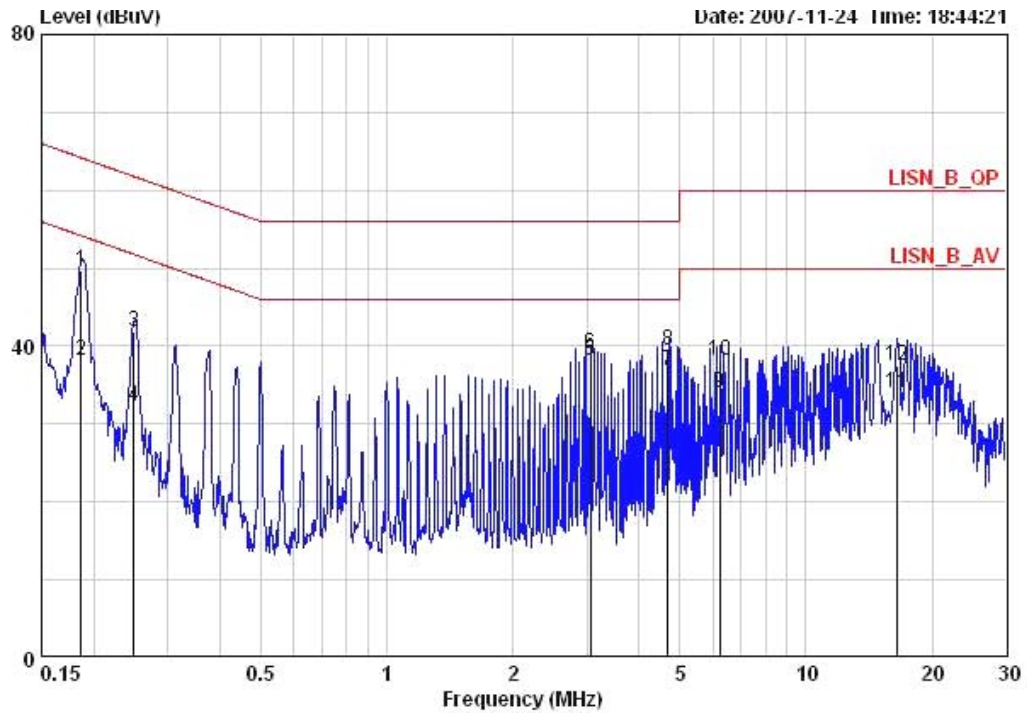

	Freq	Level	Over	Limit	Read	LISN	Cable	Remark	Pol/Phase
	MHz	dBuV	Limit	Line	Level	Factor	Loss		
			dB	dBuV	dBuV	dB	dB		
1	0.18659	49.63	-14.56	64.19	49.18	0.25	0.20	QP	NEUTRAL
2	0.18659	38.16	-16.03	54.19	37.71	0.25	0.20	AVERAGE	NEUTRAL
3	0.24958	41.79	-19.98	61.77	41.41	0.18	0.20	QP	NEUTRAL
4	0.24958	32.23	-19.54	51.77	31.85	0.18	0.20	AVERAGE	NEUTRAL
5	3.058	38.19	-7.81	46.00	37.88	0.10	0.21	AVERAGE	NEUTRAL
6	3.058	38.97	-17.03	56.00	38.66	0.10	0.21	QP	NEUTRAL
7	4.680	36.79	-9.21	46.00	36.39	0.10	0.30	AVERAGE	NEUTRAL
8	4.680	39.50	-16.50	56.00	39.10	0.10	0.30	QP	NEUTRAL
9	6.238	34.05	-15.95	50.00	33.60	0.10	0.35	AVERAGE	NEUTRAL
10	6.238	38.06	-21.94	60.00	37.61	0.10	0.35	QP	NEUTRAL
11	16.471	33.94	-16.06	50.00	33.44	0.10	0.40	AVERAGE	NEUTRAL
12	16.471	37.43	-22.57	60.00	36.93	0.10	0.40	QP	NEUTRAL

Note:

Level = Read Level + LISN Factor + Cable Loss.

4.2. 99% Occupied Bandwidth Measurement

4.2.1. Limit

No restriction limits. But resolution bandwidth within band edge measurement is 1% of the 99% occupied bandwidth.

4.2.2. Measuring Instruments and Setting

Please refer to section 5 of equipments list in this report. The following table is the setting of the spectrum analyzer.

Spectrum Parameters	Setting
Attenuation	Auto
Span Frequency	> 26dB Bandwidth
RB	300 kHz
VB	1000 kHz
Detector	Peak
Trace	Max Hold
Sweep Time	Auto

4.2.3. Test Procedures

1. The transmitter output (antenna port) was connected to the spectrum analyzer in peak hold mode.
2. The resolution bandwidth of 300 kHz and the video bandwidth of 1000 kHz were used.
3. Measured the spectrum width with power higher than 26dB below carrier.
4. Measuring multiple antennas, the connector is required to link with Power Meter through a combiner.

4.2.4. Test Setup Layout

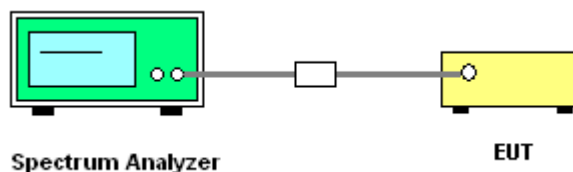

4.2.5. Test Deviation

There is no deviation with the original standard.

4.2.6. EUT Operation during Test

The EUT was programmed to be in continuously transmitting mode.

4.2.7. Test Result of 99% Occupied Bandwidth

Temperature	23°C	Humidity	56%
Test Engineer	Beck Wu	Configurations	Draft n

Configuration Draft n MCS8 20MHz Ant. 3 + Ant. 5

Channel	Frequency	26dB Bandwidth (MHz)	99% Occupied Bandwidth (MHz)
36	5180 MHz	22.05	17.56
40	5200 MHz	21.79	17.56
48	5240 MHz	22.05	17.43

Configuration Draft n MCS8 40MHz Ant. 3 + Ant. 5

Channel	Frequency	26dB Bandwidth (MHz)	99% Occupied Bandwidth (MHz)
38	5190 MHz	38.71	36.02
46	5230 MHz	38.78	36.05

26 dB Bandwidth Plot on Configuration Drafft n MCS8 20MHz Ant. 3 + Ant. 5 / 5180 MHz

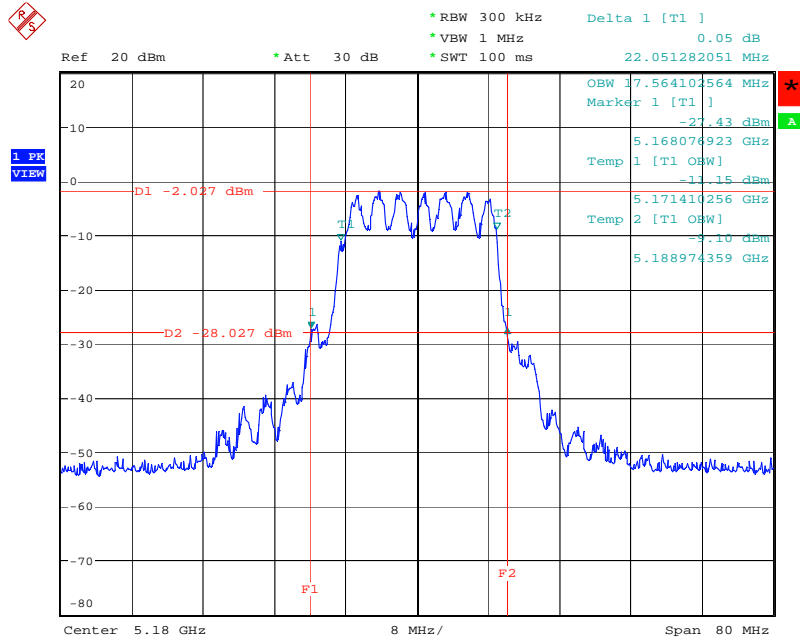

Date: 11.DEC.2007 14:37:43

26 dB Bandwidth Plot on Configuration Drafft n MCS8 20MHz Ant. 3 + Ant. 5 / 5200 MHz

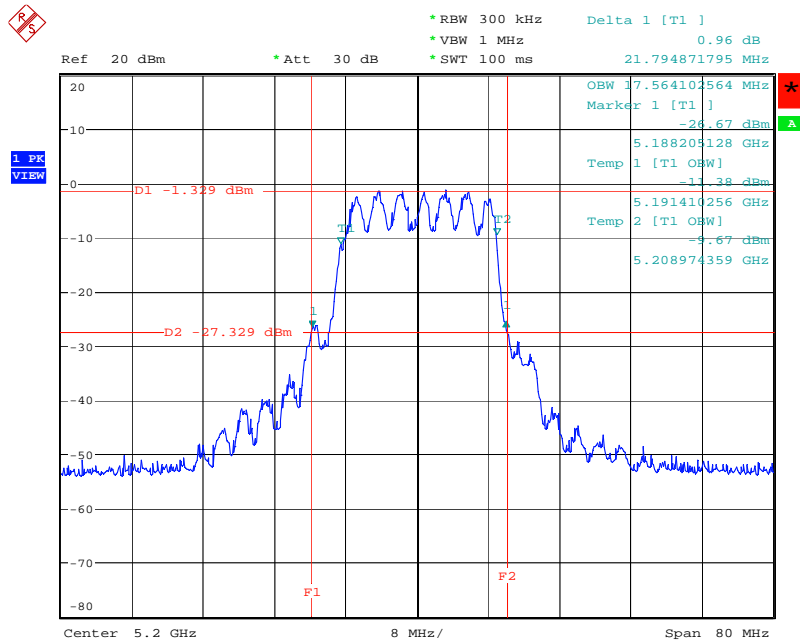

Date: 11.DEC.2007 14:39:52

26 dB Bandwidth Plot on Configuration Drafft n MCS8 20MHz Ant. 3 + Ant. 5 / 5240 MHz

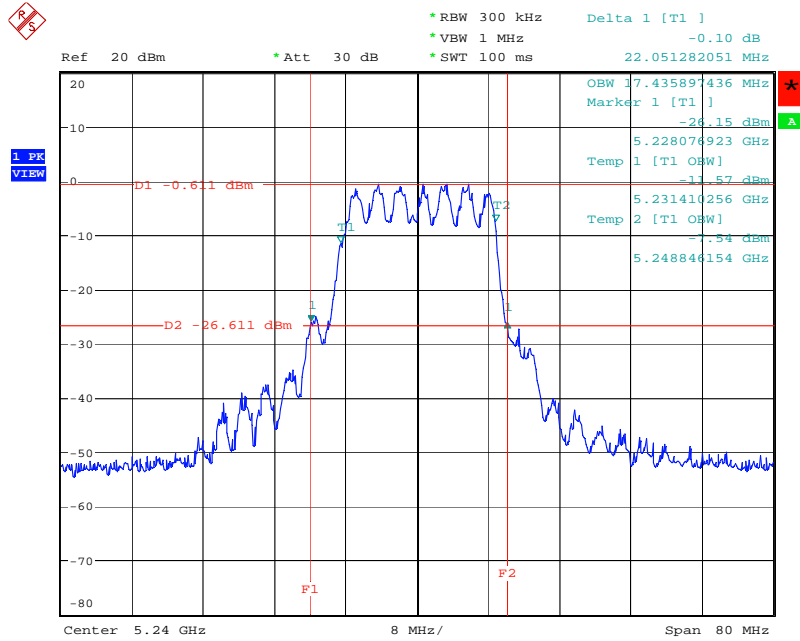

Date: 11.DEC.2007 14:42:00

26 dB Bandwidth Plot on Configuration Drafft n MCS8 40MHz Ant. 3 + Ant. 5 / 5190 MHz

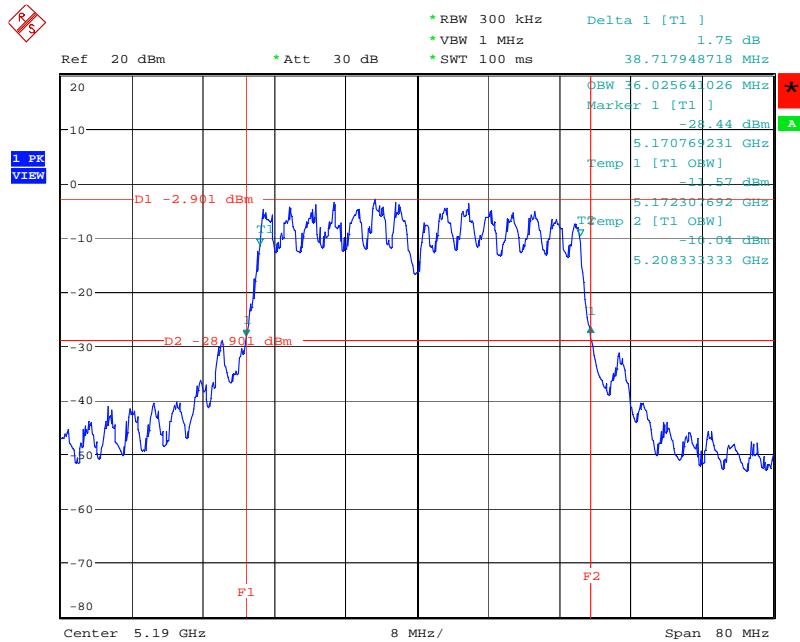

Date: 11.DEC.2007 14:34:13

4.3. Maximum Conducted Output Power Measurement

4.3.1. Limit

For the band 5.15~5.25 GHz, the maximum conducted output power over the frequency band of operation shall not exceed the lesser of 50 mW (17dBm) or $4 \text{ dBm} + 10\log B$, where B is the 26 dB emissions bandwidth in MHz. If transmitting antennas of directional gain greater than 6 dBi are used, the peak output power and power density from the intentional radiator shall be reduced by the amount in dB that the directional gain of the antenna exceeds 6 dBi.

However, fixed point-to-point U-NII devices operating in this band may employ transmitting antennas with directional gain up to 23 dBi without any corresponding reduction in the transmitter peak output power and peak power spectral density. For fixed, point-to-point U-NII transmitters that employ a directional antenna gain greater than 23 dBi, a 1 dB reduction in peak transmitter power and peak power spectral density for each 1 dB of antenna gain in excess of 23 dBi would be required.

4.3.2. Measuring Instruments and Setting

Please refer to section 5 of equipments list in this report. The following table is the setting of the spectrum analyzer.

Spectrum Parameter	Setting
Attenuation	Auto
Span Frequency	Encompass the entire emissions bandwidth (EBW) of the signal
RB	1000 kHz
VB	3000 kHz
Detector	PEAK
Trace	MAX HOLD
Sweep Time	20ms

4.3.3. Test Procedures

1. The transmitter output (antenna port) was connected to the spectrum analyzer.
2. Test was performed in accordance with FCC Conference Call, June 10, 2003.
3. When measuring maximum conducted output power with multiple antenna systems, add every result of the values by mathematic formula.

4.3.4. Test Setup Layout

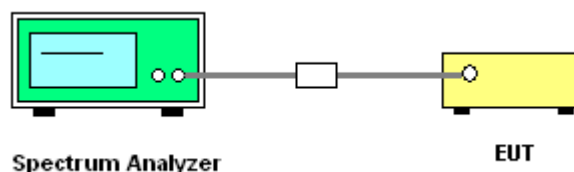

4.3.5. Test Deviation

There is no deviation with the original standard.

4.3.6. EUT Operation during Test

The EUT was programmed to be in continuously transmitting mode.

4.3.7. Test Result of Maximum Conducted Output Power

Temperature	23°C	Humidity	56%
Test Engineer	Beck Wu	Configurations	Draft n

Configuration Draft n MCS8 20MHz Ant. 3

Channel	Frequency	Conducted Power (dBm)	Max. Limit (dBm)	Result
36	5180 MHz	13.09	16.08	Complies
40	5200 MHz	13.13	16.08	Complies
48	5240 MHz	13.03	16.08	Complies

Configuration Draft n MCS8 20MHz Ant. 5

Channel	Frequency	Conducted Power (dBm)	Max. Limit (dBm)	Result
36	5180 MHz	13.00	16.08	Complies
40	5200 MHz	12.99	16.08	Complies
48	5240 MHz	12.91	16.08	Complies

Configuration Draft n MCS8 20MHz Ant. 3 + Ant. 5

Channel	Frequency	Conducted Power (dBm)	Max. Limit (dBm)	Result
36	5180 MHz	16.06	16.08	Complies
40	5200 MHz	16.07	16.08	Complies
48	5240 MHz	15.98	16.08	Complies

Configuration Draft n MCS8 40MHz Ant. 3

Channel	Frequency	Conducted Power (dBm)	Max. Limit (dBm)	Result
38	5190 MHz	13.01	16.08	Complies
46	5230 MHz	13.04	16.08	Complies

Configuration Draft n MCS8 40MHz Ant. 5

Channel	Frequency	Conducted Power (dBm)	Max. Limit (dBm)	Result
38	5190 MHz	12.90	16.08	Complies
46	5230 MHz	12.87	16.08	Complies

Configuration Draft n MCS8 40MHz Ant. 3 + Ant. 5

Channel	Frequency	Conducted Power (dBm)	Max. Limit (dBm)	Result
38	5190 MHz	15.97	16.08	Complies
46	5230 MHz	15.97	16.08	Complies

Channel Output Power Plot on Configuration Draft n MCS8 20MHz Ant. 3 / 5180 MHz

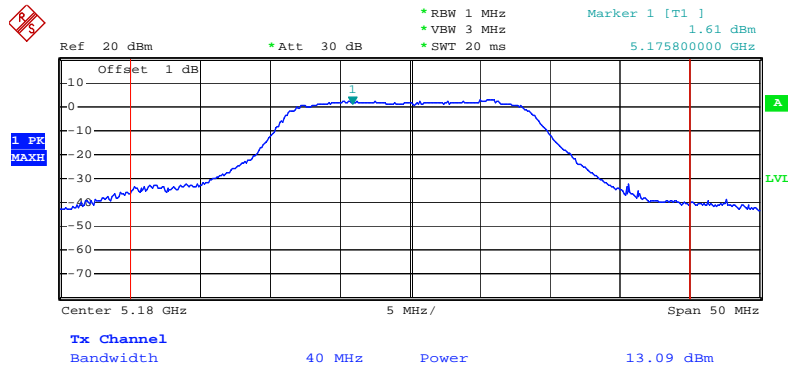

Date: 27.DEC.2007 03:55:08

Channel Output Power Plot on Configuration Draft n MCS8 20MHz Ant. 5 / 5180 MHz

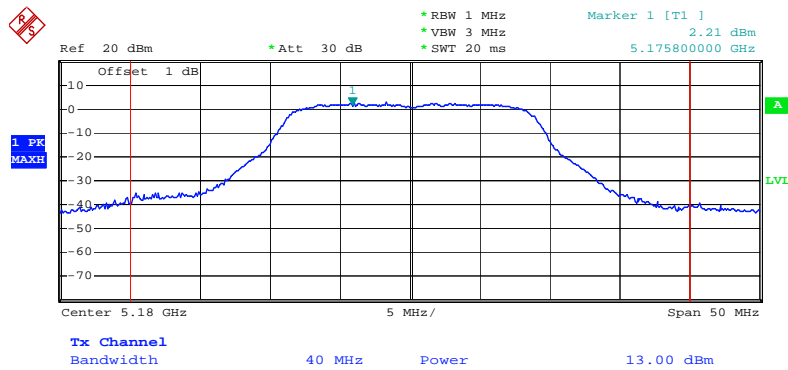

Date: 27.DEC.2007 03:59:33

Channel Output Power Plot on Configuration Draft n MCS8 40MHz Ant. 3 / 5190 MHz

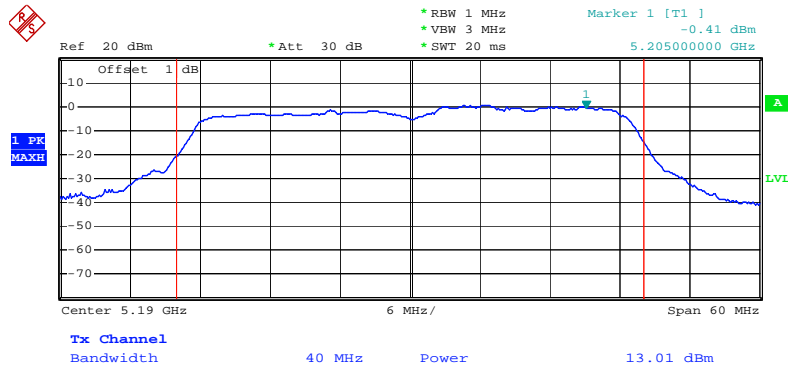

Date: 27.DEC.2007 04:41:13

Channel Output Power Plot on Configuration Draft n MCS8 40MHz Ant. 5 / 5190 MHz

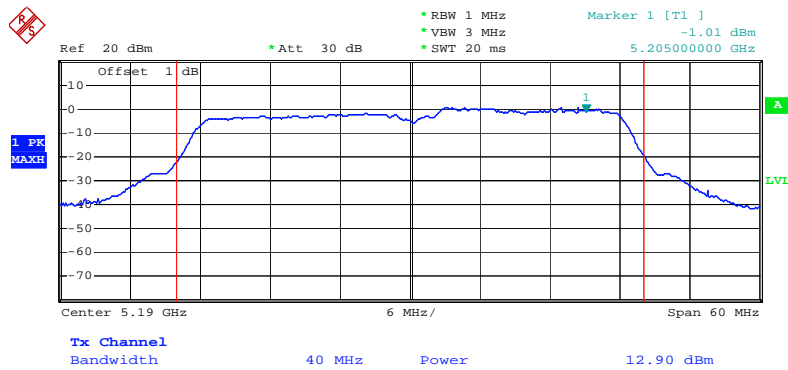

Date: 27.DEC.2007 04:43:12

Channel Output Power Plot on Configuration Draft n MCS8 40MHz Ant. 3 / 5230 MHz

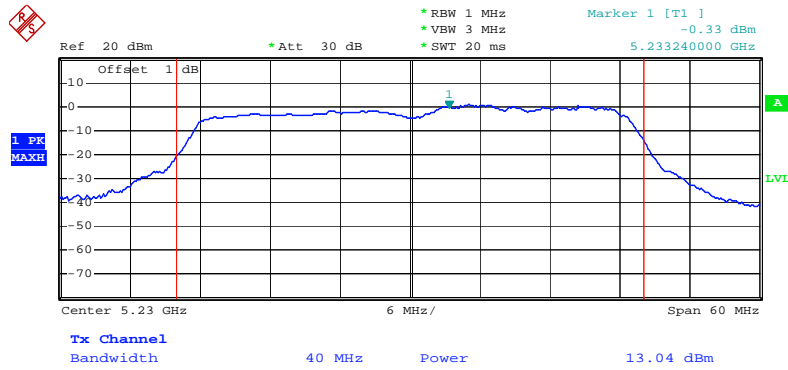

Date: 27.DEC.2007 04:55:56

Channel Output Power Plot on Configuration Draft n MCS8 40MHz Ant. 5 / 5230 MHz

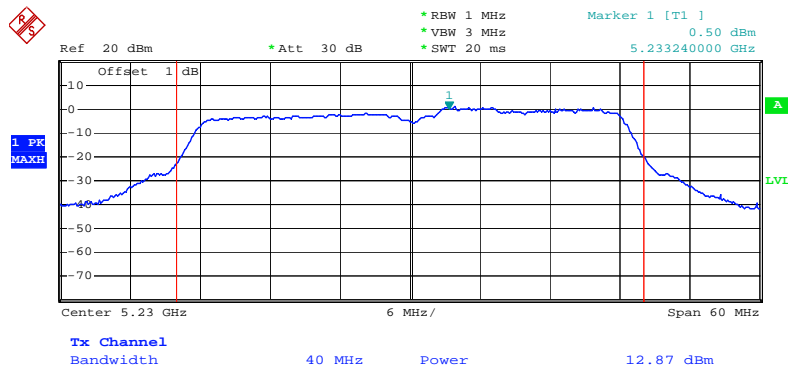

Date: 27.DEC.2007 04:48:39

4.4. Power Spectral Density Measurement

4.4.1. Limit

The power spectral density is defined as the highest level of power in dBm per MHz generated by the transmitter within the power envelope. The following table is power spectral density limits and decrease power density limit rule refer to section 4.3.1.

Frequency Range	Power Spectral Density limit (dBm/MHz)
5.15~5.25 GHz	4

4.4.2. Measuring Instruments and Setting

Please refer to section 5 of equipments list in this report. The following table is the setting of the spectrum analyzer.

Spectrum Parameter	Setting
Attenuation	Auto
Span Frequency	Encompass the entire emissions bandwidth (EBW) of the signal
RB	1000 kHz
VB	3000 kHz
Detector	Peak
Trace	Max Hold
Sweep Time	Auto

4.4.3. Test Procedures

1. The transmitter output (antenna port) was connected to the spectrum analyzer.
2. Set RBW of spectrum analyzer to 1000kHz and VBW to 3000kHz. Set Detector to Peak, Trace to Max Hold. Mark the frequency with maximum peak power as the center of the display of the spectrum.
3. Measuring multiple antennas, the connector is required to link with Power Meter through a combiner.

4.4.4. Test Setup Layout

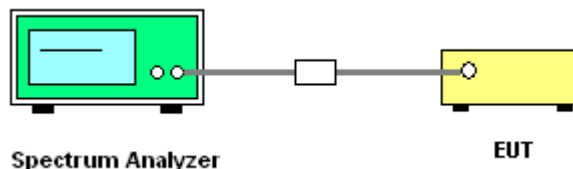

4.4.5. Test Deviation

There is no deviation with the original standard.

4.4.6. EUT Operation during Test

The EUT was programmed to be in continuously transmitting mode.

4.4.7. Test Result of Power Spectral Density

Temperature	23°C	Humidity	56%
Test Engineer	Beck Wu	Configurations	Draft n

Configuration Draft n MCS8 20MHz Ant. 3 + Ant. 5

Channel	Frequency	Power Density (dBm)	Max. Limit (dBm)	Result
36	5180 MHz	-1.51	4.00	Complies
40	5200 MHz	-0.34	11.00	Complies
48	5240 MHz	0.50	11.00	Complies

Configuration Draft n MCS8 40MHz Ant. 3 + Ant. 5

Channel	Frequency	Power Density (dBm)	Max. Limit (dBm)	Result
38	5190 MHz	-5.14	4.00	Complies
46	5230 MHz	-4.25	11.00	Complies

Power Density Plot on Configuration Drafft n MCS8 20MHz Ant. 3 + Ant. 5 / 5180 MHz

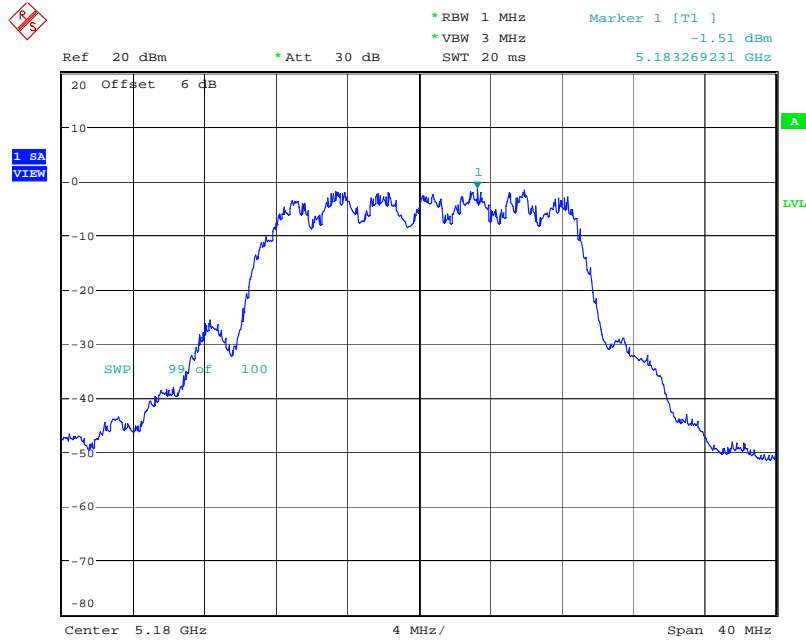

Date: 11.DEC.2007 14:37:50

Power Density Plot on Configuration Drafft n MCS8 20MHz Ant. 3 + Ant. 5 / 5200 MHz

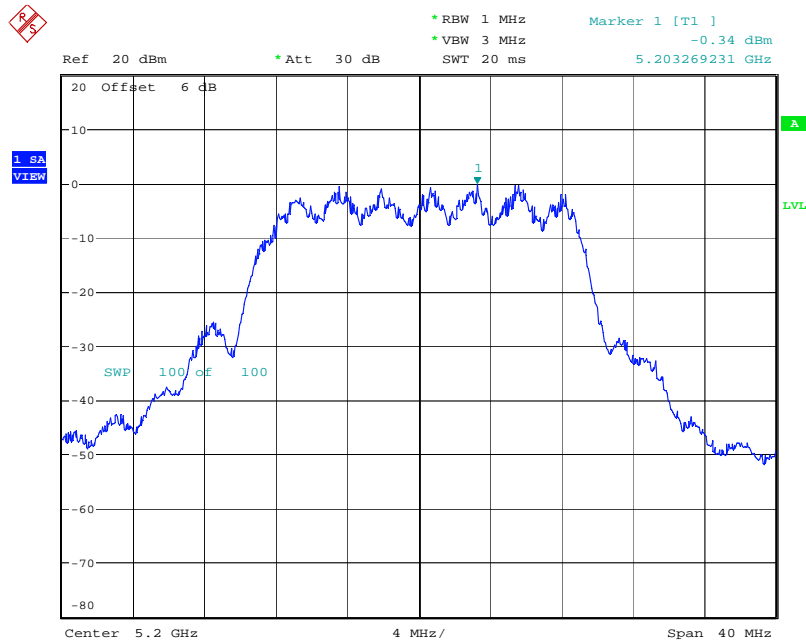

Date: 11.DEC.2007 14:39:59

4.5. Peak Excursion Measurement

4.5.1. Limit

The ratio of the peak excursion of the modulation envelope (measured using a peak hold function) to the maximum conducted output power (measured as specified above) shall not exceed 13 dB across any 1 MHz bandwidth or the emissions bandwidth whichever is less.

4.5.2. Measuring Instruments and Setting

Please refer to section 5 of equipments list in this report. The following table is the setting of the spectrum analyzer.

Spectrum Parameter	Setting
Attenuation	Auto
Span Frequency	Encompass the entire emissions bandwidth (EBW) of the signal
RB	1000 kHz (Peak Trace) / 1000 kHz (Average Trace)
VB	3000 kHz (Peak Trace) / 300 kHz (Average Trace)
Detector	Peak (Peak Trace) / Sample (Average Trace)
Trace	Max Hold
Sweep Time	60s

4.5.3. Test Procedures

1. The transmitter output (antenna port) was connected to the spectrum analyzer.
2. Set the spectrum analyzer span to view the entire emissions bandwidth. The largest difference between the following two traces (Peak Trace and Average Trace) must be ≤ 13 dB for all frequencies across the emissions bandwidth. Submit a plot.
3. Peak Trace: Set RBW = 1 MHz, VBW ≥ 3 MHz with peak detector and max-hold settings.
4. Average Trace: Method #3—video averaging with max hold--and sum power across the band. Set span to encompass the entire emissions bandwidth (EBW) of the signal. Set sweep trigger to "free run". Set RBW = 1 MHz. Set VBW $\geq 1/T$ (Draft n VBW = 300kHz $\geq 1/4 \mu$ s). Use sample detector mode if bin width (i.e., span/number of points in spectrum) < 0.5 RBW. Otherwise use peak detector mode . Set max hold. Allow max hold to run for 60 seconds.
5. Measuring multiple antennas, the connector is required to link with Power Meter through a combiner.

4.5.4. Test Setup Layout

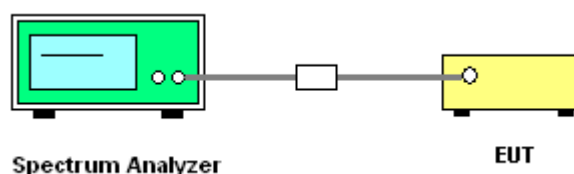

4.5.5. Test Deviation

There is no deviation with the original standard.

4.5.6. EUT Operation during Test

The EUT was programmed to be in continuously transmitting mode.

4.5.7. Test Result of Peak Excursion

Temperature	23°C	Humidity	56%
Test Engineer	Beck Wu	Configurations	Draft n

Configuration Draft n MCS8 20MHz Ant. 3 + Ant. 5

Channel	Frequency	Peak Excursion (dB)	Max. Limit (dB)	Result
36	5180 MHz	4.46	13	Complies
40	5200 MHz	3.83	13	Complies
48	5240 MHz	4.38	13	Complies

Configuration Draft n MCS8 40MHz Ant. 3 + Ant. 5

Channel	Frequency	Peak Excursion (dB)	Max. Limit (dB)	Result
38	5190 MHz	6.35	13	Complies
468	5230 MHz	5.98	13	Complies

Peak Excursion Plot on Configuration Drafft n MCS8 20MHz Ant. 3 + Ant. 5 / 5180 MHz

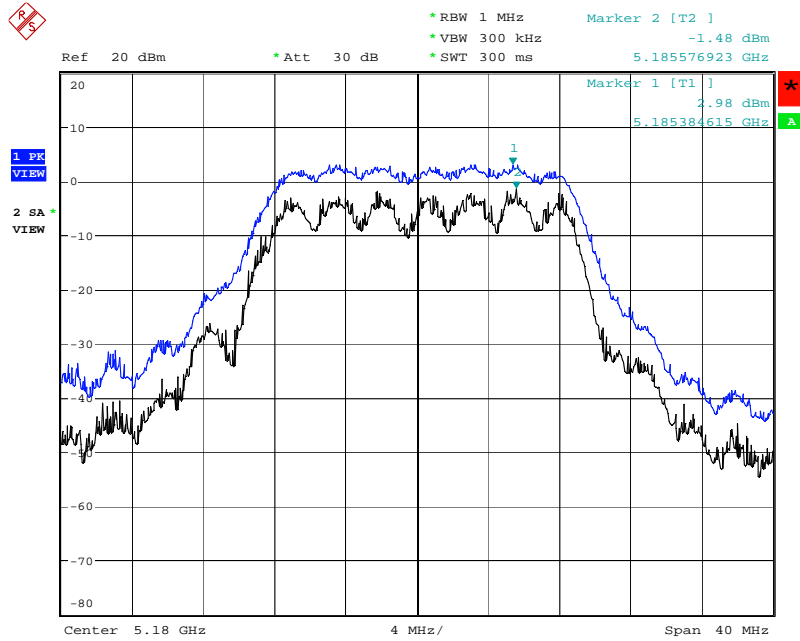

Date: 11.DEC.2007 14:38:38

Peak Excursion Plot on Configuration Drafft n MCS8 20MHz Ant. 3 + Ant. 5 / 5200 MHz

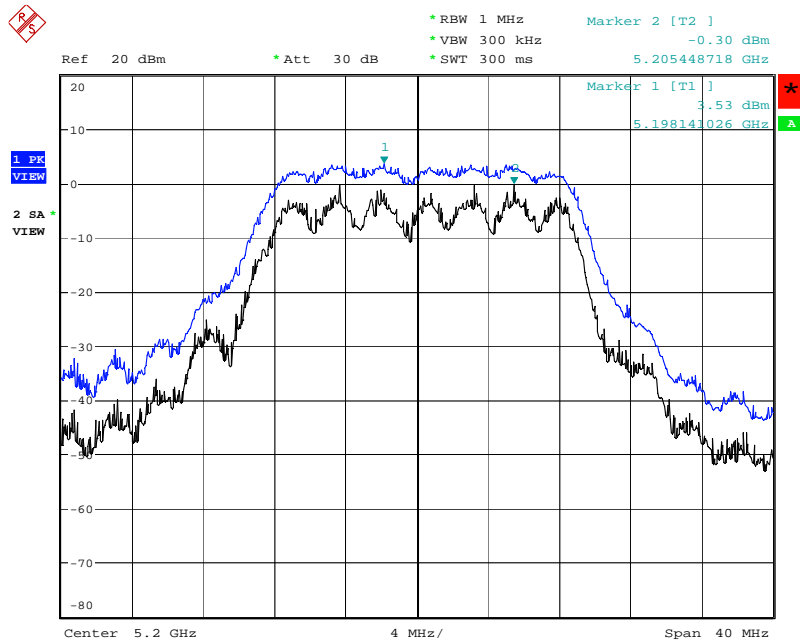

Date: 11.DEC.2007 14:40:46

Peak Excursion Plot on Configuration Drafft n MCS8 20MHz Ant. 3 + Ant. 5 / 5240 MHz

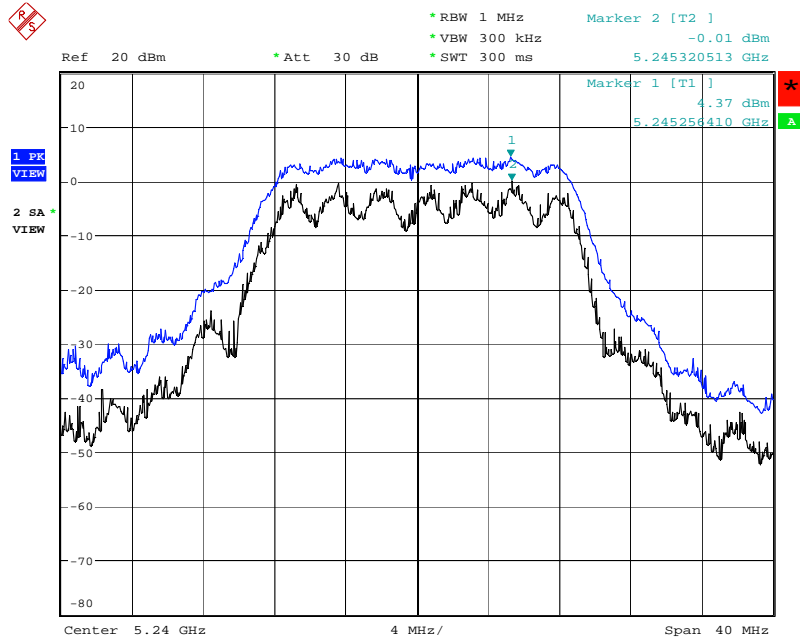

Date: 11.DEC.2007 14:42:54

Peak Excursion Plot on Configuration Drafft n MCS8 40MHz Ant. 3 + Ant. 5 / 5190 MHz

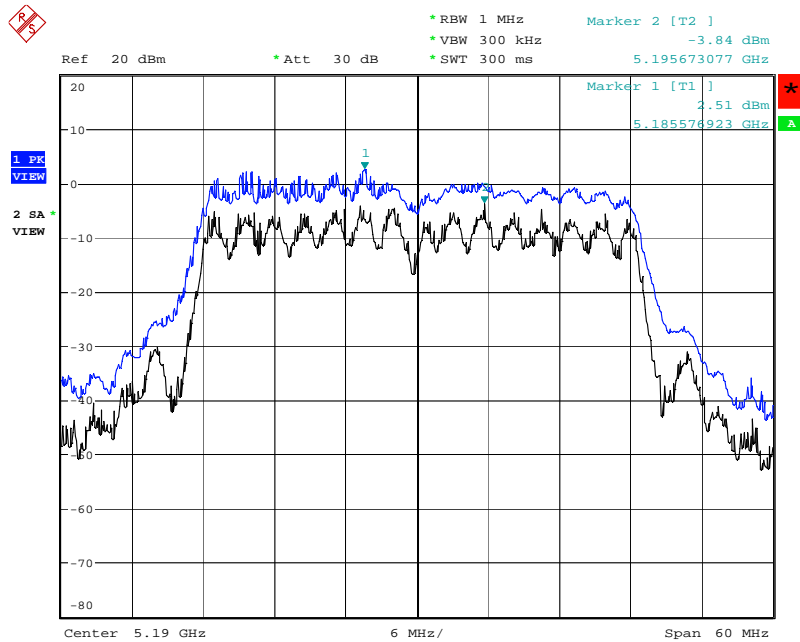

Date: 11.DEC.2007 14:35:07

Peak Excursion Plot on Configuration Draft n MCS8 40MHz Ant. 3 + Ant. 5 / 5230 MHz

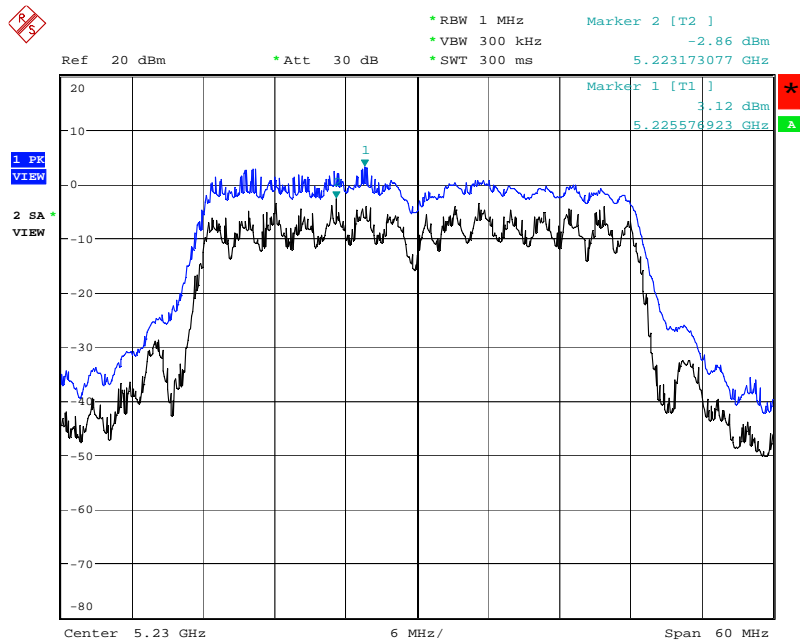

Date: 11.DEC.2007 14:32:20

4.6. Radiated Emissions Measurement

4.6.1. Limit

For transmitters operating in the 5.15-5.35 GHz band: all emissions outside of the 5.15-5.35 GHz band shall not exceed an EIRP of -27 dBm/MHz (68.3dBuV/m at 3m).; for frequencies 10 MHz or greater above or below the band edge, emissions shall not exceed an EIRP of -27 dBm/MHz (68.3dBuV/m at 3m). In addition, In case the emission fall within the restricted band specified on 15.205(a), then the 15.209(a) limit in the table below has to be followed.

Frequencies (MHz)	Field Strength (microvolts/meter)	Measurement Distance (meters)
0.009~0.490	2400/F(KHz)	300
0.490~1.705	24000/F(KHz)	30
1.705~30.0	30	30
30~88	100	3
88~216	150	3
216~960	200	3
Above 960	500	3

4.6.2. Measuring Instruments and Setting

Please refer to section 5 of equipments list in this report. The following table is the setting of spectrum analyzer and receiver.

Spectrum Parameter	Setting
Attenuation	Auto
Start Frequency	1000 MHz
Stop Frequency	40 GHz
RB / VB (Emission in restricted band)	1MHz / 1MHz for Peak, 1 MHz / 10Hz for Average
RB / VB (Emission in non-restricted band)	1000KHz / 1000KHz for peak

Receiver Parameter	Setting
Attenuation	Auto
Start ~ Stop Frequency	9kHz~150kHz / RB 200Hz for QP
Start ~ Stop Frequency	150kHz~30MHz / RB 9kHz for QP
Start ~ Stop Frequency	30MHz~1000MHz / RB 120kHz for QP

4.6.3. Test Procedures

1. Configure the EUT according to ANSI C63.4. The EUT was placed on the top of the turntable 0.8 meter above ground. The phase center of the receiving antenna mounted on the top of a height-variable antenna tower was placed 3 meters far away from the turntable.
2. Power on the EUT and all the supporting units. The turntable was rotated by 360 degrees to determine the position of the highest radiation.
3. The height of the broadband receiving antenna was varied between one meter and four meters above ground to find the maximum emissions field strength of both horizontal and vertical polarization.
4. For each suspected emissions, the antenna tower was scan (from 1 M to 4 M) and then the turntable was rotated (from 0 degree to 360 degrees) to find the maximum reading.
5. Set the test-receiver system to Peak or CISPR quasi-peak Detect Function with specified bandwidth under Maximum Hold Mode.
6. For emissions above 1GHz, use 1MHz VBW and RBW for peak reading. Then 1MHz RBW and 10Hz VBW for average reading in spectrum analyzer.
7. When the radiated emissions limits are expressed in terms of the average value of the emissions, and pulsed operation is employed, the measurement field strength shall be determined by averaging over one complete pulse train, including blanking intervals, as long as the pulse train does not exceed 0.1 seconds. As an alternative (provided the transmitter operates for longer than 0.1 seconds) or in cases where the pulse train exceeds 0.1 seconds, the measured field strength shall be determined from the average absolute voltage during a 0.1 second interval during which the field strength is at its maximum value.
8. If the emissions level of the EUT in peak mode was 3 dB lower than the average limit specified, then testing will be stopped and peak values of EUT will be reported, otherwise, the emissions which do not have 3 dB margin will be repeated one by one using the quasi-peak method for below 1GHz.
9. For testing above 1GHz, the emissions level of the EUT in peak mode was lower than average limit (that means the emissions level in peak mode also complies with the limit in average mode), then testing will be stopped and peak values of EUT will be reported, otherwise, the emissions will be measured in average mode again and reported.
10. In case the emission is lower than 30MHz, loop antenna has to be used for measurement and the recorded data should be QP measured by receiver. High – Low scan is not required in this case.

4.6.4. Test Setup Layout

For radiated emissions below 30MHz

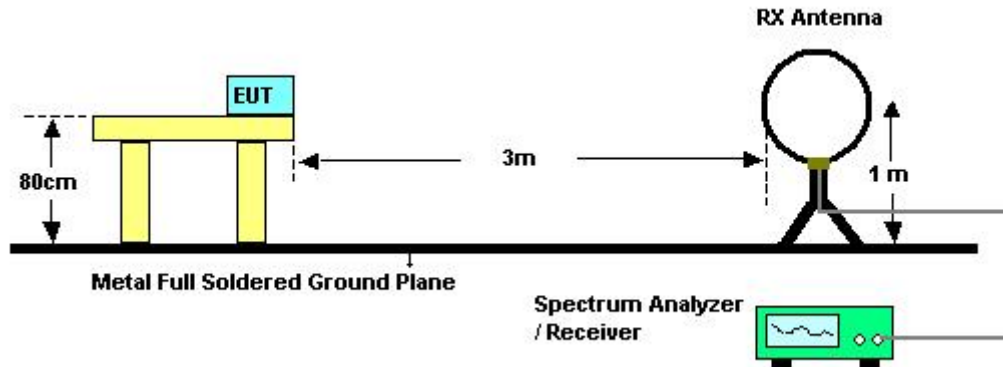

For radiated emissions above 30MHz

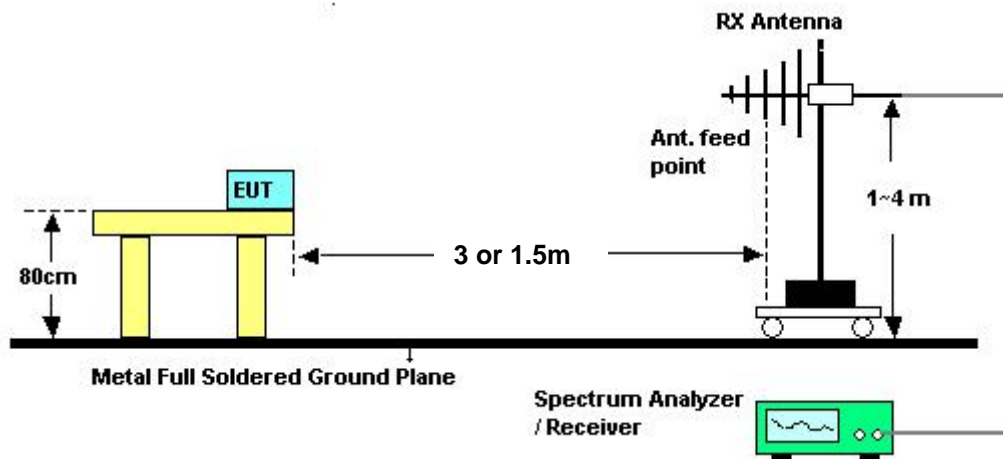

Above 5GHz shall be extrapolated to the specified distance using an extrapolation factor of 20 dB/decade from 3m to 1.5m.

Distance extrapolation factor = $20 \log (\text{specific distance [3m]} / \text{test distance [1.5m]})$ (dB);

Limit line = specific limits (dBuV) + distance extrapolation factor [6 dB].

4.6.5. Test Deviation

There is no deviation with the original standard.

4.6.6. EUT Operation during Test

The EUT was programmed to be in continuously transmitting mode.

4.6.7. Results of Radiated Emissions (9kHz~30MHz)

Temperature	23°C	Humidity	54%
Test Engineer	Barry Chen	Configurations	Normal Link

Freq. (MHz)	Level (dBuV)	Over Limit (dB)	Limit Line (dBuV)	Remark
-	-	-	-	See Note

Note:

The amplitude of spurious emissions that are attenuated by more than 20dB below the permissible value has no need to be reported.

Distance extrapolation factor = $40 \log(\text{specific distance} / \text{test distance})$ (dB);

Limit line = specific limits (dBuV) + distance extrapolation factor.

4.6.8. Results of Radiated Emissions (30MHz~1GHz)

Temperature	23°C	Humidity	54%
Test Engineer	Barry Chen	Configurations	Normal Link

Horizontal

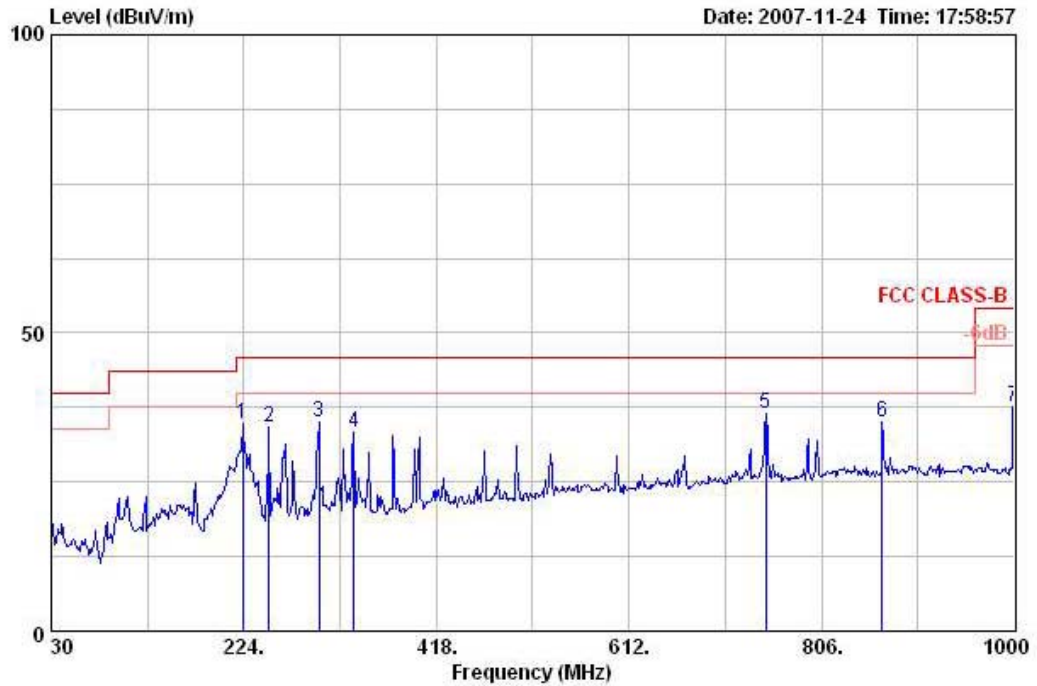

	Freq	Level	Over Limit	Limit Line	Read Level	Antenna Factor	Preamp Factor	Cable Loss	Remark	Table Pos	Ant Pos	Pol/Phase
	MHz	dBUV/m	dB	dBUV/m	dBuV	dB/m	dB	dB		deg	cm	
1	223.030	34.71	-11.29	46.00	51.06	8.91	27.05	1.79	Peak	0	100	HORIZONTAL
2	249.220	34.07	-11.93	46.00	47.61	11.56	27.00	1.90	Peak	0	100	HORIZONTAL
3	299.660	35.16	-10.84	46.00	47.06	12.90	26.90	2.10	Peak	0	100	HORIZONTAL
4	334.580	33.41	-12.59	46.00	44.42	13.97	27.14	2.17	Peak	0	100	HORIZONTAL
5	749.740	36.59	-9.41	46.00	40.82	20.07	27.80	3.50	Peak	0	100	HORIZONTAL
6	867.110	34.93	-11.07	46.00	38.51	20.43	27.47	3.47	Peak	0	100	HORIZONTAL
7	1000.000	37.69	-16.31	54.00	40.69	20.30	27.00	3.70	Peak	0	100	HORIZONTAL

Vertical

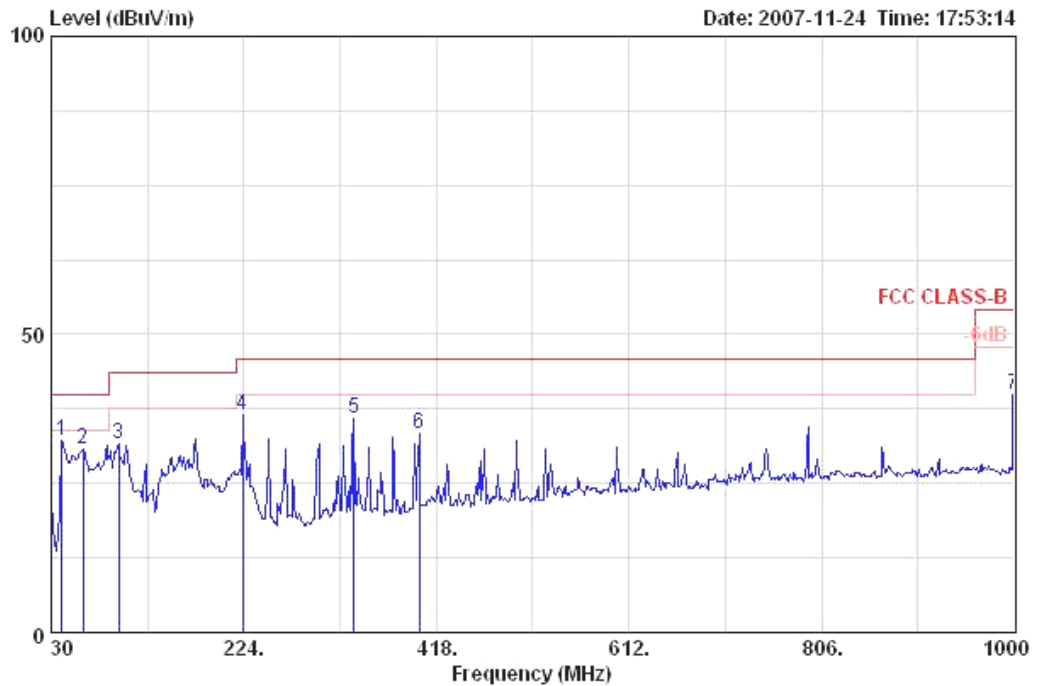

	Freq	Level	Over	Limit	Read	Antenna	Preamp	Cable	Table	Ant	
	MHz	dBuV/m	Limit	Line	Level	Factor	Factor	Loss	Pos	Pos	Pol/Phase
			dB	dBuV/m	dBuV	dB/m	dB	dB	deg	cm	
1	40.670	32.06	-7.94	40.00	47.71	11.45	27.80	0.70	236	100	VERTICAL
2	62.010	30.68	-9.32	40.00	52.64	4.95	27.75	0.84	0	400	VERTICAL
3	97.900	31.70	-11.80	43.50	48.20	9.95	27.61	1.16	0	400	VERTICAL
4	223.030	36.59	-9.41	46.00	52.94	8.91	27.05	1.79	0	400	VERTICAL
5	334.580	35.79	-10.21	46.00	46.80	13.97	27.14	2.17	0	400	VERTICAL
6	400.540	33.46	-12.54	46.00	42.81	15.95	27.61	2.31	0	400	VERTICAL
7	1000.000	39.85	-14.15	54.00	42.85	20.30	27.00	3.70	0	400	VERTICAL

Note:

The amplitude of spurious emissions that are attenuated by more than 20dB below the permissible value has no need to be reported.

Emission level (dBuV/m) = 20 log Emission level (uV/m).

Corrected Reading: Antenna Factor + Cable Loss + Read Level - Preamp Factor = Level.

4.6.9. Results for Radiated Emissions (1GHz~40GHz)

Temperature	23°C	Humidity	54%
Test Engineer	Barry Chen	Configurations	Draft n MCS8 20MHz Ch 36 Ant. 3 + Ant. 5

Horizontal

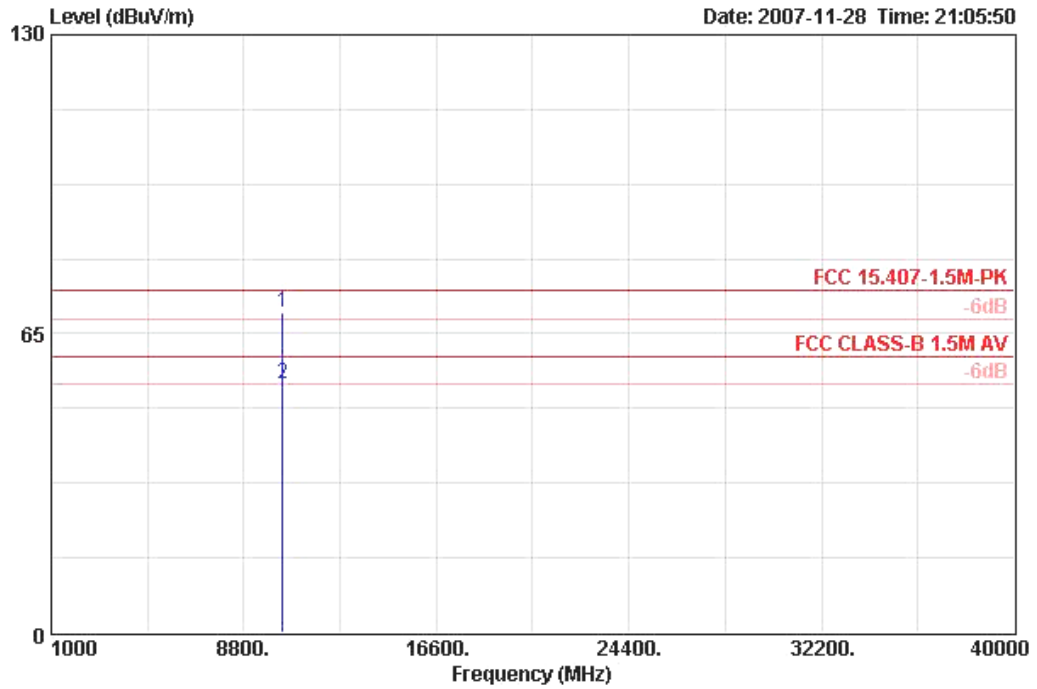

	Freq	Level	Over Limit	Limit	Line Remark	Pol/Phase	Distance	ReadAntenna Level	Antenna Factor	Cable Loss	Preamp
	MHz	dBuV/m	dB	dBuV/m			m	dBuV	dB/m	dB	dB
1 !	10358.200	69.63	-4.67	74.30	PEAK	HORIZONTAL	3	57.05	38.37	9.32	35.12

Vertical

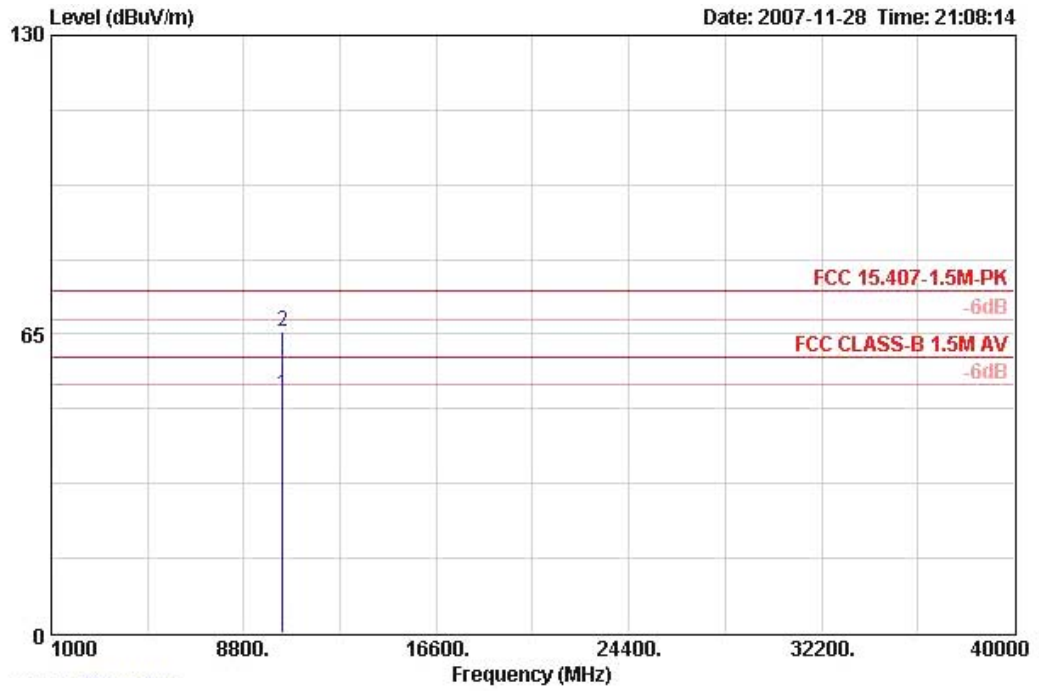

Line	Freq	Level	Over	Limit	Remark	Pol/Phase	Distance	ReadAntenna		Cable Preamp	
			Limit	Line				Level	Factor	Loss	Factor
	MHz	dBUV/m	dB	dBUV/m			m	dBuV	dB/m	dB	dB
2	10362.600	65.72	-8.58	74.30	PEAK	VERTICAL	3	53.15	38.37	9.32	35.12



Temperature	23°C	Humidity	54%
Test Engineer	Barry Chen	Configurations	Draft n MCS8 20MHz Ch 46 Ant. 3 + Ant. 5

Horizontal

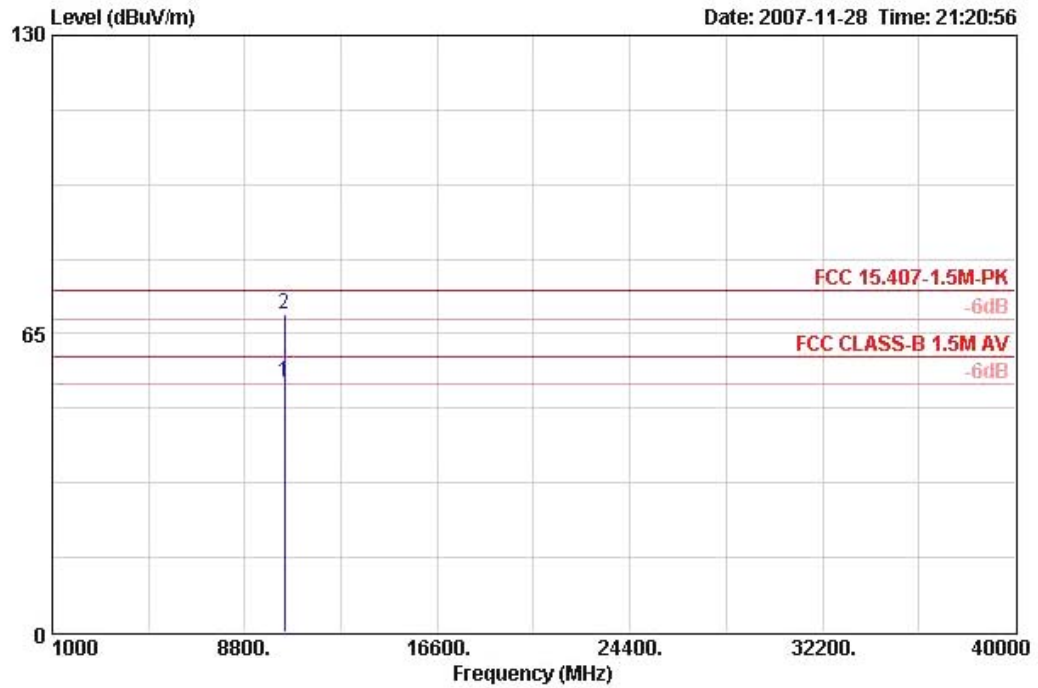

	Freq	Level	Over Limit	Limit Line	Remark	Pol/Phase	Distance	Read Level	Antenna Factor	Cable Loss	Preamp Factor
	MHz	dBuV/m	dB	dBuV/m			m	dBuV	dB/m	dB	dB
2 !	10400.600	69.27	-5.03	74.30	PEAK	HORIZONTAL	3	56.58	38.38	9.36	35.05

Vertical

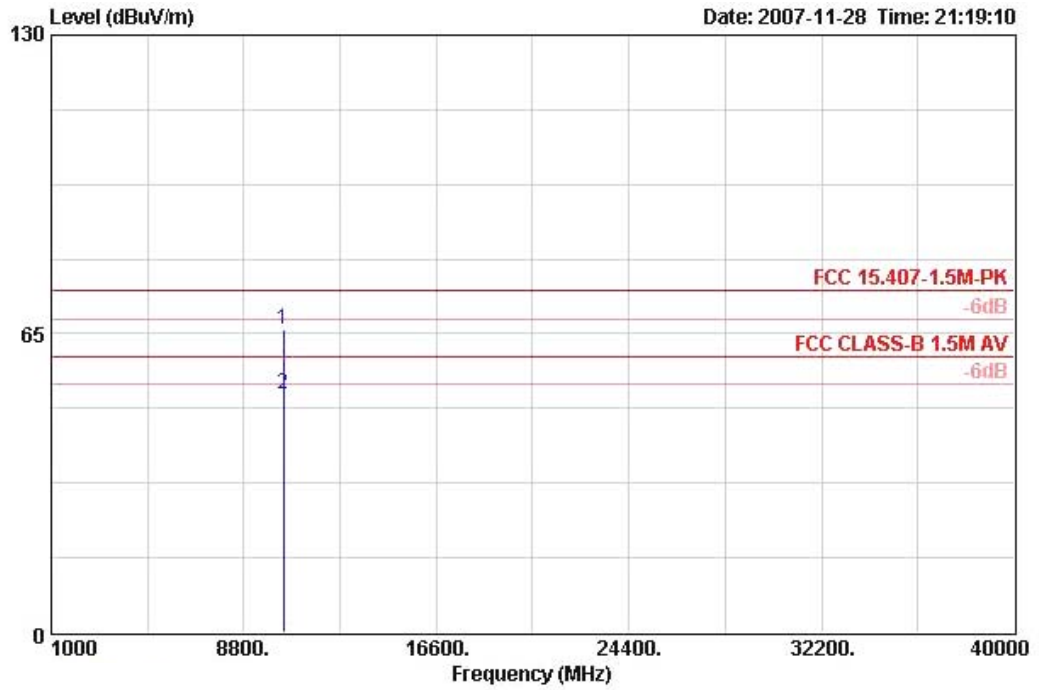

	Freq	Level	Over	Limit	Line	Remark	Pol/Phase	Distance	ReadAntenna		Cable Preamp	
									Level	Factor	Loss	Factor
	MHz	dBuV/m	dB	dBuV/m				m	dBuV	dB/m	dB	dB
1	10397.320	65.97	-8.33	74.30	PEAK	VERTICAL		3	53.29	38.38	9.36	35.05

Temperature	23°C	Humidity	54%
Test Engineer	Barry Chen	Configurations	Draft n MCS8 20MHz Ch 48 Ant. 3 + Ant. 5

Horizontal

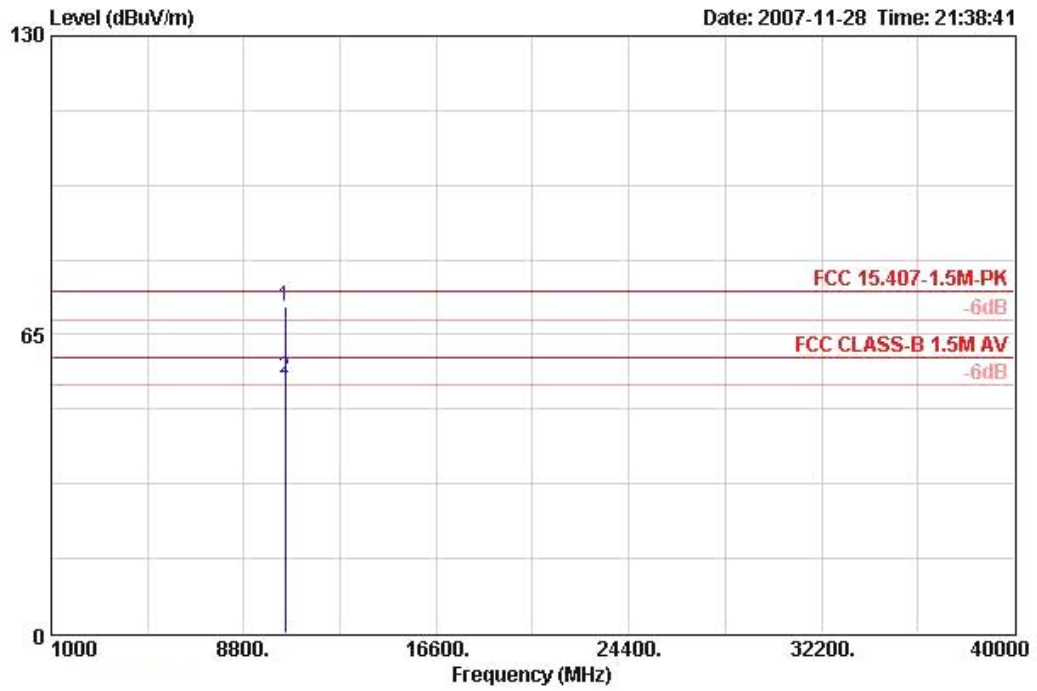

	Freq	Level	Over	Limit	Line Remark	Pol/Phase	Distance	Read	Antenna	Cable	Preamp
			Limit	Line				Level	Factor	Loss	Factor
	MHz	dBUV/m	dB	dBUV/m			m	dBUV	dB/m	dB	dB
1 !	10477.920	71.19	-3.11	74.30	PEAK	HORIZONTAL	3	58.34	38.40	9.41	34.96

Vertical

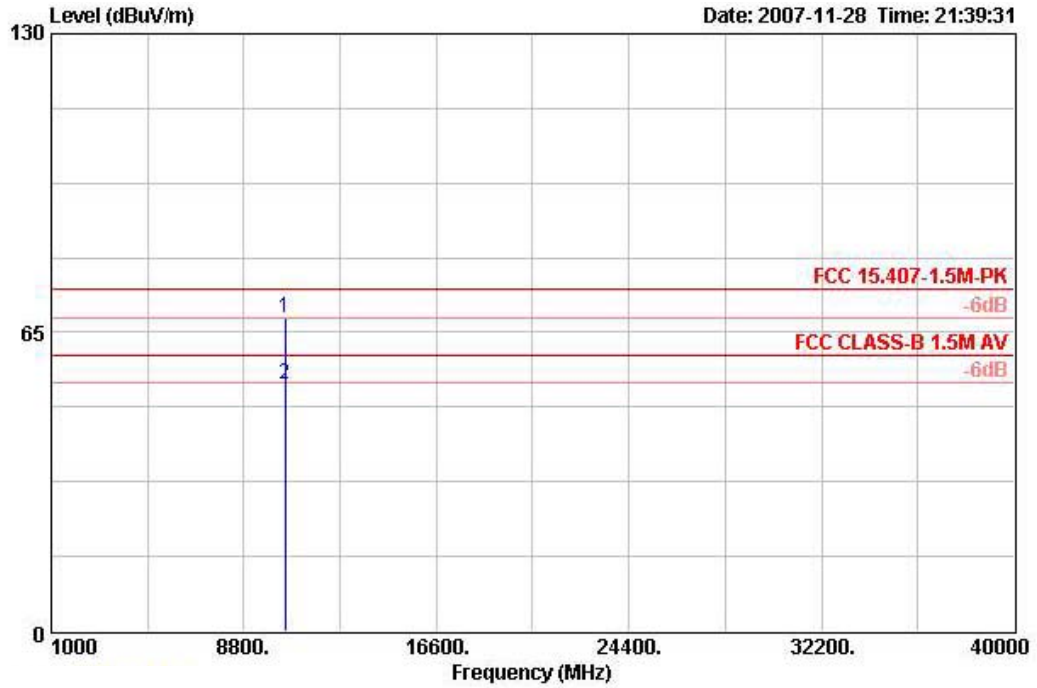

	Freq	Level	Over	Limit	Remark	Pol/Phase	Distance	ReadAntenna		Cable Preamp	
			Limit	Line				Level	Factor	Loss	Factor
	MHz	dBuV/m	dB	dBuV/m			m	dBuV	dB/m	dB	dB
1	10479.960	68.24	-6.06	74.30	PEAK	VERTICAL	3	55.39	38.40	9.41	34.96



Temperature	23°C	Humidity	54%
Test Engineer	Barry Chen	Configurations	Draft n MCS8 40MHz Ch 38 Ant. 3 + Ant. 5

Horizontal

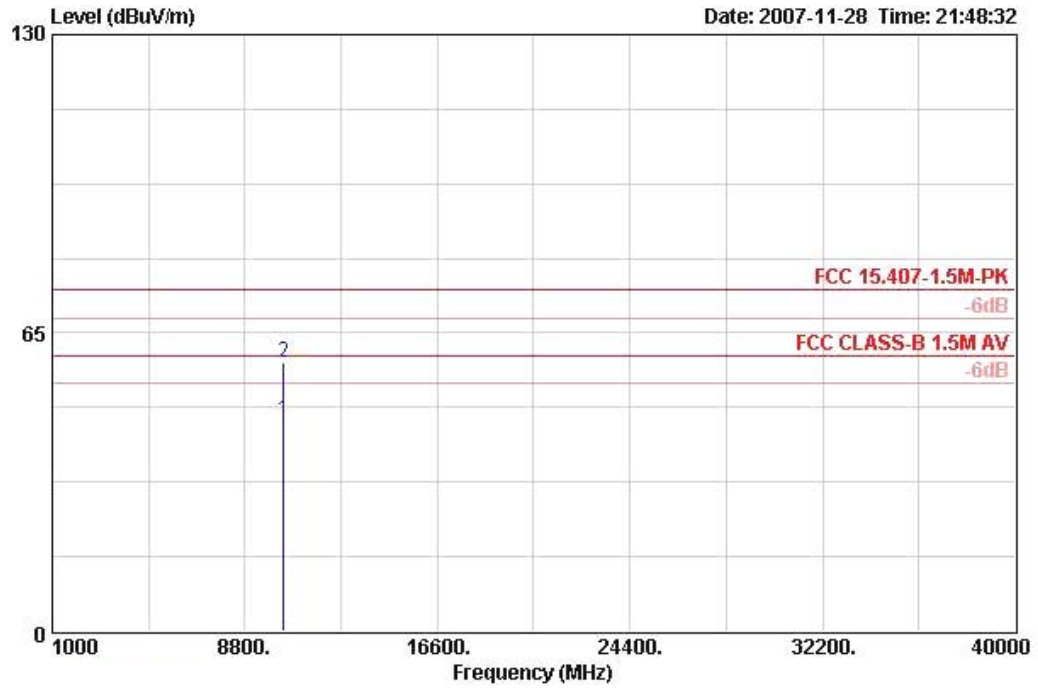

	Freq	Level	Over Limit	Limit Line	Remark	Pol/Phase	Distance	ReadAntenna Level	Antenna Factor	Cable Loss	Preamp Factor
	MHz	dBuV/m	dB	dBuV/m			m	dBuV	dB/m	dB	dB
2	10381.000	58.57	-15.73	74.30	PEAK	HORIZONTAL	3	45.94	38.38	9.34	35.09

Vertical

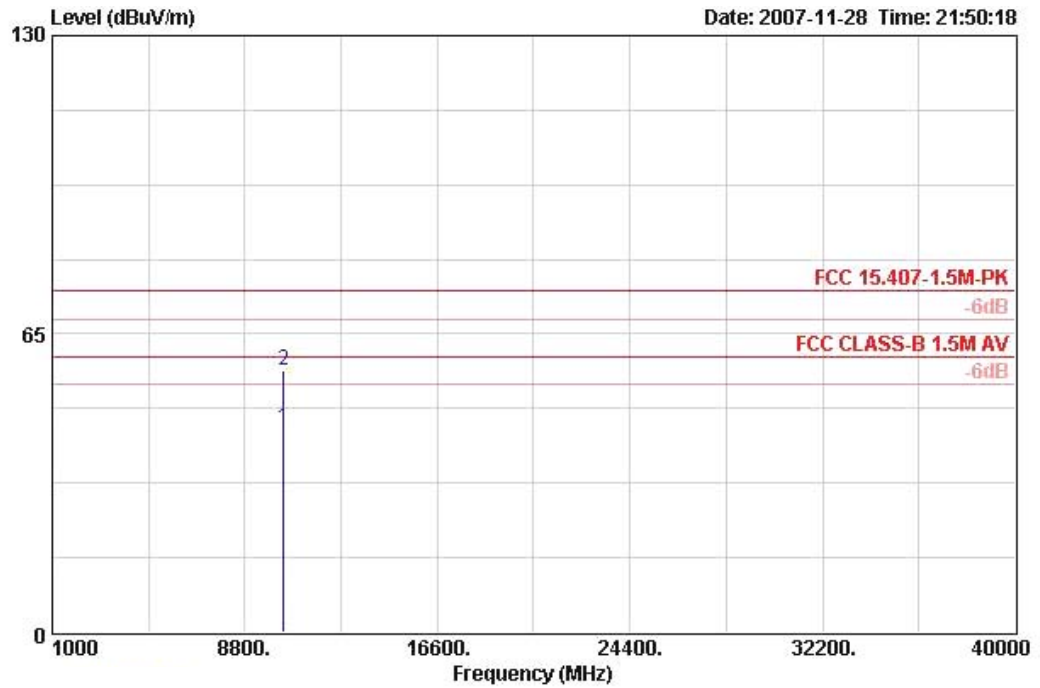

	Freq	Level	Over Limit	Limit Line	Remark	Pol/Phase	Distance	ReadAntenna Level	Antenna Factor	Cable Loss	Preamp Factor
	MHz	dBuV/m	dB	dBuV/m			m	dBuV	dB/m	dB	dB
2	10380.400	57.10	-17.20	74.30	PEAK	VERTICAL	3	44.47	38.38	9.34	35.09



Temperature	23°C	Humidity	54%
Test Engineer	Barry Chen	Configurations	Draft n MCS8 40MHz Ch 46 Ant. 3 + Ant. 5

Horizontal

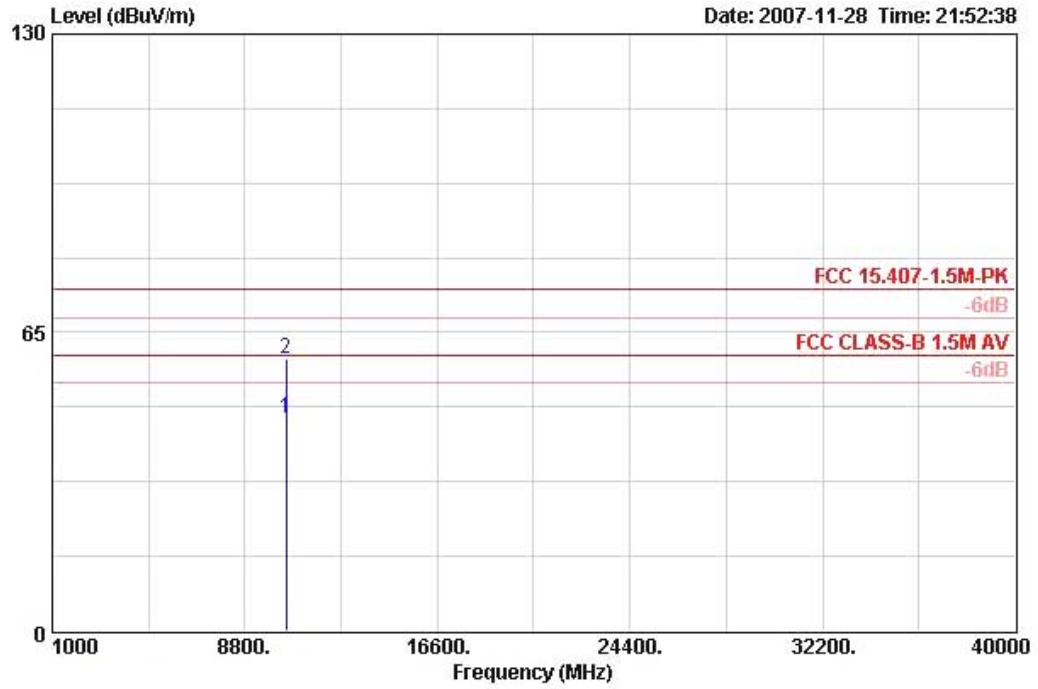

	Freq	Level	Over Limit	Limit Line	Remark	Pol/Phase	Distance	ReadAntenna Level	Antenna Factor	Cable Loss	Preamp Factor
	MHz	dBuV/m	dB	dBuV/m			m	dBuV	dB/m	dB	dB
2	10460.400	59.36	-14.94	74.30	PEAK	HORIZONTAL	3	46.56	38.39	9.39	34.99

Vertical

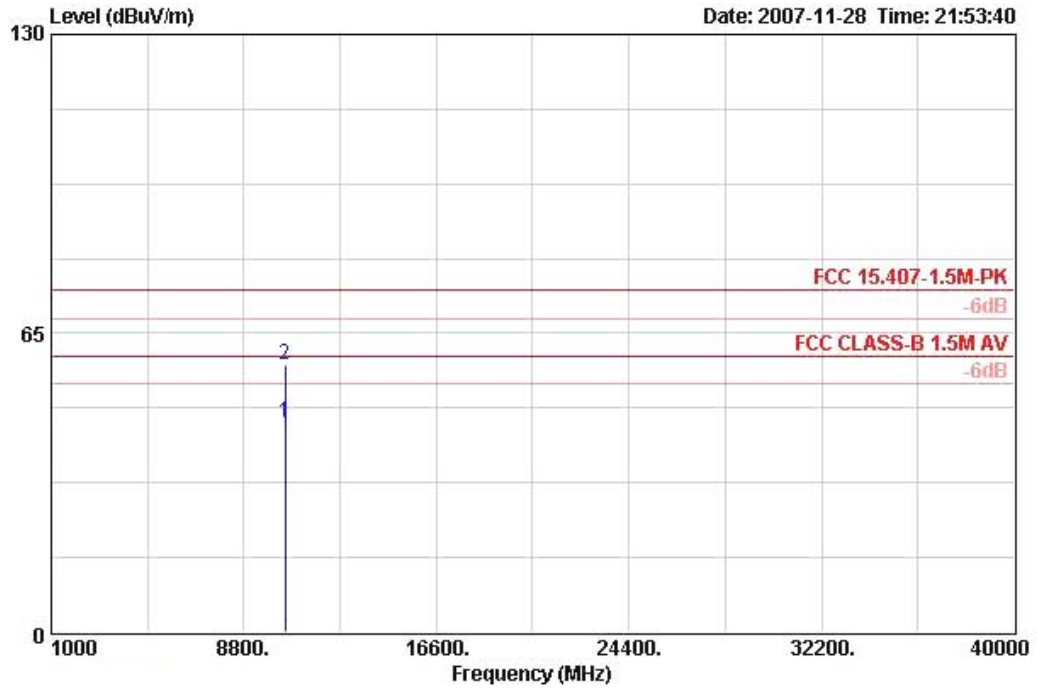

Date: 2007-11-28 Time: 21:53:40

Ereg	Level	Over Limit	Limit	Line Remark	Pol/Phase	Distance	ReadAntenna		Cable Preamp	
							Level	Factor	Loss	Factor
MHz	dBUV/m	dB	dBUV/m			m	dBuV	dB/m	dB	dB
2	10462.780	58.29	-16.01	74.30 PEAK	VERTICAL	3	45.50	38.39	9.39	34.99

Note:

The amplitude of spurious emissions that are attenuated by more than 20dB below the permissible value has no need to be reported.

Emission level (dBUV/m) = 20 log Emission level (uV/m).

Corrected Reading: Antenna Factor + Cable Loss + Read Level - Preamp Factor = Level.

The limits above 5GHz shall be extrapolated to the specified distance using an extrapolation factor of 20 dB/decade form 3m to 1.5m.

Distance extrapolation factor = 20 log (specific distance [3m] / test distance [1.5m]) (dB);

Limit line = specific limits (dBUV) + distance extrapolation factor [6 dB].

4.7. Band Edge Emissions Measurement

4.7.1. Limit

For transmitters operating in the 5.15-5.35 GHz band: all emissions outside of the 5.15-5.35 GHz band shall not exceed an EIRP of -27 dBm/MHz (68.3dBuV/m at 3m).; for frequencies 10 MHz or greater above or below the band edge, emissions shall not exceed an EIRP of -27 dBm/MHz (68.3dBuV/m at 3m). In addition, In case the emission fall within the restricted band specified on 15.205(a), then the 15.209(a) limit in the table below has to be followed.

Frequencies (MHz)	Field Strength (micovolts/meter)	Measurement Distance (meters)
0.009~0.490	2400/F(KHz)	300
0.490~1.705	24000/F(KHz)	30
1.705~30.0	30	30
30~88	100	3
88~216	150	3
216~960	200	3
Above 960	500	3

4.7.2. Measuring Instruments and Setting

Please refer to section 5 of equipments list in this report. The following table is the setting of the spectrum analyzer.

Spectrum Parameter	Setting
Attenuation	Auto
Span Frequency	100 MHz
RB / VB (Emission in restricted band)	1 MHz / 1MHz for Peak, 1 MHz / 10Hz for Average
RB / VB (Emission in non-restricted band)	1 MHz /1 MHz for Peak

4.7.3. Test Procedures

1. The test procedure is the same as section 4.6.3, only the frequency range investigated is limited to 100MHz around bandedges.
2. In case the emission is fail due to the used RB/VB is too wide, marker-delta method of FCC Public Notice DA00-705 will be followed.

4.7.4. Test Setup Layout

This test setup layout is the same as that shown in section 4.6.4.

4.7.5. Test Deviation

There is no deviation with the original standard.

4.7.6. EUT Operation during Test

The EUT was programmed to be in continuously transmitting mode.

4.7.7. Test Result of Band Edge and Fundamental Emissions

Temperature	23°C	Humidity	54%
Test Engineer	Barry Chen	Configurations	Draft n MCS8 20MHz Ch 36, 40, 48 Ant. 3 + Ant. 5

Channel 36

	Freq	Level	Over	Limit	Remark	Pol/Phase	Distance	ReadAntenna		Cable	Preamp
			Limit	Line				Level	Factor	Loss	Factor
	MHz	dBuV/m	dB	dBuV/m			m	dBuV	dB/m	dB	dB
1 !	5150.000	59.76	-0.24	60.00	AVERAGE	VERTICAL	3	19.55	33.67	6.54	0.00
2	5150.000	75.52			PEAK	VERTICAL	3	35.30	33.67	6.54	0.00
3 @	5176.200	106.09			AVERAGE	VERTICAL	3	65.81	33.73	6.55	0.00
4	5183.400	117.71			PEAK	VERTICAL	3	77.43	33.73	6.55	0.00

Item 3, 4 are the fundamental frequency at 5180 MHz.

Note: Item 2 fall in restricted band, thus 15.209 limit applies. However, the test site distance has been moved to 1.5m, the corresponding limit will be adjusted to 80dBuV/m.

Channel 40

	Freq	Level	Over	Limit	Remark	Pol/Phase	Distance	ReadAntenna		Cable	Preamp
			Limit	Line				Level	Factor	Loss	Factor
	MHz	dBuV/m	dB	dBuV/m			m	dBuV	dB/m	dB	dB
1 @	5195.200	106.52			AVERAGE	VERTICAL	3	66.19	33.76	6.57	0.00
2	5195.400	116.52			PEAK	VERTICAL	3	76.20	33.76	6.57	0.00

Item 3, 4 are the fundamental frequency at 5200 MHz.

Channel 48

	Freq	Level	Over	Limit	Remark	Pol/Phase	Distance	ReadAntenna		Cable	Preamp
			Limit	Line				Level	Factor	Loss	Factor
	MHz	dBuV/m	dB	dBuV/m			m	dBuV	dB/m	dB	dB
1	5235.600	118.08			PEAK	VERTICAL	3	77.68	33.82	6.58	0.00
2 @	5245.400	107.20			AVERAGE	VERTICAL	3	66.77	33.85	6.58	0.00

Item 3, 4 are the fundamental frequency at 5240 MHz.

Temperature	20°C	Humidity	70%
Test Engineer	Barry Chen	Configurations	Draft n MCS8 40MHz Ch 38, 46, Ant. 3 + Ant. 5

Channel 38

	Freq	Level	Over	Limit	Remark	Pol/Phase	Distance	ReadAntenna		Cable	Preamp
			Limit	Line				Level	Factor	Loss	Factor
	MHz	dBuV/m	dB	dBuV/m			m	dBuV	dB/m	dB	dB
1 !	5150.000	59.80	-0.20	60.00	AVERAGE	VERTICAL	3	19.58	33.67	6.54	0.00
2 !	5150.000	72.32			PEAK	VERTICAL	3	32.11	33.67	6.54	0.00
3	5195.600	97.91			AVERAGE	VERTICAL	3	57.58	33.76	6.57	0.00
4	5197.600	110.21			PEAK	VERTICAL	3	69.88	33.76	6.57	0.00

Item 3, 4 are the fundamental frequency at 5190 MHz.

Item 2 fall in restricted band, thus 15.209 limit applies. However, the test site distance has been moved to 1.5m, the corresponding limit will be adjusted to 80dBuV/m.

Channel 46

	Freq	Level	Over	Limit	Remark	Pol/Phase	Distance	ReadAntenna		Cable	Preamp
			Limit	Line				Level	Factor	Loss	Factor
	MHz	dBuV/m	dB	dBuV/m			m	dBuV	dB/m	dB	dB
1	5235.200	98.07			AVERAGE	VERTICAL	3	57.67	33.82	6.58	0.00
2	5235.200	111.70			PEAK	VERTICAL	3	71.30	33.82	6.58	0.00

Item 3, 4 are the fundamental frequency at 5230 MHz.

Note:

Emission level (dBuV/m) = 20 log Emission level (uV/m)

Corrected Reading: Antenna Factor + Cable Loss + Read Level - Preamp Factor = Level

The limits above 5GHz shall be extrapolated to the specified distance using an extrapolation factor of 20 dB/decade form 3m to 1.5m.

Distance extrapolation factor = 20 log (specific distance [3m] / test distance [1.5m]) (dB);

Limit line = specific limits (dBuV) + distance extrapolation factor [6 dB].

EIRP Emission in Band on Configuration Drafft n MCS8 20MHz Ant. 3 + Ant. 5 / 5180 MHz

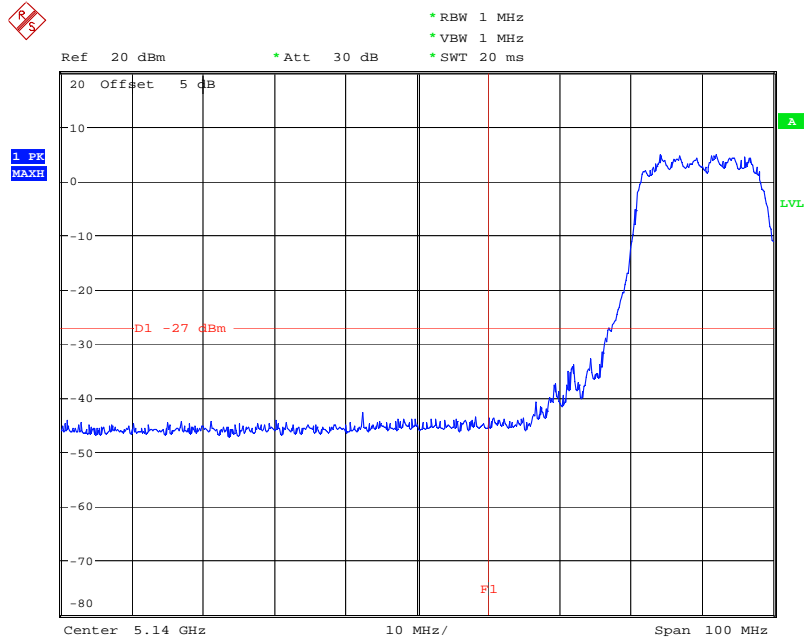

Date: 11.DEC.2007 12:17:35

EIRP Emission in Band on Configuration Drafft n MCS8 20MHz Ant. 3 + Ant. 5 / 5240 MHz

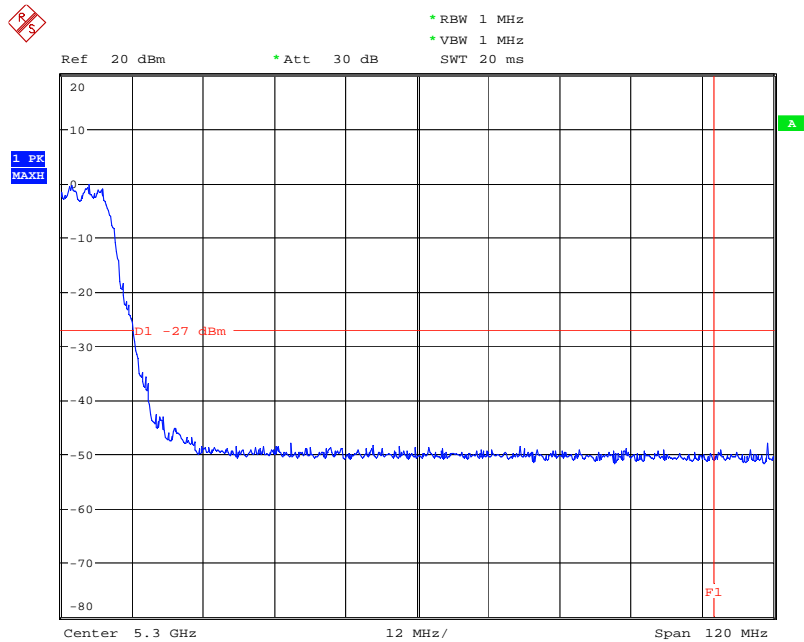

Date: 11.DEC.2007 12:26:15

EIRP Emission in Band on Configuration Drafft n MCS8 40MHz Ant. 3 + Ant. 5 / 5190 MHz

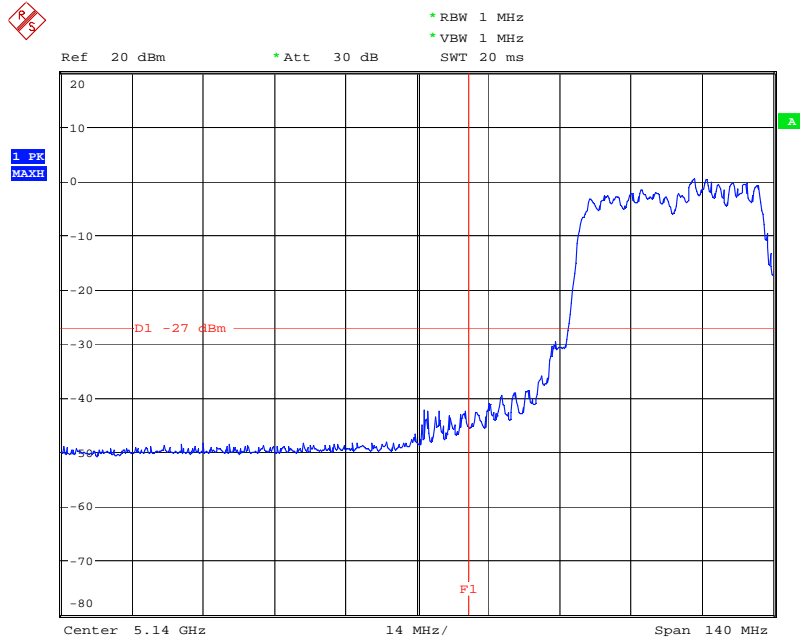

Date: 11.DEC.2007 12:31:19

EIRP Emission in Band on Configuration Drafft n MCS8 40MHz Ant. 3 + Ant. 5 / 5230 MHz

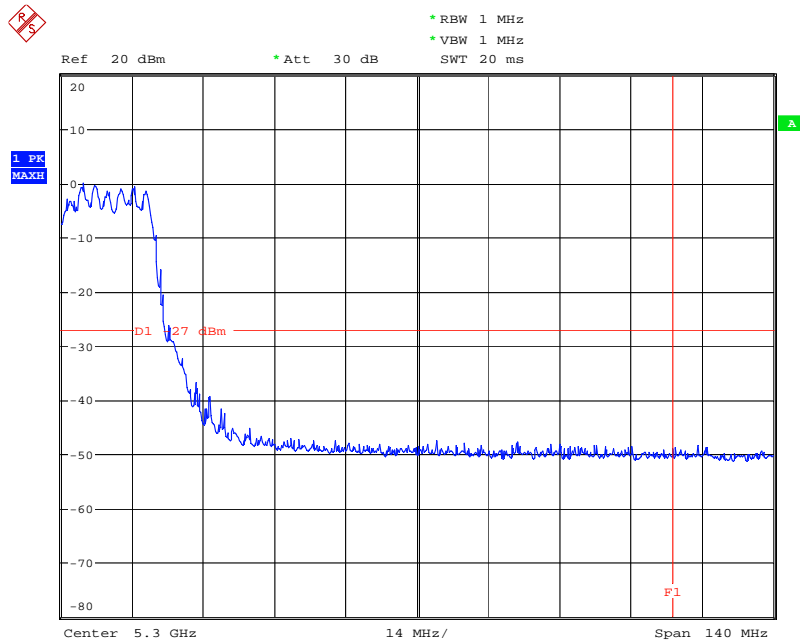

Date: 11.DEC.2007 12:34:45

4.8. Frequency Stability Measurement

4.8.1. Limit

Manufacturers of U-NII devices are responsible for ensuring frequency stability such that an emissions is maintained within the band of operation under all conditions of normal operation as specified in the user's manual or $\pm 20\text{ppm}$ (Draft n specification).

4.8.2. Measuring Instruments and Setting

Please refer to section 5 of equipments list in this report. The following table is the setting of the spectrum analyzer.

Spectrum Parameter	Setting
Attenuation	Auto
Span Frequency	Entire absence of modulation emissions bandwidth
RB	10 kHz
VB	10 kHz
Sweep Time	Auto

4.8.3. Test Procedures

1. The transmitter output (antenna port) was connected to the spectrum analyser.
2. EUT have transmitted absence of modulation signal and fixed channelize.
3. Set the spectrum analyzer span to view the entire absence of modulation emissions bandwidth.
4. Set RBW = 10 kHz, VBW = 10 kHz with peak detector and maxhold settings.
5. f_c is declaring of channel frequency. Then the frequency error formula is $(f_c - f) / f_c \times 10^6$ ppm and the limit is less than $\pm 20\text{ppm}$ (Draft n specification).
6. The test extreme voltage is to change the primary supply voltage from 85 to 115 percent of the nominal value
7. Extreme temperature rule is $-30^\circ\text{C} \sim 50^\circ\text{C}$.
8. Measuring multiple antennas, the connector is required to link with Power Meter through a combiner.

4.8.4. Test Setup Layout

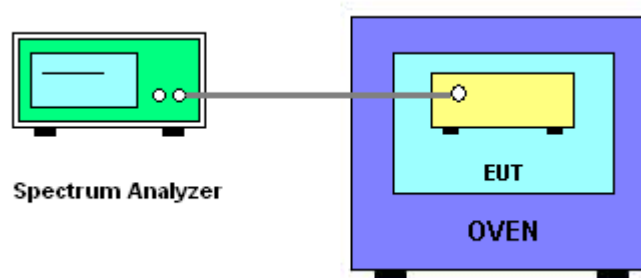

4.8.5. Test Deviation

There is no deviation with the original standard.

4.8.6. EUT Operation during Test

The EUT was programmed to be in continuously un-modulation transmitting mode.

4.8.7. Test Result of Frequency Stability

Voltage vs. Frequency Stability

Voltage	Measurement Frequency (MHz)
(V)	5200
126.50	5200.012400
110.00	5200.012400
93.50	5200.012400
Max. Deviation (MHz)	0.012400
Max. Deviation (ppm)	2.38

Temperature vs. Frequency Stability

Temperature	Measurement Frequency (MHz)
(°C)	5200
-30	5200.065400
-20	5200.061200
-10	5200.061200
0	5200.043200
10	5200.034200
20	5200.012400
30	5199.998200
40	5199.998200
50	5199.996800
Max. Deviation (MHz)	0.065400
Max. Deviation (ppm)	12.58

4.9. Antenna Requirements

4.9.1. Limit

Except for special regulations, the Low-power Radio-frequency Devices must not be equipped with any jacket for installing an antenna with extension cable. An intentional radiator shall be designed to ensure that no antenna other than that furnished by the responsible party shall be used with the device. The use of a permanently attached antenna or of an antenna that uses a unique coupling to the intentional radiator shall be considered sufficient to comply with the provisions of this Section. The manufacturer may design the unit so that the user can replace a broken antenna, but the use of a standard antenna jack or electrical connector is prohibited. Further, this requirement does not apply to intentional radiators that must be professionally installed.

4.9.2. Antenna Connector Construction

Please refer to section 3.3 in this test report; antenna connector complied with the requirements.

5. LIST OF MEASURING EQUIPMENTS

Instrument	Manufacturer	Model No.	Serial No.	Characteristics	Calibration Date	Remark
EMC Receiver	R&S	ESCS 30	100359	9kHz – 2.75GHz	Mar. 01, 2007	Conduction (CO04-HY)
LISN	MessTec	NNB-2/16Z	99079	9kHz – 30MHz	Mar. 31, 2007	Conduction (CO04-HY)
LISN (Support Unit)	EMCO	3810/2NM	9703-1839	9kHz – 30MHz	Mar. 22, 2007	Conduction (CO04-HY)
RF Cable-CON	UTIFLEX	3102-26886-4	CB049	9kHz – 30MHz	Apr. 20, 2007	Conduction (CO04-HY)
ISN	SCHAFFNER	ISN T400	21653	9kHz –30MHz	May 09, 2007	Conduction (CO04-HY)
EMI Filter	LINDGREN	LRE-2030	2651	< 450 Hz	N/A	Conduction (CO04-HY)
Isolation Transformer	Erika Fiedler OHG	D-65396 Walluf	58	45MHz-2.15GHz	N/A	Conduction (CO04-HY)
3m Semi Anechoic Chamber	SIDT FRANKONIA	SAC-3M	03CH03-HY	30 MHz - 1 GHz 3m	Jun. 14, 2007	Radiation (03CH03-HY)
Amplifier	SCHAFFNER	CPA9231A	1886	9 kHz - 2 GHz	Jan. 22, 2007	Radiation (03CH03-HY)
Amplifier	Agilent	8449B	3008A02120	1 GHz - 26.5 GHz	Jun. 07, 2007	Radiation (03CH03-HY)
Amplifier	MITEQ	AMF-6F-260400	923364	26.5 GHz - 40 GHz	Jan. 22, 2007*	Radiation (03CH03-HY)
Spectrum Analyzer	R&S	FSP40	100305	9 kHz - 40 GHz	Sep. 27, 2007	Radiation (03CH03-HY)
Loop Antenna	R&S	HFH2-Z2	860004/001	9 kHz - 30 MHz	May 23, 2006*	Radiation (03CH03-HY)
Bilog Antenna	SCHAFFNER	CBL 6112D	22237	30 MHz – 1 GHz	Jul. 21, 2007	Radiation (03CH03-HY)
Horn Antenna	EMCO	3115	6741	1GHz ~ 18GHz	May 04, 2007	Radiation (03CH03-HY)
Horn Antenna	SCHWARZBECK	BBHA9170	BBHA9170154	15 GHz - 40 GHz	NCR	Radiation (03CH03-HY)
RF Cable-R03m	Jye Bao	RG142	CB021	30 MHz - 1 GHz	Dec. 03, 2007	Radiation (03CH03-HY)
RF Cable-HIGH	SUHNER	SUCOFLEX 106	03CH03-HY	1 GHz - 40 GHz	Dec. 03, 2007	Radiation (03CH03-HY)
Turn Table	HD	DS 420	420/650/00	0 – 360 degree	N/A	Radiation (03CH03-HY)
Antenna Mast	HD	MA 240	240/560/00	1 m - 4 m	N/A	Radiation (03CH03-HY)
Spectrum Analyzer	R&S	FSP30	100023	9kHz ~ 30GHz	Dec. 17, 2007	Conducted (TH01-HY)
Power Meter	R&S	NRVS	100444	DC ~ 40GHz	Jun. 27, 2007	Conducted (TH01-HY)
Power Sensor	R&S	NRV-Z51	100458	DC ~ 30GHz	Jun. 27, 2007	Conducted (TH01-HY)
Power Sensor	R&S	NRV-Z32	100057	30MHz ~ 6GHz	Jun. 27, 2007	Conducted (TH01-HY)
AC Power Source	HPC	HPA-500W	HPA-9100024	AC 0 ~ 300V	May 04, 2007*	Conducted (TH01-HY)
DC Power Source	G.W.	GPC-6030D	C671845	DC 1V ~ 60V	Mar. 03, 2007	Conducted (TH01-HY)

Instrument	Manufacturer	Model No.	Serial No.	Characteristics	Calibration Date	Remark
Temp. and Humidity Chamber	KSON	THS-C3L	612	N/A	Oct. 01, 2007	Conducted (TH01-HY)
RF CABLE-1m	Jye Bao	RG142	CB034-1m	20MHz ~ 7GHz	Dec. 01, 2007	Conducted (TH01-HY)
RF CABLE-2m	Jye Bao	RG142	CB035-2m	20MHz ~ 1GHz	Dec. 01, 2007	Conducted (TH01-HY)
Signal Generator	R&S	SMR40	100116	10MHz ~ 40GHz	Mar. 07, 2007	Conducted (TH01-HY)

Note: Calibration Interval of instruments listed above is one year.

* Calibration Interval of instruments listed above is two year.

NCR means Non-Calibration required.

6. TEST LOCATION

SHIJR	ADD : 6Fl., No. 106, Sec. 1, Shintai 5th Rd., Shijr City, Taipei, Taiwan 221, R.O.C. TEL : 886-2-2696-2468 FAX : 886-2-2696-2255
HWA YA	ADD : No. 52, Hwa Ya 1st Rd., Kwei-Shan Hsiang, Tao Yuan Hsien, Taiwan, R.O.C. TEL : 886-3-327-3456 FAX : 886-3-318-0055
LINKOU	ADD : No. 30-2, Dingfu Tsuen, Linkou Shiang, Taipei, Taiwan 244, R.O.C TEL : 886-2-2601-1640 FAX : 886-2-2601-1695
DUNGHU	ADD : No. 3, Lane 238, Kangle St., Neihu Chiu, Taipei, Taiwan 114, R.O.C. TEL : 886-2-2631-4739 FAX : 886-2-2631-9740
JUNGHE	ADD : 7Fl., No. 758, Jungjeng Rd., Junghe City, Taipei, Taiwan 235, R.O.C. TEL : 886-2-8227-2020 FAX : 886-2-8227-2626
NEIHU	ADD : 4Fl., No. 339, Hsin Hu 2 nd Rd., Taipei 114, Taiwan, R.O.C. TEL : 886-2-2794-8886 FAX : 886-2-2794-9777
JHUBEI	ADD : No.8, Lane 724, Bo-ai St., Jhubei City, HsinChu County 302, Taiwan, R.O.C. TEL : 886-3-656-9065 FAX : 886-3-656-9085

7. TAF CERTIFICATE OF ACCREDITATION



Certificate No. : L1190-070110

財團法人全國認證基金會
Taiwan Accreditation Foundation

Certificate of Accreditation

This is to certify that

Sporton International Inc.

EMC & Wireless Communications Laboratory

No.52, Hwa Ya 1st Rd., Hwa Ya Technology Park, Kwei-Shan Hsiang, Tao Yuan Hsien,
Taiwan, R.O.C.

is accredited in respect of laboratory

Accreditation Criteria	: ISO/IEC 17025:2005
Accreditation Number	: 1190
Originally Accredited	: December 15, 2003
Effective Period	: January 10, 2007 to January 09, 2010
Accredited Scope	: Testing Field, see described in the Appendix
Specific Accreditation Program	: Accreditation Program for Designated Testing Laboratory for Commodities Inspection : Accreditation Program for Telecommunication Equipment Testing Laboratory



Jay-San Chen
President, Taiwan Accreditation Foundation
Date : January 10, 2007

P1, total 9 pages

The Appendix forms an integral part of this Certificate, which shall be invalid when used without the Appendix.