

# FCC TEST REPORT

according to

## FCC Rules and Regulations

### Part 15 Subpart C

Applicant	: Netgear Inc.
Address	: 4500 Great America Parkway, Santa Clara, California 95054 U.S.A.
Equipment	: ProSafe Wireless ADSL Modem VPN Firewall Router
Model No.	: DGFV114G
Series No.	: DGFV114GB
FCC ID	: PY307200066
Trade Name	: Netgear

Laboratory Accreditation



1332

- The test result refers exclusively to the test presented test model / sample.,
- Without written approval of *Exclusive Certification Corp.* the test report shall not be reproduced except in full.
- The EUT is also considered as a kind of computer peripheral, because the connection to computer is necessary for typical use. It has been verified to comply with the requirements of FCC Part 15, Subpart B, Class B (DoC). The test report has been issued separately.

## Contents

<b>1. Report of Measurements and Examinations</b> .....	<b>5</b>
1.1 List of Measurements and Examinations.....	5
<b>2. Test Configuration of Equipment under Test</b> .....	<b>6</b>
2.1 Feature of Equipment under Test.....	6
2.2 RF Specifications .....	6
2.3 Test Mode & Test Software .....	7
2.4 Description of Test System.....	8
2.5 Connection Diagram of Test System.....	9
2.6 General Information of Test.....	10
2.7 Measurement Uncertainty.....	10
2.8 History of this test report .....	11
<b>3. Antenna Requirements</b> .....	<b>12</b>
3.1 Standard Applicable .....	12
3.2 Antenna Construction and Directional Gain.....	12
<b>4. Test of Conducted Emission</b> .....	<b>13</b>
4.1 Test Limit.....	13
4.2 Test Procedures.....	13
4.3 Typical Test Setup .....	14
4.4 Measurement equipment .....	14
4.5 Test Result and Data.....	15
4.6 Test Photographs .....	27
<b>5. Test of Radiated Emission</b> .....	<b>28</b>
5.1 Test Limit.....	28
5.2 Test Procedures.....	29
5.3 Typical Test Setup.....	30
5.4 Measurement equipment .....	30
5.5 Test Result and Data.....	31
5.6 Test Photographs .....	95
<b>6. 6dB Bandwidth Measurement Data</b> .....	<b>96</b>
6.1 Test Limit .....	96
6.2 Test Procedures .....	96
6.3 Test Setup Layout .....	96
6.4 Measurement equipment .....	96
6.5 Test Result and Data.....	96
<b>7. Maximum Peak Output Power</b> .....	<b>103</b>
7.1 Test Limit .....	103
7.2 Test Procedures .....	103
7.3 Test Setup Layout .....	103
7.4 Measurement equipment .....	103
7.5 Test Result and Data.....	103
<b>8. Band Edges Measurement</b> .....	<b>111</b>
8.1 Test Limit .....	111
8.2 Test Procedure : .....	111
8.3 Test Setup Layout .....	111
8.4 List of Measuring Equipment Used.....	111
8.5 Test Result and Data.....	111

8.6 Restrict band emission Measurement Data ..... 121

**9. Power Spectral Density ..... 125**

9.1 Test Limit ..... 125

9.2 Test Procedures ..... 125

9.3 Test Setup Layout : ..... 125

9.4 List of Measuring Equipment Used ..... 125

9.5 Test Result and Data ..... 125

**10. Restricted Bands of Operation ..... 133**

10.1 Labeling Requirement ..... 133

**Appendix A. Photographs of EUT ..... A1 ~ A12**

# CERTIFICATE OF COMPLIANCE

according to

## FCC Rules and Regulations

### Part 15 Subpart C

Applicant	: Netgear Inc.
Address	: 4500 Great America Parkway, Santa Clara, California 95054 U.S.A.
Equipment	: ProSafe Wireless ADSL Modem VPN Firewall Router
Model No.	: DGFV114G
Series No.	: DGFV114GB
FCC ID	: PY307200066

I **HEREBY** CERTIFY THAT :

The measurements shown in this test report were made in accordance with the procedures given in **ANSI C63.4** The equipment was **passed** the test performed according to **FCC Rules and Regulations Part 15 Subpart C (2005)**.

The test was carried out on Jun. 08, 2007 at **Exclusive Certification Corp.**

Signature

  
Anson Chou / Manager

## 1. Report of Measurements and Examinations

### 1.1 List of Measurements and Examinations

FCC Rule	Description of Test	Result
15.203	. Antenna Requirement	Pass
15.207	. Conducted Emission	Pass
15.209 15.247(d)	. Radiated Emission	Pass
15.247(a)(2)	. 6dB Bandwidth	Pass
15.247(b)	. Maximum Peak Output Power	Pass
15.247(d)	. 100kHz Bandwidth of Frequency Band Edges	Pass
15.247(e)	. Power Spectral Density	Pass
1.1307 1.1310 2.1091 2.1093	. RF Exposure Compliance	Pass

## 2. Test Configuration of Equipment under Test

### 2.1 Feature of Equipment under Test

- WAN port: ADSL, RJ-11, Annex A, interoperable with T1.143, G.DMT, G.lite, Multimode, and supports Dying Gasp.
- LAN ports: 4 RJ45port 10/100 Mbps fast Ethernet switch, N-way automatic speed negotiation supported, Auto MDI/MDIX supported. The order from left to right is: 4, 3, 2, 1.
- Reset button: One recessed momentary push button, requiring a paper clip to push. When this button is held for 5 seconds, the Test LED lights Amber and the gateway resets to factory defaults.
- Power jack: 12V DC, 1A
- ADSL Annex A interoperable with T1.413, G.DMT, G.lite and multi-mode
- ADSL Annex B with UR2 compliance
- 4-port switch with 10/100Mbps auto-negotiation and MDI/MDI-X support
- Reset button: reset to factory default by pressing button for 5 seconds
- Integrated with bridge / router functionality
- Integrated with Firewall functionality
- Dying Gasp support
- K.21 function reserved

### 2.2 RF Specifications

<b>Host Interface</b>	WLAN on-board
<b>Frequency</b>	2.412GHz-2.4835GHz
<b>Compliance</b>	IEEE 802.11g (Backward compatible with 802.11b)
<b>Modulation</b>	802.11b: Direct Sequence Spread Spectrum
	802.11g: Orthogonal frequency division multiplexing
<b>Rate</b>	802.11b: 22, 11, 5.5, 2, 1 Mbps
	802.11g: 54, 48, 36, 24, 18, 12, 9, 6 Mbps
<b>Function</b>	Access point supported
<b>Encryption</b>	IEEE 802.1x and WPA (available in the future)
	WEP 64 bit, 128 bit
<b>Antenna</b>	Optional detachable or attachable 2dBi antenna (SMA connector on-board)

## 2.3 Test Mode & Test Software

- a. During testing, the interface cables and equipment positions were varied according to ANSI C63.4
- b. The complete test system included IBM PC, Monitor, Keyboard, Mouse, Modem, Printer and EUT for EMI test.
- c. An executive program, EMITEST.exe under WIN XP, which generates a complete line of continuously repeating "H" pattern was used as the test software.

The program was executed as follows:

1. Turn on the power of all equipment.
  2. The EUT reads the test program from the hard disk drive and runs it.
  3. The EUT sends "H" messages to the monitor, and the monitor displays " H" patterns on the screen.
  4. The PC sends "H" messages to the modem.
  5. The PC sends "H" messages to the internal Hard Disk, and the Hard Disk reads and writes the message.
  6. Repeat the steps from 2 to 5.
- d. An executive program, Radioscope.exe under WIN XP, which generates a continuous signal by the following frequency to test.
    - 802.11b (CH 01: 2412MHz) • 802.11b (CH 06: 2437MHz) • 802.11b (CH 11: 2462MHz)
    - 802.11g (CH 01: 2412MHz) • 802.11g (CH 06: 2437MHz) • 802.11g (CH 11: 2462MHz)
  - e. For conducted emission test , the two test samples (DGFV114G and DGFV114GB) and the adapter (DSA-12R-12 AUS 120120) will result in the following test modes:  
Test Mode 1: DGFV114G, Adapter: DSA-12R-12 AUS 120120.  
Test Mode 2: DGFV114GB, Adapter: DSA-12R-12 AUS 120120.
  - f. For radiated emission test and AC power line conducted emission test, the two test samples (DGFV114G and DGFV114GB) and the two adapters (DSA-12R-12 AUS 120120 and RHQ-120100-1) will result in the following test modes:  
Test Mode 1: DGFV114G, Adapter: DSA-12R-12 AUS 120120.  
Test Mode 2: DGFV114GB, Adapter: DSA-12R-12 AUS 120120.  
Test Mode 3: DGFV114G, Adapter: RHQ-120100-1.  
Test Mode 4: DGFV114GB, Adapter: RHQ-120100-1.

## 2.4 Description of Test System

Device	Manufacturer	Model No.	Description
PC	IBM	IGV	Power Cable, Unshielding 1.8 m
Monitor	SlimAGE	510A	Power Cable, Adapter Unshielding 1.8 m Data Cable, VGA Shielding 1.35 m
Keyboard	IBM	KB-0225	Data Cable, PS2 Shielding 1.85 m
Mouse	IBM	MO28VO	Data Cable, USB Shielding 1.85 m
Modem	ACEXX	DM-1414	Power Cable, Adapter Unshielding 1.8 m Data Cable, RS232 Shielding 1.35 m
Printer	HP	Desk Jet400	Power Cable, Adapter Unshielding 1.8 m Data Cable, PRINT Shielding 1.6 m
C.O. (Remote Workstation)	ZyXEL	IES-1000	Power Cable, Unshielding 1.8 m

### Use Cable:

Cable	Quantity	Description
RJ11	1	Unshielding, 3.0m
RJ45	1	Unshielding, 1.5m
RJ45	3	Unshielding, 0.5m



## 2.5 Connection Diagram of Test System

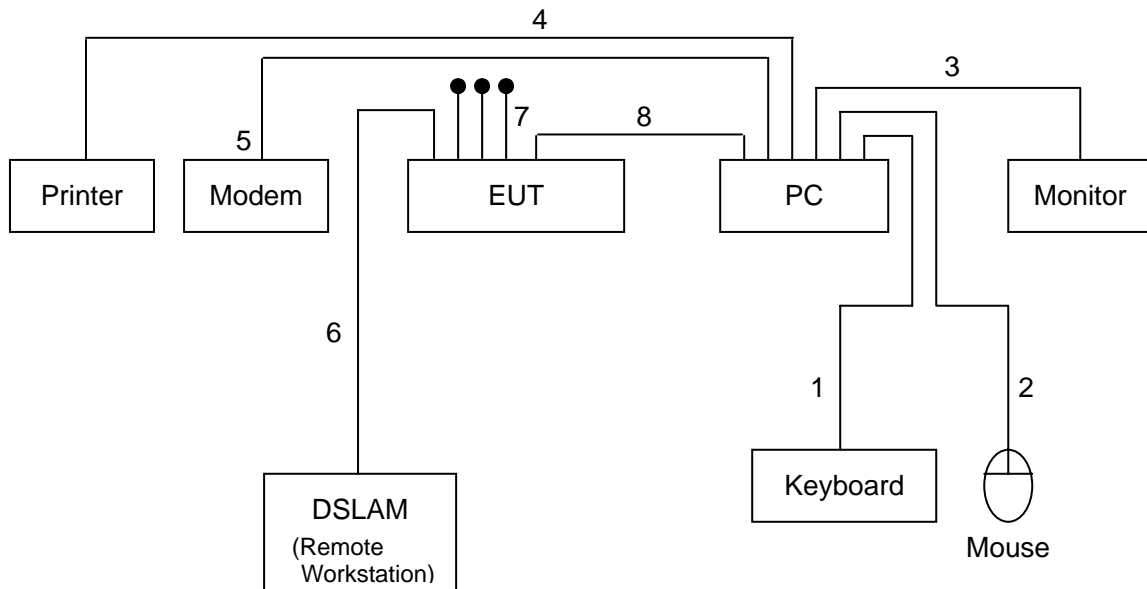

1. The PS2 cable is connected from PC to the Keyboard.
2. The USB cable is connected from PC to the Mouse.
3. The VGA cable is connected from PC to the Monitor.
4. The PRINT cable is connected from PC to the Printer.
5. The RS232 cable is connected from PC to the Modem.
6. The RJ11 Cable is connected from EUT to the Remote workstation.
7. Those RJ45 cables are floating.
8. The RJ45 cable is connected from PC to the EUT.

## 2.6 General Information of Test

Test Site :	Exclusive Certification Corp. 4F-2, No. 28, Lane 78, Xing-Ai Rd. Nei-hu, Taipei City 114 Taiwan R.O.C.
Test Site Location (OATS1-SD):	No.68-1, Shihbachongsi, shihding Township, Taipei City 223, Taiwan, R.O.C. Registration Number: 632249.
FCC Registration Number :	632249
IC Registration Number :	6597A-1
VCCI Registration Number :	T-182 for Telecommunication Test C-2188 for Conducted emission test R-1902 for Radiated emission test
Test Voltage:	AC 120V/ 60Hz
Test in Compliance with:	ANSI C63.4-2003 FCC Part 15 Subpart C
Frequency Range Investigated:	Conducted: from 150kHz to 30 MHz Radiation: from 30 MHz to 24620MHz
Test Distance:	The test distance of radiated emission from antenna to EUT is 3 M.

## 2.7 Measurement Uncertainty

Measurement Item	Measurement Frequency	Polarization	Uncertainty
Conducted Emission	9 kHz ~ 30 MHz	LINE/NEUTRAL	2.71 dB
Radiated Emission	30 MHz ~ 1GHz	Vertical	4.11 dB
		Horizontal	4.10 dB
6 dB Bandwidth	---	---	7500 Hz
Maximum Peak Output Power	---	---	1.4 dB
100kHz Bandwidth of Frequency Band Edges	---	---	2.2 dB
Power Spectral Density	---	---	2.2 dB



### 3. Antenna Requirements

#### 3.1 Standard Applicable

For intentional device, according to FCC 47 CFR Section 15.203, an intentional radiator shall be designed to ensure that no antenna other than that furnished by the responsible party shall be used with the device.

And according to FCC 47 CFR Section 15.247 (b), if transmitting antennas of directional gain greater than 6dBi are used, the power shall be reduced by the amount in dB that the directional gain of the antenna exceeds 6dBi.

#### 3.2 Antenna Construction and Directional Gain

Antenna type: Reverse SMA Connector, Dipole Antenna

Antenna Gain: 5 dBi.

## 4. Test of Conducted Emission

### 4.1 Test Limit

Conducted Emissions were measured from 150 kHz to 30 MHz with a bandwidth of 9 KHz on the 120 VAC power and return leads of the EUT according to the methods defined in ANSI C63.4-2003 Section 3.1. The EUT was placed on a nonmetallic stand in a shielded room 0.8 meters above the ground plane as shown in section 2.2. The interface cables and equipment positioning were varied within limits of reasonable applications to determine the position produced maximum conducted emissions.

Frequency (MHz)	Quasi Peak (dB $\mu$ V)	Average (dB $\mu$ V)
0.15 – 0.5	66-56*	56-46*
0.5 – 5.0	56	46
5.0 – 30.0	60	50

\*Decreases with the logarithm of the frequency.

### 4.2 Test Procedures

- a. The EUT was placed 0.4 meter from the conducting wall of the shielding room was kept at least 80 centimeters from any other grounded conducting surface.
- b. Connect EUT to the power mains through a line impedance stabilization network (LISN).
- c. All the support units are connecting to the other LISN.
- d. The LISN provides 50 ohm coupling impedance for the measuring instrument.
- e. The FCC states that a 50 ohm, 50 micro-Henry LISN should be used.
- f. Both sides of AC line were checked for maximum conducted interference.
- g. The frequency range from 150 kHz to 30 MHz was searched.
- h. Set the test-receiver system to Peak Detect Function and Specified Bandwidth with Maximum Hold Mode.

### 4.3 Typical Test Setup

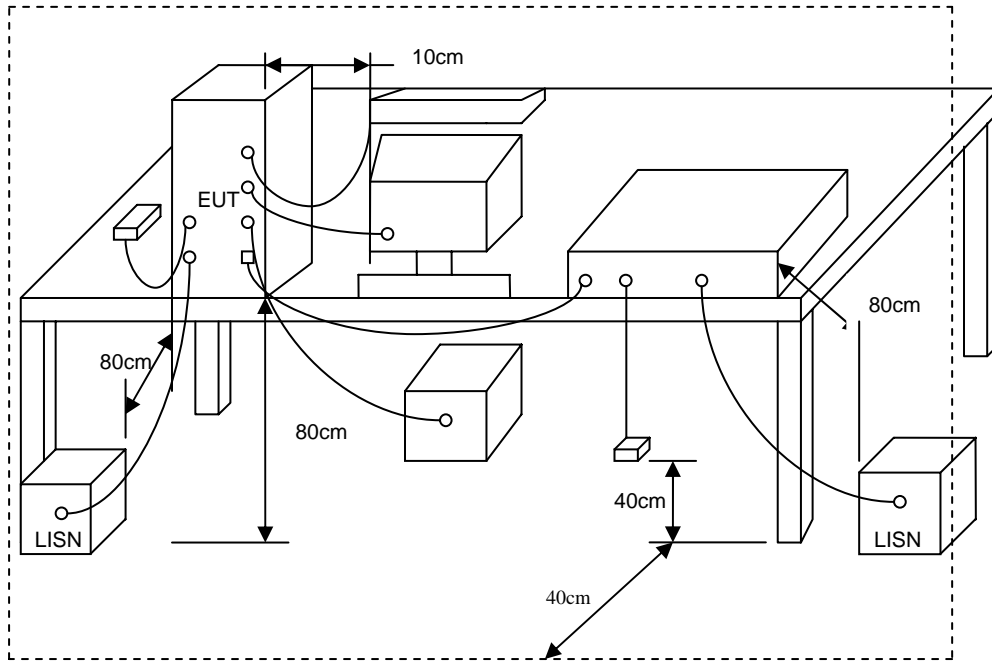

### 4.4 Measurement equipment

Instrument/Ancillary	Model No.	Manufacturer	Serial No.	Calibration Date	Valid Date.
Receiver	R&S	ESCI	100443	2006/09/20	2007/09/19
LISN	NNB-2/16Z	MESS TEC	02/10191	2007/05/14	2008/05/13
LISN	NNB-2/16Z	ROLF HEINE	03/10058	2007/04/19	2008/04/18

### 4.5 Test Result and Data

Power	: AC120V	Pol/Phase	: LINE
Test Mode 1	: 802.11g CH1	Temperature	: 25 °C
Memo	: DSA-12RN-12 AUS 120120	Humidity	: 68 %

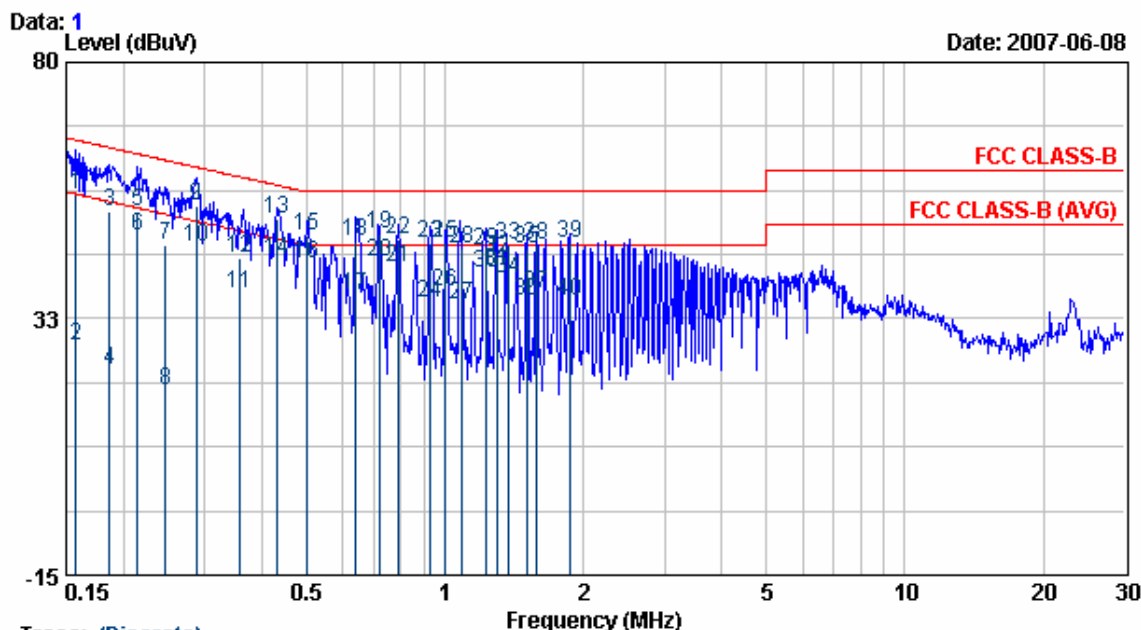

Item	Freq	Read Value	Factor	Result	Limit	Margin	Remark
	MHz	dBuV	dB	dBuV	dBuV	dBuV	
1	0.16	55.42	0.10	55.52	65.61	-10.08	QP
2	0.16	27.41	0.10	27.51	55.61	-28.09	AVERAGE
3	0.19	52.39	0.10	52.49	64.21	-11.72	QP
4	0.19	22.86	0.10	22.96	54.21	-31.25	AVERAGE
5	0.21	52.18	0.11	52.29	63.03	-10.74	QP
6	0.21	47.79	0.11	47.90	53.03	-5.13	AVERAGE
7	0.25	46.03	0.11	46.14	61.88	-15.74	QP
8	0.25	18.99	0.11	19.10	51.88	-32.78	AVERAGE
9	0.29	53.17	0.12	53.29	60.60	-7.31	QP
10	0.29	45.67	0.12	45.79	50.60	-4.81	AVERAGE
11	0.36	37.05	0.12	37.17	48.74	-11.57	AVERAGE
12	0.36	43.50	0.12	43.62	58.74	-15.12	QP
13	0.43	50.87	0.12	50.99	57.24	-6.25	QP
14	0.43	43.20	0.12	43.32	47.24	-3.92	AVERAGE
15	0.50	47.78	0.13	47.91	56.00	-8.09	QP
16	0.50	42.44	0.13	42.57	46.00	-3.43	AVERAGE
17	0.64	36.57	0.14	36.71	46.00	-9.29	AVERAGE
18	0.64	46.68	0.14	46.82	56.00	-9.18	QP
19	0.72	48.01	0.14	48.15	56.00	-7.85	QP
20	0.72	42.80	0.14	42.94	46.00	-3.06	AVERAGE
21	0.79	41.95	0.14	42.09	46.00	-3.91	AVERAGE
22	0.79	47.13	0.14	47.27	56.00	-8.73	QP
23	0.93	46.44	0.15	46.59	56.00	-9.41	QP

- Remarks:
1. Level = Read Level + Factor
  2. Factor = LISN(ISN) Factor + Cable Loss
  3. All emission below 1GHz at 802.11g mode are all the same,so the 802.11g mode chosen as representative in final test.
  4. According to technical experiences,all spurious emission of 802.11g mode at channel 1,6,11 are almost the same below 1GHz,so that the channel 1 was chosen as representative in final test.
  5. The data is worse case.

Item	Freq	Read Value	Factor	Result	Limit	Margin	Remark
	MHz	dBuV	dB	dBuV	dBuV	dBuV	
24	0.93	35.19	0.15	35.34	46.00	-10.66	AVERAGE
25	1.00	46.27	0.15	46.42	56.00	-9.58	QP
26	1.00	37.31	0.15	37.46	46.00	-8.54	AVERAGE
27	1.08	34.78	0.16	34.94	46.00	-11.06	AVERAGE
28	1.08	45.47	0.16	45.63	56.00	-10.37	QP
29	1.22	45.03	0.17	45.20	56.00	-10.80	QP
30	1.22	40.96	0.17	41.13	46.00	-4.87	AVERAGE
31	1.30	41.11	0.17	41.28	46.00	-4.72	AVERAGE
32	1.30	43.72	0.17	43.89	56.00	-12.11	QP
33	1.37	45.81	0.18	45.99	56.00	-10.01	QP
34	1.37	39.89	0.18	40.07	46.00	-5.93	AVERAGE
35	1.50	45.25	0.19	45.44	56.00	-10.56	QP
36	1.50	35.49	0.19	35.68	46.00	-10.32	AVERAGE
37	1.59	37.09	0.19	37.28	46.00	-8.72	AVERAGE
38	1.59	45.93	0.19	46.12	56.00	-9.88	QP
39	1.87	46.45	0.20	46.65	56.00	-9.35	QP
40	1.87	35.72	0.20	35.92	46.00	-10.08	AVERAGE

- Remarks:
1. Level = Read Level + Factor
  2. Factor = LISN(ISN) Factor + Cable Loss
  3. All emission below 1GHz at 802.11b/g mode are all the same,so the 802.11g mode chosen as representative in final test.
  4. According to technical experiences,all spurious emission of 802.11g mode at channel 1,6,11 are almost the same below 1GHz,so that the channel 1 was chosen as representative in final test.
  5. The data is worse case.



Power	: AC120V	Pol/Phase	: NEUTRAL
Test Mode 1	: 802.11g CH1	Temperature	: 25 °C
Memo	: DSA-12RN-12 AUS 120120	Humidity	: 68 %

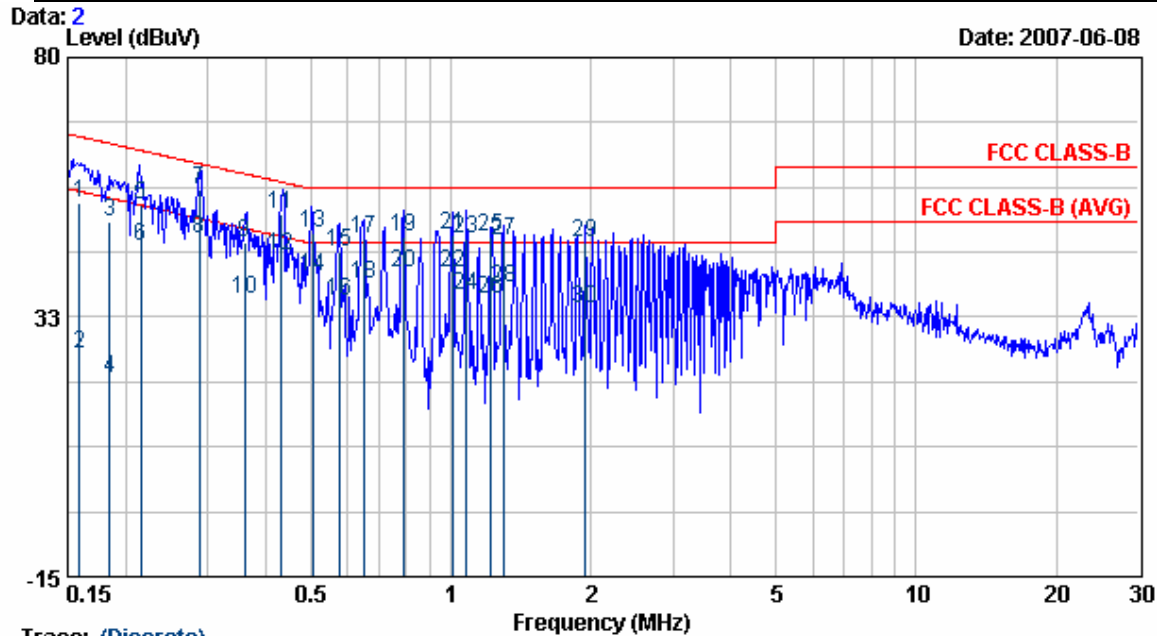

Item	Freq	Read Value	Factor	Result	Limit	Margin	Remark
	MHz	dBuV	dB	dBuV	dBuV	dBuV	
1	0.16	53.35	0.09	53.44	65.53	-12.09	QP
2	0.16	25.66	0.09	25.75	55.53	-29.78	AVERAGE
3	0.18	50.01	0.09	50.10	64.28	-14.18	QP
4	0.18	21.30	0.09	21.39	54.28	-32.89	AVERAGE
5	0.22	52.89	0.09	52.98	62.99	-10.01	QP
6	0.22	45.25	0.09	45.34	52.99	-7.65	AVERAGE
7	0.29	55.78	0.10	55.88	60.59	-4.71	QP
8	0.29	46.90	0.10	47.00	50.59	-3.59	AVERAGE
9	0.36	46.09	0.11	46.20	58.74	-12.55	QP
10	0.36	35.56	0.11	35.67	48.74	-13.08	AVERAGE
11	0.43	51.38	0.11	51.49	57.23	-5.74	QP
12	0.43	43.75	0.11	43.86	47.23	-3.37	AVERAGE
13	0.50	47.76	0.12	47.88	56.00	-8.12	QP
14	0.50	39.84	0.12	39.96	46.00	-6.04	AVERAGE
15	0.58	44.39	0.13	44.52	56.00	-11.48	QP
16	0.58	35.42	0.13	35.55	46.00	-10.45	AVERAGE
17	0.65	46.86	0.13	46.99	56.00	-9.01	QP
18	0.65	38.56	0.13	38.69	46.00	-7.31	AVERAGE
19	0.79	46.97	0.14	47.11	56.00	-8.89	QP
20	0.79	40.43	0.14	40.57	46.00	-5.43	AVERAGE
21	1.01	47.46	0.15	47.61	56.00	-8.39	QP
22	1.01	40.64	0.15	40.79	46.00	-5.21	AVERAGE
23	1.08	46.79	0.16	46.95	56.00	-9.05	QP

- Remarks:
1. Level = Read Level + Factor
  2. Factor = LISN(ISN) Factor + Cable Loss
  3. All emission below 1GHz at 802.11b/g mode are all the same,so the 802.11g mode chosen as representative in final test.
  4. According to technical experiences,all spurious emission of 802.11g mode at channel 1,6,11 are almost the same below 1GHz,so that the channel 1 was chosen as representative in final test.
  5. The data is worse case.

Item	Freq	Read Value	Factor	Result	Limit	Margin	Remark
	MHz	dBuV	dB	dBuV	dBuV	dBuV	
24	1.08	36.16	0.16	36.32	46.00	-9.68	AVERAGE
25	1.21	46.91	0.16	47.07	56.00	-8.93	QP
26	1.21	35.50	0.16	35.66	46.00	-10.34	AVERAGE
27	1.30	46.40	0.17	46.57	56.00	-9.43	QP
28	1.30	37.63	0.17	37.80	46.00	-8.20	AVERAGE
29	1.95	45.83	0.20	46.03	56.00	-9.97	QP
30	1.95	33.98	0.20	34.18	46.00	-11.82	AVERAGE

- Remarks:
1. Level = Read Level + Factor
  2. Factor = LISN(ISN) Factor + Cable Loss
  3. All emission below 1GHz at 802.11b/g mode are all the same,so the 802.11g mode chosen as representative in final test.
  4. According to technical experiences,all spurious emission of 802.11g mode at channel 1,6,11 are almost the same below 1GHz,so that the channel 1 was chosen as representative in final test.
  5. The data is worse case.

Power	: AC120V	Pol/Phase	: LINE
Test Mode 2	: 802.11g CH1	Temperature	: 25 °C
Memo	: DSA-12RN-12 AUS 120120	Humidity	: 68 %

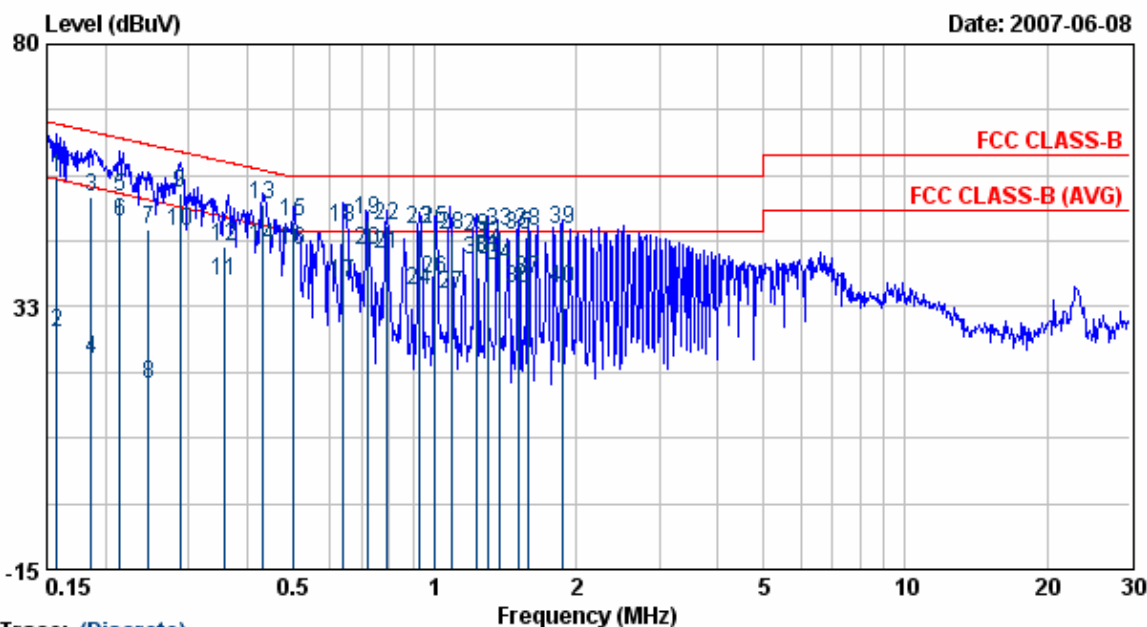

Trace: (Discrete)

Item	Freq	Read Value	Factor	Result	Limit	Margin	Remark
	MHz	dBuV	dB	dBuV	dBuV	dBuV	
1	0.16	55.63	0.10	55.73	65.61	-9.87	QP
2	0.16	27.72	0.10	27.82	55.61	-27.78	AVERAGE
3	0.19	52.22	0.10	52.32	64.21	-11.89	QP
4	0.19	22.75	0.10	22.85	54.21	-31.36	AVERAGE
5	0.21	52.10	0.11	52.21	63.03	-10.82	QP
6	0.21	47.64	0.11	47.75	53.03	-5.28	AVERAGE
7	0.25	46.29	0.11	46.40	61.88	-15.48	QP
8	0.25	18.36	0.11	18.47	51.88	-33.41	AVERAGE
9	0.29	53.10	0.12	53.22	60.60	-7.38	QP
10	0.29	45.88	0.12	46.00	50.60	-4.60	AVERAGE
11	0.36	37.03	0.12	37.15	48.74	-11.59	AVERAGE
12	0.36	43.29	0.12	43.41	58.74	-15.33	QP
13	0.43	50.77	0.12	50.89	57.24	-6.35	QP
14	0.43	43.27	0.12	43.39	47.24	-3.85	AVERAGE
15	0.50	47.74	0.13	47.87	56.00	-8.13	QP
16	0.50	42.40	0.13	42.53	46.00	-3.47	AVERAGE
17	0.64	36.57	0.14	36.71	46.00	-9.29	AVERAGE
18	0.64	46.68	0.14	46.82	56.00	-9.18	QP
19	0.72	48.08	0.14	48.22	56.00	-7.78	QP
20	0.72	42.72	0.14	42.86	46.00	-3.14	AVERAGE
21	0.79	41.93	0.14	42.07	46.00	-3.93	AVERAGE
22	0.79	47.13	0.14	47.27	56.00	-8.73	QP
23	0.93	46.44	0.15	46.59	56.00	-9.41	QP

- Remarks:
1. Level = Read Level + Factor
  2. Factor = LISN(ISN) Factor + Cable Loss
  3. All emission below 1GHz at 802.11b/g mode are all the same,so the 802.11g mode chosen as representative in final test.
  4. According to technical experiences,all spurious emission of 802.11g mode at channel 1,6,11 are almost the same below 1GHz,so that the channel 1 was chosen as representative in final test.
  5. The data is worse case.

Item	Freq	Read Value	Factor	Result	Limit	Margin	Remark
	MHz	dBuV	dB	dBuV	dBuV	dBuV	
24	0.93	35.33	0.15	35.48	46.00	-10.52	AVERAGE
25	1.00	46.22	0.15	46.37	56.00	-9.63	QP
26	1.00	37.35	0.15	37.50	46.00	-8.50	AVERAGE
27	1.08	34.74	0.16	34.90	46.00	-11.10	AVERAGE
28	1.08	45.43	0.16	45.59	56.00	-10.41	QP
29	1.22	45.00	0.17	45.17	56.00	-10.83	QP
30	1.22	40.87	0.17	41.04	46.00	-4.96	AVERAGE
31	1.30	41.03	0.17	41.20	46.00	-4.80	AVERAGE
32	1.30	43.70	0.17	43.87	56.00	-12.13	QP
33	1.37	45.81	0.18	45.99	56.00	-10.01	QP
34	1.37	39.89	0.18	40.07	46.00	-5.93	AVERAGE
35	1.50	45.25	0.19	45.44	56.00	-10.56	QP
36	1.50	35.49	0.19	35.68	46.00	-10.32	AVERAGE
37	1.59	37.15	0.19	37.34	46.00	-8.66	AVERAGE
38	1.59	45.90	0.19	46.09	56.00	-9.91	QP
39	1.87	46.45	0.20	46.65	56.00	-9.35	QP
40	1.87	35.70	0.20	35.90	46.00	-10.10	AVERAGE

- Remarks:
1. Level = Read Level + Factor
  2. Factor = LISN(ISN) Factor + Cable Loss
  3. All emission below 1GHz at 802.11b/g mode are all the same,so the 802.11g mode chosen as representative in final test.
  4. According to technical experiences,all spurious emission of 802.11g mode at channel 1,6,11 are almost the same below 1GHz,so that the channel 1 was chosen as representative in final test.
  5. The data is worse case.

Power	: AC120V	Pol/Phase	: NEUTRAL
Test Mode 2	: 802.11g CH1	Temperature	: 25 °C
Memo	: DSA-12RN-12 AUS 120120	Humidity	: 68 %

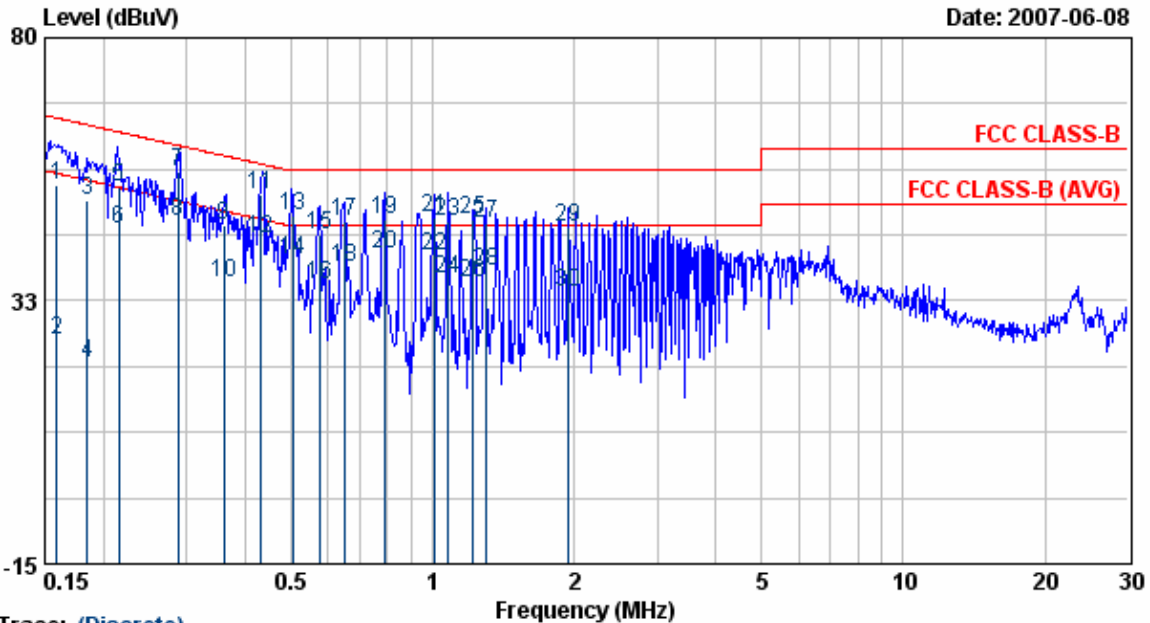

Trace: (Discrete)

Item	Freq MHz	Read Value dBuV	Factor dB	Result dBuV	Limit dBuV	Margin dBuV	Remark
1	0.16	53.30	0.09	53.39	65.53	-12.14	QP
2	0.16	25.45	0.09	25.54	55.53	-29.99	AVERAGE
3	0.18	50.40	0.09	50.49	64.28	-13.79	QP
4	0.18	21.22	0.09	21.31	54.28	-32.97	AVERAGE
5	0.22	52.93	0.09	53.02	62.99	-9.97	QP
6	0.22	45.28	0.09	45.37	52.99	-7.62	AVERAGE
7	0.29	55.74	0.10	55.84	60.59	-4.75	QP
8	0.29	46.90	0.10	47.00	50.59	-3.59	AVERAGE
9	0.36	46.09	0.11	46.20	58.74	-12.55	QP
10	0.36	35.56	0.11	35.67	48.74	-13.08	AVERAGE
11	0.43	51.50	0.11	51.61	57.23	-5.62	QP
12	0.43	43.66	0.11	43.77	47.23	-3.46	AVERAGE
13	0.50	47.70	0.12	47.82	56.00	-8.18	QP
14	0.50	39.80	0.12	39.92	46.00	-6.08	AVERAGE
15	0.58	44.44	0.13	44.57	56.00	-11.43	QP
16	0.58	35.39	0.13	35.52	46.00	-10.48	AVERAGE
17	0.65	46.86	0.13	46.99	56.00	-9.01	QP
18	0.65	38.56	0.13	38.69	46.00	-7.31	AVERAGE
19	0.79	46.95	0.14	47.09	56.00	-8.91	QP
20	0.79	40.66	0.14	40.80	46.00	-5.20	AVERAGE
21	1.01	47.46	0.15	47.61	56.00	-8.39	QP
22	1.01	40.64	0.15	40.79	46.00	-5.21	AVERAGE
23	1.08	46.84	0.16	47.00	56.00	-9.00	QP

- Remarks:
1. Level = Read Level + Factor
  2. Factor = LISN(ISN) Factor + Cable Loss
  3. All emission below 1GHz at 802.11b/g mode are all the same,so the 802.11g mode chosen as representative in final test.
  4. According to technical experiences,all spurious emission of 802.11g mode at channel 1,6,11 are almost the same below 1GHz,so that the channel 1 was chosen as representative in final test.
  5. The data is worse case.

Item	Freq	Read Value	Factor	Result	Limit	Margin	Remark
	MHz	dBuV	dB	dBuV	dBuV	dBuV	
24	1.08	36.26	0.16	36.42	46.00	-9.58	AVERAGE
25	1.21	46.91	0.16	47.07	56.00	-8.93	QP
26	1.21	35.50	0.16	35.66	46.00	-10.34	AVERAGE
27	1.30	46.40	0.17	46.57	56.00	-9.43	QP
28	1.30	37.63	0.17	37.80	46.00	-8.20	AVERAGE
29	1.95	45.72	0.20	45.92	56.00	-10.08	QP
30	1.95	34.00	0.20	34.20	46.00	-11.80	AVERAGE

- Remarks:
1. Level = Read Level + Factor
  2. Factor = LISN(ISN) Factor + Cable Loss
  3. All emission below 1GHz at 802.11b/g mode are all the same,so the 802.11g mode chosen as representative in final test.
  4. According to technical experiences,all spurious emission of 802.11g mode at channel 1,6,11 are almost the same below 1GHz,so that the channel 1 was chosen as representative in final test.
  5. The data is worse case.

Power	: AC120V	Pol/Phase	: LINE
Test Mode 3	: 802.11g CH1	Temperature	: 25 °C
Memo	: RHQ-120100-1	Humidity	: 68 %

Data: 3

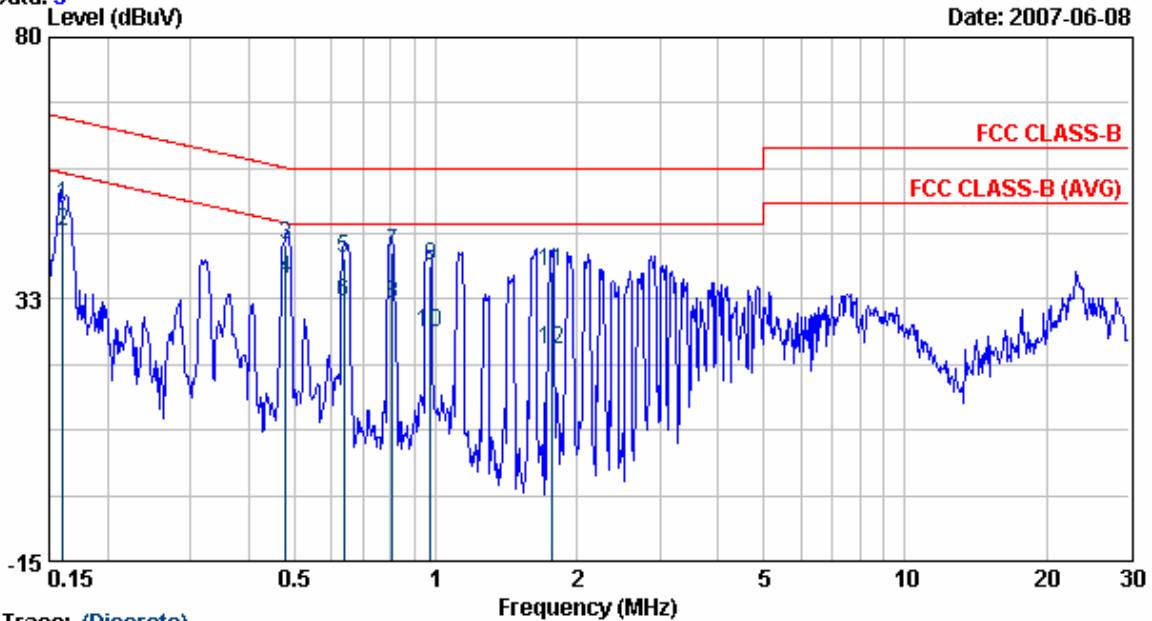

Trace: (Discrete)

Item	Freq	Read Value	Factor	Result	Limit	Margin	Remark
	MHz	dBuV	dB	dBuV	dBuV	dBuV	
1	0.16	49.50	0.10	49.60	65.45	-15.85	QP
2	0.16	44.57	0.10	44.67	55.45	-10.78	AVERAGE
3	0.48	42.12	0.13	42.25	56.37	-14.12	QP
4	0.48	36.14	0.13	36.27	46.37	-10.10	AVERAGE
5	0.64	39.87	0.14	40.01	56.00	-15.99	QP
6	0.64	31.92	0.14	32.06	46.00	-13.94	AVERAGE
7	0.81	40.77	0.14	40.91	56.00	-15.09	QP
8	0.81	31.40	0.14	31.54	46.00	-14.46	AVERAGE
9	0.97	38.42	0.15	38.57	56.00	-17.43	QP
10	0.97	26.26	0.15	26.41	46.00	-19.59	AVERAGE
11	1.77	37.43	0.20	37.63	56.00	-18.37	QP
12	1.77	23.24	0.20	23.44	46.00	-22.56	AVERAGE

- Remarks:
- Level = Read Level + Factor
  - Factor = LISN(ISN) Factor + Cable Loss
  - All emission below 1GHz at 802.11g mode are all the same,so the 802.11g mode chosen as representative in final test.
  - According to technical experiences,all spurious emission of 802.11g mode at channel 1,6,11 are almost the same below 1GHz,so that the channel 1 was chosen as representative in final test.
  - The data is worse case.

Power	: AC120V	Pol/Phase	: NEUTRAL
Test Mode 3	: 802.11g CH1	Temperature	: 25 °C
Memo	: RHQ-120100-1	Humidity	: 68 %

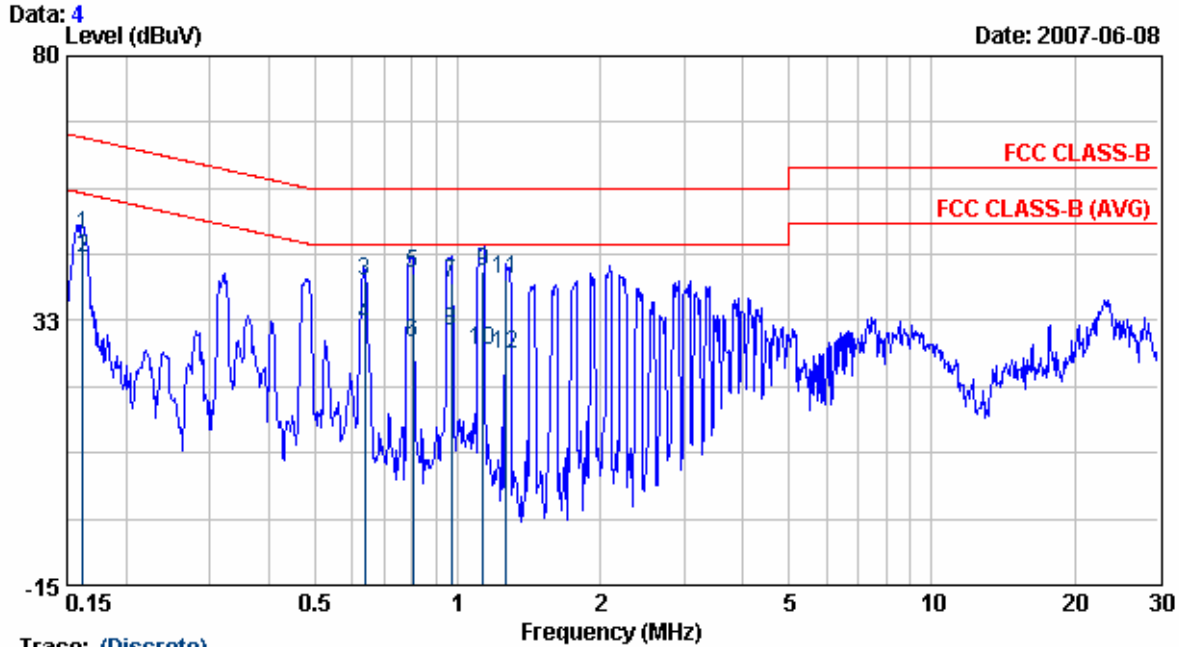

Trace: (Discrete)

Item	Freq	Read Value	Factor	Result	Limit	Margin	Remark
	MHz	dBuV	dB	dBuV	dBuV	dBuV	
1	0.16	47.85	0.09	47.94	65.35	-17.41	QP
2	0.16	43.49	0.09	43.58	55.35	-11.77	AVERAGE
3	0.64	39.47	0.13	39.60	56.00	-16.40	QP
4	0.64	31.43	0.13	31.56	46.00	-14.44	AVERAGE
5	0.81	40.79	0.14	40.93	56.00	-15.07	QP
6	0.81	28.50	0.14	28.64	46.00	-17.36	AVERAGE
7	0.97	38.93	0.15	39.08	56.00	-16.92	QP
8	0.97	30.47	0.15	30.62	46.00	-15.38	AVERAGE
9	1.13	41.29	0.16	41.45	56.00	-14.55	QP
10	1.13	26.99	0.16	27.15	46.00	-18.85	AVERAGE
11	1.26	39.87	0.17	40.04	56.00	-15.96	QP
12	1.26	26.26	0.17	26.43	46.00	-19.57	AVERAGE

- Remarks:
1. Level = Read Level + Factor
  2. Factor = LISN(ISN) Factor + Cable Loss
  3. All emission below 1GHz at 802.11b/g mode are all the same,so the 802.11g mode chosen as representative in final test.
  4. According to technical experiences,all spurious emission of 802.11g mode at channel 1,6,11 are almost the same below 1GHz,so that the channel 1 was chosen as representative in final test.
  5. The data is worse case.



Power	: AC120V	Pol/Phase	: LINE
Test Mode 4	: 802.11g CH1	Temperature	: 25 °C
Memo	: RHQ-120100-1	Humidity	: 68 %

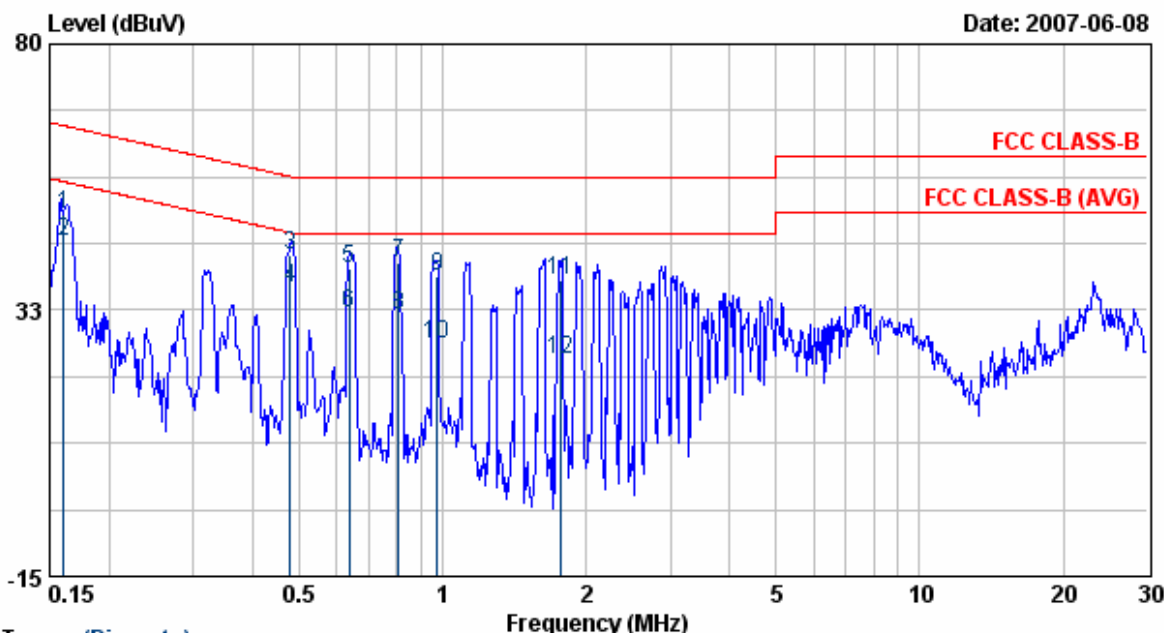

Trace: (Discrete)

Item	Freq	Read Value	Factor	Result	Limit	Margin	Remark
	MHz	dBuV	dB	dBuV	dBuV	dBuV	
1	0.16	49.42	0.10	49.52	65.45	-15.93	QP
2	0.16	44.50	0.10	44.60	55.45	-10.85	AVERAGE
3	0.48	42.23	0.13	42.36	56.37	-14.01	QP
4	0.48	36.25	0.13	36.38	46.37	-9.99	AVERAGE
5	0.64	39.84	0.14	39.98	56.00	-16.02	QP
6	0.64	31.97	0.14	32.11	46.00	-13.89	AVERAGE
7	0.81	40.88	0.14	41.02	56.00	-14.98	QP
8	0.81	31.46	0.14	31.60	46.00	-14.40	AVERAGE
9	0.97	38.47	0.15	38.62	56.00	-17.38	QP
10	0.97	26.42	0.15	26.57	46.00	-19.43	AVERAGE
11	1.77	37.49	0.20	37.69	56.00	-18.31	QP
12	1.77	23.39	0.20	23.59	46.00	-22.41	AVERAGE

- Remarks:
1. Level = Read Level + Factor
  2. Factor = LISN(ISN) Factor + Cable Loss
  3. All emission below 1GHz at 802.11g mode are all the same,so the 802.11g mode chosen as representative in final test.
  4. According to technical experiences,all spurious emission of 802.11g mode at channel 1,6,11 are almost the same below 1GHz,so that the channel 1 was chosen as representative in final test.
  5. The data is worse case.

Power	: AC120V	Pol/Phase	: NEUTRAL
Test Mode 4	: 802.11g CH1	Temperature	: 25 °C
Memo	: RHQ-120100-1	Humidity	: 68 %

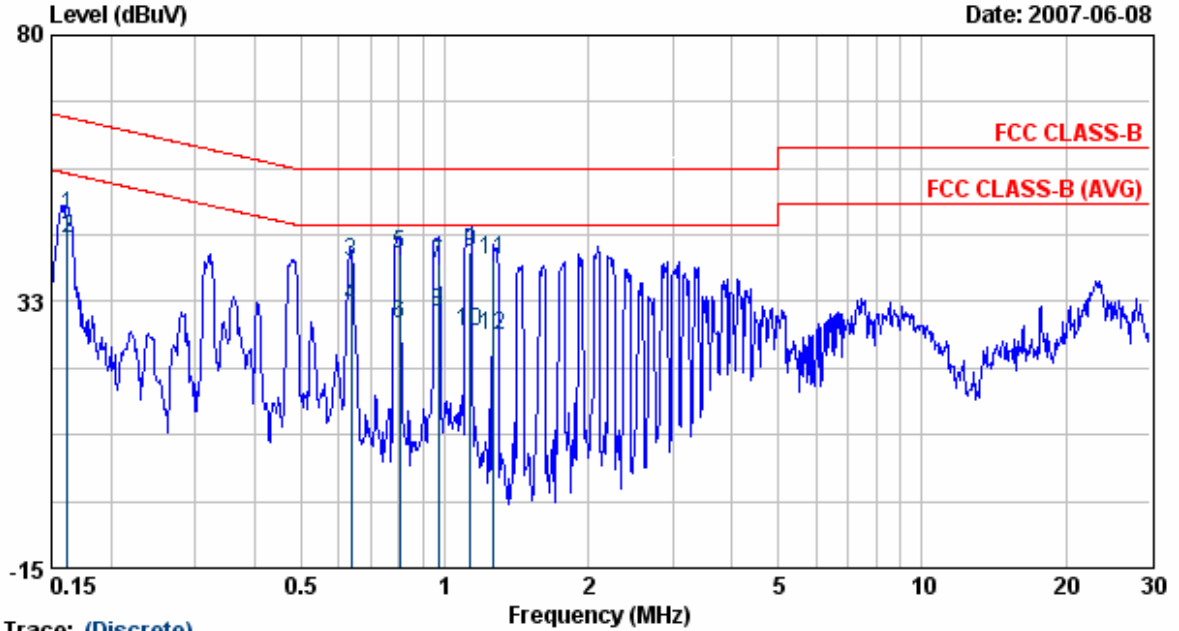

Trace: (Discrete)

Item	Freq	Read Value	Factor	Result	Limit	Margin	Remark
	MHz	dBuV	dB	dBuV	dBuV	dBuV	
1	0.16	47.77	0.09	47.86	65.35	-17.49	QP
2	0.16	43.51	0.09	43.60	55.35	-11.75	AVERAGE
3	0.64	39.57	0.13	39.70	56.00	-16.30	QP
4	0.64	31.48	0.13	31.61	46.00	-14.39	AVERAGE
5	0.81	40.83	0.14	40.97	56.00	-15.03	QP
6	0.81	28.26	0.14	28.40	46.00	-17.60	AVERAGE
7	0.97	38.96	0.15	39.11	56.00	-16.89	QP
8	0.97	30.55	0.15	30.70	46.00	-15.30	AVERAGE
9	1.13	41.11	0.16	41.27	56.00	-14.73	QP
10	1.13	26.87	0.16	27.03	46.00	-18.97	AVERAGE
11	1.26	39.86	0.17	40.03	56.00	-15.97	QP
12	1.26	26.38	0.17	26.55	46.00	-19.45	AVERAGE

- Remarks:
1. Level = Read Level + Factor
  2. Factor = LISN(ISN) Factor + Cable Loss
  3. All emission below 1GHz at 802.11g mode are all the same, so the 802.11g mode chosen as representative in final test.
  4. According to technical experiences, all spurious emission of 802.11g mode at channel 1, 6, 11 are almost the same below 1GHz, so that the channel 1 was chosen as representative in final test.
  5. The data is worse case.

Test engineer: Ben

## 5. Test of Radiated Emission

### 5.1 Test Limit

Radiated emissions from 30 MHz to 25 GHz were measured according to the methods defines in ANSI C63.4-2003. The EUT was placed, 0.8 meter above the ground plane, as shown in section 5.6.3. The interface cables and equipment positions were varied within limits of reasonable applications to determine the positions producing maximum radiated emissions

For unintentional device, according to § 15.109(a), except for Class A digital devices, the field strength of radiated emissions from unintentional radiators at a distance of 3 meters shall not exceed the following values:

Frequency (MHz)	Distance Meters	Radiated ( $\mu$ V / M)	Radiated (dB $\mu$ V/ M)
30-88	3	100	40.0
88-216	3	150	43.5
216-960	3	200	46.0
Above 960	3	500	54.0

For unintentional device, according to CISPR PUB.22, for Class B digital devices, the general requirement of field strength of radiated emissions from intentional radiators at a distance of 10 meters shall not exceed the below table.

Frequency (MHz)	Distance Meters	Radiated (dB $\mu$ V/ M)
30-230	10	30
230-1000	10	37

## 5.2 Test Procedures

1. The EUT was placed on a rotatable table top 0.8 meter above ground.
2. The EUT was set 3 meters from the interference receiving antenna which was mounted on the top of a variable height antenna tower.
3. The table was rotated 360 degrees to determine the position of the highest radiation.
4. The antenna is a broadband antenna and its height is varied between one meter and four meters above ground to find the maximum value of the field strength both horizontal polarization and vertical polarization of the antenna are set to make the measurement.
5. For each suspected emission the EUT was arranged to its worst case and then tune the antenna tower (from 1 M to 4 M) and turn table (from 0 degree to 360 degrees) to find the maximum reading.
6. Set the test-receiver system to Peak or CISPR quasi-peak Detect Function and specified bandwidth with Maximum Hold Mode.
7. If the emission level of the EUT in peak mode was 3 dB lower than the limit specified, then testing will be stopped and peak values of EUT will be reported, otherwise, the emissions which do not have 3 dB margin will be repeated one by one using the quasi-peak method and reported.
8. For testing above 1GHz, the emission level of the EUT in peak mode was 20dB lower than average limit (that means the emission level in peak mode also complies with the limit in average mode), then testing will be stopped and peak values of EUT will be reported, otherwise, the emissions will be measured in average mode again and reported.

### 5.3 Typical Test Setup

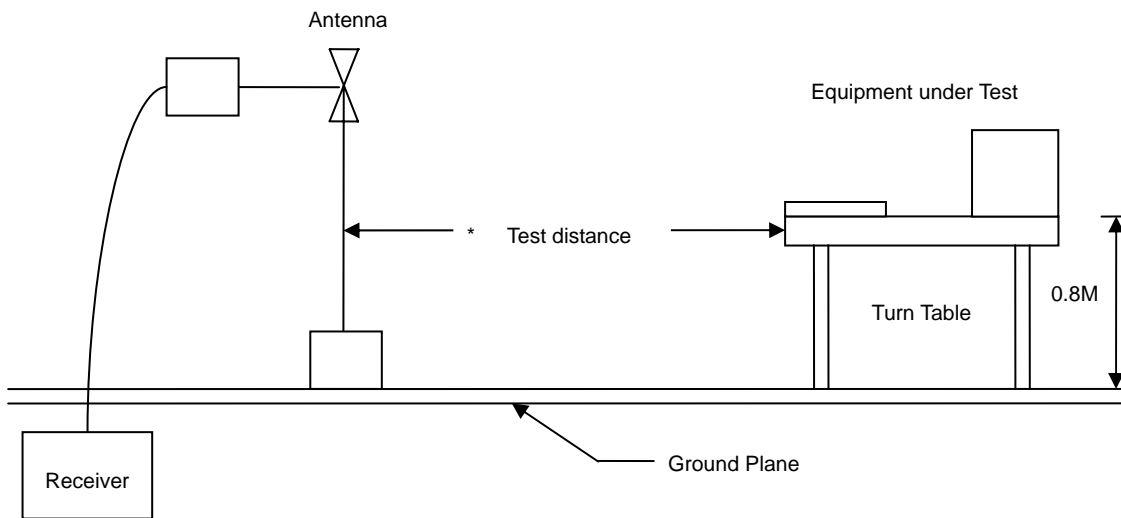

### 5.4 Measurement equipment

Instrument/Ancillary	Model No.	Manufacturer	Serial No.	Calibration Date	Valid Date
EMI Receiver	85460A	HP	3807A00454	2007/06/05	2008/06/04
Spectrum Analyzer	FSP40	R&S	10047	2007/01/23	2008/01/22
Horn Antenna	3115	EMCO	31589	2007/03/05	2008/03/04
Horn Antenna	3116	EMCO	31970	2007/03/06	2008/03/05
Bilog Antenna	CBL6112B	Schaffner	2840	2007/04/26	2008/04/25
Amplifier	8449B	Agilent	3008A01954	2007/01/12	2008/01/11
Amplifier	8447D	Agilent	2944A10531	2006/09/11	2007/09/10

## 5.5 Test Result and Data

Power	: AC120V	Pol/Phase	: VERTICAL
Test Mode 1	: Transmit / Receive	Temperature	: 25 °C
Operation Channel	: 1	Humidity	: 70 %
Modulation Type	: 802.11g	Atmospheric Pressure	: 1010 hPa
Memo	: DSA-12RN-12 AUS 120120	Rate	: 12 Mbps

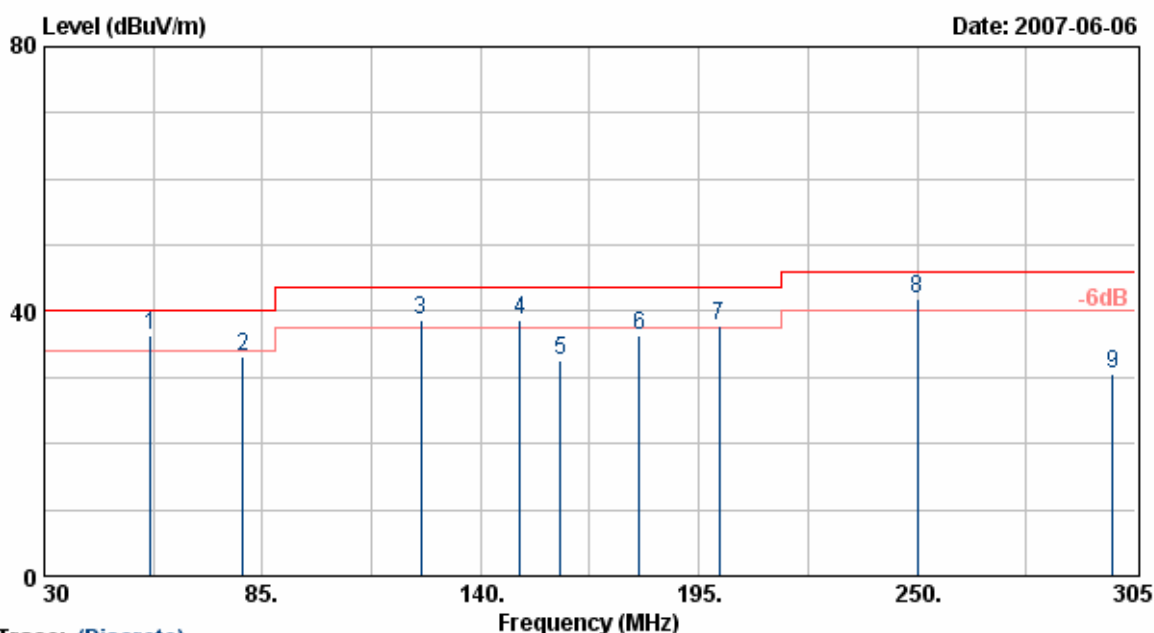

Item	Freq	Read Value	Factor	Result	Limit	Margin	Remark	Ant Pos	Tab Pos
	MHz	dBuV/m	dB	dBuV/m	dBuV/m	dB		cm	Deg
1	56.70	53.66	-17.21	36.45	40.00	-3.55	QP	100	74
2	80.11	48.16	-15.12	33.04	40.00	-6.96	Peak	100	0
3	125.00	51.21	-12.59	38.62	43.50	-4.88	QP	100	0
4	150.00	50.75	-12.12	38.63	43.50	-4.87	QP	100	89
5	160.00	47.47	-14.93	32.54	43.50	-10.96	Peak	100	115
6	180.00	48.10	-11.81	36.29	43.50	-7.21	Peak	100	115
7	200.00	50.93	-13.25	37.68	43.50	-5.82	QP	100	257
8	250.00	53.77	-11.84	41.93	46.00	-4.07	QP	100	33
9	299.25	42.84	-12.16	30.68	46.00	-15.32	Peak	100	0

## Notes:

1. Result = Read Value + Factor
2. Factor = Antenna Factor + Cable Loss - Amplifier
3. The resolution bandwidth of test receiver/spectrum analyzer is 120KHz and video bandwidth is 300kHz for Peak detection and Quasi-peak detection at frequency below 1GHz.
4. All emission below 1GHz at 802.11b/g mode are all the same, so the 802.11g mode chosen as representative in final test.
5. According to technical experiences, all spurious emission of 802.11g mode at channel 1,6,11 are almost the same below 1GHz, so that the channel 1 was chosen as representative in final test.
6. The data is worse case.

Power	: AC120V	Pol/Phase	: VERTICAL
Test Mode 1	: Transmit / Receive	Temperature	: 25 °C
Operation Channel	: 1	Humidity	: 70 %
Modulation Type	: 802.11g	Atmospheric Pressure	: 1010 hPa
Memo	: DSA-12RN-12 AUS 120120	Rate	: 12 Mbps

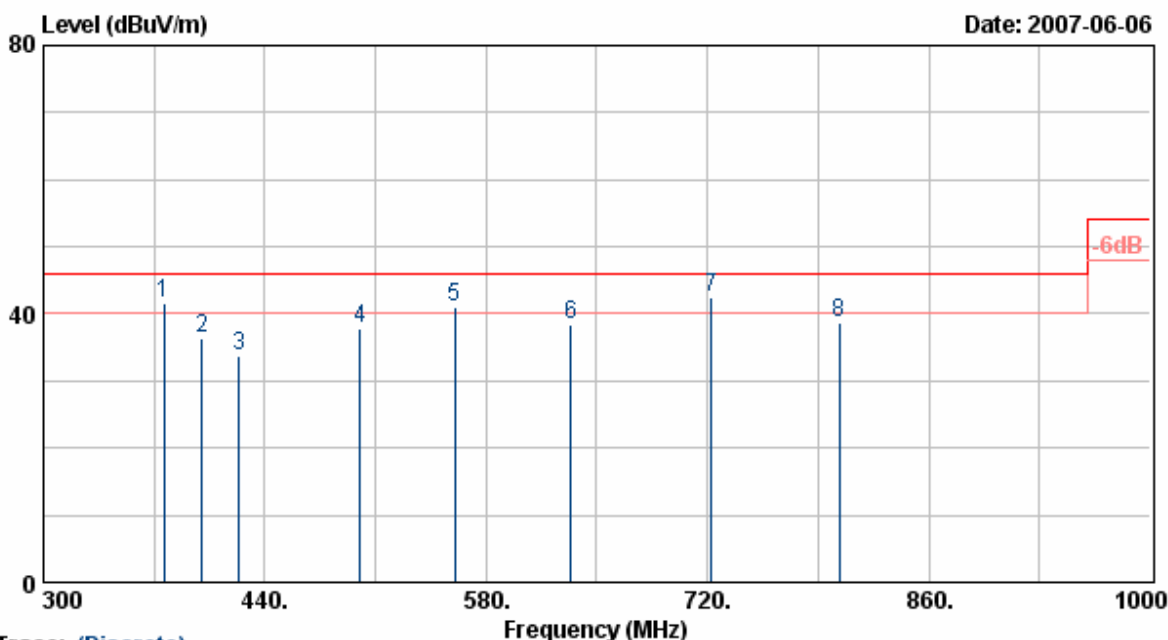

Trace: (Discrete)

Item	Freq	Read Value	Factor	Result	Limit	Margin	Remark	Ant Pos	Tab Pos
	MHz	dBuV/m	dB	dBuV/m	dBuV/m	dB		cm	Deg
1	376.30	50.99	-9.51	41.48	46.00	-4.52	QP	100	47
2	400.00	45.86	-9.40	36.46	46.00	-9.54	Peak	100	99
3	424.00	43.16	-9.39	33.77	46.00	-12.23	Peak	100	99
4	500.00	42.75	-4.96	37.79	46.00	-8.21	Peak	100	66
5	560.00	45.75	-4.75	41.00	46.00	-5.00	QP	100	121
6	633.90	41.73	-3.36	38.37	46.00	-7.63	Peak	100	35
7	722.80	46.72	-4.14	42.58	46.00	-3.42	QP	100	225
8	803.30	39.65	-1.02	38.63	46.00	-7.37	Peak	100	225

Notes:

1. Result = Read Value + Factor
2. Factor = Antenna Factor + Cable Loss - Amplifier
3. The resolution bandwidth of test receiver/spectrum analyzer is 120KHz and video bandwidth is 300kHz for Peak detection and Quasi-peak detection at frequency below 1GHz.
4. All emission below 1GHz at 802.11b/g mode are all the same,so the 802.11g mode chosen as representative in final test.
5. According to technical experiences,all spurious emission of 802.11g mode at channel 1,6,11 are almost the same below 1GHz,so that the channel 1 was chosen as representative in final test.
6. The data is worse case.

Power	: AC120V	Pol/Phase	: HORIZONTAL
Test Mode 1	: Transmit / Receive	Temperature	: 25 °C
Operation Channel	: 1	Humidity	: 70 %
Modulation Type	: 802.11g	Atmospheric Pressure	: 1010 hPa
Memo	: DSA-12RN-12 AUS 120120	Rate	: 12 Mbps

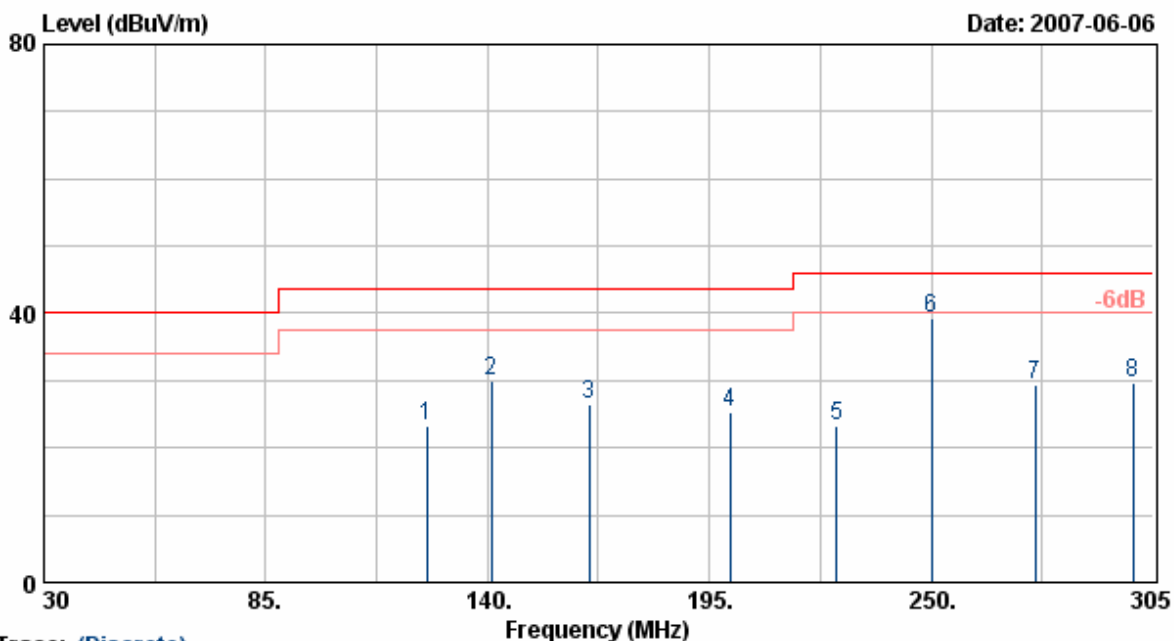

Trace: (Discrete)

Item	Freq	Read Value	Factor	Result	Limit	Margin	Remark	Ant Pos	Tab Pos
	MHz	dBuV/m	dB	dBuV/m	dBuV/m	dB		cm	Deg
1	125.00	44.74	-21.34	23.40	43.50	-20.10	Peak	200	44
2	141.00	46.66	-16.80	29.86	43.50	-13.64	Peak	200	83
3	165.30	47.25	-20.87	26.38	43.50	-17.12	Peak	200	83
4	200.00	44.90	-19.49	25.41	43.50	-18.09	Peak	200	182
5	226.50	41.74	-18.60	23.14	46.00	-22.86	Peak	200	182
6	250.00	55.79	-16.48	39.31	46.00	-6.69	Peak	200	332
7	275.80	43.52	-14.25	29.27	46.00	-16.73	Peak	200	360
8	300.05	44.76	-15.10	29.66	46.00	-16.34	Peak	200	304

Notes:

1. Result = Read Value + Factor
2. Factor = Antenna Factor + Cable Loss - Amplifier
3. The resolution bandwidth of test receiver/spectrum analyzer is 120KHz and video bandwidth is 300kHz for Peak detection and Quasi-peak detection at frequency below 1GHz.
4. All emission below 1GHz at 802.11b/g mode are all the same,so the 802.11g mode chosen as representative in final test.
5. According to technical experiences,all spurious emission of 802.11g mode at channel 1,6,11 are almost the same below 1GHz,so that the channel 1 was chosen as representative in final test.
6. The data is worse case.



Power	: AC120V	Pol/Phase	: HORIZONTAL
Test Mode 1	: Transmit / Receive	Temperature	: 25 °C
Operation Channel	: 1	Humidity	: 70 %
Modulation Type	: 802.11g	Atmospheric Pressure	: 1010 hPa
Memo	: DSA-12RN-12 AUS 120120	Rate	: 12 Mbps

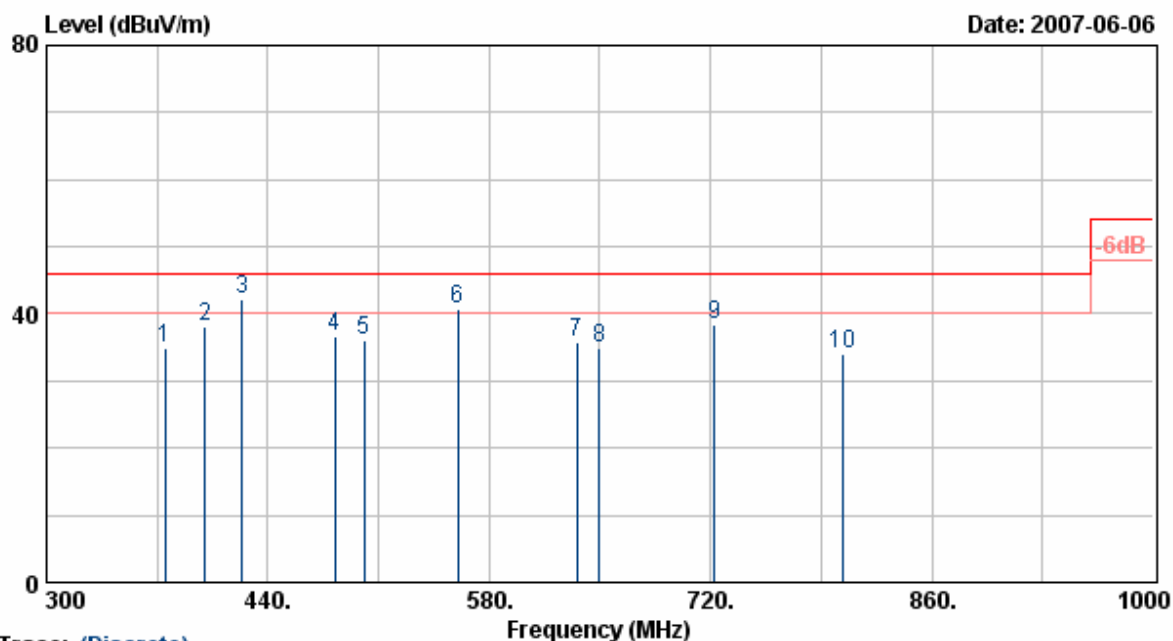

Trace: (Discrete)

Item	Freq	Read Value	Factor	Result	Limit	Margin	Remark	Ant Pos	Tab Pos
	MHz	dBUV/m	dB	dBUV/m	dBUV/m	dB		cm	Deg
1	374.92	45.52	-10.52	35.00	46.00	-11.00	Peak	200	0
2	400.00	46.88	-8.91	37.97	46.00	-8.03	Peak	200	81
3	423.90	50.21	-7.94	42.27	46.00	-3.73	QP	200	175
4	482.70	45.76	-8.99	36.77	46.00	-9.23	Peak	200	222
5	500.90	42.81	-6.68	36.13	46.00	-9.87	Peak	200	222
6	560.00	45.03	-4.18	40.85	46.00	-5.15	QP	200	0
7	635.30	40.19	-4.48	35.71	46.00	-10.29	Peak	200	0
8	650.00	38.93	-4.08	34.85	46.00	-11.15	Peak	200	66
9	722.80	45.32	-7.04	38.28	46.00	-7.72	Peak	200	0
10	803.30	37.62	-3.54	34.08	46.00	-11.92	Peak	200	50

Notes:

1. Result = Read Value + Factor
2. Factor = Antenna Factor + Cable Loss - Amplifier
3. The resolution bandwidth of test receiver/spectrum analyzer is 120KHz and video bandwidth is 300kHz for Peak detection and Quasi-peak detection at frequency below 1GHz.
4. All emission below 1GHz at 802.11b/g mode are all the same,so the 802.11g mode chosen as representative in final test.
5. According to technical experiences,all spurious emission of 802.11g mode at channel 1,6,11 are almost the same below 1GHz,so that the channel 1 was chosen as representative in final test.
6. The data is worse case.

Power	: AC120V	Pol/Phase	: VERTICAL
Test Mode 1	: Transmit / Receive	Temperature	: 25 °C
Operation Channel	: 1	Humidity	: 70 %
Modulation Type	: 802.11b	Atmospheric Pressure	: 1010 hPa
Memo	: DSA-12RN-12 AUS 120120	Rate	: 11 Mbps

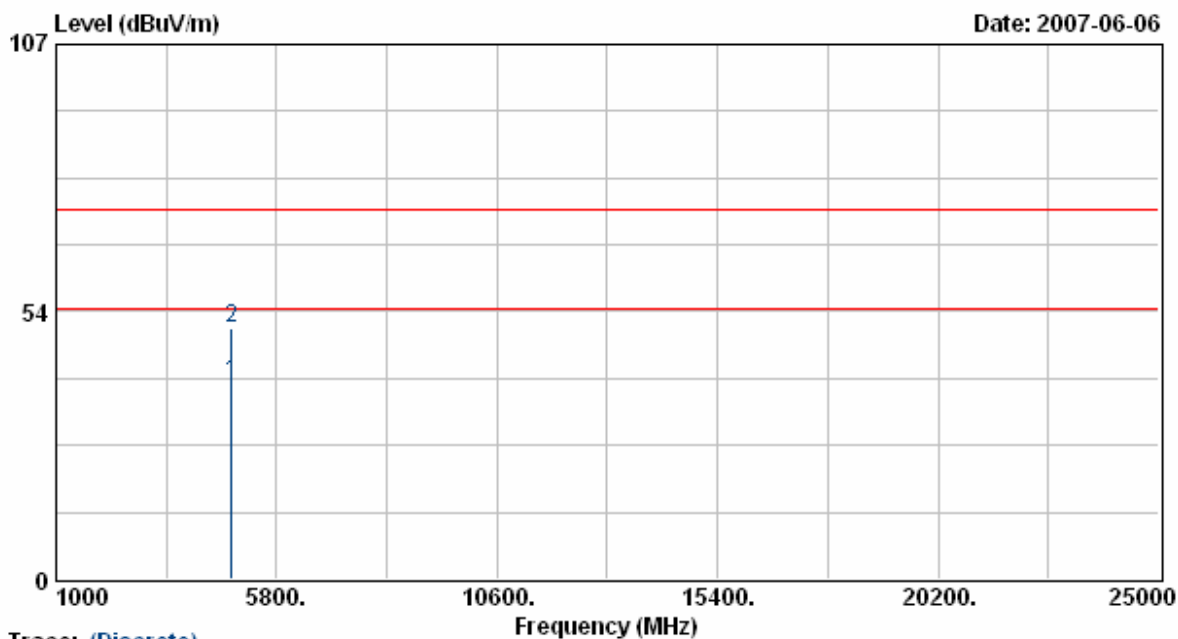

Trace: (Discrete)

Item	Freq	Read Value	Factor	Result	Limit	Margin	Remark	Ant Pos	Tab Pos
	MHz	dBuV/m	dB	dBuV/m	dBuV/m	dB		cm	Deg
1	4824.00	30.60	8.64	39.24	54.00	-14.76	Average	100	160
2	4824.00	41.65	8.64	50.29	74.00	-23.71	Peak	100	160

Notes:

1. Result = Read Value + Factor
2. Factor = Antenna Factor + Cable Loss - Amplifier
3. The resolution bandwidth of test receiver/spectrum analyzer is 120KHz and video bandwidth is 300kHz for Peak detection and Quasi-peak detection at frequency below 1GHz.
4. The resolution bandwidth of test receiver/spectrum analyzer is 1MHz and video bandwidth is 3MHz for Peak detection at frequency above 1GHz.
5. The resolution bandwidth of test receiver/spectrum analyzer is 1MHz and video bandwidth is 10Hz for Average detection at frequency above 1GHz.
6. The other emissions is too low to be measured.

Power	: AC120V	Pol/Phase	: HORIZONTAL
Test Mode 1	: Transmit / Receive	Temperature	: 25 °C
Operation Channel	: 1	Humidity	: 70 %
Modulation Type	: 802.11b	Atmospheric Pressure	: 1010 hPa
Memo	: DSA-12RN-12 AUS 120120	Rate	: 11 Mbps

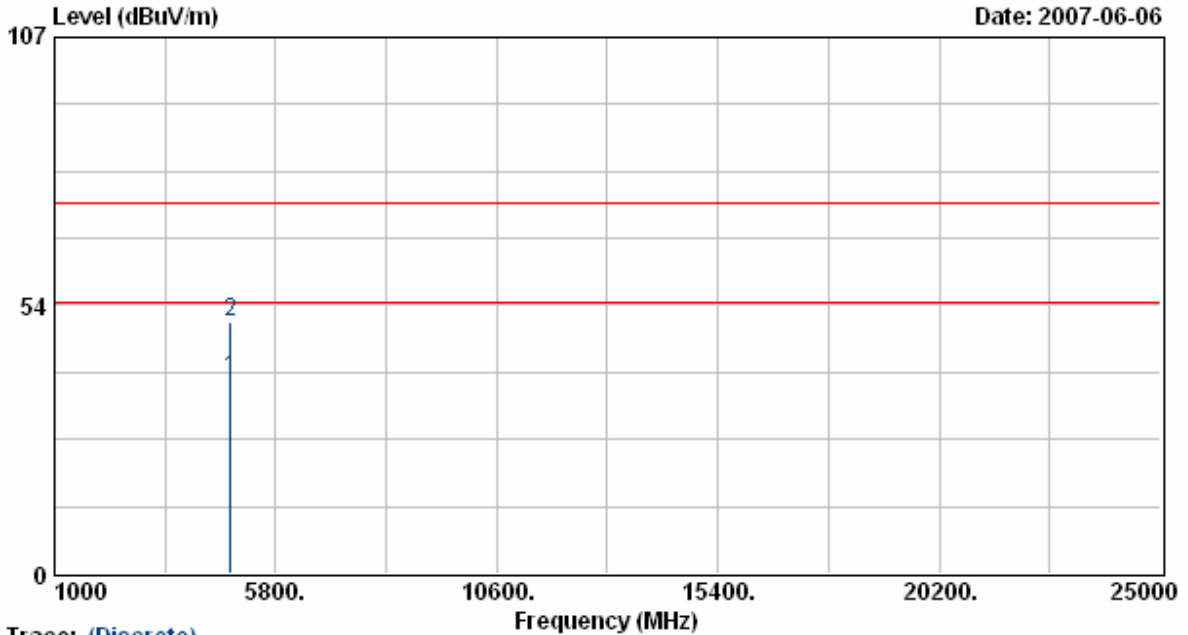

Trace: (Discrete)

Item	Freq	Read Value	Factor	Result	Limit	Margin	Remark	Ant Pos	Tab Pos
	MHz	dBuV/m	dB	dBuV/m	dBuV/m	dB		cm	Deg
1	4824.50	30.38	8.64	39.03	54.00	-14.97	Average	100	128
2	4824.50	41.37	8.64	50.01	74.00	-23.99	Peak	100	128

Notes:

1. Result = Read Value + Factor
2. Factor = Antenna Factor + Cable Loss - Amplifier
3. The resolution bandwidth of test receiver/spectrum analyzer is 120KHz and video bandwidth is 300kHz for Peak detection and Quasi-peak detection at frequency below 1GHz.
4. The resolution bandwidth of test receiver/spectrum analyzer is 1MHz and video bandwidth is 3MHz for Peak detection at frequency above 1GHz.
5. The resolution bandwidth of test receiver/spectrum analyzer is 1MHz and video bandwidth is 10Hz for Average detection at frequency above 1GHz.
6. The other emissions is too low to be measured.

Power	: AC120V	Pol/Phase	: VERTICAL
Test Mode 1	: Transmit / Receive	Temperature	: 25 °C
Operation Channel	: 6	Humidity	: 70 %
Modulation Type	: 802.11b	Atmospheric Pressure	: 1010 hPa
Memo	: DSA-12RN-12 AUS 120120	Rate	: 11 Mbps

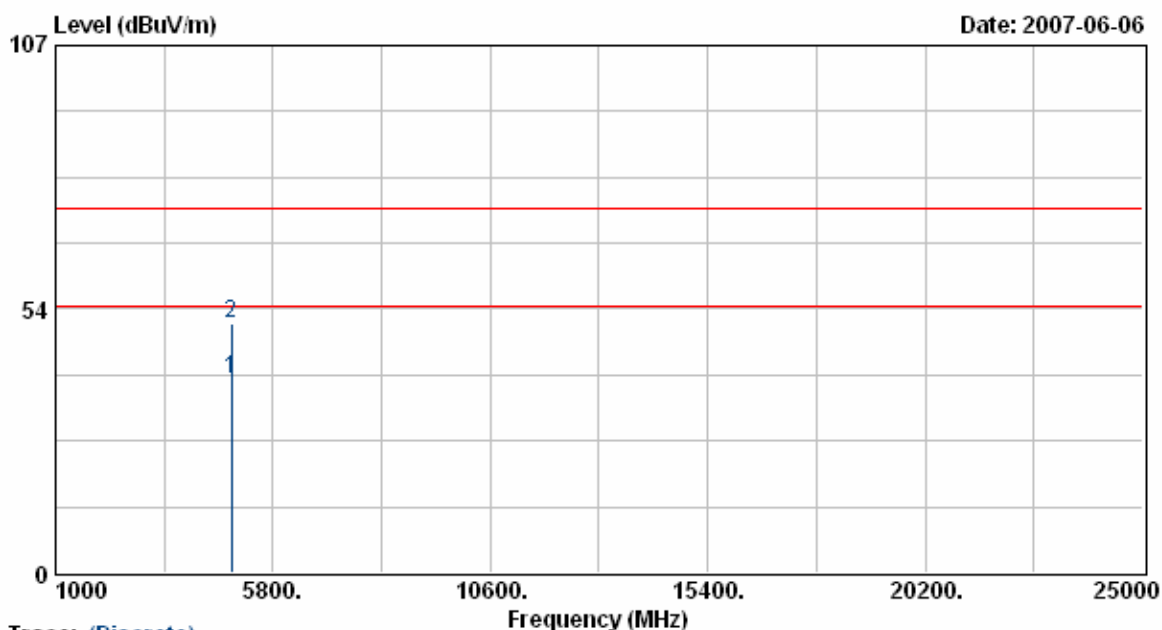

Trace: (Discrete)

Item	Freq	Read Value	Factor	Result	Limit	Margin	Remark	Ant Pos	Tab Pos
	MHz	dBuV/m	dB	dBuV/m	dBuV/m	dB		cm	Deg
1	4874.13	30.64	8.78	39.43	54.00	-14.57	Average	100	160
2	4874.13	41.64	8.78	50.42	74.00	-23.58	Peak	100	160

Notes:

1. Result = Read Value + Factor
2. Factor = Antenna Factor + Cable Loss - Amplifier
3. The resolution bandwidth of test receiver/spectrum analyzer is 120KHz and video bandwidth is 300kHz for Peak detection and Quasi-peak detection at frequency below 1GHz.
4. The resolution bandwidth of test receiver/spectrum analyzer is 1MHz and video bandwidth is 3MHz for Peak detection at frequency above 1GHz.
5. The resolution bandwidth of test receiver/spectrum analyzer is 1MHz and video bandwidth is 10Hz for Average detection at frequency above 1GHz.
6. The other emissions is too low to be measured.

Power	: AC120V	Pol/Phase	: HORIZONTAL
Test Mode 1	: Transmit / Receive	Temperature	: 25 °C
Operation Channel	: 6	Humidity	: 70 %
Modulation Type	: 802.11b	Atmospheric Pressure	: 1010 hPa
Memo	: DSA-12RN-12 AUS 120120	Rate	: 11 Mbps

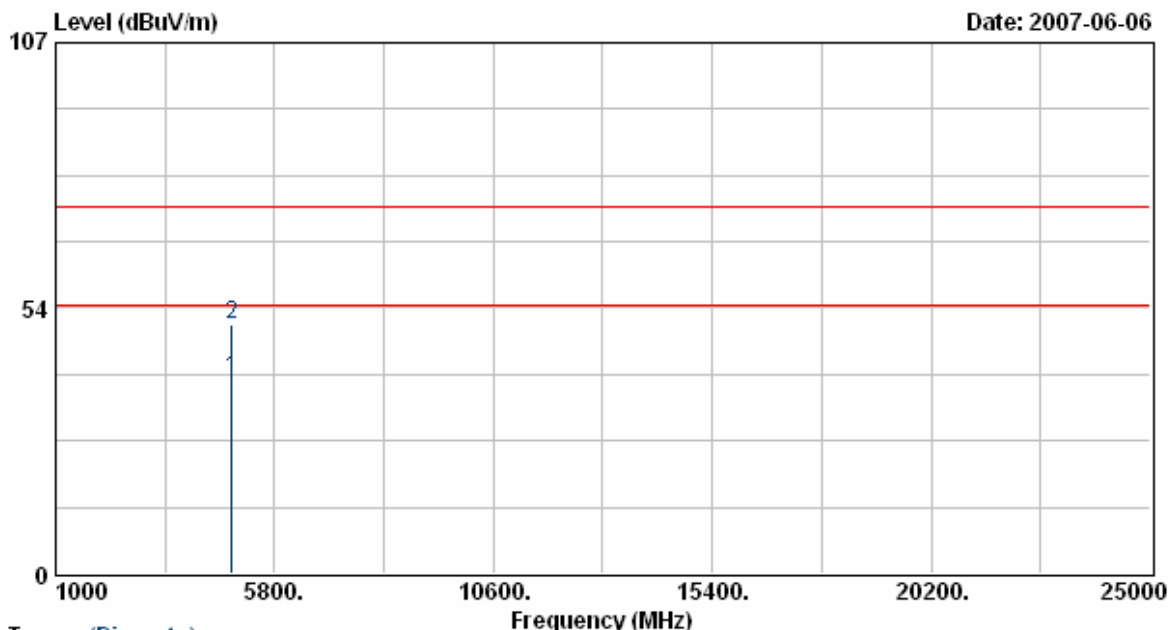

Trace: (Discrete)

Item	Freq	Read Value	Factor	Result	Limit	Margin	Remark	Ant Pos	Tab Pos
	MHz	dBuV/m	dB	dBuV/m	dBuV/m	dB		cm	Deg
1	4873.00	30.36	8.78	39.14	54.00	-14.86	Average	100	128
2	4873.00	41.56	8.78	50.34	74.00	-23.66	Peak	100	128

Notes:

1. Result = Read Value + Factor
2. Factor = Antenna Factor + Cable Loss - Amplifier
3. The resolution bandwidth of test receiver/spectrum analyzer is 120KHz and video bandwidth is 300kHz for Peak detection and Quasi-peak detection at frequency below 1GHz.
4. The resolution bandwidth of test receiver/spectrum analyzer is 1MHz and video bandwidth is 3MHz for Peak detection at frequency above 1GHz.
5. The resolution bandwidth of test receiver/spectrum analyzer is 1MHz and video bandwidth is 10Hz for Average detection at frequency above 1GHz.
6. The other emissions is too low to be measured.

Power	: AC120V	Pol/Phase	: VERTICAL
Test Mode 1	: Transmit / Receive	Temperature	: 25 °C
Operation Channel	: 11	Humidity	: 70 %
Modulation Type	: 802.11b	Atmospheric Pressure	: 1010 hPa
Memo	: DSA-12RN-12 AUS 120120	Rate	: 11 Mbps

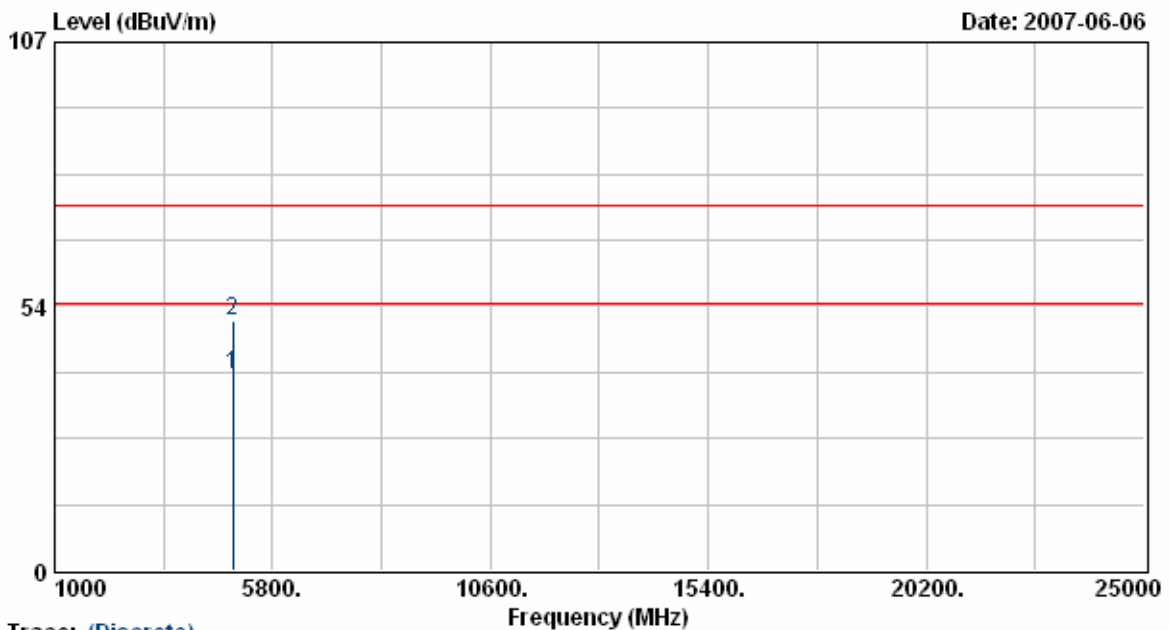

Trace: (Discrete)

Item	Freq	Read Value	Factor	Result	Limit	Margin	Remark	Ant Pos	Tab Pos
	MHz	dBuV/m	dB	dBuV/m	dBuV/m	dB		cm	Deg
1	4923.88	30.70	8.92	39.62	54.00	-14.38	Average	100	160
2	4923.88	41.66	8.92	50.58	74.00	-23.42	Peak	100	160

Notes:

1. Result = Read Value + Factor
2. Factor = Antenna Factor + Cable Loss - Amplifier
3. The resolution bandwidth of test receiver/spectrum analyzer is 120KHz and video bandwidth is 300kHz for Peak detection and Quasi-peak detection at frequency below 1GHz.
4. The resolution bandwidth of test receiver/spectrum analyzer is 1MHz and video bandwidth is 3MHz for Peak detection at frequency above 1GHz.
5. The resolution bandwidth of test receiver/spectrum analyzer is 1MHz and video bandwidth is 10Hz for Average detection at frequency above 1GHz.
6. The other emissions is too low to be measured.

Power	: AC120V	Pol/Phase	: HORIZONTAL
Test Mode 1	: Transmit / Receive	Temperature	: 25 °C
Operation Channel	: 11	Humidity	: 70 %
Modulation Type	: 802.11b	Atmospheric Pressure	: 1010 hPa
Memo	: DSA-12RN-12 AUS 120120	Rate	: 11 Mbps

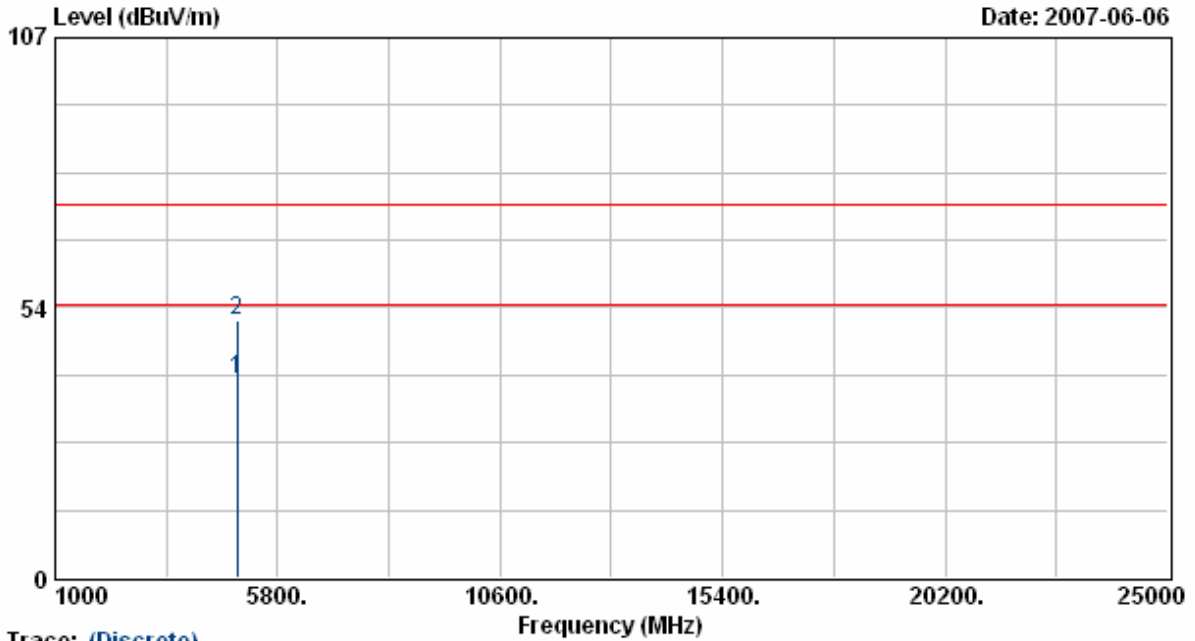

Trace: (Discrete)

Item	Freq	Read Value	Factor	Result	Limit	Margin	Remark	Ant Pos	Tab Pos
	MHz	dBuV/m	dB	dBuV/m	dBuV/m	dB		cm	Deg
1	4924.25	30.29	8.92	39.22	54.00	-14.78	Average	100	128
2	4924.25	41.91	8.92	50.83	74.00	-23.17	Peak	100	128

Notes:

1. Result = Read Value + Factor
2. Factor = Antenna Factor + Cable Loss - Amplifier
3. The resolution bandwidth of test receiver/spectrum analyzer is 120kHz and video bandwidth is 300kHz for Peak detection and Quasi-peak detection at frequency below 1GHz.
4. The resolution bandwidth of test receiver/spectrum analyzer is 1MHz and video bandwidth is 3MHz for Peak detection at frequency above 1GHz.
5. The resolution bandwidth of test receiver/spectrum analyzer is 1MHz and video bandwidth is 10Hz for Average detection at frequency above 1GHz.
6. The other emissions is too low to be measured.

Power	: AC120V	Pol/Phase	: VERTICAL
Test Mode 1	: Transmit / Receive	Temperature	: 25 °C
Operation Channel	: 1	Humidity	: 70 %
Modulation Type	: 802.11g	Atmospheric Pressure	: 1010 hPa
Memo	: DSA-12RN-12 AUS 120120	Rate	: 12 Mbps

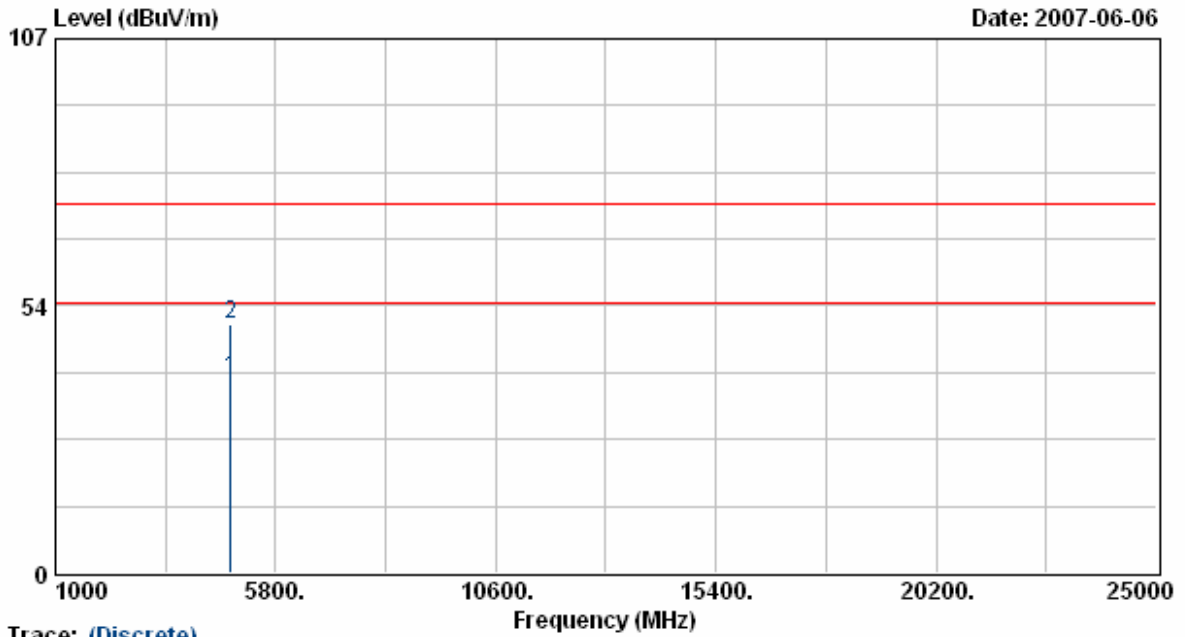

Trace: (Discrete)

Item	Freq	Read Value	Factor	Result	Limit	Margin	Remark	Ant Pos	Tab Pos
	MHz	dBuV/m	dB	dBuV/m	dBuV/m	dB		cm	Deg
1	4824.13	30.29	8.64	38.93	54.00	-15.07	Average	100	160
2	4824.13	41.28	8.64	49.92	74.00	-24.08	Peak	100	160

Notes:

1. Result = Read Value + Factor
2. Factor = Antenna Factor + Cable Loss - Amplifier
3. The resolution bandwidth of test receiver/spectrum analyzer is 120KHz and video bandwidth is 300kHz for Peak detection and Quasi-peak detection at frequency below 1GHz.
4. The resolution bandwidth of test receiver/spectrum analyzer is 1MHz and video bandwidth is 3MHz for Peak detection at frequency above 1GHz.
5. The resolution bandwidth of test receiver/spectrum analyzer is 1MHz and video bandwidth is 10Hz for Average detection at frequency above 1GHz.
6. The other emissions is too low to be measured.



Power	: AC120V	Pol/Phase	: HORIZONTAL
Test Mode 1	: Transmit / Receive	Temperature	: 25 °C
Operation Channel	: 1	Humidity	: 70 %
Modulation Type	: 802.11g	Atmospheric Pressure	: 1010 hPa
Memo	: DSA-12RN-12 AUS 120120	Rate	: 12 Mbps

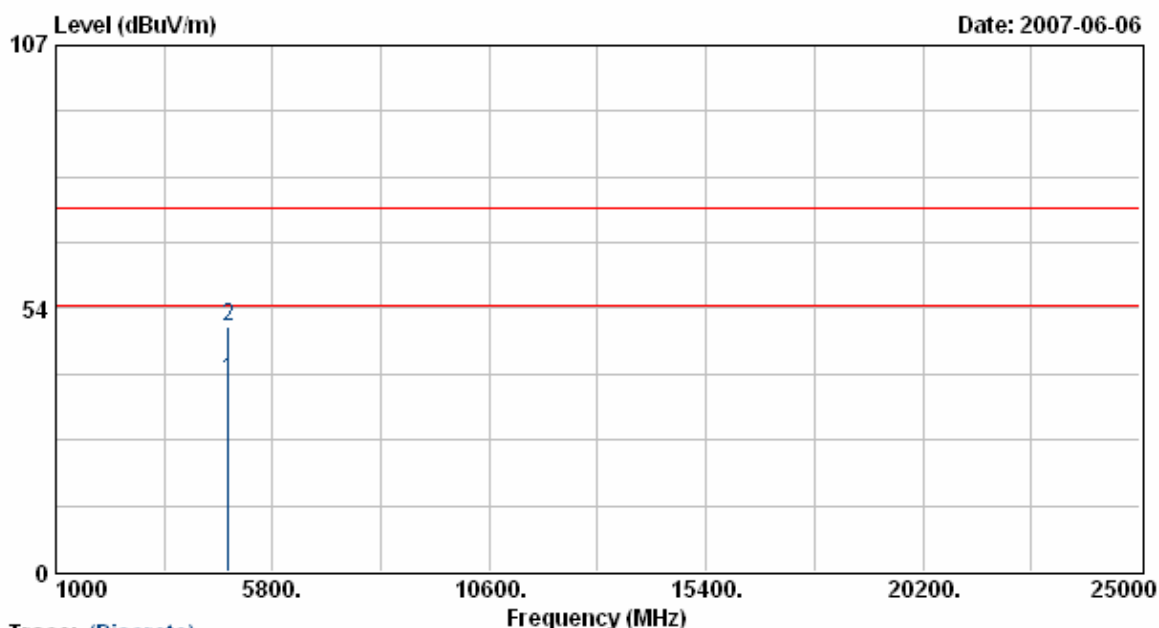

Trace: (Discrete)

Item	Freq	Read Value	Factor	Result	Limit	Margin	Remark	Ant Pos	Tab Pos
	MHz	dBuV/m	dB	dBuV/m	dBuV/m	dB		cm	Deg
1	4824.00	30.09	8.64	38.73	54.00	-15.27	Average	100	128
2	4824.00	41.18	8.64	49.82	74.00	-24.18	Peak	100	128

Notes:

1. Result = Read Value + Factor
2. Factor = Antenna Factor + Cable Loss - Amplifier
3. The resolution bandwidth of test receiver/spectrum analyzer is 120KHz and video bandwidth is 300kHz for Peak detection and Quasi-peak detection at frequency below 1GHz.
4. The resolution bandwidth of test receiver/spectrum analyzer is 1MHz and video bandwidth is 3MHz for Peak detection at frequency above 1GHz.
5. The resolution bandwidth of test receiver/spectrum analyzer is 1MHz and video bandwidth is 10Hz for Average detection at frequency above 1GHz.
6. The other emissions is too low to be measured.

Power	: AC120V	Pol/Phase	: VERTICAL
Test Mode 1	: Transmit / Receive	Temperature	: 25 °C
Operation Channel	: 6	Humidity	: 70 %
Modulation Type	: 802.11g	Atmospheric Pressure	: 1010 hPa
Memo	: DSA-12RN-12 AUS 120120	Rate	: 12 Mbps

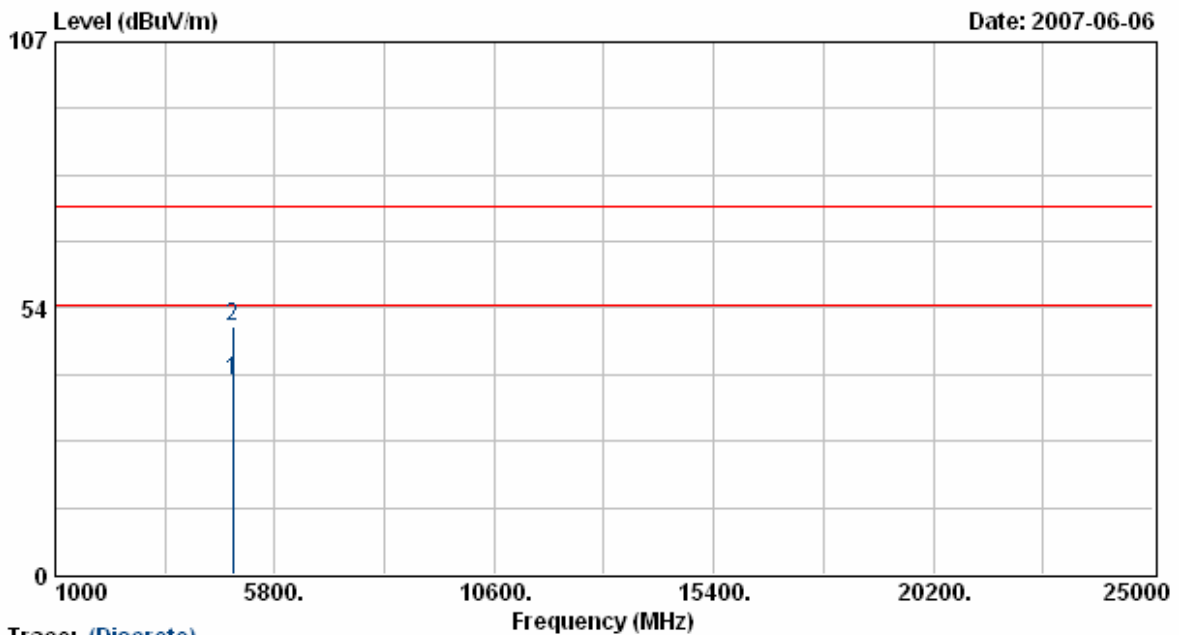

Trace: (Discrete)

Item	Freq	Read Value	Factor	Result	Limit	Margin	Remark	Ant Pos	Tab Pos
	MHz	dBuV/m	dB	dBuV/m	dBuV/m	dB		cm	Deg
1	4874.00	30.18	8.78	38.97	54.00	-15.03	Average	100	128
2	4874.00	41.15	8.78	49.93	74.00	-24.07	Peak	100	128

Notes:

1. Result = Read Value + Factor
2. Factor = Antenna Factor + Cable Loss - Amplifier
3. The resolution bandwidth of test receiver/spectrum analyzer is 120KHz and video bandwidth is 300kHz for Peak detection and Quasi-peak detection at frequency below 1GHz.
4. The resolution bandwidth of test receiver/spectrum analyzer is 1MHz and video bandwidth is 3MHz for Peak detection at frequency above 1GHz.
5. The resolution bandwidth of test receiver/spectrum analyzer is 1MHz and video bandwidth is 10Hz for Average detection at frequency above 1GHz.
6. The other emissions is too low to be measured.

Power	: AC120V	Pol/Phase	: HORIZONTAL
Test Mode 1	: Transmit / Receive	Temperature	: 25 °C
Operation Channel	: 6	Humidity	: 70 %
Modulation Type	: 802.11g	Atmospheric Pressure	: 1010 hPa
Memo	: DSA-12RN-12 AUS 120120	Rate	: 12 Mbps

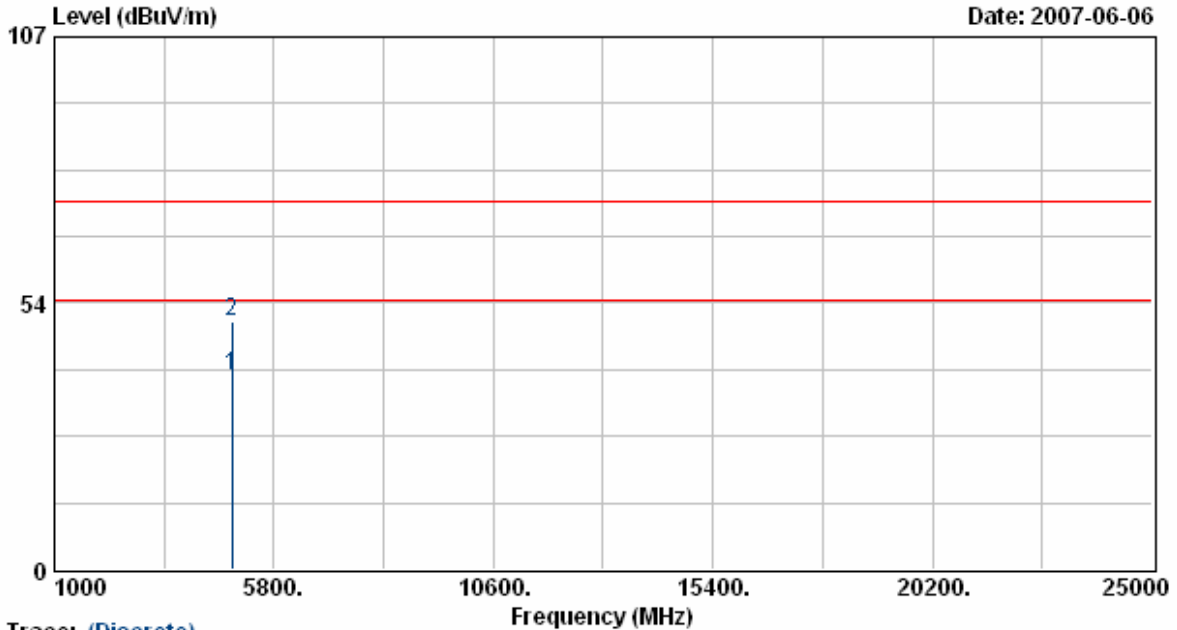

Trace: (Discrete)

Item	Freq	Read Value	Factor	Result	Limit	Margin	Remark	Ant Pos	Tab Pos
	MHz	dBuV/m	dB	dBuV/m	dBuV/m	dB		cm	Deg
1	4874.00	30.18	8.78	38.97	54.00	-15.03	Average	100	128
2	4874.00	41.15	8.78	49.93	74.00	-24.07	Peak	100	128

Notes:

1. Result = Read Value + Factor
2. Factor = Antenna Factor + Cable Loss - Amplifier
3. The resolution bandwidth of test receiver/spectrum analyzer is 120KHz and video bandwidth is 300kHz for Peak detection and Quasi-peak detection at frequency below 1GHz.
4. The resolution bandwidth of test receiver/spectrum analyzer is 1MHz and video bandwidth is 3MHz for Peak detection at frequency above 1GHz.
5. The resolution bandwidth of test receiver/spectrum analyzer is 1MHz and video bandwidth is 10Hz for Average detection at frequency above 1GHz.
6. The other emissions is too low to be measured.

Power	: AC120V	Pol/Phase	: VERTICAL
Test Mode 1	: Transmit / Receive	Temperature	: 25 °C
Operation Channel	: 11	Humidity	: 70 %
Modulation Type	: 802.11g	Atmospheric Pressure	: 1010 hPa
Memo	: DSA-12RN-12 AUS 120120	Rate	: 12 Mbps

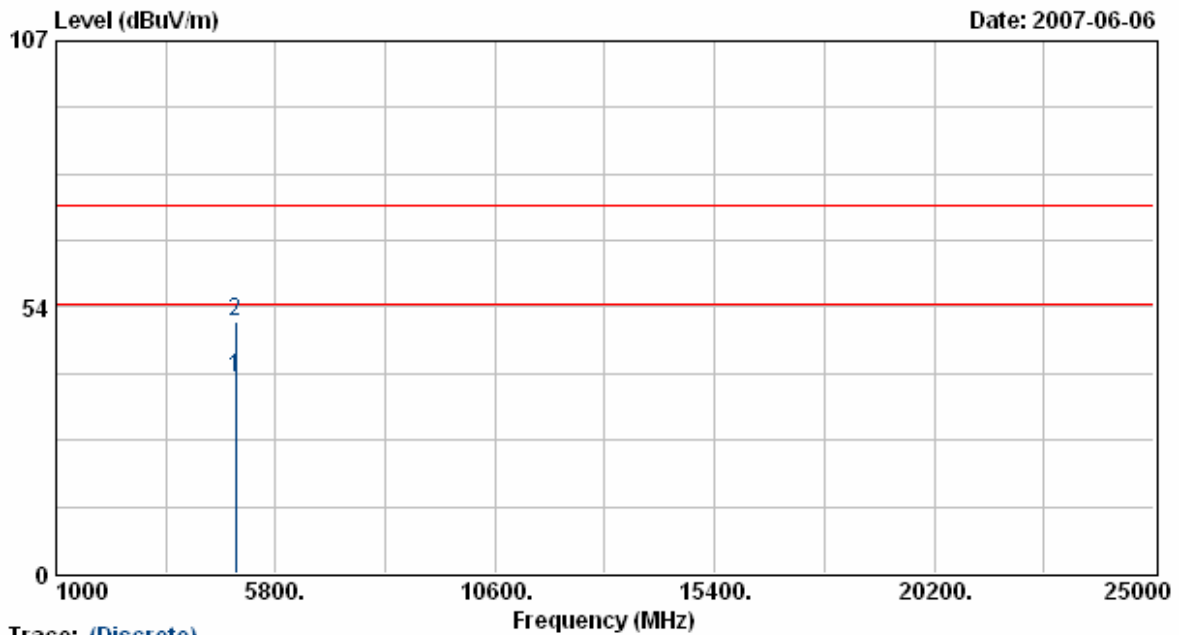

Trace: (Discrete)

Item	Freq	Read Value	Factor	Result	Limit	Margin	Remark	Ant Pos	Tab Pos
	MHz	dBuV/m	dB	dBuV/m	dBuV/m	dB		cm	Deg
1	4924.00	30.48	8.92	39.40	54.00	-14.60	Average	100	160
2	4924.00	41.78	8.92	50.70	74.00	-23.30	Peak	100	160

Notes:

1. Result = Read Value + Factor
2. Factor = Antenna Factor + Cable Loss - Amplifier
3. The resolution bandwidth of test receiver/spectrum analyzer is 120KHz and video bandwidth is 300kHz for Peak detection and Quasi-peak detection at frequency below 1GHz.
4. The resolution bandwidth of test receiver/spectrum analyzer is 1MHz and video bandwidth is 3MHz for Peak detection at frequency above 1GHz.
5. The resolution bandwidth of test receiver/spectrum analyzer is 1MHz and video bandwidth is 10Hz for Average detection at frequency above 1GHz.
6. The other emissions is too low to be measured.

Power	: AC120V	Pol/Phase	: HORIZONTAL
Test Mode 1	: Transmit / Receive	Temperature	: 25 °C
Operation Channel	: 11	Humidity	: 70 %
Modulation Type	: 802.11g	Atmospheric Pressure	: 1010 hPa
Memo	: DSA-12RN-12 AUS 120120	Rate	: 12 Mbps

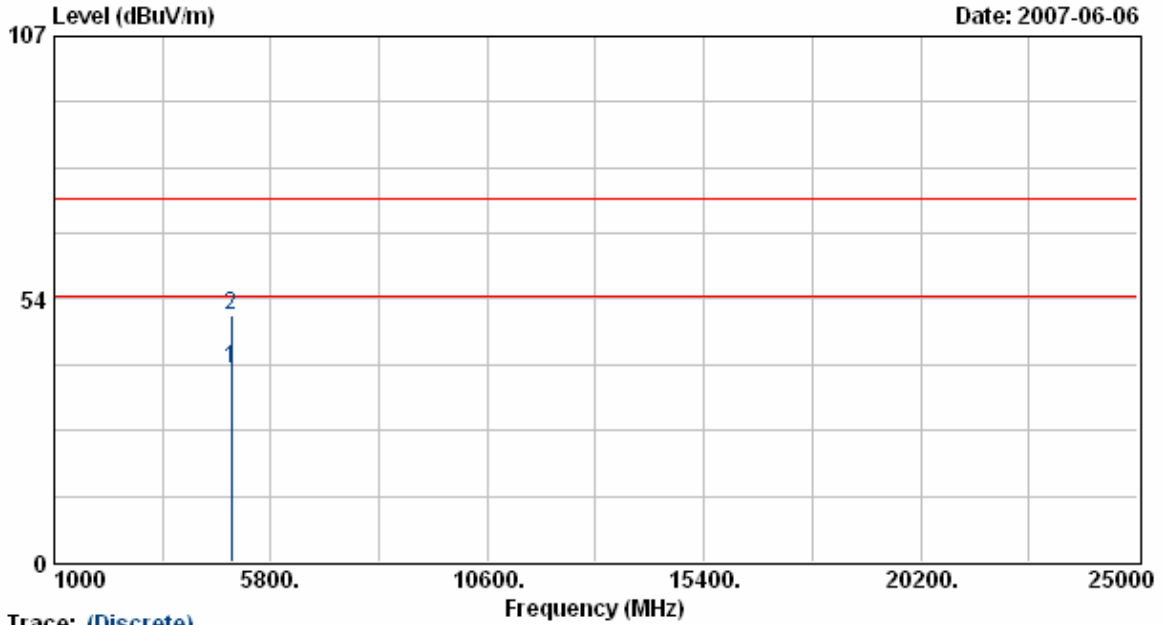

Trace: (Discrete)

Item	Freq	Read Value	Factor	Result	Limit	Margin	Remark	Ant Pos	Tab Pos
	MHz	dBuV/m	dB	dBuV/m	dBuV/m	dB		cm	Deg
1	4923.50	30.26	8.92	39.19	54.00	-14.81	Average	100	128
2	4923.50	41.24	8.92	50.16	74.00	-23.84	Peak	100	128

Notes:

1. Result = Read Value + Factor
2. Factor = Antenna Factor + Cable Loss - Amplifier
3. The resolution bandwidth of test receiver/spectrum analyzer is 120KHz and video bandwidth is 300kHz for Peak detection and Quasi-peak detection at frequency below 1GHz.
4. The resolution bandwidth of test receiver/spectrum analyzer is 1MHz and video bandwidth is 3MHz for Peak detection at frequency above 1GHz.
5. The resolution bandwidth of test receiver/spectrum analyzer is 1MHz and video bandwidth is 10Hz for Average detection at frequency above 1GHz.
6. The other emissions is too low to be measured.

Power	: AC120V	Pol/Phase	: VERTICAL
Test Mode 2	: Transmit / Receive	Temperature	: 25 °C
Operation Channel	: 1	Humidity	: 70 %
Modulation Type	: 802.11g	Atmospheric Pressure	: 1010 hPa
Memo	: DSA-12RN-12 AUS 120120	Rate	: 12 Mbps

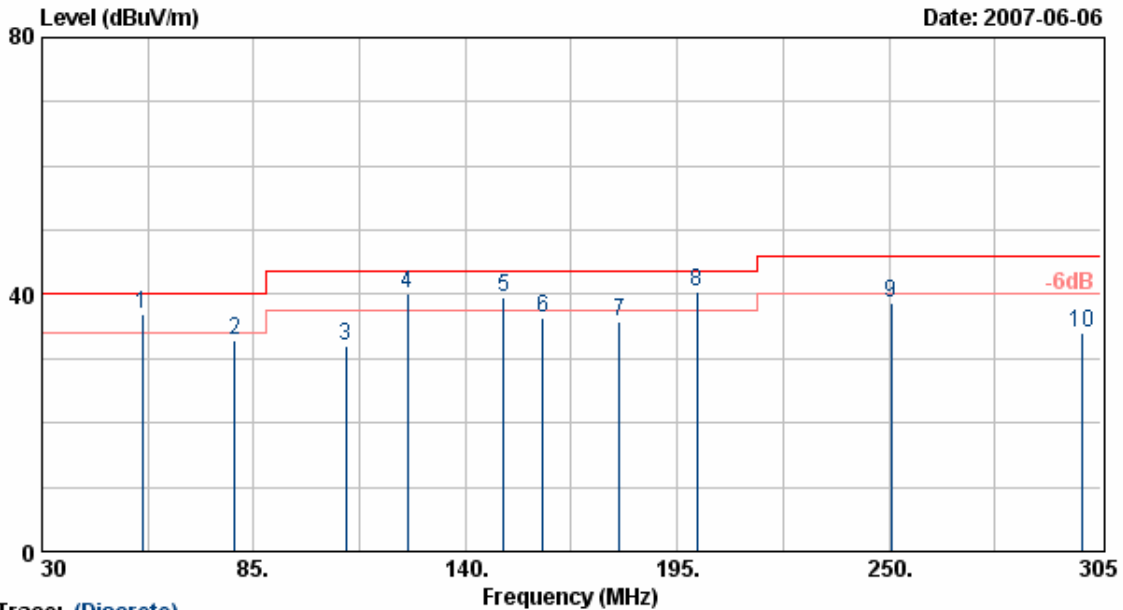

Trace: (Discrete)

Item	Freq	Read Value	Factor	Result	Limit	Margin	Remark	Ant Pos	Tab Pos
	MHz	dBuV/m	dB	dBuV/m	dBuV/m	dB		cm	Deg
1	56.00	53.96	-17.03	36.93	40.00	-3.07	QP	100	75
2	80.00	47.99	-15.08	32.91	40.00	-7.09	Peak	100	21
3	108.90	48.52	-16.57	31.95	43.50	-11.55	Peak	100	21
4	125.00	52.84	-12.59	40.25	43.50	-3.25	QP	100	88
5	150.00	51.75	-12.12	39.63	43.50	-3.87	QP	100	90
6	160.00	51.25	-14.93	36.32	43.50	-7.18	Peak	100	115
7	180.00	47.46	-11.81	35.65	43.50	-7.85	Peak	100	115
8	200.00	53.63	-13.25	40.38	43.50	-3.12	QP	100	276
9	250.55	50.42	-11.80	38.62	46.00	-7.38	Peak	100	55
10	300.00	46.00	-12.10	33.90	46.00	-12.10	Peak	100	55

Notes:

1. Result = Read Value + Factor
2. Factor = Antenna Factor + Cable Loss - Amplifier
3. The resolution bandwidth of test receiver/spectrum analyzer is 120KHz and video bandwidth is 300kHz for Peak detection and Quasi-peak detection at frequency below 1GHz.
4. All emission below 1GHz at 802.11b/g mode are all the same,so the 802.11g mode chosen as representative in final test.
5. According to technical experiences,all spurious emission of 802.11g mode at channel 1,6,11 are almost the same below 1GHz,so that the channel 1 was chosen as representative in final test.
6. The data is worse case.

Power	: AC120V	Pol/Phase	: VERTICAL
Test Mode 2	: Transmit / Receive	Temperature	: 25 °C
Operation Channel	: 1	Humidity	: 70 %
Modulation Type	: 802.11g	Atmospheric Pressure	: 1010 hPa
Memo	: DSA-12RN-12 AUS 120120	Rate	: 12 Mbps

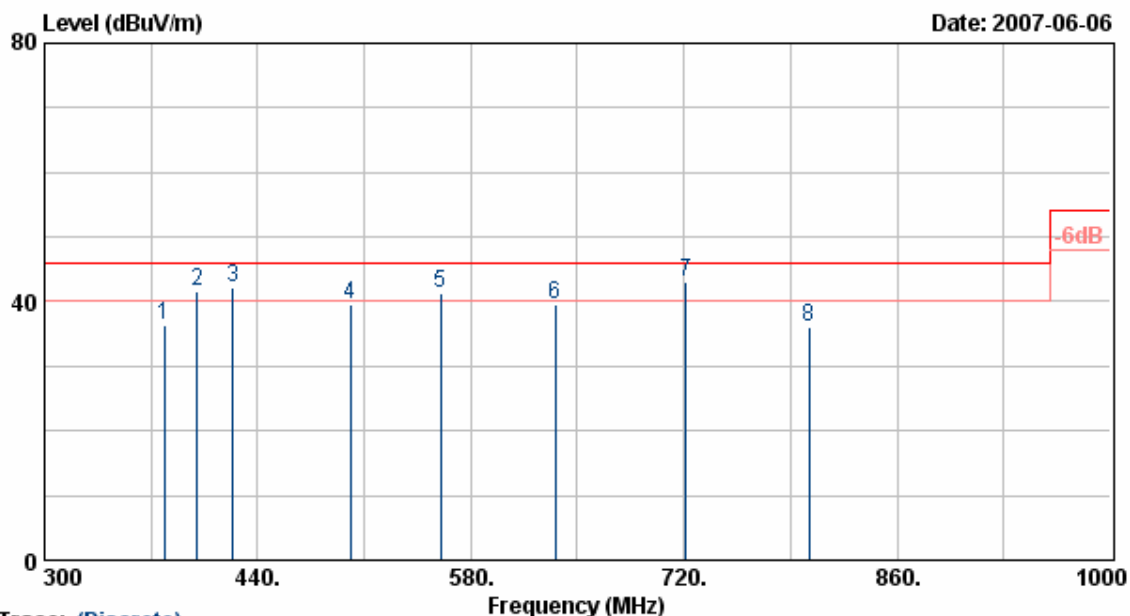

Trace: (Discrete)

Item	Freq	Read Value	Factor	Result	Limit	Margin	Remark	Ant Pos	Tab Pos
	MHz	dBuV/m	dB	dBuV/m	dBuV/m	dB		cm	Deg
1	378.40	46.44	-10.03	36.41	46.00	-9.59	Peak	100	48
2	400.00	50.96	-9.40	41.56	46.00	-4.44	QP	100	110
3	424.00	51.48	-9.39	42.09	46.00	-3.91	QP	100	110
4	500.90	44.52	-4.82	39.70	46.00	-6.30	Peak	100	66
5	560.00	45.93	-4.75	41.18	46.00	-4.82	QP	100	125
6	635.30	42.72	-3.19	39.53	46.00	-6.47	Peak	100	40
7	721.40	47.23	-4.28	42.95	46.00	-3.05	QP	100	225
8	801.90	37.45	-1.31	36.14	46.00	-9.86	Peak	100	225

Notes:

1. Result = Read Value + Factor
2. Factor = Antenna Factor + Cable Loss - Amplifier
3. The resolution bandwidth of test receiver/spectrum analyzer is 120KHz and video bandwidth is 300kHz for Peak detection and Quasi-peak detection at frequency below 1GHz.
4. All emission below 1GHz at 802.11b/g mode are all the same, so the 802.11g mode chosen as representative in final test.
5. According to technical experiences, all spurious emission of 802.11g mode at channel 1, 6, 11 are almost the same below 1GHz, so that the channel 1 was chosen as representative in final test.
6. The data is worse case.

Power	: AC120V	Pol/Phase	: HORIZONTAL
Test Mode 2	: Transmit / Receive	Temperature	: 25 °C
Operation Channel	: 1	Humidity	: 70 %
Modulation Type	: 802.11g	Atmospheric Pressure	: 1010 hPa
Memo	: DSA-12RN-12 AUS 120120	Rate	: 12 Mbps

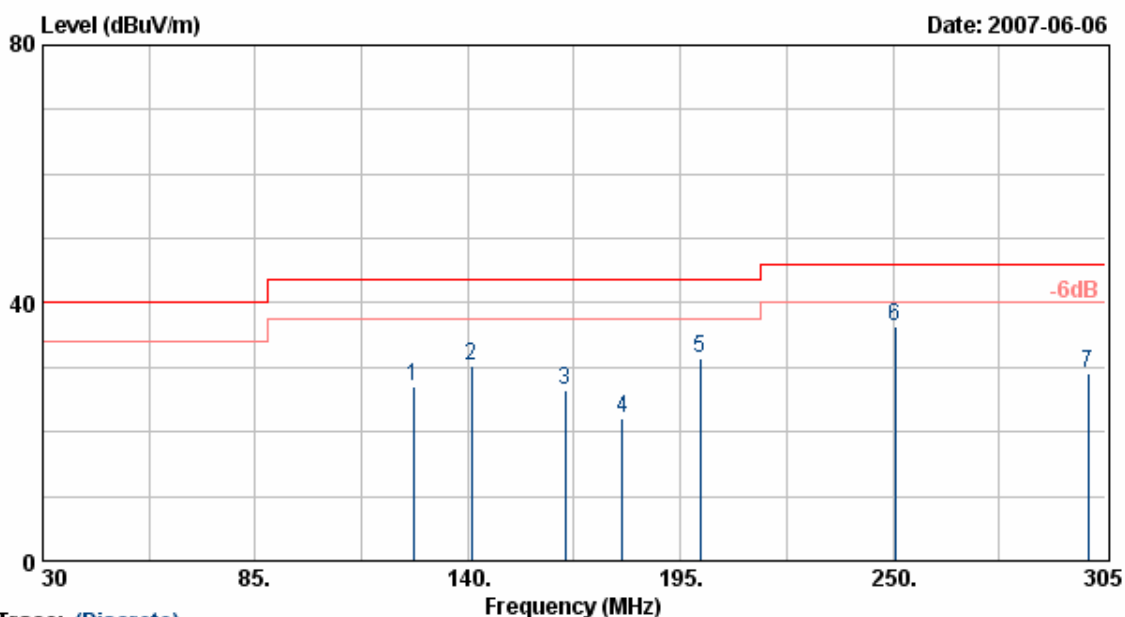

Trace: (Discrete)

Item	Freq	Read Value	Factor	Result	Limit	Margin	Remark	Ant Pos	Tab Pos
	MHz	dBuV/m	dB	dBuV/m	dBuV/m	dB		cm	Deg
1	125.98	48.12	-21.18	26.94	43.50	-16.56	Peak	200	51
2	141.00	47.17	-16.80	30.37	43.50	-13.13	Peak	200	85
3	165.30	47.29	-20.87	26.42	43.50	-17.08	Peak	200	85
4	180.00	44.23	-22.20	22.03	43.50	-21.47	Peak	200	112
5	200.00	50.89	-19.49	31.40	43.50	-12.10	Peak	200	182
6	250.50	52.83	-16.45	36.38	46.00	-9.62	Peak	200	335
7	300.60	44.37	-15.15	29.22	46.00	-16.78	Peak	200	335

Notes:

1. Result = Read Value + Factor
2. Factor = Antenna Factor + Cable Loss - Amplifier
3. The resolution bandwidth of test receiver/spectrum analyzer is 120KHz and video bandwidth is 300kHz for Peak detection and Quasi-peak detection at frequency below 1GHz.
4. All emission below 1GHz at 802.11g mode are all the same, so the 802.11g mode chosen as representative in final test.
5. According to technical experiences, all spurious emission of 802.11g mode at channel 1, 6, 11 are almost the same below 1GHz, so that the channel 1 was chosen as representative in final test.
6. The data is worse case.



Power	: AC120V	Pol/Phase	: HORIZONTAL
Test Mode 2	: Transmit / Receive	Temperature	: 25 °C
Operation Channel	: 1	Humidity	: 70 %
Modulation Type	: 802.11g	Atmospheric Pressure	: 1010 hPa
Memo	: DSA-12RN-12 AUS 120120	Rate	: 12 Mbps

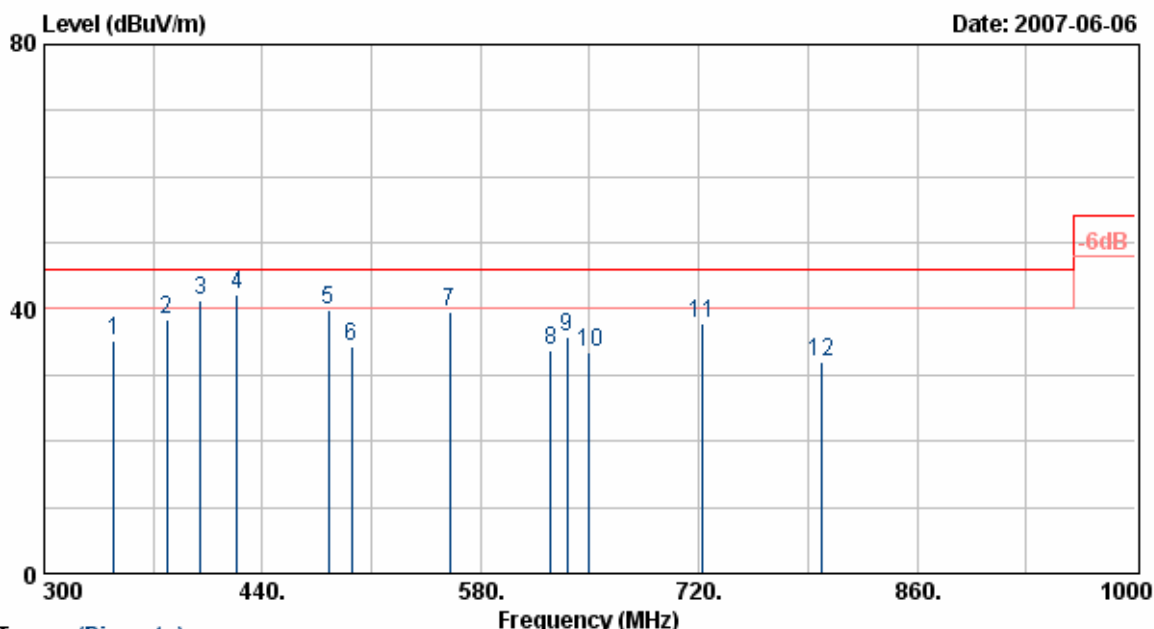

Trace: (Discrete)

Item	Freq	Read Value	Factor	Result	Limit	Margin	Remark	Ant Pos	Tab Pos
	MHz	dBuV/m	dB	dBuV/m	dBuV/m	dB		cm	Deg
1	344.80	47.62	-12.47	35.15	46.00	-10.85	Peak	200	0
2	378.40	48.28	-9.96	38.32	46.00	-7.68	Peak	200	52
3	400.00	50.14	-8.91	41.23	46.00	-4.77	QP	200	88
4	424.00	50.16	-7.95	42.21	46.00	-3.79	QP	200	177
5	482.70	48.74	-8.99	39.75	46.00	-6.25	Peak	200	223
6	497.40	41.59	-7.13	34.46	46.00	-11.54	Peak	200	225
7	560.00	43.80	-4.18	39.62	46.00	-6.38	Peak	200	33
8	625.00	38.48	-4.78	33.70	46.00	-12.30	Peak	200	33
9	635.30	40.17	-4.48	35.69	46.00	-10.31	Peak	200	69
10	650.00	37.51	-4.08	33.43	46.00	-12.57	Peak	200	89
11	722.80	44.83	-7.04	37.79	46.00	-8.21	Peak	200	0
12	799.10	35.71	-3.83	31.88	46.00	-14.12	Peak	200	50

Notes:

1. Result = Read Value + Factor
2. Factor = Antenna Factor + Cable Loss - Amplifier
3. The resolution bandwidth of test receiver/spectrum analyzer is 120KHz and video bandwidth is 300kHz for Peak detection and Quasi-peak detection at frequency below 1GHz.
4. All emission below 1GHz at 802.11b/g mode are all the same,so the 802.11g mode chosen as representative in final test.
5. According to technical experiences,all spurious emission of 802.11g mode at channel 1,6,11 are almost the same below 1GHz,so that the channel 1 was chosen as representative in final test.
6. The data is worse case.

Power	: AC120V	Pol/Phase	: VERTICAL
Test Mode 2	: Transmit / Receive	Temperature	: 25 °C
Operation Channel	: 1	Humidity	: 70 %
Modulation Type	: 802.11b	Atmospheric Pressure	: 1010 hPa
Memo	: DSA-12RN-12 AUS 120120	Rate	: 11 Mbps

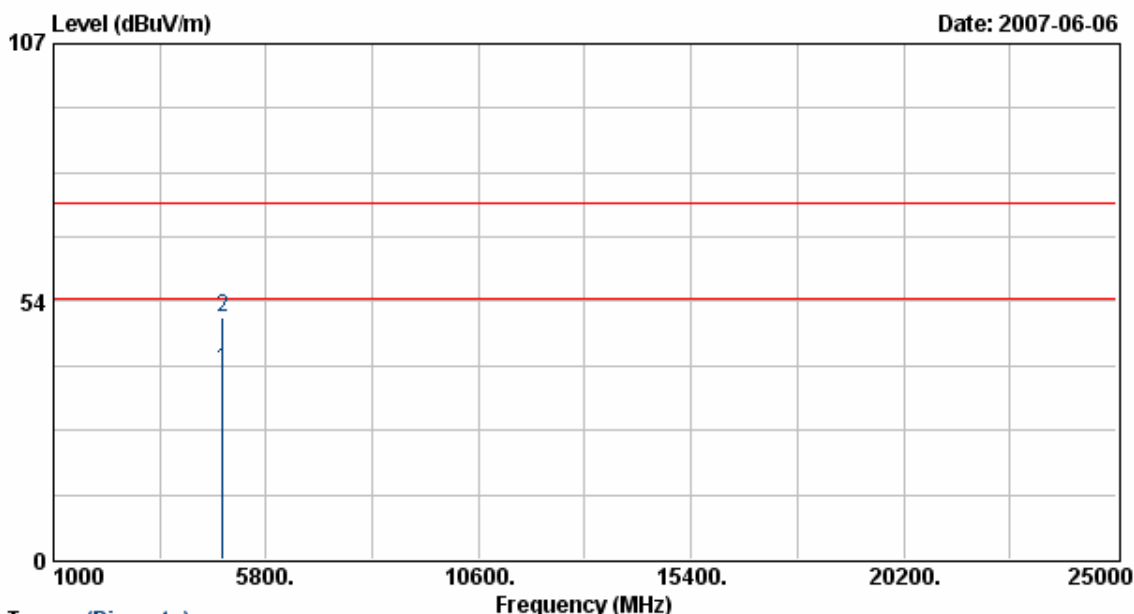

Trace: (Discrete)

Item	Freq	Read Value	Factor	Result	Limit	Margin	Remark	Ant Pos	Tab Pos
	MHz	dBuV/m	dB	dBuV/m	dBuV/m	dB		cm	Deg
1	4824.00	30.84	8.64	39.48	54.00	-14.52	Average	100	160
2	4824.00	41.72	8.64	50.36	74.00	-23.64	Peak	100	160

Notes:

1. Result = Read Value + Factor
2. Factor = Antenna Factor + Cable Loss - Amplifier
3. The resolution bandwidth of test receiver/spectrum analyzer is 120KHz and video bandwidth is 300kHz for Peak detection and Quasi-peak detection at frequency below 1GHz.
4. The resolution bandwidth of test receiver/spectrum analyzer is 1MHz and video bandwidth is 3MHz for Peak detection at frequency above 1GHz.
5. The resolution bandwidth of test receiver/spectrum analyzer is 1MHz and video bandwidth is 10Hz for Average detection at frequency above 1GHz.
6. The other emissions is too low to be measured.

Power	: AC120V	Pol/Phase	: HORIZONTAL
Test Mode 2	: Transmit / Receive	Temperature	: 25 °C
Operation Channel	: 1	Humidity	: 70 %
Modulation Type	: 802.11b	Atmospheric Pressure	: 1010 hPa
Memo	: DSA-12RN-12 AUS 120120	Rate	: 11 Mbps

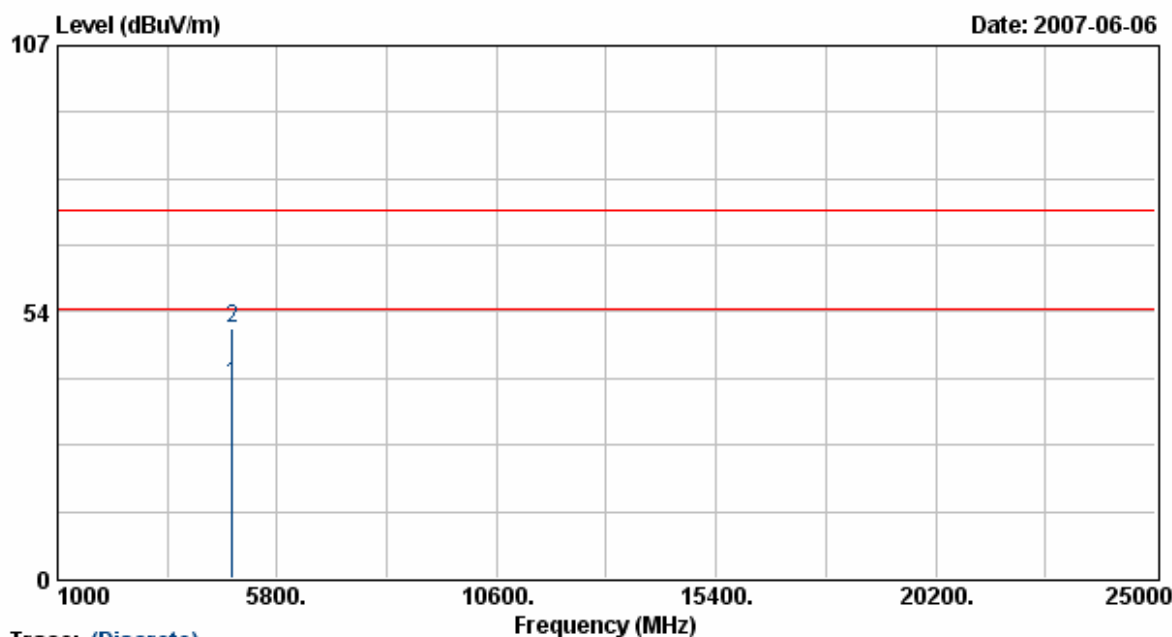

Trace: (Discrete)

Item	Freq	Read Value	Factor	Result	Limit	Margin	Remark	Ant Pos	Tab Pos
	MHz	dBuV/m	dB	dBuV/m	dBuV/m	dB		cm	Deg
1	4824.50	30.35	8.64	38.99	54.00	-15.01	Average	100	128
2	4824.50	41.41	8.64	50.05	74.00	-23.95	Peak	100	128

Notes:

1. Result = Read Value + Factor
2. Factor = Antenna Factor + Cable Loss - Amplifier
3. The resolution bandwidth of test receiver/spectrum analyzer is 120KHz and video bandwidth is 300kHz for Peak detection and Quasi-peak detection at frequency below 1GHz.
4. The resolution bandwidth of test receiver/spectrum analyzer is 1MHz and video bandwidth is 3MHz for Peak detection at frequency above 1GHz.
5. The resolution bandwidth of test receiver/spectrum analyzer is 1MHz and video bandwidth is 10Hz for Average detection at frequency above 1GHz.
6. The other emissions is too low to be measured.

Power	: AC120V	Pol/Phase	: VERTICAL
Test Mode 2	: Transmit / Receive	Temperature	: 25 °C
Operation Channel	: 6	Humidity	: 70 %
Modulation Type	: 802.11b	Atmospheric Pressure	: 1010 hPa
Memo	: DSA-12RN-12 AUS 120120	Rate	: 11 Mbps

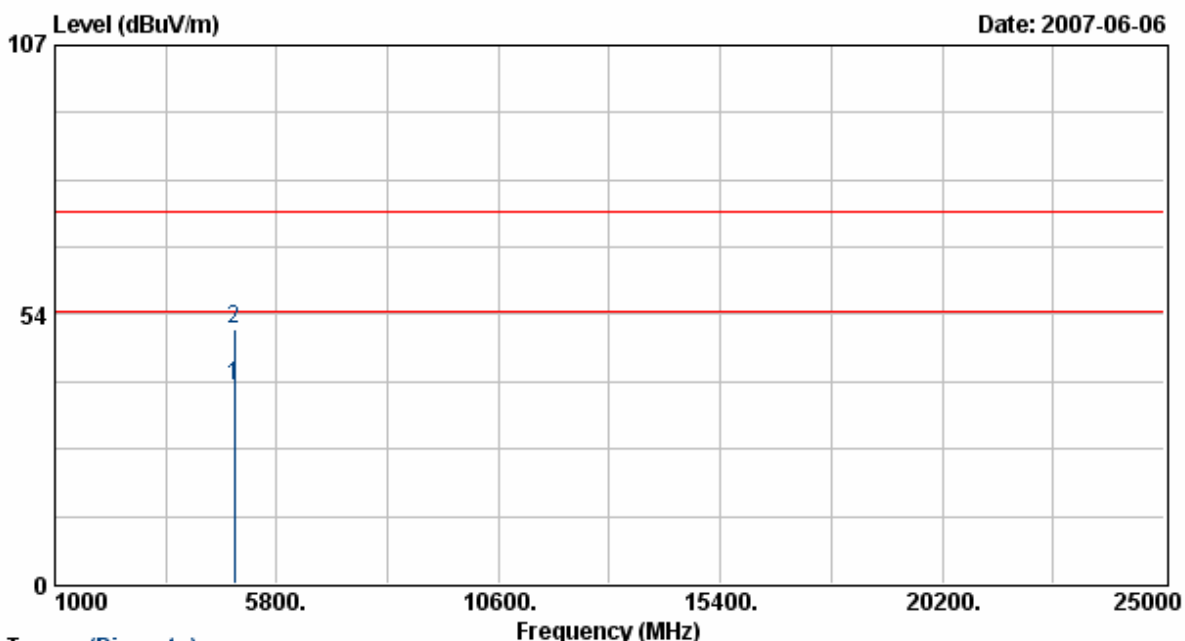

Trace: (Discrete)

Item	Freq	Read Value	Factor	Result	Limit	Margin	Remark	Ant Pos	Tab Pos
	MHz	dBuV/m	dB	dBuV/m	dBuV/m	dB		cm	Deg
1	4874.13	30.69	8.78	39.47	54.00	-14.53	Average	100	160
2	4874.13	41.73	8.78	50.51	74.00	-23.49	Peak	100	160

Notes:

1. Result = Read Value + Factor
2. Factor = Antenna Factor + Cable Loss - Amplifier
3. The resolution bandwidth of test receiver/spectrum analyzer is 120KHz and video bandwidth is 300kHz for Peak detection and Quasi-peak detection at frequency below 1GHz.
4. The resolution bandwidth of test receiver/spectrum analyzer is 1MHz and video bandwidth is 3MHz for Peak detection at frequency above 1GHz.
5. The resolution bandwidth of test receiver/spectrum analyzer is 1MHz and video bandwidth is 10Hz for Average detection at frequency above 1GHz.
6. The other emissions is too low to be measured.

Power	: AC120V	Pol/Phase	: HORIZONTAL
Test Mode 2	: Transmit / Receive	Temperature	: 25 °C
Operation Channel	: 6	Humidity	: 70 %
Modulation Type	: 802.11b	Atmospheric Pressure	: 1010 hPa
Memo	: DSA-12RN-12 AUS 120120	Rate	: 11 Mbps

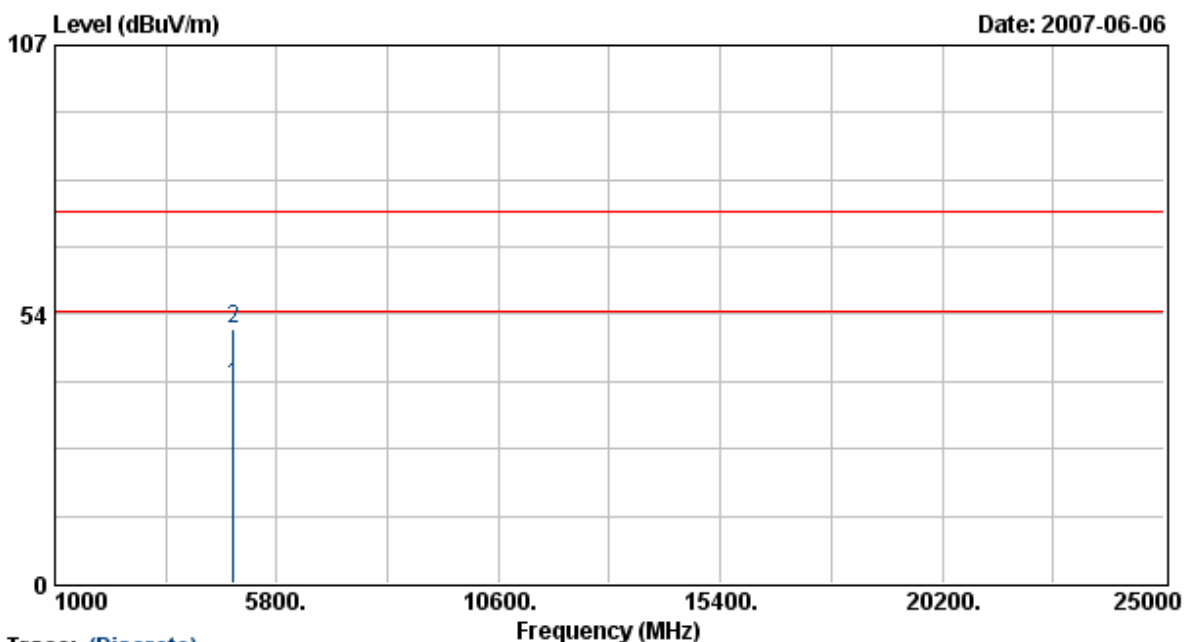

Trace: (Discrete)

Item	Freq	Read Value	Factor	Result	Limit	Margin	Remark	Ant Pos	Tab Pos
	MHz	dBuV/m	dB	dBuV/m	dBuV/m	dB		cm	Deg
1	4873.00	30.56	8.78	39.34	54.00	-14.66	Average	100	128
2	4873.00	41.70	8.78	50.48	74.00	-23.52	Peak	100	128

Notes:

1. Result = Read Value + Factor
2. Factor = Antenna Factor + Cable Loss - Amplifier
3. The resolution bandwidth of test receiver/spectrum analyzer is 120KHz and video bandwidth is 300kHz for Peak detection and Quasi-peak detection at frequency below 1GHz.
4. The resolution bandwidth of test receiver/spectrum analyzer is 1MHz and video bandwidth is 3MHz for Peak detection at frequency above 1GHz.
5. The resolution bandwidth of test receiver/spectrum analyzer is 1MHz and video bandwidth is 10Hz for Average detection at frequency above 1GHz.
6. The other emissions is too low to be measured.

Power	: AC120V	Pol/Phase	: VERTICAL
Test Mode 2	: Transmit / Receive	Temperature	: 25 °C
Operation Channel	: 11	Humidity	: 70 %
Modulation Type	: 802.11b	Atmospheric Pressure	: 1010 hPa
Memo	: DSA-12RN-12 AUS 120120	Rate	: 11 Mbps

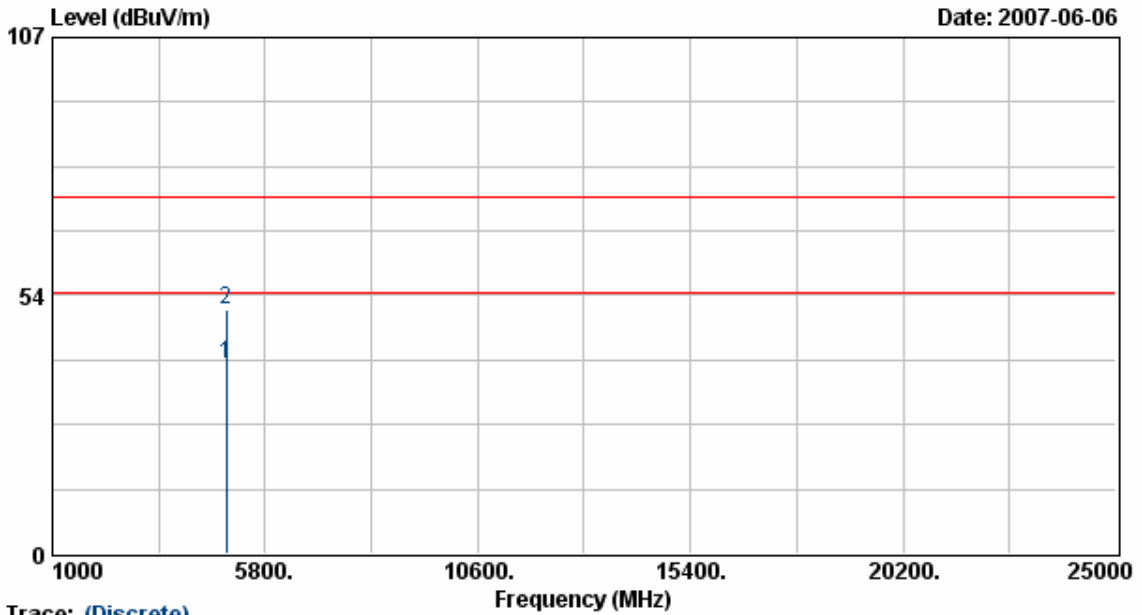

Trace: (Discrete)

Item	Freq	Read Value	Factor	Result	Limit	Margin	Remark	Ant Pos	Tab Pos
	MHz	dBuV/m	dB	dBuV/m	dBuV/m	dB		cm	Deg
1	4923.88	30.53	8.92	39.45	54.00	-14.55	Average	100	160
2	4923.88	41.55	8.92	50.47	74.00	-23.53	Peak	100	160

Notes:

1. Result = Read Value + Factor
2. Factor = Antenna Factor + Cable Loss - Amplifier
3. The resolution bandwidth of test receiver/spectrum analyzer is 120KHz and video bandwidth is 300kHz for Peak detection and Quasi-peak detection at frequency below 1GHz.
4. The resolution bandwidth of test receiver/spectrum analyzer is 1MHz and video bandwidth is 3MHz for Peak detection at frequency above 1GHz.
5. The resolution bandwidth of test receiver/spectrum analyzer is 1MHz and video bandwidth is 10Hz for Average detection at frequency above 1GHz.
6. The other emissions is too low to be measured.

Power	: AC120V	Pol/Phase	: HORIZONTAL
Test Mode 2	: Transmit / Receive	Temperature	: 25 °C
Operation Channel	: 11	Humidity	: 70 %
Modulation Type	: 802.11b	Atmospheric Pressure	: 1010 hPa
Memo	: DSA-12RN-12 AUS 120120	Rate	: 11 Mbps

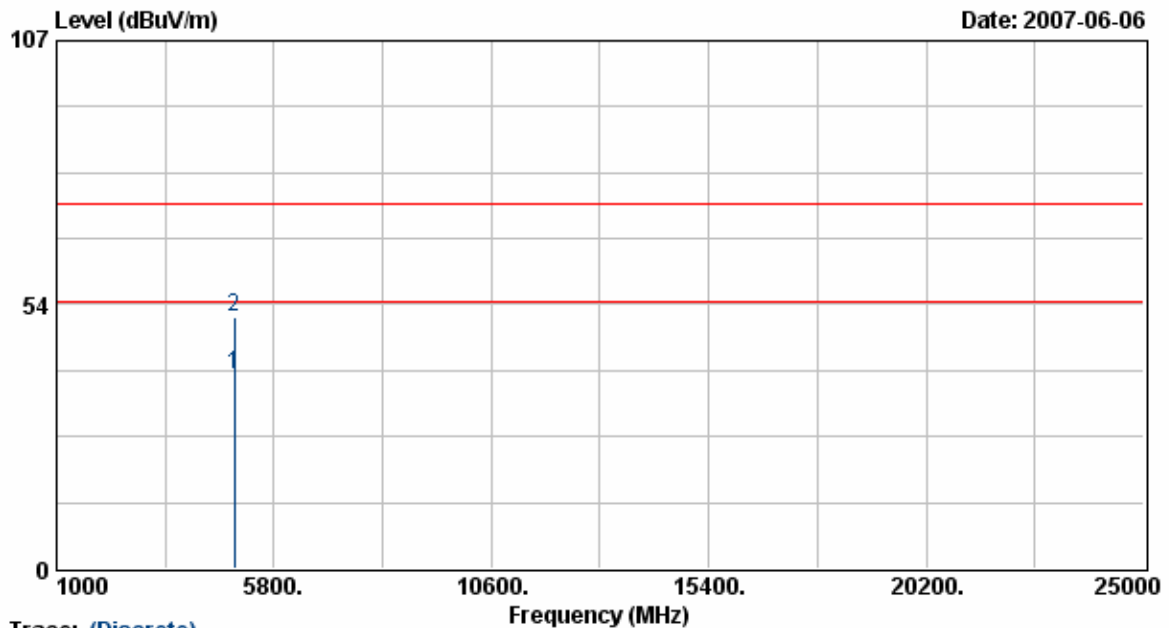

Trace: (Discrete)

Item	Freq	Read Value	Factor	Result	Limit	Margin	Remark	Ant Pos	Tab Pos
	MHz	dBuV/m	dB	dBuV/m	dBuV/m	dB		cm	Deg
1	4924.25	30.21	8.92	39.13	54.00	-14.87	Average	100	128
2	4924.25	41.97	8.92	50.89	74.00	-23.11	Peak	100	128

Notes:

1. Result = Read Value + Factor
2. Factor = Antenna Factor + Cable Loss - Amplifier
3. The resolution bandwidth of test receiver/spectrum analyzer is 120KHz and video bandwidth is 300kHz for Peak detection and Quasi-peak detection at frequency below 1GHz.
4. The resolution bandwidth of test receiver/spectrum analyzer is 1MHz and video bandwidth is 3MHz for Peak detection at frequency above 1GHz.
5. The resolution bandwidth of test receiver/spectrum analyzer is 1MHz and video bandwidth is 10Hz for Average detection at frequency above 1GHz.
6. The other emissions is too low to be measured.

Power	: AC120V	Pol/Phase	: VERTICAL
Test Mode 2	: Transmit / Receive	Temperature	: 25 °C
Operation Channel	: 1	Humidity	: 70 %
Modulation Type	: 802.11g	Atmospheric Pressure	: 1010 hPa
Memo	: DSA-12RN-12 AUS 120120	Rate	: 12 Mbps

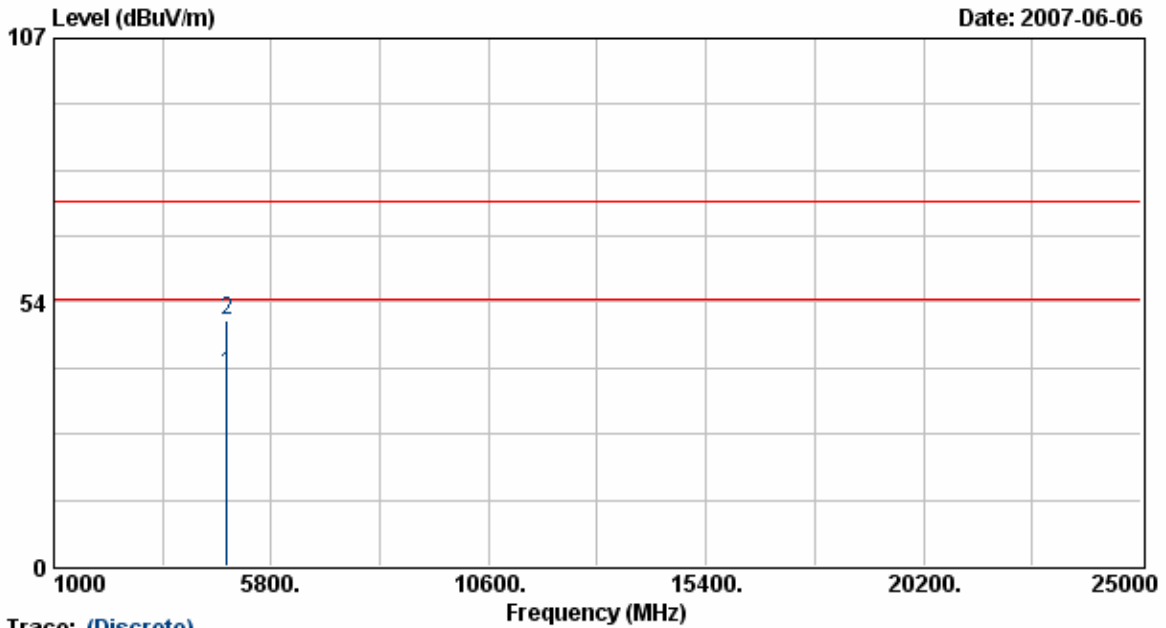

Trace: (Discrete)

Item	Freq	Read Value	Factor	Result	Limit	Margin	Remark	Ant Pos	Tab Pos
	MHz	dBuV/m	dB	dBuV/m	dBuV/m	dB		cm	Deg
1	4824.13	30.28	8.64	38.92	54.00	-15.08	Average	100	160
2	4824.13	41.28	8.64	49.92	74.00	-24.08	Peak	100	160

Notes:

1. Result = Read Value + Factor
2. Factor = Antenna Factor + Cable Loss - Amplifier
3. The resolution bandwidth of test receiver/spectrum analyzer is 120KHz and video bandwidth is 300kHz for Peak detection and Quasi-peak detection at frequency below 1GHz.
4. The resolution bandwidth of test receiver/spectrum analyzer is 1MHz and video bandwidth is 3MHz for Peak detection at frequency above 1GHz.
5. The resolution bandwidth of test receiver/spectrum analyzer is 1MHz and video bandwidth is 10Hz for Average detection at frequency above 1GHz.
6. The other emissions is too low to be measured.



Power	: AC120V	Pol/Phase	: HORIZONTAL
Test Mode 2	: Transmit / Receive	Temperature	: 25 °C
Operation Channel	: 1	Humidity	: 70 %
Modulation Type	: 802.11g	Atmospheric Pressure	: 1010 hPa
Memo	: DSA-12RN-12 AUS 120120	Rate	: 12 Mbps

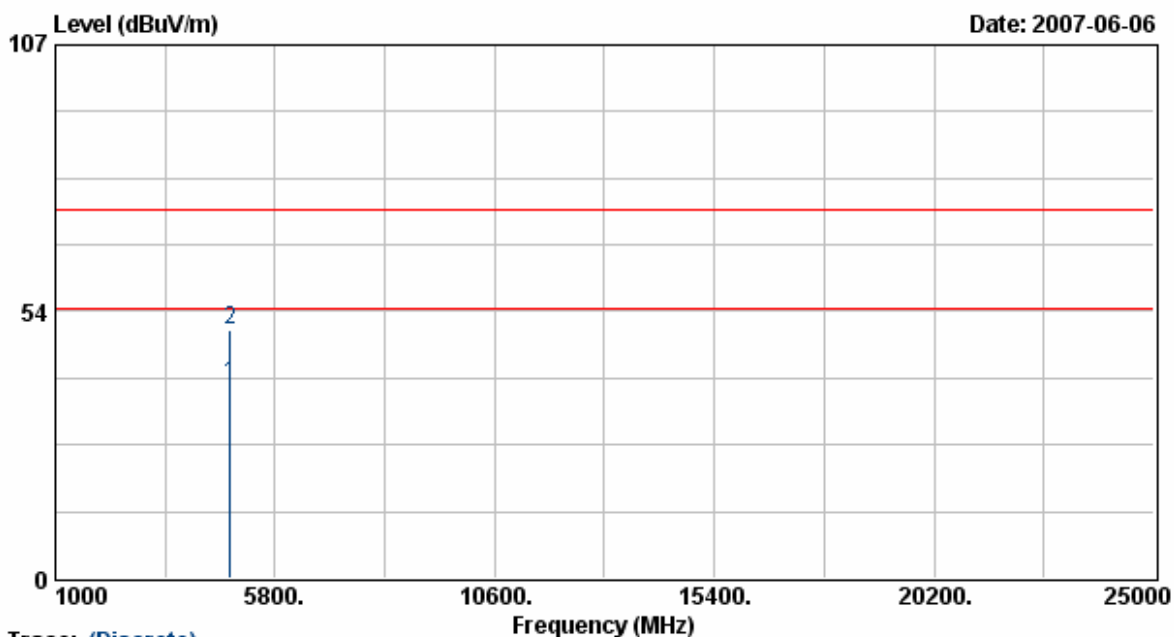

Trace: (Discrete)

Item	Freq	Read Value	Factor	Result	Limit	Margin	Remark	Ant Pos	Tab Pos
	MHz	dBuV/m	dB	dBuV/m	dBuV/m	dB		cm	Deg
1	4824.00	30.08	8.64	38.72	54.00	-15.28	Average	100	128
2	4824.00	41.17	8.64	49.81	74.00	-24.19	Peak	100	128

Notes:

1. Result = Read Value + Factor
2. Factor = Antenna Factor + Cable Loss - Amplifier
3. The resolution bandwidth of test receiver/spectrum analyzer is 120KHz and video bandwidth is 300kHz for Peak detection and Quasi-peak detection at frequency below 1GHz.
4. The resolution bandwidth of test receiver/spectrum analyzer is 1MHz and video bandwidth is 3MHz for Peak detection at frequency above 1GHz.
5. The resolution bandwidth of test receiver/spectrum analyzer is 1MHz and video bandwidth is 10Hz for Average detection at frequency above 1GHz.
6. The other emissions is too low to be measured.

Power	: AC120V	Pol/Phase	: VERTICAL
Test Mode 2	: Transmit / Receive	Temperature	: 25 °C
Operation Channel	: 6	Humidity	: 70 %
Modulation Type	: 802.11g	Atmospheric Pressure	: 1010 hPa
Memo	: DSA-12RN-12 AUS 120120	Rate	: 12 Mbps

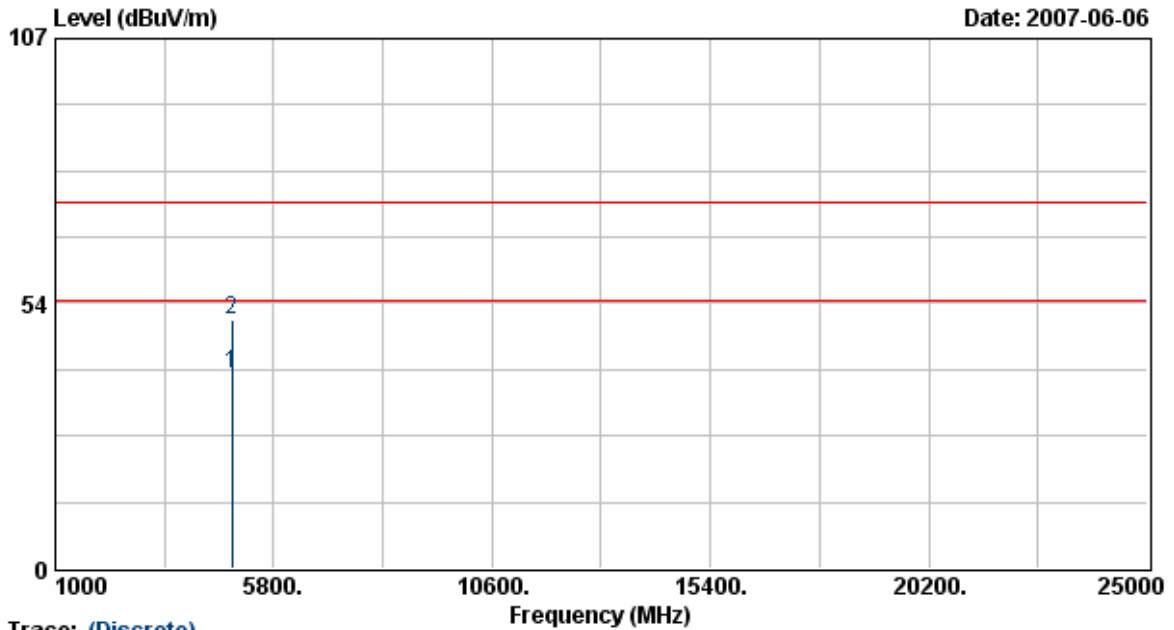

Trace: (Discrete)

Item	Freq	Read Value	Factor	Result	Limit	Margin	Remark	Ant Pos	Tab Pos
	MHz	dBuV/m	dB	dBuV/m	dBuV/m	dB		cm	Deg
1	4873.38	30.36	8.78	39.14	54.00	-14.86	Average	100	160
2	4873.38	41.33	8.78	50.11	74.00	-23.89	Peak	100	160

Notes:

1. Result = Read Value + Factor
2. Factor = Antenna Factor + Cable Loss - Amplifier
3. The resolution bandwidth of test receiver/spectrum analyzer is 120KHz and video bandwidth is 300kHz for Peak detection and Quasi-peak detection at frequency below 1GHz.
4. The resolution bandwidth of test receiver/spectrum analyzer is 1MHz and video bandwidth is 3MHz for Peak detection at frequency above 1GHz.
5. The resolution bandwidth of test receiver/spectrum analyzer is 1MHz and video bandwidth is 10Hz for Average detection at frequency above 1GHz.
6. The other emissions is too low to be measured.

Power	: AC120V	Pol/Phase	: HORIZONTAL
Test Mode 2	: Transmit / Receive	Temperature	: 25 °C
Operation Channel	: 6	Humidity	: 70 %
Modulation Type	: 802.11g	Atmospheric Pressure	: 1010 hPa
Memo	: DSA-12RN-12 AUS 120120	Rate	: 12 Mbps

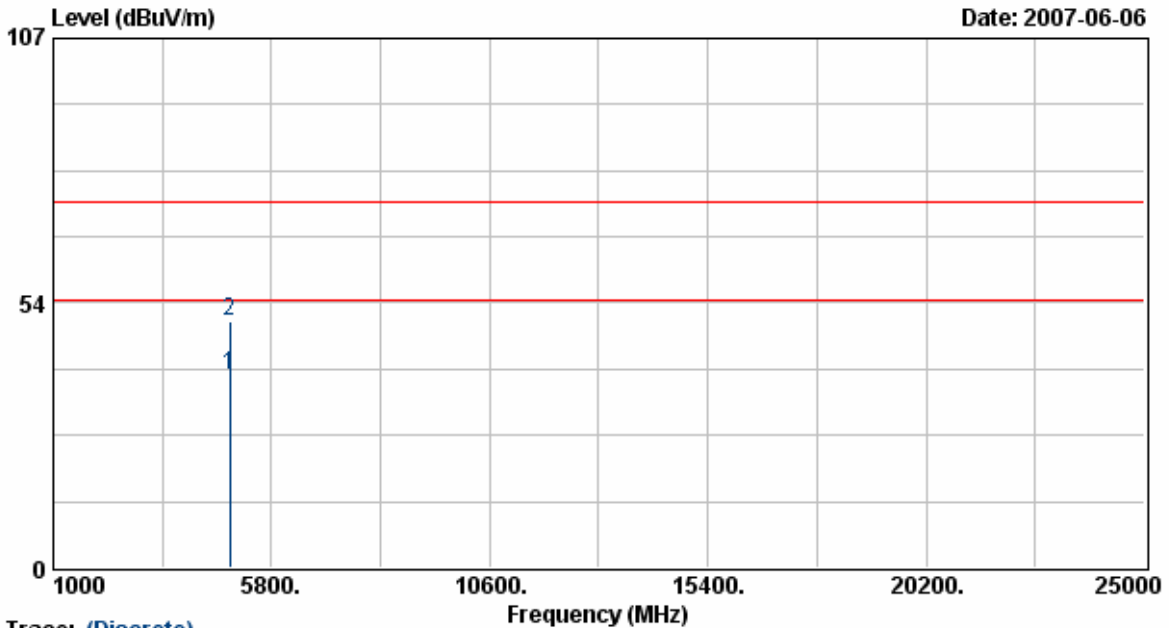

Trace: (Discrete)

Item	Freq	Read Value	Factor	Result	Limit	Margin	Remark	Ant Pos	Tab Pos
	MHz	dBuV/m	dB	dBuV/m	dBuV/m	dB		cm	Deg
1	4874.00	30.15	8.78	38.93	54.00	-15.07	Average	100	128
2	4874.00	41.17	8.78	49.95	74.00	-24.05	Peak	100	128

Notes:

1. Result = Read Value + Factor
2. Factor = Antenna Factor + Cable Loss - Amplifier
3. The resolution bandwidth of test receiver/spectrum analyzer is 120KHz and video bandwidth is 300kHz for Peak detection and Quasi-peak detection at frequency below 1GHz.
4. The resolution bandwidth of test receiver/spectrum analyzer is 1MHz and video bandwidth is 3MHz for Peak detection at frequency above 1GHz.
5. The resolution bandwidth of test receiver/spectrum analyzer is 1MHz and video bandwidth is 10Hz for Average detection at frequency above 1GHz.
6. The other emissions is too low to be measured.

Power	: AC120V	Pol/Phase	: VERTICAL
Test Mode 2	: Transmit / Receive	Temperature	: 25 °C
Operation Channel	: 11	Humidity	: 70 %
Modulation Type	: 802.11g	Atmospheric Pressure	: 1010 hPa
Memo	: DSA-12RN-12 AUS 120120	Rate	: 12 Mbps

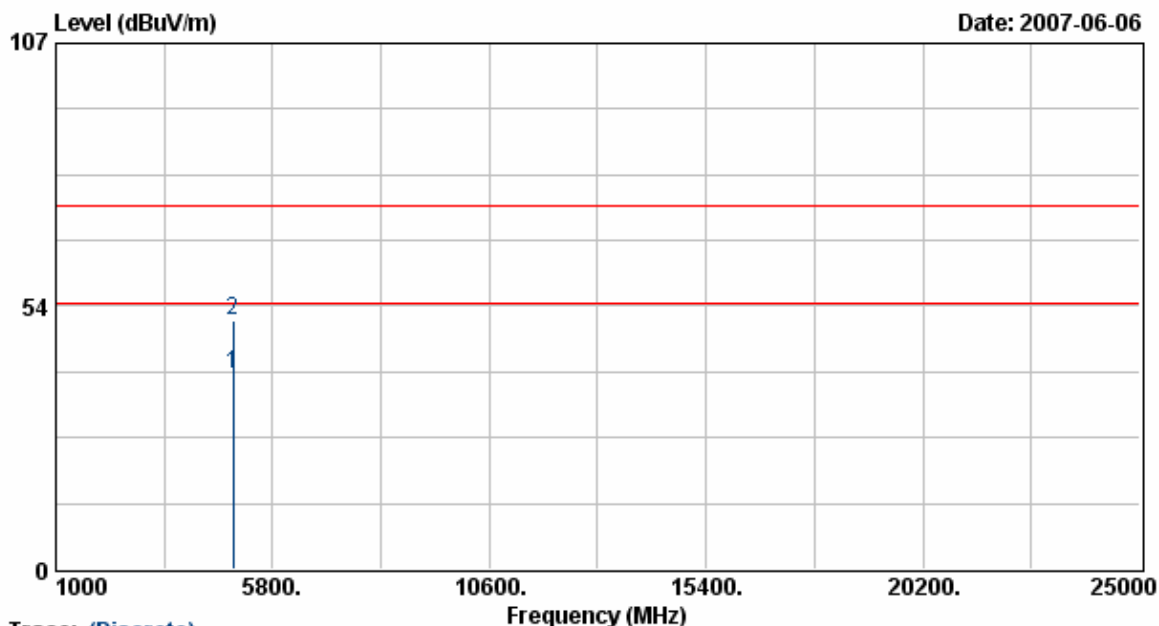

Trace: (Discrete)

Item	Freq	Read Value	Factor	Result	Limit	Margin	Remark	Ant Pos	Tab Pos
	MHz	dBuV/m	dB	dBuV/m	dBuV/m	dB		cm	Deg
1	4924.00	30.78	8.92	39.70	54.00	-14.30	Average	100	160
2	4924.00	41.79	8.92	50.71	74.00	-23.29	Peak	100	160

Notes:

1. Result = Read Value + Factor
2. Factor = Antenna Factor + Cable Loss - Amplifier
3. The resolution bandwidth of test receiver/spectrum analyzer is 120KHz and video bandwidth is 300kHz for Peak detection and Quasi-peak detection at frequency below 1GHz.
4. The resolution bandwidth of test receiver/spectrum analyzer is 1MHz and video bandwidth is 3MHz for Peak detection at frequency above 1GHz.
5. The resolution bandwidth of test receiver/spectrum analyzer is 1MHz and video bandwidth is 10Hz for Average detection at frequency above 1GHz.
6. The other emissions is too low to be measured.

Power	: AC120V	Pol/Phase	: HORIZONTAL
Test Mode 2	: Transmit / Receive	Temperature	: 25 °C
Operation Channel	: 11	Humidity	: 70 %
Modulation Type	: 802.11g	Atmospheric Pressure	: 1010 hPa
Memo	: DSA-12RN-12 AUS 120120	Rate	: 12 Mbps

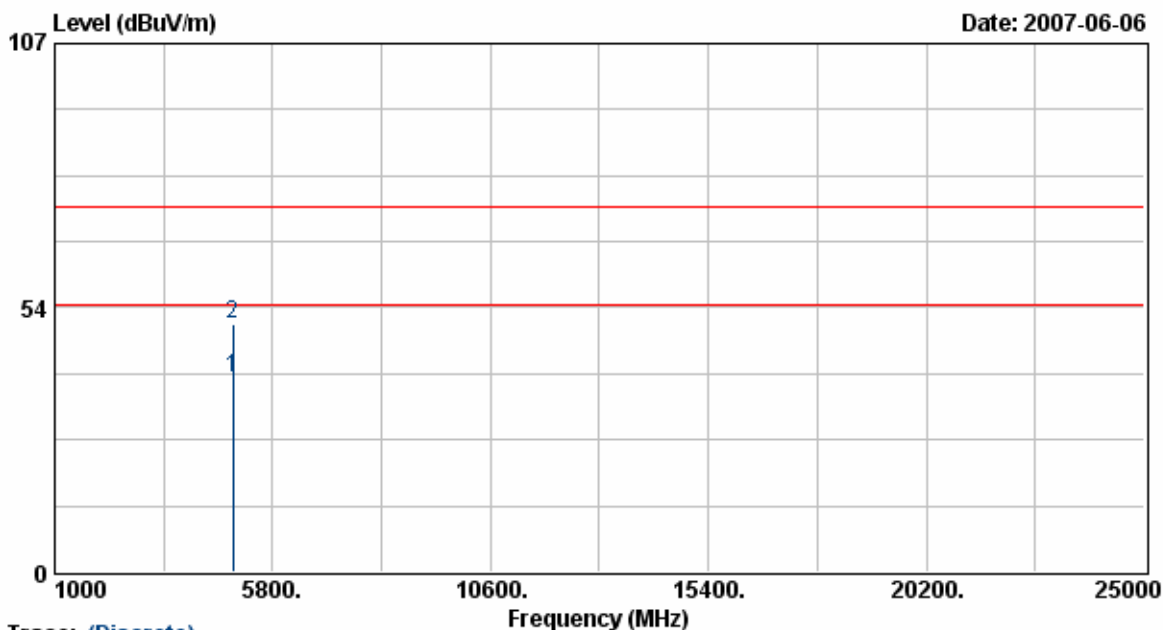

Trace: (Discrete)

Item	Freq	Read Value	Factor	Result	Limit	Margin	Remark	Ant Pos	Tab Pos
	MHz	dBuV/m	dB	dBuV/m	dBuV/m	dB		cm	Deg
1	4923.50	30.24	8.92	39.16	54.00	-14.84	Average	100	128
2	4923.50	41.26	8.92	50.18	74.00	-23.82	Peak	100	128

Notes:

1. Result = Read Value + Factor
2. Factor = Antenna Factor + Cable Loss - Amplifier
3. The resolution bandwidth of test receiver/spectrum analyzer is 120KHz and video bandwidth is 300kHz for Peak detection and Quasi-peak detection at frequency below 1GHz.
4. The resolution bandwidth of test receiver/spectrum analyzer is 1MHz and video bandwidth is 3MHz for Peak detection at frequency above 1GHz.
5. The resolution bandwidth of test receiver/spectrum analyzer is 1MHz and video bandwidth is 10Hz for Average detection at frequency above 1GHz.
6. The other emissions is too low to be measured.

Power	: AC120V	Pol/Phase	: VERTICAL
Test Mode 3	: Transmit / Receive	Temperature	: 25 °C
Operation Channel	: 1	Humidity	: 70 %
Modulation Type	: 802.11g	Atmospheric Pressure	: 1010 hPa
Memo	: RHQ-120100-1	Rate	: 12 Mbps

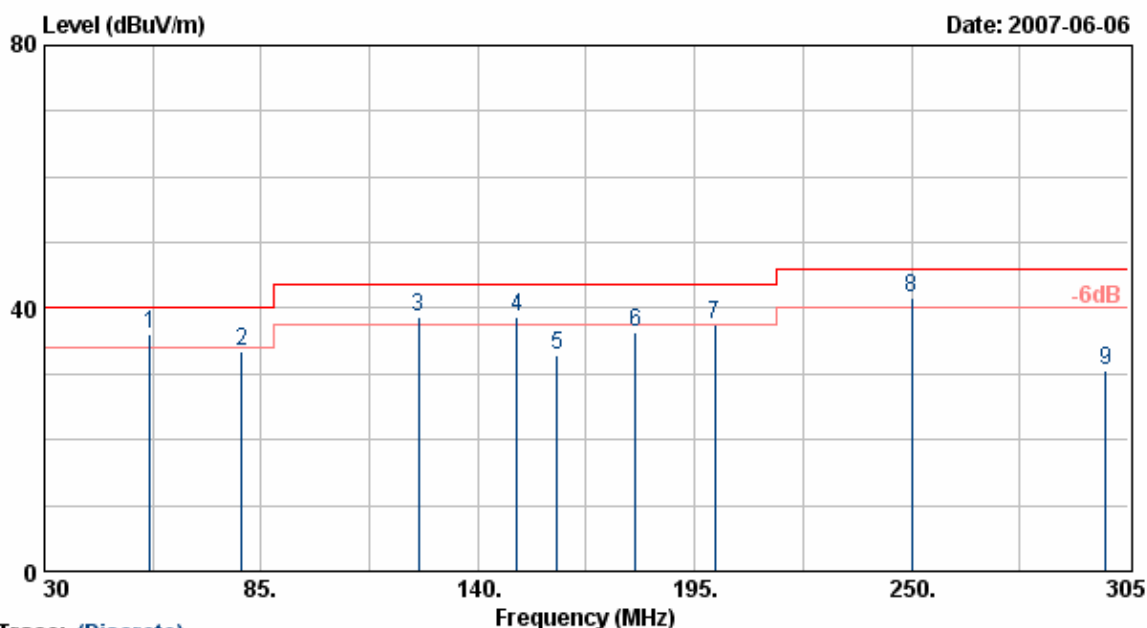

Trace: (Discrete)

Item	Freq	Read Value	Factor	Result	Limit	Margin	Remark	Ant Pos	Tab Pos
	MHz	dBuV/m	dB	dBuV/m	dBuV/m	dB		cm	Deg
1	56.70	53.24	-17.21	36.03	40.00	-3.97	QP	100	74
2	80.11	48.57	-15.12	33.45	40.00	-6.55	Peak	100	0
3	125.00	51.37	-12.59	38.78	43.50	-4.72	QP	100	0
4	150.00	50.70	-12.12	38.58	43.50	-4.92	QP	100	89
5	160.00	47.77	-14.93	32.84	43.50	-10.66	Peak	100	115
6	180.00	48.16	-11.81	36.35	43.50	-7.15	Peak	100	115
7	200.00	50.90	-13.25	37.65	43.50	-5.85	QP	100	257
8	250.00	53.43	-11.84	41.59	46.00	-4.41	QP	100	33
9	299.25	42.80	-12.16	30.64	46.00	-15.36	Peak	100	0

Notes:

1. Result = Read Value + Factor
2. Factor = Antenna Factor + Cable Loss - Amplifier
3. The resolution bandwidth of test receiver/spectrum analyzer is 120KHz and video bandwidth is 300kHz for Peak detection and Quasi-peak detection at frequency below 1GHz.
4. All emission below 1GHz at 802.11b/g mode are all the same,so the 802.11g mode chosen as representative in final test.
5. According to technical experiences,all spurious emission of 802.11g mode at channel 1,6,11 are almost the same below 1GHz,so that the channel 1 was chosen as representative in final test.
6. The data is worse case.

Power	: AC120V	Pol/Phase	: VERTICAL
Test Mode 3	: Transmit / Receive	Temperature	: 25 °C
Operation Channel	: 1	Humidity	: 70 %
Modulation Type	: 802.11g	Atmospheric Pressure	: 1010 hPa
Memo	: RHQ-120100-1	Rate	: 12 Mbps

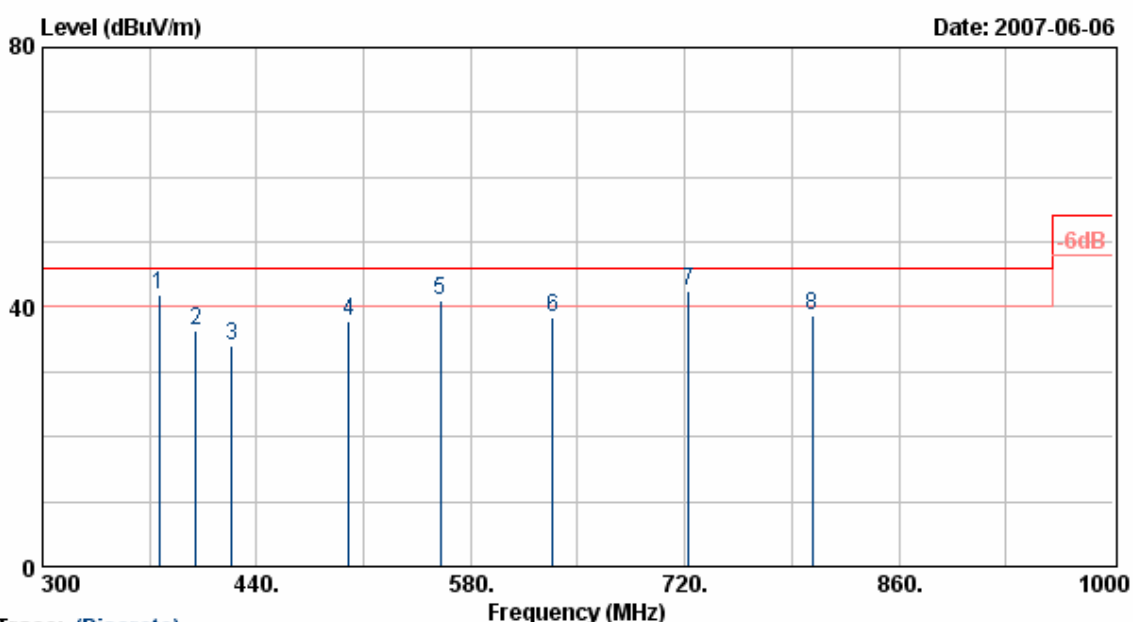

Trace: (Discrete)

Item	Freq	Read Value	Factor	Result	Limit	Margin	Remark	Ant Pos	Tab Pos
	MHz	dBuV/m	dB	dBuV/m	dBuV/m	dB		cm	Deg
1	376.30	51.26	-9.51	41.75	46.00	-4.25	QP	100	47
2	400.00	45.80	-9.40	36.40	46.00	-9.60	Peak	100	99
3	424.00	43.46	-9.39	34.07	46.00	-11.93	Peak	100	99
4	500.00	42.69	-4.96	37.73	46.00	-8.27	Peak	100	66
5	560.00	45.88	-4.75	41.13	46.00	-4.87	QP	100	121
6	633.90	41.87	-3.37	38.51	46.00	-7.50	Peak	100	35
7	722.80	46.70	-4.14	42.56	46.00	-3.44	QP	100	225
8	803.30	39.60	-1.02	38.58	46.00	-7.42	Peak	100	225

Notes:

1. Result = Read Value + Factor
2. Factor = Antenna Factor + Cable Loss - Amplifier
3. The resolution bandwidth of test receiver/spectrum analyzer is 120KHz and video bandwidth is 300kHz for Peak detection and Quasi-peak detection at frequency below 1GHz.
4. All emission below 1GHz at 802.11b/g mode are all the same, so the 802.11g mode chosen as representative in final test.
5. According to technical experiences, all spurious emission of 802.11g mode at channel 1,6,11 are almost the same below 1GHz, so that the channel 1 was chosen as representative in final test.
6. The data is worse case.

Power	: AC120V	Pol/Phase	: HORIZONTAL
Test Mode 3	: Transmit / Receive	Temperature	: 25 °C
Operation Channel	: 1	Humidity	: 70 %
Modulation Type	: 802.11g	Atmospheric Pressure	: 1010 hPa
Memo	: RHQ-120100-1	Rate	: 12 Mbps

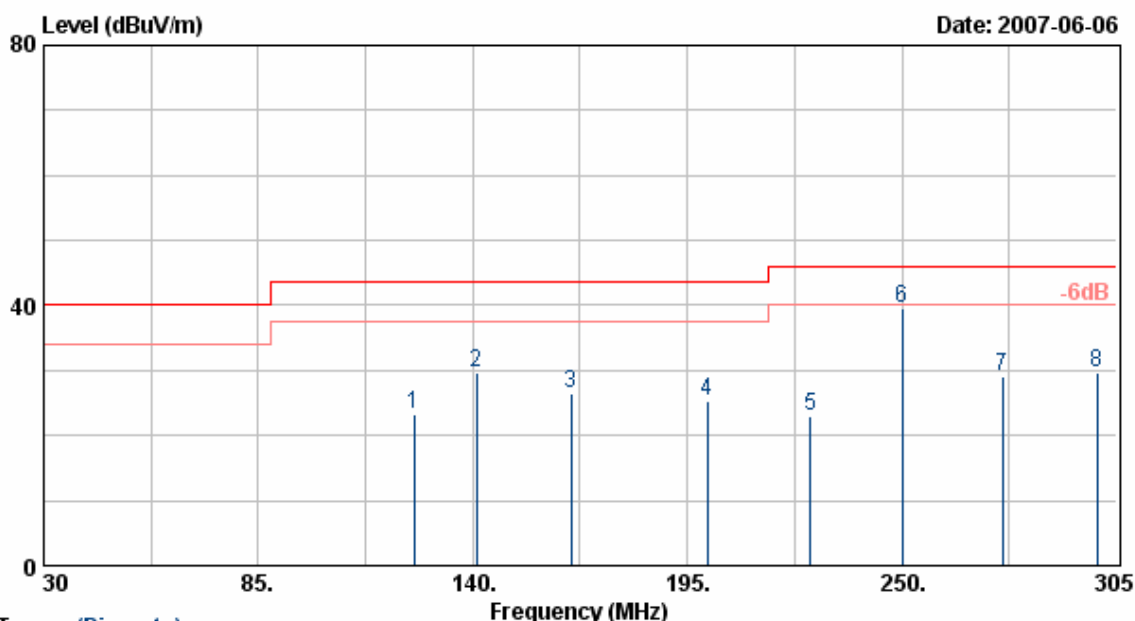

Trace: (Discrete)

Item	Freq	Read Value	Factor	Result	Limit	Margin	Remark	Ant Pos	Tab Pos
	MHz	dBuV/m	dB	dBuV/m	dBuV/m	dB		cm	Deg
1	125.00	44.57	-21.34	23.23	43.50	-20.27	Peak	200	44
2	141.00	46.35	-16.80	29.55	43.50	-13.95	Peak	200	83
3	165.30	47.36	-20.87	26.49	43.50	-17.01	Peak	200	83
4	200.00	44.74	-19.49	25.25	43.50	-18.25	Peak	200	182
5	226.50	41.66	-18.60	23.06	46.00	-22.94	Peak	200	182
6	250.00	55.93	-16.48	39.45	46.00	-6.55	Peak	200	332
7	275.80	43.30	-14.25	29.05	46.00	-16.95	Peak	200	360
8	300.05	44.77	-15.10	29.67	46.00	-16.33	Peak	200	304

Notes:

1. Result = Read Value + Factor
2. Factor = Antenna Factor + Cable Loss - Amplifier
3. The resolution bandwidth of test receiver/spectrum analyzer is 120KHz and video bandwidth is 300kHz for Peak detection and Quasi-peak detection at frequency below 1GHz.
4. All emission below 1GHz at 802.11b/g mode are all the same, so the 802.11g mode chosen as representative in final test.
5. According to technical experiences, all spurious emission of 802.11g mode at channel 1,6,11 are almost the same below 1GHz, so that the channel 1 was chosen as representative in final test.
6. The data is worse case.



Power	: AC120V	Pol/Phase	: HORIZONTAL
Test Mode 3	: Transmit / Receive	Temperature	: 25 °C
Operation Channel	: 1	Humidity	: 70 %
Modulation Type	: 802.11g	Atmospheric Pressure	: 1010 hPa
Memo	: RHQ-120100-1	Rate	: 12 Mbps

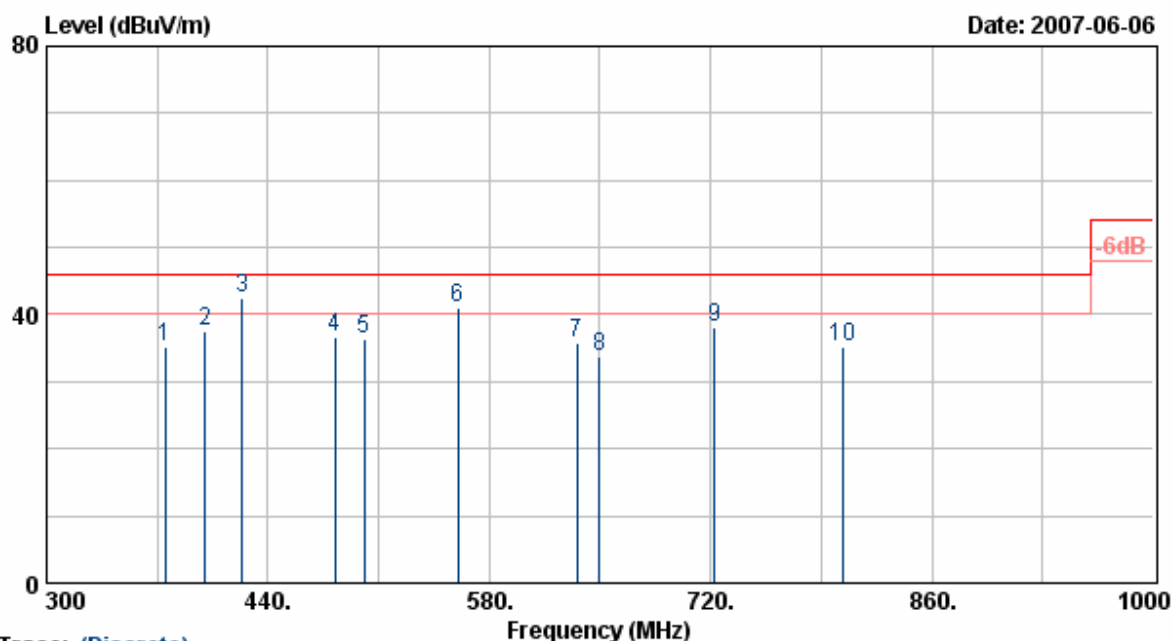

Trace: (Discrete)

Item	Freq	Read Value	Factor	Result	Limit	Margin	Remark	Ant Pos	Tab Pos
	MHz	dBuV/m	dB	dBuV/m	dBuV/m	dB		cm	Deg
1	374.92	45.66	-10.52	35.14	46.00	-10.86	Peak	200	0
2	400.00	46.56	-8.91	37.65	46.00	-8.35	Peak	200	81
3	423.90	50.35	-7.94	42.41	46.00	-3.59	QP	200	175
4	482.70	45.71	-8.99	36.72	46.00	-9.28	Peak	200	222
5	500.90	42.98	-6.68	36.30	46.00	-9.70	Peak	200	222
6	560.00	45.26	-4.18	41.08	46.00	-4.92	QP	200	0
7	635.30	40.27	-4.48	35.79	46.00	-10.21	Peak	200	0
8	650.00	37.93	-4.08	33.85	46.00	-12.15	Peak	200	66
9	722.80	45.12	-7.04	38.08	46.00	-7.92	Peak	200	0
10	803.30	38.63	-3.54	35.09	46.00	-10.91	Peak	200	62

Notes:

1. Result = Read Value + Factor
2. Factor = Antenna Factor + Cable Loss - Amplifier
3. The resolution bandwidth of test receiver/spectrum analyzer is 120KHz and video bandwidth is 300kHz for Peak detection and Quasi-peak detection at frequency below 1GHz.
4. All emission below 1GHz at 802.11b/g mode are all the same,so the 802.11g mode chosen as representative in final test.
5. According to technical experiences,all spurious emission of 802.11g mode at channel 1,6,11 are almost the same below 1GHz,so that the channel 1 was chosen as representative in final test.
6. The data is worse case.

Power	: AC120V	Pol/Phase	: VERTICAL
Test Mode 3	: Transmit / Receive	Temperature	: 25 °C
Operation Channel	: 1	Humidity	: 70 %
Modulation Type	: 802.11b	Atmospheric Pressure	: 1010 hPa
Memo	: RHQ-120100-1	Rate	: 11 Mbps

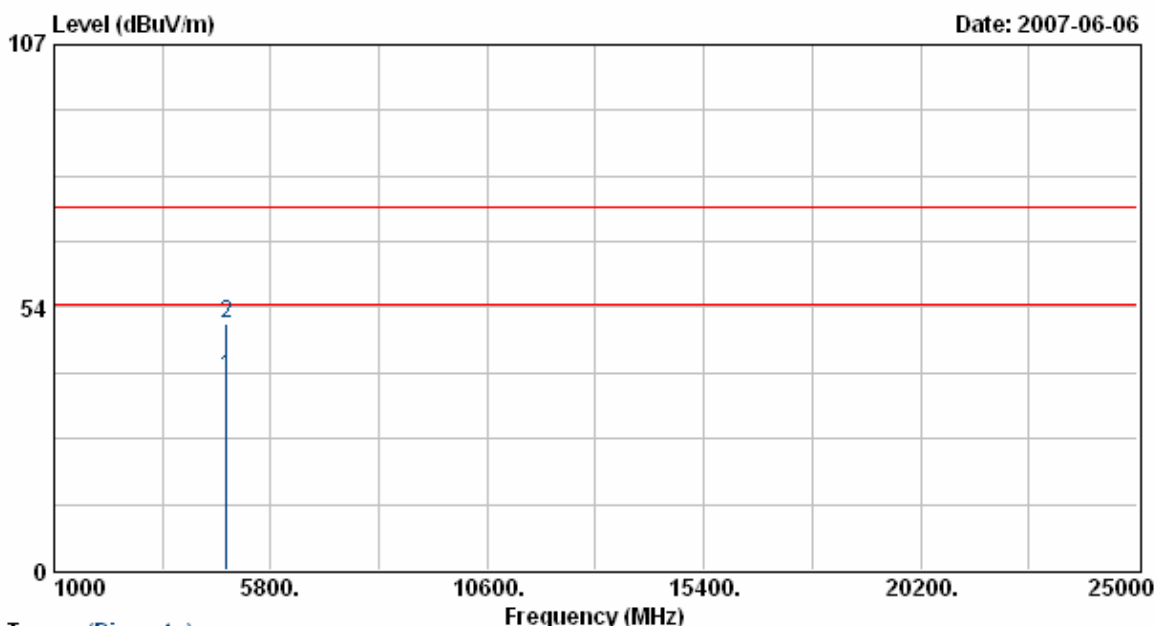

Trace: (Discrete)

Item	Freq	Read Value	Factor	Result	Limit	Margin	Remark	Ant Pos	Tab Pos
	MHz	dBuV/m	dB	dBuV/m	dBuV/m	dB		cm	Deg
1	4824.00	30.65	8.64	39.29	54.00	-14.71	Average	100	160
2	4824.00	41.47	8.64	50.11	74.00	-23.89	Peak	100	160

Notes:

1. Result = Read Value + Factor
2. Factor = Antenna Factor + Cable Loss - Amplifier
3. The resolution bandwidth of test receiver/spectrum analyzer is 120KHz and video bandwidth is 300kHz for Peak detection and Quasi-peak detection at frequency below 1GHz.
4. The resolution bandwidth of test receiver/spectrum analyzer is 1MHz and video bandwidth is 3MHz for Peak detection at frequency above 1GHz.
5. The resolution bandwidth of test receiver/spectrum analyzer is 1MHz and video bandwidth is 10Hz for Average detection at frequency above 1GHz.
6. The other emissions is too low to be measured.

Power	: AC120V	Pol/Phase	: HORIZONTAL
Test Mode 3	: Transmit / Receive	Temperature	: 25 °C
Operation Channel	: 1	Humidity	: 70 %
Modulation Type	: 802.11b	Atmospheric Pressure	: 1010 hPa
Memo	: RHQ-120100-1	Rate	: 11 Mbps

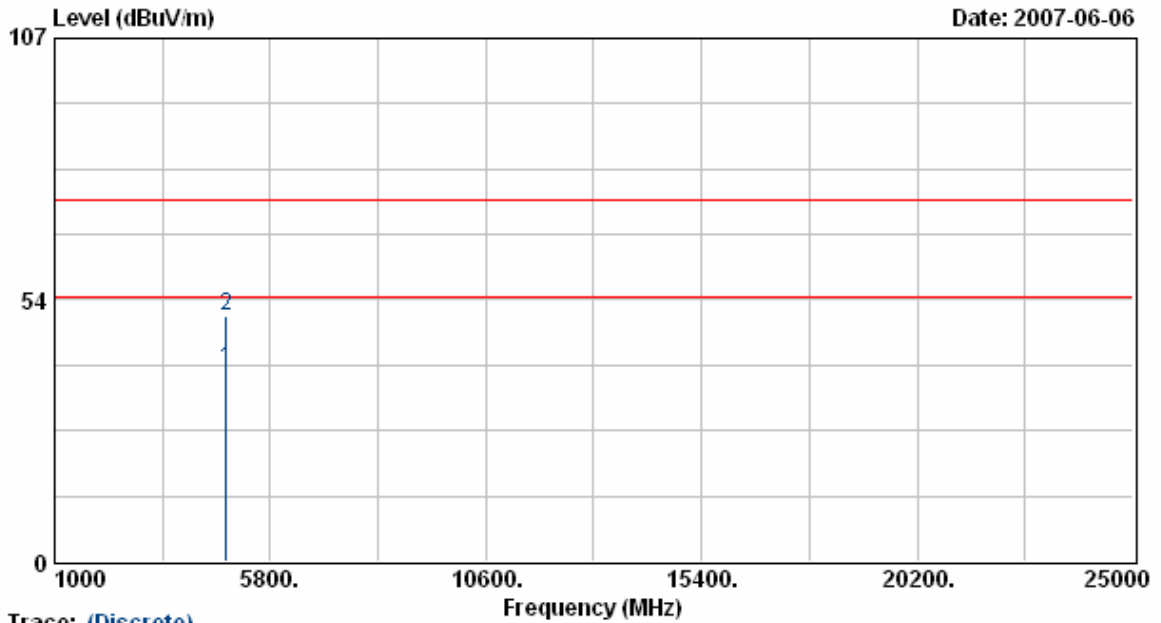

Trace: (Discrete)

Item	Freq	Read Value	Factor	Result	Limit	Margin	Remark	Ant Pos	Tab Pos
	MHz	dBuV/m	dB	dBuV/m	dBuV/m	dB		cm	Deg
1	4824.50	30.85	8.64	39.49	54.00	-14.51	Average	100	128
2	4824.50	41.70	8.64	50.34	74.00	-23.66	Peak	100	128

Notes:

1. Result = Read Value + Factor
2. Factor = Antenna Factor + Cable Loss - Amplifier
3. The resolution bandwidth of test receiver/spectrum analyzer is 120KHz and video bandwidth is 300kHz for Peak detection and Quasi-peak detection at frequency below 1GHz.
4. The resolution bandwidth of test receiver/spectrum analyzer is 1MHz and video bandwidth is 3MHz for Peak detection at frequency above 1GHz.
5. The resolution bandwidth of test receiver/spectrum analyzer is 1MHz and video bandwidth is 10Hz for Average detection at frequency above 1GHz.
6. The other emissions is too low to be measured.

Power	: AC120V	Pol/Phase	: VERTICAL
Test Mode 3	: Transmit / Receive	Temperature	: 25 °C
Operation Channel	: 6	Humidity	: 70 %
Modulation Type	: 802.11b	Atmospheric Pressure	: 1010 hPa
Memo	: RHQ-120100-1	Rate	: 11 Mbps

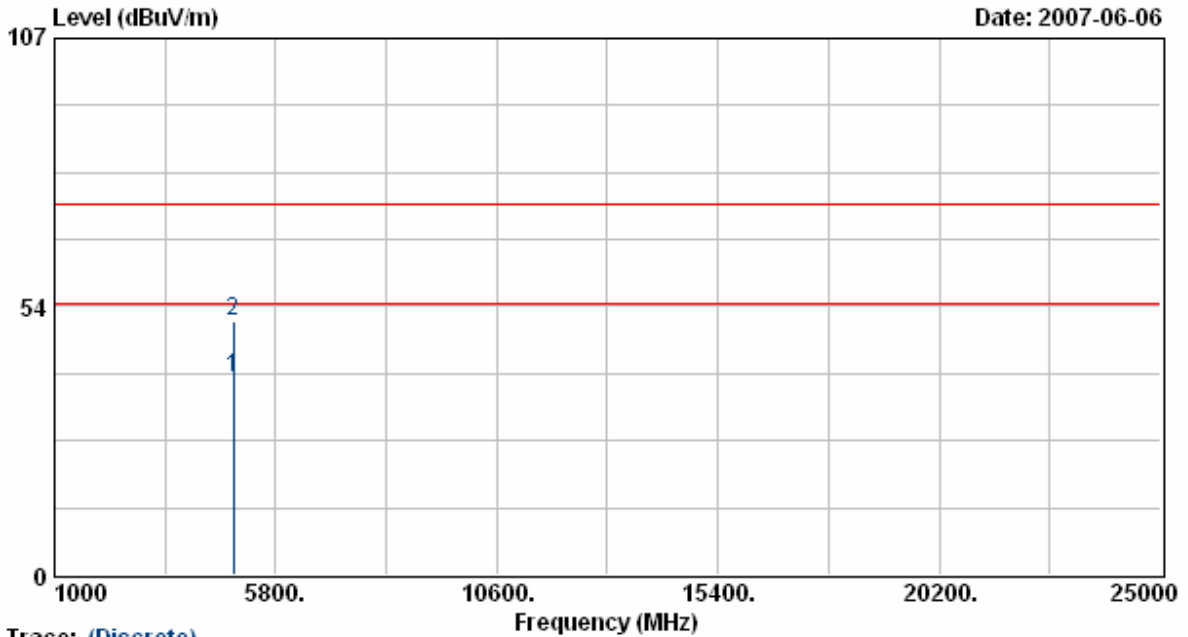

Trace: (Discrete)

Item	Freq	Read Value	Factor	Result	Limit	Margin	Remark	Ant Pos	Tab Pos
	MHz	dBuV/m	dB	dBuV/m	dBuV/m	dB		cm	Deg
1	4874.13	30.44	8.78	39.22	54.00	-14.78	Average	100	160
2	4874.13	41.67	8.78	50.45	74.00	-23.55	Peak	100	160

Notes:

1. Result = Read Value + Factor
2. Factor = Antenna Factor + Cable Loss - Amplifier
3. The resolution bandwidth of test receiver/spectrum analyzer is 120KHz and video bandwidth is 300kHz for Peak detection and Quasi-peak detection at frequency below 1GHz.
4. The resolution bandwidth of test receiver/spectrum analyzer is 1MHz and video bandwidth is 3MHz for Peak detection at frequency above 1GHz.
5. The resolution bandwidth of test receiver/spectrum analyzer is 1MHz and video bandwidth is 10Hz for Average detection at frequency above 1GHz.
6. The other emissions is too low to be measured.

Power	: AC120V	Pol/Phase	: HORIZONTAL
Test Mode 3	: Transmit / Receive	Temperature	: 25 °C
Operation Channel	: 6	Humidity	: 70 %
Modulation Type	: 802.11b	Atmospheric Pressure	: 1010 hPa
Memo	: RHQ-120100-1	Rate	: 11 Mbps

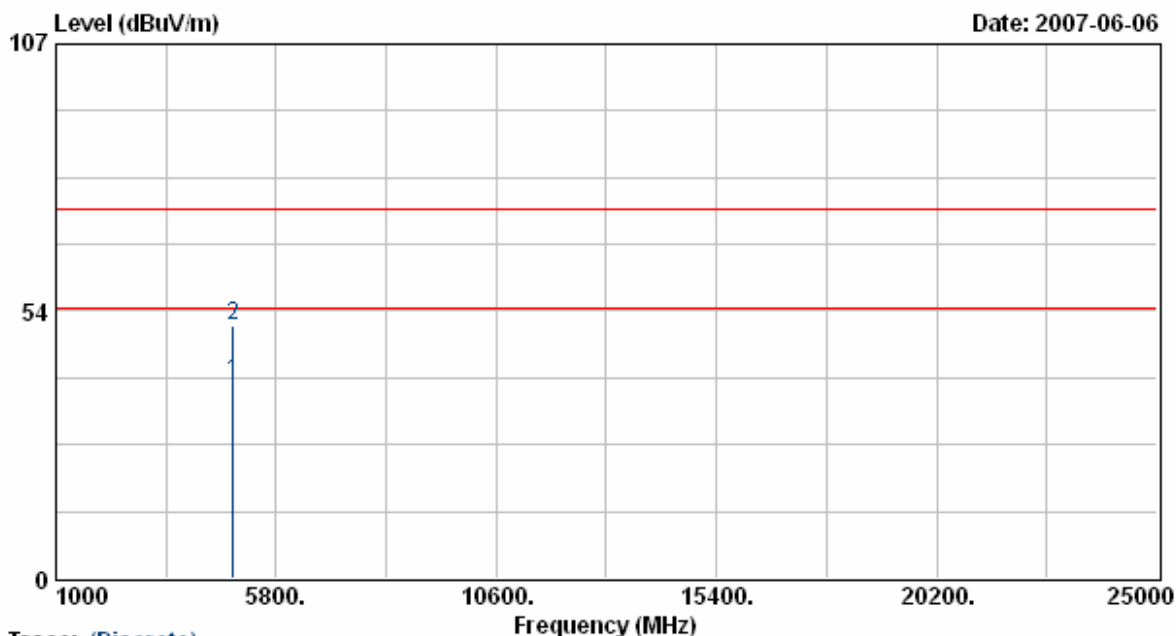

Trace: (Discrete)

Item	Freq	Read Value	Factor	Result	Limit	Margin	Remark	Ant Pos	Tab Pos
	MHz	dBuV/m	dB	dBuV/m	dBuV/m	dB		cm	Deg
1	4873.00	30.56	8.78	39.34	54.00	-14.66	Average	100	128
2	4873.00	41.70	8.78	50.48	74.00	-23.52	Peak	100	128

Notes:

1. Result = Read Value + Factor
2. Factor = Antenna Factor + Cable Loss - Amplifier
3. The resolution bandwidth of test receiver/spectrum analyzer is 120KHz and video bandwidth is 300kHz for Peak detection and Quasi-peak detection at frequency below 1GHz.
4. The resolution bandwidth of test receiver/spectrum analyzer is 1MHz and video bandwidth is 3MHz for Peak detection at frequency above 1GHz.
5. The resolution bandwidth of test receiver/spectrum analyzer is 1MHz and video bandwidth is 10Hz for Average detection at frequency above 1GHz.
6. The other emissions is too low to be measured.

Power	: AC120V	Pol/Phase	: VERTICAL
Test Mode 3	: Transmit / Receive	Temperature	: 25 °C
Operation Channel	: 11	Humidity	: 70 %
Modulation Type	: 802.11b	Atmospheric Pressure	: 1010 hPa
Memo	: RHQ-120100-1	Rate	: 11 Mbps

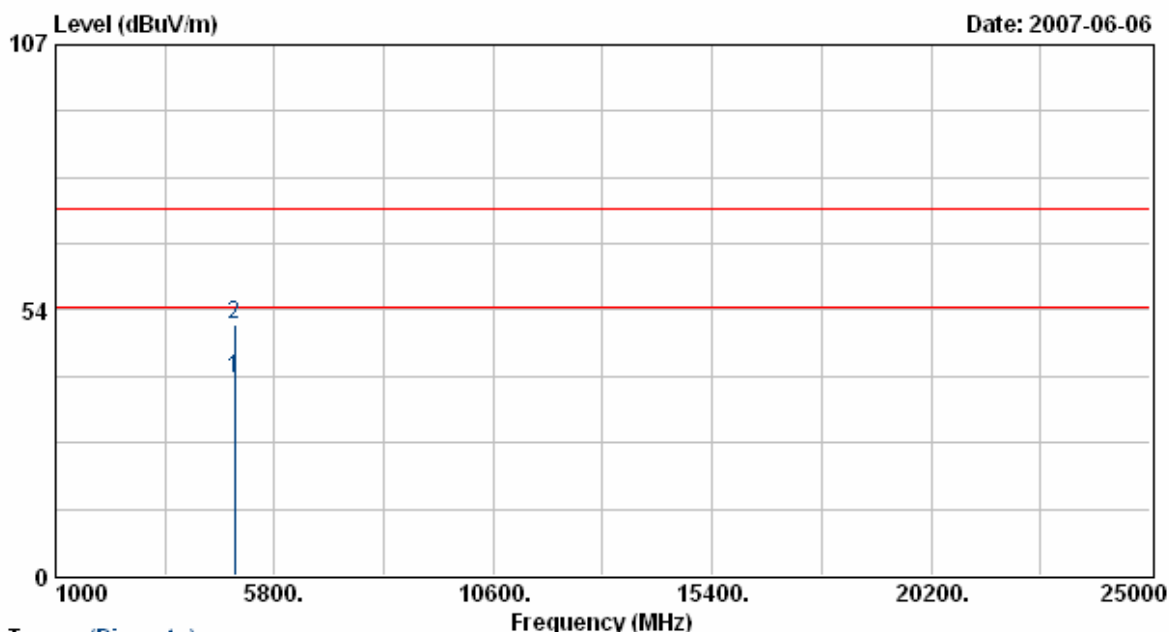

Trace: (Discrete)

Item	Freq	Read Value	Factor	Result	Limit	Margin	Remark	Ant Pos	Tab Pos
	MHz	dBuV/m	dB	dBuV/m	dBuV/m	dB		cm	Deg
1	4923.88	30.96	8.92	39.88	54.00	-14.12	Average	100	160
2	4923.88	41.67	8.92	50.59	74.00	-23.41	Peak	100	160

Notes:

1. Result = Read Value + Factor
2. Factor = Antenna Factor + Cable Loss - Amplifier
3. The resolution bandwidth of test receiver/spectrum analyzer is 120KHz and video bandwidth is 300kHz for Peak detection and Quasi-peak detection at frequency below 1GHz.
4. The resolution bandwidth of test receiver/spectrum analyzer is 1MHz and video bandwidth is 3MHz for Peak detection at frequency above 1GHz.
5. The resolution bandwidth of test receiver/spectrum analyzer is 1MHz and video bandwidth is 10Hz for Average detection at frequency above 1GHz.
6. The other emissions is too low to be measured.

Power	: AC120V	Pol/Phase	: HORIZONTAL
Test Mode 3	: Transmit / Receive	Temperature	: 25 °C
Operation Channel	: 11	Humidity	: 70 %
Modulation Type	: 802.11b	Atmospheric Pressure	: 1010 hPa
Memo	: RHQ-120100-1	Rate	: 11 Mbps

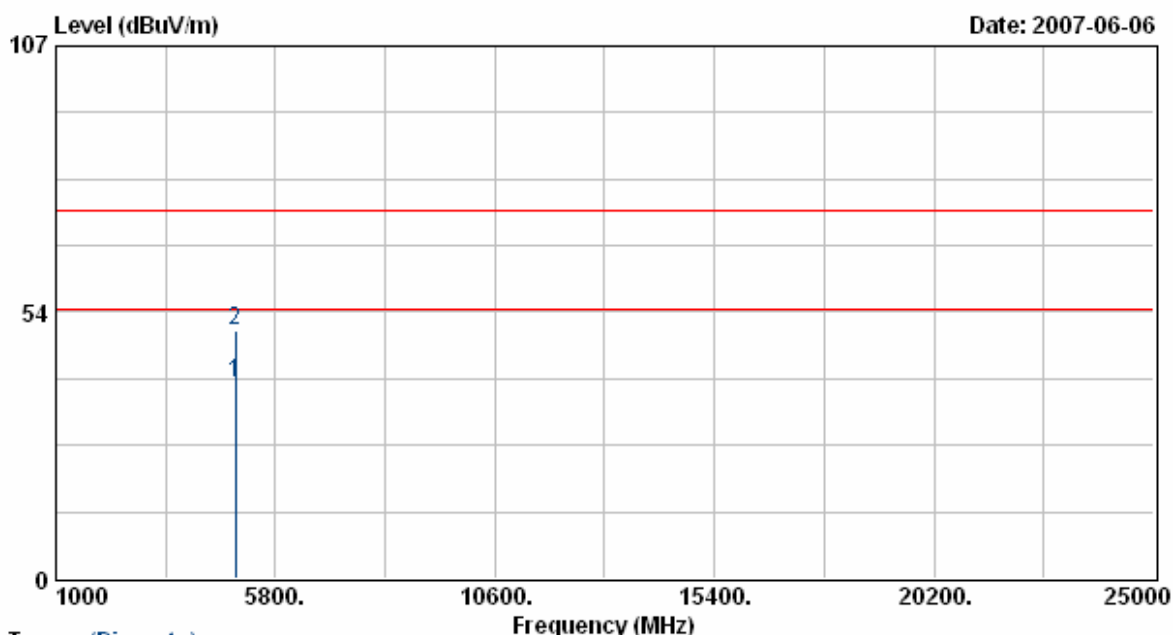

Trace: (Discrete)

Item	Freq	Read Value	Factor	Result	Limit	Margin	Remark	Ant Pos	Tab Pos
	MHz	dBuV/m	dB	dBuV/m	dBuV/m	dB		cm	Deg
1	4924.25	30.21	8.92	39.13	54.00	-14.87	Average	100	128
2	4924.25	41.07	8.92	49.99	74.00	-24.01	Peak	100	128

Notes:

1. Result = Read Value + Factor
2. Factor = Antenna Factor + Cable Loss - Amplifier
3. The resolution bandwidth of test receiver/spectrum analyzer is 120KHz and video bandwidth is 300kHz for Peak detection and Quasi-peak detection at frequency below 1GHz.
4. The resolution bandwidth of test receiver/spectrum analyzer is 1MHz and video bandwidth is 3MHz for Peak detection at frequency above 1GHz.
5. The resolution bandwidth of test receiver/spectrum analyzer is 1MHz and video bandwidth is 10Hz for Average detection at frequency above 1GHz.
6. The other emissions is too low to be measured.

Power	: AC120V	Pol/Phase	: VERTICAL
Test Mode 3	: Transmit / Receive	Temperature	: 25 °C
Operation Channel	: 1	Humidity	: 70 %
Modulation Type	: 802.11g	Atmospheric Pressure	: 1010 hPa
Memo	: RHQ-120100-1	Rate	: 12 Mbps

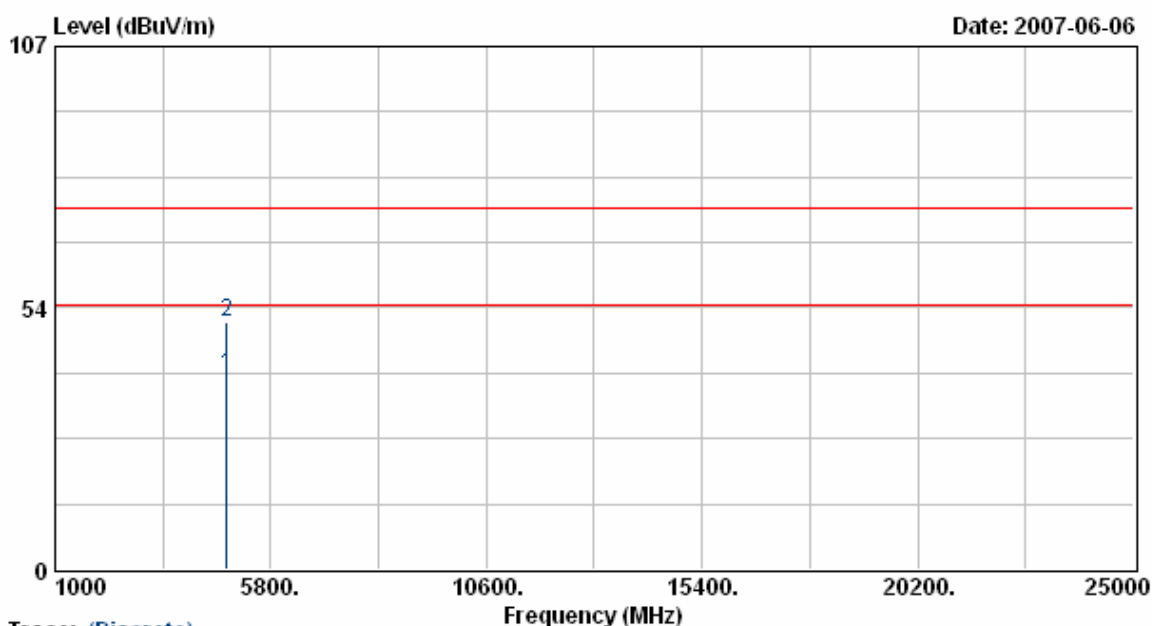

Trace: (Discrete)

Item	Freq	Read Value	Factor	Result	Limit	Margin	Remark	Ant Pos	Tab Pos
	MHz	dBuV/m	dB	dBuV/m	dBuV/m	dB		cm	Deg
1	4824.13	30.88	8.64	39.52	54.00	-14.48	Average	100	160
2	4824.13	41.77	8.64	50.41	74.00	-23.59	Peak	100	160

Notes:

1. Result = Read Value + Factor
2. Factor = Antenna Factor + Cable Loss - Amplifier
3. The resolution bandwidth of test receiver/spectrum analyzer is 120KHz and video bandwidth is 300kHz for Peak detection and Quasi-peak detection at frequency below 1GHz.
4. The resolution bandwidth of test receiver/spectrum analyzer is 1MHz and video bandwidth is 3MHz for Peak detection at frequency above 1GHz.
5. The resolution bandwidth of test receiver/spectrum analyzer is 1MHz and video bandwidth is 10Hz for Average detection at frequency above 1GHz.
6. The other emissions is too low to be measured.



Power	: AC120V	Pol/Phase	: HORIZONTAL
Test Mode 3	: Transmit / Receive	Temperature	: 25 °C
Operation Channel	: 1	Humidity	: 70 %
Modulation Type	: 802.11g	Atmospheric Pressure	: 1010 hPa
Memo	: RHQ-120100-1	Rate	: 12 Mbps

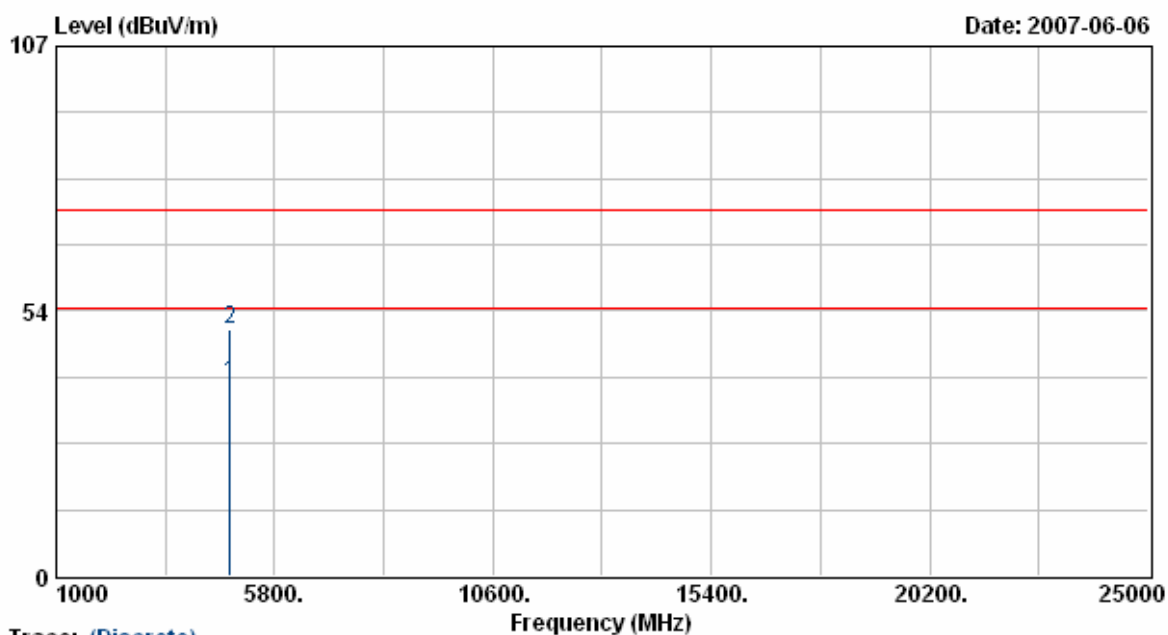

Trace: (Discrete)

Item	Freq	Read Value	Factor	Result	Limit	Margin	Remark	Ant Pos	Tab Pos
	MHz	dBuV/m	dB	dBuV/m	dBuV/m	dB		cm	Deg
1	4824.00	30.08	8.64	38.72	54.00	-15.28	Average	100	128
2	4824.00	41.18	8.64	49.82	74.00	-24.18	Peak	100	128

Notes:

1. Result = Read Value + Factor
2. Factor = Antenna Factor + Cable Loss - Amplifier
3. The resolution bandwidth of test receiver/spectrum analyzer is 120KHz and video bandwidth is 300kHz for Peak detection and Quasi-peak detection at frequency below 1GHz.
4. The resolution bandwidth of test receiver/spectrum analyzer is 1MHz and video bandwidth is 3MHz for Peak detection at frequency above 1GHz.
5. The resolution bandwidth of test receiver/spectrum analyzer is 1MHz and video bandwidth is 10Hz for Average detection at frequency above 1GHz.
6. The other emissions is too low to be measured.

Power	: AC120V	Pol/Phase	: VERTICAL
Test Mode 3	: Transmit / Receive	Temperature	: 25 °C
Operation Channel	: 6	Humidity	: 70 %
Modulation Type	: 802.11g	Atmospheric Pressure	: 1010 hPa
Memo	: RHQ-120100-1	Rate	: 12 Mbps

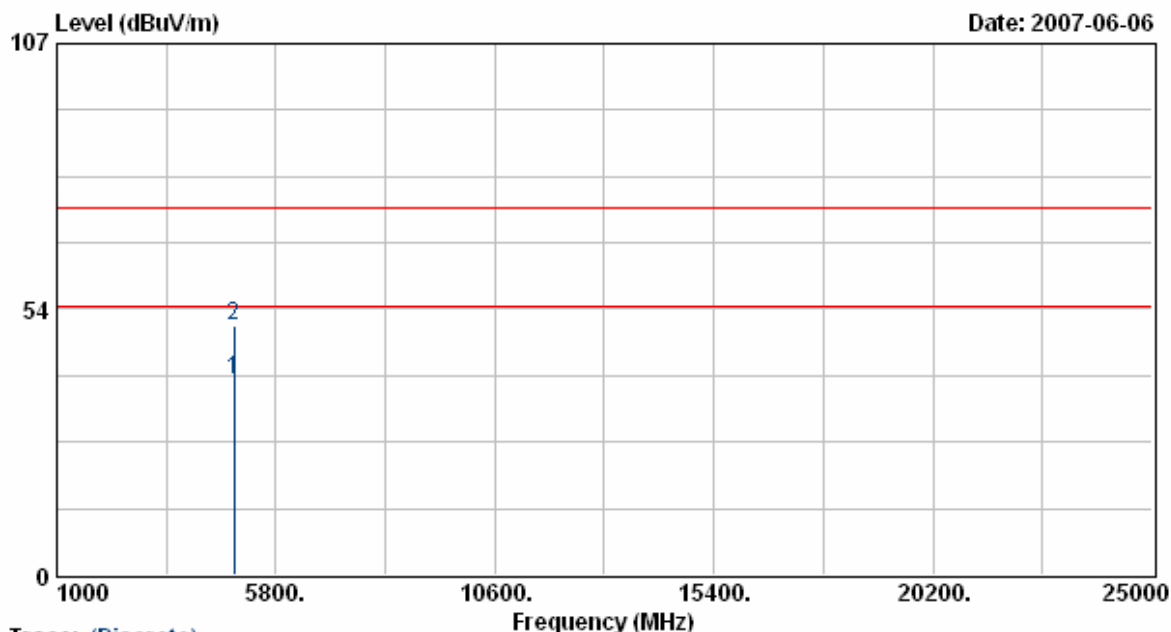

Trace: (Discrete)

Item	Freq	Read Value	Factor	Result	Limit	Margin	Remark	Ant Pos	Tab Pos
	MHz	dBuV/m	dB	dBuV/m	dBuV/m	dB		cm	Deg
1	4873.38	30.36	8.78	39.14	54.00	-14.86	Average	100	160
2	4873.38	41.57	8.78	50.35	74.00	-23.65	Peak	100	160

Notes:

1. Result = Read Value + Factor
2. Factor = Antenna Factor + Cable Loss - Amplifier
3. The resolution bandwidth of test receiver/spectrum analyzer is 120KHz and video bandwidth is 300kHz for Peak detection and Quasi-peak detection at frequency below 1GHz.
4. The resolution bandwidth of test receiver/spectrum analyzer is 1MHz and video bandwidth is 3MHz for Peak detection at frequency above 1GHz.
5. The resolution bandwidth of test receiver/spectrum analyzer is 1MHz and video bandwidth is 10Hz for Average detection at frequency above 1GHz.
6. The other emissions is too low to be measured.

Power	: AC120V	Pol/Phase	: HORIZONTAL
Test Mode 3	: Transmit / Receive	Temperature	: 25 °C
Operation Channel	: 6	Humidity	: 70 %
Modulation Type	: 802.11g	Atmospheric Pressure	: 1010 hPa
Memo	: RHQ-120100-1	Rate	: 12 Mbps

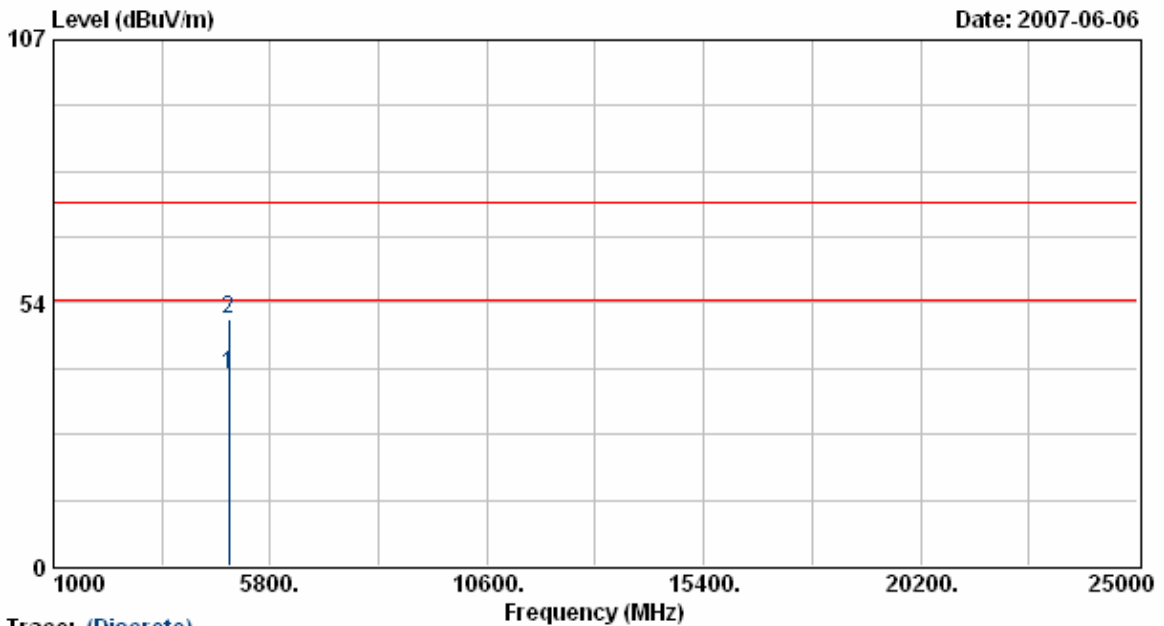

Trace: (Discrete)

Item	Freq	Read Value	Factor	Result	Limit	Margin	Remark	Ant Pos	Tab Pos
	MHz	dBuV/m	dB	dBuV/m	dBuV/m	dB		cm	Deg
1	4874.00	30.15	8.78	38.93	54.00	-15.07	Average	100	128
2	4874.00	41.47	8.78	50.25	74.00	-23.75	Peak	100	128

Notes:

1. Result = Read Value + Factor
2. Factor = Antenna Factor + Cable Loss - Amplifier
3. The resolution bandwidth of test receiver/spectrum analyzer is 120KHz and video bandwidth is 300kHz for Peak detection and Quasi-peak detection at frequency below 1GHz.
4. The resolution bandwidth of test receiver/spectrum analyzer is 1MHz and video bandwidth is 3MHz for Peak detection at frequency above 1GHz.
5. The resolution bandwidth of test receiver/spectrum analyzer is 1MHz and video bandwidth is 10Hz for Average detection at frequency above 1GHz.
6. The other emissions is too low to be measured.

Power	: AC120V	Pol/Phase	: VERTICAL
Test Mode 3	: Transmit / Receive	Temperature	: 25 °C
Operation Channel	: 11	Humidity	: 70 %
Modulation Type	: 802.11g	Atmospheric Pressure	: 1010 hPa
Memo	: RHQ-120100-1	Rate	: 12 Mbps

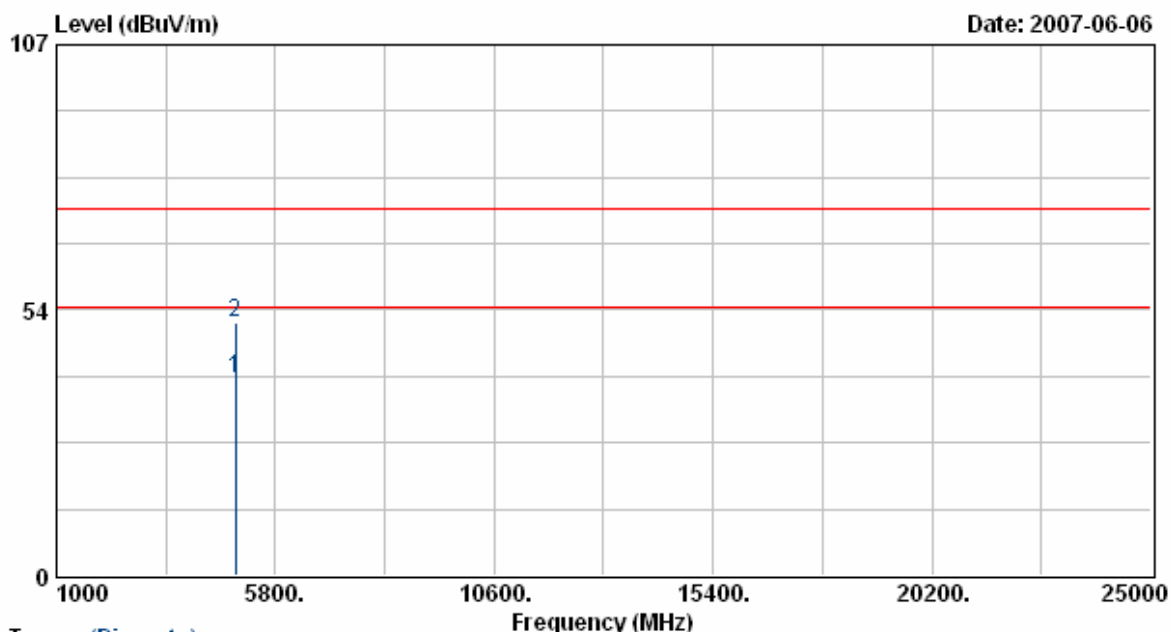

Trace: (Discrete)

Item	Freq	Read Value	Factor	Result	Limit	Margin	Remark	Ant Pos	Tab Pos
	MHz	dBuV/m	dB	dBuV/m	dBuV/m	dB		cm	Deg
1	4924.00	30.77	8.92	39.69	54.00	-14.31	Average	100	160
2	4924.00	41.90	8.92	50.82	74.00	-23.18	Peak	100	160

Notes:

1. Result = Read Value + Factor
2. Factor = Antenna Factor + Cable Loss - Amplifier
3. The resolution bandwidth of test receiver/spectrum analyzer is 120KHz and video bandwidth is 300kHz for Peak detection and Quasi-peak detection at frequency below 1GHz.
4. The resolution bandwidth of test receiver/spectrum analyzer is 1MHz and video bandwidth is 3MHz for Peak detection at frequency above 1GHz.
5. The resolution bandwidth of test receiver/spectrum analyzer is 1MHz and video bandwidth is 10Hz for Average detection at frequency above 1GHz.
6. The other emissions is too low to be measured.

Power	: AC120V	Pol/Phase	: HORIZONTAL
Test Mode 3	: Transmit / Receive	Temperature	: 25 °C
Operation Channel	: 11	Humidity	: 70 %
Modulation Type	: 802.11g	Atmospheric Pressure	: 1010 hPa
Memo	: RHQ-120100-1	Rate	: 12 Mbps

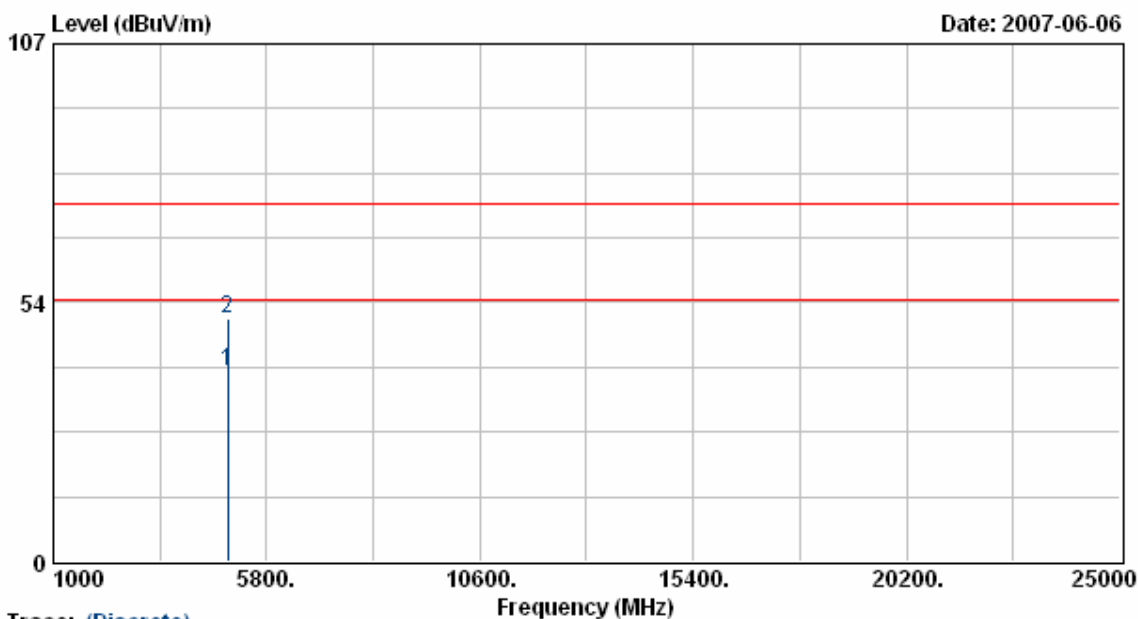

Trace: (Discrete)

Item	Freq	Read Value	Factor	Result	Limit	Margin	Remark	Ant Pos	Tab Pos
	MHz	dBuV/m	dB	dBuV/m	dBuV/m	dB		cm	Deg
1	4923.50	30.24	8.92	39.16	54.00	-14.84	Average	100	128
2	4923.50	41.27	8.92	50.19	74.00	-23.81	Peak	100	128

Notes:

1. Result = Read Value + Factor
2. Factor = Antenna Factor + Cable Loss - Amplifier
3. The resolution bandwidth of test receiver/spectrum analyzer is 120KHz and video bandwidth is 300kHz for Peak detection and Quasi-peak detection at frequency below 1GHz.
4. The resolution bandwidth of test receiver/spectrum analyzer is 1MHz and video bandwidth is 3MHz for Peak detection at frequency above 1GHz.
5. The resolution bandwidth of test receiver/spectrum analyzer is 1MHz and video bandwidth is 10Hz for Average detection at frequency above 1GHz.
6. The other emissions is too low to be measured.

Power	: AC120V	Pol/Phase	: VERTICAL
Test Mode 4	: Transmit / Receive	Temperature	: 25 °C
Operation Channel	: 1	Humidity	: 70 %
Modulation Type	: 802.11g	Atmospheric Pressure	: 1010 hPa
Memo	: RHQ-120100-1	Rate	: 12 Mbps

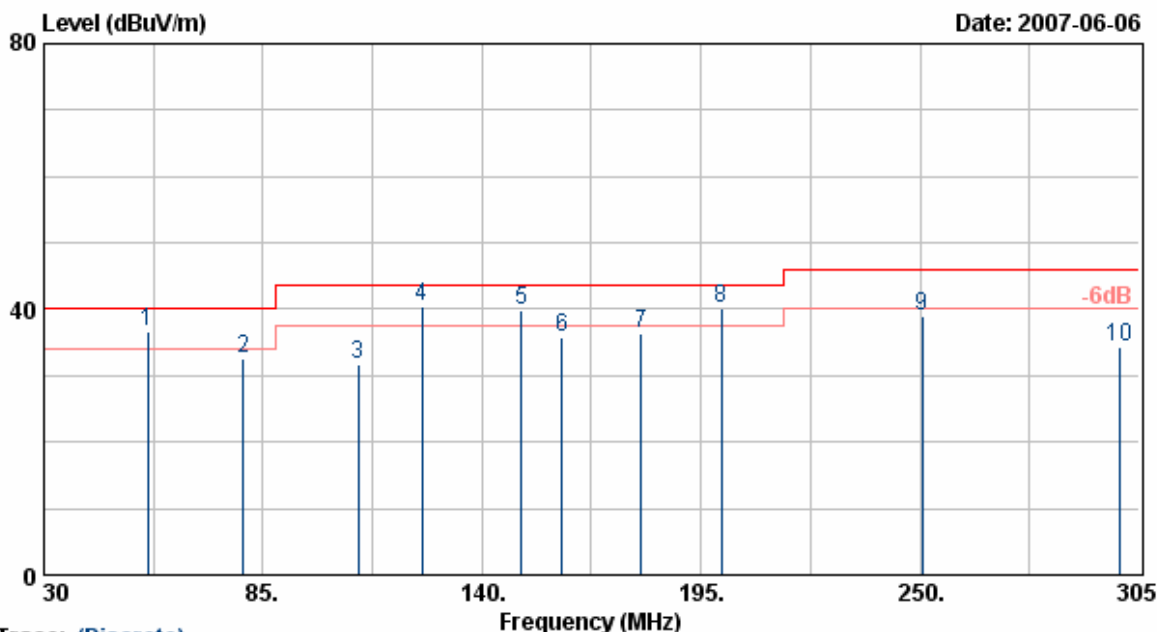

Trace: (Discrete)

Item	Freq	Read Value	Factor	Result	Limit	Margin	Remark	Ant Pos	Tab Pos
	MHz	dBuV/m	dB	dBuV/m	dBuV/m	dB		cm	Deg
1	56.00	53.76	-17.03	36.73	40.00	-3.27	QP	100	75
2	80.00	47.61	-15.08	32.53	40.00	-7.47	Peak	100	21
3	108.90	48.19	-16.57	31.62	43.50	-11.88	Peak	100	21
4	125.00	52.93	-12.59	40.34	43.50	-3.16	QP	100	88
5	150.00	51.91	-12.12	39.79	43.50	-3.71	QP	100	90
6	160.00	50.80	-14.93	35.87	43.50	-7.63	Peak	100	115
7	180.00	48.22	-11.81	36.41	43.50	-7.09	Peak	100	115
8	200.00	53.35	-13.25	40.10	43.50	-3.40	QP	100	276
9	250.55	50.67	-11.80	38.87	46.00	-7.13	Peak	100	55
10	300.00	46.33	-12.10	34.23	46.00	-11.77	Peak	100	55

Notes:

1. Result = Read Value + Factor
2. Factor = Antenna Factor + Cable Loss - Amplifier
3. The resolution bandwidth of test receiver/spectrum analyzer is 120KHz and video bandwidth is 300kHz for Peak detection and Quasi-peak detection at frequency below 1GHz.
4. All emission below 1GHz at 802.11b/g mode are all the same, so the 802.11g mode chosen as representative in final test.
5. According to technical experiences, all spurious emission of 802.11g mode at channel 1,6,11 are almost the same below 1GHz, so that the channel 1 was chosen as representative in final test.
6. The data is worse case.

Power	: AC120V	Pol/Phase	: VERTICAL
Test Mode 4	: Transmit / Receive	Temperature	: 25 °C
Operation Channel	: 1	Humidity	: 70 %
Modulation Type	: 802.11g	Atmospheric Pressure	: 1010 hPa
Memo	: RHQ-120100-1	Rate	: 12 Mbps

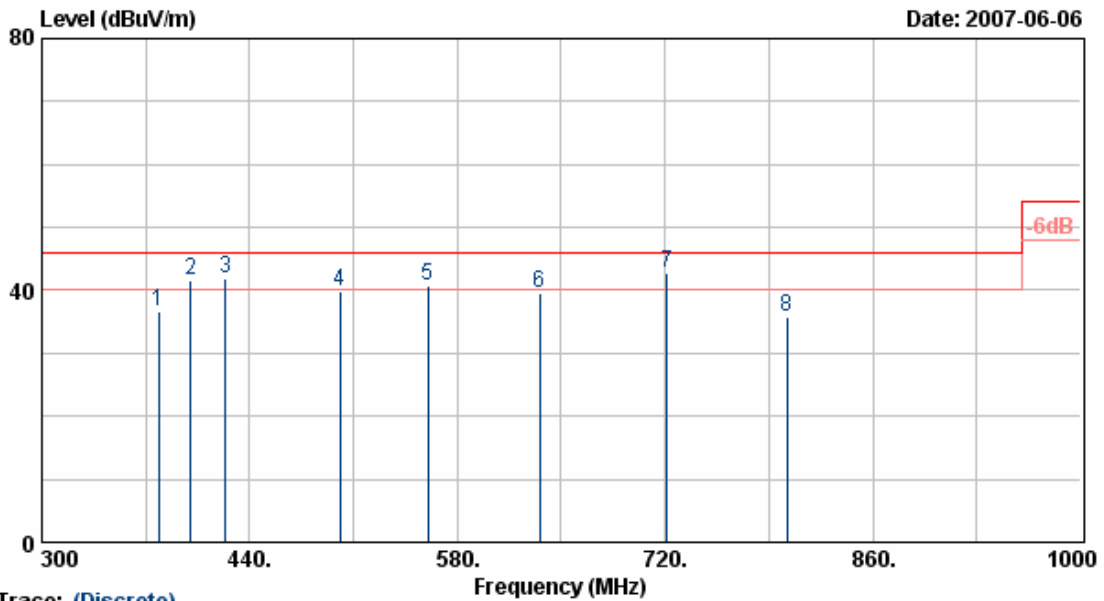

Trace: (Discrete)

Item	Freq	Read Value	Factor	Result	Limit	Margin	Remark	Ant Pos	Tab Pos
	MHz	dBuV/m	dB	dBuV/m	dBuV/m	dB		cm	Deg
1	378.40	46.68	-10.03	36.65	46.00	-9.35	Peak	100	48
2	400.00	50.90	-9.40	41.50	46.00	-4.50	QP	100	110
3	424.00	51.21	-9.39	41.82	46.00	-4.18	QP	100	110
4	500.90	44.57	-4.82	39.75	46.00	-6.25	Peak	100	66
5	560.00	45.51	-4.75	40.76	46.00	-5.24	QP	100	125
6	635.30	42.61	-3.19	39.42	46.00	-6.58	Peak	100	40
7	721.40	47.10	-4.28	42.82	46.00	-3.18	QP	100	225
8	801.90	37.13	-1.31	35.82	46.00	-10.18	Peak	100	225

Notes:

1. Result = Read Value + Factor
2. Factor = Antenna Factor + Cable Loss - Amplifier
3. The resolution bandwidth of test receiver/spectrum analyzer is 120KHz and video bandwidth is 300kHz for Peak detection and Quasi-peak detection at frequency below 1GHz.
4. All emission below 1GHz at 802.11b/g mode are all the same, so the 802.11g mode chosen as representative in final test.
5. According to technical experiences, all spurious emission of 802.11g mode at channel 1, 6, 11 are almost the same below 1GHz, so that the channel 1 was chosen as representative in final test.
6. The data is worse case.

Power	: AC120V	Pol/Phase	: HORIZONTAL
Test Mode 4	: Transmit / Receive	Temperature	: 25 °C
Operation Channel	: 1	Humidity	: 70 %
Modulation Type	: 802.11g	Atmospheric Pressure	: 1010 hPa
Memo	: RHQ-120100-1	Rate	: 12 Mbps

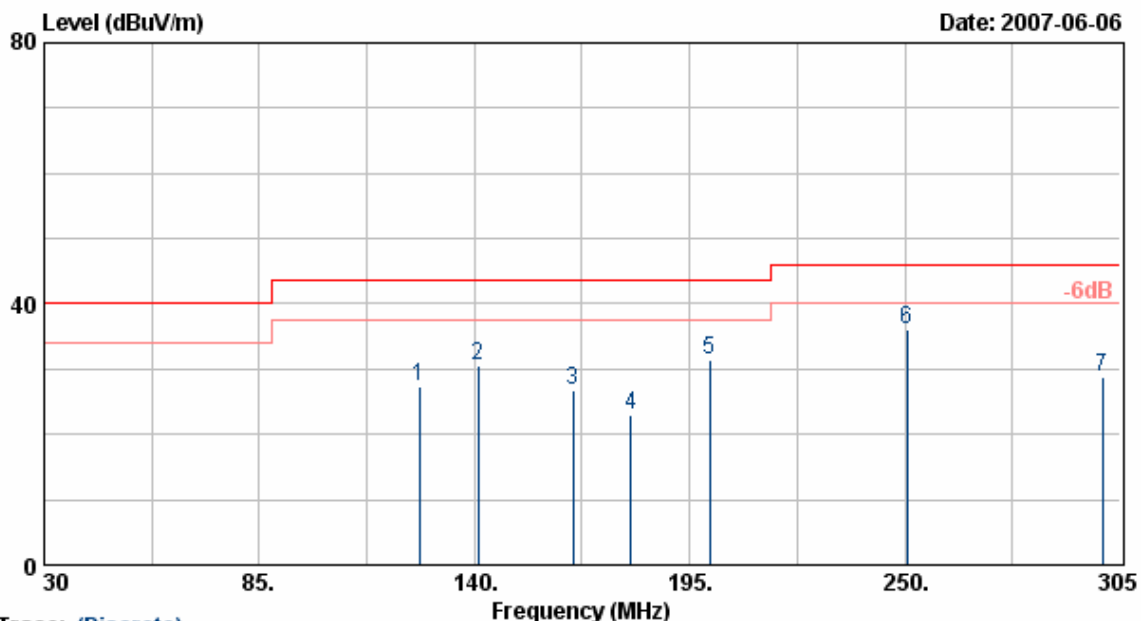

Trace: (Discrete)

Item	Freq	Read Value	Factor	Result	Limit	Margin	Remark	Ant Pos	Tab Pos
	MHz	dBuV/m	dB	dBuV/m	dBuV/m	dB		cm	Deg
1	125.98	48.46	-21.18	27.28	43.50	-16.22	Peak	200	51
2	141.00	47.29	-16.80	30.49	43.50	-13.01	Peak	200	85
3	165.30	47.57	-20.87	26.70	43.50	-16.80	Peak	200	85
4	180.00	45.23	-22.20	23.03	43.50	-20.47	Peak	200	112
5	200.00	50.80	-19.49	31.31	43.50	-12.19	Peak	200	182
6	250.50	52.59	-16.45	36.14	46.00	-9.86	Peak	200	335
7	300.60	44.02	-15.15	28.87	46.00	-17.13	Peak	200	335

Notes:

1. Result = Read Value + Factor
2. Factor = Antenna Factor + Cable Loss - Amplifier
3. The resolution bandwidth of test receiver/spectrum analyzer is 120KHz and video bandwidth is 300kHz for Peak detection and Quasi-peak detection at frequency below 1GHz.
4. All emission below 1GHz at 802.11b/g mode are all the same,so the 802.11g mode chosen as representative in final test.
5. According to technical experiences,all spurious emission of 802.11g mode at channel 1,6,11 are almost the same below 1GHz,so that the channel 1 was chosen as representative in final test.
6. The data is worse case.



Power	: AC120V	Pol/Phase	: HORIZONTAL
Test Mode 4	: Transmit / Receive	Temperature	: 25 °C
Operation Channel	: 1	Humidity	: 70 %
Modulation Type	: 802.11g	Atmospheric Pressure	: 1010 hPa
Memo	: RHQ-120100-1	Rate	: 12 Mbps

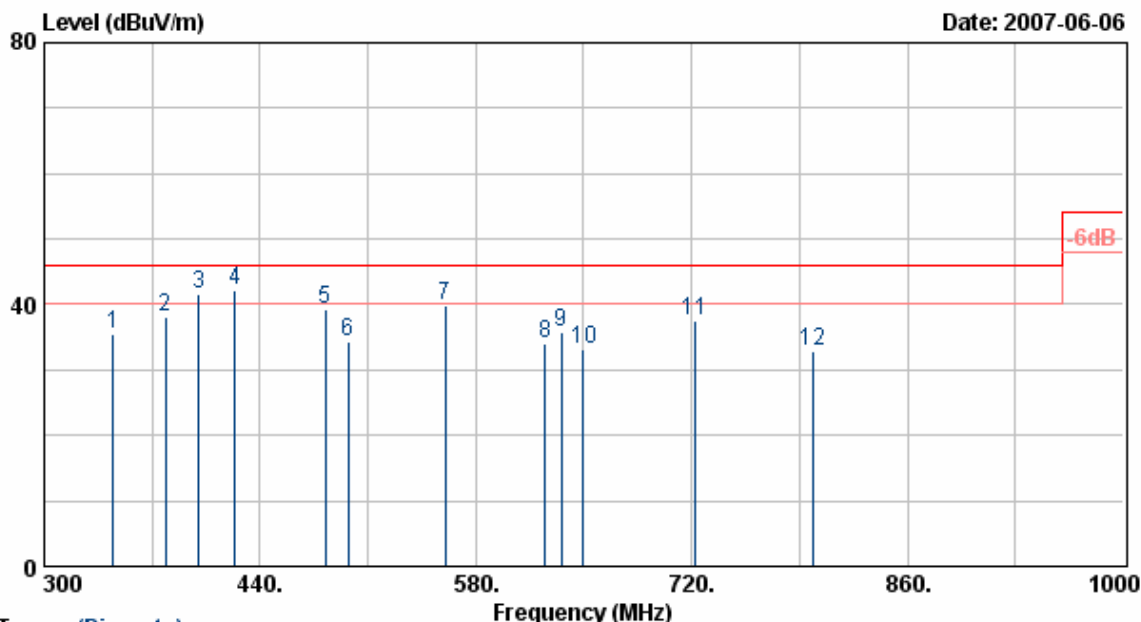

Trace: (Discrete)

Item	Freq	Read Value	Factor	Result	Limit	Margin	Remark	Ant Pos	Tab Pos
	MHz	dBuV/m	dB	dBuV/m	dBuV/m	dB		cm	Deg
1	344.80	47.86	-12.47	35.39	46.00	-10.61	Peak	200	0
2	378.40	48.18	-9.96	38.22	46.00	-7.78	Peak	200	52
3	400.00	50.53	-8.91	41.62	46.00	-4.38	QP	200	88
4	424.00	50.26	-7.95	42.31	46.00	-3.69	QP	200	177
5	482.70	48.39	-8.99	39.40	46.00	-6.60	Peak	200	223
6	497.40	41.57	-7.13	34.44	46.00	-11.56	Peak	200	225
7	560.00	44.15	-4.18	39.97	46.00	-6.03	Peak	200	33
8	625.00	38.85	-4.78	34.07	46.00	-11.93	Peak	200	33
9	635.30	40.36	-4.48	35.88	46.00	-10.12	Peak	200	69
10	650.00	37.34	-4.08	33.26	46.00	-12.74	Peak	200	89
11	722.80	44.70	-7.04	37.66	46.00	-8.34	Peak	200	0
12	799.10	36.71	-3.83	32.88	46.00	-13.12	Peak	200	50

Notes:

1. Result = Read Value + Factor
2. Factor = Antenna Factor + Cable Loss - Amplifier
3. The resolution bandwidth of test receiver/spectrum analyzer is 120KHz and video bandwidth is 300kHz for Peak detection and Quasi-peak detection at frequency below 1GHz.
4. All emission below 1GHz at 802.11b/g mode are all the same, so the 802.11g mode chosen as representative in final test.
5. According to technical experiences, all spurious emission of 802.11g mode at channel 1,6,11 are almost the same below 1GHz, so that the channel 1 was chosen as representative in final test.
6. The data is worse case.

Power	: AC120V	Pol/Phase	: VERTICAL
Test Mode 4	: Transmit / Receive	Temperature	: 25 °C
Operation Channel	: 1	Humidity	: 70 %
Modulation Type	: 802.11b	Atmospheric Pressure	: 1010 hPa
Memo	: RHQ-120100-1	Rate	: 11 Mbps

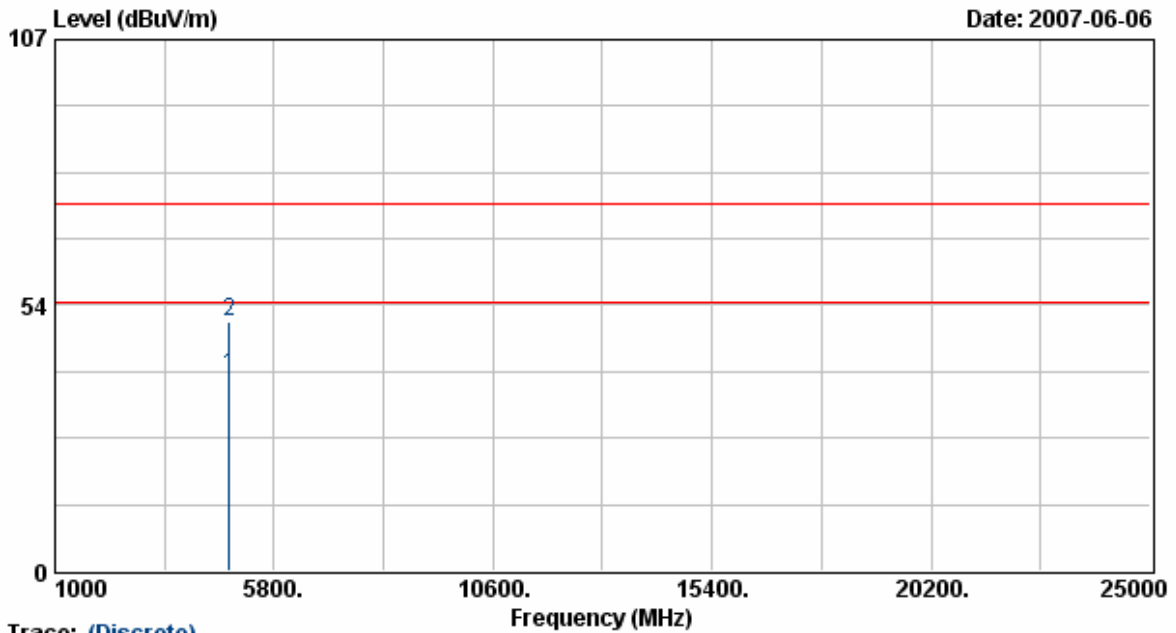

Trace: (Discrete)

Item	Freq	Read Value	Factor	Result	Limit	Margin	Remark	Ant Pos	Tab Pos
	MHz	dBuV/m	dB	dBuV/m	dBuV/m	dB		cm	Deg
1	4824.00	30.67	8.64	39.31	54.00	-14.69	Average	100	160
2	4824.00	41.66	8.64	50.30	74.00	-23.70	Peak	100	160

Notes:

1. Result = Read Value + Factor
2. Factor = Antenna Factor + Cable Loss - Amplifier
3. The resolution bandwidth of test receiver/spectrum analyzer is 120KHz and video bandwidth is 300kHz for Peak detection and Quasi-peak detection at frequency below 1GHz.
4. The resolution bandwidth of test receiver/spectrum analyzer is 1MHz and video bandwidth is 3MHz for Peak detection at frequency above 1GHz.
5. The resolution bandwidth of test receiver/spectrum analyzer is 1MHz and video bandwidth is 10Hz for Average detection at frequency above 1GHz.
6. The other emissions is too low to be measured.

Power	: AC120V	Pol/Phase	: HORIZONTAL
Test Mode 4	: Transmit / Receive	Temperature	: 25 °C
Operation Channel	: 1	Humidity	: 70 %
Modulation Type	: 802.11b	Atmospheric Pressure	: 1010 hPa
Memo	: RHQ-120100-1	Rate	: 11 Mbps

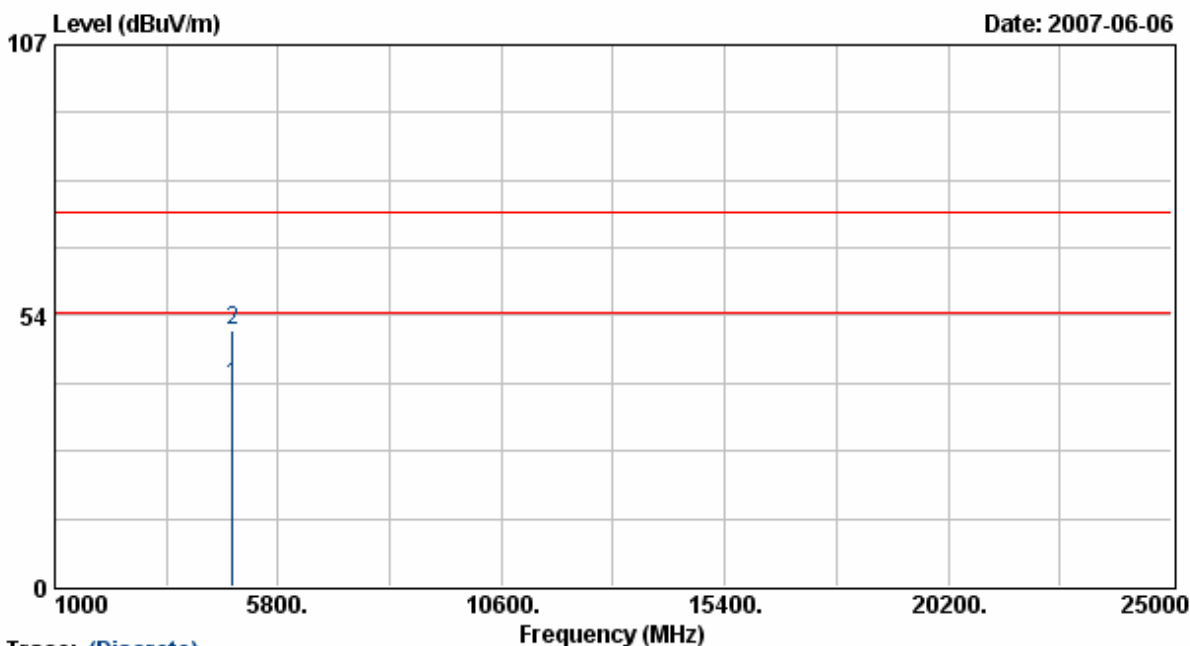

Trace: (Discrete)

Item	Freq	Read Value	Factor	Result	Limit	Margin	Remark	Ant Pos	Tab Pos
	MHz	dBuV/m	dB	dBuV/m	dBuV/m	dB		cm	Deg
1	4824.50	30.87	8.64	39.51	54.00	-14.49	Average	100	128
2	4824.50	41.75	8.64	50.39	74.00	-23.61	Peak	100	128

Notes:

1. Result = Read Value + Factor
2. Factor = Antenna Factor + Cable Loss - Amplifier
3. The resolution bandwidth of test receiver/spectrum analyzer is 120KHz and video bandwidth is 300kHz for Peak detection and Quasi-peak detection at frequency below 1GHz.
4. The resolution bandwidth of test receiver/spectrum analyzer is 1MHz and video bandwidth is 3MHz for Peak detection at frequency above 1GHz.
5. The resolution bandwidth of test receiver/spectrum analyzer is 1MHz and video bandwidth is 10Hz for Average detection at frequency above 1GHz.
6. The other emissions is too low to be measured.

Power	: AC120V	Pol/Phase	: VERTICAL
Test Mode 4	: Transmit / Receive	Temperature	: 25 °C
Operation Channel	: 6	Humidity	: 70 %
Modulation Type	: 802.11b	Atmospheric Pressure	: 1010 hPa
Memo	: RHQ-120100-1	Rate	: 11 Mbps

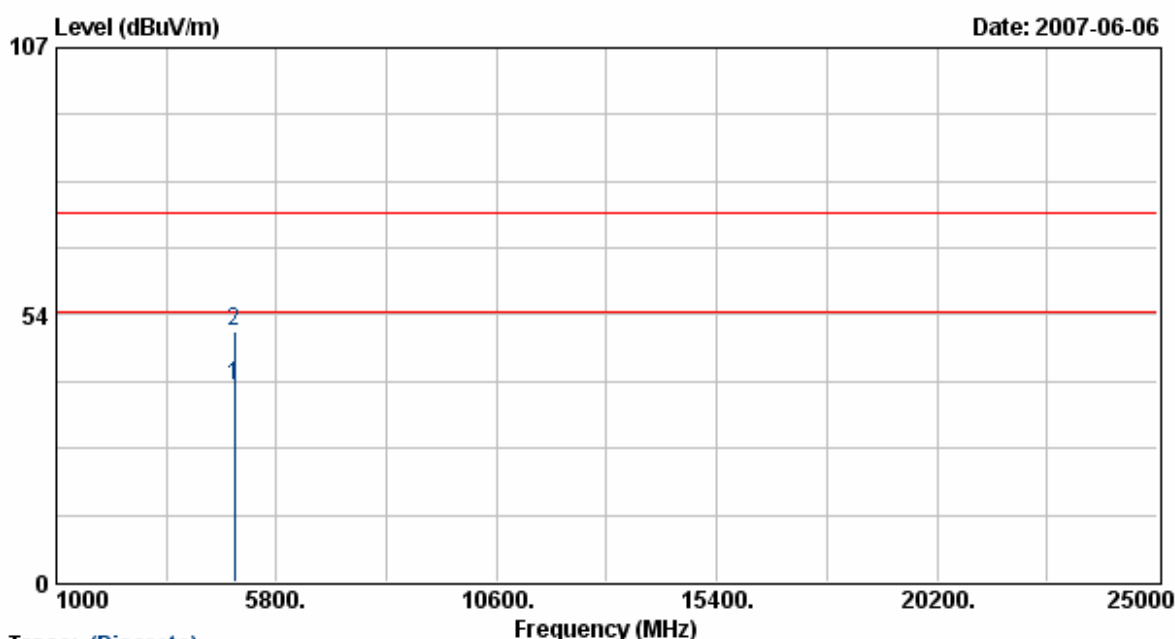

Trace: (Discrete)

Item	Freq	Read Value	Factor	Result	Limit	Margin	Remark	Ant Pos	Tab Pos
	MHz	dBuV/m	dB	dBuV/m	dBuV/m	dB		cm	Deg
1	4874.13	30.41	8.78	39.19	54.00	-14.81	Average	100	160
2	4874.13	41.55	8.78	50.33	74.00	-23.67	Peak	100	160

Notes:

1. Result = Read Value + Factor
2. Factor = Antenna Factor + Cable Loss - Amplifier
3. The resolution bandwidth of test receiver/spectrum analyzer is 120KHz and video bandwidth is 300kHz for Peak detection and Quasi-peak detection at frequency below 1GHz.
4. The resolution bandwidth of test receiver/spectrum analyzer is 1MHz and video bandwidth is 3MHz for Peak detection at frequency above 1GHz.
5. The resolution bandwidth of test receiver/spectrum analyzer is 1MHz and video bandwidth is 10Hz for Average detection at frequency above 1GHz.
6. The other emissions is too low to be measured.

Power	: AC120V	Pol/Phase	: HORIZONTAL
Test Mode 4	: Transmit / Receive	Temperature	: 25 °C
Operation Channel	: 6	Humidity	: 70 %
Modulation Type	: 802.11b	Atmospheric Pressure	: 1010 hPa
Memo	: RHQ-120100-1	Rate	: 11 Mbps

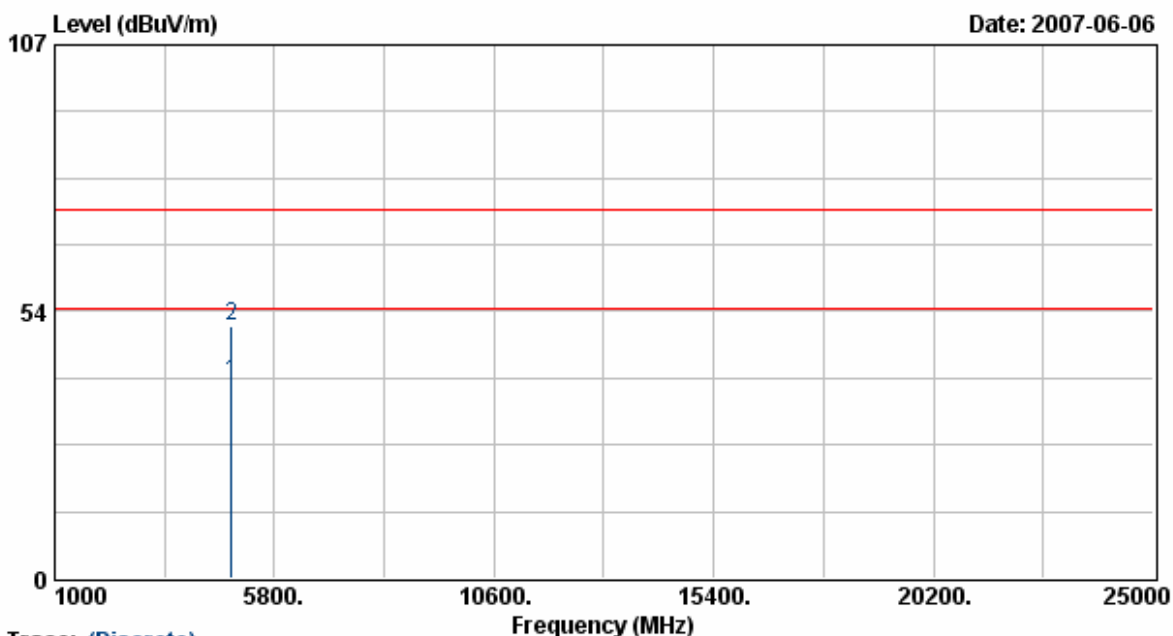

Trace: (Discrete)

Item	Freq	Read Value	Factor	Result	Limit	Margin	Remark	Ant Pos	Tab Pos
	MHz	dBuV/m	dB	dBuV/m	dBuV/m	dB		cm	Deg
1	4873.00	30.59	8.78	39.37	54.00	-14.63	Average	100	128
2	4873.00	41.77	8.78	50.55	74.00	-23.45	Peak	100	128

Notes:

1. Result = Read Value + Factor
2. Factor = Antenna Factor + Cable Loss - Amplifier
3. The resolution bandwidth of test receiver/spectrum analyzer is 120KHz and video bandwidth is 300kHz for Peak detection and Quasi-peak detection at frequency below 1GHz.
4. The resolution bandwidth of test receiver/spectrum analyzer is 1MHz and video bandwidth is 3MHz for Peak detection at frequency above 1GHz.
5. The resolution bandwidth of test receiver/spectrum analyzer is 1MHz and video bandwidth is 10Hz for Average detection at frequency above 1GHz.
6. The other emissions is too low to be measured.

Power	: AC120V	Pol/Phase	: VERTICAL
Test Mode 4	: Transmit / Receive	Temperature	: 25 °C
Operation Channel	: 11	Humidity	: 70 %
Modulation Type	: 802.11b	Atmospheric Pressure	: 1010 hPa
Memo	: RHQ-120100-1	Rate	: 11 Mbps

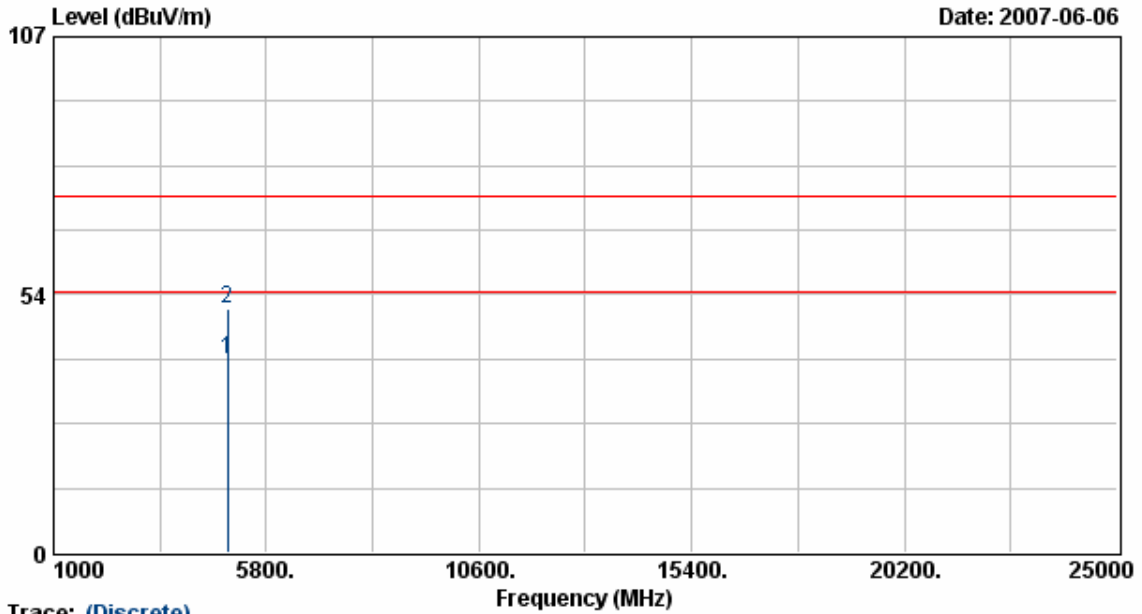

Trace: (Discrete)

Item	Freq	Read Value	Factor	Result	Limit	Margin	Remark	Ant Pos	Tab Pos
	MHz	dBuV/m	dB	dBuV/m	dBuV/m	dB		cm	Deg
1	4923.88	31.02	8.92	39.94	54.00	-14.06	Average	100	160
2	4923.88	41.76	8.92	50.68	74.00	-23.32	Peak	100	160

Notes:

1. Result = Read Value + Factor
2. Factor = Antenna Factor + Cable Loss - Amplifier
3. The resolution bandwidth of test receiver/spectrum analyzer is 120KHz and video bandwidth is 300kHz for Peak detection and Quasi-peak detection at frequency below 1GHz.
4. The resolution bandwidth of test receiver/spectrum analyzer is 1MHz and video bandwidth is 3MHz for Peak detection at frequency above 1GHz.
5. The resolution bandwidth of test receiver/spectrum analyzer is 1MHz and video bandwidth is 10Hz for Average detection at frequency above 1GHz.
6. The other emissions is too low to be measured.

Power	: AC120V	Pol/Phase	: HORIZONTAL
Test Mode 4	: Transmit / Receive	Temperature	: 25 °C
Operation Channel	: 11	Humidity	: 70 %
Modulation Type	: 802.11b	Atmospheric Pressure	: 1010 hPa
Memo	: RHQ-120100-1	Rate	: 11 Mbps

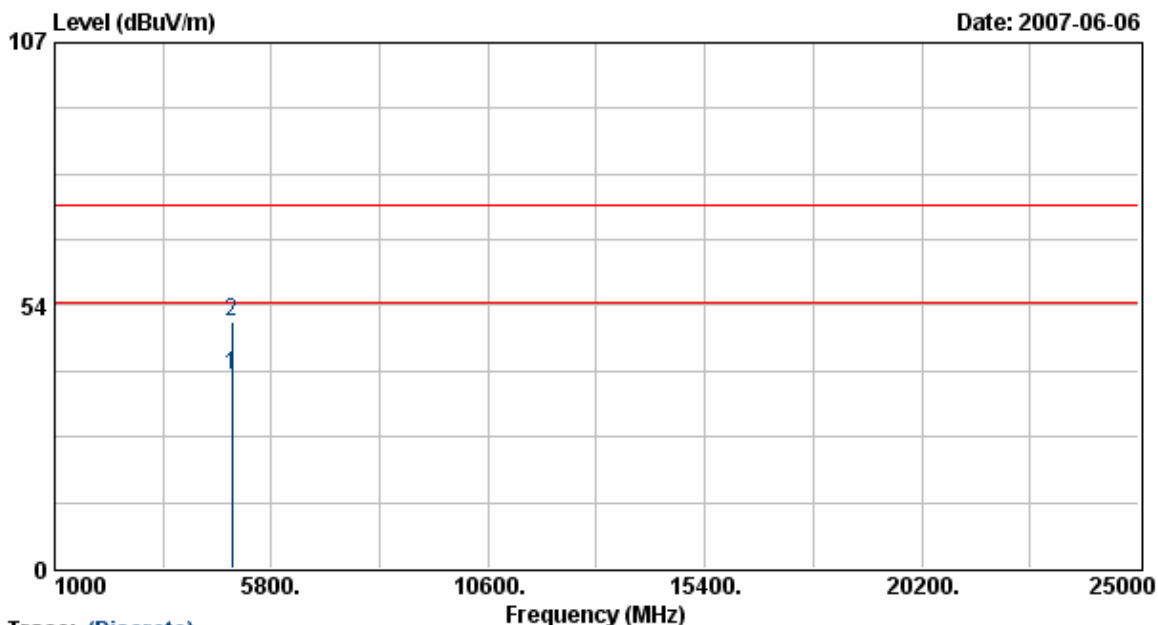

Trace: (Discrete)

Item	Freq MHz	Read Value dBuV/m	Factor dB	Result dBuV/m	Limit dBuV/m	Margin dB	Remark	Ant Pos cm	Tab Pos Deg
1	4924.25	30.27	8.92	39.19	54.00	-14.81	Average	100	128
2	4924.25	41.09	8.92	50.01	74.00	-23.99	Peak	100	128

Notes:

1. Result = Read Value + Factor
2. Factor = Antenna Factor + Cable Loss - Amplifier
3. The resolution bandwidth of test receiver/spectrum analyzer is 120KHz and video bandwidth is 300kHz for Peak detection and Quasi-peak detection at frequency below 1GHz.
4. The resolution bandwidth of test receiver/spectrum analyzer is 1MHz and video bandwidth is 3MHz for Peak detection at frequency above 1GHz.
5. The resolution bandwidth of test receiver/spectrum analyzer is 1MHz and video bandwidth is 10Hz for Average detection at frequency above 1GHz.
6. The other emissions is too low to be measured.

Power	: AC120V	Pol/Phase	: VERTICAL
Test Mode 4	: Transmit / Receive	Temperature	: 25 °C
Operation Channel	: 1	Humidity	: 70 %
Modulation Type	: 802.11g	Atmospheric Pressure	: 1010 hPa
Memo	: RHQ-120100-1	Rate	: 12 Mbps

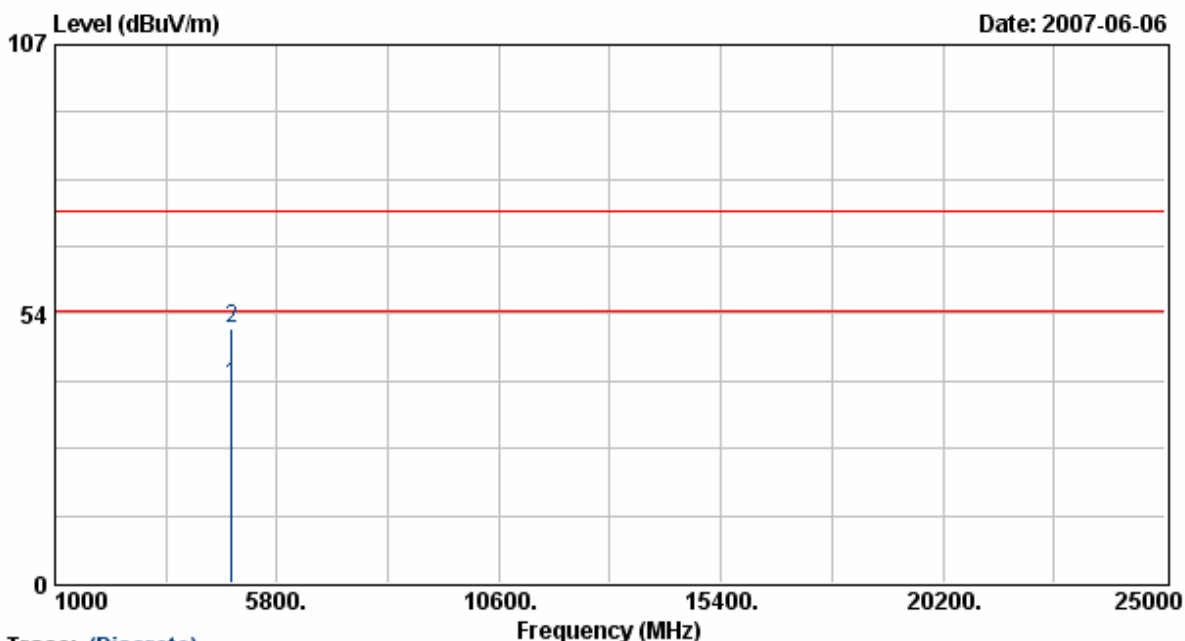

Trace: (Discrete)

Item	Freq	Read Value	Factor	Result	Limit	Margin	Remark	Ant Pos	Tab Pos
	MHz	dBuV/m	dB	dBuV/m	dBuV/m	dB		cm	Deg
1	4824.13	30.77	8.64	39.41	54.00	-14.59	Average	100	160
2	4824.13	41.80	8.64	50.44	74.00	-23.56	Peak	100	160

Notes:

1. Result = Read Value + Factor
2. Factor = Antenna Factor + Cable Loss - Amplifier
3. The resolution bandwidth of test receiver/spectrum analyzer is 120KHz and video bandwidth is 300kHz for Peak detection and Quasi-peak detection at frequency below 1GHz.
4. The resolution bandwidth of test receiver/spectrum analyzer is 1MHz and video bandwidth is 3MHz for Peak detection at frequency above 1GHz.
5. The resolution bandwidth of test receiver/spectrum analyzer is 1MHz and video bandwidth is 10Hz for Average detection at frequency above 1GHz.
6. The other emissions is too low to be measured.



Power	: AC120V	Pol/Phase	: HORIZONTAL
Test Mode 4	: Transmit / Receive	Temperature	: 25 °C
Operation Channel	: 1	Humidity	: 70 %
Modulation Type	: 802.11g	Atmospheric Pressure	: 1010 hPa
Memo	: RHQ-120100-1	Rate	: 12 Mbps

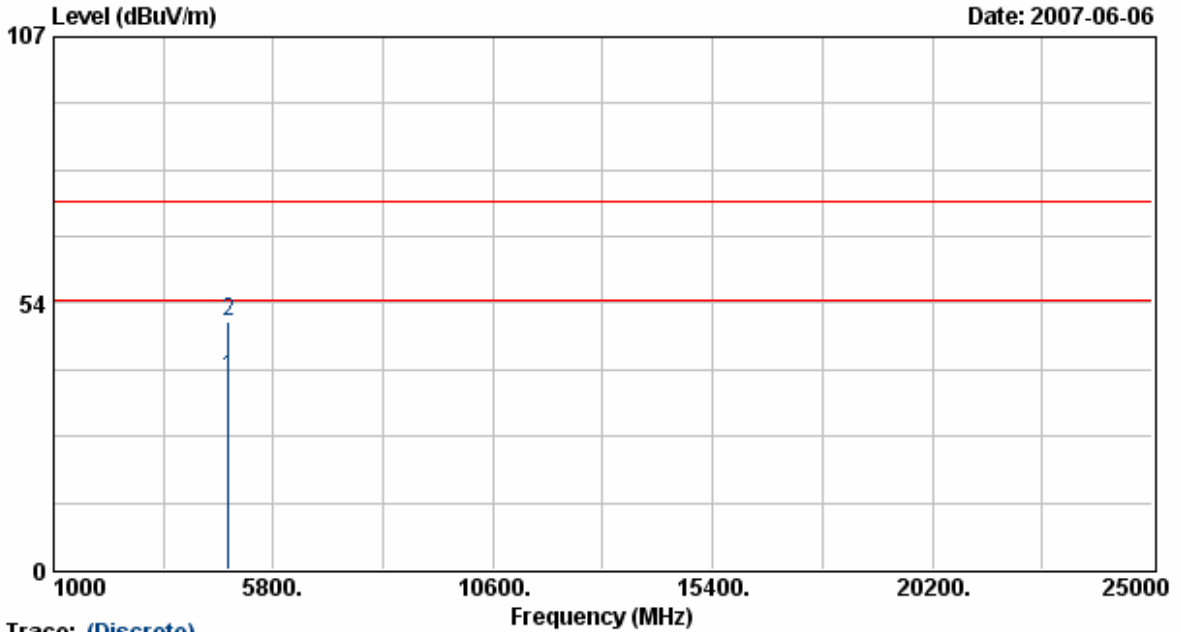

Trace: (Discrete)

Item	Freq	Read Value	Factor	Result	Limit	Margin	Remark	Ant Pos	Tab Pos
	MHz	dBuV/m	dB	dBuV/m	dBuV/m	dB		cm	Deg
1	4824.00	30.07	8.64	38.71	54.00	-15.29	Average	100	128
2	4824.00	41.27	8.64	49.91	74.00	-24.09	Peak	100	128

Notes:

1. Result = Read Value + Factor
2. Factor = Antenna Factor + Cable Loss - Amplifier
3. The resolution bandwidth of test receiver/spectrum analyzer is 120KHz and video bandwidth is 300kHz for Peak detection and Quasi-peak detection at frequency below 1GHz.
4. The resolution bandwidth of test receiver/spectrum analyzer is 1MHz and video bandwidth is 3MHz for Peak detection at frequency above 1GHz.
5. The resolution bandwidth of test receiver/spectrum analyzer is 1MHz and video bandwidth is 10Hz for Average detection at frequency above 1GHz.
6. The other emissions is too low to be measured.

Power	: AC120V	Pol/Phase	: VERTICAL
Test Mode 4	: Transmit / Receive	Temperature	: 25 °C
Operation Channel	: 6	Humidity	: 70 %
Modulation Type	: 802.11g	Atmospheric Pressure	: 1010 hPa
Memo	: RHQ-120100-1	Rate	: 12 Mbps

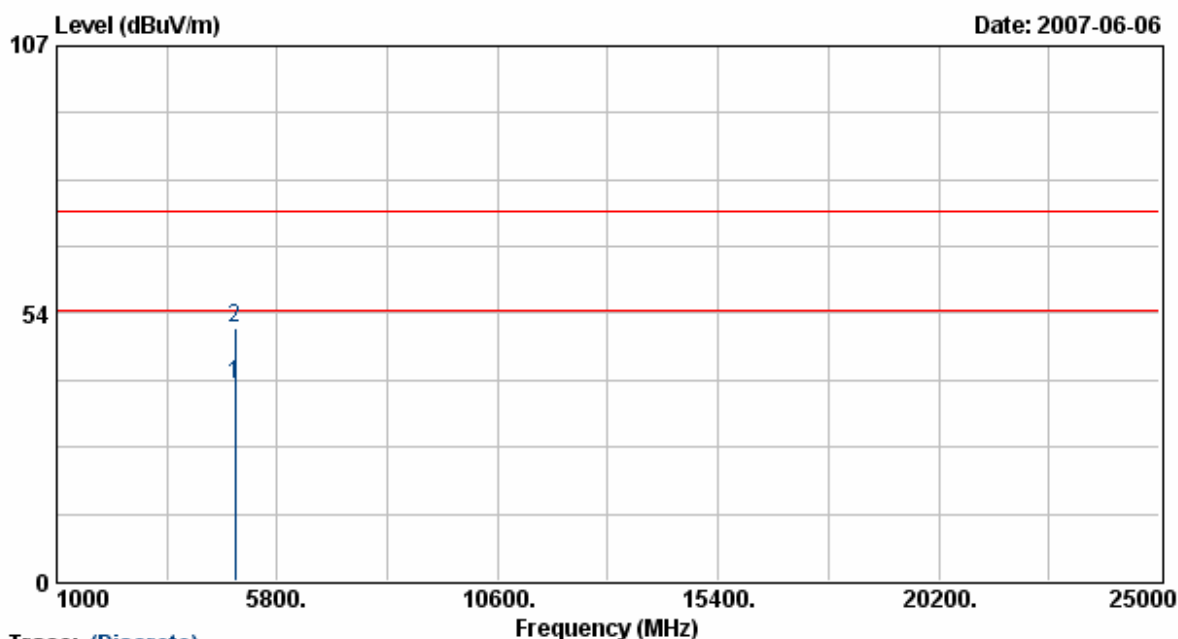

Trace: (Discrete)

Item	Freq	Read Value	Factor	Result	Limit	Margin	Remark	Ant Pos	Tab Pos
	MHz	dBuV/m	dB	dBuV/m	dBuV/m	dB		cm	Deg
1	4873.38	30.47	8.78	39.25	54.00	-14.75	Average	100	160
2	4873.38	41.65	8.78	50.43	74.00	-23.57	Peak	100	160

Notes:

1. Result = Read Value + Factor
2. Factor = Antenna Factor + Cable Loss - Amplifier
3. The resolution bandwidth of test receiver/spectrum analyzer is 120KHz and video bandwidth is 300kHz for Peak detection and Quasi-peak detection at frequency below 1GHz.
4. The resolution bandwidth of test receiver/spectrum analyzer is 1MHz and video bandwidth is 3MHz for Peak detection at frequency above 1GHz.
5. The resolution bandwidth of test receiver/spectrum analyzer is 1MHz and video bandwidth is 10Hz for Average detection at frequency above 1GHz.
6. The other emissions is too low to be measured.

Power	: AC120V	Pol/Phase	: HORIZONTAL
Test Mode 4	: Transmit / Receive	Temperature	: 25 °C
Operation Channel	: 6	Humidity	: 70 %
Modulation Type	: 802.11g	Atmospheric Pressure	: 1010 hPa
Memo	: RHQ-120100-1	Rate	: 12 Mbps

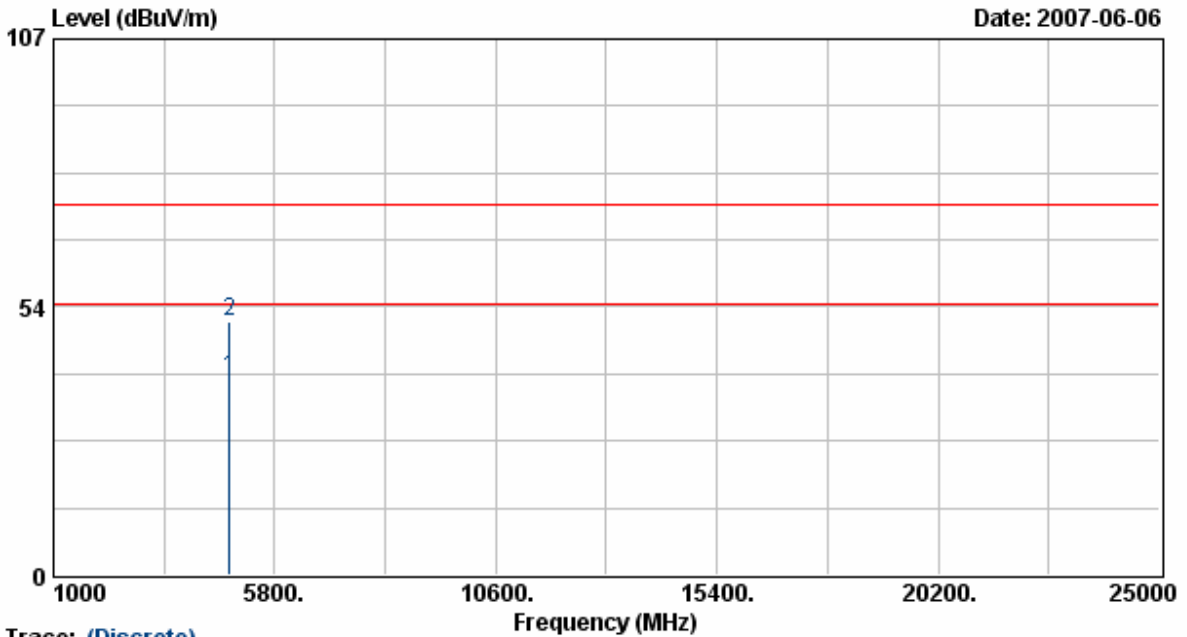

Trace: (Discrete)

Item	Freq	Read Value	Factor	Result	Limit	Margin	Remark	Ant Pos	Tab Pos
	MHz	dBuV/m	dB	dBuV/m	dBuV/m	dB		cm	Deg
1	4824.13	30.77	8.64	39.41	54.00	-14.59	Average	100	160
2	4824.13	41.80	8.64	50.44	74.00	-23.56	Peak	100	160

Notes:

1. Result = Read Value + Factor
2. Factor = Antenna Factor + Cable Loss - Amplifier
3. The resolution bandwidth of test receiver/spectrum analyzer is 120KHz and video bandwidth is 300kHz for Peak detection and Quasi-peak detection at frequency below 1GHz.
4. The resolution bandwidth of test receiver/spectrum analyzer is 1MHz and video bandwidth is 3MHz for Peak detection at frequency above 1GHz.
5. The resolution bandwidth of test receiver/spectrum analyzer is 1MHz and video bandwidth is 10Hz for Average detection at frequency above 1GHz.
6. The other emissions is too low to be measured.

Power	: AC120V	Pol/Phase	: VERTICAL
Test Mode 4	: Transmit / Receive	Temperature	: 25 °C
Operation Channel	: 11	Humidity	: 70 %
Modulation Type	: 802.11g	Atmospheric Pressure	: 1010 hPa
Memo	: RHQ-120100-1	Rate	: 12 Mbps

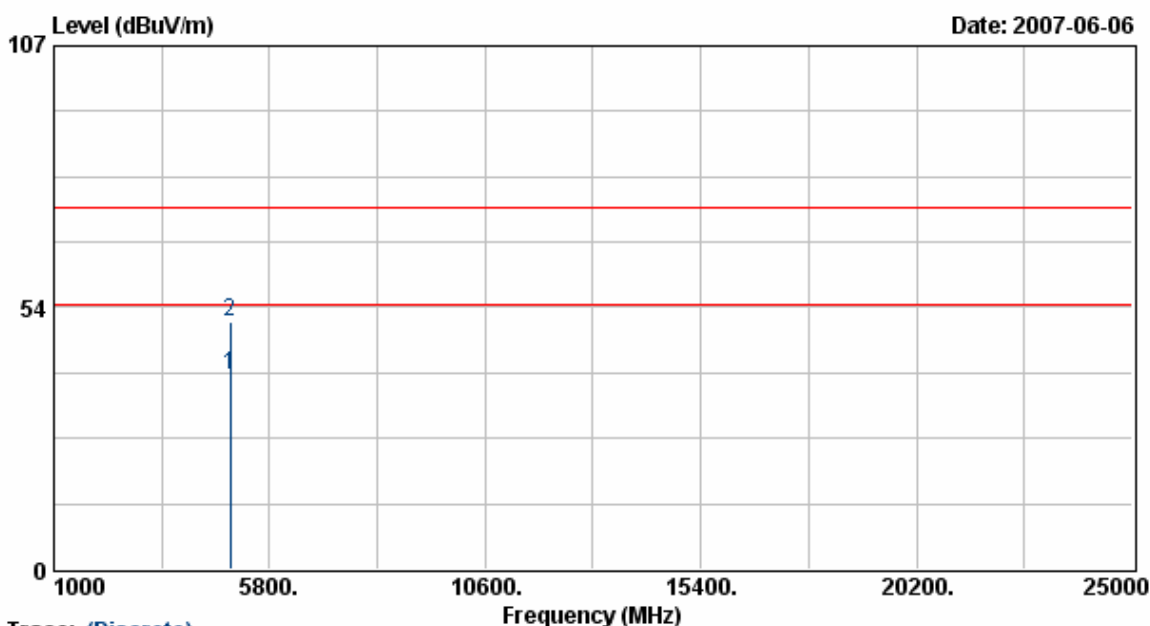

Trace: (Discrete)

Item	Freq	Read Value	Factor	Result	Limit	Margin	Remark	Ant Pos	Tab Pos
	MHz	dBuV/m	dB	dBuV/m	dBuV/m	dB		cm	Deg
1	4924.00	30.57	8.92	39.49	54.00	-14.51	Average	100	160
2	4924.00	41.66	8.92	50.58	74.00	-23.42	Peak	100	160

Notes:

1. Result = Read Value + Factor
2. Factor = Antenna Factor + Cable Loss - Amplifier
3. The resolution bandwidth of test receiver/spectrum analyzer is 120KHz and video bandwidth is 300kHz for Peak detection and Quasi-peak detection at frequency below 1GHz.
4. The resolution bandwidth of test receiver/spectrum analyzer is 1MHz and video bandwidth is 3MHz for Peak detection at frequency above 1GHz.
5. The resolution bandwidth of test receiver/spectrum analyzer is 1MHz and video bandwidth is 10Hz for Average detection at frequency above 1GHz.
6. The other emissions is too low to be measured.

Power	: AC120V	Pol/Phase	: HORIZONTAL
Test Mode 4	: Transmit / Receive	Temperature	: 25 °C
Operation Channel	: 11	Humidity	: 70 %
Modulation Type	: 802.11g	Atmospheric Pressure	: 1010 hPa
Memo	: RHQ-120100-1	Rate	: 12 Mbps

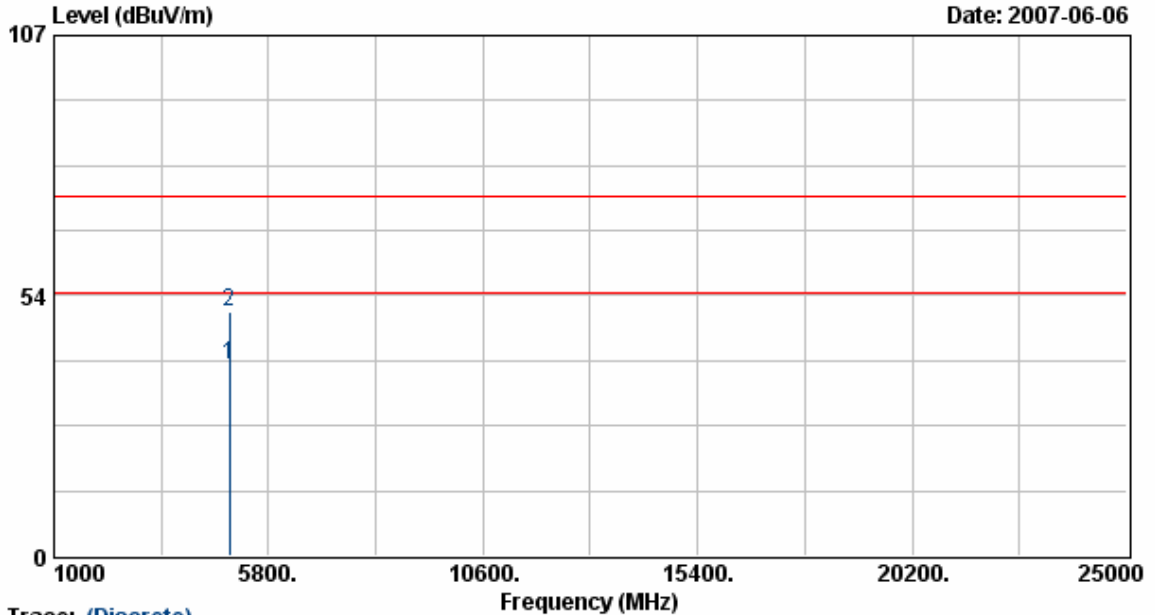

Trace: (Discrete)

Item	Freq	Read Value	Factor	Result	Limit	Margin	Remark	Ant Pos	Tab Pos
	MHz	dBuV/m	dB	dBuV/m	dBuV/m	dB		cm	Deg
1	4923.50	30.36	8.92	39.28	54.00	-14.72	Average	100	128
2	4923.50	41.37	8.92	50.29	74.00	-23.71	Peak	100	128

Notes:

1. Result = Read Value + Factor
2. Factor = Antenna Factor + Cable Loss - Amplifier
3. The resolution bandwidth of test receiver/spectrum analyzer is 120KHz and video bandwidth is 300kHz for Peak detection and Quasi-peak detection at frequency below 1GHz.
4. The resolution bandwidth of test receiver/spectrum analyzer is 1MHz and video bandwidth is 3MHz for Peak detection at frequency above 1GHz.
5. The resolution bandwidth of test receiver/spectrum analyzer is 1MHz and video bandwidth is 10Hz for Average detection at frequency above 1GHz.
6. The other emissions is too low to be measured.

Test engineer: Ben

## 6. 6dB Bandwidth Measurement Data

### 6.1 Test Limit

The minimum of 6dB Bandwidth Measurement is 0.5 MHz.

### 6.2 Test Procedures

1. The transmitter output was connected to the spectrum analyzer.
2. Set RBW of spectrum analyzer to 100 KHz and VBW to 100 KHz.
3. The 6 dB bandwidth is defined as the total spectrum the power of which is higher than peak power minus 6 dB.

### 6.3 Test Setup Layout

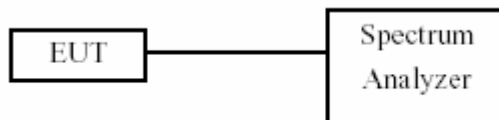

### 6.4 Measurement equipment

Instrument/Ancillary	Model No.	Manufacturer	Serial No.	Calibration Date	Valid Date.
Spectrum Analyzer	FSP40	R&S	100047	2007/01/23	2008/01/22

### 6.5 Test Result and Data

#### (1) Test Mode 1:

Modulation Standard: IEEE 802.11b (11Mbps)

Test Date: May. 21, 2007 Temperature: 25 Humidity: 68% Atmospheric pressure: 1010 hPa

Channel	Frequency (MHz)	6dB Bandwidth (MHz)
01	2412	11.9
06	2437	12.0
11	2462	12.0

#### (2) Test Mode 1:

Modulation Standard: IEEE 802.11g (12Mbps)

Test Date: May. 21, 2007 Temperature: 25 Humidity: 68% Atmospheric pressure: 1010 hPa

Channel	Frequency (MHz)	6dB Bandwidth (MHz)
01	2412	16.4
06	2437	16.4
11	2462	16.5

#### (3) Test Mode 2:

Modulation Standard: IEEE 802.11b (11Mbps)

Test Date: May. 21, 2007 Temperature: 25 Humidity: 68% Atmospheric pressure: 1010 hPa

Channel	Frequency (MHz)	6dB Bandwidth (MHz)
01	2412	12.0
06	2437	12.0
11	2462	12.0

#### (4) Test Mode 2:

Modulation Standard: IEEE 802.11g (12Mbps)

Test Date: May. 21, 2007 Temperature: 25 Humidity: 68% Atmospheric pressure: 1010 hPa

Channel	Frequency (MHz)	6dB Bandwidth (MHz)
01	2412	16.4
06	2437	16.4
11	2462	16.5

Test Mode 1: Modulation Standard: 802.11b (11Mbps)  
Channel: 01

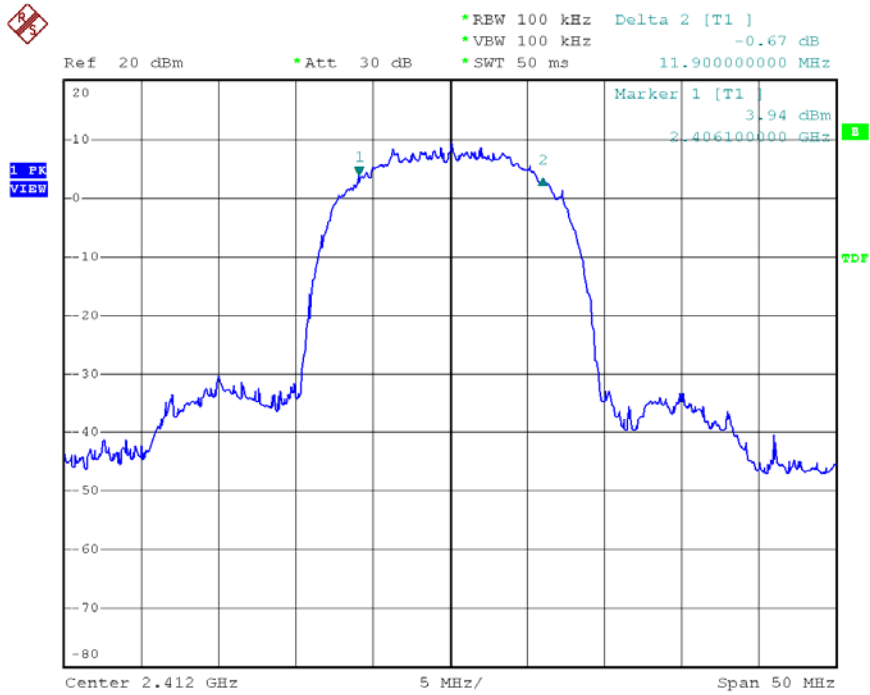

Date: 21.MAY.2007 14:13:38

Test Mode 1: Modulation Standard: 802.11b (11Mbps)  
Channel: 06

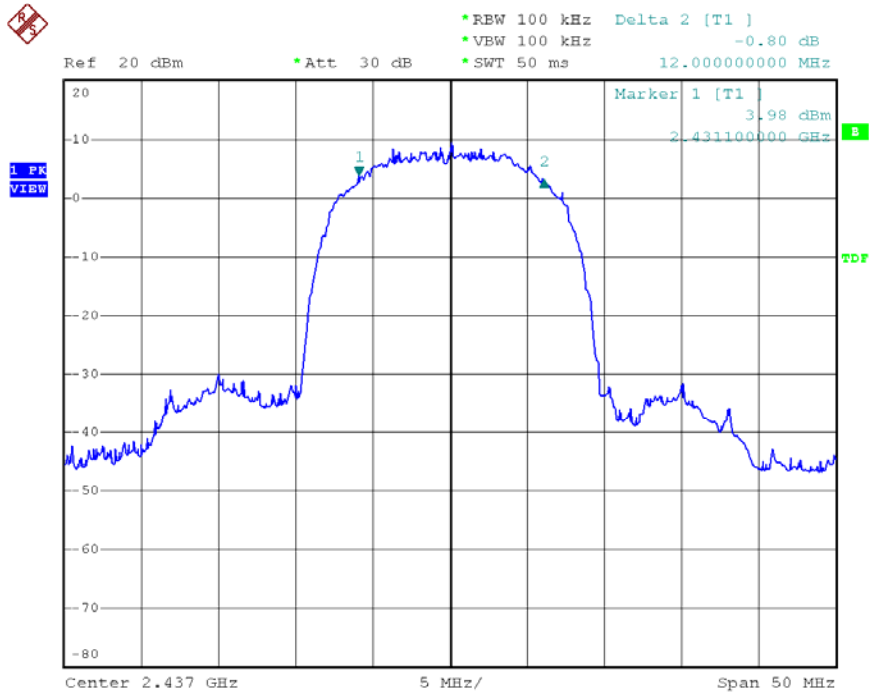

Date: 21.MAY.2007 14:15:53

Test Mode 1: Modulation Standard: 802.11b (11Mbps)  
 Channel: 11

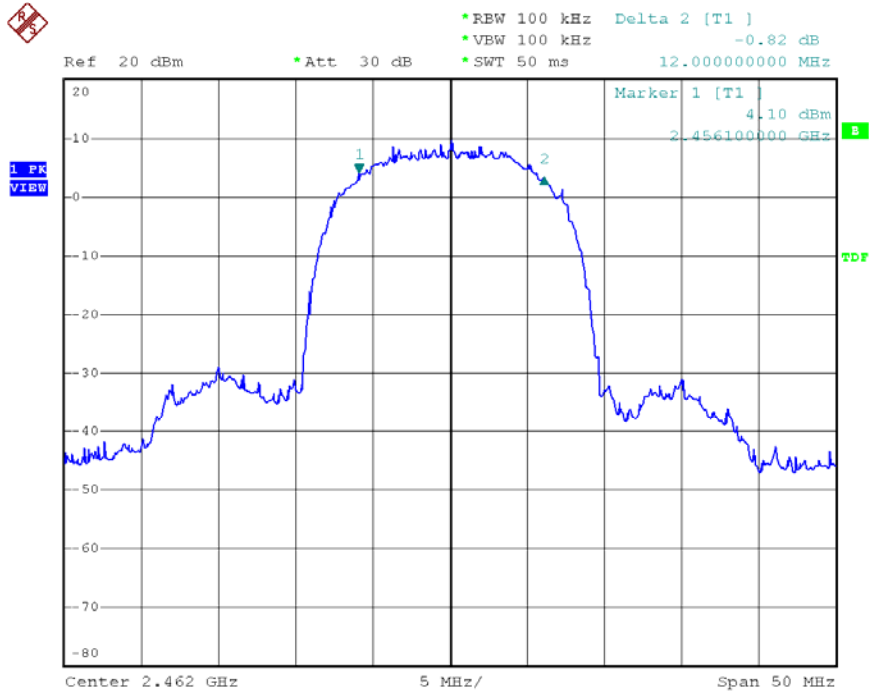

Date: 21.MAY.2007 14:17:33

Test Mode 1: Modulation Standard: 802.11g (12Mbps)  
 Channel: 01

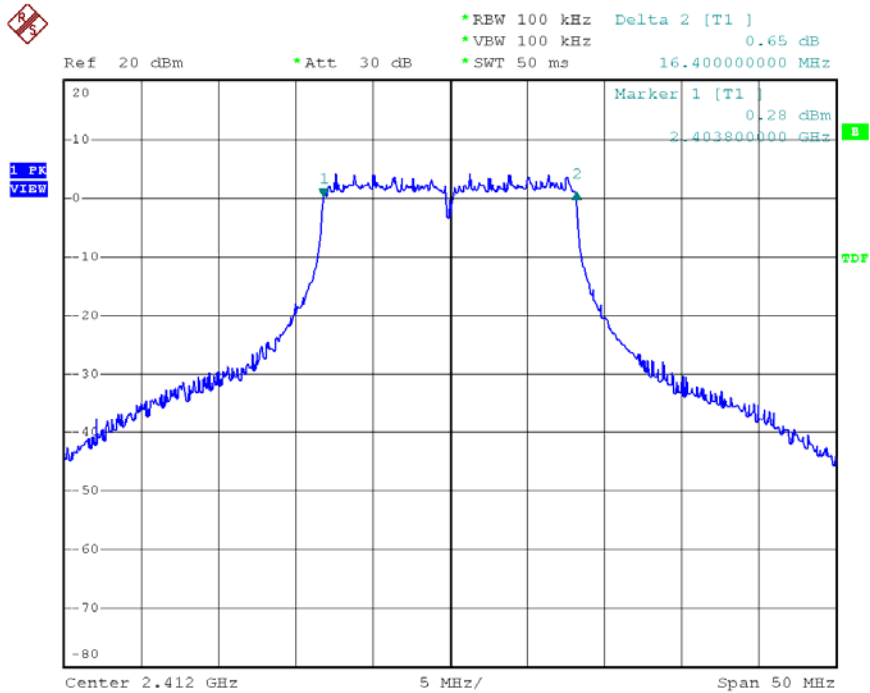

Date: 21.MAY.2007 14:24:34



Test Mode 1: Modulation Standard: 802.11g (12Mbps)  
Channel: 06

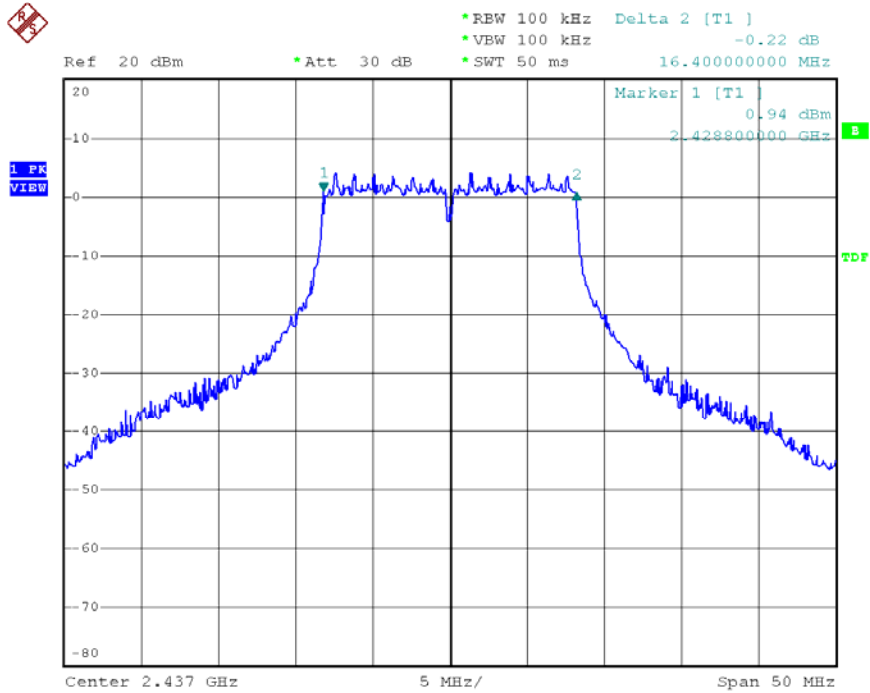

Date: 21.MAY.2007 14:34:42

Test Mode 1: Modulation Standard: 802.11g (12Mbps)  
Channel: 11

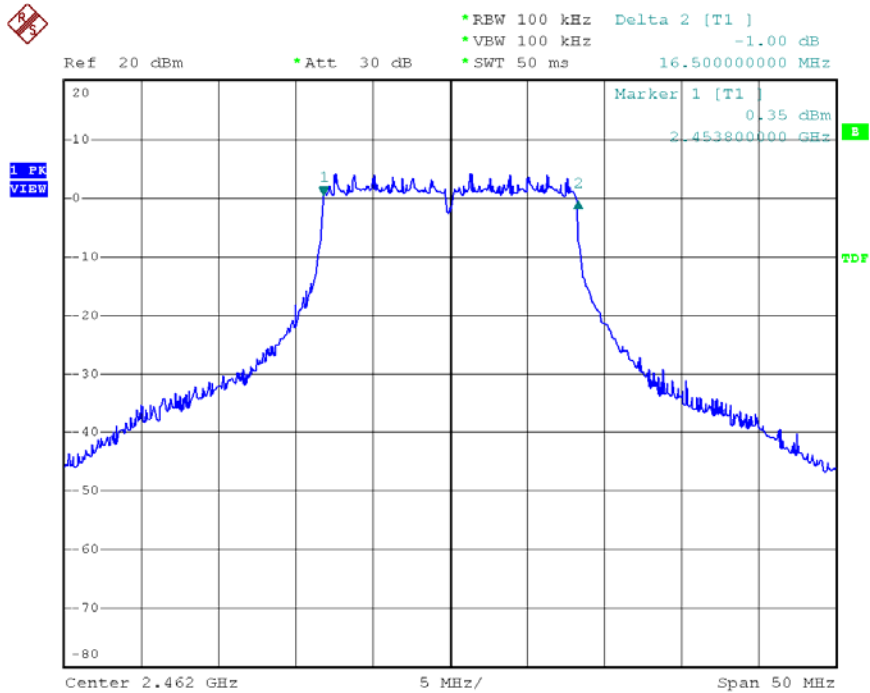

Date: 21.MAY.2007 14:37:43

Test Mode 2: Modulation Standard: 802.11b (11Mbps)  
Channel: 01

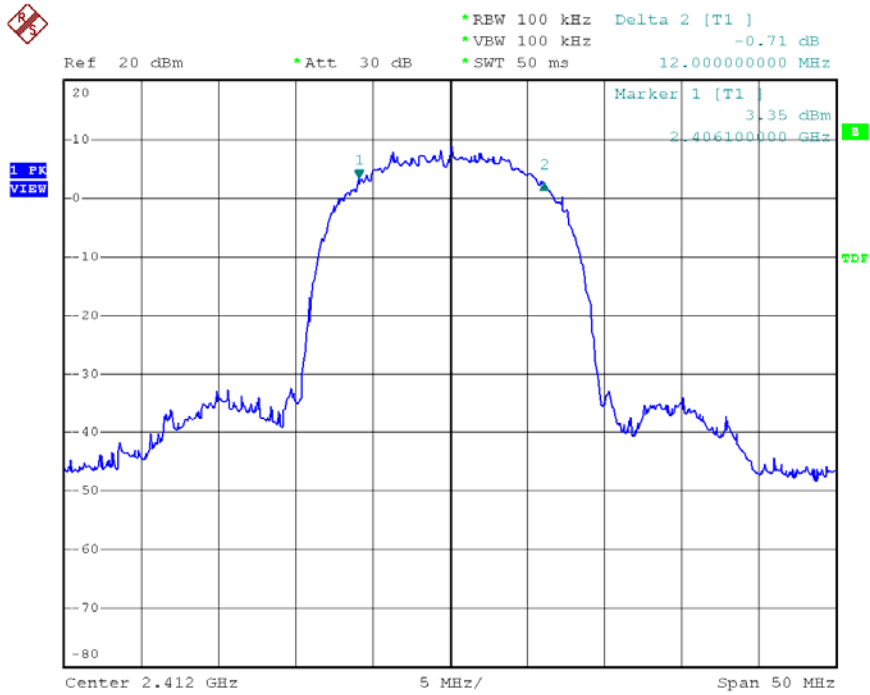

Date: 21.MAY.2007 11:21:02

Test Mode 2: Modulation Standard: 802.11b (11Mbps)  
Channel: 06

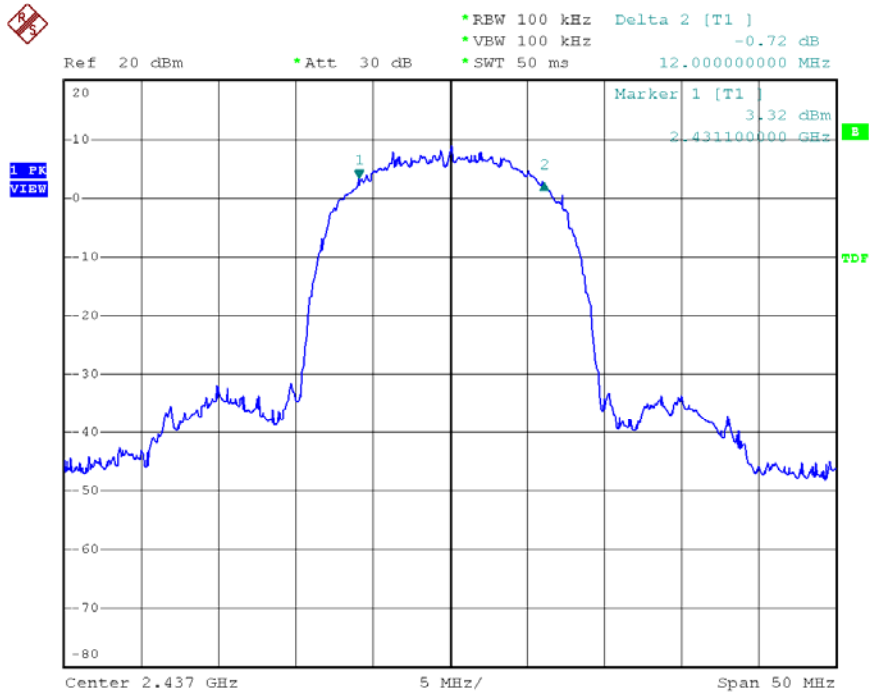

Date: 21.MAY.2007 11:22:33

Test Mode 2: Modulation Standard: 802.11b (11Mbps)  
 Channel: 11

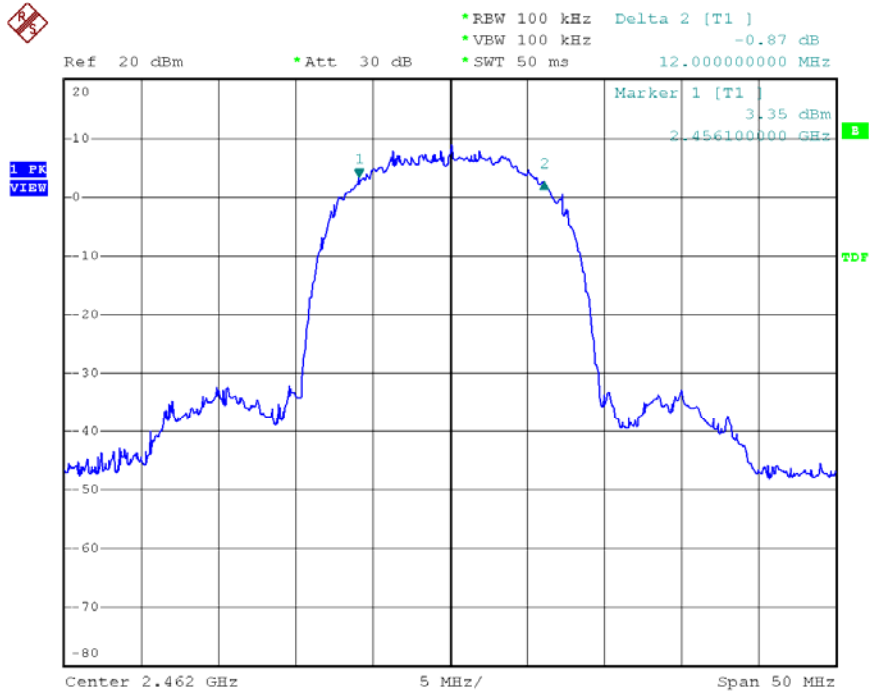

Date: 21.MAY.2007 11:23:53

Test Mode 2: Modulation Standard: 802.11g (12Mbps)  
 Channel: 01

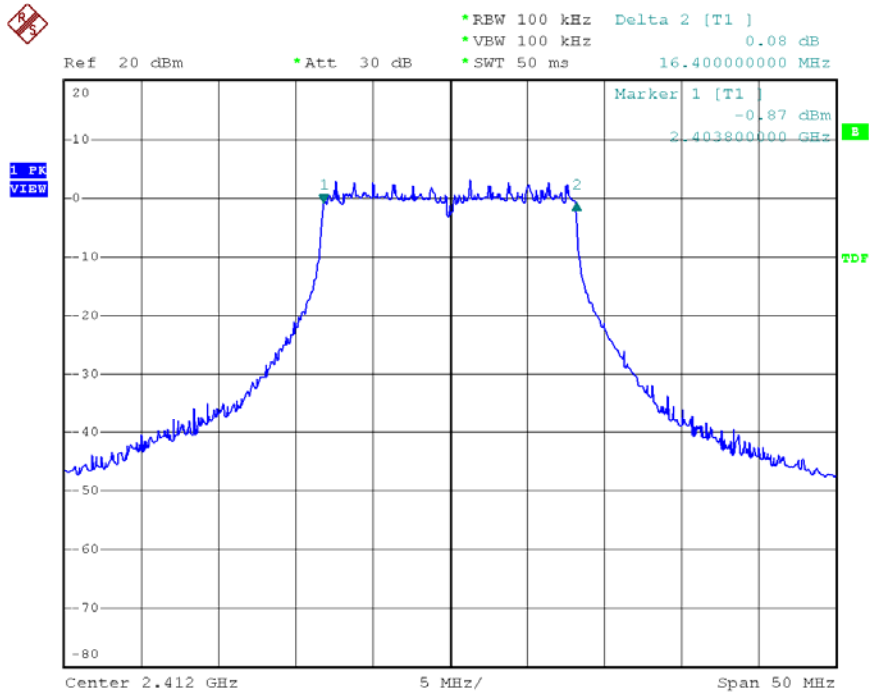

Date: 21.MAY.2007 11:25:24

Test Mode 2: Modulation Standard: 802.11g (12Mbps)  
 Channel: 06

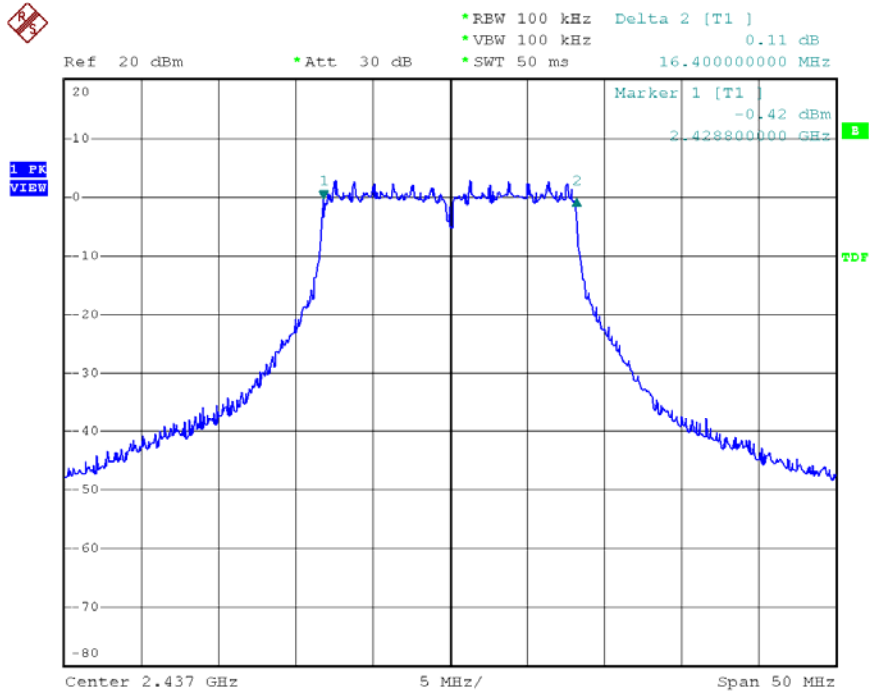

Date: 21.MAY.2007 11:26:55

Test Mode 2: Modulation Standard: 802.11g (12Mbps)  
 Channel: 11

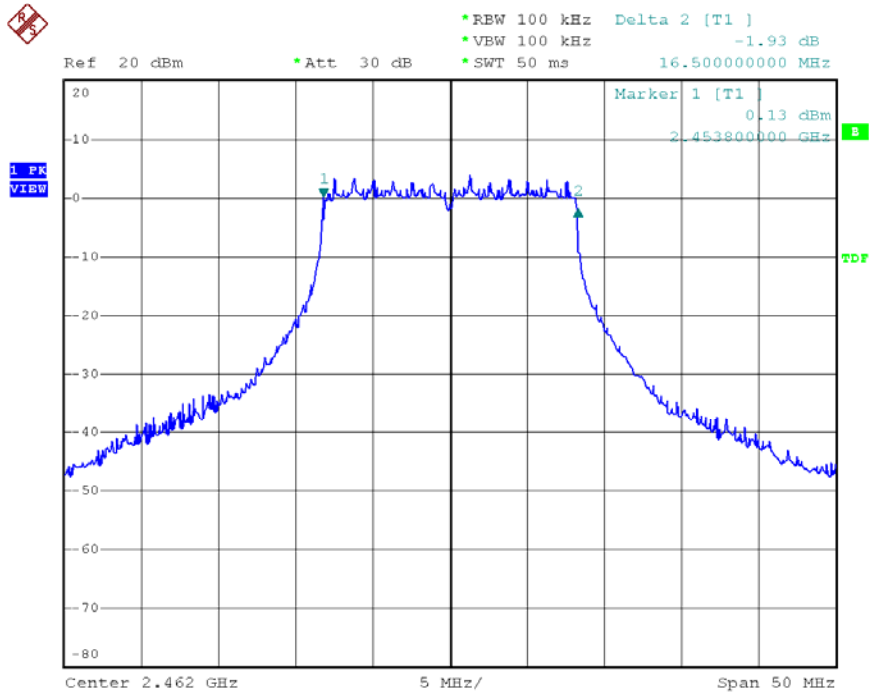

Date: 21.MAY.2007 11:28:47

## 7. Maximum Peak Output Power

### 7.1 Test Limit

The Maximum Peak Output Power Measurement is 30dBm.

### 7.2 Test Procedures

The antenna port( RF output )of the EUT was connected to the input( RF input )of a power meter. Power was read directly from the meter and cable loss connection was added to the reading to obtain power at the EUT antenna terminal. The EUT Output Power was set to maximum to produce the worse case test result.

### 7.3 Test Setup Layout

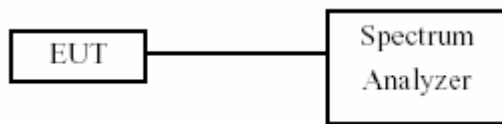

### 7.4 Measurement equipment

Instrument/Ancillary	Model No.	Manufacturer	Serial No.	Calibration Date	Valid Date.
Spectrum Analyzer	FSP40	R&S	100047	2007/01/23	2008/01/22

### 7.5 Test Result and Data

#### (1) Test Mode 1:

Modulation Standard: IEEE 802.11b (11Mbps)

Test Date: May. 21, 2007 Temperature: 25 Humidity: 68% Atmospheric pressure: 1010 hPa

Channel	Frequency (MHz)	Peak Power Output (dBm)	Peak Power Output (mW)
01	2412	24.80	302.0
06	2437	24.83	304.1
11	2462	24.78	300.6

#### (2) Test Mode 1:

Modulation Standard: IEEE 802.11g (12Mbps)

Test Date: May. 21, 2007 Temperature: 25 Humidity: 68% Atmospheric pressure: 1010 hPa

Channel	Frequency (MHz)	Peak Power Output (dBm)	Peak Power Output (mW)
01	2412	23.79	239.3
06	2437	23.89	244.9
11	2462	23.87	243.8

## (3) Test Mode 2:

Modulation Standard: IEEE 802.11b (11Mbps)

Test Date: May. 21, 2007 Temperature: 25 Humidity: 68% Atmospheric pressure: 1010 hPa

Channel	Frequency (MHz)	Peak Power Output (dBm)	Peak Power Output (mW)
01	2412	24.85	305.5
06	2437	24.80	302.0
11	2462	24.71	295.8

## (4) Test Mode 2:

Modulation Standard: IEEE 802.11g (12Mbps)

Test Date: May. 21, 2007 Temperature: 25 Humidity: 68% Atmospheric pressure: 1010 hPa

Channel	Frequency (MHz)	Peak Power Output (dBm)	Peak Power Output (mW)
01	2412	23.87	243.8
06	2437	23.90	245.5
11	2462	23.95	248.3

Test Mode 1: Modulation Standard: 802.11b (11Mbps)  
Channel: 01

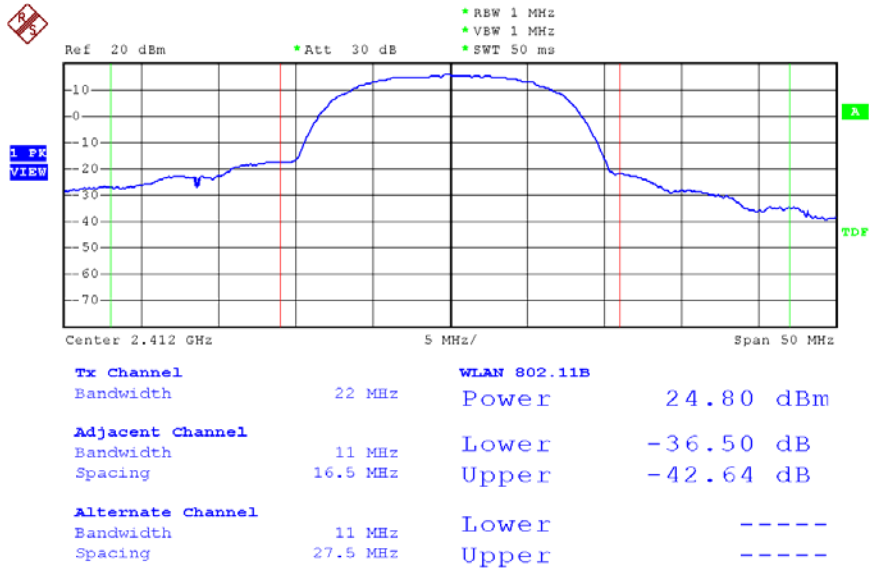

Date: 21.MAY.2007 16:06:34

Test Mode 1: Modulation Standard: 802.11b (11Mbps)  
Channel: 06

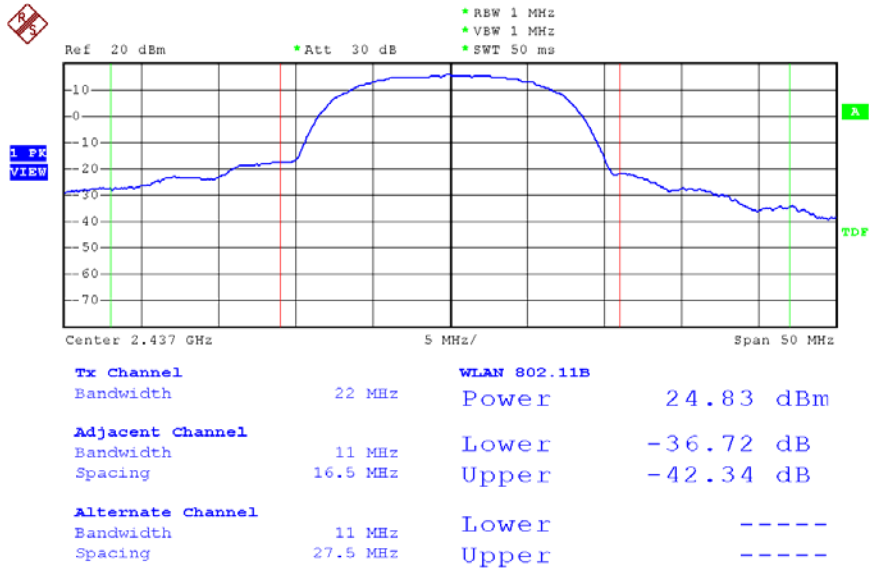

Date: 21.MAY.2007 16:05:44

Test Mode 1: Modulation Standard: 802.11b (11Mbps)  
Channel: 11

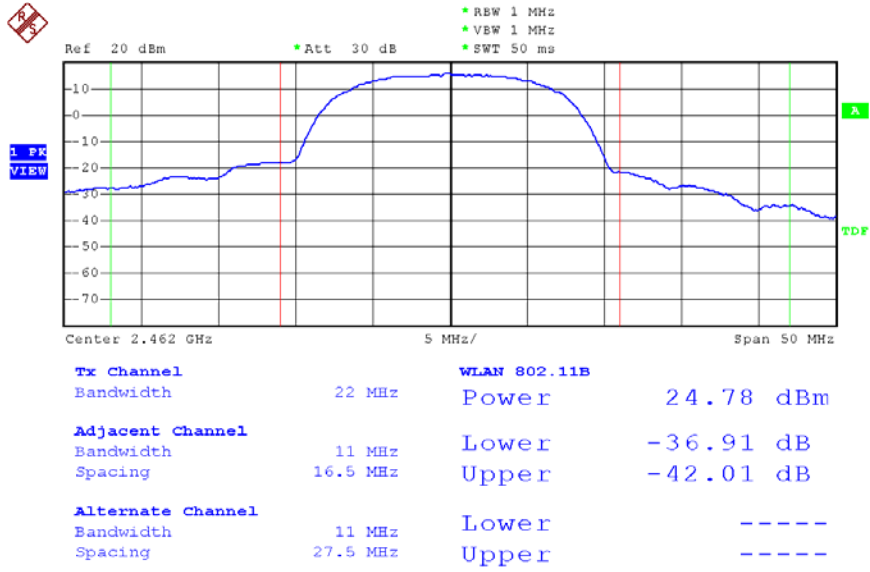

Date: 21.MAY.2007 16:07:10

Test Mode 1: Modulation Standard: 802.11g (12Mbps)  
Channel: 01

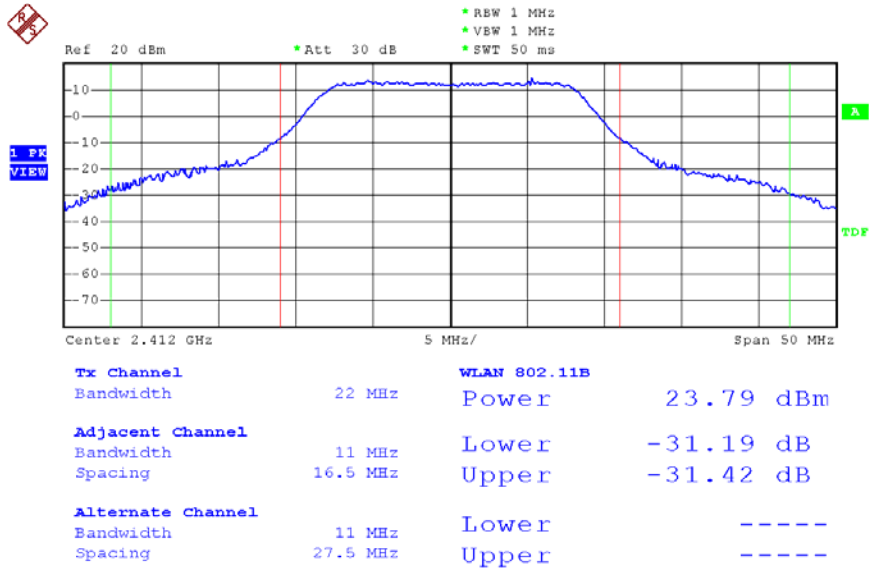

Date: 21.MAY.2007 16:09:36



Test Mode 1: Modulation Standard: 802.11g (12Mbps)  
Channel: 06

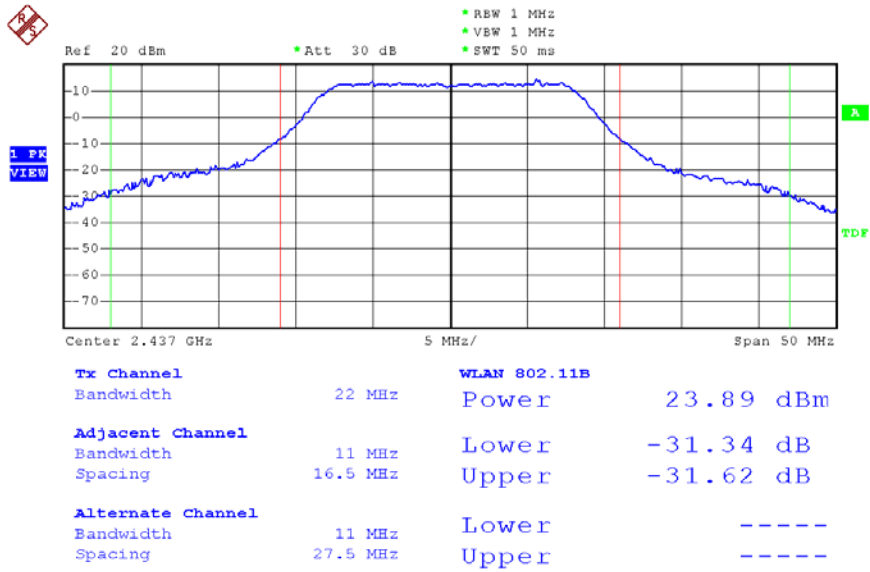

Date: 21.MAY.2007 16:10:20

Test Mode 1: Modulation Standard: 802.11g (12Mbps)  
Channel: 11

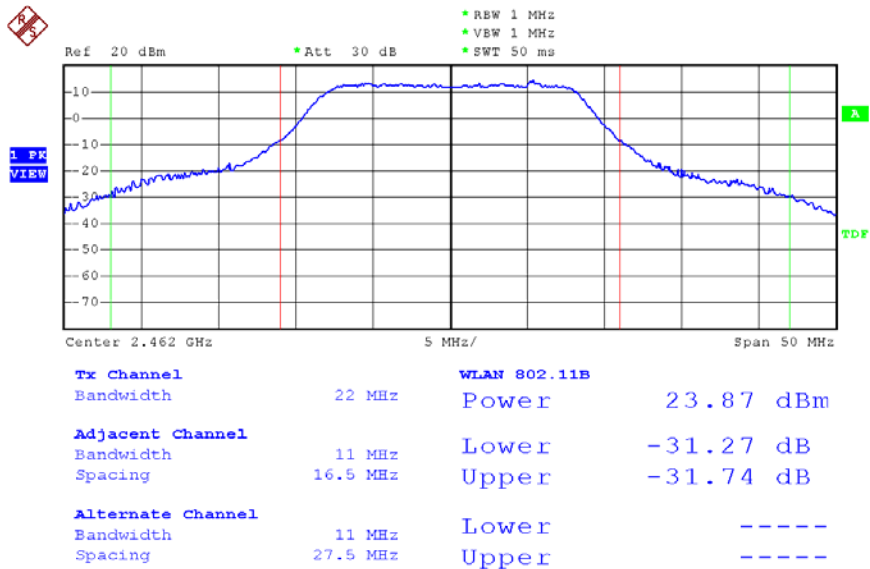

Date: 21.MAY.2007 16:11:09

Test Mode 2: Modulation Standard: 802.11b (11Mbps)  
Channel: 01

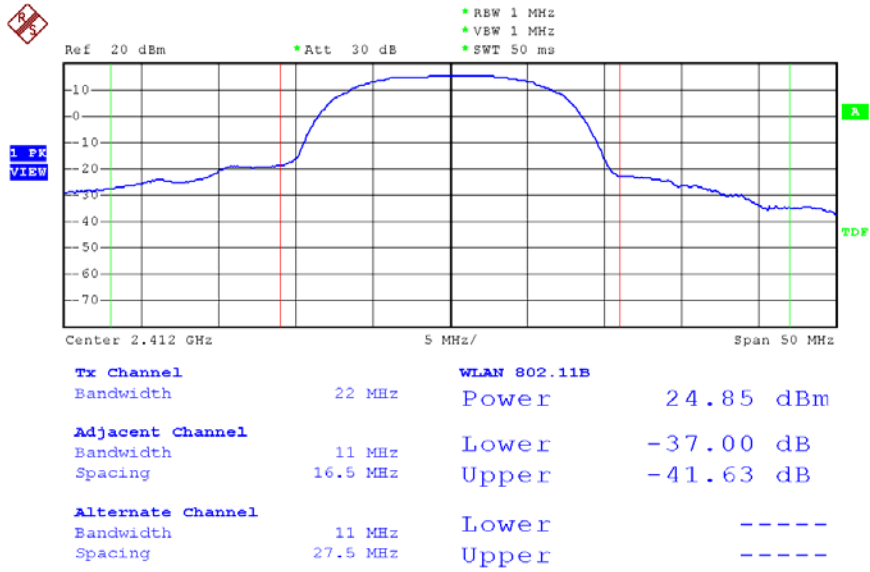

Date: 21.MAY.2007 11:14:25

Test Mode 2: Modulation Standard: 802.11b (11Mbps)  
Channel: 06

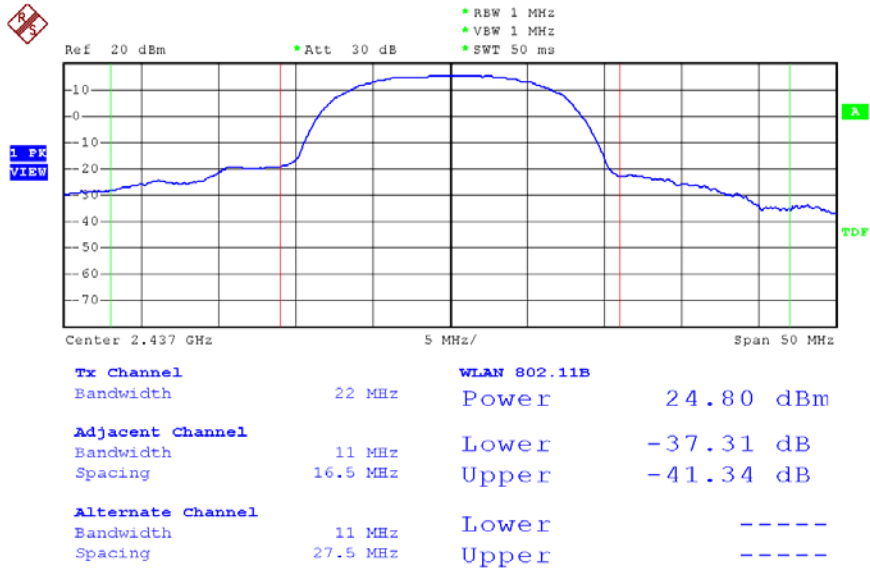

Date: 21.MAY.2007 11:15:09

Test Mode 2: Modulation Standard: 802.11b (11Mbps)  
Channel: 11

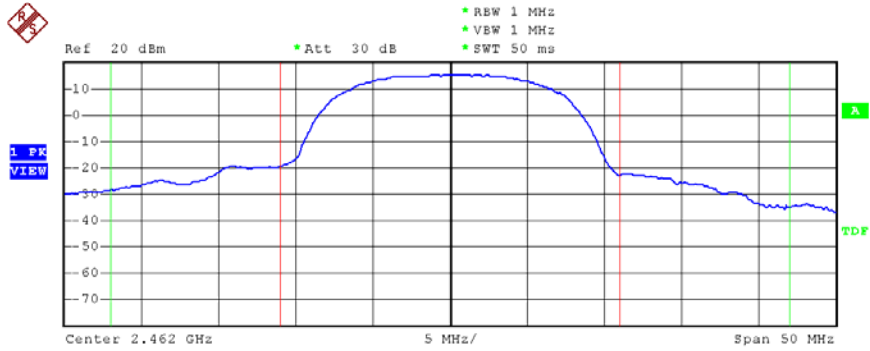

<b>Tx Channel</b>		<b>WLAN 802.11B</b>	
Bandwidth	22 MHz	Power	24.71 dBm
<b>Adjacent Channel</b>		Lower	-37.52 dB
Bandwidth	11 MHz	Upper	-41.10 dB
Spacing	16.5 MHz		
<b>Alternate Channel</b>		Lower	-----
Bandwidth	11 MHz	Upper	-----
Spacing	27.5 MHz		

Date: 21.MAY.2007 11:18:08

Test Mode 2: Modulation Standard: 802.11g (12Mbps)  
Channel: 01

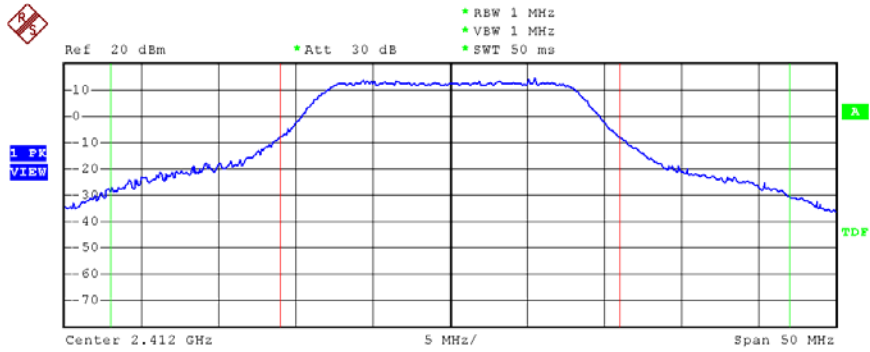

<b>Tx Channel</b>		<b>WLAN 802.11B</b>	
Bandwidth	22 MHz	Power	23.87 dBm
<b>Adjacent Channel</b>		Lower	-31.04 dB
Bandwidth	11 MHz	Upper	-31.46 dB
Spacing	16.5 MHz		
<b>Alternate Channel</b>		Lower	-----
Bandwidth	11 MHz	Upper	-----
Spacing	27.5 MHz		

Date: 21.MAY.2007 11:16:34

Test Mode 2: Modulation Standard: 802.11g (12Mbps)  
Channel: 06

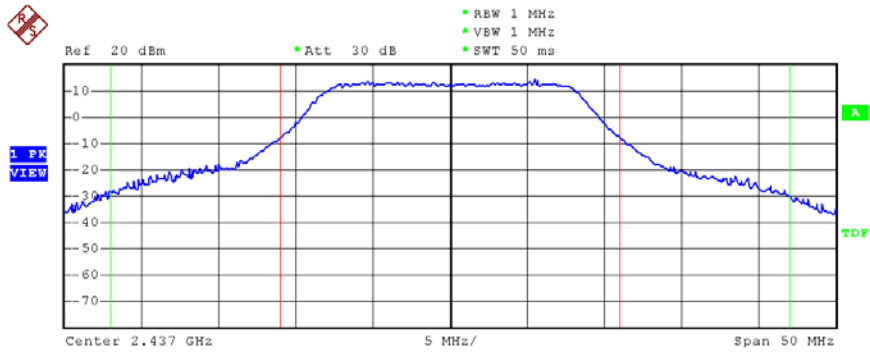

<b>Tx Channel</b>		<b>WLAN 802.11B</b>	
Bandwidth	22 MHz	Power	23.90 dBm
<b>Adjacent Channel</b>		Lower	-31.05 dB
Bandwidth	11 MHz	Upper	-31.41 dB
Spacing	16.5 MHz		
<b>Alternate Channel</b>		Lower	-----
Bandwidth	11 MHz	Upper	-----
Spacing	27.5 MHz		

Date: 21.MAY.2007 11:19:10

Test Mode 2: Modulation Standard: 802.11g (12Mbps)  
Channel: 11

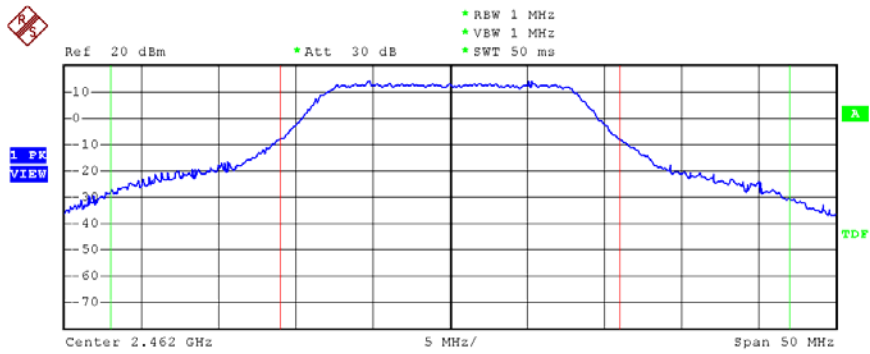

<b>Tx Channel</b>		<b>WLAN 802.11B</b>	
Bandwidth	22 MHz	Power	23.95 dBm
<b>Adjacent Channel</b>		Lower	-30.95 dB
Bandwidth	11 MHz	Upper	-31.36 dB
Spacing	16.5 MHz		
<b>Alternate Channel</b>		Lower	-----
Bandwidth	11 MHz	Upper	-----
Spacing	27.5 MHz		

Date: 21.MAY.2007 11:19:54

## 8. Band Edges Measurement

### 8.1 Test Limit

Below -20dB of the highest emission level of operating band (in 100kHz Resolution Bandwidth).

### 8.2 Test Procedure :

1. The transmitter output was connected to the spectrum analyzer via a low lose cable.
2. Set both RBW and VBW of spectrum analyzer to 100 KHz with convenient frequency span including 100 KHz bandwidth from band edge.
3. The band edges was measured and recorded.

### 8.3 Test Setup Layout

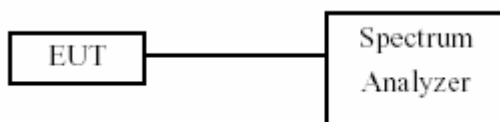

### 8.4 List of Measuring Equipment Used

Instrument/Ancillary	Model No.	Manufacturer	Serial No.	Calibration Date	Valid Date.
Spectrum Analyzer	FSP40	R&S	100047	2007/01/23	2008/01/22

### 8.5 Test Result and Data

(1) Test Mode 1:

Modulation Standard: IEEE 802.11b (11Mbps)

Test Date: May. 21, 2007 Temperature: 25 Humidity: 68% Atmospheric pressure: 1010 hPa

Channel	Frequency	maximum value in frequency (MHz)	maximum value is (dBm)
01	2412	2397.00	-30.24
11	2462	2860.00	-35.82

(2) Test Mode 1:

Modulation Standard: IEEE 802.11g (12Mbps)

Test Date: May. 21, 2007 Temperature: 25 Humidity: 68% Atmospheric pressure: 1010 hPa

Channel	Frequency	maximum value in frequency (MHz)	maximum value is (dBm)
01	2412	2399.8	-27.66
11	2462	2483.9	-39.10

(3) Test Mode 2:

Modulation Standard: IEEE 802.11b (11Mbps)

Test Date: May. 21, 2007 Temperature: 25 Humidity: 68% Atmospheric pressure: 1010 hPa

Channel	Frequency	maximum value in frequency (MHz)	maximum value is (dBm)
01	2412	2397.0	-32.89
11	2462	2860.0	-39.12

(4) Test Mode 2:

Modulation Standard: IEEE 802.11g (12Mbps)

Test Date: May. 21, 2007 Temperature: 25 Humidity: 68% Atmospheric pressure: 1010 hPa

Channel	Frequency	maximum value in frequency (MHz)	maximum value is (dBm)
01	2412	2399.8	-28.42
11	2462	2483.7	-45.04

Test Mode 1: Modulation Standard: 802.11b (11Mbps)  
 Channel: 01

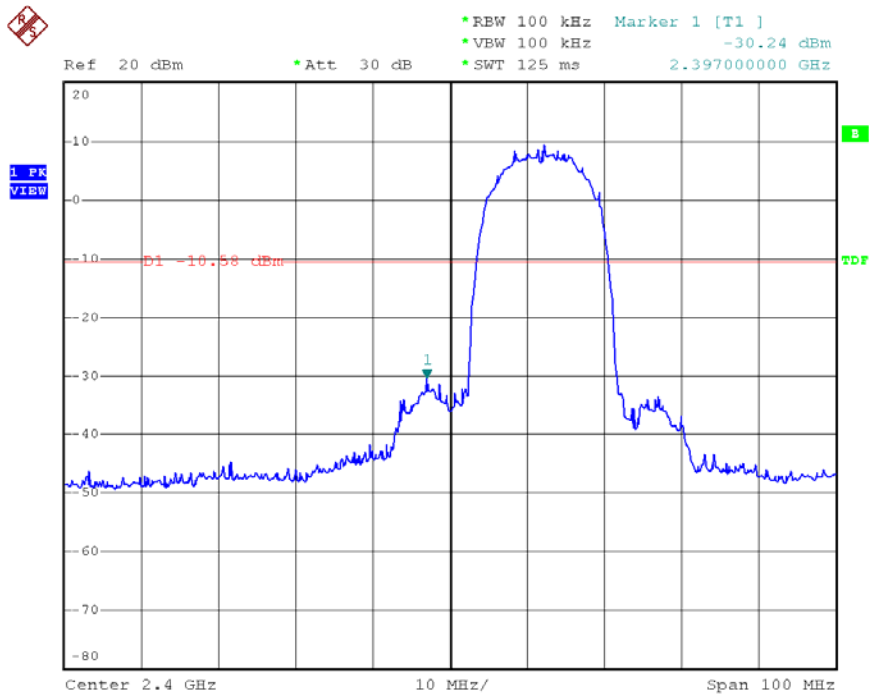

Date: 21.MAY.2007 14:49:26

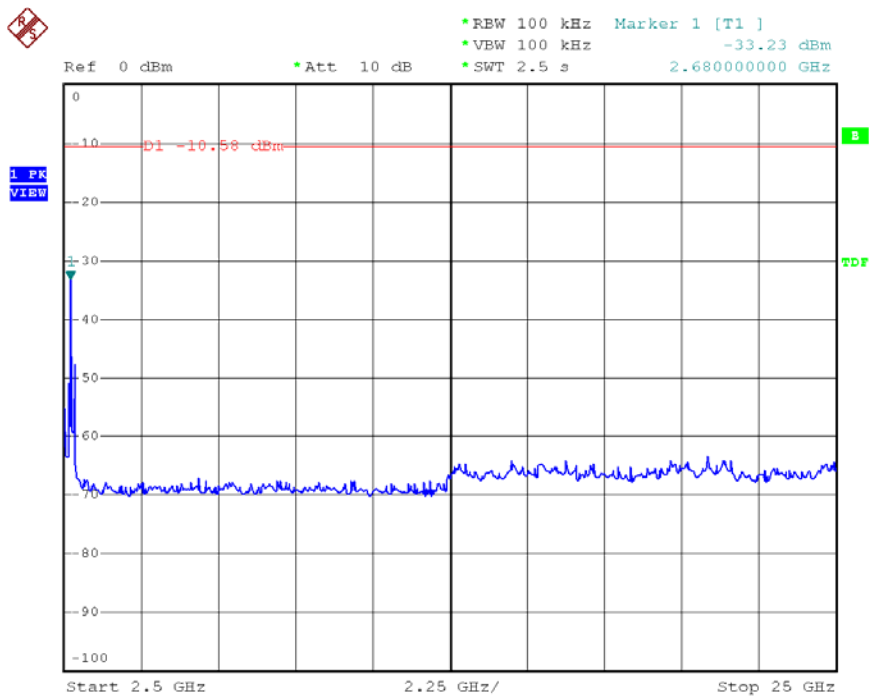

Date: 21.MAY.2007 14:50:13

Test Mode 1: Modulation Standard: 802.11b (11Mbps)  
 Channel: 11

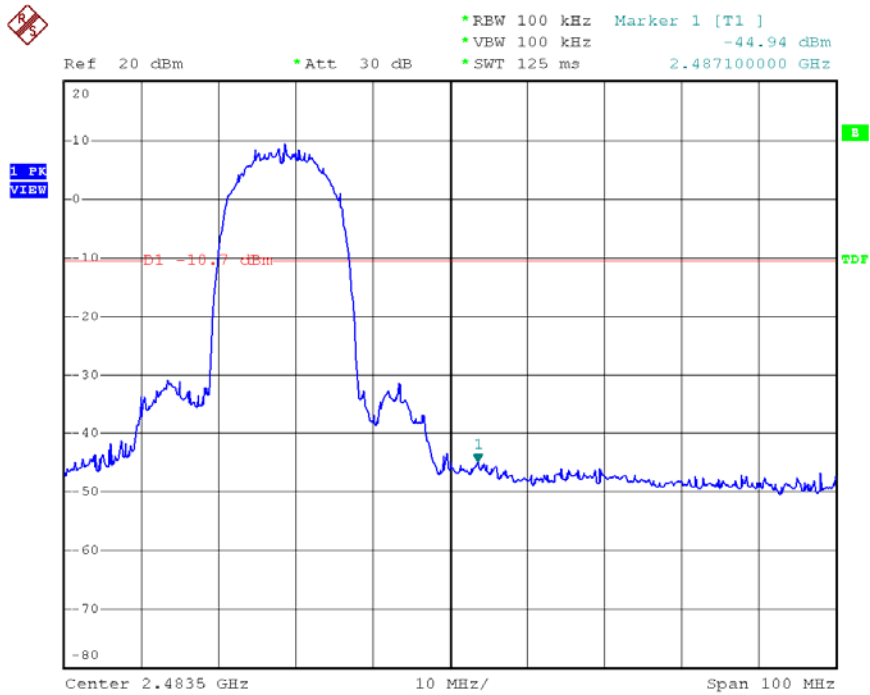

Date: 21.MAY.2007 14:52:06

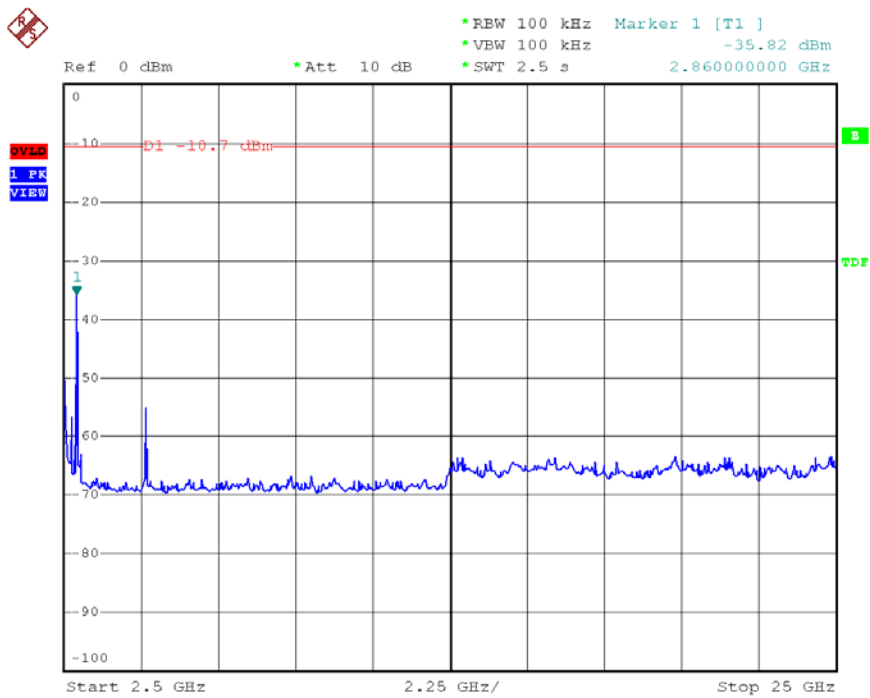

Date: 21.MAY.2007 14:54:11



Test Mode 1: Modulation Standard: 802.11g (12Mbps)  
 Channel: 01

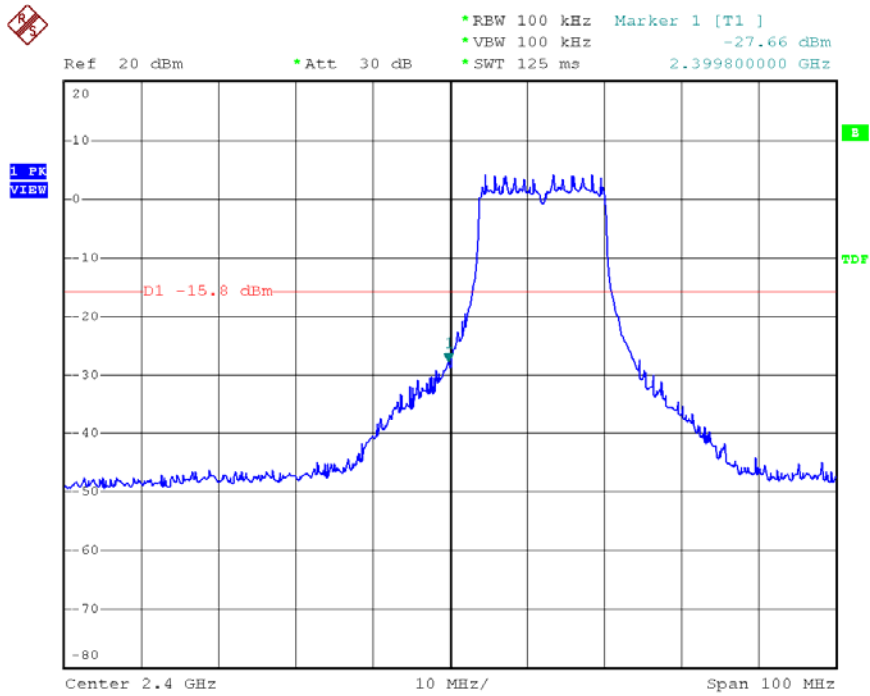

Date: 21.MAY.2007 14:58:06

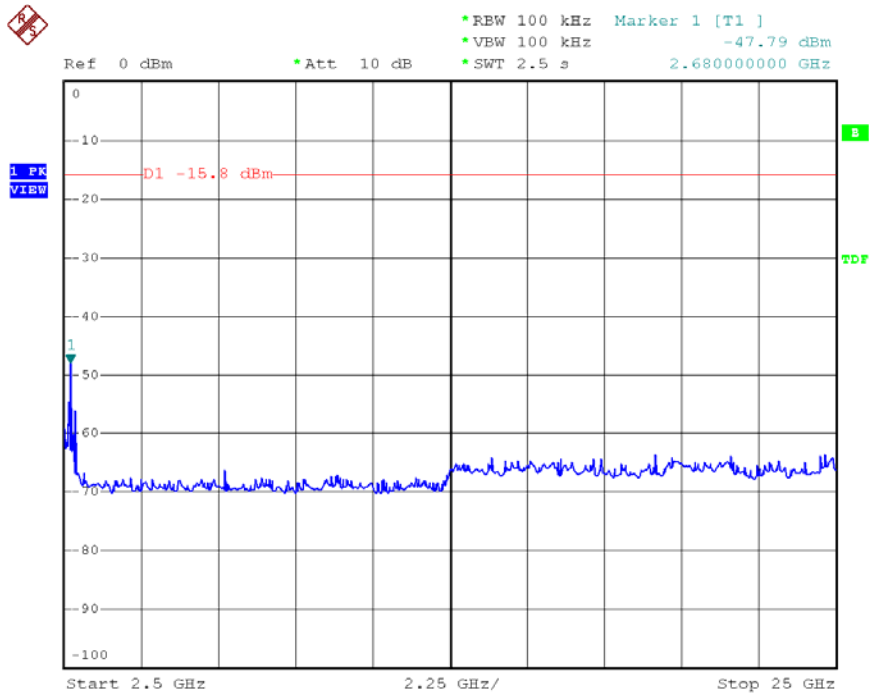

Date: 21.MAY.2007 14:56:43

Test Mode 1: Modulation Standard: 802.11g (12Mbps)  
 Channel: 11

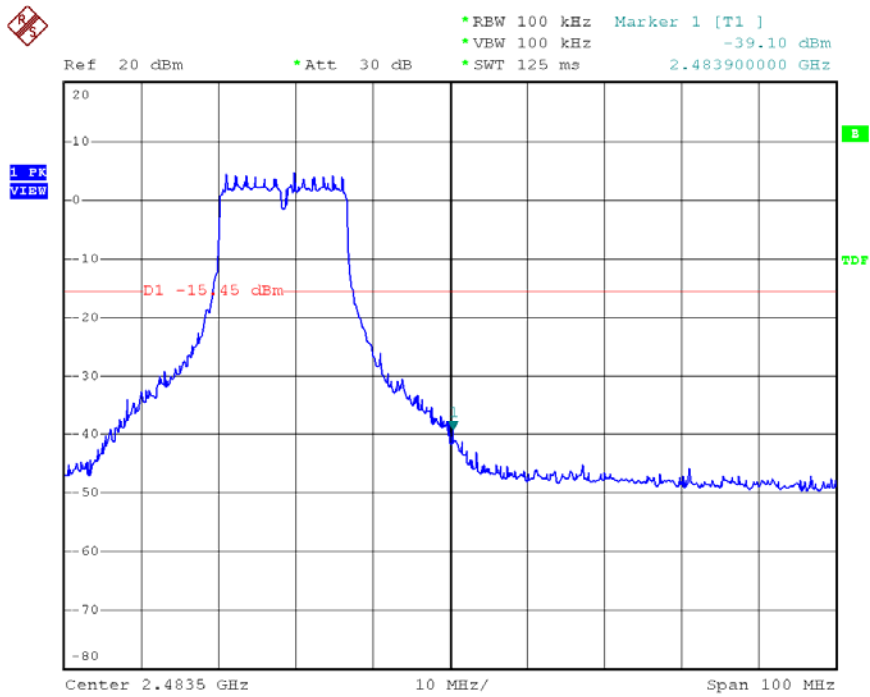

Date: 21.MAY.2007 14:59:13

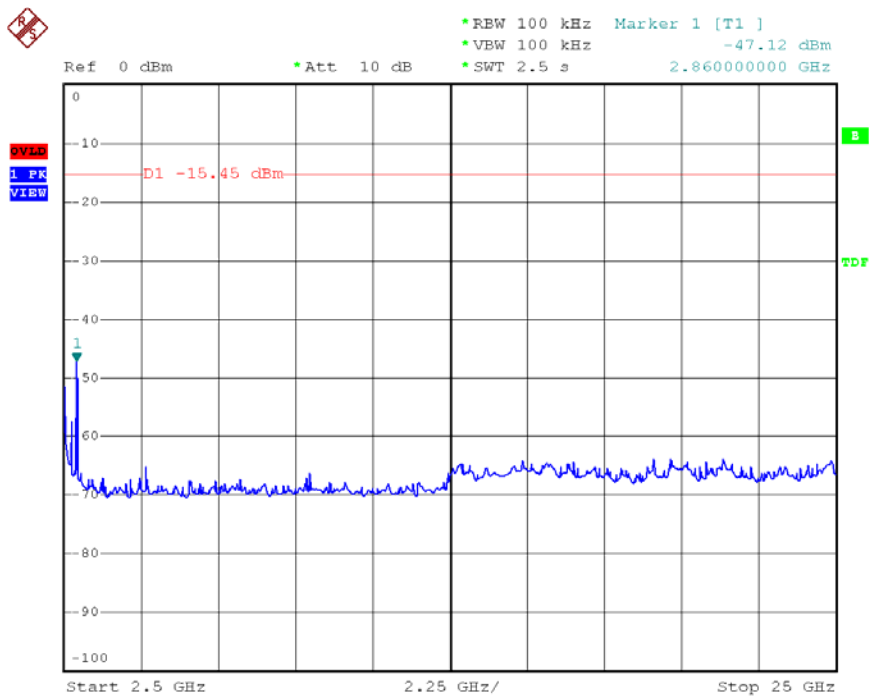

Date: 21.MAY.2007 15:01:55

Test Mode 2: Modulation Standard: 802.11b (11Mbps)  
 Channel: 01

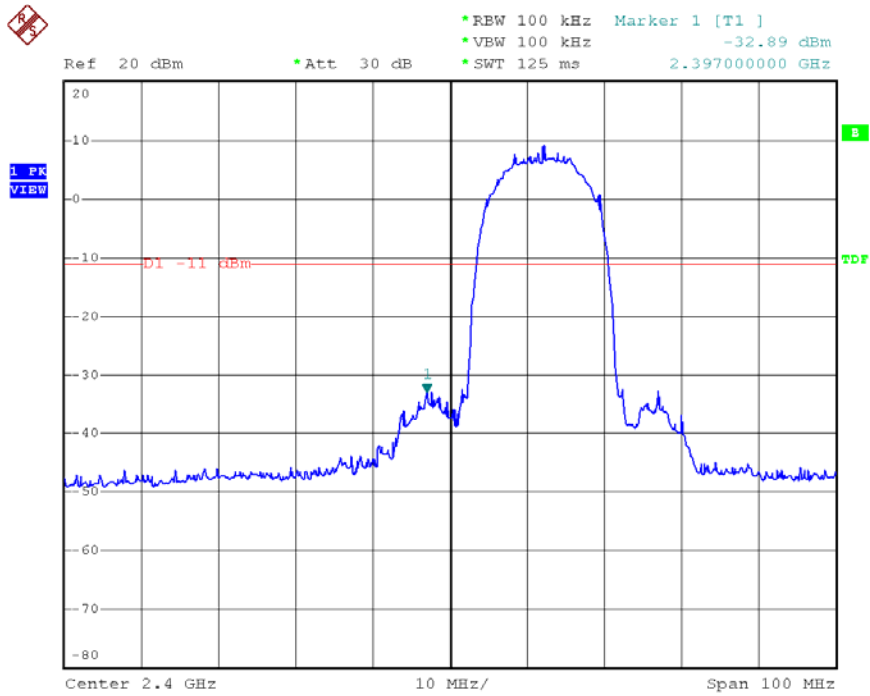

Date: 21.MAY.2007 11:38:44

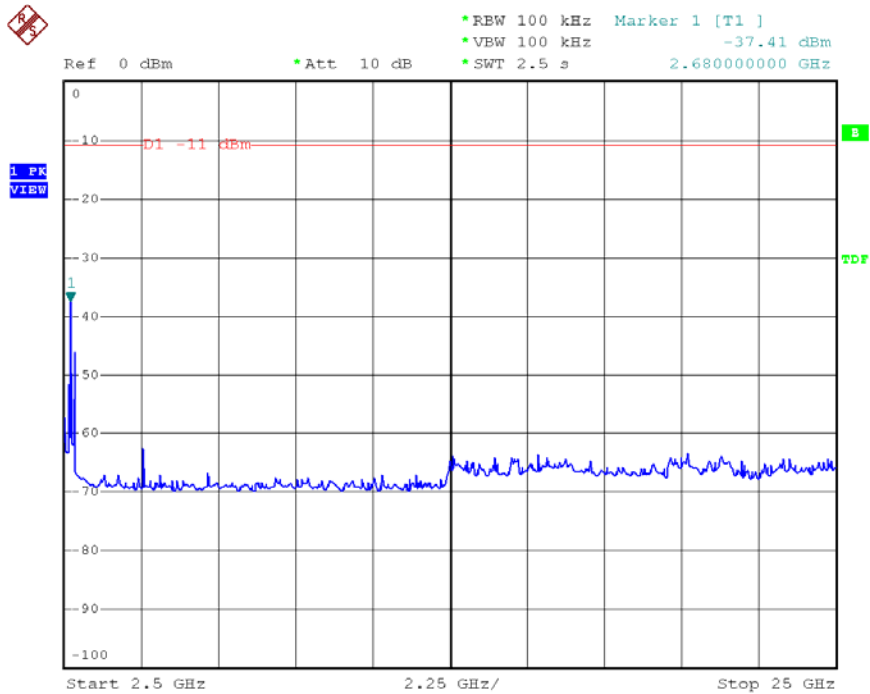

Date: 21.MAY.2007 11:39:21

Test Mode 2: Modulation Standard: 802.11b (11Mbps)  
 Channel: 11

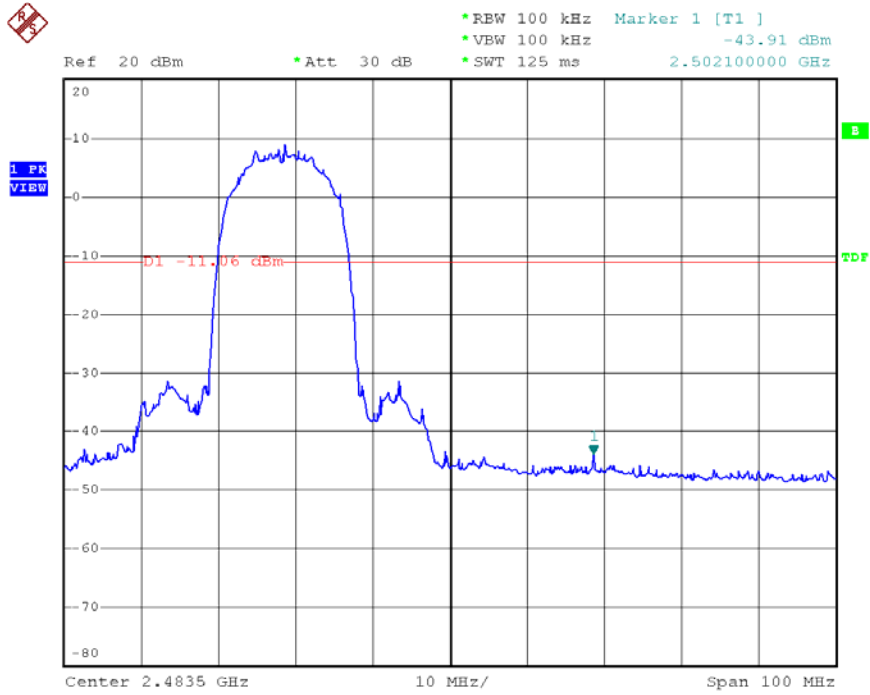

Date: 21.MAY.2007 11:42:13

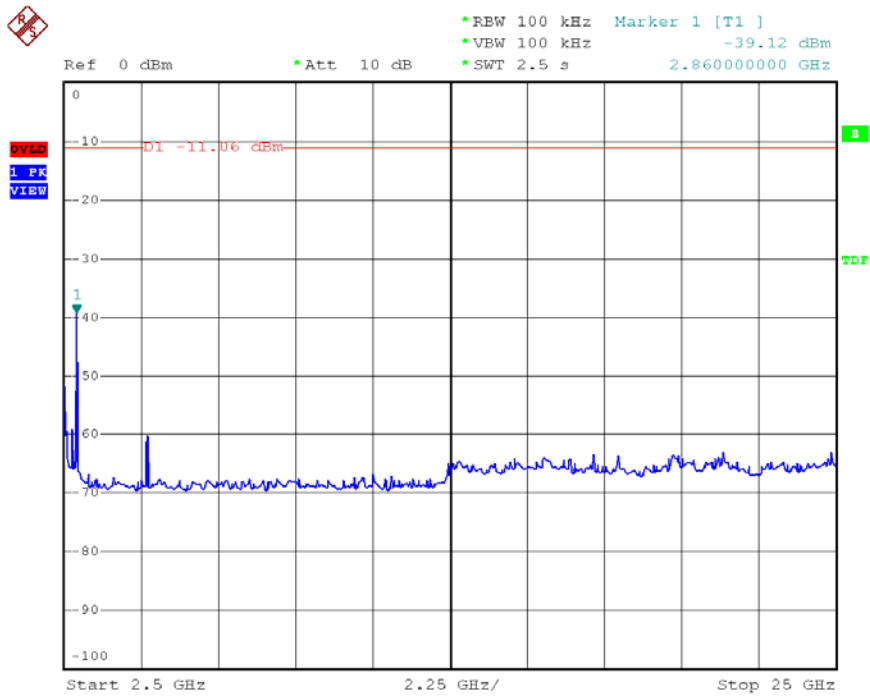

Date: 21.MAY.2007 11:43:06

Test Mode 2: Modulation Standard: 802.11g (12Mbps)  
 Channel: 01

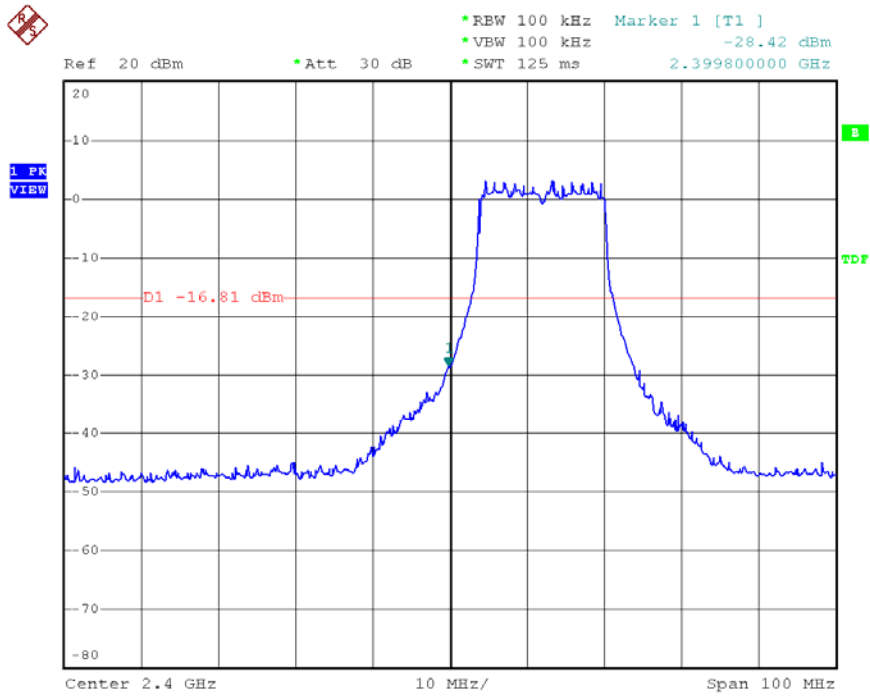

Date: 21.MAY.2007 11:44:53

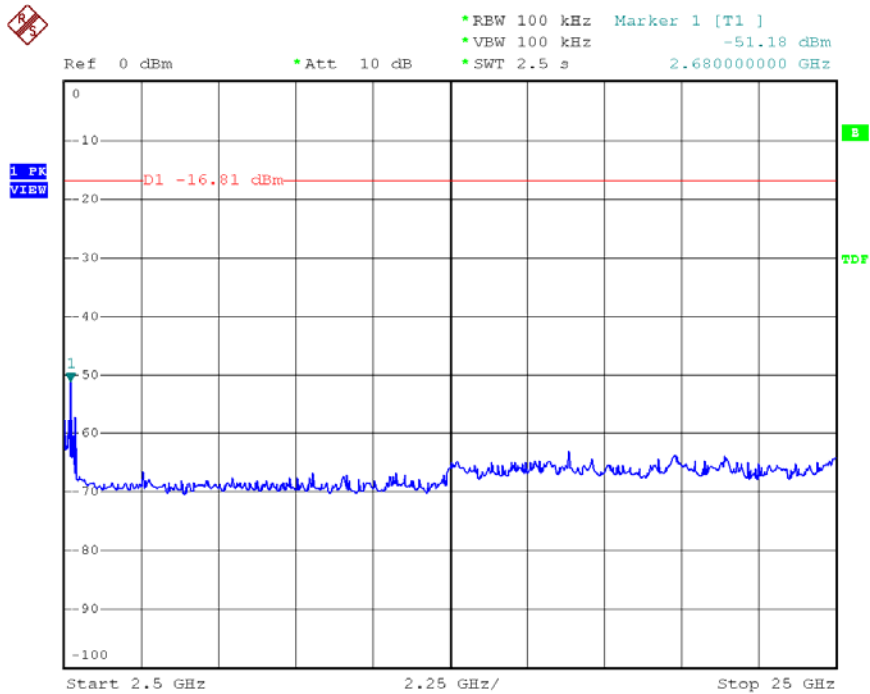

Date: 21.MAY.2007 11:45:49

Test Mode 2: Modulation Standard: 802.11g (12Mbps)  
 Channel: 11

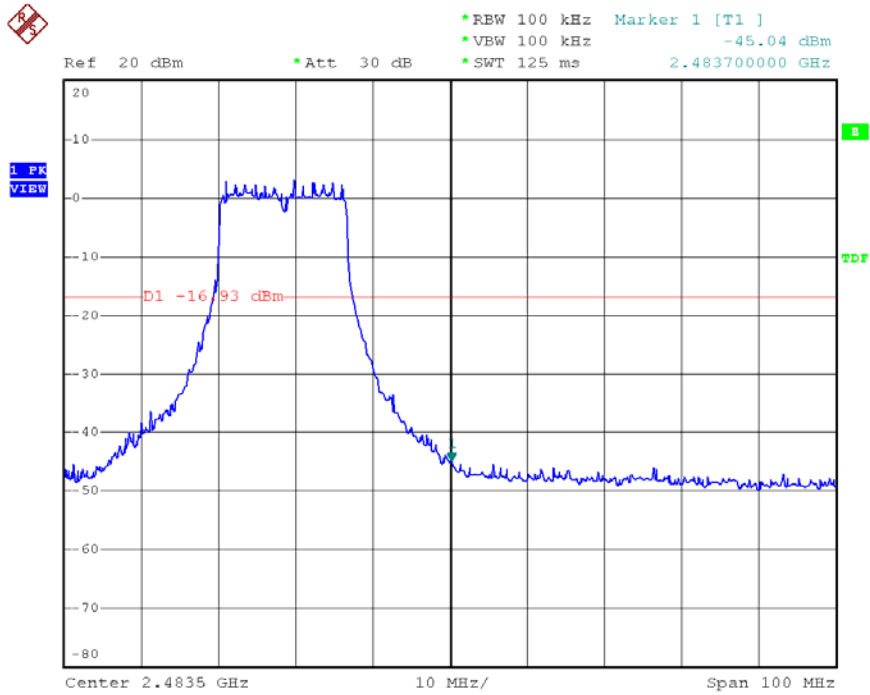

Date: 21.MAY.2007 11:49:08

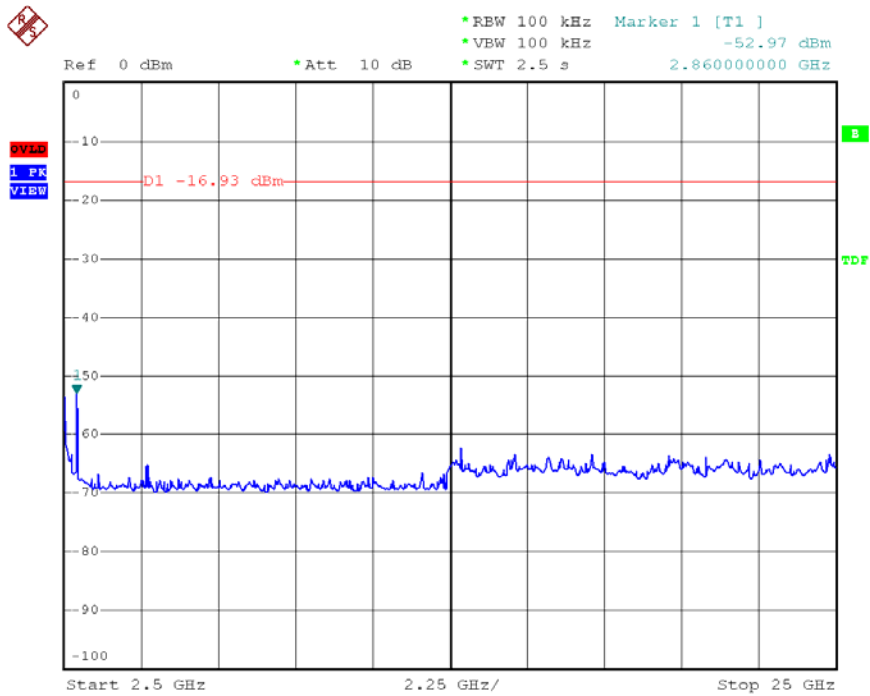

Date: 21.MAY.2007 11:49:56

**8.6 Restrict band emission Measurement Data**

Test Mode 1:

Modulation Standard: IEEE 802.11b (11Mbps)

Test Date: Jun. 06, 2007 Temperature: 25 Humidity: 70% Atmospheric pressure: 1010 hPa

a) Channel 1

Frequency (MHz)	Ant-Pol H/V	Meter Reading	Corrected Factor	Result (dBuV/m)	Remark	Limit@3m (dBuV/m)		Margin (dB)	Table (Deg.)	Ant High (m)
						Peak	Ave.			
2389.46	H	50.44	-0.14	50.30	Peak	74	54	-23.70	128	1.1
2386.19	H	39.28	-0.16	39.12	Ave	74	54	-14.88	128	1.1
2389.97	V	62.88	-0.14	62.74	Peak	74	54	-11.26	160	1.0
2386.19	V	51.13	-0.16	50.97	Ave	74	54	-3.03	160	1.0

b) Channel 11

Frequency (MHz)	Ant-Pol H/V	Meter Reading	Corrected Factor	Result (dBuV/m)	Remark	Limit@3m (dBuV/m)		Margin (dB)	Table (Deg.)	Ant High (m)
						Peak	Ave.			
2484.88	H	50.93	0.24	51.17	Peak	74	54	-22.83	128	1.1
2483.51	H	39.26	0.23	39.49	Ave	74	54	-14.51	128	1.1
2484.12	V	61.65	0.24	61.89	Peak	74	54	-12.11	160	1.0
2483.51	V	50.33	0.23	50.56	Ave	74	54	-3.44	160	1.0

Modulation Standard: 802.11g (12Mbps)

Test Date: Jun. 06, 2007 Temperature: 25 Humidity: 70% Atmospheric pressure: 1010 hPa

c) Channel 1

Frequency (MHz)	Ant-Pol H/V	Meter Reading	Corrected Factor	Result (dBuV/m)	Remark	Limit@3m (dBuV/m)		Margin (dB)	Table (Deg.)	Ant High (m)
						Peak	Ave.			
2389.46	H	51.48	-0.14	51.34	Peak	74	54	-22.66	128	1.1
2389.97	H	40.42	-0.14	40.28	Ave	74	54	-13.72	128	1.1
2389.76	V	63.40	-0.14	63.26	Peak	74	54	-10.74	160	1.0
2389.97	V	51.65	-0.14	51.51	Ave	74	54	-3.49	160	1.0

d) Channel 11

Frequency (MHz)	Ant-Pol H/V	Meter Reading	Corrected Factor	Result (dBuV/m)	Remark	Limit@3m (dBuV/m)		Margin (dB)	Table (Deg.)	Ant High (m)
						Peak	Ave.			
2483.74	H	51.24	0.23	51.47	Peak	74	54	-22.53	128	1.1
2483.51	H	40.80	0.23	41.03	Ave	74	54	-12.97	128	1.1
2483.62	V	61.78	0.23	62.01	Peak	74	54	-11.99	160	1.0
2483.51	V	50.76	0.23	50.99	Ave	74	54	-3.01	160	1.0

Notes:

1. Result = Meter Reading + Factor
2. Factor = Antenna Factor + Cable Loss – Amplifier
3. The resolution bandwidth of test receiver/spectrum analyzer is 1 MHz and video bandwidth is 3 MHz for Peak detection at frequency above 1GHz.
4. The resolution bandwidth of test receiver/spectrum analyzer is 1MHz and video bandwidth is 10Hz for Average detection at frequency above 1GHz

Test Mode 2:

Modulation Standard: IEEE 802.11b (11Mbps)

Test Date: Jun. 06, 2007 Temperature: 25 Humidity: 70% Atmospheric pressure: 1010 hPa

a) Channel 1

Frequency (MHz)	Ant-Pol H/V	Meter Reading	Corrected Factor	Result (dBuV/m)	Remark	Limit@3m (dBuV/m)		Margin (dB)	Table (Deg.)	Ant High (m)
						Peak	Ave.			
2389.46	H	50.77	-0.14	50.63	Peak	74	54	-23.37	128	1.1
2386.19	H	39.35	-0.16	39.19	Ave	74	54	-14.81	128	1.1
2389.97	V	62.49	-0.14	62.35	Peak	74	54	-11.65	160	1.0
2386.19	V	51.08	-0.16	50.92	Ave	74	54	-3.08	160	1.0

b) Channel 11

Frequency (MHz)	Ant-Pol H/V	Meter Reading	Corrected Factor	Result (dBuV/m)	Remark	Limit@3m (dBuV/m)		Margin (dB)	Table (Deg.)	Ant High (m)
						Peak	Ave.			
2484.88	H	50.88	0.24	51.12	Peak	74	54	-22.88	128	1.1
2483.51	H	39.37	0.23	39.60	Ave	74	54	-14.40	128	1.1
2484.12	V	61.74	0.24	61.98	Peak	74	54	-12.02	160	1.0
2483.51	V	50.46	0.23	50.69	Ave	74	54	-3.31	160	1.0

Modulation Standard: 802.11g (12Mbps)

Test Date: Jun. 06, 2007 Temperature: 25 Humidity: 70% Atmospheric pressure: 1010 hPa

c) Channel 1

Frequency (MHz)	Ant-Pol H/V	Meter Reading	Corrected Factor	Result (dBuV/m)	Remark	Limit@3m (dBuV/m)		Margin (dB)	Table (Deg.)	Ant High (m)
						Peak	Ave.			
2389.46	H	51.53	-0.14	51.39	Peak	74	54	-22.61	128	1.1
2389.97	H	40.55	-0.14	40.41	Ave	74	54	-13.59	128	1.1
2389.76	V	63.57	-0.14	63.43	Peak	74	54	-10.57	160	1.0
2389.97	V	50.40	-0.14	50.26	Ave	74	54	-3.74	160	1.0

d) Channel 11

Frequency (MHz)	Ant-Pol H/V	Meter Reading	Corrected Factor	Result (dBuV/m)	Remark	Limit@3m (dBuV/m)		Margin (dB)	Table (Deg.)	Ant High (m)
						Peak	Ave.			
2483.74	H	51.35	0.23	51.58	Peak	74	54	-22.42	128	1.1
2483.51	H	40.77	0.23	41.00	Ave	74	54	-13.00	128	1.1
2483.62	V	71.94	0.23	62.17	Peak	74	54	-11.83	160	1.0
2483.51	V	50.11	0.23	50.34	Ave	74	54	-3.66	160	1.0

Notes:

1. Result = Meter Reading + Factor
2. Factor = Antenna Factor + Cable Loss – Amplifier
3. The resolution bandwidth of test receiver/spectrum analyzer is 1 MHz and video bandwidth is 3 MHz for Peak detection at frequency above 1GHz.
4. The resolution bandwidth of test receiver/spectrum analyzer is 1MHz and video bandwidth is 10Hz for Average detection at frequency above 1GHz



Test Mode 3:

Modulation Standard: IEEE 802.11b (11Mbps)

Test Date: Jun. 06, 2007 Temperature: 25 Humidity: 70% Atmospheric pressure: 1010 hPa

e) Channel 1

Frequency (MHz)	Ant-Pol H/V	Meter Reading	Corrected Factor	Result (dBuV/m)	Remark	Limit@3m (dBuV/m)		Margin (dB)	Table (Deg.)	Ant High (m)
						Peak	Ave.			
2389.46	H	50.35	-0.14	50.21	Peak	74	54	-23.79	132	1.1
2386.19	H	39.30	-0.16	39.14	Ave	74	54	-14.86	132	1.1
2389.97	V	63.17	-0.14	63.03	Peak	74	54	-10.97	170	1.0
2386.19	V	51.42	-0.16	51.26	Ave	74	54	-2.74	170	1.0

f) Channel 11

Frequency (MHz)	Ant-Pol H/V	Meter Reading	Corrected Factor	Result (dBuV/m)	Remark	Limit@3m (dBuV/m)		Margin (dB)	Table (Deg.)	Ant High (m)
						Peak	Ave.			
2484.88	H	50.89	0.24	51.13	Peak	74	54	-22.87	132	1.1
2483.51	H	39.22	0.23	39.45	Ave	74	54	-14.55	132	1.1
2484.12	V	61.86	0.24	62.10	Peak	74	54	-11.90	170	1.0
2483.51	V	50.11	0.23	50.34	Ave	74	54	-3.66	170	1.0

Modulation Standard: 802.11g (12Mbps)

Test Date: Jun. 06, 2007 Temperature: 25 Humidity: 70% Atmospheric pressure: 1010 hPa

g) Channel 1

Frequency (MHz)	Ant-Pol H/V	Meter Reading	Corrected Factor	Result (dBuV/m)	Remark	Limit@3m (dBuV/m)		Margin (dB)	Table (Deg.)	Ant High (m)
						Peak	Ave.			
2389.46	H	51.55	-0.14	51.41	Peak	74	54	-22.59	132	1.1
2389.97	H	40.30	-0.14	40.16	Ave	74	54	-13.84	132	1.1
2389.76	V	63.88	-0.14	63.74	Peak	74	54	-10.26	170	1.0
2389.97	V	50.97	-0.14	50.83	Ave	74	54	-3.17	170	1.0

h) Channel 11

Frequency (MHz)	Ant-Pol H/V	Meter Reading	Corrected Factor	Result (dBuV/m)	Remark	Limit@3m (dBuV/m)		Margin (dB)	Table (Deg.)	Ant High (m)
						Peak	Ave.			
2483.74	H	51.64	0.23	51.87	Peak	74	54	-22.13	132	1.1
2483.51	H	40.77	0.23	41.00	Ave	74	54	-13.00	132	1.1
2483.62	V	61.50	0.23	61.73	Peak	74	54	-12.27	170	1.0
2483.51	V	50.69	0.23	50.92	Ave	74	54	-3.08	170	1.0

Notes:

1. Result = Meter Reading + Factor
2. Factor = Antenna Factor + Cable Loss – Amplifier
3. The resolution bandwidth of test receiver/spectrum analyzer is 1 MHz and video bandwidth is 3 MHz for Peak detection at frequency above 1GHz.
4. The resolution bandwidth of test receiver/spectrum analyzer is 1MHz and video bandwidth is 10Hz for Average detection at frequency above 1GHz

Test Mode 4:

Modulation Standard: IEEE 802.11b (11Mbps)

Test Date: Jun. 06, 2007 Temperature: 25 Humidity: 70% Atmospheric pressure: 1010 hPa

i) Channel 1

Frequency (MHz)	Ant-Pol H/V	Meter Reading	Corrected Factor	Result (dBuV/m)	Remark	Limit@3m (dBuV/m)		Margin (dB)	Table (Deg.)	Ant High (m)
						Peak	Ave.			
2389.46	H	50.74	-0.14	50.60	Peak	74	54	-23.40	132	1.1
2386.19	H	39.24	-0.16	39.08	Ave	74	54	-14.92	132	1.1
2389.97	V	62.29	-0.14	62.15	Peak	74	54	-11.85	170	1.0
2386.19	V	51.06	-0.16	50.90	Ave	74	54	-3.10	170	1.0

j) Channel 11

Frequency (MHz)	Ant-Pol H/V	Meter Reading	Corrected Factor	Result (dBuV/m)	Remark	Limit@3m (dBuV/m)		Margin (dB)	Table (Deg.)	Ant High (m)
						Peak	Ave.			
2484.88	H	50.74	0.24	50.98	Peak	74	54	-23.02	132	1.1
2483.51	H	39.52	0.23	39.75	Ave	74	54	-14.25	132	1.1
2484.12	V	61.64	0.24	61.88	Peak	74	54	-12.12	170	1.0
2483.51	V	50.67	0.23	50.90	Ave	74	54	-3.10	170	1.0

Modulation Standard: 802.11g (12Mbps)

Test Date: Jun. 06, 2007 Temperature: 25 Humidity: 70% Atmospheric pressure: 1010 hPa

k) Channel 1

Frequency (MHz)	Ant-Pol H/V	Meter Reading	Corrected Factor	Result (dBuV/m)	Remark	Limit@3m (dBuV/m)		Margin (dB)	Table (Deg.)	Ant High (m)
						Peak	Ave.			
2389.46	H	51.48	-0.14	51.34	Peak	74	54	-22.66	132	1.1
2389.97	H	40.84	-0.14	40.70	Ave	74	54	-13.30	132	1.1
2389.76	V	63.33	-0.14	63.19	Peak	74	54	-10.81	170	1.0
2389.97	V	50.99	-0.14	50.85	Ave	74	54	-3.15	170	1.0

l) Channel 11

Frequency (MHz)	Ant-Pol H/V	Meter Reading	Corrected Factor	Result (dBuV/m)	Remark	Limit@3m (dBuV/m)		Margin (dB)	Table (Deg.)	Ant High (m)
						Peak	Ave.			
2483.74	H	51.62	0.23	51.85	Peak	74	54	-22.15	132	1.1
2483.51	H	40.89	0.23	41.12	Ave	74	54	-12.88	132	1.1
2483.62	V	61.42	0.23	61.65	Peak	74	54	-12.35	170	1.0
2483.51	V	50.38	0.23	50.61	Ave	74	54	-3.39	170	1.0

Notes:

1. Result = Meter Reading + Factor
2. Factor = Antenna Factor + Cable Loss – Amplifier
3. The resolution bandwidth of test receiver/spectrum analyzer is 1 MHz and video bandwidth is 3 MHz for Peak detection at frequency above 1GHz.
4. The resolution bandwidth of test receiver/spectrum analyzer is 1MHz and video bandwidth is 10Hz for Average detection at frequency above 1GHz

## 9. Power Spectral Density

### 9.1 Test Limit

The Maximum of Power Spectral Density Measurement is 8dBm.

### 9.2 Test Procedures

- 1.The transmitter output was connected to spectrum analyzer.
- 2.The spectrum analyzer's resolution bandwidth were set at 3KHz RBW and 30KHz VBW as that of the fundamental frequency. Set the sweep time=span/3KHz.
- 3.The power spectral density was measured and recorded.
- 4.The Sweep time is allowed to be longer than span/3KHz for a full response of the mixer in the spectrum analyzer.

### 9.3 Test Setup Layout :

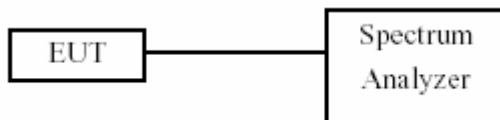

### 9.4 List of Measuring Equipment Used

Instrument/Ancillary	Model No.	Manufacturer	Serial No.	Calibration Date	Valid Date.
Spectrum Analyzer	FSP40	R&S	100047	2007/01/23	2008/01/22

### 9.5 Test Result and Data

#### (1) Test Mode 1:

Modulation Standard: IEEE 802.11b (11Mbps)

Test Date: May. 21, 2007 Temperature: 25 Humidity: 68% Atmospheric pressure: 1010 hPa

Channel	Frequency	Maximum Power Density of 3 kHz Bandwidth (dBm)
01	2412	-3.00
06	2437	-3.07
11	2462	-3.13

#### (2) Test Mode 1:

Modulation Standard: IEEE 802.11g (12Mbps)

Test Date: May. 21, 2007 Temperature: 25 Humidity: 68% Atmospheric pressure: 1010 hPa

Channel	Frequency	Maximum Power Density of 3 kHz Bandwidth (dBm)
01	2412	-6.14
06	2437	-6.25
11	2462	-6.35

(3) Test Mode 2:

Modulation Standard: IEEE 802.11b (11Mbps)

Test Date: May. 21, 2007 Temperature: 25 Humidity: 68% Atmospheric pressure: 1010 hPa

Channel	Frequency	Maximum Power Density of 3 kHz Bandwidth (dBm)
01	2412	-4.32
06	2437	-4.36
11	2462	-4.24

(4) Test Mode 2:

Modulation Standard: IEEE 802.11g (12Mbps)

Test Date: May. 21, 2007 Temperature: 25 Humidity: 68% Atmospheric pressure: 1010 hPa

Channel	Frequency	Maximum Power Density of 3 kHz Bandwidth (dBm)
01	2412	-5.39
06	2437	-5.65
11	2462	-5.69

Test Mode 1: Modulation Standard: 802.11b (11Mbps)  
Channel: 01

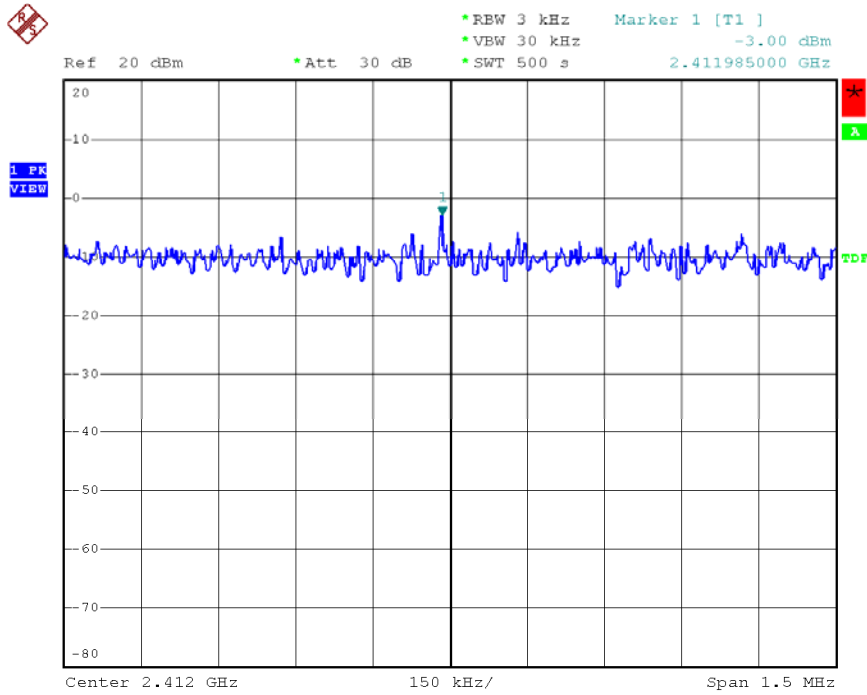

Date: 21.MAY.2007 14:41:04

Test Mode 1: Modulation Standard: 802.11b (11Mbps)  
Channel: 06

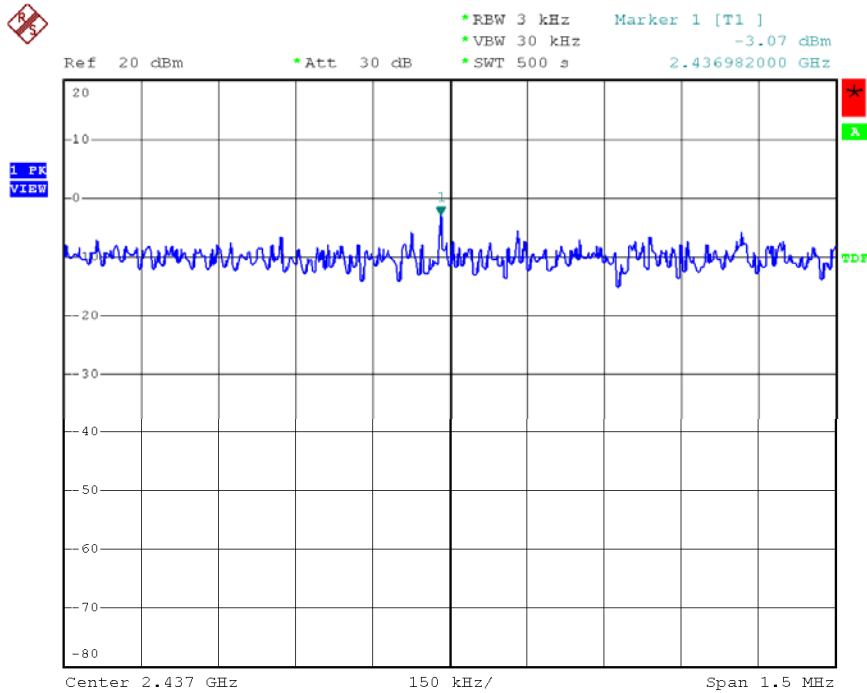

Date: 21.MAY.2007 14:42:12

Test Mode 1: Modulation Standard: 802.11b (11Mbps)  
Channel: 11

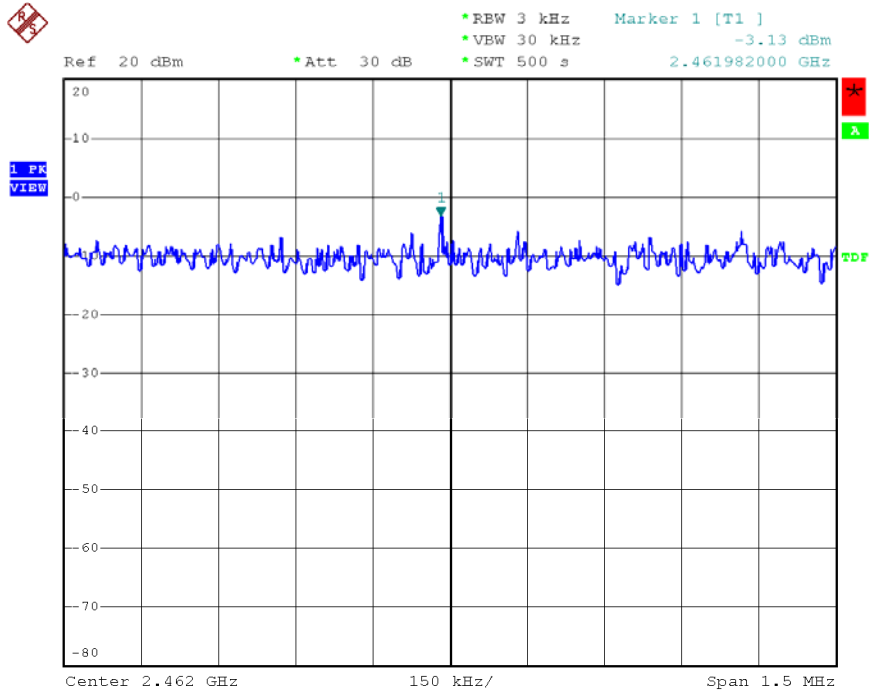

Date: 21.MAY.2007 14:43:03

Test Mode 1: Modulation Standard: 802.11g (12Mbps)  
Channel: 01

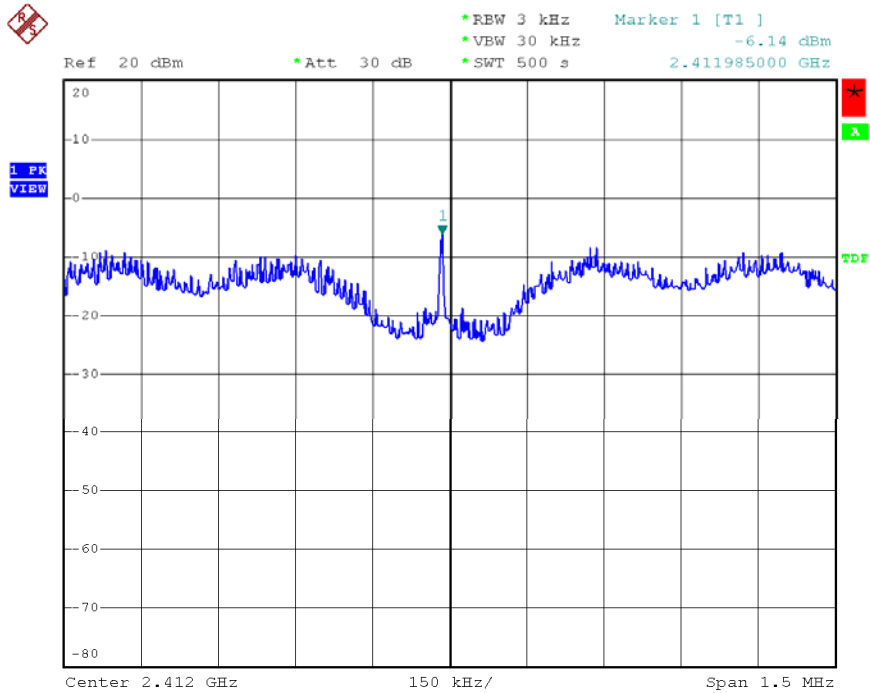

Date: 21.MAY.2007 14:45:58

Test Mode 1: Modulation Standard: 802.11g (12Mbps)  
Channel: 06

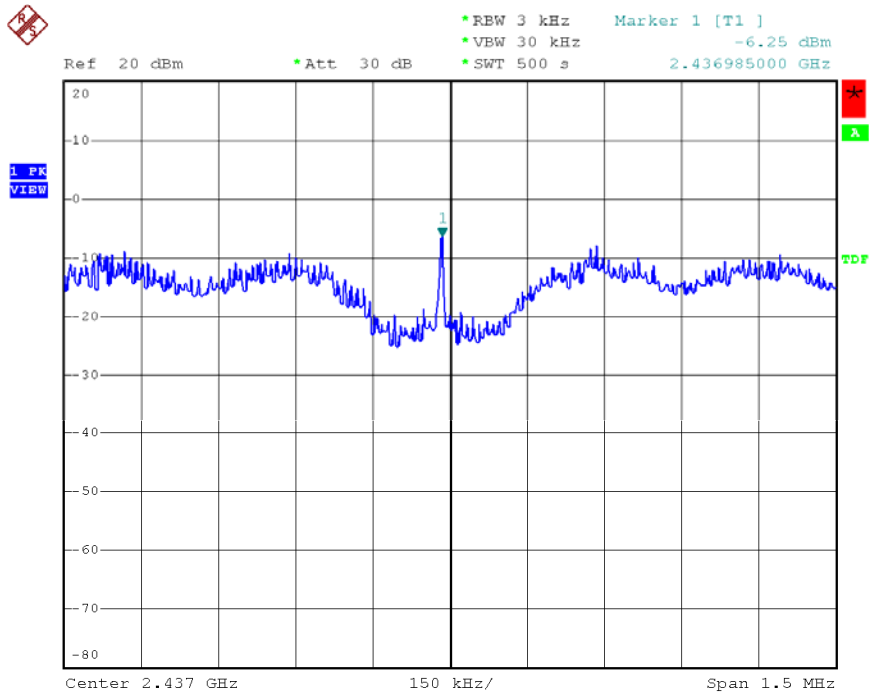

Date: 21.MAY.2007 14:46:58

Test Mode 1: Modulation Standard: 802.11g (12Mbps)  
Channel: 11

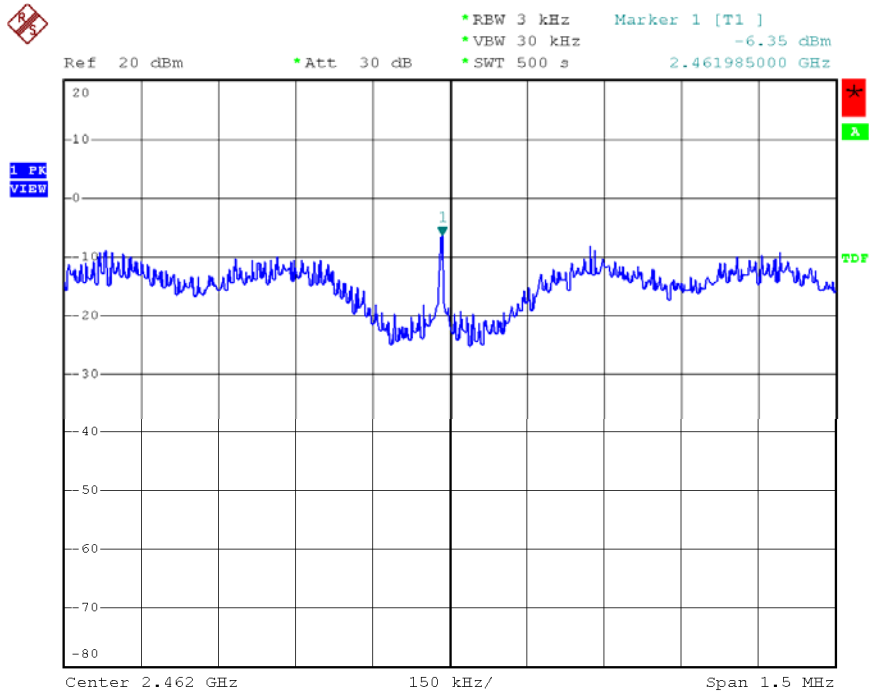

Date: 21.MAY.2007 14:47:44

Test Mode 2: Modulation Standard: 802.11b (11Mbps)  
 Channel: 01

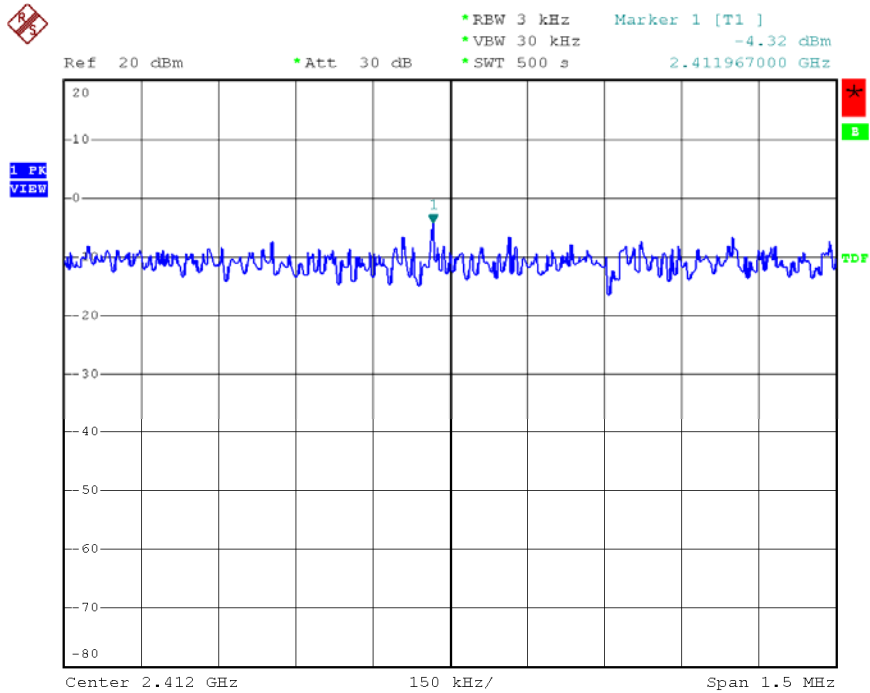

Date: 21.MAY.2007 11:31:30

Test Mode 2: Modulation Standard: 802.11b (11Mbps)  
 Channel: 06

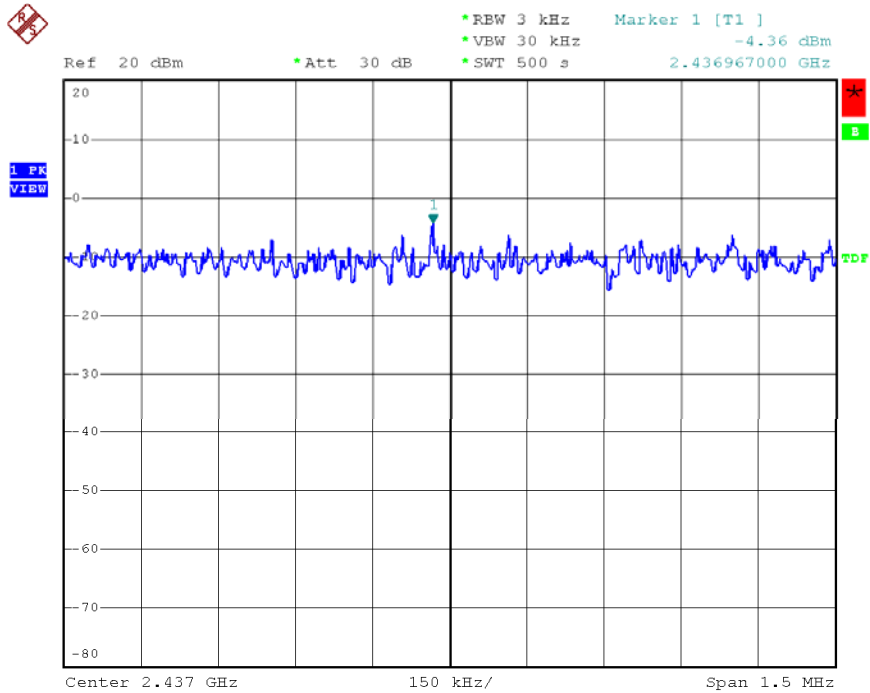

Date: 21.MAY.2007 11:32:35



Test Mode 2: Modulation Standard: 802.11b (11Mbps)  
 Channel: 11

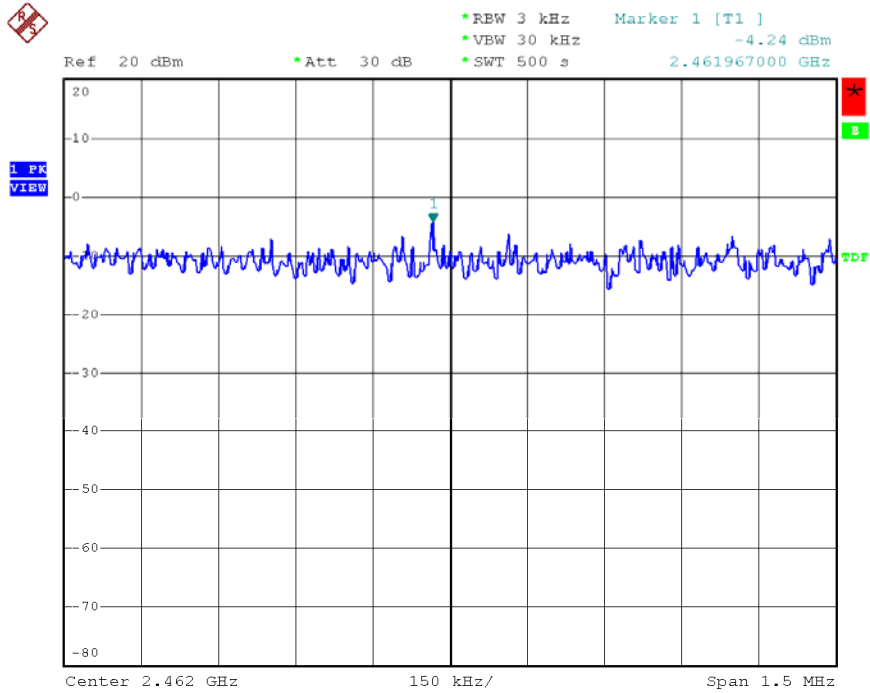

Date: 21.MAY.2007 11:33:44

Test Mode 2: Modulation Standard: 802.11g (12Mbps)  
 Channel: 01

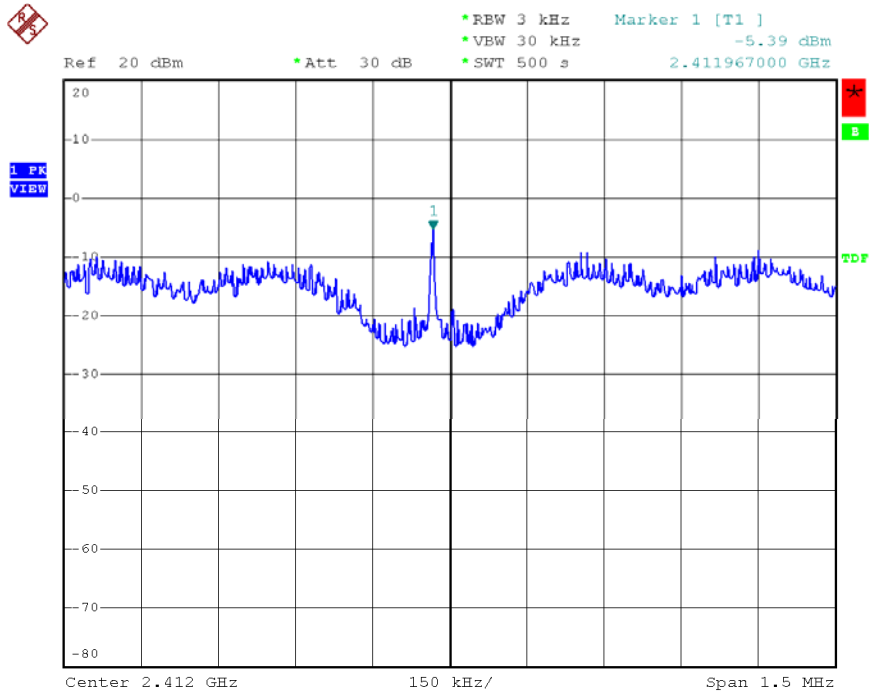

Date: 21.MAY.2007 11:34:40

Test Mode 2: Modulation Standard: 802.11g (12Mbps)  
Channel: 06

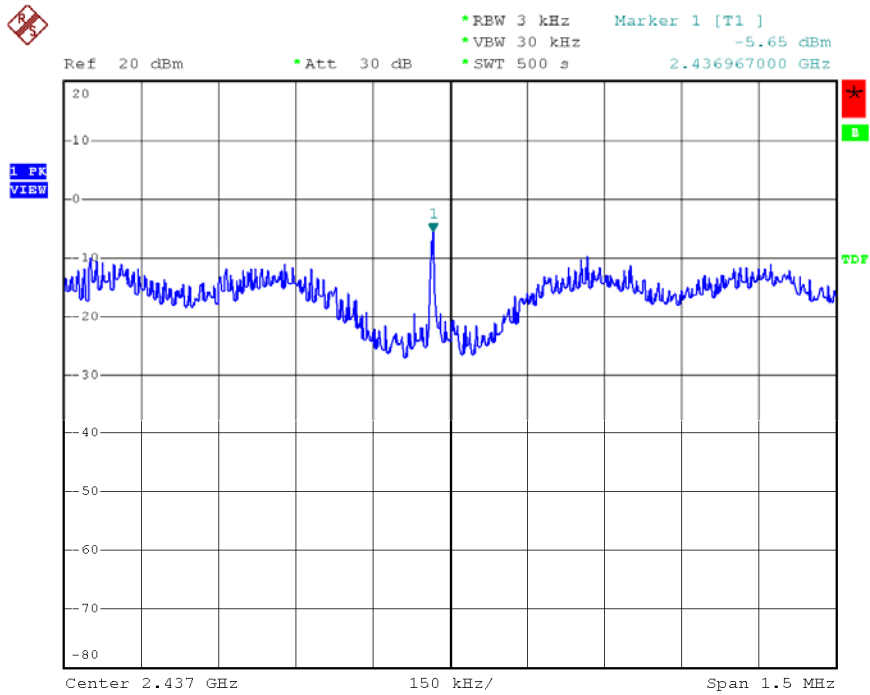

Date: 21.MAY.2007 11:35:39

Test Mode 2: Modulation Standard: 802.11g (12Mbps)  
Channel: 11

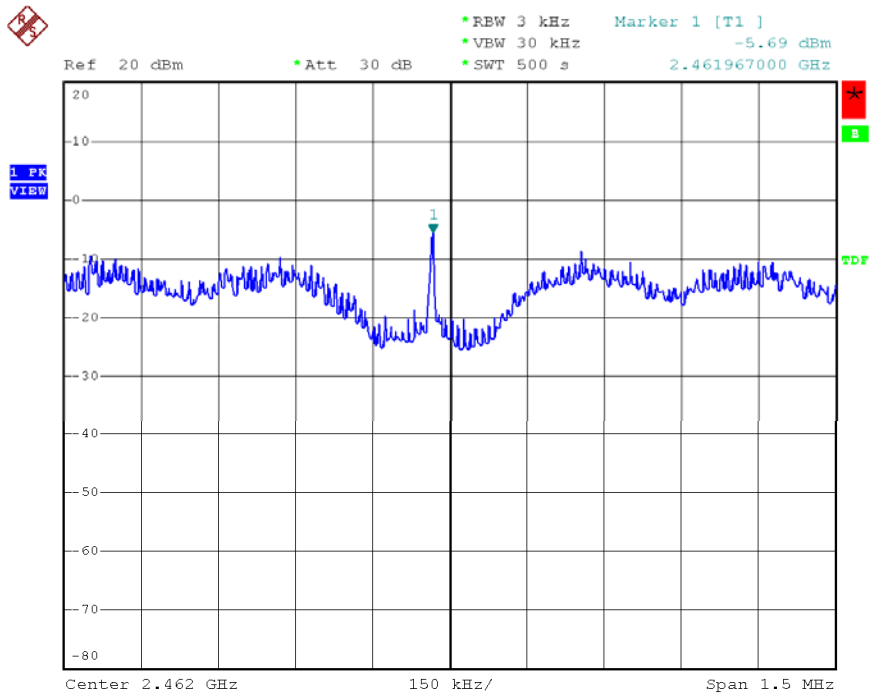

Date: 21.MAY.2007 11:36:23

## 10. Restricted Bands of Operation

Only spurious emissions are permitted in any of the frequency bands listed below:

MHz	MHz	MHz	GHz
0.09000 – 0.11000	16.42000 – 16.42300	399.9 – 410.0	4.500 – 5.250
0.49500 – 0.505**	16.69475 – 16.69525	608.0 – 614.0	5.350 – 5.460
2.17350 – 2.19050	16.80425 – 16.80475	960.0 – 1240.0	7.250 – 7.750
4.12500 – 4.12800	25.50000 – 25.67000	1300.0 – 1427.0	8.025 – 8.500
4.17725 – 4.17775	37.50000 – 38.25000	1435.0 – 1626.5	9.000 – 9.200
4.20725 – 4.20775	73.00000 – 74.60000	1645.5 – 1646.5	9.300 – 9.500
6.21500 – 6.21800	74.80000 – 75.20000	1660.0 – 1710.0	10.600 – 12.700
6.26775 – 6.26825	108.00000 – 121.94000	1718.8 – 1722.2	13.250 – 13.400
6.31175 – 6.31225	123.00000 – 138.00000	2200.0 – 2300.0	14.470 – 14.500
8.29100 – 8.29400	149.90000 – 150.05000	2310.0 – 2390.0	15.350 – 16.200
8.36200 – 8.36600	156.52475 – 156.52525	2483.5 – 2500.0	17.700 – 21.400
8.37625 – 8.38675	156.70000 – 156.90000	2655.0 – 2900.0	22.010 – 23.120
8.41425 – 8.41475	162.01250 – 167.17000	3260.0 – 3267.0	23.600 – 24.000
12.29000 – 12.29300	167.72000 – 173.20000	3332.0 – 3339.0	31.200 – 31.800
12.51975 – 12.52025	240.00000 – 285.00000	3345.8 – 3358.0	36.430 – 36.500
12.57675 – 12.57725	322.00000 – 335.40000	3600.0 – 4400.0	Above 38.6
13.36000 – 13.41000			

\*\* : Until February 1, 1999, this restricted band shall be 0.490-0.510 MHz

### 10.1 Labeling Requirement

The device shall bear the following statement in a conspicuous location on the device:

This device complies with part 15 of the FCC Rules. Operation is subject to the following two conditions: (1) This device may not cause harmful interference, and (2) this device must accept any interference received, including interference that may cause undesired operation.