



# FCC TEST REPORT

**REPORT NO.:** RF950601L13

**MODEL NO.:** WNR834M

**RECEIVED:** Jun. 08, 2006

**TESTED:** Jun. 08 ~ Jun. 26, 2006

**ISSUED:** Jun. 28, 2006

**APPLICANT:** Netgear Incorporated

**ADDRESS:** 4500 Great America Parkway Santa Clara, CA  
95054

**ISSUED BY:** Advance Data Technology Corporation

**LAB ADDRESS:** 47 14<sup>th</sup> Lin, Chiapau Tsun, Linko, Taipei, Taiwan,  
R.O.C.

**TEST LOCATION:** No. 19, Hwa Ya 2<sup>nd</sup> Rd., Kueishan, Taoyuan,  
Taiwan, R.O.C.

This test report consists of 135 pages in total. It may be duplicated completely for legal use with the approval of the applicant. It should not be reproduced except in full, without the written approval of our laboratory. The client should not use it to claim product endorsement by CNLA, A2LA or any government agencies. The test results in the report only apply to the tested sample.



## TABLE OF CONTENTS

1.	CERTIFICATION.....	4
2.	SUMMARY OF TEST RESULTS.....	5
2.1	MEASUREMENT UNCERTAINTY .....	5
3.	GENERAL INFORMATION .....	6
3.1	GENERAL DESCRIPTION OF EUT.....	6
3.2	DESCRIPTION OF TEST MODES .....	7
3.2.1	CONFIGURATION OF SYSTEM UNDER TEST .....	7
3.2.2	TEST MODE APPLICABILITY AND TESTED CHANNEL DETAIL.....	8
3.3	GENERAL DESCRIPTION OF APPLIED STANDARDS .....	11
3.4	DESCRIPTION OF SUPPORT UNITS .....	11
4.	TEST TYPES AND RESULTS.....	12
4.1	CONDUCTED EMISSION MEASUREMENT .....	12
4.1.1	LIMITS OF CONDUCTED EMISSION MEASUREMENT .....	12
4.1.2	TEST INSTRUMENTS .....	12
4.1.3	TEST PROCEDURES .....	13
4.1.4	DEVIATION FROM TEST STANDARD .....	13
4.1.5	TEST SETUP.....	14
4.1.6	EUT OPERATING CONDITIONS.....	14
4.1.7	TEST RESULTS .....	15
4.2	RADIATED EMISSION MEASUREMENT .....	39
4.2.1	LIMITS OF RADIATED EMISSION MEASUREMENT .....	39
4.2.2	TEST INSTRUMENTS .....	40
4.2.3	TEST PROCEDURES .....	41
4.2.4	DEVIATION FROM TEST STANDARD .....	41
4.2.5	TEST SETUP.....	42
4.2.6	EUT OPERATING CONDITIONS.....	42
4.2.7	TEST RESULTS .....	43
4.3	6dB BANDWIDTH MEASUREMENT .....	62
4.3.1	LIMITS OF 6dB BANDWIDTH MEASUREMENT .....	62
4.3.2	TEST INSTRUMENTS .....	62
4.3.3	TEST PROCEDURE.....	62
4.3.4	DEVIATION FROM TEST STANDARD .....	62
4.3.5	TEST SETUP.....	63
4.3.6	EUT OPERATING CONDITIONS.....	63
4.3.7	TEST RESULTS .....	64
4.4	MAXIMUM PEAK OUTPUT POWER .....	84
4.4.1	LIMITS OF MAXIMUM PEAK OUTPUT POWER MEASUREMENT.....	84
4.4.2	INSTRUMENTS.....	84
4.4.3	TEST PROCEDURES .....	84
4.4.4	DEVIATION FROM TEST STANDARD .....	84
4.4.5	TEST SETUP.....	85
4.4.6	EUT OPERATING CONDITIONS.....	85
4.4.7	TEST RESULTS .....	86
4.5	POWER SPECTRAL DENSITY MEASUREMENT .....	89
4.5.1	LIMITS OF POWER SPECTRAL DENSITY MEASUREMENT.....	89
4.5.2	TEST INSTRUMENTS .....	89
4.5.3	TEST PROCEDURE.....	89
4.5.4	DEVIATION FROM TEST STANDARD .....	89
4.5.5	TEST SETUP.....	90



4.5.6	EUT OPERATING CONDITION .....	90
4.5.7	TEST RESULTS .....	91
4.6	BAND EDGES MEASUREMENT .....	111
4.6.1	LIMITS OF BAND EDGES MEASUREMENT .....	111
4.6.2	TEST INSTRUMENTS .....	111
4.6.3	TEST PROCEDURE .....	111
4.6.4	DEVIATION FROM TEST STANDARD .....	112
4.6.5	EUT OPERATING CONDITION .....	112
4.6.6	TEST RESULTS .....	113
4.7	ANTENNA REQUIREMENT .....	133
4.7.1	STANDARD APPLICABLE .....	133
4.7.2	ANTENNA CONNECTED CONSTRUCTION .....	133
5.	INFORMATION ON THE TESTING LABORATORIES .....	134
	APPENDIX-A .....	A-1



## 1. CERTIFICATION

**PRODUCT:** RangeMax NEXT Wireless mPCI

**MODEL:** WNR834M

**BRAND:** NETGEAR

**APPLICANT:** Netgear Incorporated

**TESTED:** Jun. 08 ~ Jun. 26, 2006

**TEST SAMPLE:** ENGINEERING SAMPLE

**STANDARDS:** FCC Part 15, Subpart C (Section 15.247),  
ANSI C63.4-2003

The above equipment has been tested by **Advance Data Technology Corporation**, and found compliance with the requirement of the above standards. The test record, data evaluation & Equipment Under Test (EUT) configurations represented herein are true and accurate accounts of the measurements of the sample's EMC characteristics under the conditions specified in this report.

**PREPARED BY :** Jessie Wang , **DATE:** Jun. 28, 2006  
Jessie Wang

**TECHNICAL**  
**ACCEPTANCE :** Long Chen , **DATE:** Jun. 28, 2006  
Responsible for RF  
Long Chen

**APPROVED BY :** Gary Chang , **DATE:** Jun. 28, 2006  
Gary Chang / Supervisor

## 2. SUMMARY OF TEST RESULTS

The EUT has been tested according to the following specifications:

APPLIED STANDARD: FCC Part 15, Subpart C			
STANDARD SECTION	TEST TYPE AND LIMIT	RESULT	REMARK
15.207	AC Power Conducted Emission	PASS	Meet the requirement of limit. Minimum passing margin is -16.24dB at 0.177MHz.
15.247(a)(2)	Spectrum Bandwidth of a Direct Sequence Spread Spectrum System Limit : min. 500kHz	PASS	Meet the requirement of limit.
15.247(b)	Maximum Peak Output Power Limit: max. 30dBm	PASS	Meet the requirement of limit.
15.247(d)	Transmitter Radiated Emissions Limit: Table 15.209	PASS	Meet the requirement of limit. Minimum passing margin is -1.01dB at 2484.00MHz.
15.247(e)	Power Spectral Density Limit: max. 8dBm	PASS	Meet the requirement of limit.
15.247(d)	Band Edge Measurement Limit: 20dB less than the peak value of fundamental frequency	PASS	Meet the requirement of limit.

### 2.1 MEASUREMENT UNCERTAINTY

Where relevant, the following measurement uncertainty levels have been estimated for tests performed on the EUT as specified in CISPR 16-4:

MEASUREMENT	FREQUENCY	UNCERTAINTY
Conducted emissions	9kHz ~ 30MHz	2.44dB
Radiated emissions	30MHz ~ 200MHz (Horizontal)	3.47 dB
	30MHz ~ 200MHz (Vertical)	3.62 dB
	200MHz ~ 1000MHz (Horizontal)	3.64 dB
	200MHz ~ 1000MHz (Vertical)	3.62 dB
	1GHz ~ 18GHz	2.26 dB
	18GHz ~ 40GHz	1.94 dB

This uncertainty represents an expanded uncertainty expressed at approximately the 95% confidence level using a coverage factor of  $k = 2$ .

### 3. GENERAL INFORMATION

#### 3.1 GENERAL DESCRIPTION OF EUT

<b>PRODUCT</b>	RangeMax NEXT Wireless mPCI
<b>MODEL NO.</b>	WNR834M
<b>FCC ID</b>	PY306200049
<b>POWER SUPPLY</b>	3.3Vdc from host equipment
<b>MODULATION TYPE</b>	CCK, DQPSK, DBPSK for DSSS 64QAM, 16QAM, QPSK, BPSK for OFDM
<b>MODULATION TECHNOLOGY</b>	DSSS, OFDM
<b>TRANSFER RATE</b>	802.11b: 11/ 5.5/ 2/ 1Mbps 802.11g: 54/ 48/ 36/ 24/ 18/ 12/ 9/ 6Mbps Draft 802.11n (20MHz): 144.444/ 130.000/ 115.556/ 86.667/ 57.778/ 43.333/ 28.889/ 14.444/ 72.2/ 65.0/ 57.8/ 43.3/ 28.9/ 21.7/ 14.4/ 7.2Mbps Draft 802.11n (40MHz): 300/ 270/ 240/ 180/ 120/ 90/ 60/ 30/ 150/ 135/ 120/ 90/ 60/ 45/ 30/ 15Mbps
<b>FREQUENCY RANGE</b>	2400MHz ~ 2483.5MHz
<b>NUMBER OF CHANNEL</b>	11 for 802.11b, 802.11g, draft 802.11n (20MHz) 7 for draft 802.11n (40MHz), 802.11b (CB mode)
<b>MAXIMUM OUTPUT POWER</b>	179.693mW
<b>ANTENNA TYPE</b>	Dipole antenna-A with 2.18dBi gain Dipole antenna-B with 2.18dBi gain Dipole antenna-C with 2.18dBi gain
<b>DATA CABLE</b>	NA
<b>I/O PORTS</b>	NA

**NOTE:**

1. The EUT incorporates a MIMO function with 802.11b, 802.11g, draft 802.11n. Physically, the card provides two completed transmitters and three receivers.
2. The EUT is 2 \* 3 spatial MIMO (2Tx & 3Rx) without beam forming function that only operate dual chain configuration (both chain 0 and chain 1 transceivers are operational).
3. When the EUT operating in 802.11b, 802.11g, the software operation, which is defined by manufacturer, only set dual Tx.
4. When the EUT operating in 802.11b with "Channel Binding function", the software operation, which is defined by manufacturer, only set dual Tx.
5. When the EUT operating in draft 802.11n, the software operation, which is defined by manufacturer, only set 0 ~ 15 of "MCS" (MCS: Modulation and Coding Schemes) for dual Tx.
6. The EUT complies with draft 802.11n standards and backwards compatible with 802.11b, 802.11g products.
7. The EUT operates in the 2.4GHz frequency spectrum with throughput of up to 300Mbps.
8. The above EUT information was declared by manufacturer and for more detailed features description, please refer to the manufacturer's specifications or user's manual.

### 3.2 DESCRIPTION OF TEST MODES

Eleven channels are provided for 802.11b, 802.11g, draft 802.11n (20MHz):

CHANNEL	FREQUENCY	CHANNEL	FREQUENCY
1	2412MHz	7	2442MHz
2	2417MHz	8	2447MHz
3	2422MHz	9	2452MHz
4	2427MHz	10	2457MHz
5	2432MHz	11	2462MHz
6	2437MHz		

Seven channels are provided for 802.11b(CB mode), draft 802.11n (40MHz):

CHANNEL	FREQUENCY	CHANNEL	FREQUENCY
1	2422MHz	5	2442MHz
2	2427MHz	6	2447MHz
3	2432MHz	7	2452MHz
4	2437MHz		

#### 3.2.1 CONFIGURATION OF SYSTEM UNDER TEST

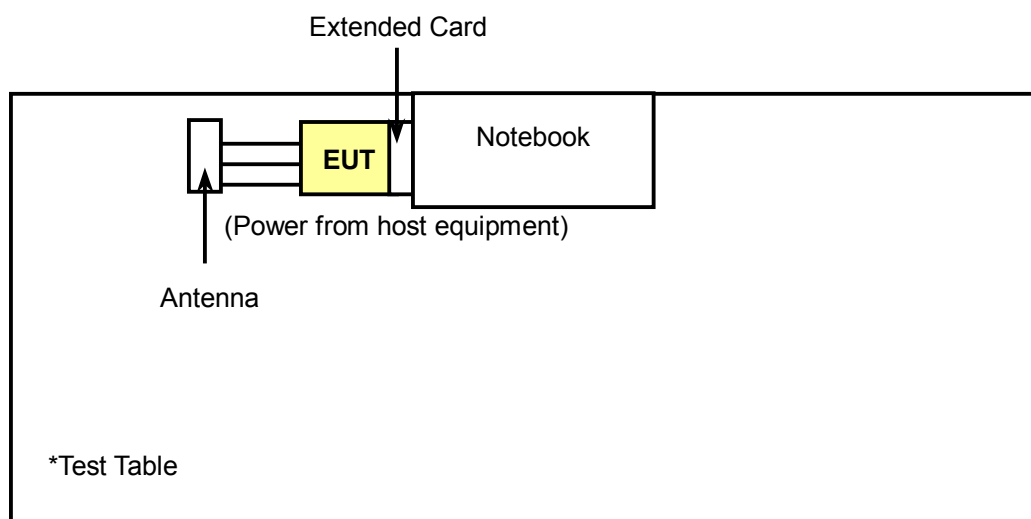

### 3.2.2 TEST MODE APPLICABILITY AND TESTED CHANNEL DETAIL

EUT CONFIGURE MODE	APPLICABLE TO				DESCRIPTION
	PLC	RE < 1G	RE ≥ 1G	APCM	
-	√	√	√	√	-

Where **PLC**: Power Line Conducted Emission

**RE < 1G**: Radiated Emission below 1GHz

**RE ≥ 1G**: Radiated Emission above 1GHz

**APCM**: Antenna Port Conducted Measurement

#### **POWER LINE CONDUCTED EMISSION TEST:**

- Pre-Scan has been conducted to determine the worst-case mode from all possible combinations between available modulations, data rates and antenna ports (if EUT with antenna diversity architecture).
- Following channel(s) was (were) selected for the final test as listed below.

MODE	AVAILABLE CHANNEL	TESTED CHANNEL	MODULATION TECHNOLOGY	MODULATION TYPE	DATA RATE (Mbps)	TX CONDITION
802.11g	1 to 11	1, 6, 11	OFDM	BPSK	6	Dual
Draft 802.11n (20MHz)	1 to 11	1, 6, 11	OFDM	BPSK	7.2	Dual
Draft 802.11n (40MHz)	1 to 7	1, 4, 7	OFDM	BPSK	15	Dual
802.11b(CB Mode)	1 to 7	1, 4, 7	DSSS	DBPSK	1	Dual

#### **RADIATED EMISSION TEST (BELOW 1 GHz):**

- Pre-Scan has been conducted to determine the worst-case mode from all possible combinations between available modulations, data rates and antenna ports (if EUT with antenna diversity architecture).
- Following channel(s) was (were) selected for the final test as listed below.

MODE	AVAILABLE CHANNEL	TESTED CHANNEL	MODULATION TECHNOLOGY	MODULATION TYPE	DATA RATE (Mbps)	TX CONDITION
802.11g	1 to 11	1	OFDM	BPSK	6	Dual
Draft 802.11n (20MHz)	1 to 11	1	OFDM	BPSK	7.2	Dual
Draft 802.11n (40MHz)	1 to 7	1	OFDM	BPSK	15	Dual
802.11b(CB Mode)	1 to 7	1	DSSS	DBPSK	1	Dual



**RADIATED EMISSION TEST (ABOVE 1 GHz):**

- Pre-Scan has been conducted to determine the worst-case mode from all possible combinations between available modulations, data rates and antenna ports (if EUT with antenna diversity architecture).
- Following channel(s) was (were) selected for the final test as listed below.

MODE	AVAILABLE CHANNEL	TESTED CHANNEL	MODULATION TECHNOLOGY	MODULATION TYPE	DATA RATE (Mbps)	TX CONDITION
802.11b	1 to 11	1, 6, 11	DSSS	DBPSK	1	Dual
802.11g	1 to 11	1, 6, 11	OFDM	BPSK	6	Dual
Draft 802.11n (20MHz)	1 to 11	1, 6, 11	OFDM	BPSK	7.2	Dual
Draft 802.11n (40MHz)	1 to 7	1, 4, 7	OFDM	BPSK	15	Dual
802.11b(CB Mode)	1 to 7	1, 4, 7	DSSS	DBPSK	1	Dual

**BANDEDGE MEASUREMENT:**

- Pre-Scan has been conducted to determine the worst-case mode from all possible combinations between available modulations, data rates and antenna ports (if EUT with antenna diversity architecture).
- Following channel(s) was (were) selected for the final test as listed below.

MODE	AVAILABLE CHANNEL	TESTED CHANNEL	MODULATION TECHNOLOGY	MODULATION TYPE	DATA RATE (Mbps)	TX CONDITION
802.11b	1 to 11	1, 11	DSSS	DBPSK	1	Dual
802.11g	1 to 11	1, 11	OFDM	BPSK	6	Dual
Draft 802.11n (20MHz)	1 to 11	1, 11	OFDM	BPSK	7.2	Dual
Draft 802.11n (40MHz)	1 to 7	1, 7	OFDM	BPSK	15	Dual
802.11b(CB Mode)	1 to 7	1, 7	DSSS	DBPSK	1	Dual

**ANTENNA PORT CONDUCTED MEASUREMENT:**

- Pre-Scan has been conducted to determine the worst-case mode from all possible combinations between available modulations, data rates and antenna ports (if EUT with antenna diversity architecture).
- Following channel(s) was (were) selected for the final test as listed below.

MODE	AVAILABLE CHANNEL	TESTED CHANNEL	MODULATION TECHNOLOGY	MODULATION TYPE	DATA RATE (Mbps)	TX CONDITION
802.11b	1 to 11	1, 6, 11	DSSS	DBPSK	1	Dual
802.11g	1 to 11	1, 6, 11	OFDM	BPSK	6	Dual
Draft 802.11n (20MHz)	1 to 11	1, 6, 11	OFDM	BPSK	7.2	Dual
Draft 802.11n (40MHz)	1 to 7	1, 4, 7	OFDM	BPSK	15	Dual
802.11b(CB Mode)	1 to 7	1, 4, 7	DSSS	DBPSK	1	Dual



### 3.3 GENERAL DESCRIPTION OF APPLIED STANDARDS

The EUT is a RF product. According to the specifications of the manufacturer, it must comply with the requirements of the following standards:

**FCC Part 15, Subpart C. (15.247)**

**ANSI C63.4-2003**

All test items have been performed and recorded as per the above standards.

**NOTE:** The EUT is also considered as a kind of computer peripheral, because the connection to computer is necessary for typical use. It has been verified to comply with the requirements of FCC Part 15, Subpart B, Class B (DoC). The test report has been issued separately.

### 3.4 DESCRIPTION OF SUPPORT UNITS

The EUT has been tested as an independent unit together with other necessary accessories or support units. The following support units or accessories were used to form a representative test configuration during the tests.

NO.	PRODUCT	BRAND	MODEL NO.	SERIAL NO.	FCC ID
1	NOTEBOOK COMPUTER	DELL	PP05L	12130898320	E2K24CLNS

NO.	SIGNAL CABLE DESCRIPTION OF THE ABOVE SUPPORT UNITS
1	NA

**NOTE:** All power cords of the above support units are non shielded (1.8m).

## 4. TEST TYPES AND RESULTS

### 4.1 CONDUCTED EMISSION MEASUREMENT

#### 4.1.1 LIMITS OF CONDUCTED EMISSION MEASUREMENT

FREQUENCY OF EMISSION (MHz)	CONDUCTED LIMIT (dB $\mu$ V)	
	Quasi-peak	Average
0.15-0.5	66 to 56	56 to 46
0.5-5	56	46
5-30	60	50

- NOTE:**
1. The lower limit shall apply at the transition frequencies.
  2. The limit decreases in line with the logarithm of the frequency in the range of 0.15 to 0.50 MHz.
  3. All emanations from a class A/B digital device or system, including any network of conductors and apparatus connected thereto, shall not exceed the level of field strengths specified above.

#### 4.1.2 TEST INSTRUMENTS

DESCRIPTION & MANUFACTURER	MODEL NO.	SERIAL NO.	CALIBRATED UNTIL
Test Receiver ROHDE & SCHWARZ	ESCS30	100291	Nov. 11, 2006
RF signal cable Woken	5D-FB	Cable-HYC01-01	Jan. 06, 2007
LISN ROHDE & SCHWARZ	ESH3-Z5	100312	Feb. 15, 2007
LISN ROHDE & SCHWARZ	ESH2-Z5	100104	Feb. 07, 2007
Software ADT	ADT_Cond_V3	NA	NA

- NOTE:**
1. The calibration interval of the above test instruments is 12 months and the calibrations are traceable to NML/ROC and NIST/USA.
  2. The test was performed in HwaYa Shielded Room 1.
  3. The VCCI Site Registration No. is C-2040.

#### 4.1.3 TEST PROCEDURES

- a. The EUT was placed 0.4 meters from the conducting wall of the shielded room with EUT being connected to the power mains through a line impedance stabilization network (LISN). Other support units were connected to the power mains through another LISN. The two LISNs provide 50 ohm/ 50uH of coupling impedance for the measuring instrument.
- b. Both lines of the power mains connected to the EUT were checked for maximum conducted interference.
- c. The frequency range from 150kHz to 30MHz was searched. Emission levels under (Limit - 20dB) was not recorded.

#### 4.1.4 DEVIATION FROM TEST STANDARD

No deviation

#### 4.1.5 TEST SETUP

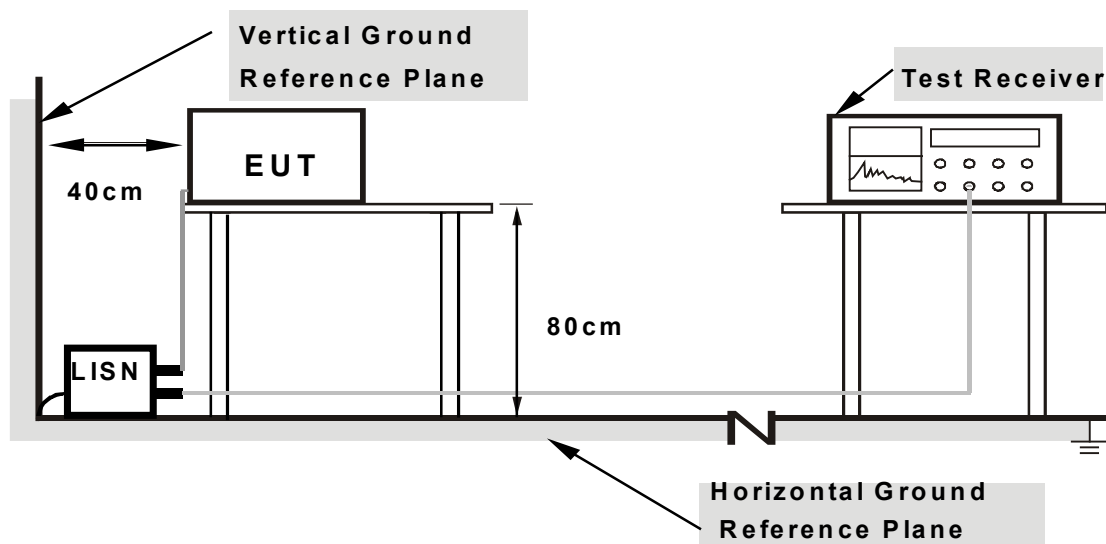

**Note: 1. Support units were connected to second LISN.**

**2. Both of LISNs (AMN) are 80 cm from EUT and at least 80 from other units and other metal planes**

For the actual test configuration, please refer to the related item – Photographs of the Test Configuration.

#### 4.1.6 EUT OPERATING CONDITIONS

- a. Connected the EUT into Notebook via extended card placed on a testing table.
- b. The notebook system ran a test program (provided by manufacturer) to enable EUT under transmission condition continuously at specific channel frequency.
- c. The notebook system sent "H" messages to its screen.

#### 4.1.7 TEST RESULTS

##### CONDUCTED WORST-CASE DATA: 802.11g OFDM MODULATION:

EUT TEST CONDITION		MEASUREMENT DETAIL	
CHANNEL	Channel 1	PHASE	Line 1
MODULATION TYPE	BPSK	6dB BANDWIDTH	9 kHz
TRANSFER RATE	6Mbps	INPUT POWER (SYSTEM)	120Vac, 60 Hz
ENVIRONMENTAL CONDITIONS	20deg. C, 60%RH, 991hPa	TESTED BY	Match Tsui

No	Freq. [MHz]	Corr. Factor [dB]	Reading Value [dB (uV)]		Emission Level [dB (uV)]		Limit [dB (uV)]		Margin (dB)	
			Q.P.	AV.	Q.P.	AV.	Q.P.	AV.	Q.P.	AV.
			1	0.193	0.10	40.29	-	40.39	-	63.91
2	0.291	0.10	32.39	-	32.49	-	60.51	50.51	-28.02	-
3	0.408	0.10	33.12	-	33.22	-	57.69	47.69	-24.47	-
4	0.623	0.14	33.24	-	33.38	-	56.00	46.00	-22.62	-
5	2.105	0.21	31.05	-	31.26	-	56.00	46.00	-24.74	-
6	10.469	0.48	35.27	-	35.75	-	60.00	50.00	-24.25	-

- REMARKS:**
1. Q.P. and AV. are abbreviations of quasi-peak and average individually.
  2. "-": The Quasi-peak reading value also meets average limit and measurement with the average detector is unnecessary.
  3. The emission levels of other frequencies were very low against the limit.
  4. Margin value = Emission level - Limit value
  5. Correction factor = Insertion loss + Cable loss
  6. Emission Level = Correction Factor + Reading Value.

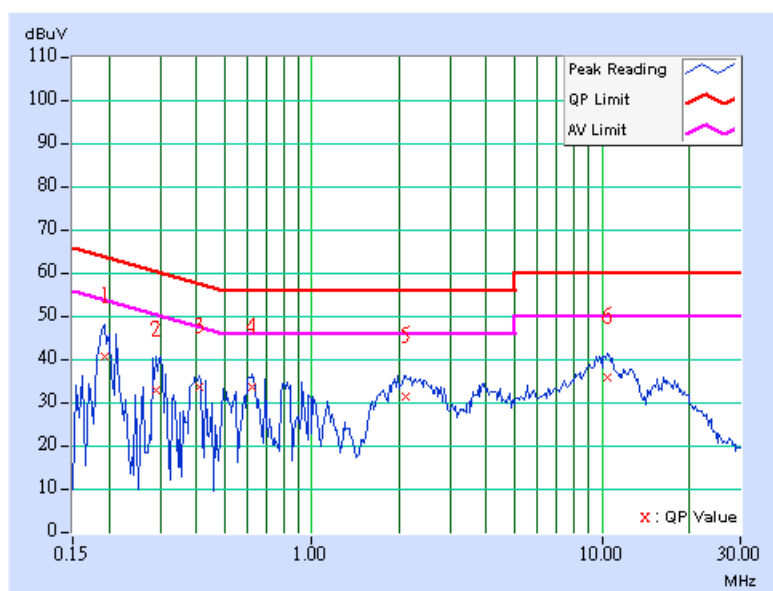

EUT TEST CONDITION		MEASUREMENT DETAIL	
CHANNEL	Channel 1	PHASE	Line 2
MODULATION TYPE	BPSK	6dB BANDWIDTH	9 kHz
TRANSFER RATE	6Mbps	INPUT POWER (SYSTEM)	120Vac, 60 Hz
ENVIRONMENTAL CONDITIONS	20deg. C, 60%RH, 991hPa	TESTED BY	Match Tsui

No	Freq. [MHz]	Corr. Factor [dB]	Reading Value [dB (uV)]		Emission Level [dB (uV)]		Limit [dB (uV)]		Margin (dB)	
			Q.P.	AV.	Q.P.	AV.	Q.P.	AV.	Q.P.	AV.
			1	0.186	0.10	39.36	-	39.46	-	64.20
2	0.209	0.10	44.99	-	45.09	-	63.26	53.26	-18.17	-
3	0.408	0.10	35.54	-	35.64	-	57.69	47.69	-22.05	-
4	0.607	0.10	34.65	-	34.75	-	56.00	46.00	-21.25	-
5	2.301	0.23	30.55	-	30.78	-	56.00	46.00	-25.22	-
6	10.141	0.46	35.84	-	36.30	-	60.00	50.00	-23.70	-

- REMARKS:**
1. Q.P. and AV. are abbreviations of quasi-peak and average individually.
  2. "-": The Quasi-peak reading value also meets average limit and measurement with the average detector is unnecessary.
  3. The emission levels of other frequencies were very low against the limit.
  4. Margin value = Emission level - Limit value
  5. Correction factor = Insertion loss + Cable loss
  6. Emission Level = Correction Factor + Reading Value.

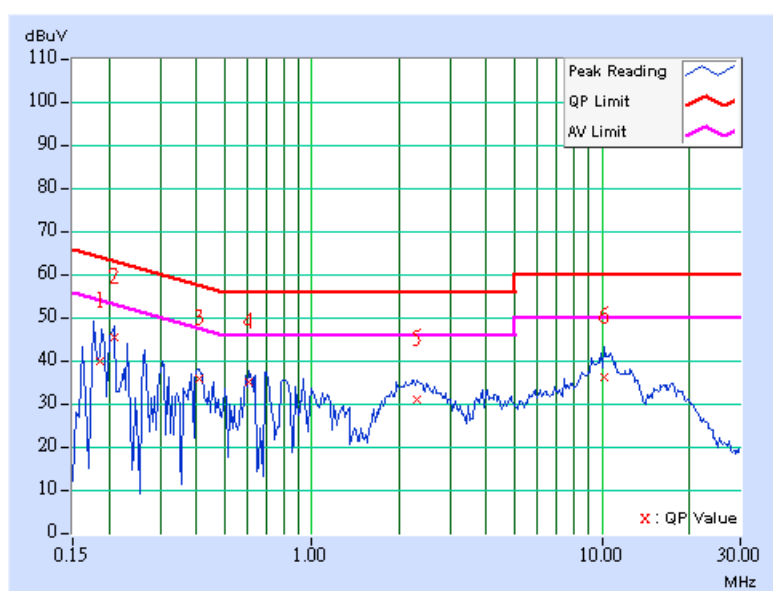



EUT TEST CONDITION		MEASUREMENT DETAIL	
CHANNEL	Channel 6	PHASE	Line 1
MODULATION TYPE	BPSK	6dB BANDWIDTH	9 kHz
TRANSFER RATE	6Mbps	INPUT POWER (SYSTEM)	120Vac, 60 Hz
ENVIRONMENTAL CONDITIONS	20deg. C, 60%RH, 991hPa	TESTED BY	Match Tsui

No	Freq. [MHz]	Corr. Factor [dB]	Reading Value [dB (uV)]		Emission Level [dB (uV)]		Limit [dB (uV)]		Margin (dB)	
			Q.P.	AV.	Q.P.	AV.	Q.P.	AV.	Q.P.	AV.
1	0.205	0.10	45.27	-	45.37	-	63.42	53.42	-18.05	-
2	0.295	0.10	36.06	-	36.16	-	60.40	50.40	-24.24	-
3	0.591	0.13	31.20	-	31.33	-	56.00	46.00	-24.67	-
4	0.701	0.15	32.64	-	32.79	-	56.00	46.00	-23.21	-
5	2.223	0.23	30.69	-	30.92	-	56.00	46.00	-25.08	-
6	10.777	0.49	34.76	-	35.25	-	60.00	50.00	-24.75	-

- REMARKS:**
1. Q.P. and AV. are abbreviations of quasi-peak and average individually.
  2. "-": The Quasi-peak reading value also meets average limit and measurement with the average detector is unnecessary.
  3. The emission levels of other frequencies were very low against the limit.
  4. Margin value = Emission level - Limit value
  5. Correction factor = Insertion loss + Cable loss
  6. Emission Level = Correction Factor + Reading Value.

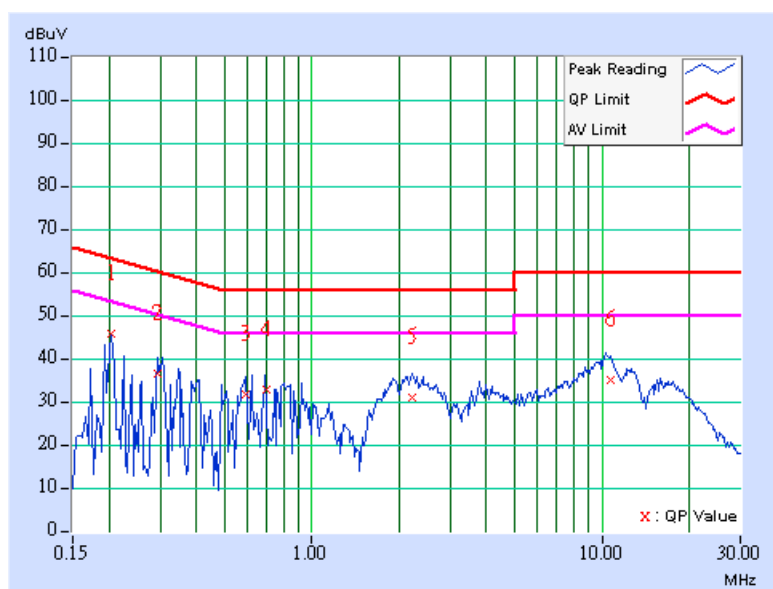

EUT TEST CONDITION		MEASUREMENT DETAIL	
CHANNEL	Channel 6	PHASE	Line 2
MODULATION TYPE	BPSK	6dB BANDWIDTH	9 kHz
TRANSFER RATE	6Mbps	INPUT POWER (SYSTEM)	120Vac, 60 Hz
ENVIRONMENTAL CONDITIONS	20deg. C, 60%RH, 991hPa	TESTED BY	Match Tsui

No	Freq. [MHz]	Corr. Factor [dB]	Reading Value [dB (uV)]		Emission Level [dB (uV)]		Limit [dB (uV)]		Margin (dB)	
			Q.P.	AV.	Q.P.	AV.	Q.P.	AV.	Q.P.	AV.
1	0.162	0.10	40.44	-	40.54	-	65.38	55.38	-24.84	-
2	0.201	0.10	46.01	-	46.11	-	63.58	53.58	-17.47	-
3	0.232	0.10	40.88	-	40.98	-	62.38	52.38	-21.40	-
4	0.627	0.10	35.19	-	35.29	-	56.00	46.00	-20.71	-
5	2.234	0.22	29.72	-	29.94	-	56.00	46.00	-26.06	-
6	10.477	0.47	35.81	-	36.28	-	60.00	50.00	-23.72	-

- REMARKS:**
1. Q.P. and AV. are abbreviations of quasi-peak and average individually.
  2. "-": The Quasi-peak reading value also meets average limit and measurement with the average detector is unnecessary.
  3. The emission levels of other frequencies were very low against the limit.
  4. Margin value = Emission level - Limit value
  5. Correction factor = Insertion loss + Cable loss
  6. Emission Level = Correction Factor + Reading Value.

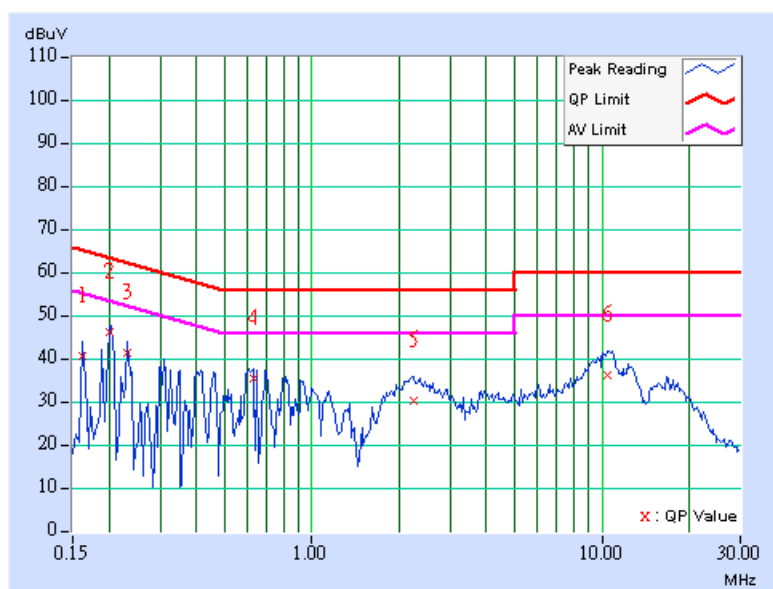

EUT TEST CONDITION		MEASUREMENT DETAIL	
CHANNEL	Channel 11	PHASE	Line 1
MODULATION TYPE	BPSK	6dB BANDWIDTH	9 kHz
TRANSFER RATE	6Mbps	INPUT POWER (SYSTEM)	120Vac, 60 Hz
ENVIRONMENTAL CONDITIONS	20deg. C, 60%RH, 991hPa	TESTED BY	Match Tsui

No	Freq. [MHz]	Corr. Factor [dB]	Reading Value [dB (uV)]		Emission Level [dB (uV)]		Limit [dB (uV)]		Margin (dB)	
			Q.P.	AV.	Q.P.	AV.	Q.P.	AV.	Q.P.	AV.
1	0.181	0.10	47.10	-	47.20	-	64.43	54.43	-17.23	-
2	0.240	0.10	39.85	-	39.95	-	62.10	52.10	-22.15	-
3	0.357	0.10	38.84	-	38.94	-	58.80	48.80	-19.86	-
4	0.970	0.20	33.23	-	33.43	-	56.00	46.00	-22.57	-
5	2.230	0.23	30.81	-	31.04	-	56.00	46.00	-24.96	-
6	10.727	0.48	36.09	-	36.57	-	60.00	50.00	-23.43	-

- REMARKS:**
1. Q.P. and AV. are abbreviations of quasi-peak and average individually.
  2. "-": The Quasi-peak reading value also meets average limit and measurement with the average detector is unnecessary.
  3. The emission levels of other frequencies were very low against the limit.
  4. Margin value = Emission level - Limit value
  5. Correction factor = Insertion loss + Cable loss
  6. Emission Level = Correction Factor + Reading Value.

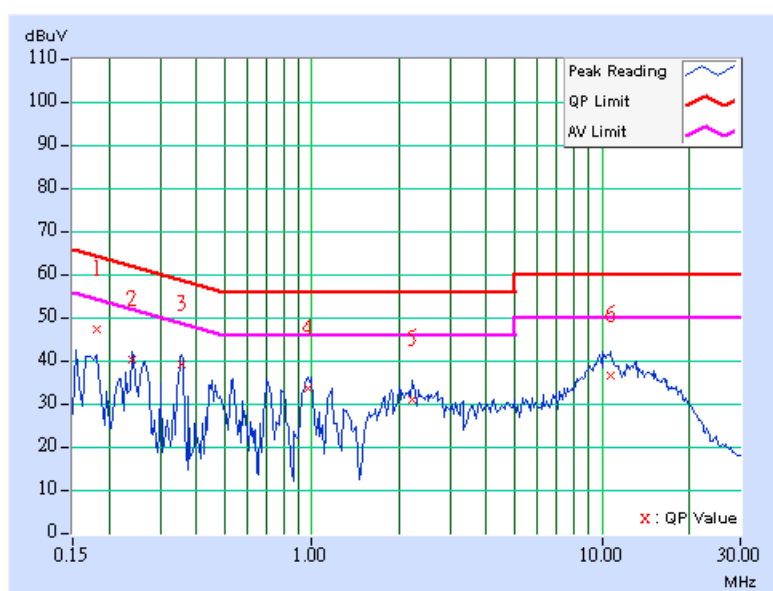

EUT TEST CONDITION		MEASUREMENT DETAIL	
CHANNEL	Channel 11	PHASE	Line 2
MODULATION TYPE	BPSK	6dB BANDWIDTH	9 kHz
TRANSFER RATE	6Mbps	INPUT POWER (SYSTEM)	120Vac, 60 Hz
ENVIRONMENTAL CONDITIONS	20deg. C, 60%RH, 991hPa	TESTED BY	Match Tsui

No	Freq. [MHz]	Corr. Factor [dB]	Reading Value [dB (uV)]		Emission Level [dB (uV)]		Limit [dB (uV)]		Margin (dB)	
			Q.P.	AV.	Q.P.	AV.	Q.P.	AV.	Q.P.	AV.
1	0.177	0.10	47.91	-	48.01	-	64.61	54.61	-16.60	-
2	0.267	0.10	40.64	-	40.74	-	61.20	51.20	-20.46	-
3	0.357	0.10	38.86	-	38.96	-	58.80	48.80	-19.84	-
4	0.537	0.10	34.11	-	34.21	-	56.00	46.00	-21.79	-
5	2.238	0.22	30.79	-	31.01	-	56.00	46.00	-24.99	-
6	10.641	0.47	35.96	-	36.43	-	60.00	50.00	-23.57	-

- REMARKS:**
1. Q.P. and AV. are abbreviations of quasi-peak and average individually.
  2. "-": The Quasi-peak reading value also meets average limit and measurement with the average detector is unnecessary.
  3. The emission levels of other frequencies were very low against the limit.
  4. Margin value = Emission level - Limit value
  5. Correction factor = Insertion loss + Cable loss
  6. Emission Level = Correction Factor + Reading Value.

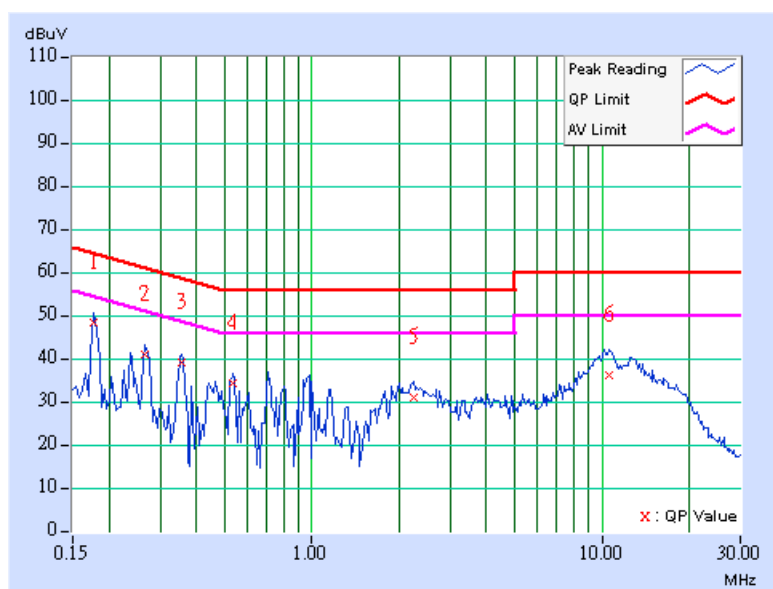

**DRAFT 802.11n (20MHz) OFDM MODULATION: DUAL TX:**

EUT TEST CONDITION		MEASUREMENT DETAIL	
CHANNEL	Channel 1	PHASE	Line 1
MODULATION TYPE	BPSK	6dB BANDWIDTH	9 kHz
TRANSFER RATE	7.2Mbps	INPUT POWER (SYSTEM)	120Vac, 60 Hz
ENVIRONMENTAL CONDITIONS	25deg. C, 65%RH, 991hPa	TESTED BY	Match Tsui

No	Freq. [MHz]	Corr. Factor (dB)	Reading Value [dB (uV)]		Emission Level [dB (uV)]		Limit [dB (uV)]		Margin (dB)	
			Q.P.	AV.	Q.P.	AV.	Q.P.	AV.	Q.P.	AV.
			1	0.185	0.10	41.78	-	41.88	-	64.25
2	0.244	0.10	38.80	-	38.90	-	61.97	51.97	-23.07	-
3	0.470	0.11	28.43	-	28.54	-	56.51	46.51	-27.97	-
4	0.970	0.20	30.00	-	30.20	-	56.00	46.00	-25.80	-
5	2.266	0.24	29.86	-	30.10	-	56.00	46.00	-25.90	-
6	10.480	0.48	35.46	-	35.94	-	60.00	50.00	-24.06	-

- REMARKS:**
1. Q.P. and AV. are abbreviations of quasi-peak and average individually.
  2. "-": The Quasi-peak reading value also meets average limit and measurement with the average detector is unnecessary.
  3. The emission levels of other frequencies were very low against the limit.
  4. Margin value = Emission level - Limit value
  5. Correction factor = Insertion loss + Cable loss
  6. Emission Level = Correction Factor + Reading Value.

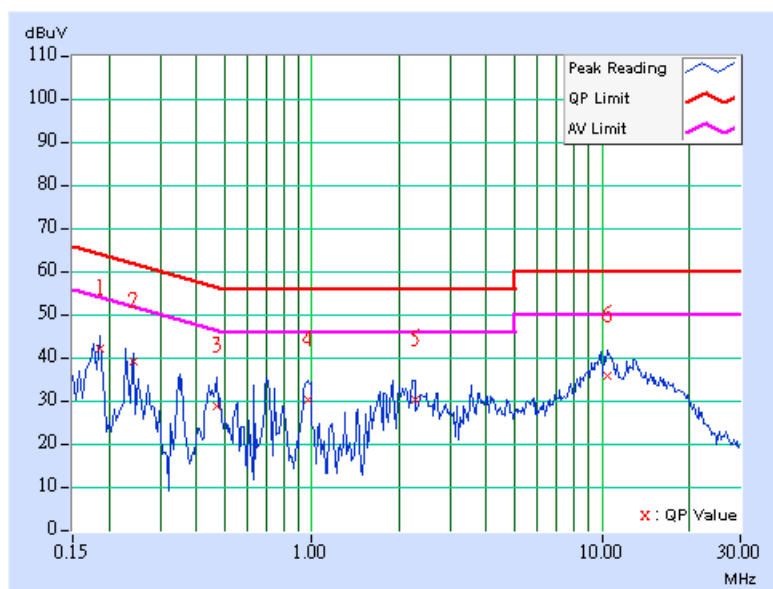

EUT TEST CONDITION		MEASUREMENT DETAIL	
CHANNEL	Channel 1	PHASE	Line 2
MODULATION TYPE	BPSK	6dB BANDWIDTH	9 kHz
TRANSFER RATE	7.2Mbps	INPUT POWER (SYSTEM)	120Vac, 60 Hz
ENVIRONMENTAL CONDITIONS	25deg. C, 65%RH, 991hPa	TESTED BY	Match Tsui

No	Freq. [MHz]	Corr. Factor [dB]	Reading Value [dB (uV)]		Emission Level [dB (uV)]		Limit [dB (uV)]		Margin (dB)	
			Q.P.	AV.	Q.P.	AV.	Q.P.	AV.	Q.P.	AV.
1	0.181	0.10	47.28	-	47.38	-	64.43	54.43	-17.05	-
2	0.238	0.10	39.61	-	39.71	-	62.16	52.16	-22.45	-
3	0.361	0.10	39.12	-	39.22	-	58.71	48.71	-19.49	-
4	0.982	0.10	34.01	-	34.11	-	56.00	46.00	-21.89	-
5	2.250	0.22	31.27	-	31.49	-	56.00	46.00	-24.51	-
6	10.180	0.46	35.49	-	35.95	-	60.00	50.00	-24.05	-

- REMARKS:**
1. Q.P. and AV. are abbreviations of quasi-peak and average individually.
  2. "-": The Quasi-peak reading value also meets average limit and measurement with the average detector is unnecessary.
  3. The emission levels of other frequencies were very low against the limit.
  4. Margin value = Emission level - Limit value
  5. Correction factor = Insertion loss + Cable loss
  6. Emission Level = Correction Factor + Reading Value.

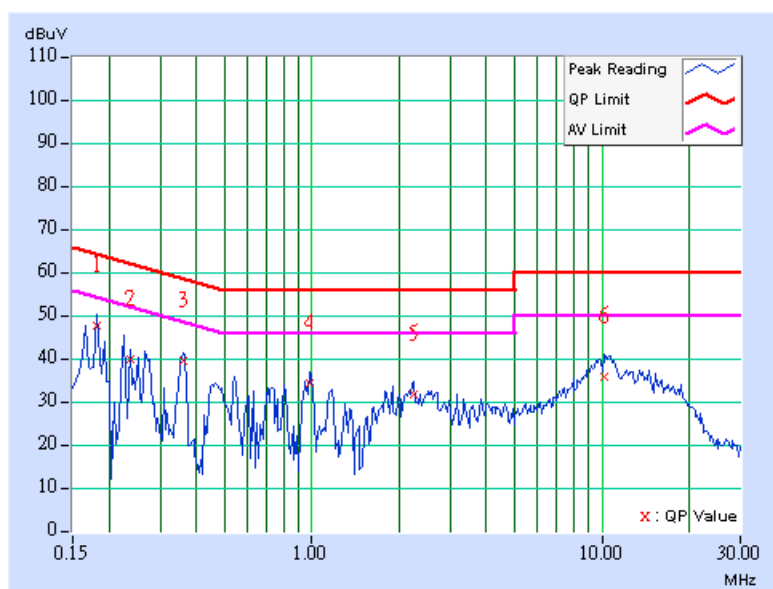

EUT TEST CONDITION		MEASUREMENT DETAIL	
CHANNEL	Channel 6	PHASE	Line 1
MODULATION TYPE	BPSK	6dB BANDWIDTH	9 kHz
TRANSFER RATE	7.2Mbps	INPUT POWER (SYSTEM)	120Vac, 60 Hz
ENVIRONMENTAL CONDITIONS	25deg. C, 65%RH, 991hPa	TESTED BY	Match Tsui

No	Freq. [MHz]	Corr. Factor [dB]	Reading Value [dB (uV)]		Emission Level [dB (uV)]		Limit [dB (uV)]		Margin (dB)	
			Q.P.	AV.	Q.P.	AV.	Q.P.	AV.	Q.P.	AV.
1	0.177	0.10	47.85	-	47.95	-	64.61	54.61	-16.66	-
2	0.267	0.10	39.23	-	39.33	-	61.20	51.20	-21.87	-
3	0.361	0.10	38.28	-	38.38	-	58.71	48.71	-20.33	-
4	0.974	0.20	32.01	-	32.21	-	56.00	46.00	-23.79	-
5	2.230	0.23	30.73	-	30.96	-	56.00	46.00	-25.04	-
6	10.230	0.47	35.11	-	35.58	-	60.00	50.00	-24.42	-

- REMARKS:**
1. Q.P. and AV. are abbreviations of quasi-peak and average individually.
  2. "-": The Quasi-peak reading value also meets average limit and measurement with the average detector is unnecessary.
  3. The emission levels of other frequencies were very low against the limit.
  4. Margin value = Emission level - Limit value
  5. Correction factor = Insertion loss + Cable loss
  6. Emission Level = Correction Factor + Reading Value.

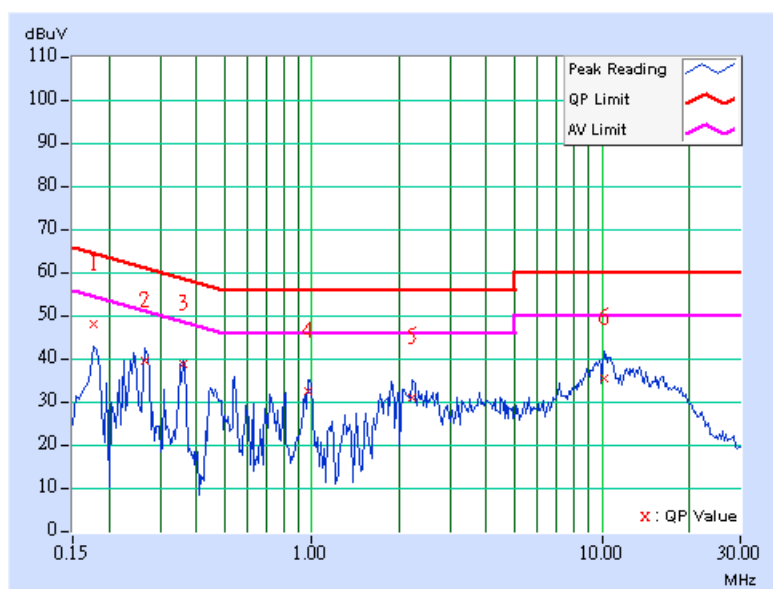

EUT TEST CONDITION		MEASUREMENT DETAIL	
CHANNEL	Channel 6	PHASE	Line 2
MODULATION TYPE	BPSK	6dB BANDWIDTH	9 kHz
TRANSFER RATE	7.2Mbps	INPUT POWER (SYSTEM)	120Vac, 60 Hz
ENVIRONMENTAL CONDITIONS	25deg. C, 65%RH, 991hPa	TESTED BY	Match Tsui

No	Freq. [MHz]	Corr. Factor [dB]	Reading Value [dB (uV)]		Emission Level [dB (uV)]		Limit [dB (uV)]		Margin (dB)	
			Q.P.	AV.	Q.P.	AV.	Q.P.	AV.	Q.P.	AV.
1	0.181	0.10	47.19	-	47.29	-	64.43	54.43	-17.14	-
2	0.271	0.10	40.25	-	40.35	-	61.08	51.08	-20.73	-
3	0.365	0.10	37.56	-	37.66	-	58.62	48.62	-20.96	-
4	0.990	0.10	33.08	-	33.18	-	56.00	46.00	-22.82	-
5	2.691	0.26	27.38	-	27.64	-	56.00	46.00	-28.36	-
6	10.664	0.47	35.80	-	36.27	-	60.00	50.00	-23.73	-

- REMARKS:**
1. Q.P. and AV. are abbreviations of quasi-peak and average individually.
  2. "-": The Quasi-peak reading value also meets average limit and measurement with the average detector is unnecessary.
  3. The emission levels of other frequencies were very low against the limit.
  4. Margin value = Emission level - Limit value
  5. Correction factor = Insertion loss + Cable loss
  6. Emission Level = Correction Factor + Reading Value.

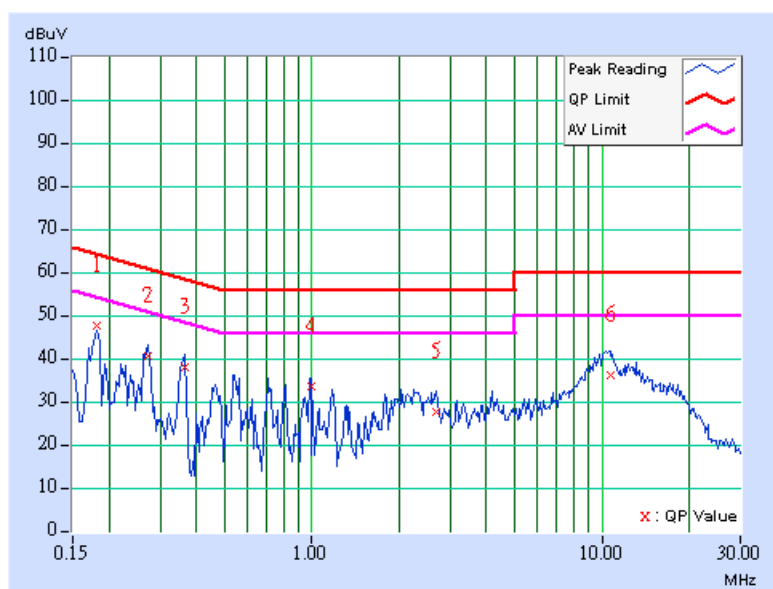



EUT TEST CONDITION		MEASUREMENT DETAIL	
CHANNEL	Channel 11	PHASE	Line 1
MODULATION TYPE	BPSK	6dB BANDWIDTH	9 kHz
TRANSFER RATE	7.2Mbps	INPUT POWER (SYSTEM)	120Vac, 60 Hz
ENVIRONMENTAL CONDITIONS	25deg. C, 65%RH, 991hPa	TESTED BY	Match Tsui

No	Freq. [MHz]	Corr. Factor [dB]	Reading Value [dB (uV)]		Emission Level [dB (uV)]		Limit [dB (uV)]		Margin (dB)	
			Q.P.	AV.	Q.P.	AV.	Q.P.	AV.	Q.P.	AV.
1	0.181	0.10	46.68	-	46.78	-	64.43	54.43	-17.65	-
2	0.267	0.10	39.58	-	39.68	-	61.20	51.20	-21.52	-
3	0.357	0.10	38.34	-	38.44	-	58.80	48.80	-20.36	-
4	0.966	0.19	32.42	-	32.61	-	56.00	46.00	-23.39	-
5	2.094	0.21	28.36	-	28.57	-	56.00	46.00	-27.43	-
6	10.691	0.48	35.00	-	35.48	-	60.00	50.00	-24.52	-

- REMARKS:**
1. Q.P. and AV. are abbreviations of quasi-peak and average individually.
  2. "-": The Quasi-peak reading value also meets average limit and measurement with the average detector is unnecessary.
  3. The emission levels of other frequencies were very low against the limit.
  4. Margin value = Emission level - Limit value
  5. Correction factor = Insertion loss + Cable loss
  6. Emission Level = Correction Factor + Reading Value.

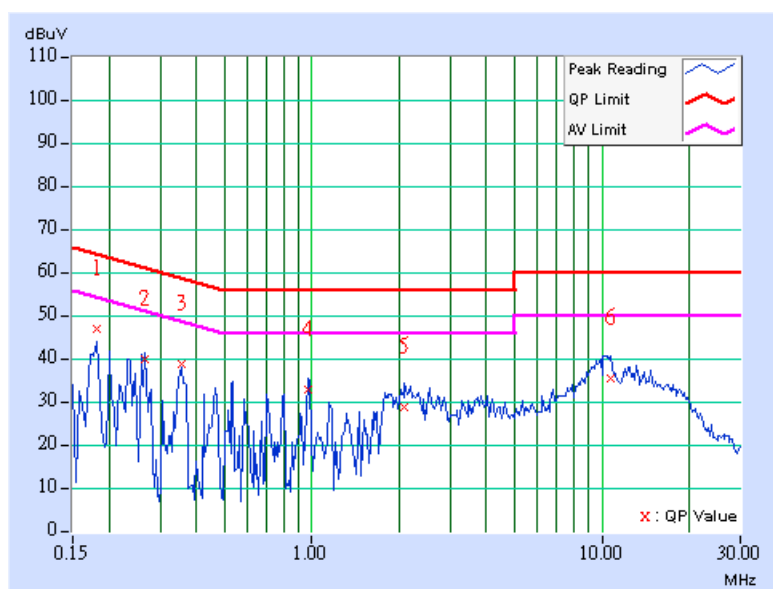

EUT TEST CONDITION		MEASUREMENT DETAIL	
CHANNEL	Channel 11	PHASE	Line 2
MODULATION TYPE	BPSK	6dB BANDWIDTH	9 kHz
TRANSFER RATE	7.2Mbps	INPUT POWER (SYSTEM)	120Vac, 60 Hz
ENVIRONMENTAL CONDITIONS	25deg. C, 65%RH, 991hPa	TESTED BY	Match Tsui

No	Freq. [MHz]	Corr. Factor [dB]	Reading Value [dB (uV)]		Emission Level [dB (uV)]		Limit [dB (uV)]		Margin (dB)	
			Q.P.	AV.	Q.P.	AV.	Q.P.	AV.	Q.P.	AV.
1	0.181	0.10	47.38	-	47.48	-	64.43	54.43	-16.95	-
2	0.240	0.10	39.77	-	39.87	-	62.10	52.10	-22.23	-
3	0.361	0.10	38.52	-	38.62	-	58.71	48.71	-20.09	-
4	1.000	0.10	31.28	-	31.38	-	56.00	46.00	-24.62	-
5	2.262	0.22	29.92	-	30.14	-	56.00	46.00	-25.86	-
6	10.168	0.46	35.06	-	35.52	-	60.00	50.00	-24.48	-

- REMARKS:**
1. Q.P. and AV. are abbreviations of quasi-peak and average individually.
  2. "-": The Quasi-peak reading value also meets average limit and measurement with the average detector is unnecessary.
  3. The emission levels of other frequencies were very low against the limit.
  4. Margin value = Emission level - Limit value
  5. Correction factor = Insertion loss + Cable loss
  6. Emission Level = Correction Factor + Reading Value.

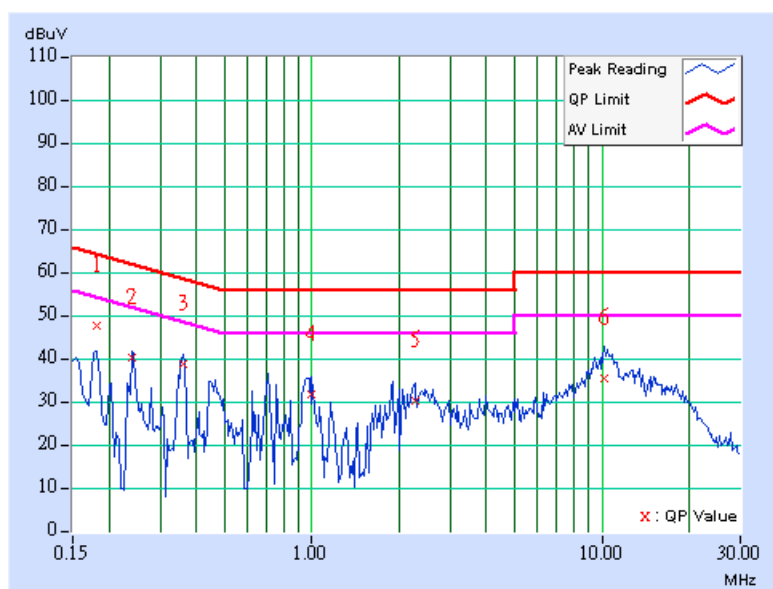

### DRAFT 802.11n (40MHz) OFDM MODULATION: DUAL TX:

EUT TEST CONDITION		MEASUREMENT DETAIL	
CHANNEL	Channel 1	PHASE	Line 1
MODULATION TYPE	BPSK	6dB BANDWIDTH	9 kHz
TRANSFER RATE	15Mbps	INPUT POWER (SYSTEM)	120Vac, 60 Hz
ENVIRONMENTAL CONDITIONS	25deg. C, 65%RH, 991hPa	TESTED BY	Match Tsui

No	Freq. [MHz]	Corr. Factor [dB]	Reading Value [dB (uV)]		Emission Level [dB (uV)]		Limit [dB (uV)]		Margin (dB)	
			Q.P.	AV.	Q.P.	AV.	Q.P.	AV.	Q.P.	AV.
1	0.177	0.10	48.27	-	48.37	-	64.61	54.61	-16.24	-
2	0.244	0.10	38.42	-	38.52	-	61.97	51.97	-23.45	-
3	0.360	0.10	38.26	-	38.36	-	58.73	48.73	-20.37	-
4	0.986	0.20	32.60	-	32.80	-	56.00	46.00	-23.20	-
5	2.230	0.23	30.28	-	30.51	-	56.00	46.00	-25.49	-
6	10.668	0.48	35.29	-	35.77	-	60.00	50.00	-24.23	-

- REMARKS:**
1. Q.P. and AV. are abbreviations of quasi-peak and average individually.
  2. "-": The Quasi-peak reading value also meets average limit and measurement with the average detector is unnecessary.
  3. The emission levels of other frequencies were very low against the limit.
  4. Margin value = Emission level - Limit value
  5. Correction factor = Insertion loss + Cable loss
  6. Emission Level = Correction Factor + Reading Value.

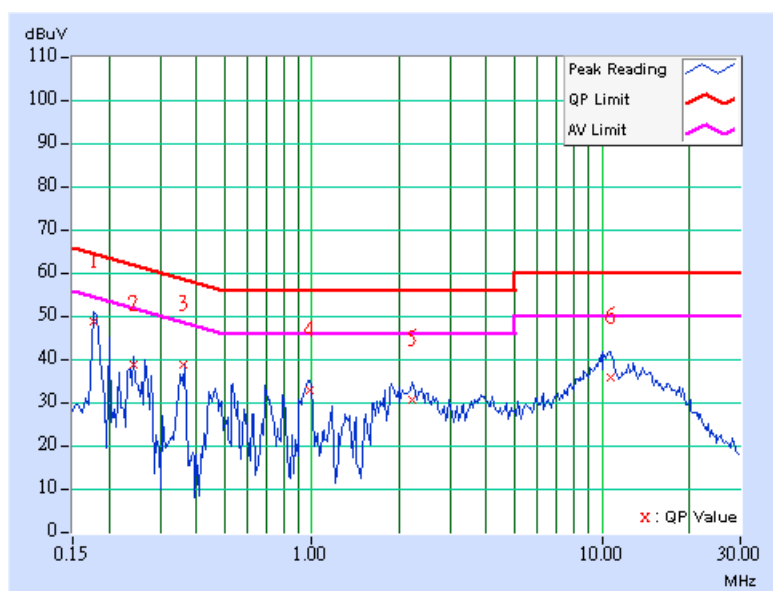

EUT TEST CONDITION		MEASUREMENT DETAIL	
CHANNEL	Channel 1	PHASE	Line 2
MODULATION TYPE	BPSK	6dB BANDWIDTH	9 kHz
TRANSFER RATE	15Mbps	INPUT POWER (SYSTEM)	120Vac, 60 Hz
ENVIRONMENTAL CONDITIONS	25deg. C, 65%RH, 991hPa	TESTED BY	Match Tsui

No	Freq. [MHz]	Corr. Factor [dB]	Reading Value [dB (uV)]		Emission Level [dB (uV)]		Limit [dB (uV)]		Margin (dB)	
			Q.P.	AV.	Q.P.	AV.	Q.P.	AV.	Q.P.	AV.
1	0.177	0.10	48.07	-	48.17	-	64.61	54.61	-16.44	-
2	0.235	0.10	38.64	-	38.74	-	62.29	52.29	-23.55	-
3	0.357	0.10	38.80	-	38.90	-	58.80	48.80	-19.90	-
4	0.705	0.10	34.39	-	34.49	-	56.00	46.00	-21.51	-
5	1.914	0.19	26.63	-	26.82	-	56.00	46.00	-29.18	-
6	10.414	0.47	36.11	-	36.58	-	60.00	50.00	-23.42	-

- REMARKS:**
1. Q.P. and AV. are abbreviations of quasi-peak and average individually.
  2. "-": The Quasi-peak reading value also meets average limit and measurement with the average detector is unnecessary.
  3. The emission levels of other frequencies were very low against the limit.
  4. Margin value = Emission level - Limit value
  5. Correction factor = Insertion loss + Cable loss
  6. Emission Level = Correction Factor + Reading Value.

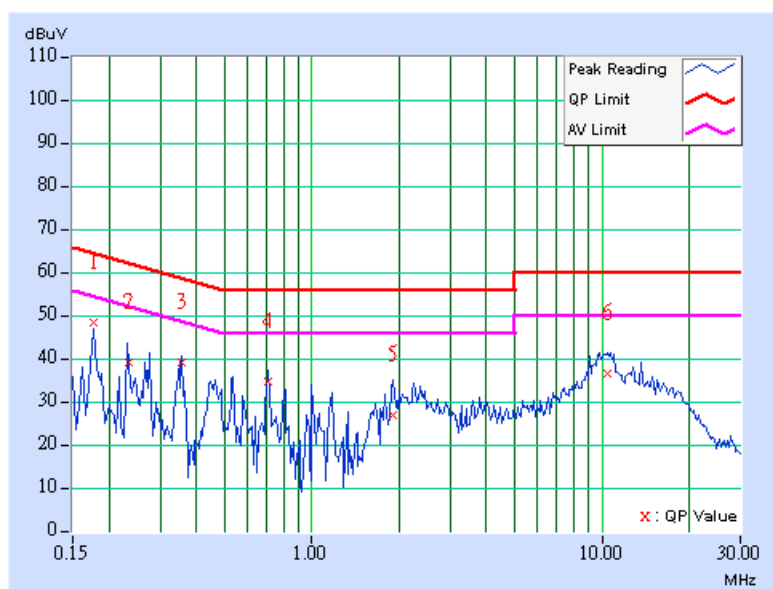

EUT TEST CONDITION		MEASUREMENT DETAIL	
CHANNEL	Channel 4	PHASE	Line 1
MODULATION TYPE	BPSK	6dB BANDWIDTH	9 kHz
TRANSFER RATE	15Mbps	INPUT POWER (SYSTEM)	120Vac, 60 Hz
ENVIRONMENTAL CONDITIONS	25deg. C, 65%RH, 991hPa	TESTED BY	Match Tsui

No	Freq. [MHz]	Corr. Factor [dB]	Reading Value [dB (uV)]		Emission Level [dB (uV)]		Limit [dB (uV)]		Margin (dB)	
			Q.P.	AV.	Q.P.	AV.	Q.P.	AV.	Q.P.	AV.
1	0.232	0.10	36.96	-	37.06	-	62.38	52.38	-25.32	-
2	0.271	0.10	38.95	-	39.05	-	61.08	51.08	-22.03	-
3	0.705	0.15	33.12	-	33.27	-	56.00	46.00	-22.73	-
4	2.258	0.23	30.66	-	30.89	-	56.00	46.00	-25.11	-
5	9.863	0.46	34.30	-	34.76	-	60.00	50.00	-25.24	-
6	14.496	0.61	29.32	-	29.93	-	60.00	50.00	-30.07	-

- REMARKS:**
1. Q.P. and AV. are abbreviations of quasi-peak and average individually.
  2. "-": The Quasi-peak reading value also meets average limit and measurement with the average detector is unnecessary.
  3. The emission levels of other frequencies were very low against the limit.
  4. Margin value = Emission level - Limit value
  5. Correction factor = Insertion loss + Cable loss
  6. Emission Level = Correction Factor + Reading Value.

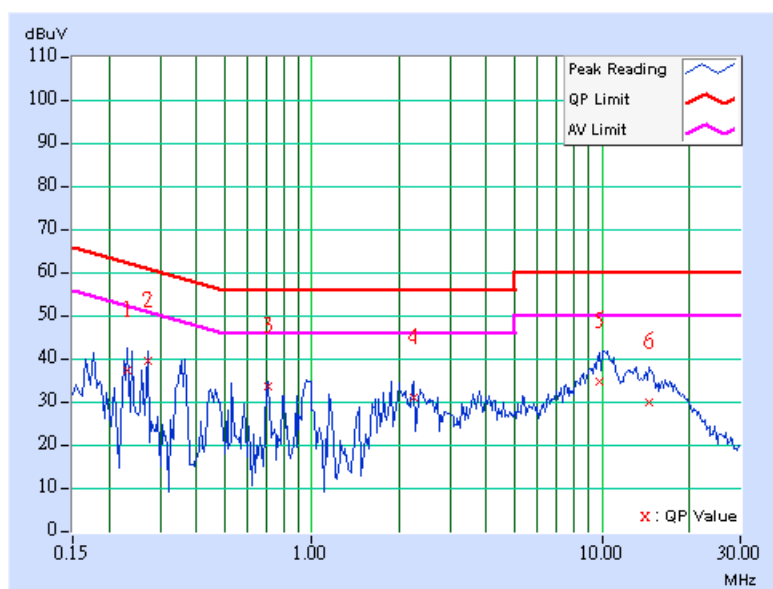

EUT TEST CONDITION		MEASUREMENT DETAIL	
CHANNEL	Channel 4	PHASE	Line 2
MODULATION TYPE	BPSK	6dB BANDWIDTH	9 kHz
TRANSFER RATE	15Mbps	INPUT POWER (SYSTEM)	120Vac, 60 Hz
ENVIRONMENTAL CONDITIONS	25deg. C, 65%RH, 991hPa	TESTED BY	Match Tsui

No	Freq. [MHz]	Corr. Factor [dB]	Reading Value [dB (uV)]		Emission Level [dB (uV)]		Limit [dB (uV)]		Margin (dB)	
			Q.P.	AV.	Q.P.	AV.	Q.P.	AV.	Q.P.	AV.
1	0.240	0.10	39.87	-	39.97	-	62.10	52.10	-22.13	-
2	0.357	0.10	38.82	-	38.92	-	58.80	48.80	-19.88	-
3	0.537	0.10	34.09	-	34.19	-	56.00	46.00	-21.81	-
4	0.705	0.10	34.41	-	34.51	-	56.00	46.00	-21.49	-
5	2.266	0.22	28.66	-	28.88	-	56.00	46.00	-27.12	-
6	10.754	0.47	35.81	-	36.28	-	60.00	50.00	-23.72	-

- REMARKS:**
1. Q.P. and AV. are abbreviations of quasi-peak and average individually.
  2. "-": The Quasi-peak reading value also meets average limit and measurement with the average detector is unnecessary.
  3. The emission levels of other frequencies were very low against the limit.
  4. Margin value = Emission level - Limit value
  5. Correction factor = Insertion loss + Cable loss
  6. Emission Level = Correction Factor + Reading Value.

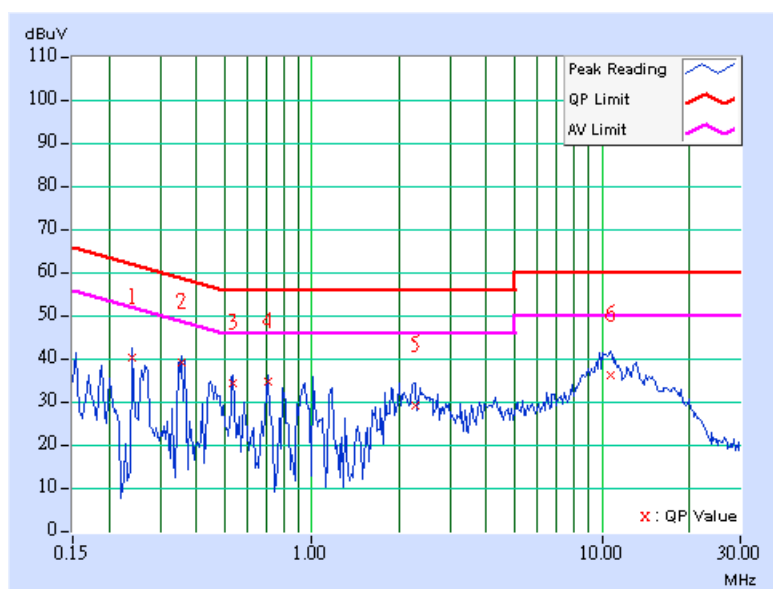

EUT TEST CONDITION		MEASUREMENT DETAIL	
CHANNEL	Channel 7	PHASE	Line 1
MODULATION TYPE	BPSK	6dB BANDWIDTH	9 kHz
TRANSFER RATE	15Mbps	INPUT POWER (SYSTEM)	120Vac, 60 Hz
ENVIRONMENTAL CONDITIONS	25deg. C, 65%RH, 991hPa	TESTED BY	Match Tsui

No	Freq. [MHz]	Corr. Factor [dB]	Reading Value [dB (uV)]		Emission Level [dB (uV)]		Limit [dB (uV)]		Margin (dB)	
			Q.P.	AV.	Q.P.	AV.	Q.P.	AV.	Q.P.	AV.
1	0.179	0.10	48.17	-	48.27	-	64.54	54.54	-16.27	-
2	0.244	0.10	38.46	-	38.56	-	61.97	51.97	-23.41	-
3	0.353	0.10	38.26	-	38.36	-	58.89	48.89	-20.53	-
4	0.986	0.20	32.46	-	32.66	-	56.00	46.00	-23.34	-
5	2.348	0.25	29.06	-	29.31	-	56.00	46.00	-26.69	-
6	9.777	0.46	34.67	-	35.13	-	60.00	50.00	-24.87	-

- REMARKS:**
1. Q.P. and AV. are abbreviations of quasi-peak and average individually.
  2. "-": The Quasi-peak reading value also meets average limit and measurement with the average detector is unnecessary.
  3. The emission levels of other frequencies were very low against the limit.
  4. Margin value = Emission level - Limit value
  5. Correction factor = Insertion loss + Cable loss
  6. Emission Level = Correction Factor + Reading Value.

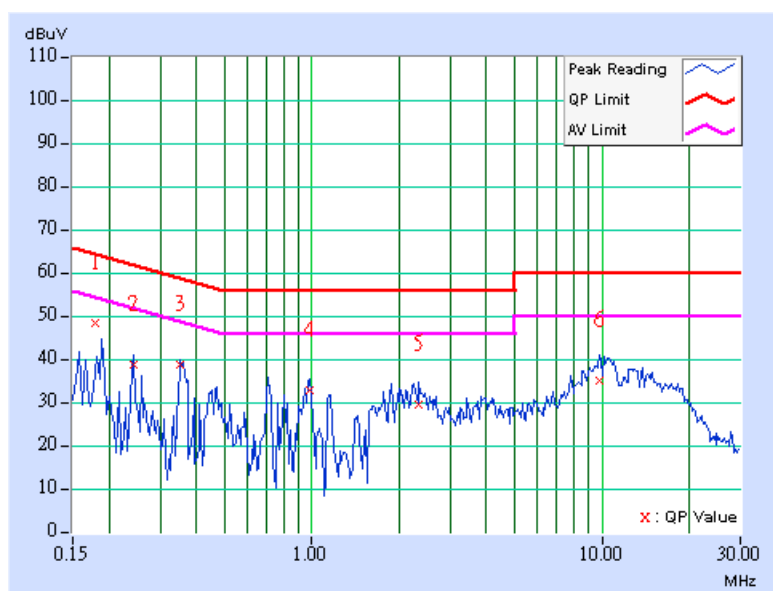

EUT TEST CONDITION		MEASUREMENT DETAIL	
CHANNEL	Channel 7	PHASE	Line 2
MODULATION TYPE	BPSK	6dB BANDWIDTH	9 kHz
TRANSFER RATE	15Mbps	INPUT POWER (SYSTEM)	120Vac, 60 Hz
ENVIRONMENTAL CONDITIONS	25deg. C, 65%RH, 991hPa	TESTED BY	Match Tsui

No	Freq. [MHz]	Corr. Factor [dB]	Reading Value [dB (uV)]		Emission Level [dB (uV)]		Limit [dB (uV)]		Margin (dB)	
			Q.P.	AV.	Q.P.	AV.	Q.P.	AV.	Q.P.	AV.
1	0.181	0.10	47.16	-	47.26	-	64.43	54.43	-17.17	-
2	0.271	0.10	40.00	-	40.10	-	61.08	51.08	-20.98	-
3	0.361	0.10	38.56	-	38.66	-	58.71	48.71	-20.05	-
4	0.705	0.10	34.29	-	34.39	-	56.00	46.00	-21.61	-
5	2.250	0.22	29.81	-	30.03	-	56.00	46.00	-25.97	-
6	10.414	0.47	36.54	-	37.01	-	60.00	50.00	-22.99	-

- REMARKS:**
1. Q.P. and AV. are abbreviations of quasi-peak and average individually.
  2. "-": The Quasi-peak reading value also meets average limit and measurement with the average detector is unnecessary.
  3. The emission levels of other frequencies were very low against the limit.
  4. Margin value = Emission level - Limit value
  5. Correction factor = Insertion loss + Cable loss
  6. Emission Level = Correction Factor + Reading Value.

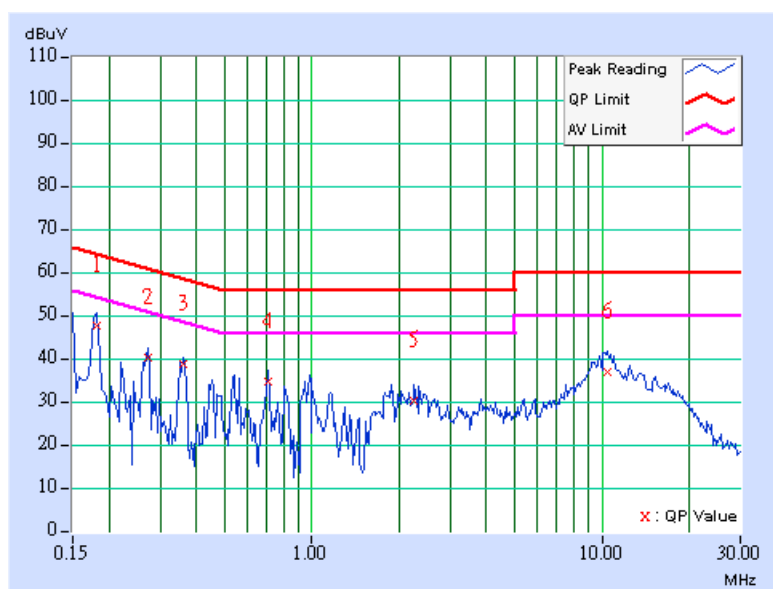



### 802.11b (CB mode) DSSS MODULATION: DUAL TX:

EUT TEST CONDITION		MEASUREMENT DETAIL	
CHANNEL	Channel 1	PHASE	Line 1
MODULATION TYPE	DBPSK	6dB BANDWIDTH	9 kHz
TRANSFER RATE	1Mbps	INPUT POWER (SYSTEM)	120Vac, 60 Hz
ENVIRONMENTAL CONDITIONS	20deg. C, 60%RH, 991hPa	TESTED BY	Match Tsui

No	Freq. [MHz]	Corr. Factor [dB]	Reading Value [dB (uV)]		Emission Level [dB (uV)]		Limit [dB (uV)]		Margin (dB)	
			Q.P.	AV.	Q.P.	AV.	Q.P.	AV.	Q.P.	AV.
			1	0.181	0.10	47.58	-	47.68	-	64.43
2	0.236	0.10	37.26	-	37.36	-	62.24	52.24	-24.88	-
3	0.349	0.10	35.66	-	35.76	-	58.98	48.98	-23.22	-
4	0.998	0.20	32.64	-	32.84	-	56.00	46.00	-23.16	-
5	2.250	0.23	31.17	-	31.40	-	56.00	46.00	-24.60	-
6	10.383	0.47	35.63	-	36.10	-	60.00	50.00	-23.90	-

- REMARKS:**
1. Q.P. and AV. are abbreviations of quasi-peak and average individually.
  2. "-": The Quasi-peak reading value also meets average limit and measurement with the average detector is unnecessary.
  3. The emission levels of other frequencies were very low against the limit.
  4. Margin value = Emission level - Limit value
  5. Correction factor = Insertion loss + Cable loss
  6. Emission Level = Correction Factor + Reading Value.

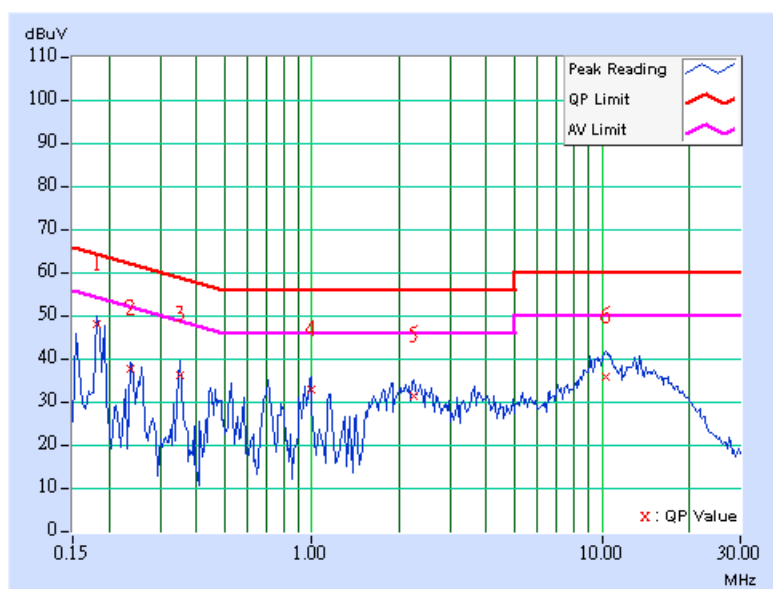

EUT TEST CONDITION		MEASUREMENT DETAIL	
CHANNEL	Channel 1	PHASE	Line 2
MODULATION TYPE	DBPSK	6dB BANDWIDTH	9 kHz
TRANSFER RATE	1Mbps	INPUT POWER (SYSTEM)	120Vac, 60 Hz
ENVIRONMENTAL CONDITIONS	20deg. C, 60%RH, 991hPa	TESTED BY	Match Tsui

No	Freq. [MHz]	Corr. Factor (dB)	Reading Value [dB (uV)]		Emission Level [dB (uV)]		Limit [dB (uV)]		Margin (dB)	
			Q.P.	AV.	Q.P.	AV.	Q.P.	AV.	Q.P.	AV.
1	0.181	0.10	47.00	-	47.10	-	64.43	54.43	-17.33	-
2	0.236	0.10	39.16	-	39.26	-	62.24	52.24	-22.98	-
3	0.357	0.10	38.82	-	38.92	-	58.80	48.80	-19.88	-
4	0.705	0.10	34.51	-	34.61	-	56.00	46.00	-21.39	-
5	0.982	0.10	33.51	-	33.61	-	56.00	46.00	-22.39	-
6	10.672	0.47	35.67	-	36.14	-	60.00	50.00	-23.86	-

- REMARKS:**
1. Q.P. and AV. are abbreviations of quasi-peak and average individually.
  2. "-": The Quasi-peak reading value also meets average limit and measurement with the average detector is unnecessary.
  3. The emission levels of other frequencies were very low against the limit.
  4. Margin value = Emission level - Limit value
  5. Correction factor = Insertion loss + Cable loss
  6. Emission Level = Correction Factor + Reading Value.

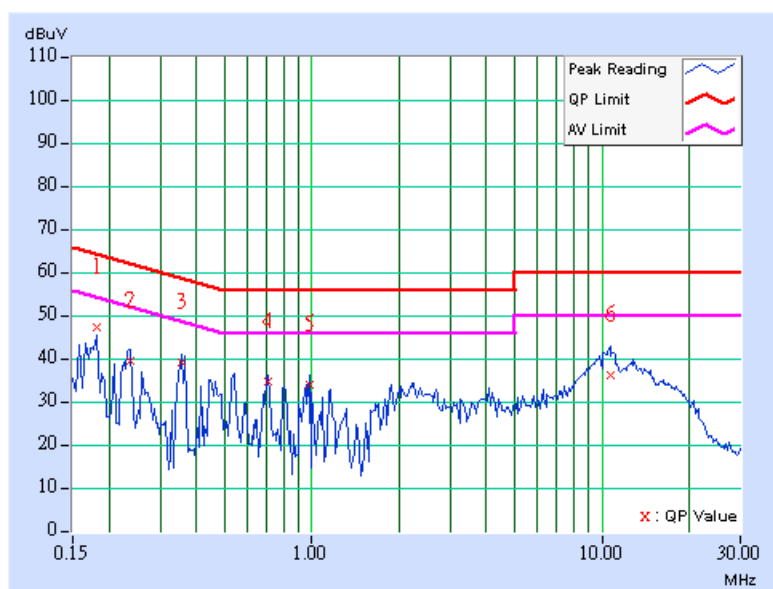

EUT TEST CONDITION		MEASUREMENT DETAIL	
CHANNEL	Channel 4	PHASE	Line 1
MODULATION TYPE	DBPSK	6dB BANDWIDTH	9 kHz
TRANSFER RATE	1Mbps	INPUT POWER (SYSTEM)	120Vac, 60 Hz
ENVIRONMENTAL CONDITIONS	20deg. C, 60%RH, 991hPa	TESTED BY	Match Tsui

No	Freq. [MHz]	Corr. Factor [dB]	Reading Value [dB (uV)]		Emission Level [dB (uV)]		Limit [dB (uV)]		Margin (dB)	
			Q.P.	AV.	Q.P.	AV.	Q.P.	AV.	Q.P.	AV.
1	0.181	0.10	46.39	-	46.49	-	64.43	54.43	-17.94	-
2	0.271	0.10	38.79	-	38.89	-	61.08	51.08	-22.19	-
3	0.361	0.10	38.20	-	38.30	-	58.71	48.71	-20.41	-
4	0.978	0.20	32.64	-	32.84	-	56.00	46.00	-23.16	-
5	2.223	0.23	30.73	-	30.96	-	56.00	46.00	-25.04	-
6	10.359	0.47	35.65	-	36.12	-	60.00	50.00	-23.88	-

- REMARKS:**
1. Q.P. and AV. are abbreviations of quasi-peak and average individually.
  2. "-": The Quasi-peak reading value also meets average limit and measurement with the average detector is unnecessary.
  3. The emission levels of other frequencies were very low against the limit.
  4. Margin value = Emission level - Limit value
  5. Correction factor = Insertion loss + Cable loss
  6. Emission Level = Correction Factor + Reading Value.

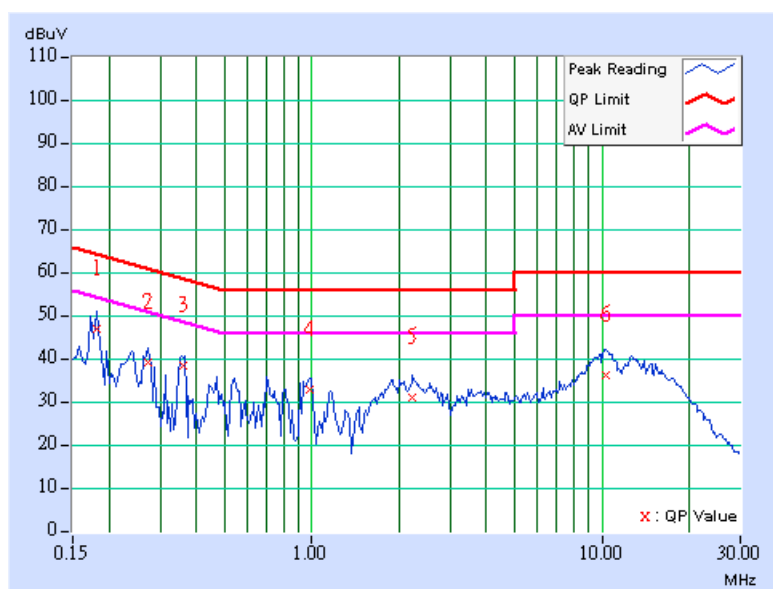

EUT TEST CONDITION		MEASUREMENT DETAIL	
CHANNEL	Channel 4	PHASE	Line 2
MODULATION TYPE	DBPSK	6dB BANDWIDTH	9 kHz
TRANSFER RATE	1Mbps	INPUT POWER (SYSTEM)	120Vac, 60 Hz
ENVIRONMENTAL CONDITIONS	20deg. C, 60%RH, 991hPa	TESTED BY	Match Tsui

No	Freq. [MHz]	Corr. Factor [dB]	Reading Value [dB (uV)]		Emission Level [dB (uV)]		Limit [dB (uV)]		Margin (dB)	
			Q.P.	AV.	Q.P.	AV.	Q.P.	AV.	Q.P.	AV.
1	0.181	0.10	47.38	-	47.48	-	64.43	54.43	-16.95	-
2	0.275	0.10	37.91	-	38.01	-	60.97	50.97	-22.96	-
3	0.357	0.10	38.82	-	38.92	-	58.80	48.80	-19.88	-
4	0.545	0.10	32.90	-	33.00	-	56.00	46.00	-23.00	-
5	2.270	0.22	28.64	-	28.86	-	56.00	46.00	-27.14	-
6	10.133	0.46	35.69	-	36.15	-	60.00	50.00	-23.85	-

- REMARKS:**
1. Q.P. and AV. are abbreviations of quasi-peak and average individually.
  2. "-": The Quasi-peak reading value also meets average limit and measurement with the average detector is unnecessary.
  3. The emission levels of other frequencies were very low against the limit.
  4. Margin value = Emission level - Limit value
  5. Correction factor = Insertion loss + Cable loss
  6. Emission Level = Correction Factor + Reading Value.

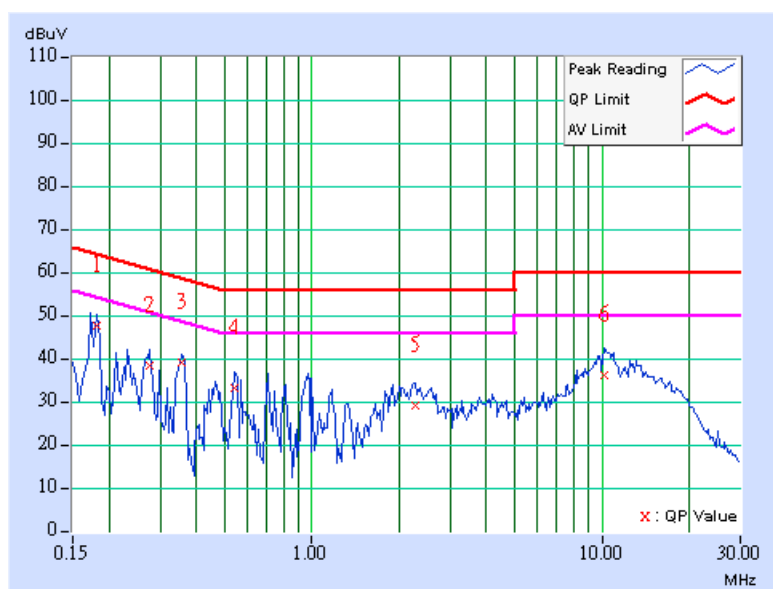

EUT TEST CONDITION		MEASUREMENT DETAIL	
CHANNEL	Channel 7	PHASE	Line 1
MODULATION TYPE	DBPSK	6dB BANDWIDTH	9 kHz
TRANSFER RATE	1Mbps	INPUT POWER (SYSTEM)	120Vac, 60 Hz
ENVIRONMENTAL CONDITIONS	25deg. C, 65%RH, 991hPa	TESTED BY	Match Tsui

No	Freq. [MHz]	Corr. Factor [dB]	Reading Value [dB (uV)]		Emission Level [dB (uV)]		Limit [dB (uV)]		Margin (dB)	
			Q.P.	AV.	Q.P.	AV.	Q.P.	AV.	Q.P.	AV.
1	0.181	0.10	47.64	-	47.74	-	64.43	54.43	-16.69	-
2	0.353	0.10	37.73	-	37.83	-	58.89	48.89	-21.06	-
3	0.705	0.15	33.08	-	33.23	-	56.00	46.00	-22.77	-
4	1.902	0.20	31.23	-	31.43	-	56.00	46.00	-24.57	-
5	10.207	0.47	35.17	-	35.64	-	60.00	50.00	-24.36	-
6	13.031	0.56	30.69	-	31.25	-	60.00	50.00	-28.75	-

- REMARKS:**
1. Q.P. and AV. are abbreviations of quasi-peak and average individually.
  2. "-": The Quasi-peak reading value also meets average limit and measurement with the average detector is unnecessary.
  3. The emission levels of other frequencies were very low against the limit.
  4. Margin value = Emission level - Limit value
  5. Correction factor = Insertion loss + Cable loss
  6. Emission Level = Correction Factor + Reading Value.

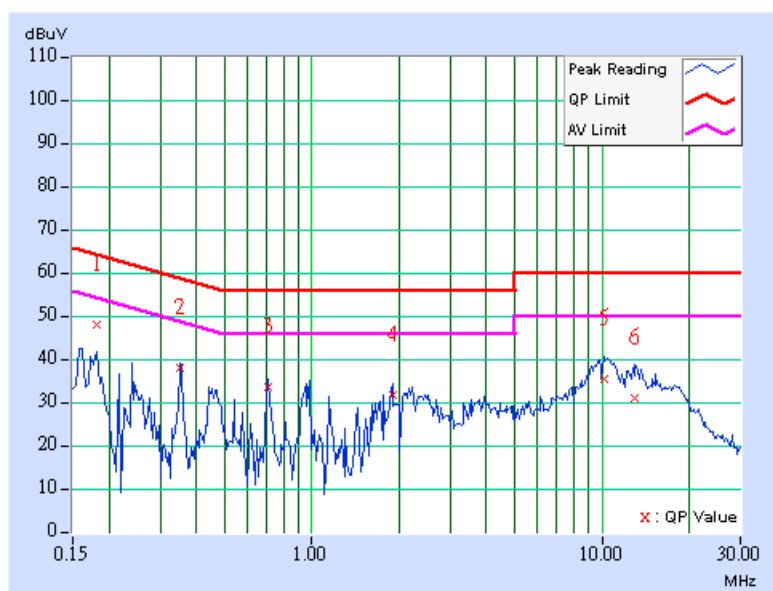

EUT TEST CONDITION		MEASUREMENT DETAIL	
CHANNEL	Channel 7	PHASE	Line 2
MODULATION TYPE	DBPSK	6dB BANDWIDTH	9 kHz
TRANSFER RATE	1Mbps	INPUT POWER (SYSTEM)	120Vac, 60 Hz
ENVIRONMENTAL CONDITIONS	25deg. C, 65%RH, 991hPa	TESTED BY	Match Tsui

No	Freq. [MHz]	Corr. Factor [dB]	Reading Value [dB (uV)]		Emission Level [dB (uV)]		Limit [dB (uV)]		Margin (dB)	
			Q.P.	AV.	Q.P.	AV.	Q.P.	AV.	Q.P.	AV.
1	0.181	0.10	47.30	-	47.40	-	64.43	54.43	-17.03	-
2	0.236	0.10	36.50	-	36.60	-	62.24	52.24	-25.64	-
3	0.353	0.10	38.98	-	39.08	-	58.89	48.89	-19.81	-
4	0.990	0.10	33.97	-	34.07	-	56.00	46.00	-21.93	-
5	2.246	0.22	31.04	-	31.26	-	56.00	46.00	-24.74	-
6	10.516	0.47	35.66	-	36.13	-	60.00	50.00	-23.87	-

- REMARKS:**
1. Q.P. and AV. are abbreviations of quasi-peak and average individually.
  2. "-": The Quasi-peak reading value also meets average limit and measurement with the average detector is unnecessary.
  3. The emission levels of other frequencies were very low against the limit.
  4. Margin value = Emission level - Limit value
  5. Correction factor = Insertion loss + Cable loss
  6. Emission Level = Correction Factor + Reading Value.

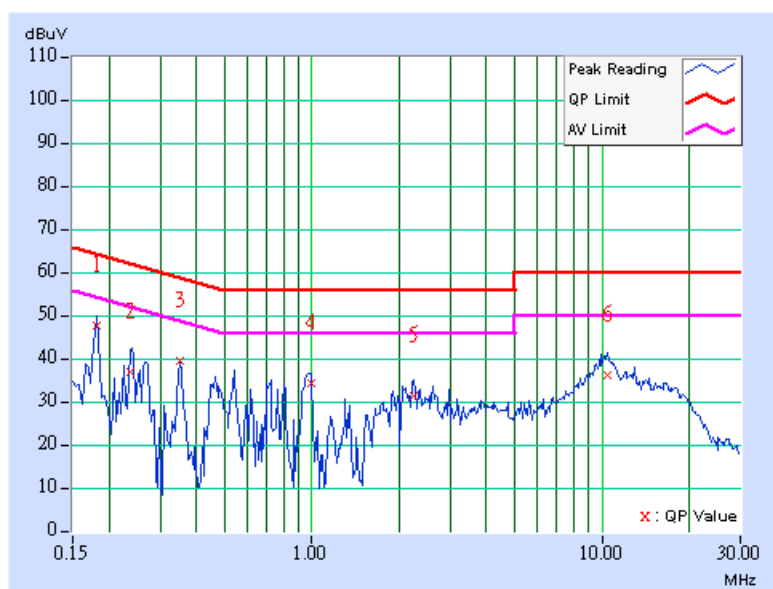

## 4.2 RADIATED EMISSION MEASUREMENT

### 4.2.1 LIMITS OF RADIATED EMISSION MEASUREMENT

Emissions radiated outside of the specified bands, shall be according to the general radiated limits in 15.209 as following:

FREQUENCIES (MHz)	FIELD STRENGTH (microvolts/meter)	MEASUREMENT DISTANCE (meters)
0.009 ~ 0.490	2400 / F(kHz)	300
0.490 ~ 1.705	24000 / F(kHz)	30
1.705 ~ 30.0	30	30
30 ~ 88	100	3
88 ~ 216	150	3
216 ~ 960	200	3
Above 960	500	3

**NOTE:**

1. The lower limit shall apply at the transition frequencies.
2. Emission level (dBuV/m) = 20 log Emission level (uV/m).
3. As shown in 15.35(b), for frequencies above 1000MHz, the field strength limits are based on average detector, however, the peak field strength of any emission shall not exceed the maximum permitted average limits, specified above by more than 20dB under any condition of modulation.



#### 4.2.2 TEST INSTRUMENTS

DESCRIPTION & MANUFACTURER	MODEL NO.	SERIAL NO.	CALIBRATED UNTIL
Test Receiver ROHDE & SCHWARZ	ESI7	838496/016	Jan. 01, 2007
Spectrum Analyzer ROHDE & SCHWARZ	FSP40	100041	Dec. 04, 2006
BILOG Antenna SCHWARZBECK	VULB9168	9168-155	Jan. 15, 2007
HORN Antenna SCHWARZBECK	BBHA 9120D	9120D-404	Jan. 01, 2007
HORN Antenna SCHWARZBECK	BBHA 9170	BBHA9170242	Jan. 19, 2007
Preamplifier Agilent	8449B	3008A01960	Nov. 09, 2006
RF signal cable HUBER+SUHNNER	SUCOFLEX 104	219268/4	Dec. 20, 2006
RF signal cable HUBER+SUHNNER	SUCOFLEX 104	230129/4	Dec. 20, 2006
Software ADT.	ADT_Radiated_V5.14	NA	NA
Antenna Tower inn-co GmbH	MA 4000	010303	NA
Antenna Tower Controller inn-co GmbH	CO2000	019303	NA
Turn Table ADT.	TT100.	TT93021704	NA
Turn Table Controller ADT.	SC100.	SC93021704	NA

- NOTE:**
1. The calibration interval of the above test instruments is 12 months and the calibrations are traceable to NML/ROC and NIST/USA.
  2. The test was performed in HwaYa Chamber 3.
  3. The horn antenna and HP preamplifier (model: 8449B) are used only for the measurement of emission frequency above 1GHz if tested.
  4. The IC Site Registration No. is IC4924-4.



#### 4.2.3 TEST PROCEDURES

- a. The EUT was placed on the top of a rotating table 0.8 meters above the ground at a 3 meters semi-anechoic chamber. The table was rotated 360 degrees to determine the position of the highest radiation.
- b. The EUT was set 3 meters away from the interference-receiving antenna, which was mounted on the top of a variable-height antenna tower.
- c. The antenna is a broadband antenna, and its height is varied from one meter to four meters above the ground to determine the maximum value of the field strength. Both horizontal and vertical polarizations of the antenna are set to make the measurement.
- d. For each suspected emission, the EUT was arranged to its worst case and then the antenna was tuned to heights from 1 meter to 4 meters and the rotatable table was turned from 0 degrees to 360 degrees to find the maximum reading.
- e. The test-receiver system was set to Peak Detect Function and Specified Bandwidth with Maximum Hold Mode.
- f. If the emission level of the EUT in peak mode was lower than the limit specified, then testing could be stopped and the peak values of the EUT would be reported. Otherwise the emissions would be re-tested one by one using peak, quasi-peak or average method as specified and then reported in a data sheet.

**NOTE:**

1. The resolution bandwidth and video bandwidth of test receiver/spectrum analyzer is 120kHz for Peak detection (PK) and Quasi-peak detection (QP) at frequency below 1GHz.
2. The resolution bandwidth and video bandwidth of test receiver/spectrum analyzer is 1 MHz for Peak detection at frequency above 1GHz.
3. The resolution bandwidth of test receiver/spectrum analyzer is 1MHz and the video bandwidth is 10Hz for Average detection (AV) at frequency above 1GHz.

#### 4.2.4 DEVIATION FROM TEST STANDARD

No deviation

#### 4.2.5 TEST SETUP

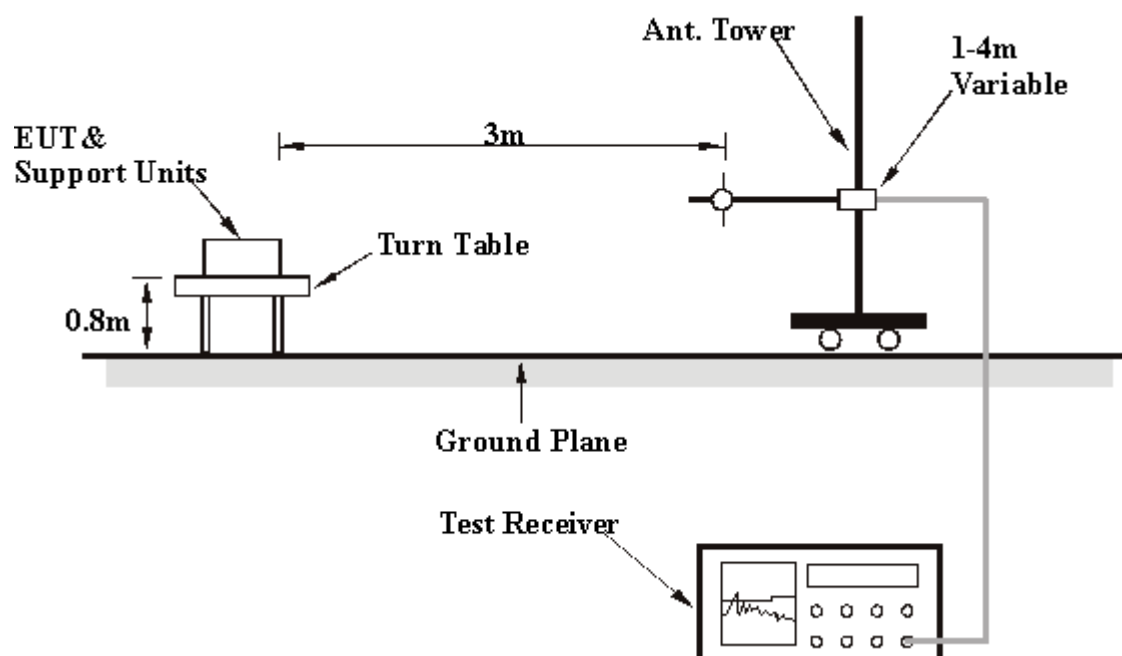

For the actual test configuration, please refer to the related item – Photographs of the Test Configuration.

#### 4.2.6 EUT OPERATING CONDITIONS

Same as item 4.1.6.

## 4.2.7 TEST RESULTS

### BELOW 1GHz WORST-CASE DATA: 802.11g OFDM MODULATION: DUAL TX:

EUT TEST CONDITION		MEASUREMENT DETAIL	
CHANNEL	Channel 1	FREQUENCY RANGE	Below 1000MHz
MODULATION TYPE	BPSK for 802.11g	INPUT POWER (SYSTEM)	120Vac, 60 Hz
TRANSFER RATE	6Mbps	DETECTOR FUNCTION	Quasi-Peak
ENVIRONMENTAL CONDITIONS	23deg. C, 63%RH, 991hPa	TESTED BY	Brad Wu

ANTENNA POLARITY & TEST DISTANCE: HORIZONTAL AT 3 M								
No.	Freq. (MHz)	Emission Level (dBuV/m)	Limit (dBuV/m)	Margin (dB)	Antenna Height (m)	Table Angle (Degree)	Raw Value (dBuV)	Correction Factor (dB/m)
1	99.98	38.07 QP	43.50	-5.43	1.25 H	28	29.07	9.00
2	133.03	38.37 QP	43.50	-5.13	1.25 H	28	25.82	12.55
3	166.07	40.55 QP	43.50	-2.95	1.25 H	28	27.72	12.83
4	199.12	40.58 QP	43.50	-2.92	1.25 H	28	29.77	10.81
5	232.16	43.66 QP	46.00	-2.34	1.25 H	28	31.82	11.84
6	265.21	44.49 QP	46.00	-1.51	1.25 H	28	31.18	13.31
7	333.25	44.91 QP	46.00	-1.09	1.00 H	202	29.03	15.89

ANTENNA POLARITY & TEST DISTANCE: VERTICAL AT 3 M								
No.	Freq. (MHz)	Emission Level (dBuV/m)	Limit (dBuV/m)	Margin (dB)	Antenna Height (m)	Table Angle (Degree)	Raw Value (dBuV)	Correction Factor (dB/m)
1	98.04	35.56 QP	43.50	-7.94	1.00 V	196	26.56	9.00
2	164.13	34.84 QP	43.50	-8.66	1.25 V	352	21.86	12.97
3	267.15	36.72 QP	46.00	-9.28	1.50 V	70	23.09	13.63
4	333.25	40.10 QP	46.00	-5.90	1.50 V	100	24.21	15.89
5	465.43	29.79 QP	46.00	-16.21	1.25 V	286	10.70	19.08
6	801.72	29.71 QP	46.00	-16.29	1.25 V	73	3.58	26.13

- REMARKS:**
1. Emission level(dBuV/m)=Raw Value(dBuV) + Correction Factor(dB/m)
  2. Correction Factor(dB/m) = Antenna Factor (dB/m) + Cable Factor (dB)
  3. The other emission levels were very low against the limit.
  4. Margin value = Emission level – Limit value.



**DRAFT 802.11n (20MHz) OFDM MODULATION: DUAL TX:**

EUT TEST CONDITION		MEASUREMENT DETAIL	
CHANNEL	Channel 1	FREQUENCY RANGE	Below 1000MHz
MODULATION TYPE	BPSK for draft 802.11n (20MHz)	INPUT POWER (SYSTEM)	120Vac, 60 Hz
TRANSFER RATE	7.2Mbps	DETECTOR FUNCTION	Quasi-Peak
ENVIRONMENTAL CONDITIONS	23deg. C, 63%RH, 991hPa	TESTED BY	Brad Wu

ANTENNA POLARITY & TEST DISTANCE: HORIZONTAL AT 3 M								
No.	Freq. (MHz)	Emission Level (dBuV/m)	Limit (dBuV/m)	Margin (dB)	Antenna Height (m)	Table Angle (Degree)	Raw Value (dBuV)	Correction Factor (dB/m)
1	133.03	38.55 QP	43.50	-4.95	1.50 H	88	26.00	12.55
2	166.07	41.51 QP	43.50	-1.99	1.25 H	70	28.68	12.83
3	199.12	41.19 QP	43.50	-2.31	1.50 H	96	30.38	10.81
4	232.16	44.88 QP	46.00	-1.12	1.25 H	70	33.04	11.84
5	265.21	43.45 QP	46.00	-2.55	1.25 H	70	30.14	13.31
6	333.25	43.69 QP	46.00	-2.31	1.00 H	130	27.80	15.89

ANTENNA POLARITY & TEST DISTANCE: VERTICAL AT 3 M								
No.	Freq. (MHz)	Emission Level (dBuV/m)	Limit (dBuV/m)	Margin (dB)	Antenna Height (m)	Table Angle (Degree)	Raw Value (dBuV)	Correction Factor (dB/m)
1	98.04	35.71 QP	43.50	-7.79	1.50 V	199	26.71	9.00
2	166.07	36.01 QP	43.50	-7.49	1.00 V	31	23.17	12.83
3	265.21	32.83 QP	46.00	-13.17	1.00 V	70	19.52	13.31
4	331.30	38.00 QP	46.00	-8.00	1.00 V	97	22.14	15.86
5	533.47	28.61 QP	46.00	-17.39	1.50 V	325	7.96	20.65
6	931.96	36.29 QP	46.00	-9.71	1.00 V	31	7.35	28.95

- REMARKS:**
1. Emission level(dBuV/m)=Raw Value(dBuV) + Correction Factor(dB/m)
  2. Correction Factor(dB/m) = Antenna Factor (dB/m) + Cable Factor (dB)
  3. The other emission levels were very low against the limit.
  4. Margin value = Emission level – Limit value.



**DRAFT 802.11n (40MHz) OFDM MODULATION: DUAL TX:**

EUT TEST CONDITION		MEASUREMENT DETAIL	
CHANNEL	Channel 1	FREQUENCY RANGE	Below 1000MHz
MODULATION TYPE	BPSK for draft 802.11n (40MHz)	INPUT POWER (SYSTEM)	120Vac, 60 Hz
TRANSFER RATE	15Mbps	DETECTOR FUNCTION	Quasi-Peak
ENVIRONMENTAL CONDITIONS	23deg. C, 63%RH, 991hPa	TESTED BY	Brad Wu

ANTENNA POLARITY & TEST DISTANCE: HORIZONTAL AT 3 M								
No.	Freq. (MHz)	Emission Level (dBuV/m)	Limit (dBuV/m)	Margin (dB)	Antenna Height (m)	Table Angle (Degree)	Raw Value (dBuV)	Correction Factor (dB/m)
1	133.03	36.85 QP	43.50	-6.65	1.25 H	283	24.30	12.55
2	166.07	38.92 QP	43.50	-4.58	1.00 H	253	26.09	12.83
3	199.12	39.74 QP	43.50	-3.76	1.00 H	253	28.94	10.81
4	232.16	42.36 QP	46.00	-3.64	1.25 H	200	30.52	11.84
5	265.21	42.28 QP	46.00	-3.72	1.00 H	253	28.97	13.31
6	333.25	42.36 QP	46.00	-3.64	1.00 H	184	26.47	15.89

ANTENNA POLARITY & TEST DISTANCE: VERTICAL AT 3 M								
No.	Freq. (MHz)	Emission Level (dBuV/m)	Limit (dBuV/m)	Margin (dB)	Antenna Height (m)	Table Angle (Degree)	Raw Value (dBuV)	Correction Factor (dB/m)
1	98.04	35.20 QP	43.50	-8.30	1.50 V	223	26.20	9.00
2	232.16	31.76 QP	46.00	-14.24	1.00 V	37	19.92	11.84
3	265.21	34.92 QP	46.00	-11.08	1.00 V	58	21.62	13.31
4	333.25	40.03 QP	46.00	-5.97	1.00 V	61	24.14	15.89
5	465.43	29.38 QP	46.00	-16.62	1.25 V	13	10.30	19.08
6	533.47	28.87 QP	46.00	-17.13	1.00 V	319	8.22	20.65

- REMARKS:**
1. Emission level(dBuV/m)=Raw Value(dBuV) + Correction Factor(dB/m)
  2. Correction Factor(dB/m) = Antenna Factor (dB/m) + Cable Factor (dB)
  3. The other emission levels were very low against the limit.
  4. Margin value = Emission level – Limit value.



**802.11b(CB mode) DSSS MODULATION: DUAL TX:**

EUT TEST CONDITION		MEASUREMENT DETAIL	
CHANNEL	Channel 1	FREQUENCY RANGE	Below 1000MHz
MODULATION TYPE	DBPSK for 802.11b(CB mode)	INPUT POWER (SYSTEM)	120Vac, 60 Hz
TRANSFER RATE	1Mbps	DETECTOR FUNCTION	Quasi-Peak
ENVIRONMENTAL CONDITIONS	23deg. C, 63%RH, 991hPa	TESTED BY	Brad Wu

ANTENNA POLARITY & TEST DISTANCE: HORIZONTAL AT 3 M								
No.	Freq. (MHz)	Emission Level (dBuV/m)	Limit (dBuV/m)	Margin (dB)	Antenna Height (m)	Table Angle (Degree)	Raw Value (dBuV)	Correction Factor (dB/m)
1	133.03	36.94 QP	43.50	-6.56	1.50 H	123	24.39	12.55
2	166.07	39.12 QP	43.50	-4.38	1.25 H	200	26.29	12.83
3	199.12	40.21 QP	43.50	-3.29	1.00 H	286	29.40	10.81
4	232.16	43.62 QP	46.00	-2.38	1.25 H	286	31.78	11.84
5	267.15	44.50 QP	46.00	-1.50	1.00 H	136	30.87	13.63
6	333.25	44.76 QP	46.00	-1.24	1.00 H	155	28.87	15.89

ANTENNA POLARITY & TEST DISTANCE: VERTICAL AT 3 M								
No.	Freq. (MHz)	Emission Level (dBuV/m)	Limit (dBuV/m)	Margin (dB)	Antenna Height (m)	Table Angle (Degree)	Raw Value (dBuV)	Correction Factor (dB/m)
1	99.98	35.48 QP	43.50	-8.02	1.00 V	175	26.49	9.00
2	166.07	35.76 QP	43.50	-7.74	1.00 V	169	22.93	12.83
3	267.15	33.69 QP	46.00	-12.31	1.00 V	64	20.06	13.63
4	333.25	38.31 QP	46.00	-7.69	1.00 V	76	22.43	15.89
5	467.37	29.48 QP	46.00	-16.52	1.00 V	271	10.35	19.13
6	931.96	35.91 QP	46.00	-10.09	1.00 V	160	6.96	28.95

- REMARKS:**
1. Emission level(dBuV/m)=Raw Value(dBuV) + Correction Factor(dB/m)
  2. Correction Factor(dB/m) = Antenna Factor (dB/m) + Cable Factor (dB)
  3. The other emission levels were very low against the limit.
  4. Margin value = Emission level – Limit value.

**802.11b DSSS MODULATION: DUAL TX:**

EUT TEST CONDITION		MEASUREMENT DETAIL	
CHANNEL	Channel 1	FREQUENCY RANGE	1 ~ 25GHz
MODULATION TYPE	DBPSK	INPUT POWER (SYSTEM)	120Vac, 60 Hz
TRANSFER RATE	1Mbps	DETECTOR FUNCTION	Peak(PK) Average (AV)
ENVIRONMENTAL CONDITIONS	26deg. C, 70%RH, 991hPa	TESTED BY	Match Tsui

ANTENNA POLARITY & TEST DISTANCE: HORIZONTAL AT 3 M								
NO.	FREQ. (MHz)	EMISSION LEVEL (dBuV/m)	LIMIT (dBuV/m)	MARGIN (dB)	ANTENNA HEIGHT (m)	TABLE ANGLE (Degree)	RAW VALUE (dBuV)	CORRECTION FACTOR (dB/m)
1	2387.00	56.65 PK	74.00	-17.35	1.27 H	291	25.27	31.38
1	2387.00	46.52 AV	54.00	-7.48	1.27 H	291	15.14	31.38
2	*2412.00	107.64 PK			1.04 H	291	76.18	31.46
2	*2412.00	104.04 AV			1.04 H	291	72.58	31.46
3	4824.00	52.50 PK	74.00	-21.50	1.22 H	282	15.37	37.13
3	4824.00	48.34 AV	54.00	-5.66	1.22 H	282	11.21	37.13

ANTENNA POLARITY & TEST DISTANCE: VERTICAL AT 3 M								
NO.	FREQ. (MHz)	EMISSION LEVEL (dBuV/m)	LIMIT (dBuV/m)	MARGIN (dB)	ANTENNA HEIGHT (m)	TABLE ANGLE (Degree)	RAW VALUE (dBuV)	CORRECTION FACTOR (dB/m)
1	2386.00	61.30 PK	74.00	-12.70	1.18 V	10	29.93	31.37
1	2386.00	51.94 AV	54.00	-2.06	1.18 V	10	20.57	31.37
2	*2412.00	110.85 PK			1.67 V	0	79.39	31.46
2	*2412.00	107.28 AV			1.67 V	0	75.82	31.46
3	2984.00	57.32 PK	90.85	-33.53	1.16 V	300	24.78	32.54
3	2984.00	48.58 AV	87.28	-38.70	1.16 V	300	16.04	32.54
4	4824.00	55.28 PK	74.00	-18.72	1.03 V	179	18.15	37.13
4	4824.00	52.59 AV	54.00	-1.41	1.03 V	179	15.46	37.13

- REMARKS:**
1. Emission level (dBuV/m) = Raw Value (dBuV) + Correction Factor (dB/m).
  2. Correction Factor (dB/m) = Antenna Factor (dB/m) + Cable Factor (dB).
  3. The other emission levels were very low against the limit.
  4. Margin value = Emission level – Limit value.
  5. The limit value is defined as per 15.247.
  6. “ \* “: Fundamental frequency.

EUT TEST CONDITION		MEASUREMENT DETAIL	
CHANNEL	Channel 6	FREQUENCY RANGE	1 ~ 25GHz
MODULATION TYPE	DBPSK	INPUT POWER (SYSTEM)	120Vac, 60 Hz
TRANSFER RATE	1Mbps	DETECTOR FUNCTION	Peak(PK) Average (AV)
ENVIRONMENTAL CONDITIONS	26deg. C, 70%RH, 991hPa	TESTED BY	Match Tsui

ANTENNA POLARITY & TEST DISTANCE: HORIZONTAL AT 3 M								
NO.	FREQ. (MHz)	EMISSION LEVEL (dBuV/m)	LIMIT (dBuV/m)	MARGIN (dB)	ANTENNA HEIGHT (m)	TABLE ANGLE (Degree)	RAW VALUE (dBuV)	CORRECTION FACTOR (dB/m)
1	*2437.00	110.20 PK			1.22 H	261	78.66	31.54
1	*2437.00	106.40 AV			1.22 H	261	74.86	31.54
2	4874.00	53.36 PK	74.00	-20.64	1.06 H	156	16.07	37.29
2	4874.00	49.46 AV	54.00	-4.54	1.06 H	156	12.17	37.29

ANTENNA POLARITY & TEST DISTANCE: VERTICAL AT 3 M								
NO.	FREQ. (MHz)	EMISSION LEVEL (dBuV/m)	LIMIT (dBuV/m)	MARGIN (dB)	ANTENNA HEIGHT (m)	TABLE ANGLE (Degree)	RAW VALUE (dBuV)	CORRECTION FACTOR (dB/m)
1	*2437.00	112.30 PK			1.11 V	289	80.76	31.54
1	*2437.00	108.60 AV			1.11 V	289	77.06	31.54
2	4874.00	55.54 PK	74.00	-18.46	1.12 V	294	18.25	37.29
2	4874.00	52.75 AV	54.00	-1.25	1.12 V	294	15.46	37.29

- REMARKS:**
1. Emission level (dBuV/m) = Raw Value (dBuV) + Correction Factor (dB/m).
  2. Correction Factor (dB/m) = Antenna Factor (dB/m) + Cable Factor (dB).
  3. The other emission levels were very low against the limit.
  4. Margin value = Emission level – Limit value.
  5. The limit value is defined as per 15.247.
  6. “ \* “: Fundamental frequency.



EUT TEST CONDITION		MEASUREMENT DETAIL	
CHANNEL	Channel 11	FREQUENCY RANGE	1 ~ 25GHz
MODULATION TYPE	DBPSK	INPUT POWER (SYSTEM)	120Vac, 60 Hz
TRANSFER RATE	1Mbps	DETECTOR FUNCTION	Peak(PK) Average (AV)
ENVIRONMENTAL CONDITIONS	26deg. C, 70%RH, 991hPa	TESTED BY	Match Tsui

ANTENNA POLARITY & TEST DISTANCE: HORIZONTAL AT 3 M								
NO.	FREQ. (MHz)	EMISSION LEVEL (dBuV/m)	LIMIT (dBuV/m)	MARGIN (dB)	ANTENNA HEIGHT (m)	TABLE ANGLE (Degree)	RAW VALUE (dBuV)	CORRECTION FACTOR (dB/m)
1	*2462.00	107.58 PK			1.26 H	222	75.96	31.62
1	*2462.00	103.86 AV			1.26 H	222	72.24	31.62
2	2487.00	58.87 PK	74.00	-15.13	1.00 H	224	27.16	31.71
2	2487.00	50.36 AV	54.00	-3.64	1.00 H	224	18.65	31.71
3	4924.00	51.69 PK	74.00	-22.31	1.04 H	152	14.25	37.44
3	4924.00	47.83 AV	54.00	-6.17	1.04 H	152	10.39	37.44

ANTENNA POLARITY & TEST DISTANCE: VERTICAL AT 3 M								
NO.	FREQ. (MHz)	EMISSION LEVEL (dBuV/m)	LIMIT (dBuV/m)	MARGIN (dB)	ANTENNA HEIGHT (m)	TABLE ANGLE (Degree)	RAW VALUE (dBuV)	CORRECTION FACTOR (dB/m)
1	*2462.00	110.28 PK			1.11 V	189	78.66	31.62
1	*2462.00	106.60 AV			1.11 V	189	74.98	31.62
2	2487.00	61.27 PK	74.00	-12.73	1.12 V	140	29.56	31.71
2	2487.00	52.65 AV	54.00	-1.35	1.12 V	140	20.94	31.71
3	4924.00	54.68 PK	74.00	-19.32	1.00 V	165	17.24	37.44
3	4924.00	51.70 AV	54.00	-2.30	1.00 V	165	14.26	37.44

- REMARKS:**
1. Emission level (dBuV/m) = Raw Value (dBuV) + Correction Factor (dB/m).
  2. Correction Factor (dB/m) = Antenna Factor (dB/m) + Cable Factor (dB).
  3. The other emission levels were very low against the limit.
  4. Margin value = Emission level – Limit value.
  5. The limit value is defined as per 15.247.
  6. “ \* “: Fundamental frequency.

**802.11g OFDM MODULATION: DUAL TX:**

EUT TEST CONDITION		MEASUREMENT DETAIL	
CHANNEL	Channel 1	FREQUENCY RANGE	1 ~ 25GHz
MODULATION TYPE	BPSK	INPUT POWER (SYSTEM)	120Vac, 60 Hz
TRANSFER RATE	6Mbps	DETECTOR FUNCTION	Peak(PK) Average (AV)
ENVIRONMENTAL CONDITIONS	26deg. C, 70%RH, 991hPa	TESTED BY	Match Tsui

ANTENNA POLARITY & TEST DISTANCE: HORIZONTAL AT 3 M								
NO.	FREQ. (MHz)	EMISSION LEVEL (dBuV/m)	LIMIT (dBuV/m)	MARGIN (dB)	ANTENNA HEIGHT (m)	TABLE ANGLE (Degree)	RAW VALUE (dBuV)	CORRECTION FACTOR (dB/m)
1	2390.00	67.02 PK	74.00	-6.98	1.25 H	278	35.63	31.39
1	2390.00	49.54 AV	54.00	-4.46	1.25 H	278	18.15	31.39
2	*2412.00	108.48 PK			1.22 H	262	77.02	31.46
2	*2412.00	99.70 AV			1.22 H	262	68.24	31.46
3	2894.00	57.22 PK	74.00	-16.78	1.00 H	241	24.82	32.40
3	2894.00	50.06 AV	54.00	-3.94	1.00 H	241	17.66	32.40
4	4824.00	51.24 PK	74.00	-22.76	1.04 H	240	14.11	37.13
4	4824.00	35.69 AV	54.00	-18.31	1.04 H	240	-1.44	37.13

ANTENNA POLARITY & TEST DISTANCE: VERTICAL AT 3 M								
NO.	FREQ. (MHz)	EMISSION LEVEL (dBuV/m)	LIMIT (dBuV/m)	MARGIN (dB)	ANTENNA HEIGHT (m)	TABLE ANGLE (Degree)	RAW VALUE (dBuV)	CORRECTION FACTOR (dB/m)
1	2390.00	70.08 PK	74.00	-3.92	1.14 V	16	38.69	31.39
1	2390.00	52.56 AV	54.00	-1.44	1.14 V	16	21.17	31.39
2	*2412.00	111.45 PK			1.12 V	34	79.99	31.46
2	*2412.00	102.45 AV			1.12 V	34	70.99	31.46
3	2894.00	58.99 PK	74.00	-15.01	1.22 V	85	26.59	32.40
3	2894.00	51.46 AV	54.00	-2.54	1.22 V	85	19.06	32.40
4	4824.00	56.30 PK	74.00	-17.70	1.29 V	87	19.17	37.13
4	4824.00	39.77 AV	54.00	-14.23	1.29 V	87	2.64	37.13

- REMARKS:**
1. Emission level (dBuV/m) = Raw Value (dBuV) + Correction Factor (dB/m).
  2. Correction Factor (dB/m) = Antenna Factor (dB/m) + Cable Factor (dB).
  3. The other emission levels were very low against the limit.
  4. Margin value = Emission level – Limit value.
  5. The limit value is defined as per 15.247.
  6. “ \* “: Fundamental frequency.

EUT TEST CONDITION		MEASUREMENT DETAIL	
CHANNEL	Channel 6	FREQUENCY RANGE	1 ~ 25GHz
MODULATION TYPE	BPSK	INPUT POWER (SYSTEM)	120Vac, 60 Hz
TRANSFER RATE	6Mbps	DETECTOR FUNCTION	Peak(PK) Average (AV)
ENVIRONMENTAL CONDITIONS	26deg. C, 70%RH, 991hPa	TESTED BY	Match Tsui

ANTENNA POLARITY & TEST DISTANCE: HORIZONTAL AT 3 M								
NO.	FREQ. (MHz)	EMISSION LEVEL (dBuV/m)	LIMIT (dBuV/m)	MARGIN (dB)	ANTENNA HEIGHT (m)	TABLE ANGLE (Degree)	RAW VALUE (dBuV)	CORRECTION FACTOR (dB/m)
1	2390.00	60.51 PK	74.00	-13.49	1.23 H	261	29.12	31.39
1	2390.00	47.89 AV	54.00	-6.11	1.23 H	261	16.50	31.39
2	*2437.00	112.72 PK			1.23 H	267	81.18	31.54
2	*2437.00	103.43 AV			1.23 H	267	71.89	31.54
3	2483.50	58.71 PK	74.00	-15.29	1.21 H	264	27.01	31.70
3	2483.50	49.61 AV	54.00	-4.39	1.21 H	264	17.91	31.70
4	2924.00	56.68 PK	74.00	-17.32	1.20 H	41	24.23	32.45
4	2924.00	46.86 AV	54.00	-7.14	1.20 H	41	14.41	32.45
5	4874.00	52.21 PK	74.00	-21.79	1.44 H	245	14.92	37.29
5	4874.00	38.22 AV	54.00	-15.78	1.44 H	245	0.93	37.29

ANTENNA POLARITY & TEST DISTANCE: VERTICAL AT 3 M								
NO.	FREQ. (MHz)	EMISSION LEVEL (dBuV/m)	LIMIT (dBuV/m)	MARGIN (dB)	ANTENNA HEIGHT (m)	TABLE ANGLE (Degree)	RAW VALUE (dBuV)	CORRECTION FACTOR (dB/m)
1	2382.00	60.08 PK	74.00	-13.92	1.11 V	260	28.72	31.36
1	2382.00	49.85 AV	54.00	-4.15	1.11 V	260	18.49	31.36
2	*2437.00	114.65 PK			1.08 V	281	83.11	31.54
2	*2437.00	105.42 AV			1.08 V	281	73.88	31.54
3	2483.50	62.62 PK	74.00	-11.38	1.32 V	255	30.92	31.70
3	2483.50	51.86 AV	54.00	-2.14	1.32 V	255	20.16	31.70
4	2924.00	58.61 PK	74.00	-15.39	1.09 V	254	26.16	32.45
4	2924.00	50.54 AV	54.00	-3.46	1.09 V	254	18.09	32.45
5	4874.00	59.40 PK	74.00	-14.60	1.28 V	92	22.11	37.29
5	4874.00	44.01 AV	54.00	-9.99	1.28 V	92	6.72	37.29

- REMARKS:**
1. Emission level (dBuV/m) = Raw Value (dBuV) + Correction Factor (dB/m).
  2. Correction Factor (dB/m) = Antenna Factor (dB/m) + Cable Factor (dB).
  3. The other emission levels were very low against the limit.
  4. Margin value = Emission level – Limit value.
  5. The limit value is defined as per 15.247.
  6. “ \* “: Fundamental frequency.

EUT TEST CONDITION		MEASUREMENT DETAIL	
CHANNEL	Channel 11	FREQUENCY RANGE	1 ~ 25GHz
MODULATION TYPE	BPSK	INPUT POWER (SYSTEM)	120Vac, 60 Hz
TRANSFER RATE	6Mbps	DETECTOR FUNCTION	Peak(PK) Average (AV)
ENVIRONMENTAL CONDITIONS	26deg. C, 70%RH, 991hPa	TESTED BY	Match Tsui

ANTENNA POLARITY & TEST DISTANCE: HORIZONTAL AT 3 M								
NO.	FREQ. (MHz)	EMISSION LEVEL (dBuV/m)	LIMIT (dBuV/m)	MARGIN (dB)	ANTENNA HEIGHT (m)	TABLE ANGLE (Degree)	RAW VALUE (dBuV)	CORRECTION FACTOR (dB/m)
1	*2462.00	107.92 PK			1.20 H	244	76.30	31.62
1	*2462.00	98.93 AV			1.20 H	244	67.31	31.62
2	2484.00	63.23 PK	74.00	-10.77	1.20 H	249	31.53	31.70
2	2484.00	50.04 AV	54.00	-3.96	1.20 H	249	18.34	31.70
3	4924.00	44.95 PK	74.00	-29.05	1.10 H	0	7.51	37.44
3	4924.00	34.43 AV	54.00	-19.57	1.10 H	0	-3.01	37.44

ANTENNA POLARITY & TEST DISTANCE: VERTICAL AT 3 M								
NO.	FREQ. (MHz)	EMISSION LEVEL (dBuV/m)	LIMIT (dBuV/m)	MARGIN (dB)	ANTENNA HEIGHT (m)	TABLE ANGLE (Degree)	RAW VALUE (dBuV)	CORRECTION FACTOR (dB/m)
1	*2462.00	110.61 PK			1.11 V	302	78.99	31.62
1	*2462.00	101.22 AV			1.11 V	302	69.60	31.62
2	2483.50	64.55 PK	74.00	-9.45	1.06 V	248	32.85	31.70
2	2483.50	52.27 AV	54.00	-1.73	1.06 V	248	20.57	31.70
3	4924.00	49.20 PK	74.00	-24.80	1.23 V	76	11.76	37.44
3	4924.00	34.50 AV	54.00	-19.50	1.00 V	171	-2.94	37.44

- REMARKS:**
1. Emission level (dBuV/m) = Raw Value (dBuV) + Correction Factor (dB/m).
  2. Correction Factor (dB/m) = Antenna Factor (dB/m) + Cable Factor (dB).
  3. The other emission levels were very low against the limit.
  4. Margin value = Emission level – Limit value.
  5. The limit value is defined as per 15.247.
  6. “ \* “: Fundamental frequency.

**DRAFT 802.11n (20MHz) OFDM MODULATION: DUAL TX:**

EUT TEST CONDITION		MEASUREMENT DETAIL	
CHANNEL	Channel 1	FREQUENCY RANGE	1 ~ 25GHz
MODULATION TYPE	BPSK	INPUT POWER (SYSTEM)	120Vac, 60 Hz
TRANSFER RATE	7.2Mbps	DETECTOR FUNCTION	Peak(PK) Average (AV)
ENVIRONMENTAL CONDITIONS	26deg. C, 70%RH, 991hPa	TESTED BY	Match Tsui

**ANTENNA POLARITY & TEST DISTANCE: HORIZONTAL AT 3 M**

NO.	FREQ. (MHz)	EMISSION LEVEL (dBuV/m)	LIMIT (dBuV/m)	MARGIN (dB)	ANTENNA HEIGHT (m)	TABLE ANGLE (Degree)	RAW VALUE (dBuV)	CORRECTION FACTOR (dB/m)
1	2390.00	65.85 PK	74.00	-8.15	1.28 H	236	34.46	31.39
1	2390.00	51.30 AV	54.00	-2.70	1.28 H	236	19.91	31.39
2	*2412.00	108.03 PK			1.27 H	259	76.57	31.46
2	*2412.00	97.43 AV			1.27 H	259	65.97	31.46
3	4824.00	50.38 PK	74.00	-23.62	1.60 H	260	13.25	37.13
3	4824.00	36.73 AV	54.00	-17.27	1.60 H	260	-0.40	37.13

**ANTENNA POLARITY & TEST DISTANCE: VERTICAL AT 3 M**

NO.	FREQ. (MHz)	EMISSION LEVEL (dBuV/m)	LIMIT (dBuV/m)	MARGIN (dB)	ANTENNA HEIGHT (m)	TABLE ANGLE (Degree)	RAW VALUE (dBuV)	CORRECTION FACTOR (dB/m)
1	2360.00	57.72 PK	74.00	-16.28	1.14 V	215	26.44	31.28
1	2360.00	48.72 AV	54.00	-5.28	1.14 V	215	17.44	31.28
2	2390.00	67.65 PK	74.00	-6.35	1.11 V	257	36.26	31.39
2	2390.00	52.98 AV	54.00	-1.02	1.11 V	257	21.59	31.39
3	*2412.00	110.57 PK			1.11 V	250	79.11	31.46
3	*2412.00	99.12 AV			1.11 V	250	67.66	31.46
4	2894.00	56.59 PK	74.00	-17.41	1.18 V	216	24.19	32.40
4	2894.00	48.08 AV	54.00	-5.92	1.18 V	216	15.68	32.40
5	4824.00	52.95 PK	74.00	-21.05	1.00 V	98	15.82	37.13
5	4824.00	39.66 AV	54.00	-14.34	1.00 V	98	2.53	37.13

- REMARKS:**
1. Emission level (dBuV/m) = Raw Value (dBuV) + Correction Factor (dB/m).
  2. Correction Factor (dB/m) = Antenna Factor (dB/m) + Cable Factor (dB).
  3. The other emission levels were very low against the limit.
  4. Margin value = Emission level – Limit value.
  5. The limit value is defined as per 15.247.
  6. “ \* “: Fundamental frequency.

EUT TEST CONDITION		MEASUREMENT DETAIL	
CHANNEL	Channel 6	FREQUENCY RANGE	1 ~ 25GHz
MODULATION TYPE	BPSK	INPUT POWER (SYSTEM)	120Vac, 60 Hz
TRANSFER RATE	7.2Mbps	DETECTOR FUNCTION	Peak(PK) Average (AV)
ENVIRONMENTAL CONDITIONS	26deg. C, 70%RH, 991hPa	TESTED BY	Match Tsui

ANTENNA POLARITY & TEST DISTANCE: HORIZONTAL AT 3 M								
NO.	FREQ. (MHz)	EMISSION LEVEL (dBuV/m)	LIMIT (dBuV/m)	MARGIN (dB)	ANTENNA HEIGHT (m)	TABLE ANGLE (Degree)	RAW VALUE (dBuV)	CORRECTION FACTOR (dB/m)
1	2390.00	56.39 PK	74.00	-17.61	1.21 H	259	25.00	31.39
1	2390.00	46.75 AV	54.00	-7.25	1.21 H	259	15.36	31.39
2	*2437.00	111.51 PK			1.21 H	250	79.97	31.54
2	*2437.00	100.78 AV			1.21 H	250	69.24	31.54
3	2483.50	60.49 PK	74.00	-13.51	1.21 H	259	28.79	31.70
3	2483.50	49.35 AV	54.00	-4.65	1.21 H	259	17.65	31.70
4	4874.00	51.08 PK	74.00	-22.92	1.44 H	244	13.79	37.29
4	4874.00	37.21 AV	54.00	-16.79	1.44 H	244	-0.08	37.29

ANTENNA POLARITY & TEST DISTANCE: VERTICAL AT 3 M								
NO.	FREQ. (MHz)	EMISSION LEVEL (dBuV/m)	LIMIT (dBuV/m)	MARGIN (dB)	ANTENNA HEIGHT (m)	TABLE ANGLE (Degree)	RAW VALUE (dBuV)	CORRECTION FACTOR (dB/m)
1	2382.00	58.51 PK	74.00	-15.49	1.11 V	272	27.15	31.36
1	2382.00	48.77 AV	54.00	-5.23	1.11 V	272	17.41	31.36
2	*2437.00	113.04 PK			1.06 V	281	81.50	31.54
2	*2437.00	102.46 AV			1.06 V	281	70.92	31.54
3	2483.50	67.52 PK	74.00	-6.48	1.31 V	256	35.82	31.70
3	2483.50	52.13 AV	54.00	-1.87	1.31 V	256	20.43	31.70
4	2924.00	57.35 PK	93.04	-35.69	1.07 V	277	24.90	32.45
4	2924.00	48.35 AV	82.46	-34.11	1.07 V	277	15.90	32.45
5	4874.00	55.87 PK	74.00	-18.13	1.43 V	92	18.58	37.29
5	4874.00	42.41 AV	54.00	-11.59	1.43 V	92	5.12	37.29

- REMARKS:**
1. Emission level (dBuV/m) = Raw Value (dBuV) + Correction Factor (dB/m).
  2. Correction Factor (dB/m) = Antenna Factor (dB/m) + Cable Factor (dB).
  3. The other emission levels were very low against the limit.
  4. Margin value = Emission level – Limit value.
  5. The limit value is defined as per 15.247.
  6. “ \* “: Fundamental frequency.

EUT TEST CONDITION		MEASUREMENT DETAIL	
CHANNEL	Channel 11	FREQUENCY RANGE	1 ~ 25GHz
MODULATION TYPE	BPSK	INPUT POWER (SYSTEM)	120Vac, 60 Hz
TRANSFER RATE	7.2Mbps	DETECTOR FUNCTION	Peak(PK) Average (AV)
ENVIRONMENTAL CONDITIONS	26deg. C, 70%RH, 991hPa	TESTED BY	Match Tsui

ANTENNA POLARITY & TEST DISTANCE: HORIZONTAL AT 3 M								
NO.	FREQ. (MHz)	EMISSION LEVEL (dBuV/m)	LIMIT (dBuV/m)	MARGIN (dB)	ANTENNA HEIGHT (m)	TABLE ANGLE (Degree)	RAW VALUE (dBuV)	CORRECTION FACTOR (dB/m)
1	*2462.00	106.56 PK			1.20 H	259	74.94	31.62
1	*2462.00	97.50 AV			1.20 H	259	65.88	31.62
2	2484.00	61.71 PK	74.00	-12.29	1.19 H	249	30.01	31.70
2	2484.00	50.62 AV	54.00	-3.38	1.19 H	249	18.92	31.70
3	4924.00	50.20 PK	74.00	-23.80	1.07 H	11	12.76	37.44
3	4924.00	36.27 AV	54.00	-17.73	1.07 H	11	-1.17	37.44

ANTENNA POLARITY & TEST DISTANCE: VERTICAL AT 3 M								
NO.	FREQ. (MHz)	EMISSION LEVEL (dBuV/m)	LIMIT (dBuV/m)	MARGIN (dB)	ANTENNA HEIGHT (m)	TABLE ANGLE (Degree)	RAW VALUE (dBuV)	CORRECTION FACTOR (dB/m)
1	2360.00	57.13 PK	74.00	-16.87	1.12 V	256	25.85	31.28
1	2360.00	46.79 AV	54.00	-7.21	1.12 V	256	15.51	31.28
2	*2462.00	109.02 PK			1.06 V	256	77.40	31.62
2	*2462.00	99.06 AV			1.06 V	256	67.44	31.62
3	2484.00	68.75 PK	74.00	-5.25	1.10 V	219	37.05	31.70
3	2484.00	52.90 AV	54.00	-1.10	1.10 V	219	21.20	31.70
4	4924.00	51.27 PK	74.00	-22.73	1.04 V	111	13.83	37.44
4	4924.00	39.24 AV	54.00	-14.76	1.04 V	111	1.80	37.44

- REMARKS:**
1. Emission level (dBuV/m) = Raw Value (dBuV) + Correction Factor (dB/m).
  2. Correction Factor (dB/m) = Antenna Factor (dB/m) + Cable Factor (dB).
  3. The other emission levels were very low against the limit.
  4. Margin value = Emission level – Limit value.
  5. The limit value is defined as per 15.247.
  6. “ \* “: Fundamental frequency.

**DRAFT 802.11n (40MHz) OFDM MODULATION: DUAL TX:**

EUT TEST CONDITION		MEASUREMENT DETAIL	
CHANNEL	Channel 1	FREQUENCY RANGE	1 ~ 25GHz
MODULATION TYPE	BPSK	INPUT POWER (SYSTEM)	120Vac, 60 Hz
TRANSFER RATE	15Mbps	DETECTOR FUNCTION	Peak(PK) Average (AV)
ENVIRONMENTAL CONDITIONS	26deg. C, 70%RH, 991hPa	TESTED BY	Match Tsui

ANTENNA POLARITY & TEST DISTANCE: HORIZONTAL AT 3 M								
NO.	FREQ. (MHz)	EMISSION LEVEL (dBuV/m)	LIMIT (dBuV/m)	MARGIN (dB)	ANTENNA HEIGHT (m)	TABLE ANGLE (Degree)	RAW VALUE (dBuV)	CORRECTION FACTOR (dB/m)
1	2390.00	60.48 PK	74.00	-13.52	1.26 H	234	29.09	31.39
1	2390.00	49.92 AV	54.00	-4.08	1.26 H	234	18.53	31.39
2	*2422.00	102.04 PK			1.24 H	223	70.55	31.49
2	*2422.00	90.26 AV			1.24 H	223	58.77	31.49
3	4844.00	45.26 PK	74.00	-28.74	1.19 H	0	8.07	37.19
3	4844.00	33.23 AV	54.00	-20.77	1.19 H	0	-3.96	37.19

ANTENNA POLARITY & TEST DISTANCE: VERTICAL AT 3 M								
NO.	FREQ. (MHz)	EMISSION LEVEL (dBuV/m)	LIMIT (dBuV/m)	MARGIN (dB)	ANTENNA HEIGHT (m)	TABLE ANGLE (Degree)	RAW VALUE (dBuV)	CORRECTION FACTOR (dB/m)
1	2390.00	63.28 PK	74.00	-10.72	1.14 V	143	31.89	31.39
1	2390.00	52.31 AV	54.00	-1.69	1.14 V	143	20.92	31.39
2	*2422.00	106.43 PK			1.12 V	31	74.94	31.49
2	*2422.00	95.74 AV			1.12 V	31	64.25	31.49
3	2906.00	56.85 PK	86.43	-29.58	1.48 V	265	24.43	32.42
3	2906.00	46.09 AV	75.74	-29.65	1.48 V	265	13.67	32.42
4	4844.00	46.04 PK	74.00	-27.96	1.08 V	360	8.85	37.19
4	4844.00	33.50 AV	54.00	-20.50	1.08 V	360	-3.69	37.19

- REMARKS:**
1. Emission level (dBuV/m) = Raw Value (dBuV) + Correction Factor (dB/m).
  2. Correction Factor (dB/m) = Antenna Factor (dB/m) + Cable Factor (dB).
  3. The other emission levels were very low against the limit.
  4. Margin value = Emission level – Limit value.
  5. The limit value is defined as per 15.247.
  6. “ \* “: Fundamental frequency.



EUT TEST CONDITION		MEASUREMENT DETAIL	
CHANNEL	Channel 4	FREQUENCY RANGE	1 ~ 25GHz
MODULATION TYPE	BPSK	INPUT POWER (SYSTEM)	120Vac, 60 Hz
TRANSFER RATE	15Mbps	DETECTOR FUNCTION	Peak(PK) Average (AV)
ENVIRONMENTAL CONDITIONS	26deg. C, 70%RH, 991hPa	TESTED BY	Match Tsui

ANTENNA POLARITY & TEST DISTANCE: HORIZONTAL AT 3 M								
NO.	FREQ. (MHz)	EMISSION LEVEL (dBuV/m)	LIMIT (dBuV/m)	MARGIN (dB)	ANTENNA HEIGHT (m)	TABLE ANGLE (Degree)	RAW VALUE (dBuV)	CORRECTION FACTOR (dB/m)
1	2390.00	58.00 PK	74.00	-16.00	1.85 H	69	26.61	31.39
1	2390.00	47.32 AV	54.00	-6.68	1.85 H	69	15.93	31.39
2	*2437.00	104.36 PK			1.77 H	98	72.82	31.54
2	*2437.00	92.87 AV			1.77 H	68	61.33	31.54
3	2483.50	60.21 PK	74.00	-13.79	1.79 H	77	28.51	31.70
3	2483.50	49.86 AV	54.00	-4.14	1.79 H	77	18.16	31.70
4	4874.00	45.69 PK	74.00	-28.31	1.10 H	0	8.40	37.29
4	4874.00	33.59 AV	54.00	-20.41	1.10 H	0	-3.70	37.29

ANTENNA POLARITY & TEST DISTANCE: VERTICAL AT 3 M								
NO.	FREQ. (MHz)	EMISSION LEVEL (dBuV/m)	LIMIT (dBuV/m)	MARGIN (dB)	ANTENNA HEIGHT (m)	TABLE ANGLE (Degree)	RAW VALUE (dBuV)	CORRECTION FACTOR (dB/m)
1	2360.00	57.13 PK	74.00	-16.87	1.00 V	345	25.85	31.28
1	2360.00	47.27 AV	54.00	-6.73	1.00 V	345	15.99	31.28
2	2390.00	63.34 PK	74.00	-10.66	1.12 V	259	31.95	31.39
2	2390.00	50.20 AV	54.00	-3.80	1.12 V	259	18.81	31.39
3	*2437.00	107.19 PK			1.08 V	260	75.65	31.54
3	*2437.00	97.39 AV			1.08 V	260	65.85	31.54
4	2483.50	67.11 PK	74.00	-6.89	1.07 V	259	35.41	31.70
4	2483.50	52.97 AV	54.00	-1.03	1.07 V	259	21.27	31.70
5	4874.00	46.24 PK	74.00	-27.76	1.10 V	0	8.95	37.29
5	4874.00	33.60 AV	54.00	-20.40	1.10 V	0	-3.69	37.29

- REMARKS:**
1. Emission level (dBuV/m) = Raw Value (dBuV) + Correction Factor (dB/m).
  2. Correction Factor (dB/m) = Antenna Factor (dB/m) + Cable Factor (dB).
  3. The other emission levels were very low against the limit.
  4. Margin value = Emission level – Limit value.
  5. The limit value is defined as per 15.247.
  6. “ \* “: Fundamental frequency.

EUT TEST CONDITION		MEASUREMENT DETAIL	
CHANNEL	Channel 7	FREQUENCY RANGE	1 ~ 25GHz
MODULATION TYPE	BPSK	INPUT POWER (SYSTEM)	120Vac, 60 Hz
TRANSFER RATE	15Mbps	DETECTOR FUNCTION	Peak(PK) Average (AV)
ENVIRONMENTAL CONDITIONS	26deg. C, 70%RH, 991hPa	TESTED BY	Match Tsui

ANTENNA POLARITY & TEST DISTANCE: HORIZONTAL AT 3 M								
NO.	FREQ. (MHz)	EMISSION LEVEL (dBuV/m)	LIMIT (dBuV/m)	MARGIN (dB)	ANTENNA HEIGHT (m)	TABLE ANGLE (Degree)	RAW VALUE (dBuV)	CORRECTION FACTOR (dB/m)
1	*2452.00	101.93 PK			1.23 H	255	70.34	31.59
1	*2452.00	90.01 AV			1.23 H	255	58.42	31.59
2	2483.50	62.59 PK	74.00	-11.41	1.21 H	252	30.89	31.70
2	2483.50	51.54 AV	54.00	-2.46	1.21 H	252	19.84	31.70
3	4904.00	46.99 PK	74.00	-27.01	1.21 H	360	9.61	37.38
3	4904.00	33.93 AV	54.00	-20.07	1.21 H	360	-3.45	37.38

ANTENNA POLARITY & TEST DISTANCE: VERTICAL AT 3 M								
NO.	FREQ. (MHz)	EMISSION LEVEL (dBuV/m)	LIMIT (dBuV/m)	MARGIN (dB)	ANTENNA HEIGHT (m)	TABLE ANGLE (Degree)	RAW VALUE (dBuV)	CORRECTION FACTOR (dB/m)
1	*2452.00	105.06 PK			1.07 V	283	73.47	31.59
1	*2452.00	94.99 AV			1.07 V	283	63.40	31.59
2	2483.50	64.79 PK	74.00	-9.21	1.05 V	277	33.09	31.70
2	2483.50	52.97 AV	54.00	-1.03	1.05 V	277	21.27	31.70
3	4904.00	46.22 PK	74.00	-27.78	1.00 V	0	8.84	37.38
3	4904.00	32.93 AV	54.00	-21.07	1.00 V	0	-4.45	37.38

- REMARKS:**
1. Emission level (dBuV/m) = Raw Value (dBuV) + Correction Factor (dB/m).
  2. Correction Factor (dB/m) = Antenna Factor (dB/m) + Cable Factor (dB).
  3. The other emission levels were very low against the limit.
  4. Margin value = Emission level – Limit value.
  5. The limit value is defined as per 15.247.
  6. “ \* “: Fundamental frequency.

**802.11b(CB mode) DSSS MODULATION: DUAL TX:**

EUT TEST CONDITION		MEASUREMENT DETAIL	
CHANNEL	Channel 1	FREQUENCY RANGE	1 ~ 25GHz
MODULATION TYPE	DBPSK	INPUT POWER (SYSTEM)	120Vac, 60 Hz
TRANSFER RATE	1Mbps	DETECTOR FUNCTION	Peak(PK) Average (AV)
ENVIRONMENTAL CONDITIONS	26deg. C, 70%RH, 991hPa	TESTED BY	Match Tsui

ANTENNA POLARITY & TEST DISTANCE: HORIZONTAL AT 3 M								
NO.	FREQ. (MHz)	EMISSION LEVEL (dBuV/m)	LIMIT (dBuV/m)	MARGIN (dB)	ANTENNA HEIGHT (m)	TABLE ANGLE (Degree)	RAW VALUE (dBuV)	CORRECTION FACTOR (dB/m)
1	2389.00	59.37 PK	74.00	-14.63	1.28 H	256	27.99	31.38
1	2389.00	51.50 AV	54.00	-2.50	1.28 H	256	20.12	31.38
2	*2432.00	108.83 PK			1.24 H	255	77.30	31.53
2	*2432.00	105.06 AV			1.24 H	255	73.53	31.53
3	4864.00	50.90 PK	74.00	-23.10	1.23 H	276	13.65	37.25
3	4864.00	45.49 AV	54.00	-8.51	1.23 H	276	8.24	37.25

ANTENNA POLARITY & TEST DISTANCE: VERTICAL AT 3 M								
NO.	FREQ. (MHz)	EMISSION LEVEL (dBuV/m)	LIMIT (dBuV/m)	MARGIN (dB)	ANTENNA HEIGHT (m)	TABLE ANGLE (Degree)	RAW VALUE (dBuV)	CORRECTION FACTOR (dB/m)
1	2348.00	56.83 PK	74.00	-17.17	1.38 V	51	25.59	31.24
1	2348.00	47.43 AV	54.00	-6.57	1.38 V	51	16.19	31.24
2	2389.00	60.42 PK	74.00	-13.58	1.14 V	298	29.04	31.38
2	2389.00	52.91 AV	54.00	-1.09	1.14 V	298	21.53	31.38
3	*2432.00	110.20 PK			1.12 V	48	78.67	31.53
3	*2432.00	106.76 AV			1.12 V	48	75.23	31.53
4	4864.00	50.72 PK	74.00	-23.28	1.58 V	53	13.47	37.25
4	4864.00	45.72 AV	54.00	-8.28	1.58 V	53	8.47	37.25

- REMARKS:**
1. Emission level (dBuV/m) = Raw Value (dBuV) + Correction Factor (dB/m).
  2. Correction Factor (dB/m) = Antenna Factor (dB/m) + Cable Factor (dB).
  3. The other emission levels were very low against the limit.
  4. Margin value = Emission level – Limit value.
  5. The limit value is defined as per 15.247.
  6. “ \* “: Fundamental frequency.

EUT TEST CONDITION		MEASUREMENT DETAIL	
CHANNEL	Channel 4	FREQUENCY RANGE	1 ~ 25GHz
MODULATION TYPE	DBPSK	INPUT POWER (SYSTEM)	120Vac, 60 Hz
TRANSFER RATE	1Mbps	DETECTOR FUNCTION	Peak(PK) Average (AV)
ENVIRONMENTAL CONDITIONS	26deg. C, 70%RH, 991hPa	TESTED BY	Match Tsui

ANTENNA POLARITY & TEST DISTANCE: HORIZONTAL AT 3 M								
NO.	FREQ. (MHz)	EMISSION LEVEL (dBuV/m)	LIMIT (dBuV/m)	MARGIN (dB)	ANTENNA HEIGHT (m)	TABLE ANGLE (Degree)	RAW VALUE (dBuV)	CORRECTION FACTOR (dB/m)
1	2389.00	57.24 PK	74.00	-16.76	1.25 H	259	25.86	31.38
1	2389.00	48.71 AV	54.00	-5.29	1.25 H	259	17.33	31.38
2	*2437.00	109.11 PK			1.00 H	258	77.57	31.54
2	*2437.00	105.55 AV			1.00 H	258	74.01	31.54
3	2484.00	59.11 PK	74.00	-14.89	1.22 H	257	27.41	31.70
3	2484.00	51.25 AV	54.00	-2.75	1.22 H	257	19.55	31.70
4	4874.00	49.11 PK	74.00	-24.89	1.03 H	157	11.82	37.29
4	4874.00	43.06 AV	54.00	-10.94	1.03 H	157	5.77	37.29

ANTENNA POLARITY & TEST DISTANCE: VERTICAL AT 3 M								
NO.	FREQ. (MHz)	EMISSION LEVEL (dBuV/m)	LIMIT (dBuV/m)	MARGIN (dB)	ANTENNA HEIGHT (m)	TABLE ANGLE (Degree)	RAW VALUE (dBuV)	CORRECTION FACTOR (dB/m)
1	2388.00	61.45 PK	74.00	-12.55	1.08 V	241	30.07	31.38
1	2388.00	52.16 AV	54.00	-1.84	1.08 V	241	20.78	31.38
2	*2437.00	112.36 PK			1.10 V	296	80.82	31.54
2	*2437.00	108.85 AV			1.10 V	296	77.31	31.54
3	2484.00	61.16 PK	74.00	-12.84	1.06 V	261	29.46	31.70
3	<b>2484.00</b>	<b>52.99 AV</b>	<b>54.00</b>	<b>-1.01</b>	<b>1.06 V</b>	<b>261</b>	<b>21.29</b>	<b>31.70</b>
4	4874.00	52.80 PK	74.00	-21.20	1.00 V	191	15.51	37.29
4	4874.00	47.79 AV	54.00	-6.21	1.00 V	191	10.50	37.29

- REMARKS:**
1. Emission level (dBuV/m) = Raw Value (dBuV) + Correction Factor (dB/m).
  2. Correction Factor (dB/m) = Antenna Factor (dB/m) + Cable Factor (dB).
  3. The other emission levels were very low against the limit.
  4. Margin value = Emission level – Limit value.
  5. The limit value is defined as per 15.247.
  6. “ \* “: Fundamental frequency.

EUT TEST CONDITION		MEASUREMENT DETAIL	
CHANNEL	Channel 7	FREQUENCY RANGE	1 ~ 25GHz
MODULATION TYPE	DBPSK	INPUT POWER (SYSTEM)	120Vac, 60 Hz
TRANSFER RATE	1Mbps	DETECTOR FUNCTION	Peak(PK) Average (AV)
ENVIRONMENTAL CONDITIONS	26deg. C, 70%RH, 991hPa	TESTED BY	Match Tsui

ANTENNA POLARITY & TEST DISTANCE: HORIZONTAL AT 3 M								
NO.	FREQ. (MHz)	EMISSION LEVEL (dBuV/m)	LIMIT (dBuV/m)	MARGIN (dB)	ANTENNA HEIGHT (m)	TABLE ANGLE (Degree)	RAW VALUE (dBuV)	CORRECTION FACTOR (dB/m)
1	*2442.00	107.48 PK			1.21 H	264	75.92	31.56
1	*2442.00	104.09 AV			1.21 H	264	72.53	31.56
2	2483.50	58.88 PK	74.00	-15.12	1.21 H	261	27.18	31.70
2	2483.50	51.91 AV	54.00	-2.09	1.21 H	261	20.21	31.70
3	4884.00	46.39 PK	74.00	-27.61	1.16 H	97	9.07	37.32
3	4884.00	37.75 AV	54.00	-16.25	1.16 H	97	0.43	37.32

ANTENNA POLARITY & TEST DISTANCE: VERTICAL AT 3 M								
NO.	FREQ. (MHz)	EMISSION LEVEL (dBuV/m)	LIMIT (dBuV/m)	MARGIN (dB)	ANTENNA HEIGHT (m)	TABLE ANGLE (Degree)	RAW VALUE (dBuV)	CORRECTION FACTOR (dB/m)
1	*2442.00	109.87 PK			1.31 V	283	78.31	31.56
1	*2442.00	106.46 AV			1.31 V	283	74.90	31.56
2	2483.50	60.67 PK	74.00	-13.33	1.08 V	231	28.97	31.70
2	2483.50	52.57 AV	54.00	-1.43	1.08 V	231	20.87	31.70
3	4884.00	50.05 PK	74.00	-23.95	1.28 V	360	12.73	37.32
3	4884.00	44.87 AV	54.00	-9.13	1.28 V	360	7.55	37.32

- REMARKS:**
1. Emission level (dBuV/m) = Raw Value (dBuV) + Correction Factor (dB/m).
  2. Correction Factor (dB/m) = Antenna Factor (dB/m) + Cable Factor (dB).
  3. The other emission levels were very low against the limit.
  4. Margin value = Emission level – Limit value.
  5. The limit value is defined as per 15.247.
  6. “ \* “: Fundamental frequency.

### 4.3 6dB BANDWIDTH MEASUREMENT

#### 4.3.1 LIMITS OF 6dB BANDWIDTH MEASUREMENT

The minimum of 6dB Bandwidth Measurement is 0.5 MHz.

#### 4.3.2 TEST INSTRUMENTS

DESCRIPTION & MANUFACTURER	MODEL NO.	SERIAL NO.	CALIBRATED UNTIL
SPECTRUM ANALYZER	FSEK 30	100049	Aug. 14, 2006

**NOTE:** The calibration interval of the above test instruments is 12 months and the calibrations are traceable to NML/ROC and NIST/USA.

#### 4.3.3 TEST PROCEDURE

The transmitter output was connected to the spectrum analyzer through an attenuator. The bandwidth of the fundamental frequency was measured by spectrum analyzer with 100kHz RBW and 100kHz VBW. The 6dB bandwidth is defined as the total spectrum the power of which is higher than peak power minus 6dB.

#### 4.3.4 DEVIATION FROM TEST STANDARD

No deviation

#### 4.3.5 TEST SETUP

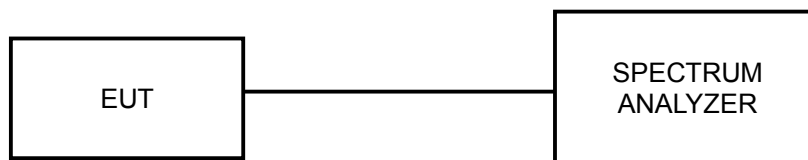

#### 4.3.6 EUT OPERATING CONDITIONS

The software provided by client to enable the EUT under transmission condition continuously at lowest, middle and highest channel frequencies individually.

### 4.3.7 TEST RESULTS

#### 802.11b DSSS MODULATION:

<b>MODULATION TYPE</b>	DBPSK	<b>TRANSFER RATE</b>	1Mbps
<b>INPUT POWER (SYSTEM)</b>	120Vac, 60 Hz	<b>ENVIRONMENTAL CONDITIONS</b>	26deg.C, 70%RH, 991hPa
<b>TESTED BY</b>	Match Tsui		

CHANNEL	CHANNEL FREQUENCY (MHz)	6dB BANDWIDTH (MHz)		MINIMUM LIMIT (MHz)	PASS / FAIL
		CHAIN 0	CHAIN 1		
1	2412	10.04	10.04	0.5	PASS
6	2437	10.04	10.04	0.5	PASS
11	2462	10.08	10.04	0.5	PASS

#### FOR CHAIN 0: CH 1

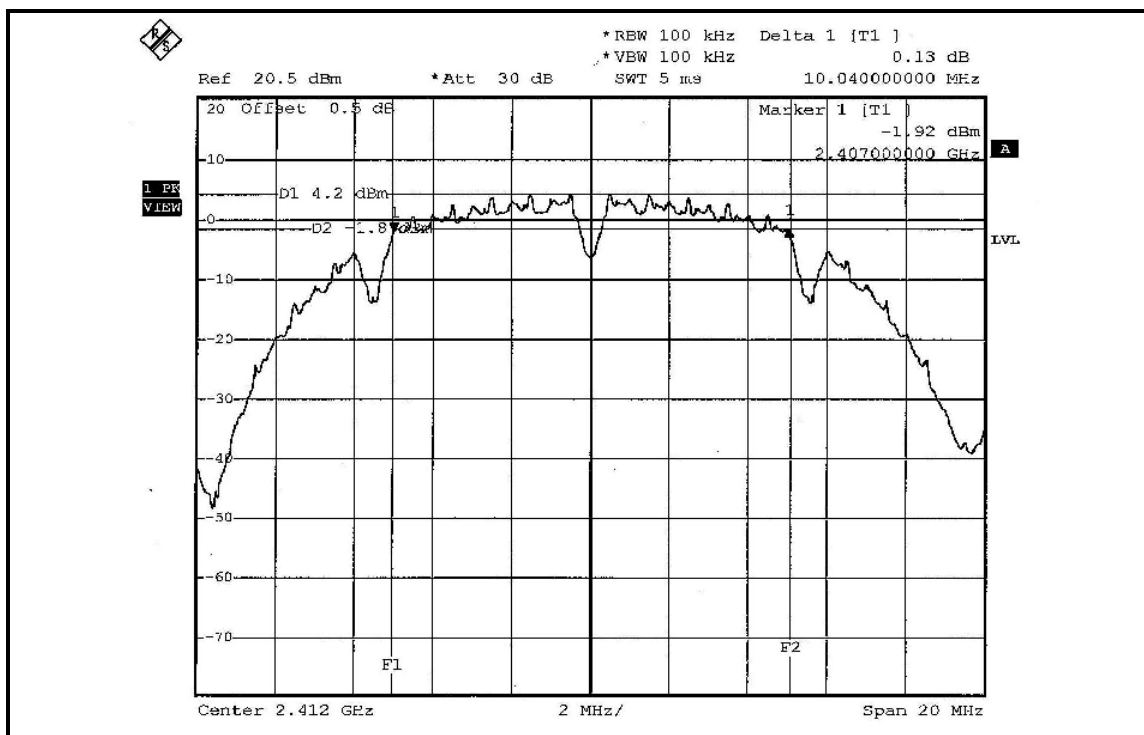



### CH 6

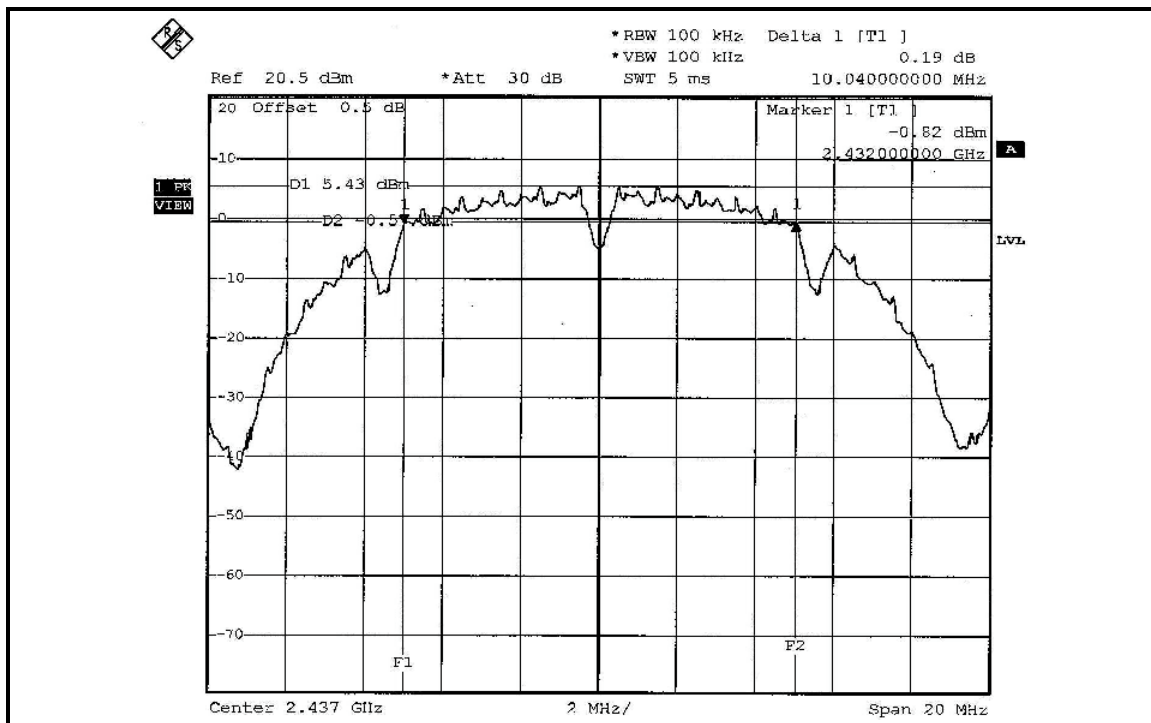

### CH 11

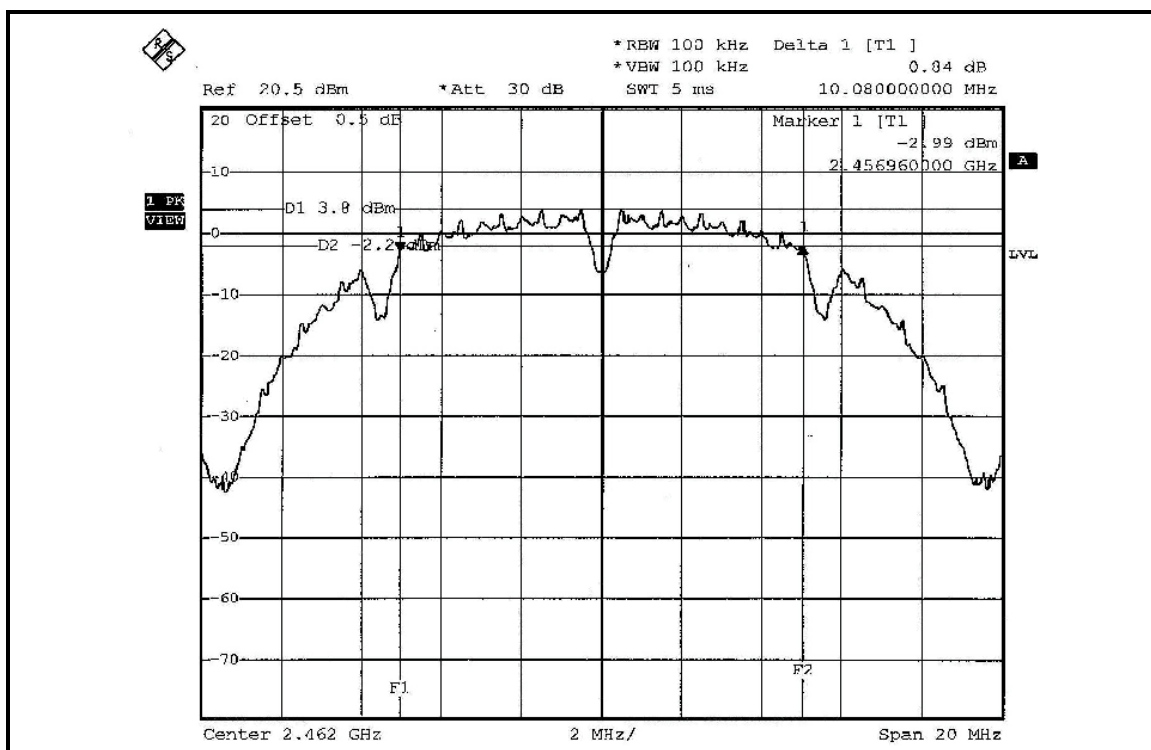

FOR CHAIN 1: CH 1

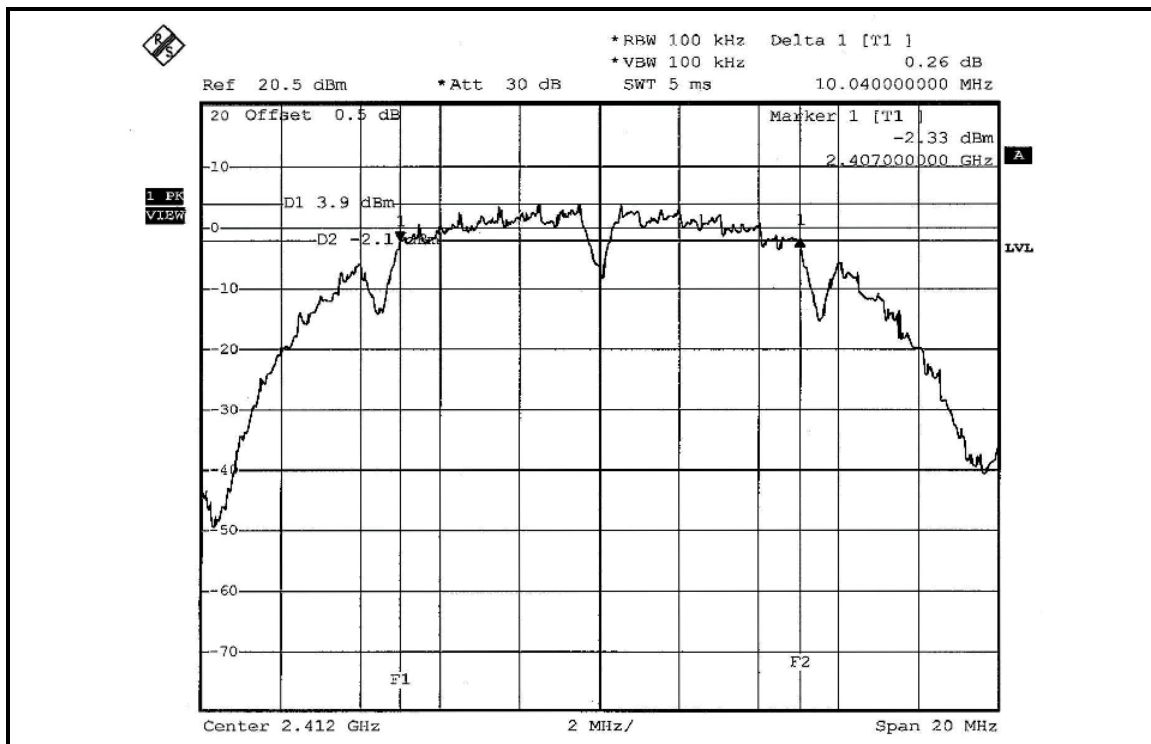

CH 6

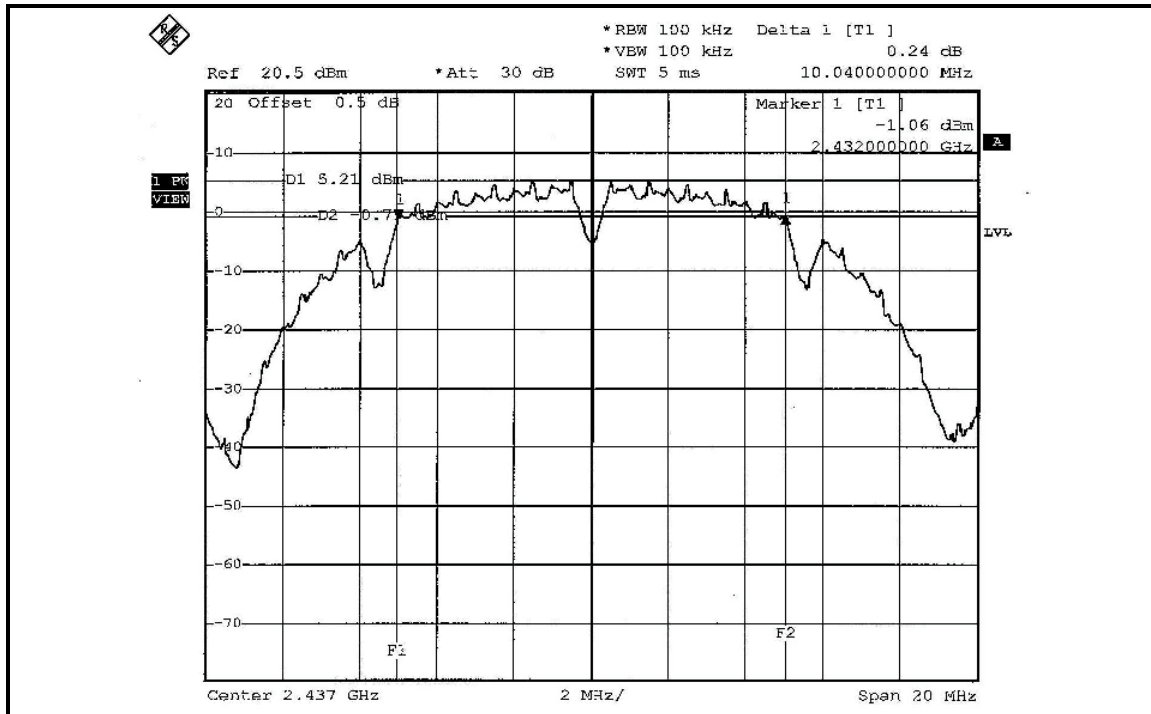

CH 11

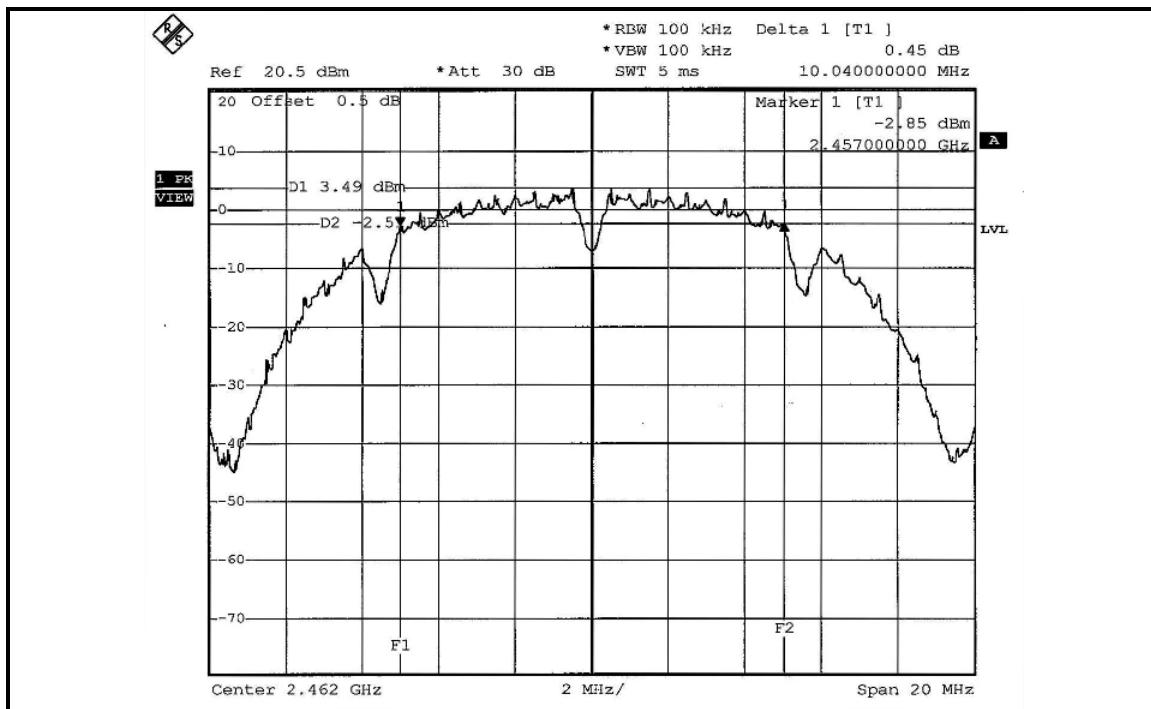

### 802.11g OFDM MODULATION:

<b>MODULATION TYPE</b>	BPSK	<b>TRANSFER RATE</b>	6Mbps
<b>INPUT POWER (SYSTEM)</b>	120Vac, 60 Hz	<b>ENVIRONMENTAL CONDITIONS</b>	26deg.C, 70%RH, 991hPa
<b>TESTED BY</b>	Match Tsui		

CHANNEL	CHANNEL FREQUENCY (MHz)	6dB BANDWIDTH (MHz)		MINIMUM LIMIT (MHz)	PASS / FAIL
		CHAIN 0	CHAIN 1		
1	2412	16.64	16.52	0.5	PASS
6	2437	16.56	16.56	0.5	PASS
11	2462	16.56	16.60	0.5	PASS

### FOR CHAIN 0: CH 1

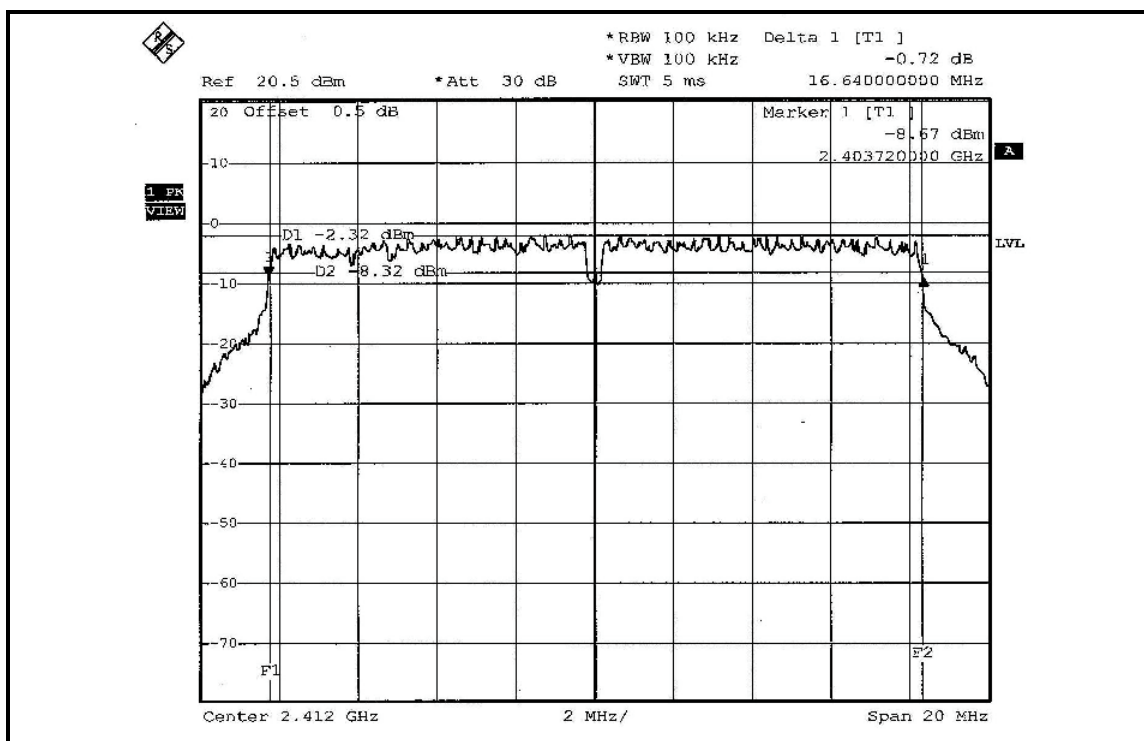

CH 6

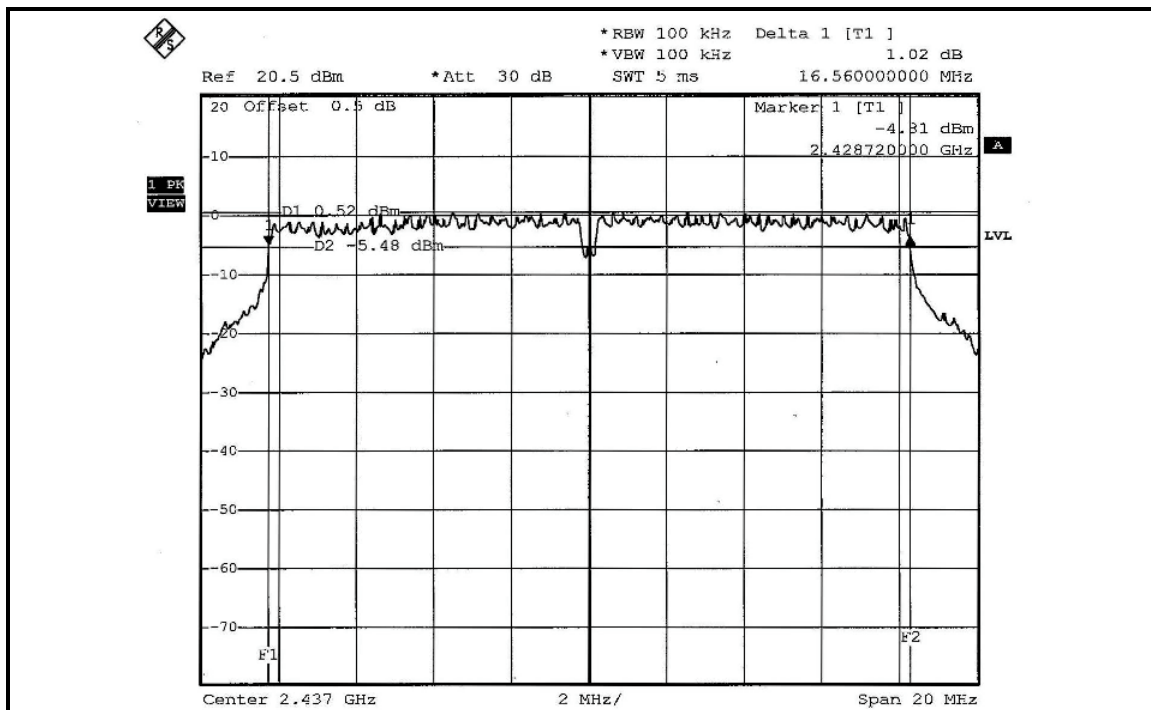

CH 11

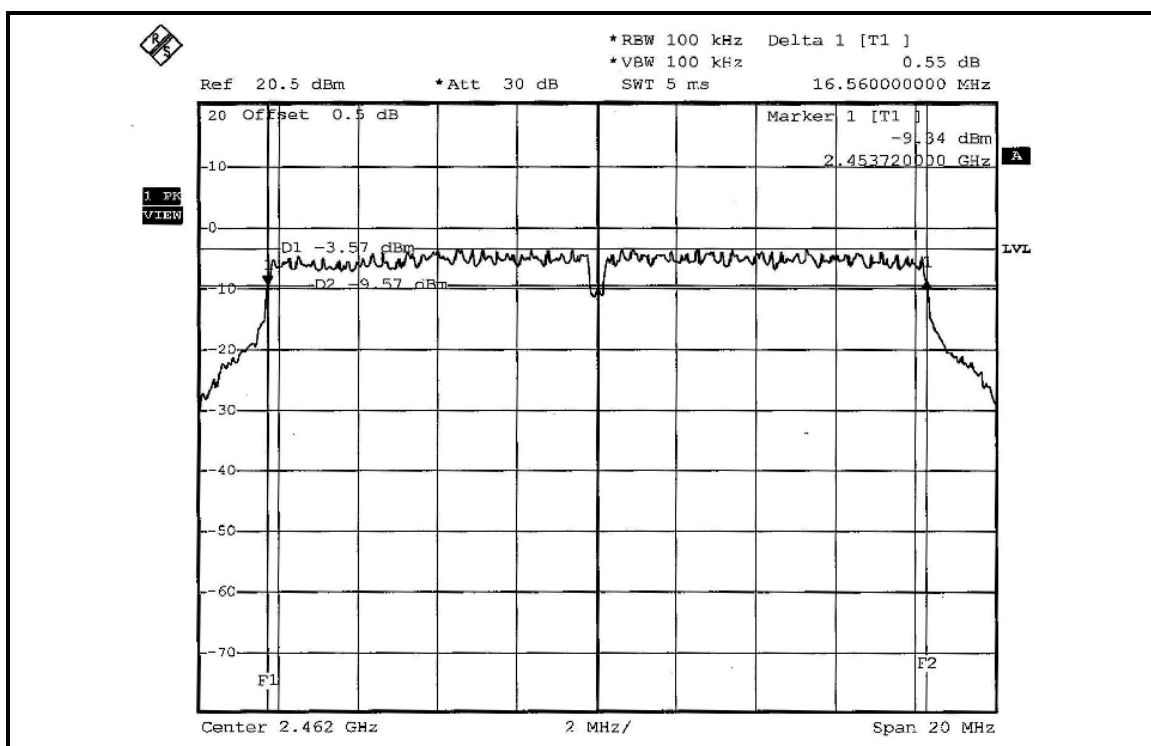

FOR CHAIN 1: CH 1

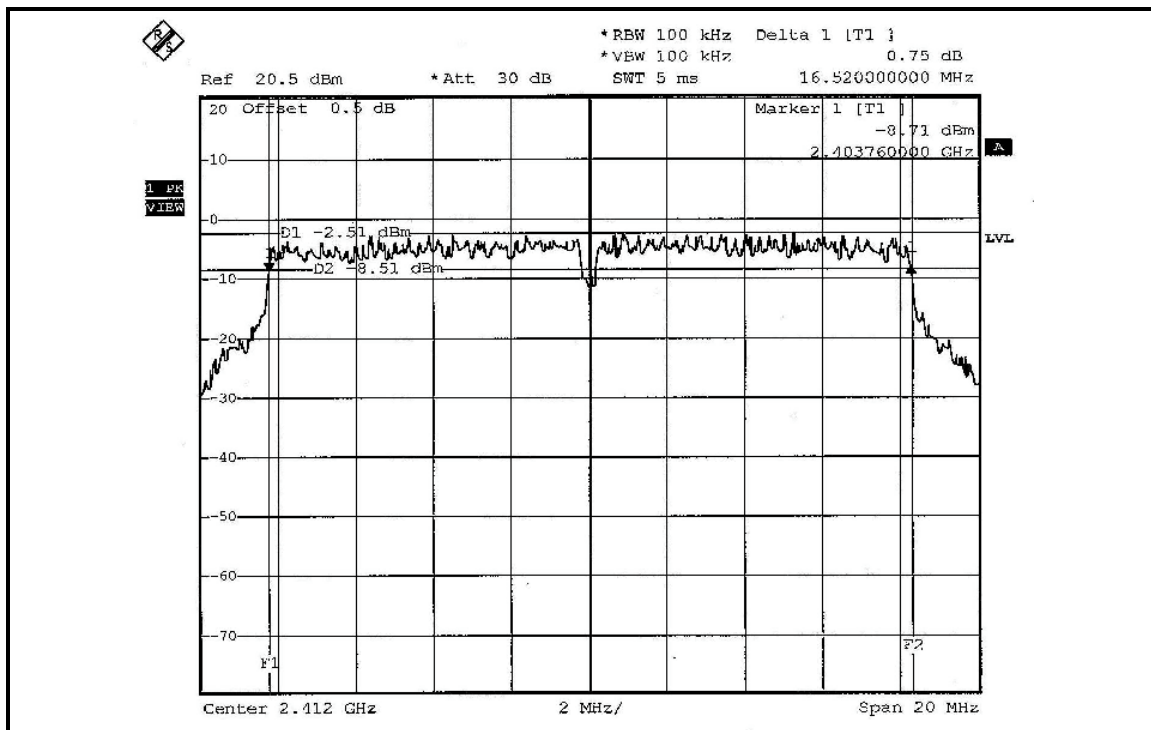

CH 6

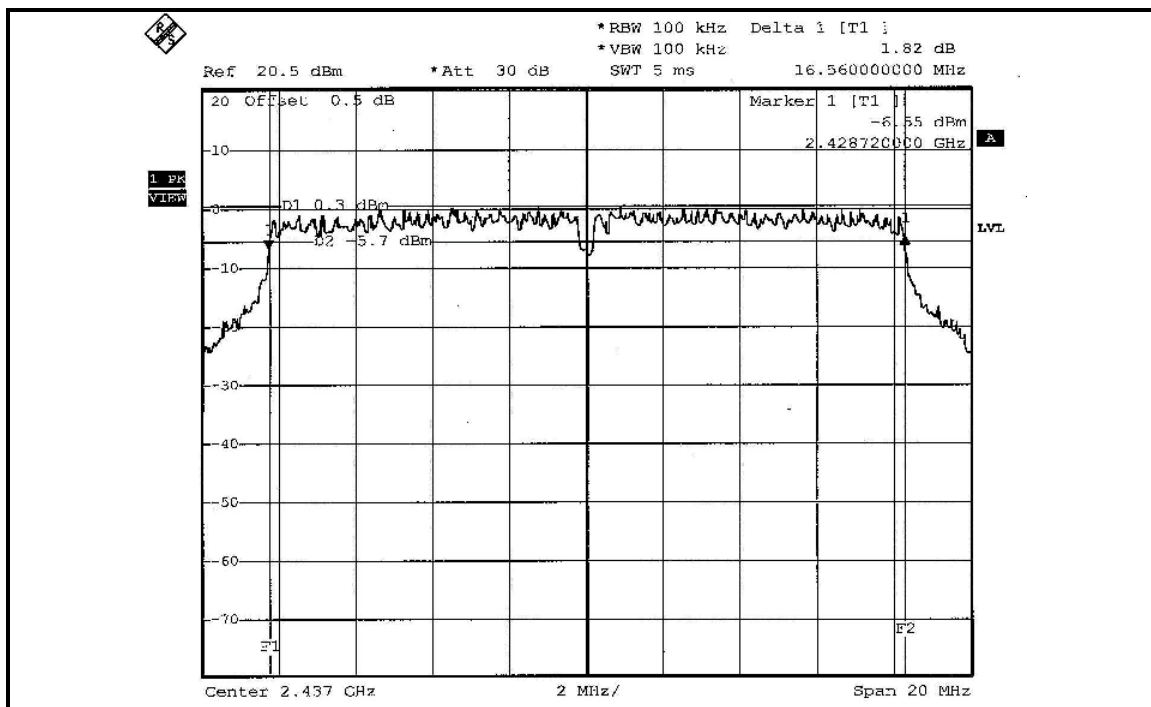

CH 11

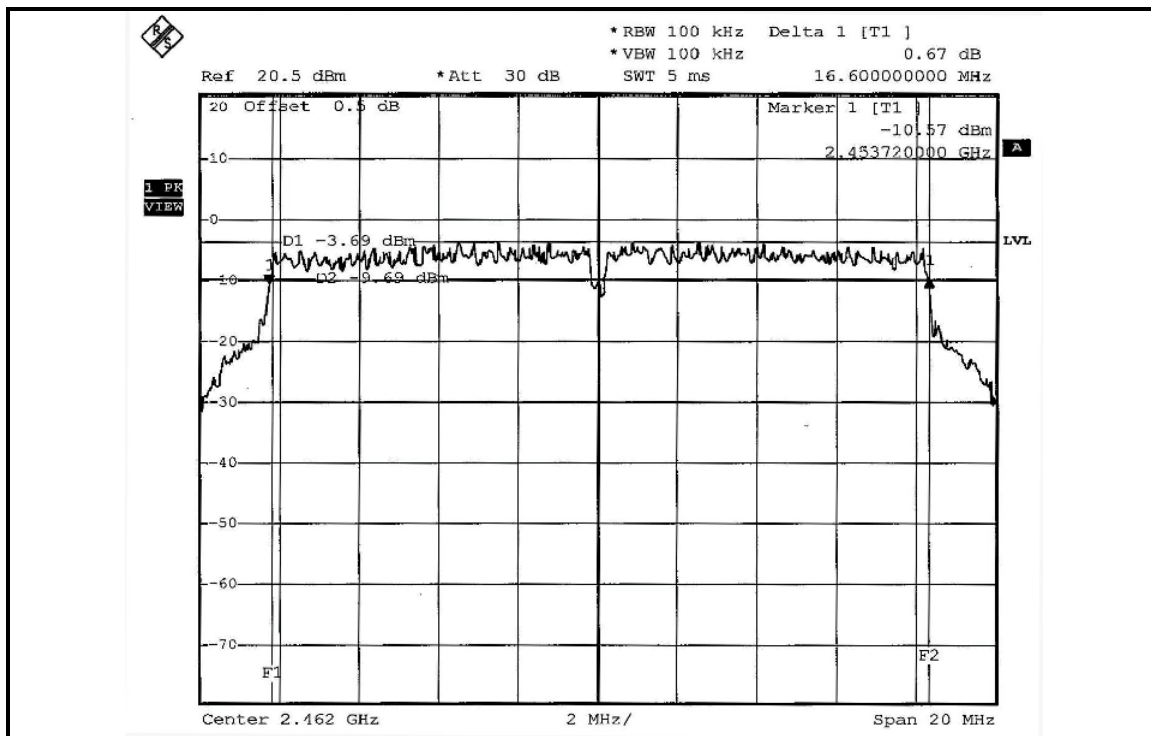



**DRAFT 802.11n (20MHz) OFDM MODULATION: DUAL TX:**

<b>MODULATION TYPE</b>	BPSK	<b>TRANSFER RATE</b>	7.2Mbps
<b>INPUT POWER (SYSTEM)</b>	120Vac, 60 Hz	<b>ENVIRONMENTAL CONDITIONS</b>	26deg.C, 70%RH, 991hPa
<b>TESTED BY</b>	Match Tsui		

CHANNEL	CHANNEL FREQUENCY (MHz)	6dB BANDWIDTH (MHz)		MINIMUM LIMIT (MHz)	PASS / FAIL
		CHAIN 0	CHAIN 1		
1	2412	17.76	17.80	0.5	PASS
6	2437	17.80	17.84	0.5	PASS
11	2462	17.84	17.72	0.5	PASS

**FOR CHAIN 0: CH 1**

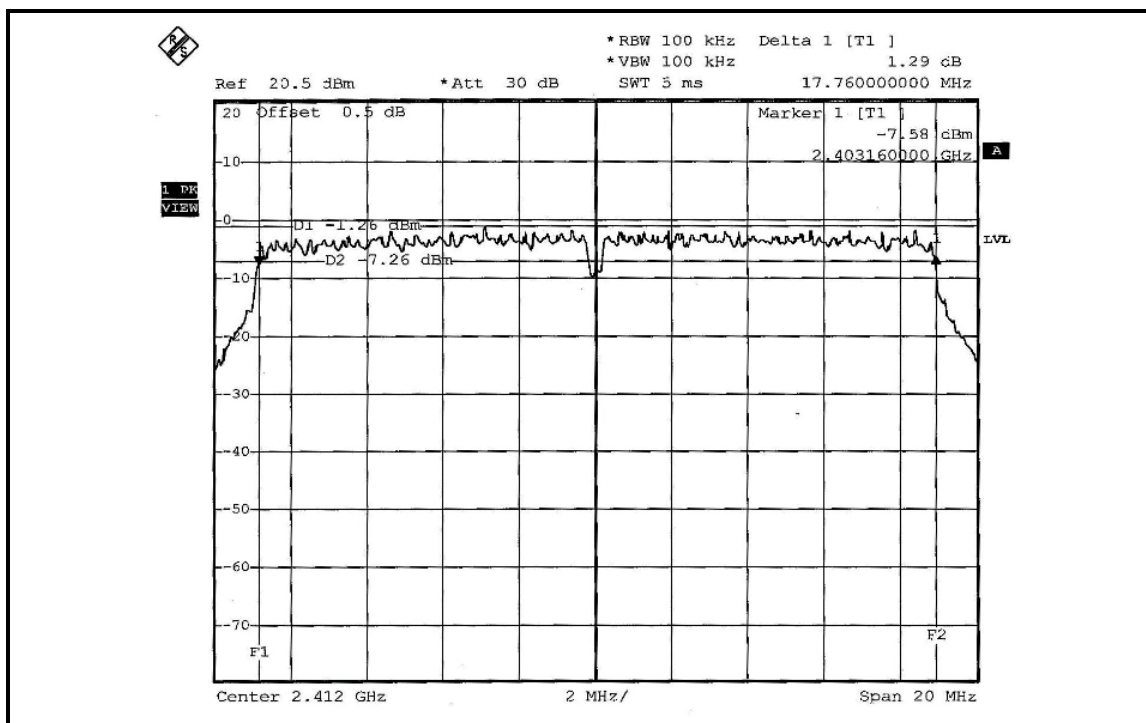



### CH 6

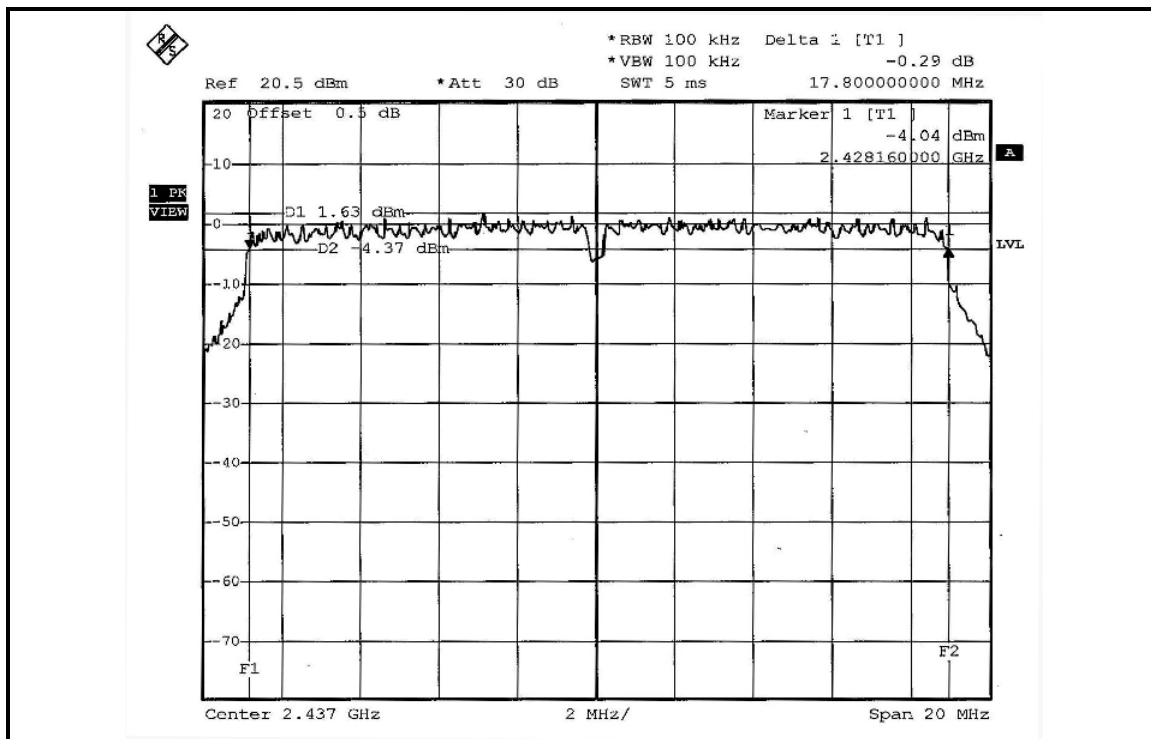

### CH 11

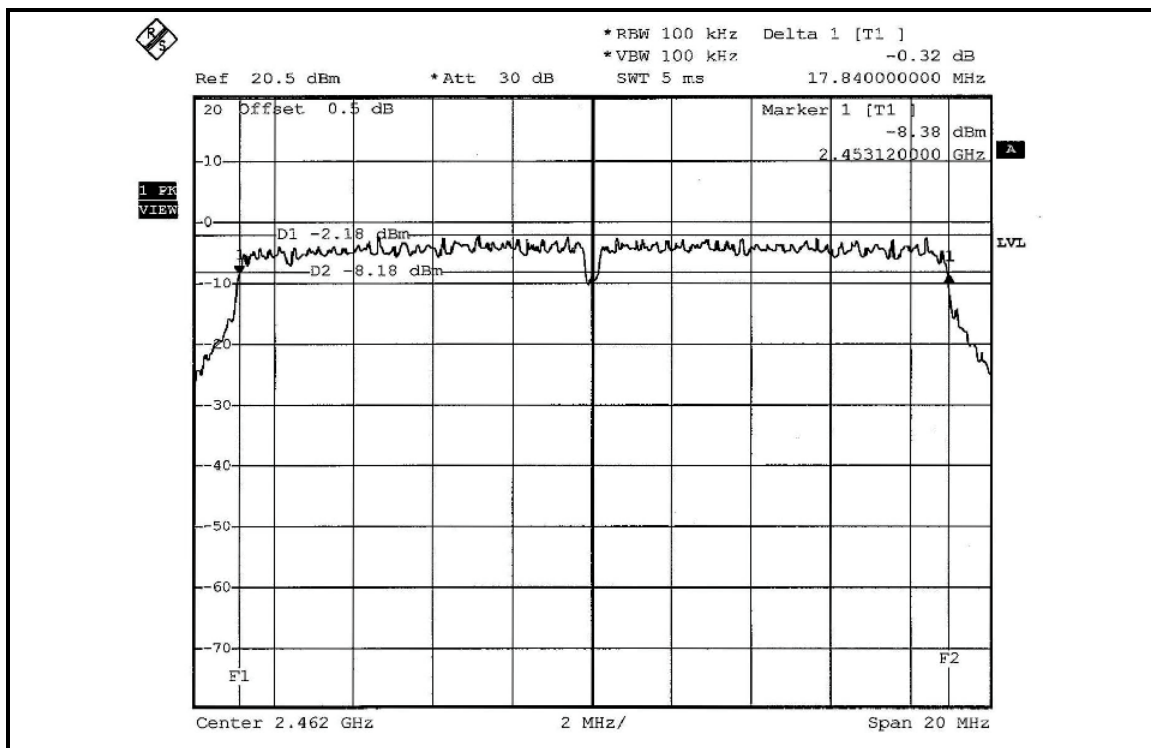

FOR CHAIN 1: CH 1

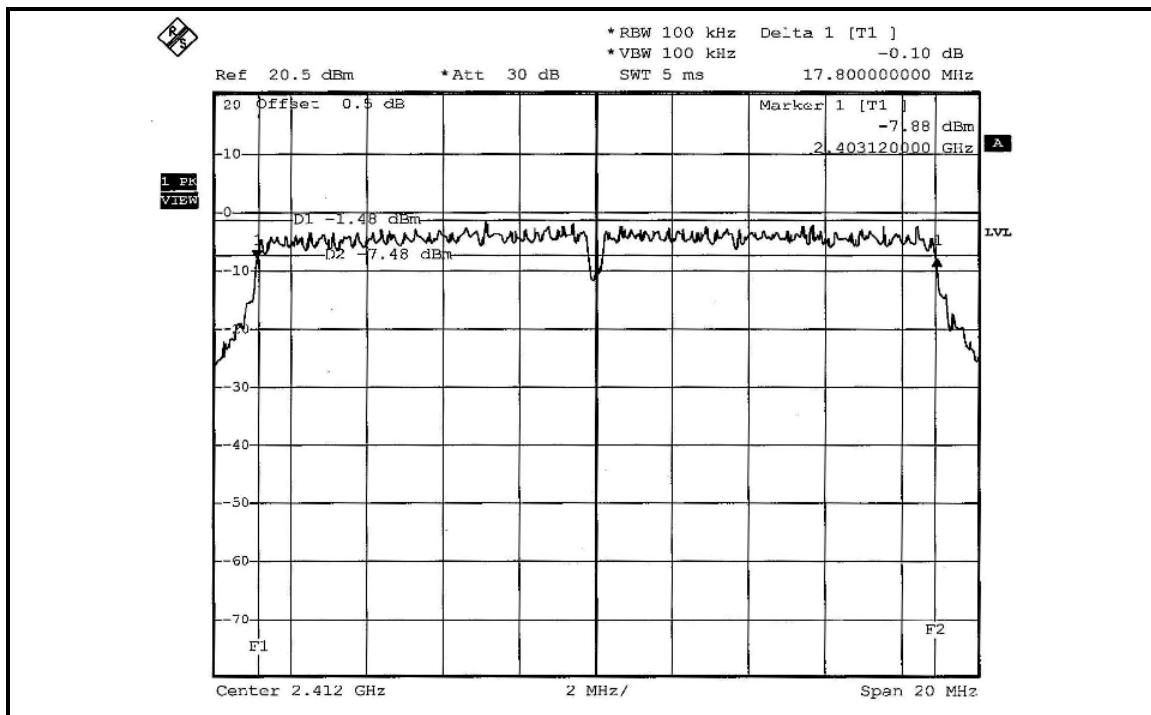

CH 6

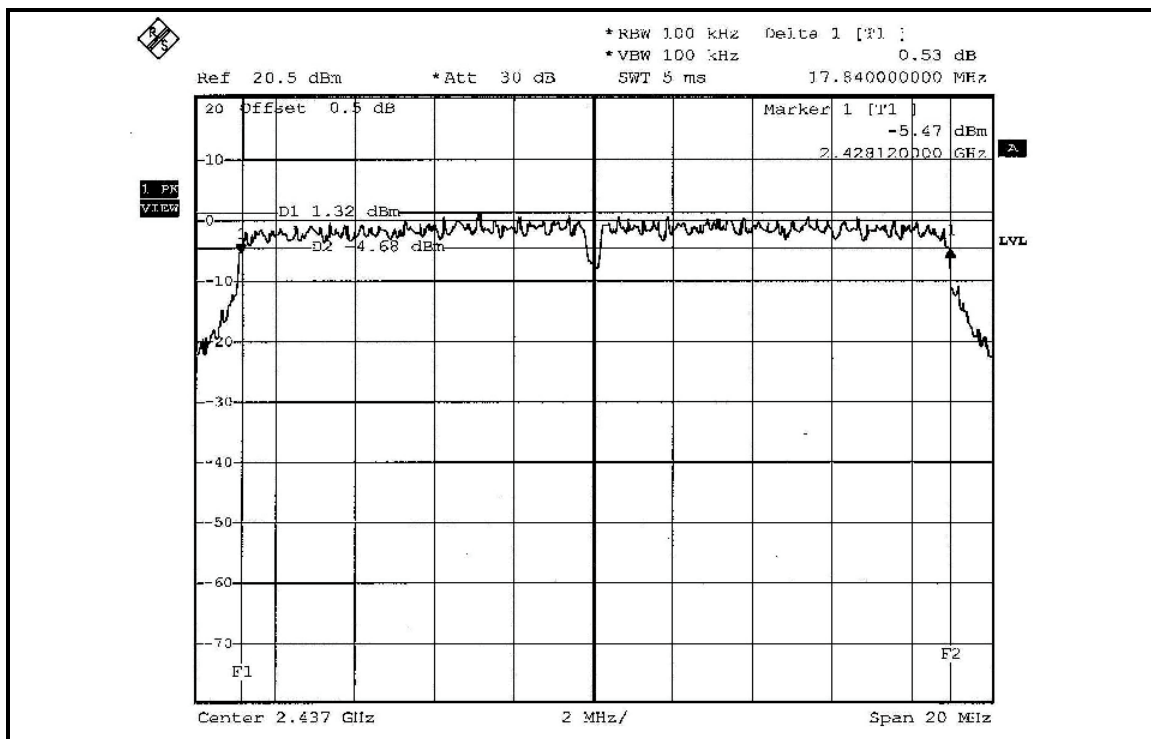

CH 11

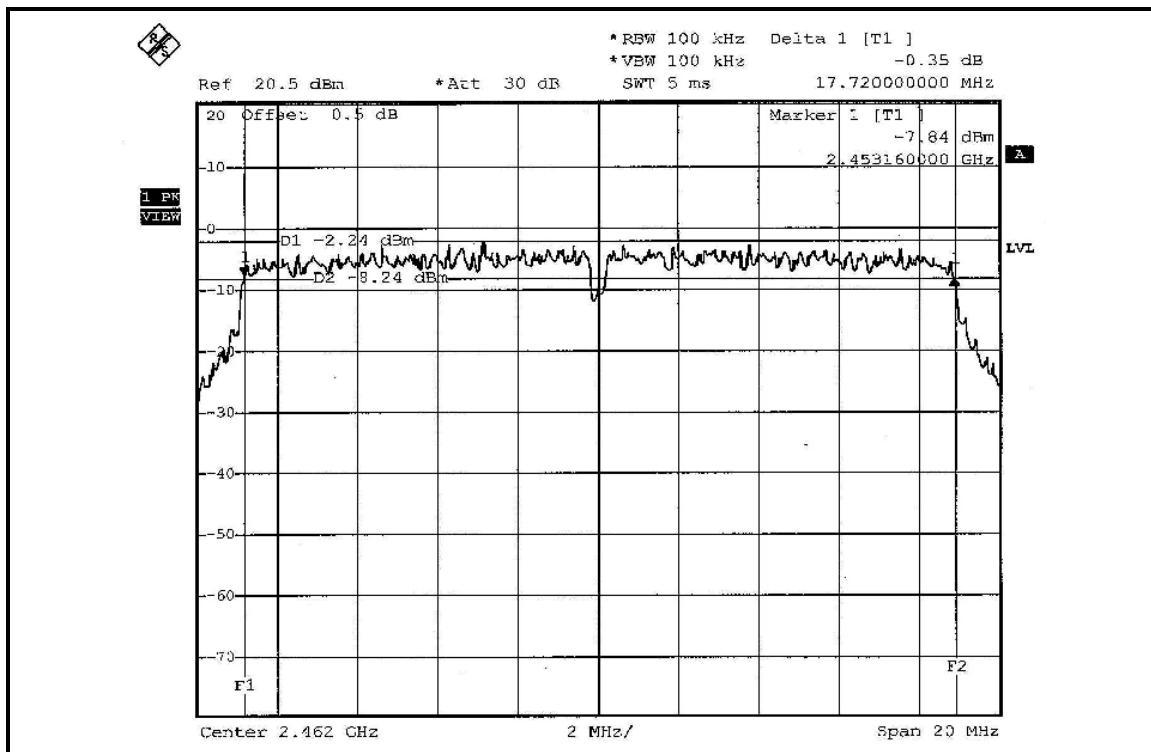



**DRAFT 802.11n (40MHz) OFDM MODULATION: DUAL TX:**

<b>MODULATION TYPE</b>	BPSK	<b>TRANSFER RATE</b>	15Mbps
<b>INPUT POWER (SYSTEM)</b>	120Vac, 60 Hz	<b>ENVIRONMENTAL CONDITIONS</b>	22deg.C, 64%RH, 991hPa
<b>TESTED BY</b>	Brad Wu		

CHANNEL	CHANNEL FREQUENCY (MHz)	6dB BANDWIDTH (MHz)		MINIMUM LIMIT (MHz)	PASS / FAIL
		CHAIN 0	CHAIN 1		
1	2422	36.56	36.48	0.5	PASS
4	2437	36.56	36.56	0.5	PASS
7	2452	36.56	36.32	0.5	PASS

**FOR CHAIN 0: CH 1**

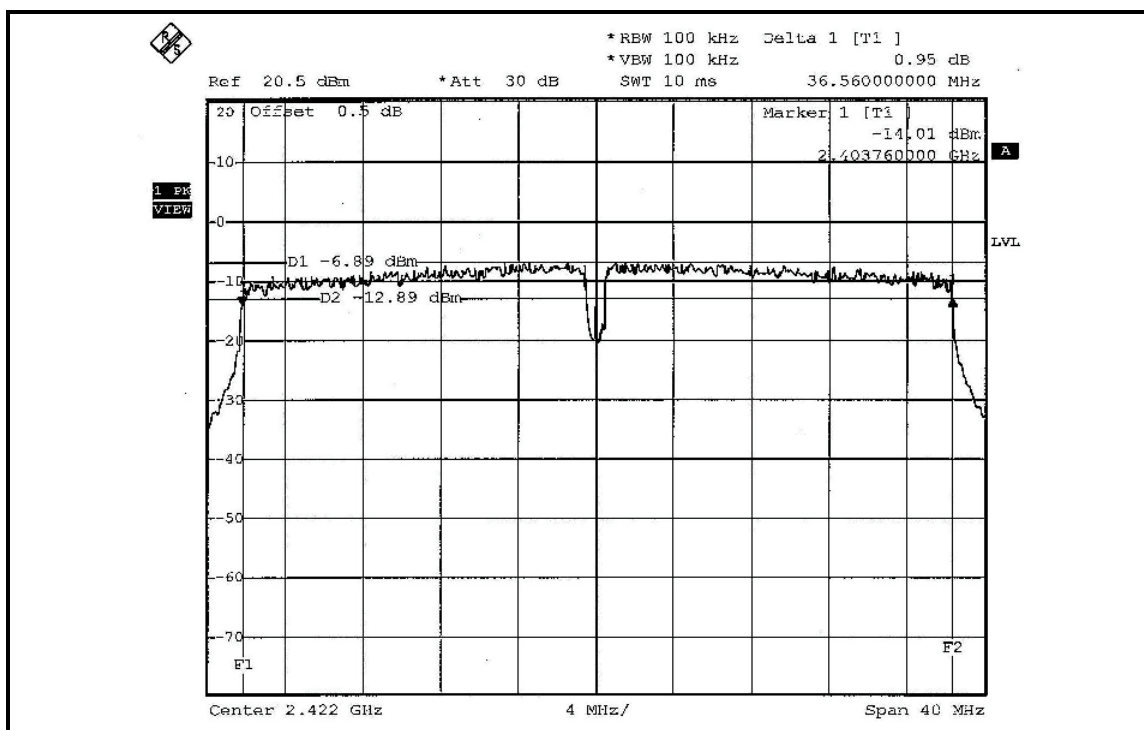

CH 4

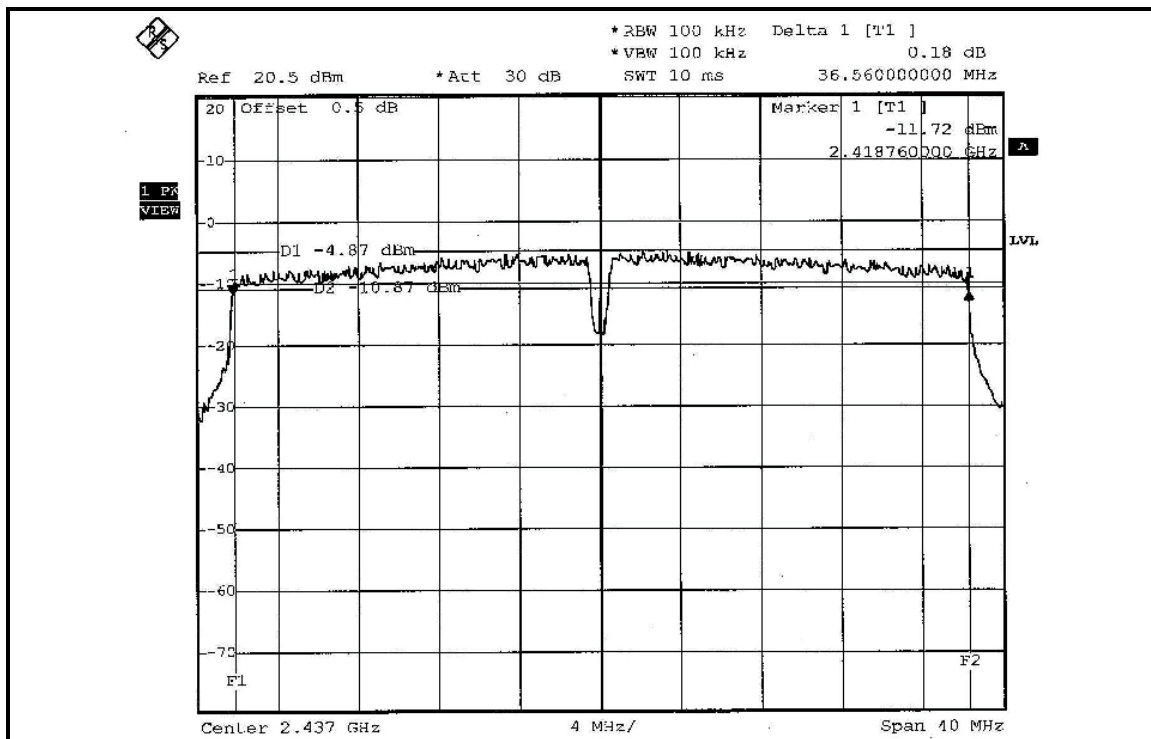

CH 7

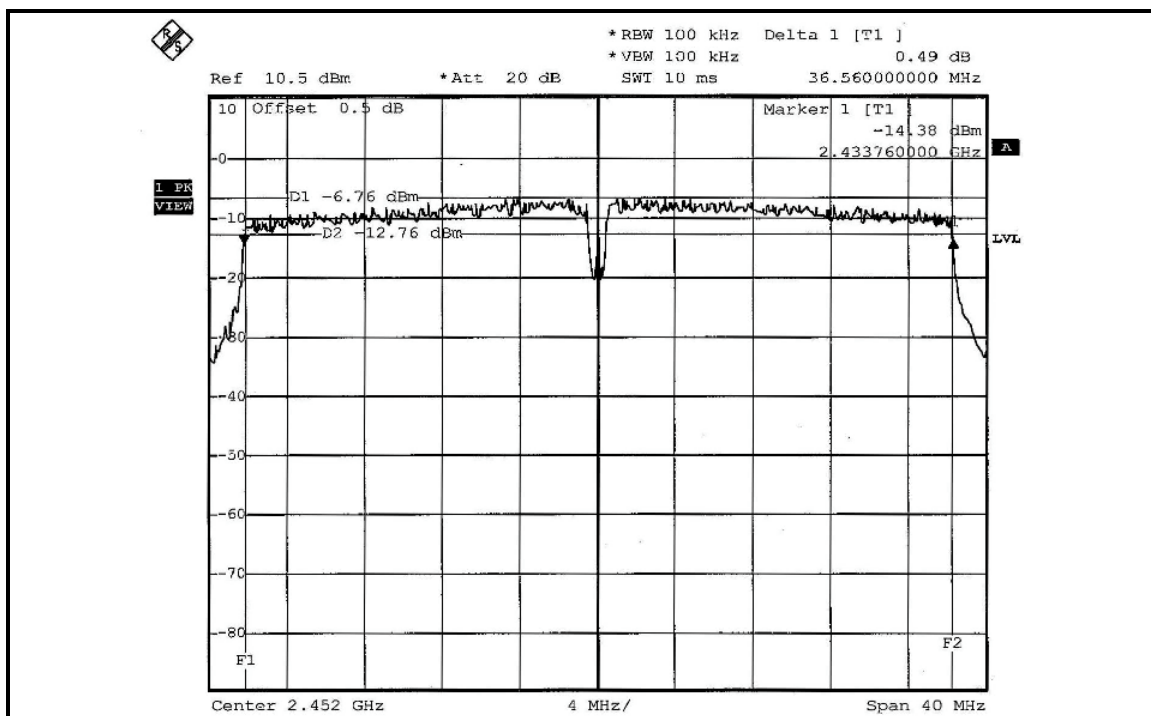

FOR CHAIN 1: CH 1

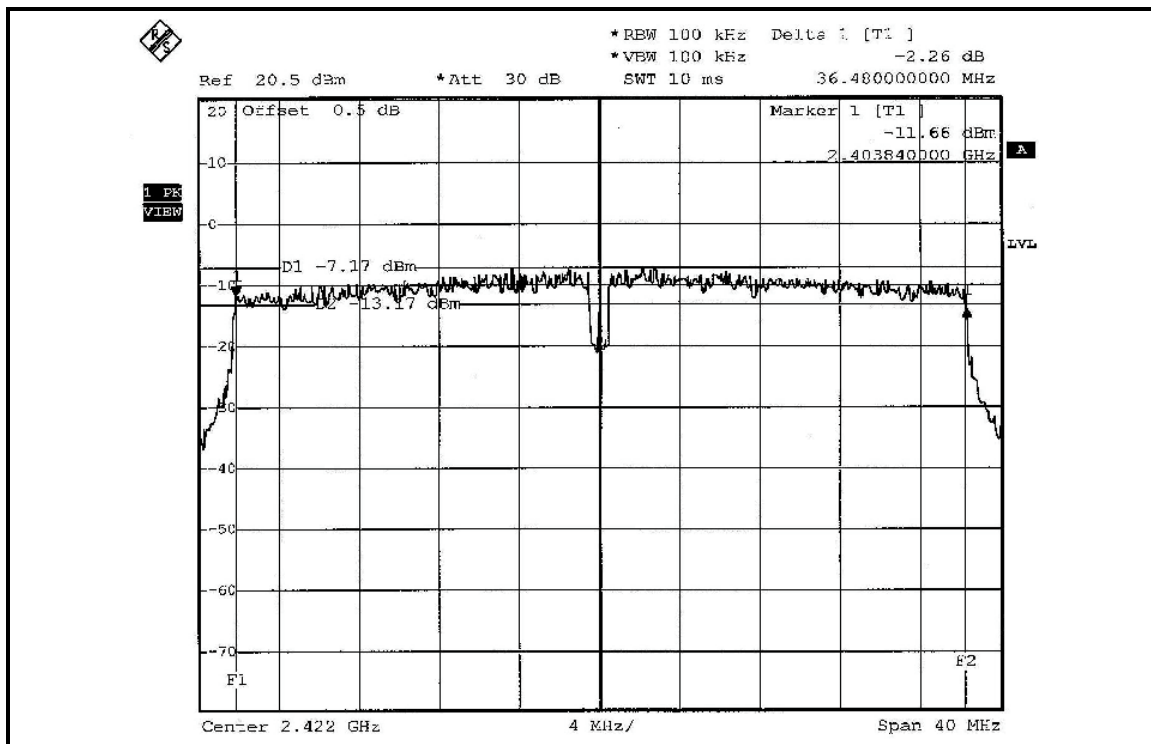

CH 4

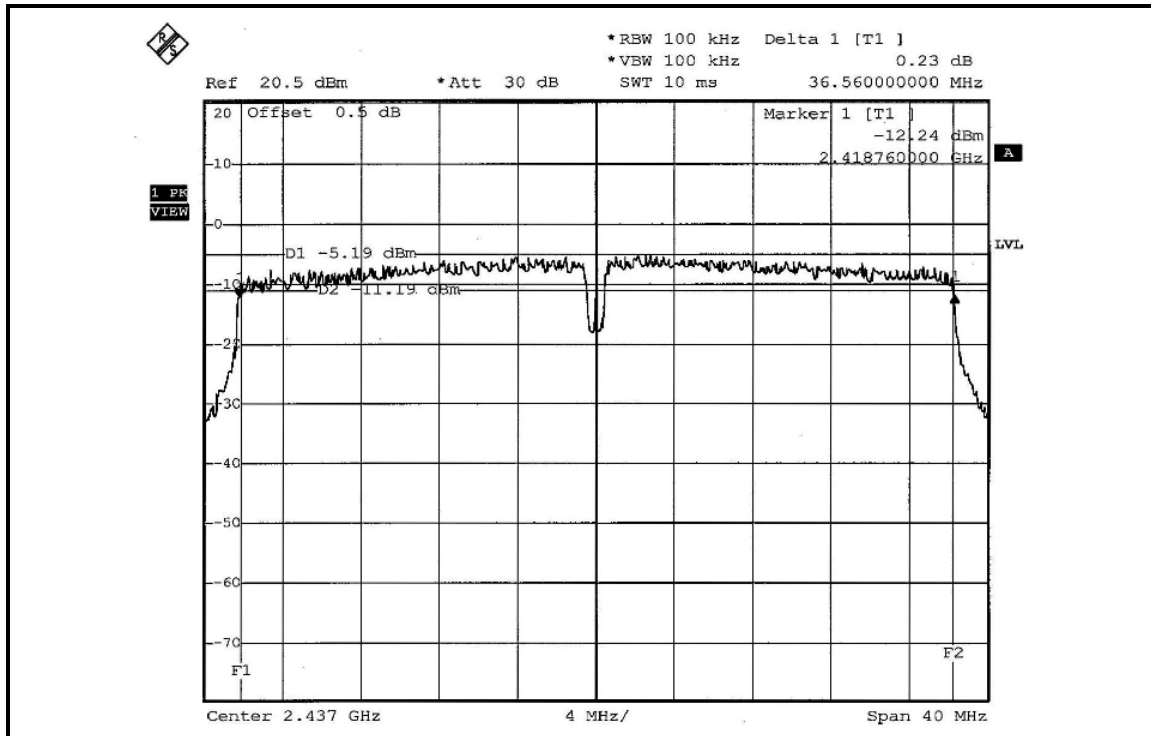

CH 7

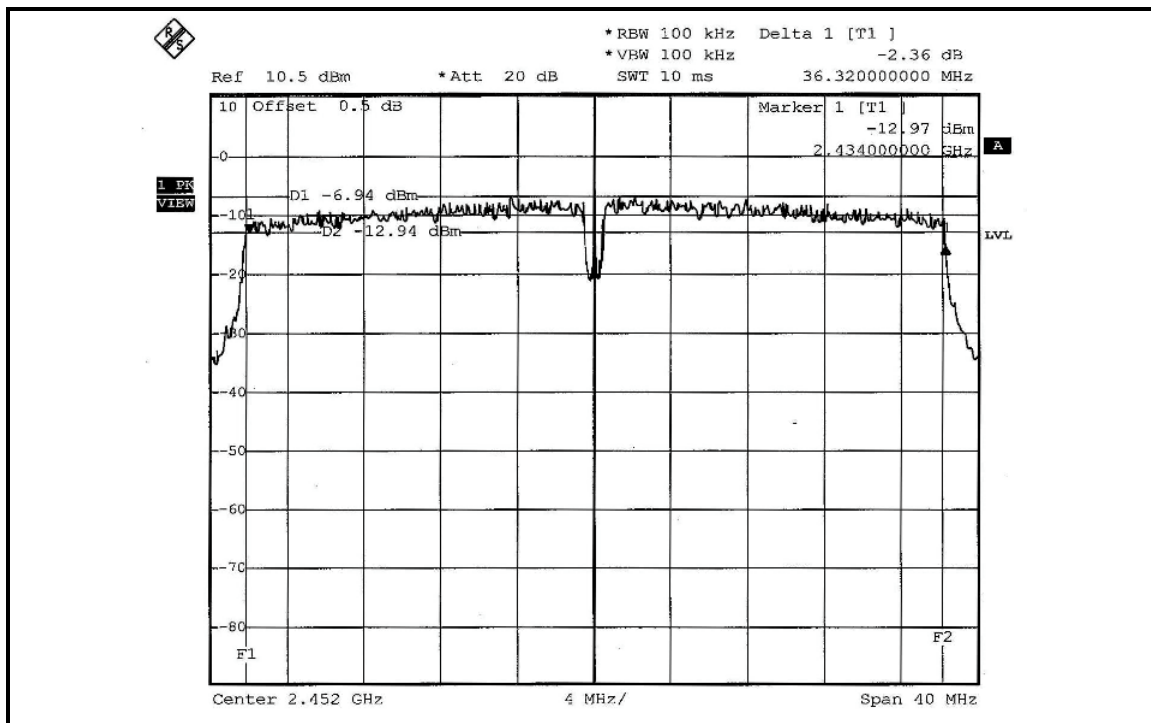



**802.11b (CB mode) OFDM MODULATION: DUAL TX:**

<b>MODULATION TYPE</b>	DBPSK	<b>TRANSFER RATE</b>	1Mbps
<b>INPUT POWER (SYSTEM)</b>	120Vac, 60 Hz	<b>ENVIRONMENTAL CONDITIONS</b>	22deg.C, 64%RH, 991hPa
<b>TESTED BY</b>	Brad Wu		

CHANNEL	CHANNEL FREQUENCY (MHz)	6dB BANDWIDTH (MHz)		MINIMUM LIMIT (MHz)	PASS / FAIL
		CHAIN 0	CHAIN 1		
1	2422	9.76	9.76	0.5	PASS
4	2437	9.76	9.60	0.5	PASS
7	2452	9.76	9.76	0.5	PASS

**FOR CHAIN 0: CH 1**

