



**DAVISCOMMS**  
*Bringing Great Products to Life ...*

## **DAVISCOMMS 433 MHz Antenna**

30 Nov 2022

**DAVISCOMMS 433 MHz Antenna**

Antenna Brand: DAVISCOMMS

Model: 433 MHz Antenna

Antenna Type: PCB Antenna

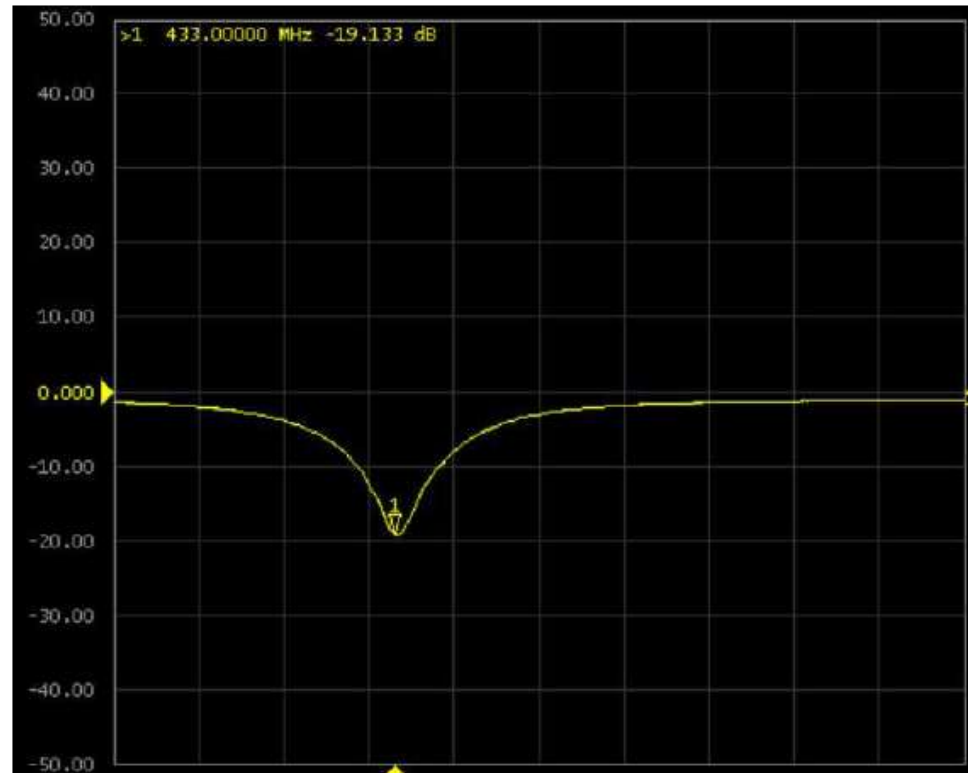
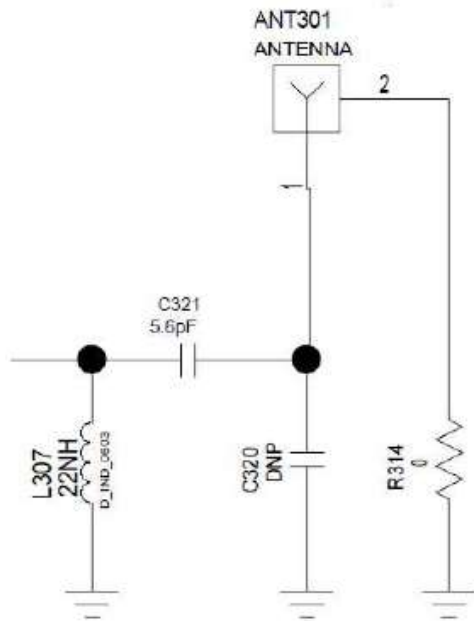

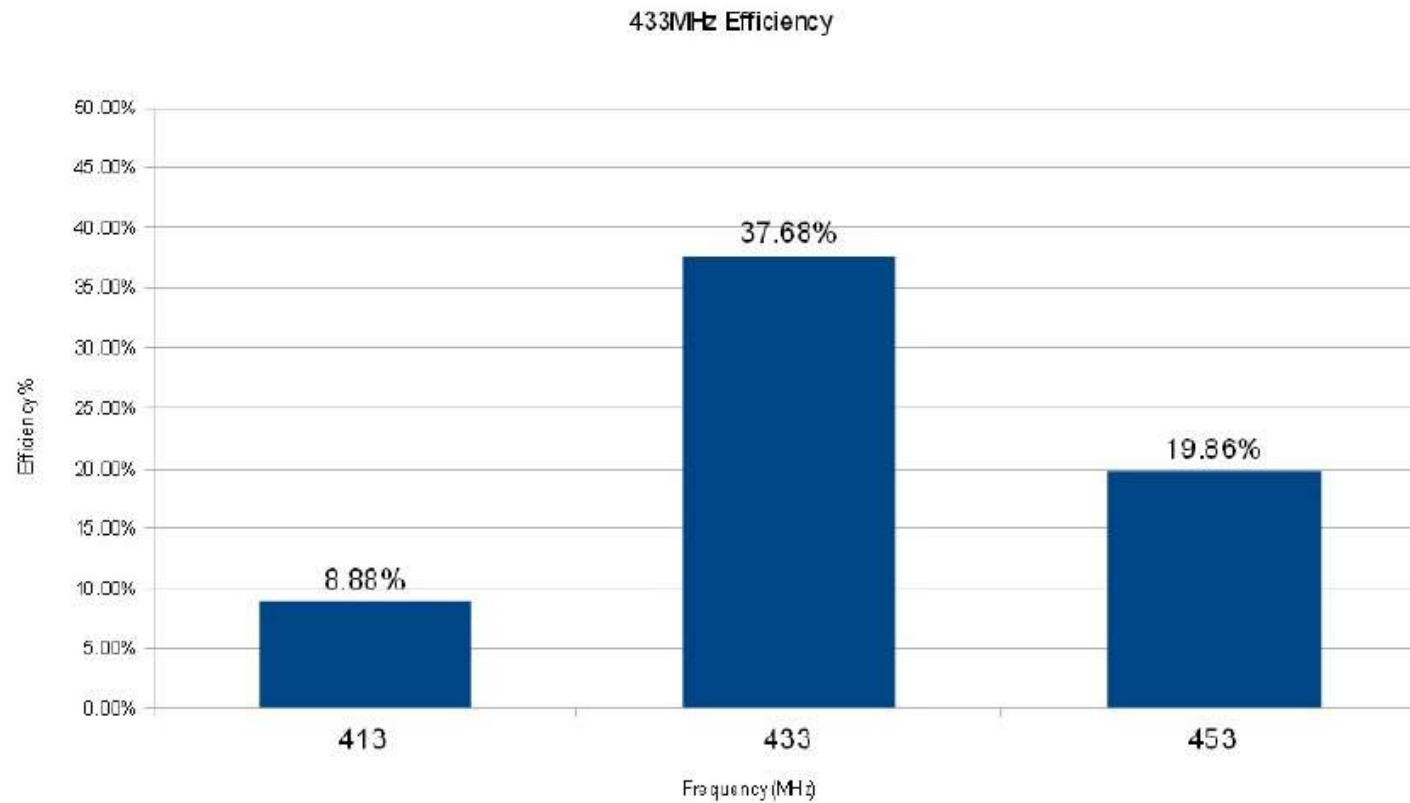

Antenna max gain: -1.94dBi

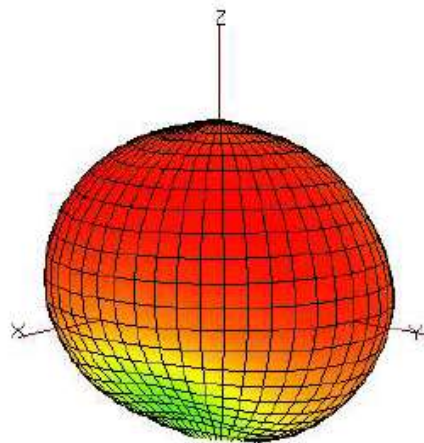
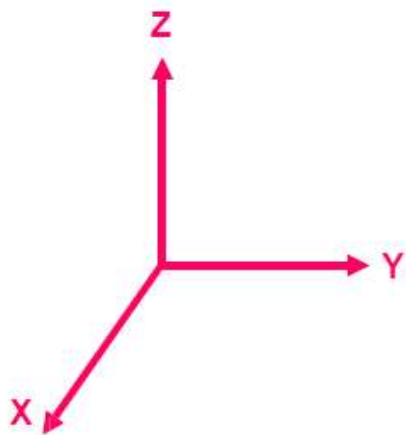

Passive Test E-Total (X-Z Plane)

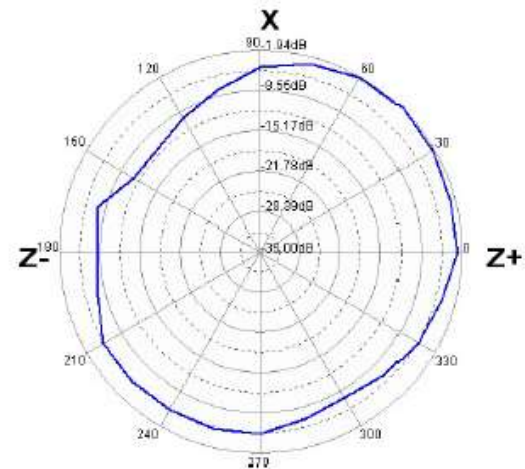

Passive Test E-Total (Y-Z Plane)

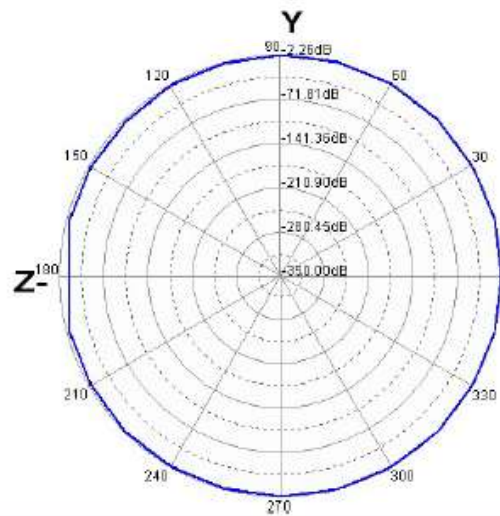

Passive Test E-Total (X-Y Plane)

