



FCC TEST REPORT

REPORT NO.: RF960524L14A
MODEL NO.: AP-1062 (refer to item 3.1 for more detail)
RECEIVED: May 24, 2007
TESTED: Sep. 02 ~ Sep. 30, 2007
ISSUED: Apr. 30, 2008

APPLICANT : RFNet Technologies Pte Ltd.

ADDRESS : 801 Lorong 7 Toa Payoh #05-02 Wearnes
Technology Building Singapore 319319

ISSUED BY : Advance Data Technology Corporation

LAB ADDRESS : No. 47, 14th Ling, Chia Pau Tsuen, Lin Kou Hsiang
244, Taipei Hsien, Taiwan, R.O.C.

TEST LOCATION : No. 19, Hwa Ya 2nd Rd., Wen Hwa Tsuen, Kwei
Shan Hsiang, Taoyuan Hsien 333, Taiwan, R.O.C.

This test report consists of 77 pages in total. It may be duplicated completely for legal use with the approval of the applicant. It should not be reproduced except in full, without the written approval of our laboratory. The client should not use it to claim product endorsement by TAF, A2LA or any government agencies. The test results in the report only apply to the tested sample.





Table of Contents

1	CERTIFICATION.....	4
2	SUMMARY OF TEST RESULTS	5
2.1	MEASUREMENT UNCERTAINTY	5
3	GENERAL INFORMATION.....	6
3.1	GENERAL DESCRIPTION OF EUT.....	6
3.2	DESCRIPTION OF TEST MODES.....	7
3.2.1	CONFIGURATION OF SYSTEM UNDER TEST.....	7
3.2.2	TEST MODE APPLICABILITY AND TESTED CHANNEL DETAIL.....	8
3.3	GENERAL DESCRIPTION OF APPLIED STANDARDS	10
3.4	DESCRIPTION OF SUPPORT UNITS.....	10
4	TEST TYPES AND RESULTS	11
4.1	RADIATED EMISSION MEASUREMENT	11
4.1.1	LIMITS OF RADIATED EMISSION MEASUREMENT.....	11
4.1.2	TEST INSTRUMENTS	12
4.1.3	TEST PROCEDURES	13
4.1.4	DEVIATION FROM TEST STANDARD	13
4.1.5	TEST SETUP	14
4.1.6	EUT OPERATING CONDITIONS	14
4.1.7	TEST RESULTS	15
4.2	CONDUCTED EMISSION MEASUREMENT	31
4.2.1	LIMITS OF CONDUCTED EMISSION MEASUREMENT.....	31
4.2.2	TEST INSTRUMENTS	31
4.2.3	TEST PROCEDURES	32
4.2.4	DEVIATION FROM TEST STANDARD	32
4.2.5	TEST SETUP	33
4.2.6	EUT OPERATING CONDITIONS	33
4.2.7	TEST RESULTS	34
4.3	6dB BANDWIDTH MEASUREMENT	42
4.3.1	LIMITS OF 6dB BANDWIDTH MEASUREMENT	42
4.3.2	TEST INSTRUMENTS	42
4.3.3	TEST PROCEDURE	42
4.3.4	DEVIATION FROM TEST STANDARD	42
4.3.5	TEST SETUP	43
4.3.6	EUT OPERATING CONDITIONS	43
4.3.7	TEST RESULTS	44
4.4	MAXIMUM PEAK OUTPUT POWER	49
4.4.1	LIMITS OF MAXIMUM PEAK OUTPUT POWER MEASUREMENT.....	49
4.4.2	TEST INSTRUMENTS	49
4.4.3	TEST PROCEDURES	50
4.4.4	DEVIATION FROM TEST STANDARD	50
4.4.5	TEST SETUP	50
4.4.6	EUT OPERATING CONDITIONS	50
4.4.7	TEST RESULTS	51
4.5	POWER SPECTRAL DENSITY MEASUREMENT	52
4.5.1	LIMITS OF POWER SPECTRAL DENSITY MEASUREMENT	52
4.5.2	TEST INSTRUMENTS	52
4.5.3	TEST PROCEDURE	52
4.5.4	DEVIATION FROM TEST STANDARD	52



4.5.5	TEST SETUP	52
4.5.6	EUT OPERATING CONDITIONS	52
4.5.7	TEST RESULTS	53
4.6	BAND EDGES MEASUREMENT	58
4.6.1	LIMITS OF BAND EDGES MEASUREMENT	58
4.6.2	TEST INSTRUMENTS	58
4.6.3	TEST PROCEDURE	58
4.6.4	DEVIATION FROM TEST STANDARD	58
4.6.5	EUT OPERATING CONDITION	58
4.6.6	TEST RESULTS	59
4.7	ANTENNA REQUIREMENT	74
4.7.1	STANDARD APPLICABLE	74
4.7.2	ANTENNA CONNECTED CONSTRUCTION	74
5	PHOTOGRAPHS OF THE TEST CONFIGURATION	75
6	INFORMATION ON THE TESTING LABORATORIES	76
7	APPENDIX A – MODIFICATIONS RECORDERS FOR ENGINEERING CHANGES TO THE EUT BY THE LAB	77



1 CERTIFICATION

PRODUCT: IEEE802.11b/g Extended range Outdoor AP
(refer to item 3.1 for more detail)

MODEL NO.: AP-1062 (refer to item 3.1 for more detail)

BRAND: RFNet (refer to item 3.1 for more detail)

APPLICANT: RFNet Technologies Pte Ltd.

TESTED: Sep. 02 ~ Sep. 30, 2007

TEST SAMPLE: ENGINEERING SAMPLE

STANDARDS: **FCC Part 15, Subpart C (Section 15.247)**
ANSI C63.4-2003

The above equipment (model: AP-1062) has been tested by **Advance Data Technology Corporation**, and found compliance with the requirement of the above standards. The test record, data evaluation & Equipment Under Test (EUT) configurations represented herein are true and accurate accounts of the measurements of the sample's EMC characteristics under the conditions specified in this report

PREPARED BY : Andrea Hsia , **DATE:** Apr. 30, 2008
Andrea Hsia / Specialist

TECHNICAL ACCEPTANCE : Long Chen , **DATE:** Apr. 30, 2008
Responsible for RF Long Chen / Senior Engineer

APPROVED BY : Gary Chang , **DATE:** Apr. 30, 2008
Gary Chang / Assistant Manager

2 SUMMARY OF TEST RESULTS

The EUT has been tested according to the following specifications:

APPLIED STANDARD: FCC Part 15, Subpart C			
Standard Section	Test Type and Limit	Result	Remark
15.207	AC Power Conducted Emission	PASS	Meet the requirement of limit. Minimum passing margin is -0.35dB at 0.468MHz
15.247(a)(2)	Spectrum Bandwidth of a Direct Sequence Spread Spectrum System Limit: min. 500kHz	PASS	Meet the requirement of limit.
15.247(b)	Maximum Peak Output Power Limit: max. 30dBm	PASS	Meet the requirement of limit.
15.247(d)	Radiated Emissions Limit: Table 15.209	PASS	Meet the requirement of limit. Minimum passing margin is -1.06dB at 2390.00MHz
15.247(e)	Power Spectral Density Limit: max. 8dBm	PASS	Meet the requirement of limit.
15.247(d)	Band Edge Measurement Limit: 20dB less than the peak value of fundamental frequency	PASS	Meet the requirement of limit.

2.1 MEASUREMENT UNCERTAINTY

Where relevant, the following measurement uncertainty levels have been estimated for tests performed on the EUT as specified in CISPR 16-4-2:

MEASUREMENT	FREQUENCY	UNCERTAINTY
Conducted emissions	9kHz~30MHz	2.44 dB
Radiated emissions	30MHz ~ 200MHz	3.19 dB
	200MHz ~1000MHz	3.21 dB
	1GHz ~ 18GHz	2.26 dB
	18GHz ~ 40GHz	1.94 dB

This uncertainty represents an expanded uncertainty expressed at approximately the 95% confidence level using a coverage factor of k=2.



3 GENERAL INFORMATION

3.1 GENERAL DESCRIPTION OF EUT

PRODUCT	IEEE802.11b/g Extended range Outdoor AP (refer to note as below)
MODEL NO.	AP-1062 (refer to note as below)
FCC ID	PXPAP1062
POWER SUPPLY	48Vdc from POE
MODULATION TYPE	CCK, DQPSK, DBPSK for DSSS 64QAM, 16QAM, QPSK, BPSK for OFDM
MODULATION TECHNOLOGY	DSSS, OFDM
TRANSFER RATE	802.11b: 11/5.5/2/1Mbps 802.11g: 54/48/36/24/18/12/9/6Mbps (up to 108Mbps for turbo mode)
FREQUENCY RANGE	2412MHz ~ 2462MHz
NUMBER OF CHANNEL	11
MAXIMUM OUTPUT POWER	35.645mW
ANTENNA TYPE	Panel antenna with 9.0dBi gain (Internal Antenna) Omni-directional antenna with 4.5dBi gain (external antenna)
DATA CABLE	3m or 10m shielded RJ45 cable without core 0.7m non-shielded grounding cable without core
I/O PORTS	Refer to User's Manual
ACCESSORY DEVICES	NA

NOTE:

1. This is a duplicate report of ADT report no.: RF960524L14. The differences compared with the original design are changing the FCC ID, model name, brand, product name, OEM brand, OEM model name, OEM product name and applicant.
2. The EUT was powered by the following POE:

BRAND:	RFNet
MODEL:	PUTP-130A-01
INPUT:	100-250Vac, 0.5A, 50-60Hz
OUTPUT:	48Vdc, 0.4A
POWER LINE:	AC 1.8m non-shielded cable without core

* The POE is for support unit only.

3. The details of model no. listed as below:

BRAND	MODEL	PRODUCT NAME	REMARK
RFNet	AP-1062	IEEE802.11b/g Extended range Outdoor AP	Main Model
IC Intracom Inc.	503679	WIRELESS OUTDOOR POE ACCESS POINT AND BRIDGE	OEM Model

4. For the RJ45 cable, client could choose one of them for accessory.

5. The EUT complies with IEEE 802.11g standards and backwards compatible with IEEE 802.11b products.
6. The EUT operates in the 2.4GHz frequency spectrum with throughput of up to 108Mbps.
7. The above EUT information was declared by manufacturer and for more detailed features description, please refer to the manufacturer's specifications or User's Manual.

3.2 DESCRIPTION OF TEST MODES

Eleven channels are provided to this EUT.

CHANNEL	FREQUENCY	CHANNEL	FREQUENCY
1	2412 MHz	7	2442 MHz
2	2417 MHz	8	2447 MHz
3	2422 MHz	9	2452 MHz
4	2427 MHz	10	2457 MHz
5	2432 MHz	11	2462 MHz
6	2437 MHz		

For 802.11g: One channel is provided to this EUT for turbo mode.

CHANNEL	FREQUENCY
6	2437 MHz

3.2.1 CONFIGURATION OF SYSTEM UNDER TEST

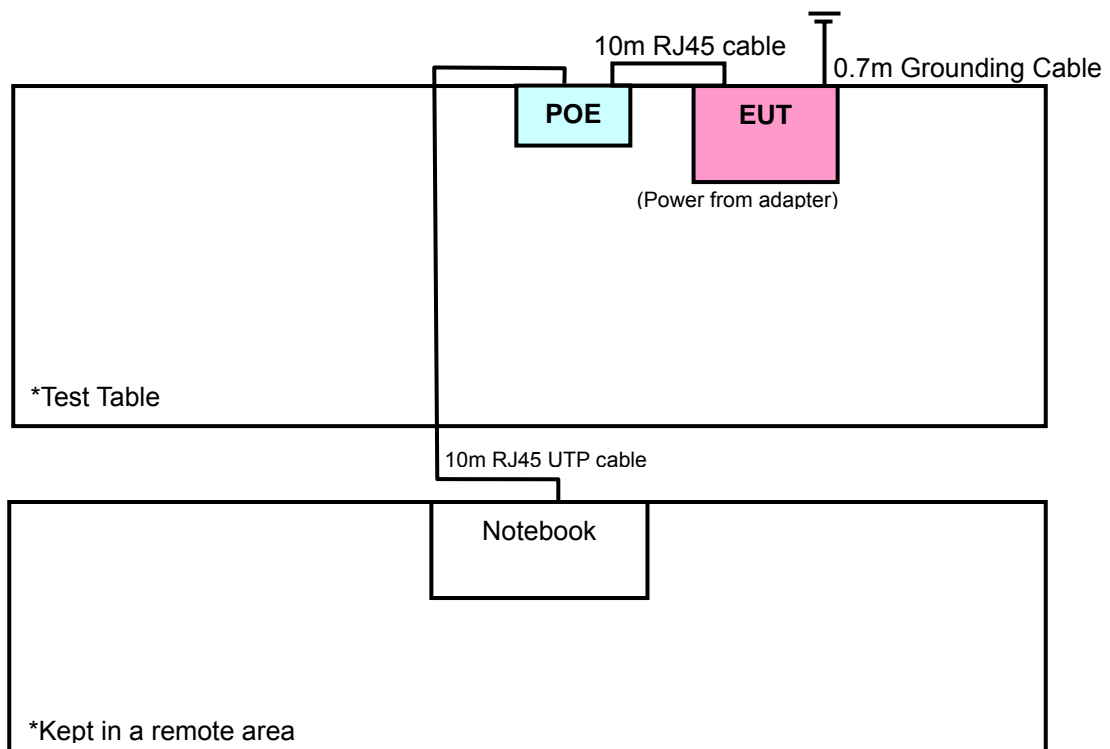

3.2.2 TEST MODE APPLICABILITY AND TESTED CHANNEL DETAIL

EUT CONFIGURE MODE	APPLICABLE TO				DESCRIPTION
	RE \geq 1G	RE $<$ 1G	PLC	APCM	
A	√	√	√	√	Internal Antenna
B	√	√	-	-	External Antenna

Where **RE \geq 1G**: Radiated Emission above 1GHz

RE $<$ 1G: Radiated Emission below 1GHz

PLC: Power Line Conducted Emission

APCM: Antenna Port Conducted Measurement

NOTE: "-" means no effect.

RADIATED EMISSION TEST (BELOW 1 GHz):

- Pre-Scan has been conducted to determine the worst-case mode from all possible combinations between available modulations, data rates, XYZ axis, antenna ports (if EUT with antenna diversity architecture) and packet type.
- Following channel(s) was (were) selected for the final test as listed below.

EUT CONFIGURE MODE	MODE	AVAILABLE CHANNEL	TESTED CHANNEL	MODULATION TECHNOLOGY	MODULATION TYPE	AXIS	DATA RATE (Mbps)
A	802.11g	1 to 11	11	OFDM	BPSK	Z	6
B	802.11g	1 to 11	11	OFDM	BPSK	Y	6

RADIATED EMISSION TEST (ABOVE 1 GHz):

- Pre-Scan has been conducted to determine the worst-case mode from all possible combinations between available modulations, data rates, XYZ axis, antenna ports (if EUT with antenna diversity architecture) and packet type.
- Following channel(s) was (were) selected for the final test as listed below.

EUT CONFIGURE MODE	MODE	AVAILABLE CHANNEL	TESTED CHANNEL	MODULATION TECHNOLOGY	MODULATION TYPE	AXIS	DATA RATE (Mbps)
A	802.11b	1 to 11	1, 6, 11	DSSS	DBPSK	Z	1
B	802.11b	1 to 11	1, 6, 11	DSSS	DBPSK	Y	1
A	802.11g	1 to 11	1, 6, 11	OFDM	BPSK	Z	6
B	802.11g	1 to 11	1, 6, 11	OFDM	BPSK	Y	6
A	802.11g Turbo	6	6	OFDM	QPSK	Z	12
B	802.11g Turbo	6	6	OFDM	QPSK	Y	12

POWER LINE CONDUCTED EMISSION TEST:

- Pre-Scan has been conducted to determine the worst-case mode from all possible combinations between available modulations, data rates and antenna ports (if EUT with antenna diversity architecture).
- Following channel(s) was (were) selected for the final test as listed below.

EUT CONFIGURE MODE	MODE	AVAILABLE CHANNEL	TESTED CHANNEL	MODULATION TECHNOLOGY	MODULATION TYPE	DATA RATE (Mbps)
A	802.11g	1 to 11	1, 6, 11	OFDM	BPSK	6
A	802.11g Turbo	6	6	OFDM	QPSK	12

BANDEDGE MEASUREMENT:

- Pre-Scan has been conducted to determine the worst-case mode from all possible combinations between available modulations, data rates and antenna ports (if EUT with antenna diversity architecture).
- Following channel(s) was (were) selected for the final test as listed below.

EUT CONFIGURE MODE	MODE	AVAILABLE CHANNEL	TESTED CHANNEL	MODULATION TECHNOLOGY	MODULATION TYPE	DATA RATE (Mbps)
A	802.11b	1 to 11	1, 11	DSSS	DBPSK	1
A	802.11g	1 to 11	1, 11	OFDM	BPSK	6
A	802.11g Turbo	6	6	OFDM	QPSK	12

ANTENNA PORT CONDUCTED MEASUREMENT:

- Pre-Scan has been conducted to determine the worst-case mode from all possible combinations between available modulations, data rates and antenna ports (if EUT with antenna diversity architecture).
- Following channel(s) was (were) selected for the final test as listed below.

EUT CONFIGURE MODE	MODE	AVAILABLE CHANNEL	TESTED CHANNEL	MODULATION TECHNOLOGY	MODULATION TYPE	DATA RATE (Mbps)
A	802.11b	1 to 11	1, 6, 11	DSSS	DBPSK	1
A	802.11g	1 to 11	1, 6, 11	OFDM	BPSK	6
A	802.11g Turbo	6	6	OFDM	QPSK	12



3.3 GENERAL DESCRIPTION OF APPLIED STANDARDS

The EUT is a RF product. According to the specifications of the manufacturer, it must comply with the requirements of the following standards:

FCC Part 15, Subpart C. (15.247)

ANSI C63.4- 2003

All test items have been performed and recorded as per the above standards.

NOTE: The EUT is also considered as a kind of computer peripheral, because the connection to computer is necessary for typical use. It has been verified to comply with the requirements of FCC Part 15, Subpart B, Class B (DoC). The test report has been issued separately.

3.4 DESCRIPTION OF SUPPORT UNITS

The EUT has been tested as an independent unit together with other necessary accessories or support units. The following support units or accessories were used to form a representative test configuration during the tests.

NO.	PRODUCT	BRAND	MODEL NO.	SERIAL NO.	FCC ID
1	NOTEBOOK COMPUTER	DELL	PP05L	16484462992	E2K24CLNS
2	POE	RFNet	PUTP-130A-01	NA	NA

NO.	SIGNAL CABLE DESCRIPTION OF THE ABOVE SUPPORT UNITS
1	10m UTP RJ 45 cable
2	1.8m non-shielded cable

NOTE 1: All power cords of the above support units are non shielded (1.8m).

NOTE 2: Item 2 was supplied from client.

NOTE 3: Item 1 acted as a communication partner to transfer data.

4 TEST TYPES AND RESULTS

4.1 RADIATED EMISSION MEASUREMENT

4.1.1 LIMITS OF RADIATED EMISSION MEASUREMENT

Emissions radiated outside of the specified bands, shall be according to the general radiated limits in 15.209 as following:

Frequencies (MHz)	Field strength (microvolts/meter)	Measurement distance (meters)
0.009-0.490	2400/F(kHz)	300
0.490-1.705	24000/F(kHz)	30
1.705-30.0	30	30
30-88	100	3
88-216	150	3
216-960	200	3
Above 960	500	3

NOTE:

1. The lower limit shall apply at the transition frequencies.
2. Emission level (dBuV/m) = 20 log Emission level (uV/m).
3. As shown in 15.35(b), for frequencies above 1000MHz, the field strength limits are based on average detector, however, the peak field strength of any emission shall not exceed the maximum permitted average limits, specified above by more than 20dB under any condition of modulation.



4.1.2 TEST INSTRUMENTS

DESCRIPTION & MANUFACTURER	MODEL NO.	SERIAL NO.	CALIBRATED UNTIL
Test Receiver ROHDE & SCHWARZ	ESI7	838496/016	Dec. 29, 2007
Spectrum Analyzer ROHDE & SCHWARZ	FSP40	100039	Dec. 01, 2007
BILOG Antenna SCHWARZBECK	VULB9168	9168-155	Jan. 04, 2008
HORN Antenna SCHWARZBECK	BBHA 9120D	9120D-405	Dec. 18, 2007
HORN Antenna SCHWARZBECK	BBHA 9170	BBHA9170242	Jan. 16, 2008
Preamplifier Agilent	8449B	3008A1960	Oct. 30, 2007
Preamplifier Agilent	8447D	2944A10631	Oct. 30, 2007
RF signal cable HUBER+SUHNNER	SUCOFLEX 104	230128/4	Nov. 14, 2007
RF signal cable HUBER+SUHNNER	SUCOFLEX 104	233233/4	Nov. 14, 2007
Software ADT.	ADT_Radiated_V7.6	NA	NA
Antenna Tower inn-co GmbH	MA 4000	010303	NA
Antenna Tower Controller inn-co GmbH	CO2000	019303	NA
Turn Table ADT.	TT100.	TT93021704	NA
Turn Table Controller ADT.	SC100.	SC93021704	NA

- NOTE:**
1. The calibration interval of the above test instruments is 12 months and the calibrations are traceable to NML/ROC and NIST/USA.
 2. The test was performed in HwaYa Chamber 4.
 3. The horn antenna and HP preamplifier (model: 8449B) are used only for the measurement of emission frequency above 1GHz if tested.
 4. The IC Site Registration No. is IC3789B-4.

4.1.3 TEST PROCEDURES

- a. The EUT was placed on the top of a rotating table 0.8 meters above the ground at a 3 meters semi-anechoic chamber. The table was rotated 360 degrees to determine the position of the highest radiation.
- b. The EUT was set 3 meters away from the interference-receiving antenna, which was mounted on the top of a variable-height antenna tower.
- c. The antenna is a broadband antenna, and its height is varied from one meter to four meters above the ground to determine the maximum value of the field strength. Both horizontal and vertical polarizations of the antenna are set to make the measurement.
- d. For each suspected emission, the EUT was arranged to its worst case and then the antenna was tuned to heights from 1 meter to 4 meters and the rotatable table was turned from 0 degrees to 360 degrees to find the maximum reading.
- e. The test-receiver system was set to Peak Detect Function and Specified Bandwidth with Maximum Hold Mode.
- f. If the emission level of the EUT in peak mode was lower than the limit specified, then testing could be stopped and the peak values of the EUT would be reported. Otherwise the emissions would be re-tested one by one using peak, quasi-peak method or average method as specified and then reported in data sheet.

NOTE:

1. The resolution bandwidth and video bandwidth of test receiver/spectrum analyzer is 120kHz for Peak detection (PK) and Quasi-peak detection (QP) at frequency below 1GHz.
2. The resolution bandwidth of test receiver/spectrum analyzer is 1 MHz and video bandwidth is 3MHz for Peak detection at frequency above 1GHz.
3. The resolution bandwidth of test receiver/spectrum analyzer is 1 MHz and the video bandwidth is 10 Hz for Average detection (AV) at frequency above 1GHz.
4. All modes of operation were investigated and the worst-case emissions are reported.

4.1.4 DEVIATION FROM TEST STANDARD

No deviation.

4.1.5 TEST SETUP

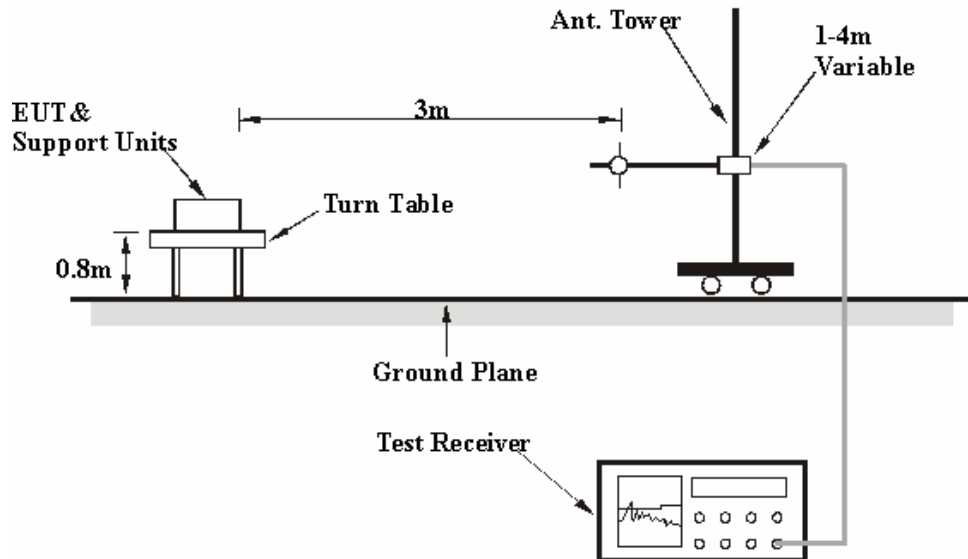

For the actual test configuration, please refer to the attached file (Test Setup Photo).

4.1.6 EUT OPERATING CONDITIONS

- a. Placed the EUT on the testing table.
- b. Prepared another Notebook system to act as a communication partner and placed it outside of testing area.
- c. The communication partner run a test program (provided by manufacturer) to enable EUT under transmission condition continuously at specific channel frequency via an RJ45 cable.

4.1.7 TEST RESULTS

802.11b DSSS MODULATION

EUT TEST CONDITION		MEASUREMENT DETAIL	
CHANNEL	Channel 1	FREQUENCY RANGE	1 ~ 25GHz
MODULATION TYPE	DBPSK	DETECTOR FUNCTION	Peak(PK) Average (AV)
TRANSFER RATE	1Mbps	ENVIRONMENTAL CONDITIONS	24deg. C, 71%RH, 1006hPa
INPUT POWER (SYSTEM)	120Vac, 60 Hz	TEST MODE	A
TESTED BY	Dean Wang		

ANTENNA POLARITY & TEST DISTANCE: HORIZONTAL AT 3 M								
No.	Freq. (MHz)	Emission Level (dBuV/m)	Limit (dBuV/m)	Margin (dB)	Antenna Height (m)	Table Angle (Degree)	Raw Value (dBuV)	Correction Factor (dB/m)
1	2390.00	56.68 PK	74.00	-17.32	1.28 H	315	24.36	32.32
2	2390.00	46.52 AV	54.00	-7.48	1.28 H	315	14.20	32.32
3	*2412.00	95.78 PK			1.29 H	314	63.46	32.32
4	*2412.00	91.09 AV			1.29 H	314	58.77	32.32
5	2688.00	59.15 PK	75.78	-16.63	1.00 H	2	26.32	32.83
6	2688.00	47.58 AV	71.09	-23.51	1.00 H	2	14.75	32.83
7	4824.00	46.26 PK	74.00	-27.74	1.10 H	18	8.26	38.00
8	4824.00	35.68 AV	54.00	-18.32	1.10 H	18	-2.32	38.00

ANTENNA POLARITY & TEST DISTANCE: VERTICAL AT 3 M								
No.	Freq. (MHz)	Emission Level (dBuV/m)	Limit (dBuV/m)	Margin (dB)	Antenna Height (m)	Table Angle (Degree)	Raw Value (dBuV)	Correction Factor (dB/m)
1	2390.00	63.53 PK	74.00	-10.47	1.05 V	353	31.21	32.32
2	2390.00	52.92 AV	54.00	-1.08	1.05 V	353	20.60	32.32
3	*2412.00	111.82 PK			1.04 V	353	79.50	32.32
4	*2412.00	107.18 AV			1.04 V	353	74.86	32.32
5	2688.00	62.49 PK	91.82	-29.33	1.16 V	354	29.66	32.83
6	2688.00	56.48 AV	87.18	-30.70	1.16 V	354	23.65	32.83
7	4824.00	48.05 PK	74.00	-25.95	1.11 V	346	10.05	38.00
8	4824.00	37.28 AV	54.00	-16.72	1.11 V	346	-0.72	38.00

- REMARKS:**
1. Emission level(dBuV/m)=Raw Value(dBuV) + Correction Factor(dB/m)
 2. Correction Factor(dB/m) = Antenna Factor (dB/m) + Cable Factor (dB)
 3. The other emission levels were very low against the limit.
 4. Margin value = Emission level – Limit value.
 5. “ * “ : Fundamental frequency.

EUT TEST CONDITION		MEASUREMENT DETAIL	
CHANNEL	Channel 6	FREQUENCY RANGE	1 ~ 25GHz
MODULATION TYPE	DBPSK	DETECTOR FUNCTION	Peak(PK) Average (AV)
TRANSFER RATE	1Mbps	ENVIRONMENTAL CONDITIONS	24deg. C, 71%RH, 1006hPa
INPUT POWER (SYSTEM)	120Vac, 60 Hz	TEST MODE	A
TESTED BY	Dean Wang		

ANTENNA POLARITY & TEST DISTANCE: HORIZONTAL AT 3 M								
No.	Freq. (MHz)	Emission Level (dBuV/m)	Limit (dBuV/m)	Margin (dB)	Antenna Height (m)	Table Angle (Degree)	Raw Value (dBuV)	Correction Factor (dB/m)
1	2390.00	56.48 PK	74.00	-17.52	1.21 H	218	24.16	32.32
2	2390.00	46.34 AV	54.00	-7.66	1.21 H	218	14.02	32.32
3	*2437.00	99.32 PK			1.21 H	217	66.98	32.34
4	*2437.00	95.17 AV			1.21 H	217	62.83	32.34
5	2688.00	59.26 PK	79.32	-20.06	1.00 H	118	26.43	32.83
6	2688.00	47.62 AV	75.17	-27.55	1.00 H	118	14.79	32.83
7	4874.00	48.26 PK	74.00	-25.74	1.00 H	165	10.14	38.12
8	4874.00	39.07 AV	54.00	-14.93	1.00 H	165	0.95	38.12

ANTENNA POLARITY & TEST DISTANCE: VERTICAL AT 3 M								
No.	Freq. (MHz)	Emission Level (dBuV/m)	Limit (dBuV/m)	Margin (dB)	Antenna Height (m)	Table Angle (Degree)	Raw Value (dBuV)	Correction Factor (dB/m)
1	2390.00	65.31 PK	74.00	-8.69	1.08 V	352	32.99	32.32
2	2390.00	52.37 AV	54.00	-1.63	1.08 V	352	20.05	32.32
3	*2437.00	115.13 PK			1.08 V	351	82.79	32.34
4	*2437.00	110.19 AV			1.08 V	351	77.85	32.34
5	2688.00	63.50 PK	95.13	-31.63	1.00 V	349	30.67	32.83
6	2688.00	58.71 AV	90.19	-31.48	1.00 V	349	25.88	32.83
7	4874.00	48.60 PK	74.00	-25.40	1.08 V	288	10.48	38.12
8	4874.00	39.56 AV	54.00	-14.44	1.08 V	288	1.44	38.12

- REMARKS:**
1. Emission level(dBuV/m)=Raw Value(dBuV) + Correction Factor(dB/m)
 2. Correction Factor(dB/m) = Antenna Factor (dB/m) + Cable Factor (dB)
 3. The other emission levels were very low against the limit.
 4. Margin value = Emission level – Limit value.
 5. “ * “ : Fundamental frequency.

EUT TEST CONDITION		MEASUREMENT DETAIL	
CHANNEL	Channel 11	FREQUENCY RANGE	1 ~ 25GHz
MODULATION TYPE	DBPSK	DETECTOR FUNCTION	Peak(PK) Average (AV)
TRANSFER RATE	1Mbps	ENVIRONMENTAL CONDITIONS	24deg. C, 71%RH, 1006hPa
INPUT POWER (SYSTEM)	120Vac, 60 Hz	TEST MODE	A
TESTED BY	Dean Wang		

ANTENNA POLARITY & TEST DISTANCE: HORIZONTAL AT 3 M								
No.	Freq. (MHz)	Emission Level (dBuV/m)	Limit (dBuV/m)	Margin (dB)	Antenna Height (m)	Table Angle (Degree)	Raw Value (dBuV)	Correction Factor (dB/m)
1	*2462.00	96.35 PK			1.25 H	268	63.98	32.37
2	*2462.00	91.61 AV			1.25 H	268	59.24	32.37
3	2483.50	57.03 PK	74.00	-16.97	1.26 H	267	24.64	32.39
4	2483.50	46.94 AV	54.00	-7.06	1.26 H	267	14.55	32.39
5	2688.00	59.37 PK	76.35	-16.98	1.00 H	24	26.54	32.83
6	2688.00	47.79 AV	71.61	-23.82	1.00 H	24	14.96	32.83
7	4924.00	47.23 PK	74.00	-26.77	1.00 H	116	9.00	38.23
8	4924.00	34.89 AV	54.00	-19.11	1.00 H	116	-3.34	38.23

ANTENNA POLARITY & TEST DISTANCE: VERTICAL AT 3 M								
No.	Freq. (MHz)	Emission Level (dBuV/m)	Limit (dBuV/m)	Margin (dB)	Antenna Height (m)	Table Angle (Degree)	Raw Value (dBuV)	Correction Factor (dB/m)
1	*2462.00	112.38 PK			1.04 V	1	80.01	32.37
2	*2462.00	108.26 AV			1.04 V	1	75.89	32.37
3	2483.50	63.07 PK	74.00	-10.93	1.04 V	0	30.68	32.39
4	2483.50	52.86 AV	54.00	-1.14	1.04 V	0	20.47	32.39
5	2688.00	63.39 PK	92.38	-28.99	1.16 V	358	30.56	32.83
6	2688.00	57.95 AV	88.26	-30.31	1.16 V	358	25.12	32.83
7	4924.00	47.98 PK	74.00	-26.02	1.00 V	16	9.75	38.23
8	4924.00	35.29 AV	54.00	-18.71	1.00 V	16	-2.94	38.23

- REMARKS:**
1. Emission level(dBuV/m)=Raw Value(dBuV) + Correction Factor(dB/m)
 2. Correction Factor(dB/m) = Antenna Factor (dB/m) + Cable Factor (dB)
 3. The other emission levels were very low against the limit.
 4. Margin value = Emission level – Limit value.
 5. “ * “ : Fundamental frequency.

EUT TEST CONDITION		MEASUREMENT DETAIL	
CHANNEL	Channel 1	FREQUENCY RANGE	1 ~ 25GHz
MODULATION TYPE	DBPSK	DETECTOR FUNCTION	Peak(PK) Average (AV)
TRANSFER RATE	1Mbps	ENVIRONMENTAL CONDITIONS	24deg. C, 71%RH, 1006hPa
INPUT POWER (SYSTEM)	120Vac, 60 Hz	TEST MODE	B
TESTED BY	Dean Wang		

ANTENNA POLARITY & TEST DISTANCE: HORIZONTAL AT 3 M								
No.	Freq. (MHz)	Emission Level (dBuV/m)	Limit (dBuV/m)	Margin (dB)	Antenna Height (m)	Table Angle (Degree)	Raw Value (dBuV)	Correction Factor (dB/m)
1	2390.00	60.17 PK	74.00	-13.83	1.16 H	340	27.85	32.32
2	2390.00	49.57 AV	54.00	-4.43	1.16 H	340	17.25	32.32
3	*2412.00	105.00 PK			1.16 H	340	72.68	32.32
4	*2412.00	100.34 AV			1.16 H	340	68.02	32.32
5	2688.00	61.29 PK	85.00	-23.71	1.03 H	145	28.46	32.83
6	2688.00	54.38 AV	80.34	-25.96	1.03 H	145	21.55	32.83
7	4824.00	46.68 PK	74.00	-27.32	1.00 H	217	8.68	38.00
8	4824.00	38.15 AV	54.00	-15.85	1.00 H	217	0.15	38.00

ANTENNA POLARITY & TEST DISTANCE: VERTICAL AT 3 M								
No.	Freq. (MHz)	Emission Level (dBuV/m)	Limit (dBuV/m)	Margin (dB)	Antenna Height (m)	Table Angle (Degree)	Raw Value (dBuV)	Correction Factor (dB/m)
1	2390.00	57.03 PK	74.00	-16.97	1.07 V	209	24.71	32.32
2	2390.00	46.84 AV	54.00	-7.16	1.07 V	209	14.52	32.32
3	*2412.00	98.16 PK			1.07 V	208	65.84	32.32
4	*2412.00	93.85 AV			1.07 V	208	61.53	32.32
5	2688.00	59.84 PK	78.16	-18.32	1.02 V	298	27.01	32.83
6	2688.00	48.63 AV	73.85	-25.22	1.02 V	298	15.80	32.83
7	4824.00	45.68 PK	74.00	-28.32	1.07 V	122	7.68	38.00
8	4824.00	34.36 AV	54.00	-19.64	1.07 V	122	-3.64	38.00

- REMARKS:**
1. Emission level(dBuV/m)=Raw Value(dBuV) + Correction Factor(dB/m)
 2. Correction Factor(dB/m) = Antenna Factor (dB/m) + Cable Factor (dB)
 3. The other emission levels were very low against the limit.
 4. Margin value = Emission level – Limit value.
 5. “ * “ : Fundamental frequency.

EUT TEST CONDITION		MEASUREMENT DETAIL	
CHANNEL	Channel 6	FREQUENCY RANGE	1 ~ 25GHz
MODULATION TYPE	DBPSK	DETECTOR FUNCTION	Peak(PK) Average (AV)
TRANSFER RATE	1Mbps	ENVIRONMENTAL CONDITIONS	24deg. C, 71%RH, 1006hPa
INPUT POWER (SYSTEM)	120Vac, 60 Hz	TEST MODE	B
TESTED BY	Dean Wang		

ANTENNA POLARITY & TEST DISTANCE: HORIZONTAL AT 3 M								
No.	Freq. (MHz)	Emission Level (dBuV/m)	Limit (dBuV/m)	Margin (dB)	Antenna Height (m)	Table Angle (Degree)	Raw Value (dBuV)	Correction Factor (dB/m)
1	*2437.00	108.21 PK			1.15 H	315	75.87	32.34
2	*2437.00	103.51 AV			1.15 H	315	71.17	32.34
3	2688.00	63.18 PK	88.21	-25.03	1.00 H	214	30.35	32.83
4	2688.00	55.67 AV	83.51	-27.84	1.00 H	214	22.84	32.83
5	4874.00	48.32 PK	74.00	-25.68	1.00 H	214	10.20	38.12
6	4874.00	39.87 AV	54.00	-14.13	1.00 H	214	1.75	38.12

ANTENNA POLARITY & TEST DISTANCE: VERTICAL AT 3 M								
No.	Freq. (MHz)	Emission Level (dBuV/m)	Limit (dBuV/m)	Margin (dB)	Antenna Height (m)	Table Angle (Degree)	Raw Value (dBuV)	Correction Factor (dB/m)
1	*2437.00	101.25 PK			1.05 V	214	68.85	32.40
2	*2437.00	96.94 AV			1.05 V	214	64.54	32.40
3	2688.00	60.38 PK	81.25	-20.87	1.05 V	168	27.17	33.21
4	2688.00	49.16 AV	76.94	-27.78	1.05 V	168	15.95	33.21
5	4874.00	47.32 PK	74.00	-26.68	1.05 V	147	9.00	38.32
6	4874.00	35.91 AV	54.00	-18.09	1.05 V	147	-2.41	38.32

- REMARKS:**
1. Emission level(dBuV/m)=Raw Value(dBuV) + Correction Factor(dB/m)
 2. Correction Factor(dB/m) = Antenna Factor (dB/m) + Cable Factor (dB)
 3. The other emission levels were very low against the limit.
 4. Margin value = Emission level – Limit value.
 5. “ * “ : Fundamental frequency.

EUT TEST CONDITION		MEASUREMENT DETAIL	
CHANNEL	Channel 11	FREQUENCY RANGE	1 ~ 25GHz
MODULATION TYPE	DBPSK	DETECTOR FUNCTION	Peak(PK) Average (AV)
TRANSFER RATE	1Mbps	ENVIRONMENTAL CONDITIONS	24deg. C, 71%RH, 1006hPa
INPUT POWER (SYSTEM)	120Vac, 60 Hz	TEST MODE	B
TESTED BY	Dean Wang		

ANTENNA POLARITY & TEST DISTANCE: HORIZONTAL AT 3 M								
No.	Freq. (MHz)	Emission Level (dBuV/m)	Limit (dBuV/m)	Margin (dB)	Antenna Height (m)	Table Angle (Degree)	Raw Value (dBuV)	Correction Factor (dB/m)
1	*2462.00	105.67 PK			1.15 H	336	73.19	32.48
2	*2462.00	100.89 AV			1.15 H	336	68.41	32.48
3	2483.50	61.24 PK	74.00	-12.76	1.15 H	335	28.68	32.56
4	2483.50	50.43 AV	54.00	-3.57	1.15 H	335	17.87	32.56
5	2688.00	61.92 PK	85.67	-23.75	1.00 H	124	28.71	33.21
6	2688.00	54.87 AV	80.89	-26.02	1.00 H	124	21.66	33.21
7	4924.00	47.21 PK	74.00	-26.79	1.05 H	87	8.75	38.46
8	4924.00	39.26 AV	54.00	-14.74	1.05 H	87	0.80	38.46

ANTENNA POLARITY & TEST DISTANCE: VERTICAL AT 3 M								
No.	Freq. (MHz)	Emission Level (dBuV/m)	Limit (dBuV/m)	Margin (dB)	Antenna Height (m)	Table Angle (Degree)	Raw Value (dBuV)	Correction Factor (dB/m)
1	*2462.00	98.72 PK			1.07 V	217	66.24	32.48
2	*2462.00	94.43 AV			1.07 V	217	61.95	32.48
3	2483.50	57.62 PK	74.00	-16.38	1.06 V	219	25.06	32.56
4	2483.50	47.35 AV	54.00	-6.65	1.06 V	219	14.79	32.56
5	2688.00	59.76 PK	78.72	-18.96	1.00 V	301	26.55	33.21
6	2688.00	48.52 AV	74.43	-25.91	1.00 V	301	15.31	33.21
7	4924.00	46.32 PK	74.00	-27.68	1.03 V	25	7.86	38.46
8	4924.00	35.67 AV	54.00	-18.33	1.03 V	25	-2.79	38.46

- REMARKS:**
1. Emission level(dBuV/m)=Raw Value(dBuV) + Correction Factor(dB/m)
 2. Correction Factor(dB/m) = Antenna Factor (dB/m) + Cable Factor (dB)
 3. The other emission levels were very low against the limit.
 4. Margin value = Emission level – Limit value.
 5. “ * “ : Fundamental frequency.

802.11g OFDM MODULATION_ NORMAL MODE

EUT TEST CONDITION		MEASUREMENT DETAIL	
CHANNEL	Channel 1	FREQUENCY RANGE	1 ~ 25GHz
MODULATION TYPE	BPSK	DETECTOR FUNCTION	Peak(PK) Average (AV)
TRANSFER RATE	6Mbps	ENVIRONMENTAL CONDITIONS	24deg. C, 71%RH, 1006hPa
INPUT POWER (SYSTEM)	120Vac, 60 Hz	TEST MODE	A
TESTED BY	Dean Wang		

ANTENNA POLARITY & TEST DISTANCE: HORIZONTAL AT 3 M								
No.	Freq. (MHz)	Emission Level (dBuV/m)	Limit (dBuV/m)	Margin (dB)	Antenna Height (m)	Table Angle (Degree)	Raw Value (dBuV)	Correction Factor (dB/m)
1	2390.00	56.59 PK	74.00	-17.41	1.28 H	314	24.27	32.32
2	2390.00	46.64 AV	54.00	-7.36	1.28 H	314	14.32	32.32
3	*2412.00	93.78 PK			1.30 H	315	61.46	32.32
4	*2412.00	83.81 AV			1.30 H	315	51.49	32.32
5	2688.00	56.60 PK	73.78	-53.78	1.00 H	145	23.77	32.83
6	2688.00	46.55 AV	63.81	-17.26	1.00 H	145	13.72	32.83
7	4824.00	47.05 PK	74.00	-26.95	1.00 H	257	9.05	38.00
8	4824.00	33.96 AV	54.00	-20.04	1.00 H	257	-4.04	38.00

ANTENNA POLARITY & TEST DISTANCE: VERTICAL AT 3 M								
No.	Freq. (MHz)	Emission Level (dBuV/m)	Limit (dBuV/m)	Margin (dB)	Antenna Height (m)	Table Angle (Degree)	Raw Value (dBuV)	Correction Factor (dB/m)
1	2390.00	69.22 PK	74.00	-4.78	1.05 V	1	36.90	32.32
2	2390.00	52.94 AV	54.00	-1.06	1.05 V	1	20.62	32.32
3	*2412.00	111.17 PK			1.05 V	1	78.85	32.32
4	*2412.00	101.02 AV			1.05 V	1	68.70	32.32
5	2688.00	62.19 PK	91.17	-28.98	1.16 V	355	29.36	32.83
6	2688.00	57.16 AV	81.02	-23.86	1.16 V	355	24.33	32.83
7	4824.00	47.26 PK	74.00	-26.74	1.00 V	211	9.26	38.00
8	4824.00	34.08 AV	54.00	-19.92	1.00 V	211	-3.92	38.00

- REMARKS:**
1. Emission level(dBuV/m)=Raw Value(dBuV) + Correction Factor(dB/m)
 2. Correction Factor(dB/m) = Antenna Factor (dB/m) + Cable Factor (dB)
 3. The other emission levels were very low against the limit.
 4. Margin value = Emission level – Limit value.
 5. “ * “ : Fundamental frequency.



EUT TEST CONDITION		MEASUREMENT DETAIL	
CHANNEL	Channel 6	FREQUENCY RANGE	1 ~ 25GHz
MODULATION TYPE	BPSK	DETECTOR FUNCTION	Peak(PK) Average (AV)
TRANSFER RATE	6Mbps	ENVIRONMENTAL CONDITIONS	24deg. C, 71%RH, 1006hPa
INPUT POWER (SYSTEM)	120Vac, 60 Hz	TEST MODE	A
TESTED BY	Dean Wang		

ANTENNA POLARITY & TEST DISTANCE: HORIZONTAL AT 3 M								
No.	Freq. (MHz)	Emission Level (dBuV/m)	Limit (dBuV/m)	Margin (dB)	Antenna Height (m)	Table Angle (Degree)	Raw Value (dBuV)	Correction Factor (dB/m)
1	*2437.00	96.43 PK			1.26 H	329	64.09	32.34
2	*2437.00	86.52 AV			1.26 H	329	54.18	32.34
3	2483.50	56.92 PK	74.00	-17.08	1.25 H	331	24.53	32.39
4	2483.50	46.95 AV	54.00	-7.05	1.25 H	331	14.56	32.39
5	2688.00	56.79 PK	76.43	-19.64	1.00 H	314	23.96	32.83
6	2688.00	46.72 AV	66.52	-19.80	1.00 H	314	13.89	32.83
7	4874.00	47.69 PK	74.00	-26.31	1.00 H	241	9.57	38.12
8	4874.00	34.57 AV	54.00	-19.43	1.00 H	241	-3.55	38.12

ANTENNA POLARITY & TEST DISTANCE: VERTICAL AT 3 M								
No.	Freq. (MHz)	Emission Level (dBuV/m)	Limit (dBuV/m)	Margin (dB)	Antenna Height (m)	Table Angle (Degree)	Raw Value (dBuV)	Correction Factor (dB/m)
1	*2437.00	114.12 PK			1.07 V	349	81.78	32.34
2	*2437.00	103.89 AV			1.07 V	349	71.55	32.34
3	2483.50	64.00 PK	74.00	-10.00	1.08 V	350	31.61	32.39
4	2483.50	52.57 AV	54.00	-1.43	1.08 V	350	20.18	32.39
5	2688.00	63.69 PK	94.12	-30.43	1.00 V	348	30.86	32.83
6	2688.00	58.32 AV	83.89	-25.57	1.00 V	348	25.49	32.83
7	4874.00	47.82 PK	74.00	-26.18	1.00 V	246	9.70	38.12
8	4874.00	34.68 AV	54.00	-19.32	1.00 V	246	-3.44	38.12

- REMARKS:**
1. Emission level(dBuV/m)=Raw Value(dBuV) + Correction Factor(dB/m)
 2. Correction Factor(dB/m) = Antenna Factor (dB/m) + Cable Factor (dB)
 3. The other emission levels were very low against the limit.
 4. Margin value = Emission level – Limit value.
 5. “ * “ : Fundamental frequency.

EUT TEST CONDITION		MEASUREMENT DETAIL	
CHANNEL	Channel 11	FREQUENCY RANGE	1 ~ 25GHz
MODULATION TYPE	BPSK	DETECTOR FUNCTION	Peak(PK) Average (AV)
TRANSFER RATE	6Mbps	ENVIRONMENTAL CONDITIONS	24deg. C, 71%RH, 1006hPa
INPUT POWER (SYSTEM)	120Vac, 60 Hz	TEST MODE	A
TESTED BY	Dean Wang		

ANTENNA POLARITY & TEST DISTANCE: HORIZONTAL AT 3 M								
No.	Freq. (MHz)	Emission Level (dBuV/m)	Limit (dBuV/m)	Margin (dB)	Antenna Height (m)	Table Angle (Degree)	Raw Value (dBuV)	Correction Factor (dB/m)
1	*2462.00	94.16 PK			1.00 H	295	61.79	32.37
2	*2462.00	84.23 AV			1.00 H	295	51.86	32.37
3	2483.50	56.94 PK	74.00	-17.06	1.00 H	294	24.55	32.39
4	2483.50	46.82 AV	54.00	-7.18	1.00 H	294	14.43	32.39
5	2688.00	56.82 PK	74.16	-17.34	1.02 H	147	23.99	32.83
6	2688.00	46.71 AV	64.23	-17.52	1.02 H	147	13.88	32.83
7	4924.00	46.16 PK	74.00	-27.84	1.00 H	201	7.93	38.23
8	4924.00	33.17 AV	54.00	-20.83	1.00 H	201	-5.06	38.23

ANTENNA POLARITY & TEST DISTANCE: VERTICAL AT 3 M								
No.	Freq. (MHz)	Emission Level (dBuV/m)	Limit (dBuV/m)	Margin (dB)	Antenna Height (m)	Table Angle (Degree)	Raw Value (dBuV)	Correction Factor (dB/m)
1	*2462.00	111.77 PK			1.03 V	351	79.40	32.37
2	*2462.00	101.75 AV			1.03 V	351	69.38	32.37
3	2483.50	68.58 PK	74.00	-5.42	1.03 V	350	36.19	32.39
4	2483.50	52.82 AV	54.00	-1.18	1.03 V	350	20.43	32.39
5	2688.00	62.78 PK	91.77	-28.99	1.15 V	352	29.95	32.83
6	2688.00	57.48 AV	81.75	-24.27	1.15 V	352	24.65	32.83
7	4924.00	46.23 PK	74.00	-27.77	1.00 V	142	8.00	38.23
8	4924.00	33.25 AV	54.00	-20.75	1.00 V	142	-4.98	38.23

- REMARKS:**
1. Emission level(dBuV/m)=Raw Value(dBuV) + Correction Factor(dB/m)
 2. Correction Factor(dB/m) = Antenna Factor (dB/m) + Cable Factor (dB)
 3. The other emission levels were very low against the limit.
 4. Margin value = Emission level – Limit value.
 5. “ * “ : Fundamental frequency.

EUT TEST CONDITION		MEASUREMENT DETAIL	
CHANNEL	Channel 1	FREQUENCY RANGE	1 ~ 25GHz
MODULATION TYPE	BPSK	DETECTOR FUNCTION	Peak(PK) Average (AV)
TRANSFER RATE	6Mbps	ENVIRONMENTAL CONDITIONS	24deg. C, 71%RH, 1006hPa
INPUT POWER (SYSTEM)	120Vac, 60 Hz	TEST MODE	B
TESTED BY	Dean Wang		

ANTENNA POLARITY & TEST DISTANCE: HORIZONTAL AT 3 M								
No.	Freq. (MHz)	Emission Level (dBuV/m)	Limit (dBuV/m)	Margin (dB)	Antenna Height (m)	Table Angle (Degree)	Raw Value (dBuV)	Correction Factor (dB/m)
1	2390.00	60.69 PK	74.00	-13.31	1.17 H	341	28.45	32.24
2	2390.00	49.13 AV	54.00	-4.87	1.17 H	341	16.89	32.24
3	*2412.00	102.67 PK			1.17 H	341	70.35	32.32
4	*2412.00	92.78 AV			1.17 H	341	60.46	32.32
5	2688.00	62.41 PK	82.67	-20.26	1.02 H	156	29.20	33.21
6	2688.00	55.89 AV	72.78	-16.89	1.02 H	156	22.68	33.21
7	4824.00	47.18 PK	74.00	-26.82	1.00 H	216	9.05	38.13
8	4824.00	34.13 AV	54.00	-19.87	1.00 H	216	-4.00	38.13

ANTENNA POLARITY & TEST DISTANCE: VERTICAL AT 3 M								
No.	Freq. (MHz)	Emission Level (dBuV/m)	Limit (dBuV/m)	Margin (dB)	Antenna Height (m)	Table Angle (Degree)	Raw Value (dBuV)	Correction Factor (dB/m)
1	2390.00	57.61 PK	74.00	-16.39	1.00 V	167	25.37	32.24
2	2390.00	46.69 AV	54.00	-7.31	1.00 V	167	14.45	32.24
3	*2412.00	95.30 PK			1.00 V	165	62.98	32.32
4	*2412.00	85.04 AV			1.00 V	165	52.72	32.32
5	2688.00	59.68 PK	75.30	-15.62	1.00 V	354	26.47	33.21
6	2688.00	48.49 AV	65.04	-16.55	1.00 V	354	15.28	33.21
7	4824.00	47.38 PK	74.00	-26.62	1.00 V	277	9.25	38.13
8	4824.00	34.51 AV	54.00	-19.49	1.00 V	277	-3.62	38.13

- REMARKS:**
1. Emission level(dBuV/m)=Raw Value(dBuV) + Correction Factor(dB/m)
 2. Correction Factor(dB/m) = Antenna Factor (dB/m) + Cable Factor (dB)
 3. The other emission levels were very low against the limit.
 4. Margin value = Emission level – Limit value.
 5. “ * “ : Fundamental frequency.

EUT TEST CONDITION		MEASUREMENT DETAIL	
CHANNEL	Channel 6	FREQUENCY RANGE	1 ~ 25GHz
MODULATION TYPE	BPSK	DETECTOR FUNCTION	Peak(PK) Average (AV)
TRANSFER RATE	6Mbps	ENVIRONMENTAL CONDITIONS	24deg. C, 71%RH, 1006hPa
INPUT POWER (SYSTEM)	120Vac, 60 Hz	TEST MODE	B
TESTED BY	Dean Wang		

ANTENNA POLARITY & TEST DISTANCE: HORIZONTAL AT 3 M								
No.	Freq. (MHz)	Emission Level (dBuV/m)	Limit (dBuV/m)	Margin (dB)	Antenna Height (m)	Table Angle (Degree)	Raw Value (dBuV)	Correction Factor (dB/m)
1	*2437.00	105.47 PK			1.16 H	328	73.07	32.40
2	*2437.00	95.56 AV			1.16 H	328	63.16	32.40
3	2688.00	63.19 PK	85.47	-22.28	1.02 H	241	29.98	33.21
4	2688.00	57.85 AV	75.56	-17.71	1.02 H	241	24.64	33.21
5	4874.00	47.59 PK	74.00	-26.41	1.00 H	312	9.27	38.32
6	4874.00	34.52 AV	54.00	-19.48	1.00 H	312	-3.80	38.32

ANTENNA POLARITY & TEST DISTANCE: VERTICAL AT 3 M								
No.	Freq. (MHz)	Emission Level (dBuV/m)	Limit (dBuV/m)	Margin (dB)	Antenna Height (m)	Table Angle (Degree)	Raw Value (dBuV)	Correction Factor (dB/m)
1	*2437.00	98.16 PK			1.00 V	158	65.76	32.40
2	*2437.00	87.98 AV			1.00 V	158	55.58	32.40
3	2688.00	60.13 PK	78.16	-18.03	1.00 V	112	26.92	33.21
4	2688.00	48.82 AV	67.98	-19.16	1.00 V	112	15.61	33.21
5	4874.00	47.59 PK	74.00	-26.41	1.03 V	287	9.27	38.32
6	4874.00	34.82 AV	54.00	-19.18	1.03 V	287	-3.50	38.32

- REMARKS:**
1. Emission level(dBuV/m)=Raw Value(dBuV) + Correction Factor(dB/m)
 2. Correction Factor(dB/m) = Antenna Factor (dB/m) + Cable Factor (dB)
 3. The other emission levels were very low against the limit.
 4. Margin value = Emission level – Limit value.
 5. “ * ” : Fundamental frequency.



EUT TEST CONDITION		MEASUREMENT DETAIL	
CHANNEL	Channel 11	FREQUENCY RANGE	1 ~ 25GHz
MODULATION TYPE	BPSK	DETECTOR FUNCTION	Peak(PK) Average (AV)
TRANSFER RATE	6Mbps	ENVIRONMENTAL CONDITIONS	24deg. C, 71%RH, 1006hPa
INPUT POWER (SYSTEM)	120Vac, 60 Hz	TEST MODE	B
TESTED BY	Dean Wang		

ANTENNA POLARITY & TEST DISTANCE: HORIZONTAL AT 3 M								
No.	Freq. (MHz)	Emission Level (dBuV/m)	Limit (dBuV/m)	Margin (dB)	Antenna Height (m)	Table Angle (Degree)	Raw Value (dBuV)	Correction Factor (dB/m)
1	*2462.00	103.21 PK			1.15 H	296	70.73	32.48
2	*2462.00	93.18 AV			1.15 H	296	60.70	32.48
3	2483.50	61.85 PK	74.00	-12.15	1.15 H	298	29.29	32.56
4	2483.50	50.37 AV	54.00	-3.63	1.15 H	298	17.81	32.56
5	2688.00	62.35 PK	83.21	-20.86	1.00 H	21	29.14	33.21
6	2688.00	57.31 AV	73.18	-15.87	1.00 H	21	24.10	33.21
7	4924.00	46.35 PK	74.00	-27.65	1.00 H	281	7.89	38.46
8	4924.00	33.52 AV	54.00	-20.48	1.00 H	281	-4.94	38.46

ANTENNA POLARITY & TEST DISTANCE: VERTICAL AT 3 M								
No.	Freq. (MHz)	Emission Level (dBuV/m)	Limit (dBuV/m)	Margin (dB)	Antenna Height (m)	Table Angle (Degree)	Raw Value (dBuV)	Correction Factor (dB/m)
1	*2462.00	95.87 PK			1.00 V	158	63.39	32.48
2	*2462.00	85.62 AV			1.00 V	158	53.14	32.48
3	2483.50	58.12 PK	74.00	-15.88	1.00 V	152	25.56	32.56
4	2483.50	47.05 AV	54.00	-6.95	1.00 V	152	14.49	32.56
5	2688.00	58.65 PK	75.87	-17.22	1.00 V	217	25.44	33.21
6	2688.00	48.92 AV	65.62	-16.70	1.00 V	217	15.71	33.21
7	4924.00	46.52 PK	74.00	-27.48	1.00 V	106	8.06	38.46
8	4924.00	33.48 AV	54.00	-20.52	1.00 V	106	-4.98	38.46

- REMARKS:**
1. Emission level(dBuV/m)=Raw Value(dBuV) + Correction Factor(dB/m)
 2. Correction Factor(dB/m) = Antenna Factor (dB/m) + Cable Factor (dB)
 3. The other emission levels were very low against the limit.
 4. Margin value = Emission level – Limit value.
 5. “ * “ : Fundamental frequency.

802.11g OFDM MODULATION TURBO MODE

EUT TEST CONDITION		MEASUREMENT DETAIL	
CHANNEL	Channel 6	FREQUENCY RANGE	1 ~ 25GHz
MODULATION TYPE	QPSK	DETECTOR FUNCTION	Peak(PK) Average (AV)
TRANSFER RATE	12Mbps	ENVIRONMENTAL CONDITIONS	24deg. C, 71%RH, 1006hPa
INPUT POWER (SYSTEM)	120Vac, 60 Hz	TEST MODE	A
TESTED BY	Dean Wang		

ANTENNA POLARITY & TEST DISTANCE: HORIZONTAL AT 3 M

No.	Freq. (MHz)	Emission Level (dBuV/m)	Limit (dBuV/m)	Margin (dB)	Antenna Height (m)	Table Angle (Degree)	Raw Value (dBuV)	Correction Factor (dB/m)
1	2390.00	59.44 PK	74.00	-14.56	1.56 H	300	27.12	32.32
2	2390.00	47.86 AV	54.00	-6.14	1.56 H	300	15.54	32.32
3	*2437.00	94.85 PK			1.56 H	313	62.51	32.34
4	*2437.00	85.40 AV			1.56 H	313	53.06	32.34
5	2483.50	58.60 PK	74.00	-15.40	1.08 H	351	26.21	32.39
6	2483.50	47.65 AV	54.00	-6.35	1.08 H	351	15.26	32.39
7	2688.00	59.81 PK	74.85	-15.04	1.00 H	214	26.98	32.83
8	2688.00	47.41 AV	65.40	-17.99	1.00 H	214	14.58	32.83
9	4874.00	46.87 PK	74.00	-27.13	1.00 H	258	8.75	38.12
10	4874.00	34.46 AV	54.00	-19.54	1.00 H	258	-3.66	38.12

ANTENNA POLARITY & TEST DISTANCE: VERTICAL AT 3 M

No.	Freq. (MHz)	Emission Level (dBuV/m)	Limit (dBuV/m)	Margin (dB)	Antenna Height (m)	Table Angle (Degree)	Raw Value (dBuV)	Correction Factor (dB/m)
1	2390.00	64.07 PK	74.00	-9.93	1.07 V	353	31.75	32.32
2	2390.00	52.86 AV	54.00	-1.14	1.07 V	353	20.54	32.32
3	*2437.00	110.85 PK			1.08 V	352	78.51	32.34
4	*2437.00	101.32 AV			1.08 V	352	68.98	32.34
5	2483.50	63.97 PK	74.00	-10.03	1.07 V	353	31.58	32.39
6	2483.50	52.62 AV	54.00	-1.38	1.07 V	353	20.23	32.39
7	2688.00	63.51 PK	90.85	-27.34	1.00 V	350	30.68	32.83
8	2688.00	58.21 AV	81.32	-23.11	1.00 V	350	25.38	32.83
9	4874.00	47.21 PK	74.00	-26.79	1.00 V	172	9.09	38.12
10	4874.00	34.75 AV	54.00	-19.25	1.00 V	172	-3.37	38.12

- REMARKS:**
1. Emission level(dBuV/m)=Raw Value(dBuV) + Correction Factor(dB/m)
 2. Correction Factor(dB/m) = Antenna Factor (dB/m) + Cable Factor (dB)
 3. The other emission levels were very low against the limit.
 4. Margin value = Emission level – Limit value.
 5. “ * “ : Fundamental frequency.

EUT TEST CONDITION		MEASUREMENT DETAIL	
CHANNEL	Channel 6	FREQUENCY RANGE	1 ~ 25GHz
MODULATION TYPE	QPSK	DETECTOR FUNCTION	Peak(PK) Average (AV)
TRANSFER RATE	12Mbps	ENVIRONMENTAL CONDITIONS	24deg. C, 71%RH, 1006hPa
INPUT POWER (SYSTEM)	120Vac, 60 Hz	TEST MODE	B
TESTED BY	Dean Wang		

ANTENNA POLARITY & TEST DISTANCE: HORIZONTAL AT 3 M								
No.	Freq. (MHz)	Emission Level (dBuV/m)	Limit (dBuV/m)	Margin (dB)	Antenna Height (m)	Table Angle (Degree)	Raw Value (dBuV)	Correction Factor (dB/m)
1	2390.00	61.19 PK	74.00	-12.81	1.09 H	198	28.95	32.24
2	2390.00	50.48 AV	54.00	-3.52	1.09 H	198	18.24	32.24
3	*2437.00	106.11 PK			1.09 H	198	73.71	32.40
4	*2437.00	96.62 AV			1.09 H	198	64.22	32.40
5	2483.50	60.86 PK	74.00	-13.14	1.09 H	198	28.30	32.56
6	2483.50	50.04 AV	54.00	-3.96	1.09 H	198	17.48	32.56
7	2688.00	62.13 PK	86.11	-23.98	1.03 H	247	28.92	33.21
8	2688.00	56.72 AV	76.62	-19.90	1.03 H	247	23.51	33.21
9	4874.00	47.56 PK	74.00	-26.44	1.00 H	116	9.24	38.32
10	4874.00	35.05 AV	54.00	-18.95	1.00 H	116	-3.27	38.32

ANTENNA POLARITY & TEST DISTANCE: VERTICAL AT 3 M								
No.	Freq. (MHz)	Emission Level (dBuV/m)	Limit (dBuV/m)	Margin (dB)	Antenna Height (m)	Table Angle (Degree)	Raw Value (dBuV)	Correction Factor (dB/m)
1	2390.00	57.16 PK	74.00	-16.84	1.00 V	157	24.92	32.24
2	2390.00	46.58 AV	54.00	-7.42	1.00 V	157	14.34	32.24
3	*2437.00	98.85 PK			1.00 V	157	66.45	32.40
4	*2437.00	88.71 AV			1.00 V	157	56.31	32.40
5	2483.50	56.87 PK	74.00	-17.13	1.00 V	157	24.31	32.56
6	2483.50	46.08 AV	54.00	-7.92	1.00 V	157	13.52	32.56
7	2688.00	60.28 PK	78.85	-18.57	1.03 V	57	27.07	33.21
8	2688.00	48.82 AV	68.71	-19.89	1.03 V	57	15.61	33.21
9	4874.00	47.79 PK	74.00	-26.21	1.00 V	354	9.47	38.32
10	4874.00	35.21 AV	54.00	-18.79	1.00 V	354	-3.11	38.32

- REMARKS:**
1. Emission level(dBuV/m)=Raw Value(dBuV) + Correction Factor(dB/m)
 2. Correction Factor(dB/m) = Antenna Factor (dB/m) + Cable Factor (dB)
 3. The other emission levels were very low against the limit.
 4. Margin value = Emission level – Limit value.
 5. " * " : Fundamental frequency.



RADIATED WORST-CASE DATA: BELOW 1GHz

EUT TEST CONDITION		MEASUREMENT DETAIL	
CHANNEL	Channel 11	FREQUENCY RANGE	Below 1000MHz
MODULATION TYPE	BPSK	DETECTOR FUNCTION	Quasi-Peak
TRANSFER RATE	6Mbps	ENVIRONMENTAL CONDITIONS	26deg. C, 67%RH, 1006hPa
INPUT POWER (SYSTEM)	120Vac, 60 Hz	TEST MODE	A
TESTED BY	Kevin Liang		

ANTENNA POLARITY & TEST DISTANCE: HORIZONTAL AT 3 M								
No.	Freq. (MHz)	Emission Level (dBuV/m)	Limit (dBuV/m)	Margin (dB)	Antenna Height (m)	Table Angle (Degree)	Raw Value (dBuV)	Correction Factor (dB/m)
1	105.73	40.15 QP	43.50	-3.35	1.50 H	121	29.45	10.70
2	146.56	36.70 QP	43.50	-6.80	2.00 H	106	22.33	14.38
3	360.00	44.34 QP	46.00	-1.66	1.00 H	330	28.03	16.31
4	539.30	36.10 QP	46.00	-9.90	2.00 H	130	14.56	21.54
5	720.12	38.17 QP	46.00	-7.83	2.00 H	247	12.69	25.48
6	900.94	39.62 QP	46.00	-6.38	1.50 H	181	11.65	27.97

ANTENNA POLARITY & TEST DISTANCE: VERTICAL AT 3 M								
No.	Freq. (MHz)	Emission Level (dBuV/m)	Limit (dBuV/m)	Margin (dB)	Antenna Height (m)	Table Angle (Degree)	Raw Value (dBuV)	Correction Factor (dB/m)
1	44.81	38.50 QP	40.00	-1.50	1.01 V	179	25.49	13.01
2	66.28	38.24 QP	40.00	-1.76	1.00 V	32	25.45	12.79
3	360.01	44.66 QP	46.00	-1.34	1.31 V	320	28.35	16.31
4	539.30	44.02 QP	46.00	-1.98	1.00 V	187	22.48	21.54
5	720.12	39.17 QP	46.00	-6.83	2.00 V	187	13.69	25.48
6	811.50	36.07 QP	46.00	-9.93	2.00 V	223	9.47	26.60

- REMARKS:**
1. Emission level(dBuV/m)=Raw Value(dBuV) + Correction Factor(dB/m)
 2. Correction Factor(dB/m) = Antenna Factor (dB/m) + Cable Factor (dB)
 3. The other emission levels were very low against the limit.
 4. Margin value = Emission level – Limit value.



EUT TEST CONDITION		MEASUREMENT DETAIL	
CHANNEL	Channel 11	FREQUENCY RANGE	Below 1000MHz
MODULATION TYPE	BPSK	DETECTOR FUNCTION	Quasi-Peak
TRANSFER RATE	6Mbps	ENVIRONMENTAL CONDITIONS	26deg. C, 67%RH, 1006hPa
INPUT POWER (SYSTEM)	120Vac, 60 Hz	TEST MODE	B
TESTED BY	Kevin Liang		

ANTENNA POLARITY & TEST DISTANCE: HORIZONTAL AT 3 M								
No.	Freq. (MHz)	Emission Level (dBuV/m)	Limit (dBuV/m)	Margin (dB)	Antenna Height (m)	Table Angle (Degree)	Raw Value (dBuV)	Correction Factor (dB/m)
1	103.78	41.31 QP	43.50	-2.19	2.00 H	88	30.81	10.49
2	175.72	34.01 QP	43.50	-9.49	1.50 H	94	20.60	13.41
3	360.43	44.67 QP	46.00	-1.33	1.00 H	334	28.35	16.32
4	539.30	40.14 QP	46.00	-5.86	1.50 H	193	18.61	21.54
5	720.12	44.39 QP	46.00	-1.61	1.00 H	247	18.91	25.48
6	900.94	41.40 QP	46.00	-4.60	1.50 H	163	13.43	27.97

ANTENNA POLARITY & TEST DISTANCE: VERTICAL AT 3 M								
No.	Freq. (MHz)	Emission Level (dBuV/m)	Limit (dBuV/m)	Margin (dB)	Antenna Height (m)	Table Angle (Degree)	Raw Value (dBuV)	Correction Factor (dB/m)
1	41.57	38.46 QP	40.00	-1.54	1.00 V	148	25.81	12.65
2	72.67	38.13 QP	40.00	-1.87	1.00 V	73	26.26	11.87
3	101.84	41.62 QP	43.50	-1.88	1.50 V	46	31.33	10.29
4	360.43	44.27 QP	46.00	-1.73	1.50 V	355	27.95	16.32
5	720.12	36.46 QP	46.00	-9.54	1.50 V	271	10.98	25.48
6	900.94	37.11 QP	46.00	-8.89	1.00 V	211	9.15	27.97

- REMARKS:**
1. Emission level(dBuV/m)=Raw Value(dBuV) + Correction Factor(dB/m)
 2. Correction Factor(dB/m) = Antenna Factor (dB/m) + Cable Factor (dB)
 3. The other emission levels were very low against the limit.
 4. Margin value = Emission level – Limit value.

4.2 CONDUCTED EMISSION MEASUREMENT

4.2.1 LIMITS OF CONDUCTED EMISSION MEASUREMENT

FREQUENCY OF EMISSION (MHz)	CONDUCTED LIMIT (dB μ V)	
	Quasi-peak	Average
0.15 ~ 0.5	66 to 56	56 to 46
0.5 ~ 5	56	46
5 ~ 30	60	50

- NOTE:**
1. The lower limit shall apply at the transition frequencies.
 2. The limit decreases in line with the logarithm of the frequency in the range of 0.15 to 0.50 MHz.
 3. All emanations from a class A/B digital device or system, including any network of conductors and apparatus connected thereto, shall not exceed the level of field strengths specified above.

4.2.2 TEST INSTRUMENTS

DESCRIPTION & MANUFACTURER	MODEL NO.	SERIAL NO.	CALIBRATED UNTIL
Test Receiver ROHDE & SCHWARZ	ESCS30	100289	Dec. 08, 2007
RF signal cable Woken	5D-FB	Cable-HYCO3-01	Jan. 06, 2008
LISN ROHDE & SCHWARZ	ESH2-Z5	100100	Jan. 08, 2008
LISN ROHDE & SCHWARZ	ESH3-Z5	100311	Jan. 16, 2008
Software ADT	ADT_Cond_V3	NA	NA

- NOTE:**
1. The calibration interval of the above test instruments is 12 months and the calibrations are traceable to NML/ROC and NIST/USA.
 2. The test was performed in HwaYa Shielded Room 2.
 3. The VCCI Site Registration No. is C-2047.

4.2.3 TEST PROCEDURES

- a. The EUT was placed 0.4 meters from the conducting wall of the shielded room with EUT being connected to the power mains through a line impedance stabilization network (LISN). Other support units were connected to the power mains through another LISN. The two LISNs provide 50 ohm/ 50uH of coupling impedance for the measuring instrument.
- b. Both lines of the power mains connected to the EUT were checked for maximum conducted interference.
- c. The frequency range from 150kHz to 30MHz was searched. Emission levels under (Limit - 20dB) was not recorded.

NOTE: All modes of operation were investigated and the worst-case emissions are reported.

4.2.4 DEVIATION FROM TEST STANDARD

No deviation.

4.2.5 TEST SETUP

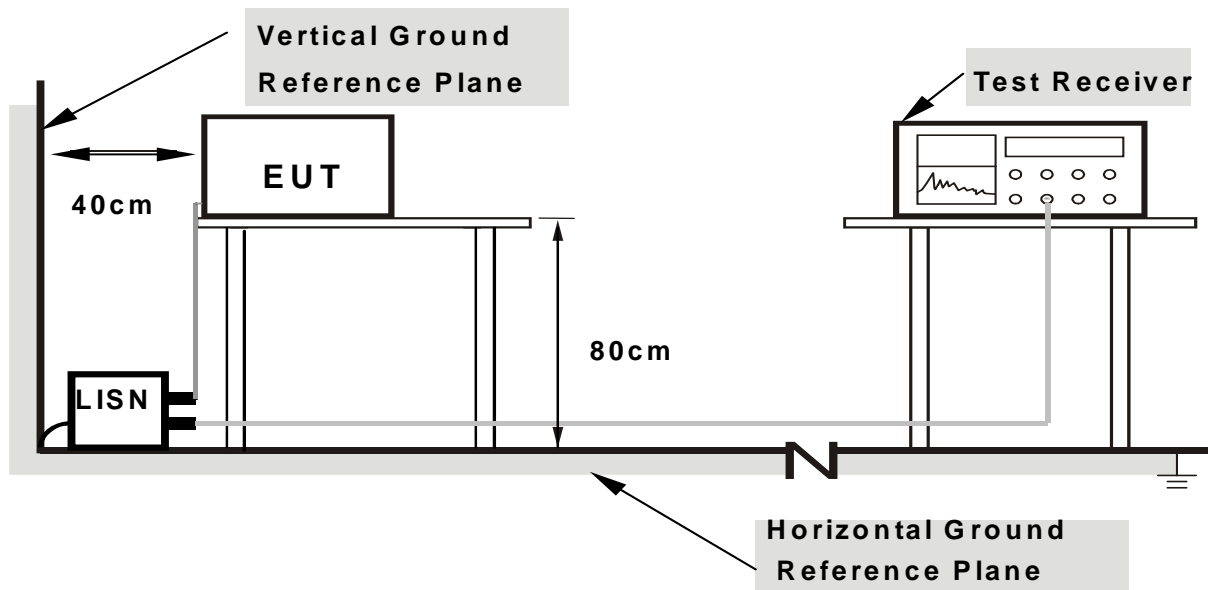

Note: 1.Support units were connected to second LISN.

2.Both of LISNs (AMN) are 80 cm from EUT and at least 80 from other units and other metal planes

For the actual test configuration, please refer to the attached file (Test Setup Photo).

4.2.6 EUT OPERATING CONDITIONS

Same as 4.1.6

4.2.7 TEST RESULTS

CONDUCTED WORST-CASE DATA_NORMAL MODE

EUT TEST CONDITION		MEASUREMENT DETAIL	
CHANNEL	Channel 1	PHASE	Line 1
MODULATION TYPE	BPSK	6dB BANDWIDTH	9 kHz
TRANSFER RATE	6Mbps	ENVIRONMENTAL CONDITIONS	20deg. C, 60%RH, 998hPa
INPUT POWER (SYSTEM)	120Vac, 60 Hz	TESTED BY	Match Tsui

No	Freq. [MHz]	Corr. Factor [dB]	Reading Value [dB (uV)]		Emission Level [dB (uV)]		Limit [dB (uV)]		Margin (dB)	
			Q.P.	AV.	Q.P.	AV.	Q.P.	AV.	Q.P.	AV.
			1	0.201	0.10	44.22	-	44.32	-	63.57
2	0.334	0.10	41.08	-	41.18	-	59.36	49.36	-18.18	-
3	0.468	0.10	46.65	46.06	46.75	46.16	56.55	46.55	-9.80	-0.39
4	1.203	0.13	39.93	-	40.06	-	56.00	46.00	-15.94	-
5	3.875	0.28	39.66	-	39.94	-	56.00	46.00	-16.06	-
6	19.711	0.56	41.85	-	42.41	-	60.00	50.00	-17.59	-

- REMARKS:**
1. Q.P. and AV. are abbreviations of quasi-peak and average individually.
 2. "-": The Quasi-peak reading value also meets average limit and measurement with the average detector is unnecessary.
 3. The emission levels of other frequencies were very low against the limit.
 4. Margin value = Emission level - Limit value
 5. Correction factor = Insertion loss + Cable loss
 6. Emission Level = Correction Factor + Reading Value.

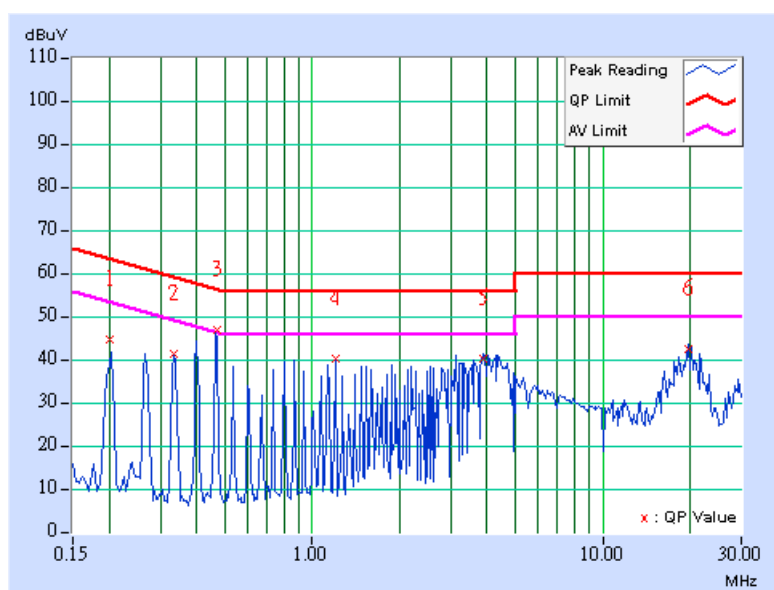

EUT TEST CONDITION		MEASUREMENT DETAIL	
CHANNEL	Channel 1	PHASE	Line 2
MODULATION TYPE	BPSK	6dB BANDWIDTH	9 kHz
TRANSFER RATE	6Mbps	ENVIRONMENTAL CONDITIONS	20deg. C, 60%RH, 998hPa
INPUT POWER (SYSTEM)	120Vac, 60 Hz	TESTED BY	Match Tsui

No	Freq. [MHz]	Corr. Factor (dB)	Reading Value [dB (uV)]		Emission Level [dB (uV)]		Limit [dB (uV)]		Margin (dB)	
			Q.P.	AV.	Q.P.	AV.	Q.P.	AV.	Q.P.	AV.
1	0.201	0.10	42.31	-	42.41	-	63.58	53.58	-21.17	-
2	0.334	0.10	39.96	-	40.06	-	59.36	49.36	-19.30	-
3	0.466	0.11	45.50	-	44.61	-	56.58	46.58	-11.97	-
4	1.203	0.21	39.42	-	38.63	-	56.00	46.00	-17.37	-
5	4.277	0.29	39.73	-	40.02	-	56.00	46.00	-15.98	-
6	19.711	0.56	41.67	-	42.23	-	60.00	50.00	-17.77	-

- REMARKS:**
1. Q.P. and AV. are abbreviations of quasi-peak and average individually.
 2. "-": The Quasi-peak reading value also meets average limit and measurement with the average detector is unnecessary.
 3. The emission levels of other frequencies were very low against the limit.
 4. Margin value = Emission level - Limit value
 5. Correction factor = Insertion loss + Cable loss
 6. Emission Level = Correction Factor + Reading Value.

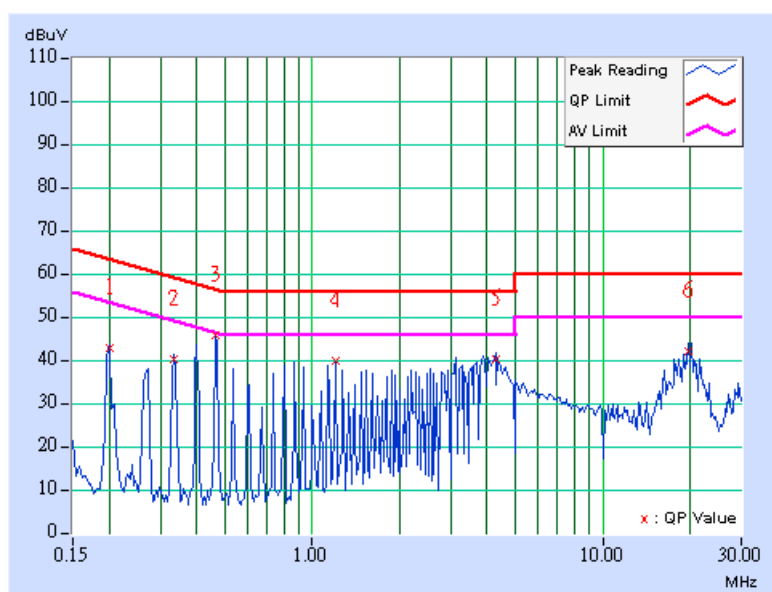

EUT TEST CONDITION		MEASUREMENT DETAIL	
CHANNEL	Channel 6	PHASE	Line 1
MODULATION TYPE	BPSK	6dB BANDWIDTH	9 kHz
TRANSFER RATE	6Mbps	ENVIRONMENTAL CONDITIONS	20deg. C, 60%RH, 998hPa
INPUT POWER (SYSTEM)	120Vac, 60 Hz	TESTED BY	Match Tsui

No	Freq. [MHz]	Corr. Factor (dB)	Reading Value [dB (uV)]		Emission Level [dB (uV)]		Limit [dB (uV)]		Margin (dB)	
			Q.P.	AV.	Q.P.	AV.	Q.P.	AV.	Q.P.	AV.
1	0.201	0.10	43.87	-	43.97	-	63.58	53.58	-19.61	-
2	0.334	0.10	41.06	-	41.16	-	59.36	49.36	-18.20	-
3	0.470	0.10	45.26	-	45.36	-	56.51	46.51	-11.15	-
4	1.203	0.13	39.99	-	40.12	-	56.00	46.00	-15.88	-
5	4.211	0.28	38.91	-	39.19	-	56.00	46.00	-16.81	-
6	20.258	0.58	41.75	-	42.33	-	60.00	50.00	-17.67	-

- REMARKS:**
1. Q.P. and AV. are abbreviations of quasi-peak and average individually.
 2. "-": The Quasi-peak reading value also meets average limit and measurement with the average detector is unnecessary.
 3. The emission levels of other frequencies were very low against the limit.
 4. Margin value = Emission level - Limit value
 5. Correction factor = Insertion loss + Cable loss
 6. Emission Level = Correction Factor + Reading Value.

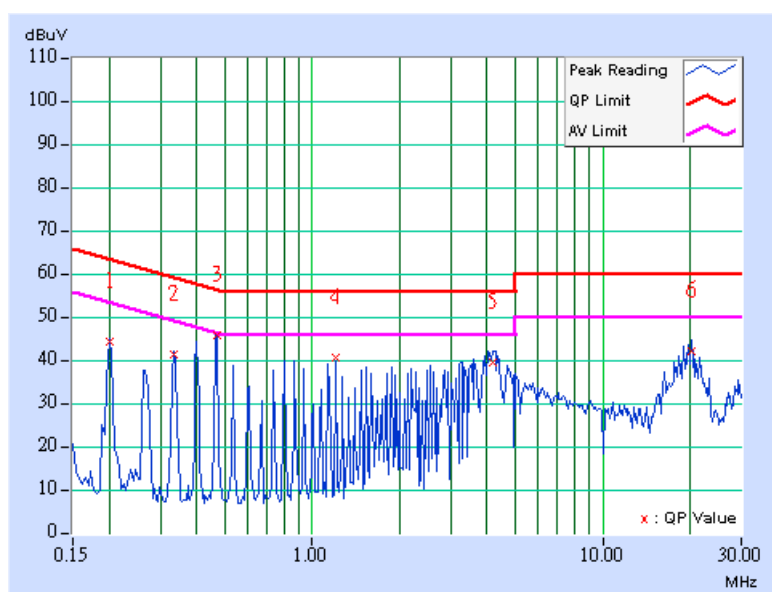

EUT TEST CONDITION		MEASUREMENT DETAIL	
CHANNEL	Channel 6	PHASE	Line 2
MODULATION TYPE	BPSK	6dB BANDWIDTH	9 kHz
TRANSFER RATE	6Mbps	ENVIRONMENTAL CONDITIONS	20deg. C, 60%RH, 998hPa
INPUT POWER (SYSTEM)	120Vac, 60 Hz	TESTED BY	Match Tsui

No	Freq. [MHz]	Corr. Factor (dB)	Reading Value [dB (uV)]		Emission Level [dB (uV)]		Limit [dB (uV)]		Margin (dB)	
			Q.P.	AV.	Q.P.	AV.	Q.P.	AV.	Q.P.	AV.
1	0.201	0.10	41.92	-	42.02	-	63.58	53.58	-21.56	-
2	0.334	0.10	39.88	-	39.98	-	59.36	49.36	-19.38	-
3	0.468	0.11	45.76	-	45.87	-	56.55	46.55	-10.68	-
4	1.137	0.21	38.81	-	39.02	-	56.00	46.00	-16.98	-
5	4.211	0.29	39.50	-	39.79	-	56.00	46.00	-16.21	-
6	19.711	0.56	41.45	-	42.01	-	60.00	50.00	-17.99	-

- REMARKS:**
1. Q.P. and AV. are abbreviations of quasi-peak and average individually.
 2. "-": The Quasi-peak reading value also meets average limit and measurement with the average detector is unnecessary.
 3. The emission levels of other frequencies were very low against the limit.
 4. Margin value = Emission level - Limit value
 5. Correction factor = Insertion loss + Cable loss
 6. Emission Level = Correction Factor + Reading Value.

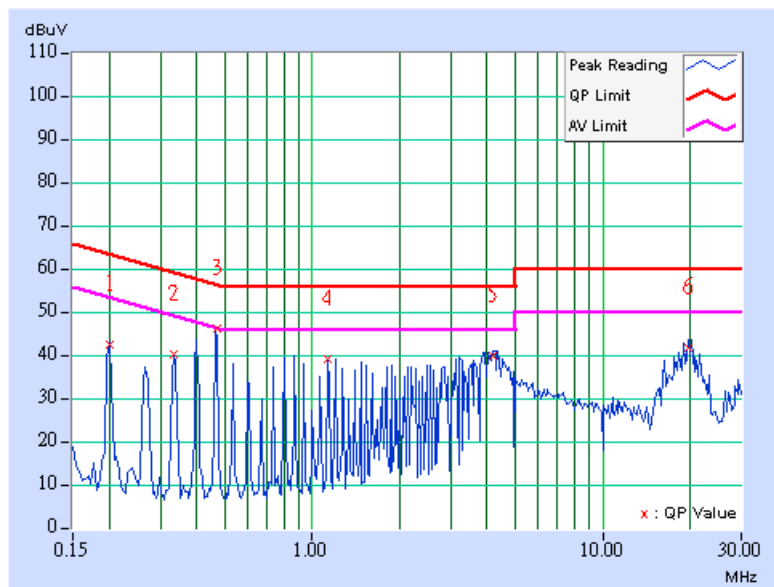

EUT TEST CONDITION		MEASUREMENT DETAIL	
CHANNEL	Channel 11	PHASE	Line 1
MODULATION TYPE	BPSK	6dB BANDWIDTH	9 kHz
TRANSFER RATE	6Mbps	ENVIRONMENTAL CONDITIONS	20deg. C, 60%RH, 998hPa
INPUT POWER (SYSTEM)	120Vac, 60 Hz	TESTED BY	Match Tsui

No	Freq. [MHz]	Corr. Factor (dB)	Reading Value [dB (uV)]		Emission Level [dB (uV)]		Limit [dB (uV)]		Margin (dB)	
			Q.P.	AV.	Q.P.	AV.	Q.P.	AV.	Q.P.	AV.
1	0.201	0.10	43.53	-	43.63	-	63.58	53.58	-19.95	-
2	0.334	0.10	40.96	-	41.06	-	59.36	49.36	-18.30	-
3	0.468	0.10	46.73	46.10	46.83	46.20	56.55	46.55	-9.72	-0.35
4	0.869	0.11	40.16	-	40.27	-	56.00	46.00	-15.73	-
5	4.141	0.28	39.67	-	39.95	-	56.00	46.00	-16.05	-
6	19.711	0.56	37.28	-	37.84	-	60.00	50.00	-22.16	-

- REMARKS:**
1. Q.P. and AV. are abbreviations of quasi-peak and average individually.
 2. "-": The Quasi-peak reading value also meets average limit and measurement with the average detector is unnecessary.
 3. The emission levels of other frequencies were very low against the limit.
 4. Margin value = Emission level - Limit value
 5. Correction factor = Insertion loss + Cable loss
 6. Emission Level = Correction Factor + Reading Value.

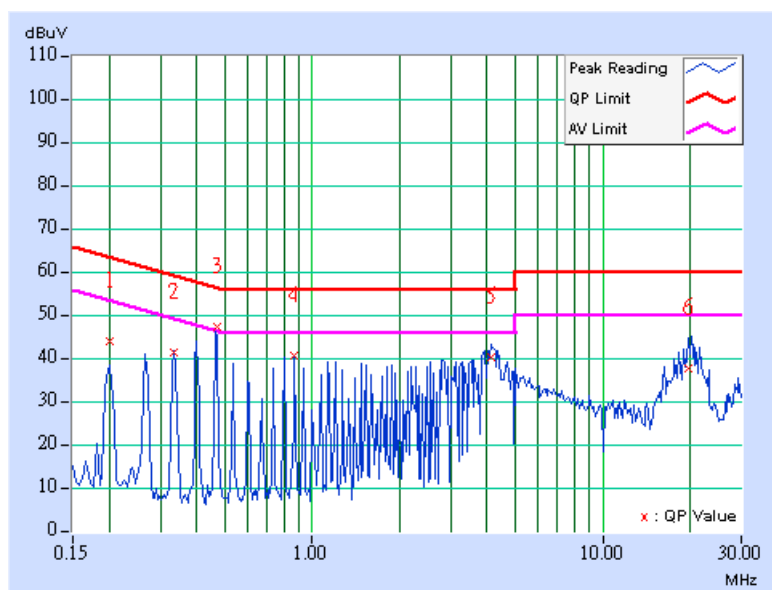

EUT TEST CONDITION		MEASUREMENT DETAIL	
CHANNEL	Channel 11	PHASE	Line 2
MODULATION TYPE	BPSK	6dB BANDWIDTH	9 kHz
TRANSFER RATE	6Mbps	ENVIRONMENTAL CONDITIONS	20deg. C, 60%RH, 998hPa
INPUT POWER (SYSTEM)	120Vac, 60 Hz	TESTED BY	Match Tsui

No	Freq. [MHz]	Corr. Factor (dB)	Reading Value [dB (uV)]		Emission Level [dB (uV)]		Limit [dB (uV)]		Margin (dB)	
			Q.P.	AV.	Q.P.	AV.	Q.P.	AV.	Q.P.	AV.
1	0.201	0.10	42.30	-	42.40	-	63.58	53.58	-21.18	-
2	0.334	0.10	37.79	-	37.89	-	59.36	49.36	-21.47	-
3	0.468	0.11	47.60	44.93	47.71	45.04	56.55	46.55	-8.84	-1.51
4	1.203	0.21	37.58	-	37.79	-	56.00	46.00	-18.21	-
5	4.344	0.29	40.42	-	40.71	-	56.00	46.00	-15.29	-
6	18.246	0.54	37.07	-	37.61	-	60.00	50.00	-22.39	-

- REMARKS:**
1. Q.P. and AV. are abbreviations of quasi-peak and average individually.
 2. "-": The Quasi-peak reading value also meets average limit and measurement with the average detector is unnecessary.
 3. The emission levels of other frequencies were very low against the limit.
 4. Margin value = Emission level - Limit value
 5. Correction factor = Insertion loss + Cable loss
 6. Emission Level = Correction Factor + Reading Value.

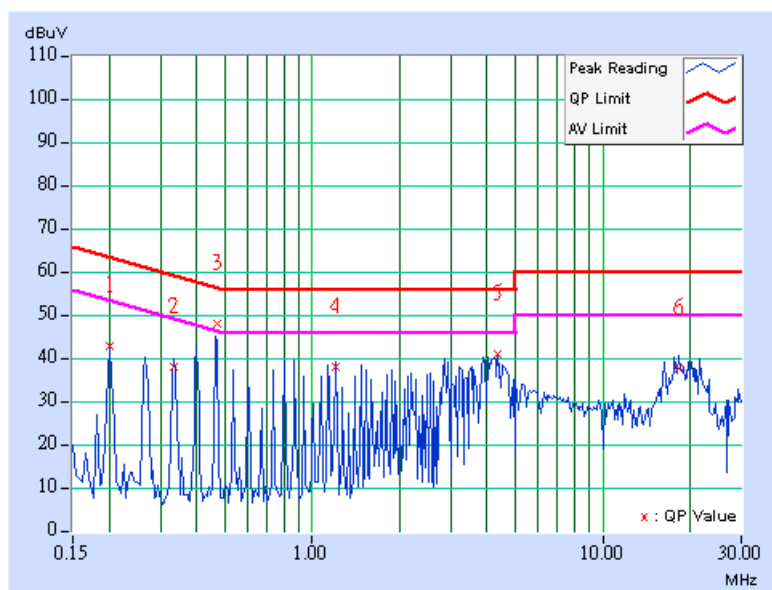

CONDUCTED WORST-CASE DATA_TURBO MODE

EUT TEST CONDITION		MEASUREMENT DETAIL	
CHANNEL	Channel 6	PHASE	Line 1
MODULATION TYPE	QPSK	6dB BANDWIDTH	9 kHz
TRANSFER RATE	12Mbps	ENVIRONMENTAL CONDITIONS	20deg. C, 60%RH, 998hPa
INPUT POWER (SYSTEM)	120Vac, 60 Hz	TESTED BY	Match Tsui

No	Freq. [MHz]	Corr. Factor (dB)	Reading Value [dB (uV)]		Emission Level [dB (uV)]		Limit [dB (uV)]		Margin (dB)	
			Q.P.	AV.	Q.P.	AV.	Q.P.	AV.	Q.P.	AV.
1	0.199	0.10	44.54	-	44.64	-	63.63	53.63	-18.99	-
2	0.334	0.10	41.08	-	41.18	-	59.36	49.36	-18.18	-
3	0.468	0.10	46.61	46.10	46.71	46.20	56.56	46.56	-9.84	-0.35
4	0.869	0.11	40.04	-	40.15	-	56.00	46.00	-15.85	-
5	4.273	0.28	40.48	-	40.76	-	56.00	46.00	-15.24	-
6	19.711	0.56	42.01	-	42.57	-	60.00	50.00	-17.43	-

- REMARKS:**
1. Q.P. and AV. are abbreviations of quasi-peak and average individually.
 2. "-": The Quasi-peak reading value also meets average limit and measurement with the average detector is unnecessary.
 3. The emission levels of other frequencies were very low against the limit.
 4. Margin value = Emission level - Limit value
 5. Correction factor = Insertion loss + Cable loss
 6. Emission Level = Correction Factor + Reading Value.

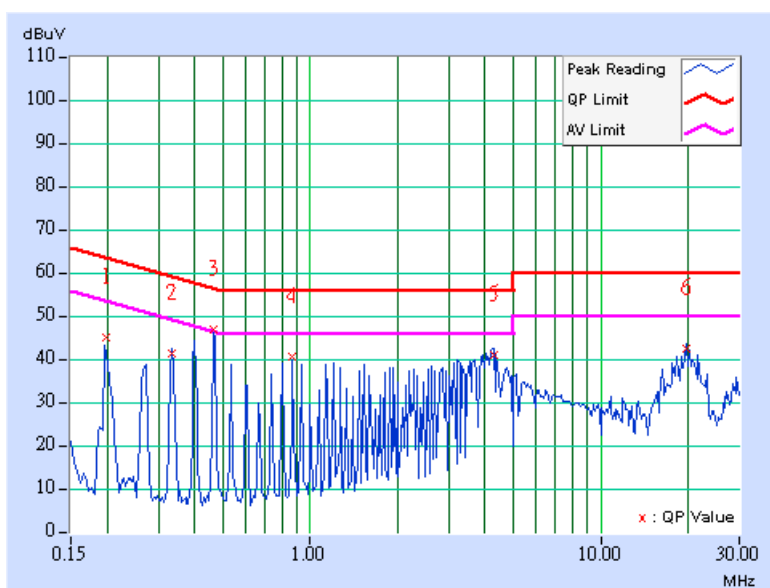

EUT TEST CONDITION		MEASUREMENT DETAIL	
CHANNEL	Channel 6	PHASE	Line 2
MODULATION TYPE	QPSK	6dB BANDWIDTH	9 kHz
TRANSFER RATE	12Mbps	ENVIRONMENTAL CONDITIONS	20deg. C, 60%RH, 998hPa
INPUT POWER (SYSTEM)	120Vac, 60 Hz	TESTED BY	Match Tsui

No	Freq. [MHz]	Corr. Factor (dB)	Reading Value [dB (uV)]		Emission Level [dB (uV)]		Limit [dB (uV)]		Margin (dB)	
			Q.P.	AV.	Q.P.	AV.	Q.P.	AV.	Q.P.	AV.
1	0.203	0.10	41.05	-	41.15	-	63.47	53.47	-22.32	-
2	0.334	0.10	40.02	-	40.12	-	59.36	49.36	-19.24	-
3	0.468	0.11	45.72	-	45.83	-	56.55	46.55	-10.72	-
4	1.203	0.21	39.32	-	39.53	-	56.00	46.00	-16.47	-
5	4.273	0.29	39.28	-	39.57	-	56.00	46.00	-16.43	-
6	19.711	0.56	41.81	-	42.37	-	60.00	50.00	-17.63	-

- REMARKS:**
1. Q.P. and AV. are abbreviations of quasi-peak and average individually.
 2. "-": The Quasi-peak reading value also meets average limit and measurement with the average detector is unnecessary.
 3. The emission levels of other frequencies were very low against the limit.
 4. Margin value = Emission level - Limit value
 5. Correction factor = Insertion loss + Cable loss
 6. Emission Level = Correction Factor + Reading Value.

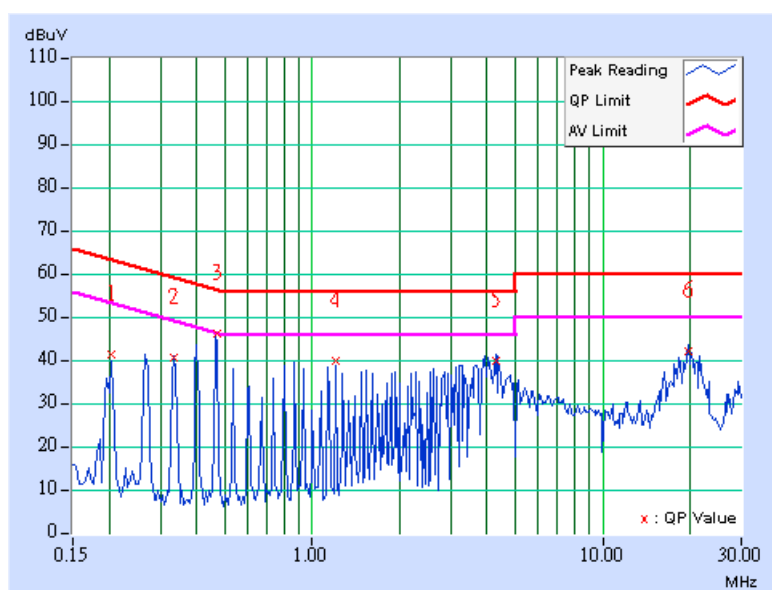



4.3 6dB BANDWIDTH MEASUREMENT

4.3.1 LIMITS OF 6dB BANDWIDTH MEASUREMENT

The minimum of 6dB Bandwidth Measurement is 0.5 MHz.

4.3.2 TEST INSTRUMENTS

DESCRIPTION & MANUFACTURER	MODEL NO.	SERIAL NO.	CALIBRATED UNTIL
SPECTRUM ANALYZER	FSP 40	100040	Jun. 28, 2008

NOTE: The calibration interval of the above test instruments is 12 months and the calibrations are traceable to NML/ROC and NIST/USA.

4.3.3 TEST PROCEDURE

The transmitter output was connected to the spectrum analyzer through an attenuator. The bandwidth of the fundamental frequency was measured by spectrum analyzer with 100 kHz RBW and 300kHz VBW. The 6dB bandwidth is defined as the total spectrum the power of which is higher than peak power minus 6dB.

4.3.4 DEVIATION FROM TEST STANDARD

No deviation.

4.3.5 TEST SETUP

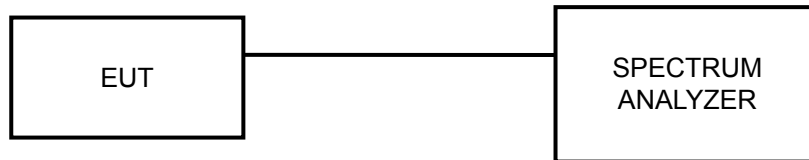

For the actual test configuration, please refer to the related Item – Photographs of the Test Configuration.

4.3.6 EUT OPERATING CONDITIONS

The software provided by client to enable the EUT under transmission condition continuously at lowest, middle and highest channel frequencies individually.

4.3.7 TEST RESULTS

802.11b DSSS MODULATION

MODULATION TYPE	DBPSK	TRANSFER RATE	1Mbps
INPUT POWER (SYSTEM)	120Vac, 60 Hz	ENVIRONMENTAL CONDITIONS	25deg. C, 65%RH, 1005hPa
TESTED BY	Long Chen		

CHANNEL	CHANNEL FREQUENCY (MHz)	6dB BANDWIDTH (MHz)	MINIMUM LIMIT (MHz)	PASS/FAIL
1	2412	11.12	0.5	PASS
6	2437	12.08	0.5	PASS
11	2462	12.08	0.5	PASS

CH 1

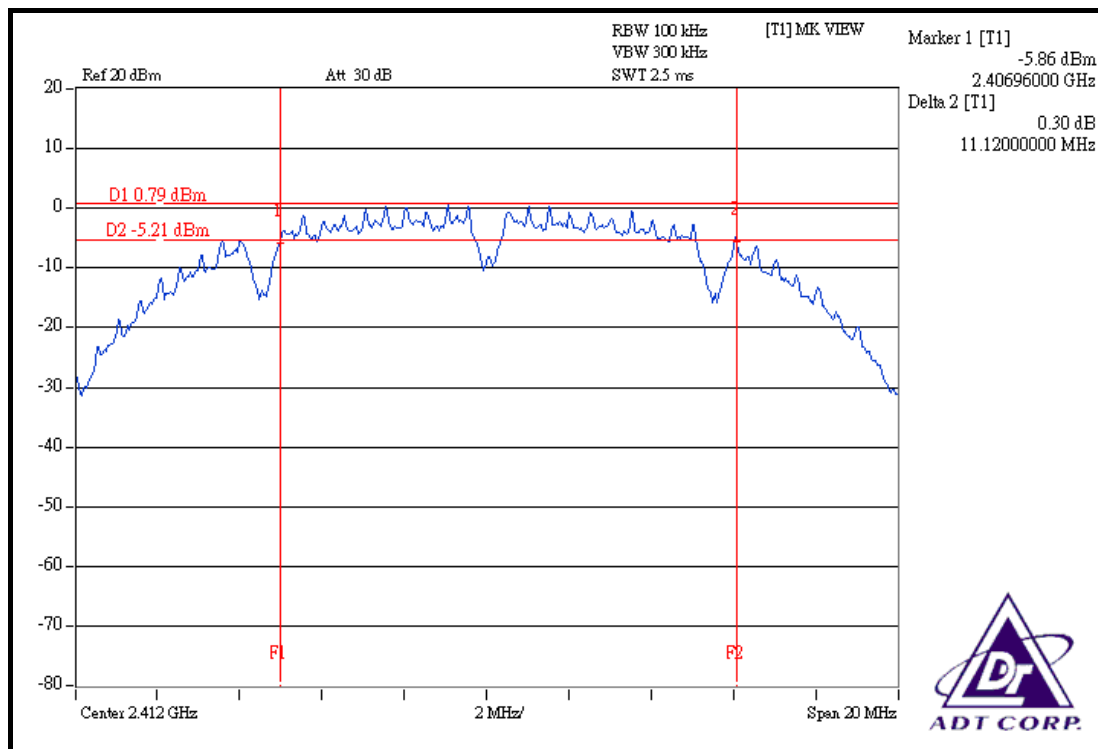

CH 6

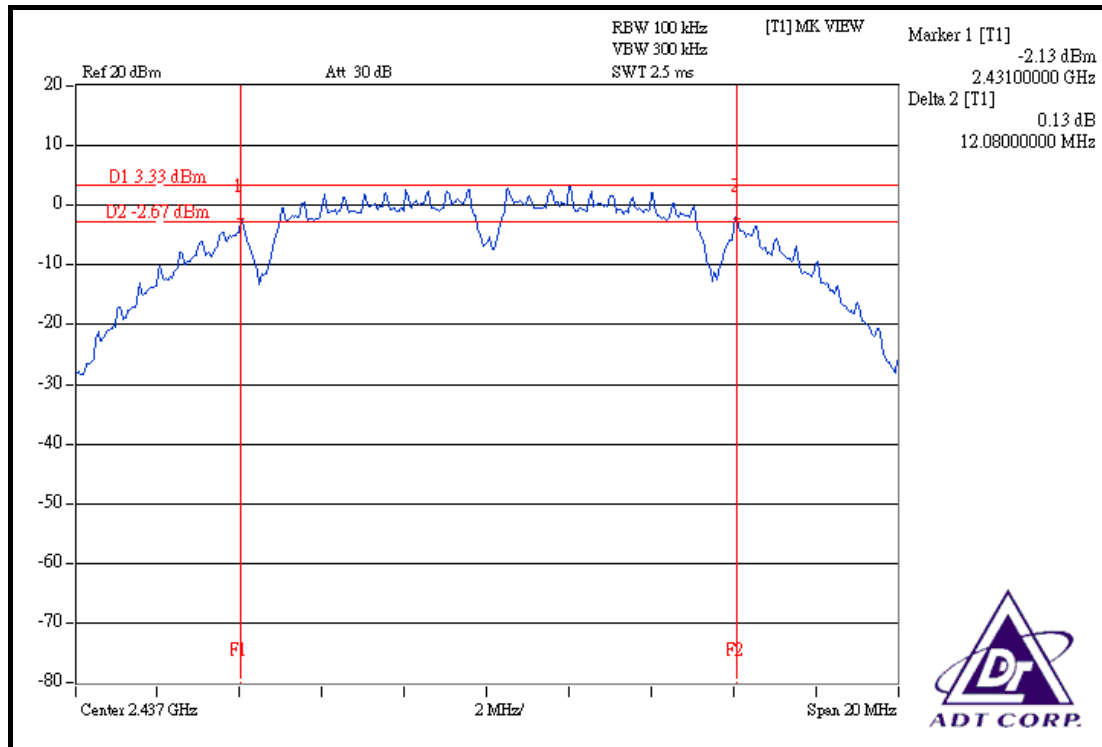

CH 11

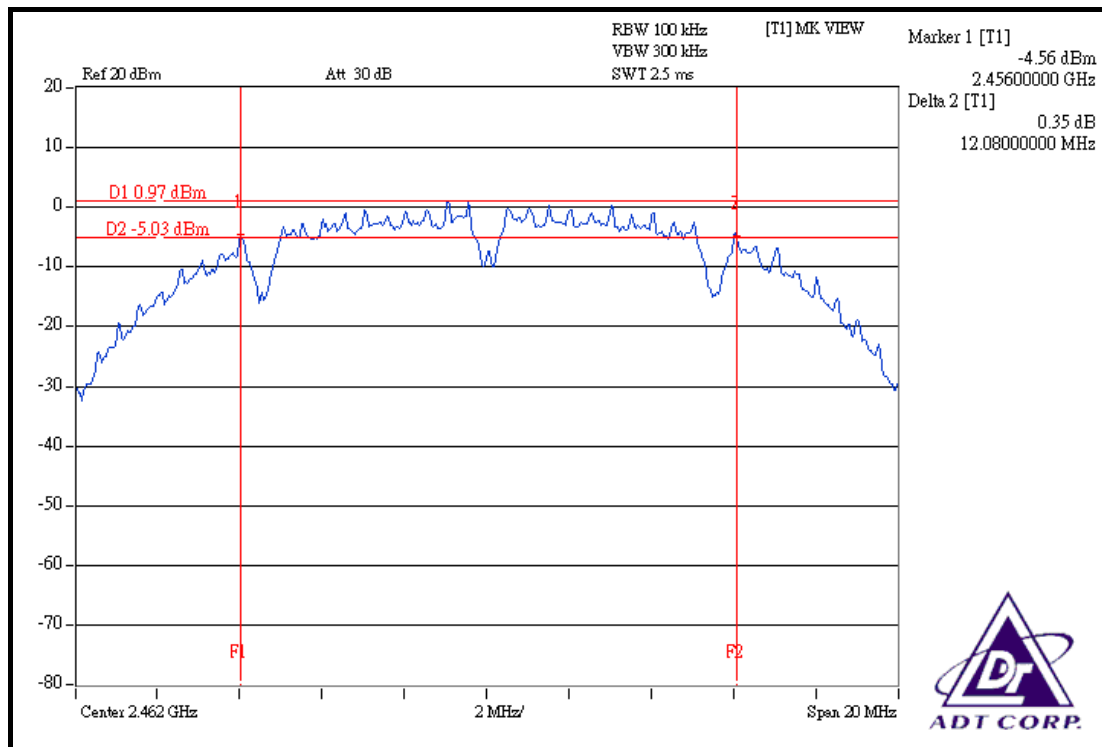



802.11g OFDM MODULATION_NORMAL MODE

MODULATION TYPE	BPSK	TRANSFER RATE	6Mbps
INPUT POWER (SYSTEM)	120Vac, 60 Hz	ENVIRONMENTAL CONDITIONS	25deg. C, 65%RH, 1005hPa
TESTED BY	Long Chen		

CHANNEL	CHANNEL FREQUENCY (MHz)	6dB BANDWIDTH (MHz)	MINIMUM LIMIT (MHz)	PASS/FAIL
1	2412	16.44	0.5	PASS
6	2437	16.48	0.5	PASS
11	2462	16.36	0.5	PASS

CH 1

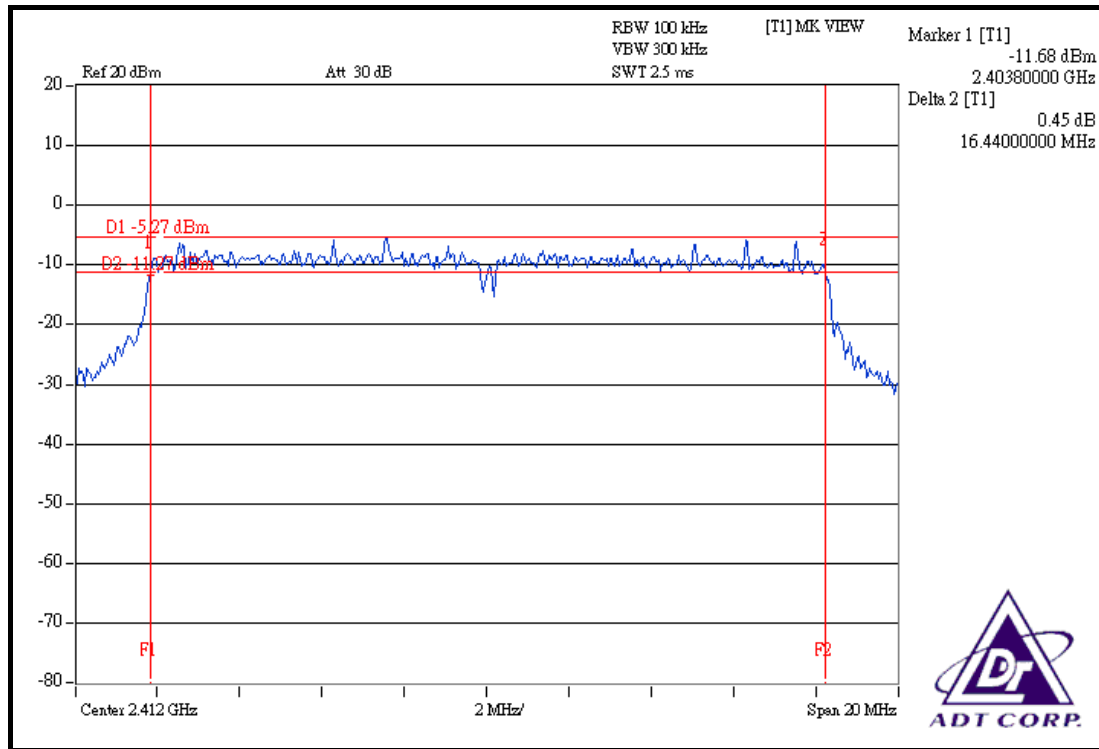

CH 6

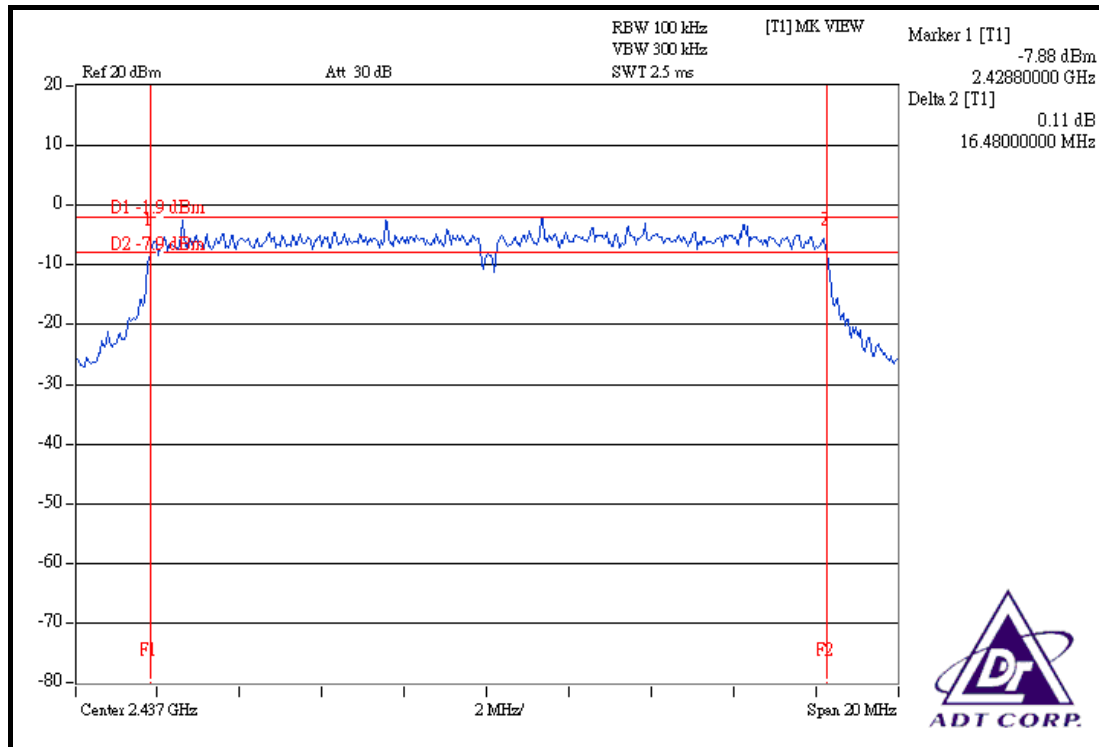

CH 11

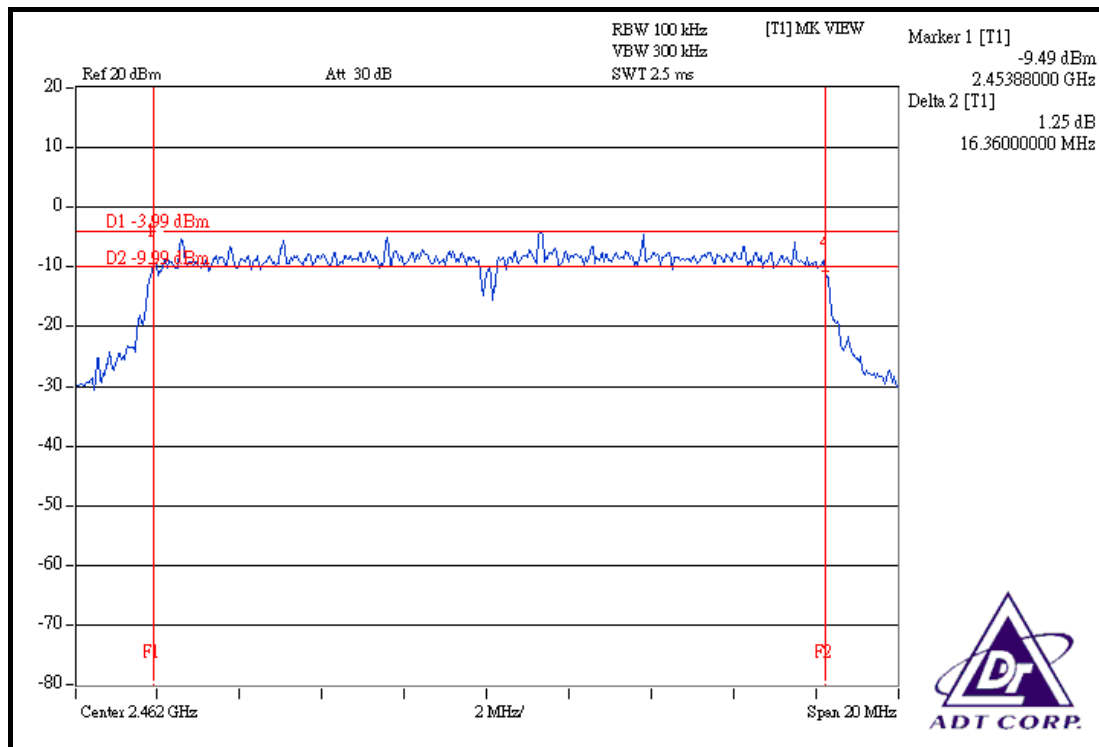



802.11g OFDM MODULATION_TURBO MODE

MODULATION TYPE	QPSK	TRANSFER RATE	12Mbps
INPUT POWER (SYSTEM)	120Vac, 60 Hz	ENVIRONMENTAL CONDITIONS	25deg. C, 65%RH, 1005hPa
TESTED BY	Long Chen		

CHANNEL	CHANNEL FREQUENCY (MHz)	6dB BANDWIDTH (MHz)	MINIMUM LIMIT (MHz)	PASS/FAIL
6	2437	32.80	0.5	PASS

CH 6

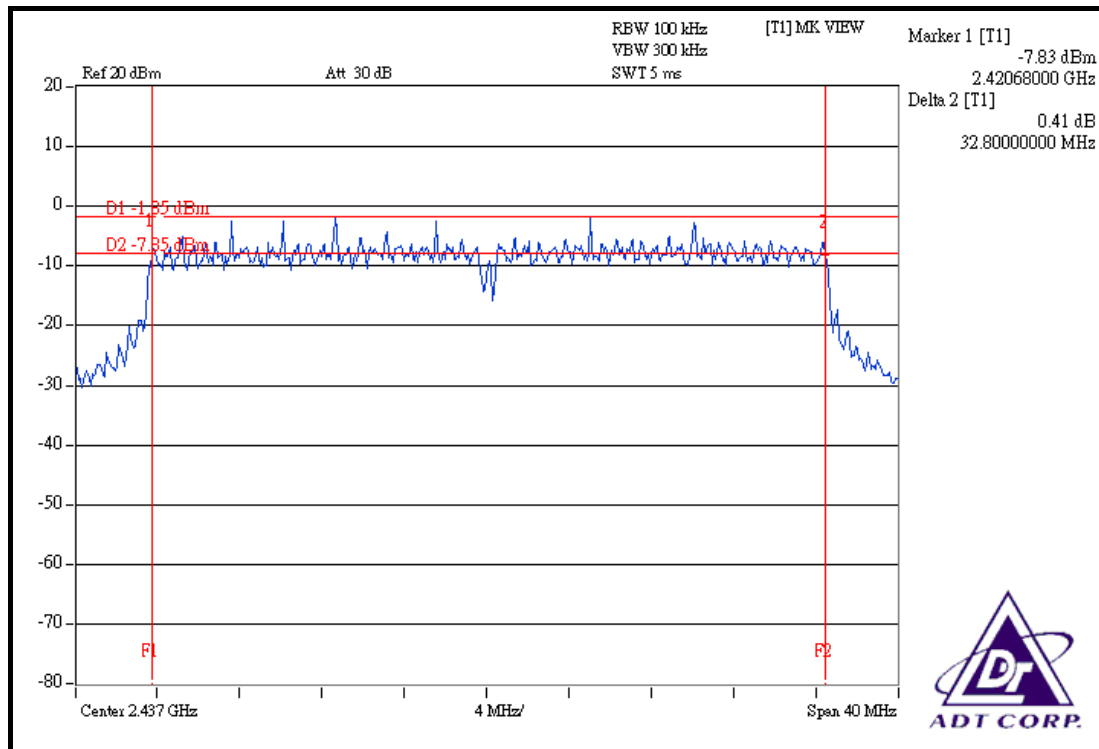



4.4 MAXIMUM PEAK OUTPUT POWER

4.4.1 LIMITS OF MAXIMUM PEAK OUTPUT POWER MEASUREMENT

The Maximum Peak Output Power Measurement is 30dBm.

4.4.2 TEST INSTRUMENTS

DESCRIPTION & MANUFACTURER	MODEL NO.	SERIAL NO.	CALIBRATED UNTIL
R&S SPECTRUM ANALYZER	FSP40	100040	Jun. 28, 2008
AGILENT SIGNAL GENERATOR	E8257C	MY43320668	Dec. 28, 2007
TEKTRONIX OSCILLOSCOPE	TDS1012	C037299	Nov. 27, 2007
NARDA DETECTOR	4503A	FSCM99899	NA

NOTE: The calibration interval of the above test instruments is 12 months and the calibrations are traceable to NML/ROC and NIST/USA.

4.4.3 TEST PROCEDURES

- a. A detector was used on the output port of the EUT. An oscilloscope was used to peak the response of the detector.
- b. Replaced the EUT by the signal generator. The center frequency of the S.G was adjusted to the center frequency of the measured channel.
- c. Adjusted the power to have the same peak reading on oscilloscope. Record the power level.

4.4.4 DEVIATION FROM TEST STANDARD

No deviation.

4.4.5 TEST SETUP

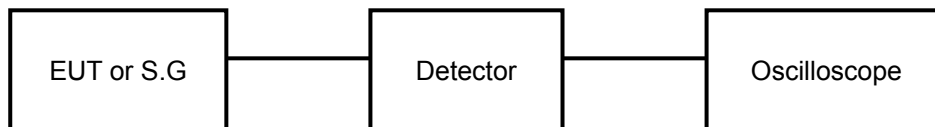

4.4.6 EUT OPERATING CONDITIONS

Same as 4.3.6.



4.4.7 TEST RESULTS

802.11b DSSS MODULATION

MODULATION TYPE	DBPSK	TRANSFER RATE	1Mbps
INPUT POWER (SYSTEM)	120Vac, 60 Hz	ENVIRONMENTAL CONDITIONS	25deg. C, 65%RH, 1005hPa
TESTED BY	Long Chen		

CHANNEL	CHANNEL FREQUENCY (MHz)	PEAK POWER OUTPUT (mW)	PEAK POWER OUTPUT (dBm)	PEAK POWER LIMIT (dBm)	PASS/FAIL
1	2412	18.113	12.58	29	PASS
6	2437	35.645	15.52	29	PASS
11	2462	20.277	13.07	29	PASS

NOTE: According to 15.247(b)(4), the maximum antenna gain 9dBi is higher than 6dBi, so the limit of peak power shall be reduced by 1dB.

802.11g OFDM MODULATION_NORMAL MODE

MODULATION TYPE	BPSK	TRANSFER RATE	6Mbps
INPUT POWER (SYSTEM)	120Vac, 60 Hz	ENVIRONMENTAL CONDITIONS	25deg. C, 65%RH, 1005hPa
TESTED BY	Long Chen		

CHANNEL	CHANNEL FREQUENCY (MHz)	PEAK POWER OUTPUT (mW)	PEAK POWER OUTPUT (dBm)	PEAK POWER LIMIT (dBm)	PASS/FAIL
1	2412	12.853	11.09	29	PASS
6	2437	25.235	14.02	29	PASS
11	2462	15.922	12.02	29	PASS

NOTE: According to 15.247(b)(4), the maximum antenna gain 9dBi is higher than 6dBi, so the limit of peak power shall be reduced by 1dB.

802.11g OFDM MODULATION_TURBO MODE

MODULATION TYPE	QPSK	TRANSFER RATE	12Mbps
INPUT POWER (SYSTEM)	120Vac, 60 Hz	ENVIRONMENTAL CONDITIONS	25deg. C, 65%RH, 1005hPa
TESTED BY	Long Chen		

CHANNEL	CHANNEL FREQUENCY (MHz)	PEAK POWER OUTPUT (mW)	PEAK POWER OUTPUT (dBm)	PEAK POWER LIMIT (dBm)	PASS/FAIL
6	2437	22.751	13.57	29	PASS

NOTE: According to 15.247(b)(4), the maximum antenna gain 9dBi is higher than 6dBi, so the limit of peak power shall be reduced by 1dB.

4.5 POWER SPECTRAL DENSITY MEASUREMENT

4.5.1 LIMITS OF POWER SPECTRAL DENSITY MEASUREMENT

The Maximum of Power Spectral Density Measurement is 8dBm.

4.5.2 TEST INSTRUMENTS

DESCRIPTION & MANUFACTURER	MODEL NO.	SERIAL NO.	CALIBRATED UNTIL
R&S SPECTRUM ANALYZER	FSP 40	100040	Jun. 28, 2008

NOTE: The calibration interval of the above test instruments is 12 months and the calibrations are traceable to NML/ROC and NIST/USA.

4.5.3 TEST PROCEDURE

The transmitter output was connected to the spectrum analyzer through an attenuator, the bandwidth of the fundamental frequency was measured with the spectrum analyzer using 3kHz RBW and 30kHz VBW, set sweep time = span/3kHz. The power spectral density was measured and recorded.

The sweep time is allowed to be longer than span/3kHz for a full response of the mixer in the spectrum analyzer.

4.5.4 DEVIATION FROM TEST STANDARD

No deviation.

4.5.5 TEST SETUP

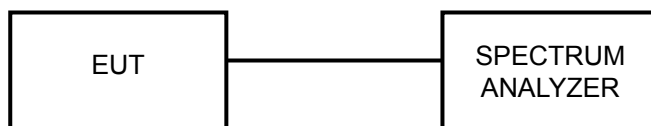

4.5.6 EUT OPERATING CONDITIONS

Same as 4.3.6.

4.5.7 TEST RESULTS

802.11b DSSS MODULATION

MODULATION TYPE	DBPSK	TRANSFER RATE	1Mbps
INPUT POWER (SYSTEM)	120Vac, 60 Hz	ENVIRONMENTAL CONDITIONS	25deg. C, 65%RH, 1005hPa
TESTED BY	Long Chen		

CHANNEL	CHANNEL FREQUENCY (MHz)	RF POWER LEVEL IN 3 kHz BW (dBm)	MAXIMUM LIMIT (dBm)	PASS/FAIL
1	2412	-13.93	7	PASS
6	2437	-10.92	7	PASS
11	2462	-13.61	7	PASS

NOTE: According to 15.247(b)(4), the maximum antenna gain 9dBi is higher than 6dBi, so the limit of peak power shall be reduced by 1dB.

CH 1

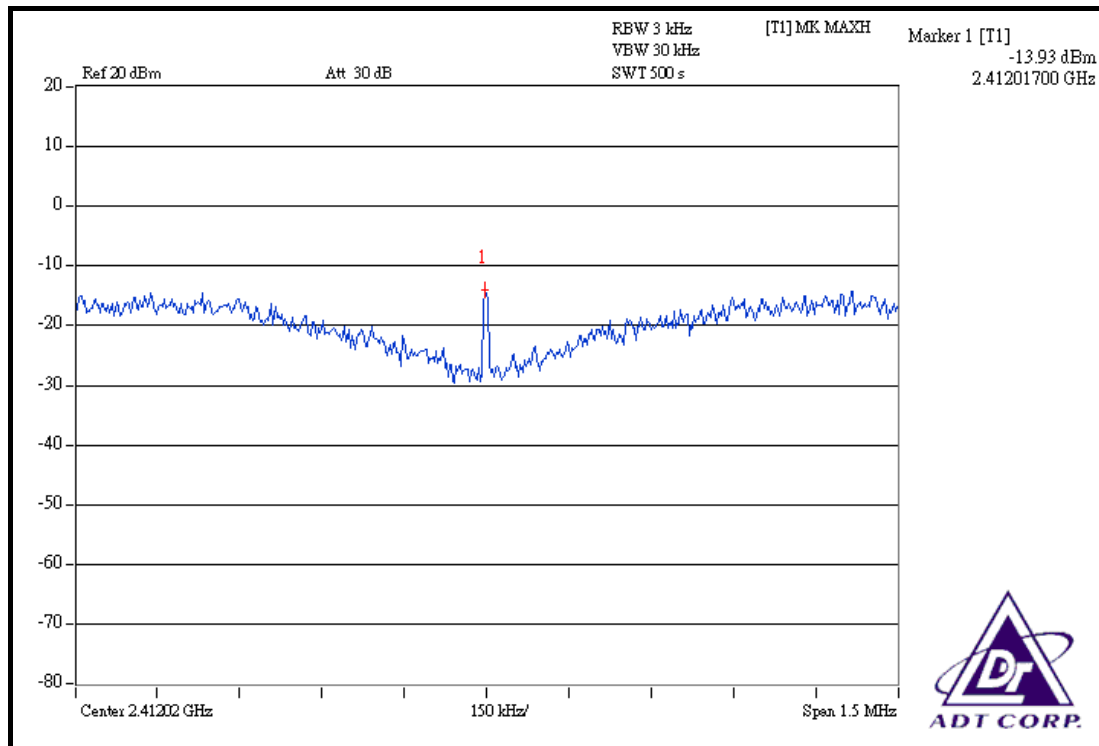

802.11g OFDM MODULATION_NORMAL MODE

MODULATION TYPE	BPSK	TRANSFER RATE	6Mbps
INPUT POWER (SYSTEM)	120Vac, 60 Hz	ENVIRONMENTAL CONDITIONS	25deg. C, 65%RH, 1005hPa
TESTED BY	Long Chen		

CHANNEL	CHANNEL FREQUENCY (MHz)	RF POWER LEVEL IN 3 kHz BW (dBm)	MAXIMUM LIMIT (dBm)	PASS/FAIL
1	2412	-14.98	7	PASS
6	2437	-11.79	7	PASS
11	2462	-14.11	7	PASS

NOTE: According to 15.247(b)(4), the maximum antenna gain 9dBi is higher than 6dBi, so the limit of peak power shall be reduced by 1dB.

CH 1

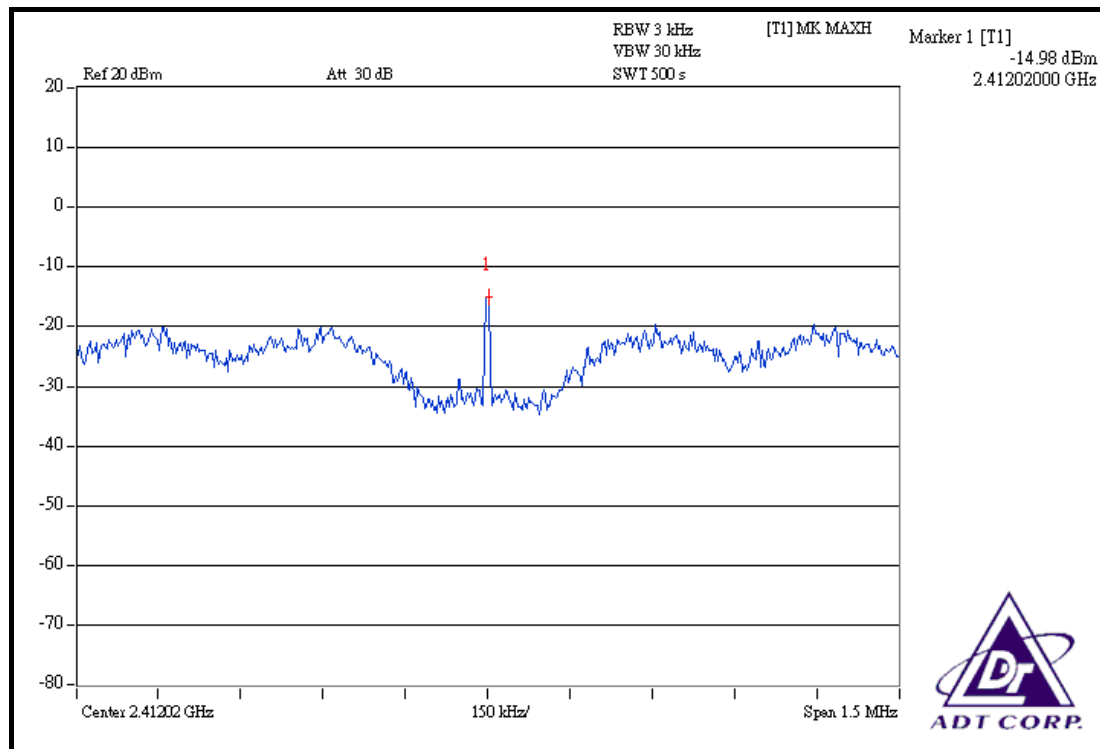



802.11g OFDM MODULATION_NORMAL MODE

MODULATION TYPE	QPSK	TRANSFER RATE	12Mbps
INPUT POWER (SYSTEM)	120Vac, 60 Hz	ENVIRONMENTAL CONDITIONS	25deg. C, 65%RH, 1005hPa
TESTED BY	Long Chen		

CHANNEL	CHANNEL FREQUENCY (MHz)	RF POWER LEVEL IN 3 kHz BW (dBm)	MAXIMUM LIMIT (dBm)	PASS/FAIL
6	2437	-12.48	7	PASS

NOTE: According to 15.247(b)(4), the maximum antenna gain 9dBi is higher than 6dBi, so the limit of peak power shall be reduced by 1dB.

CH 6

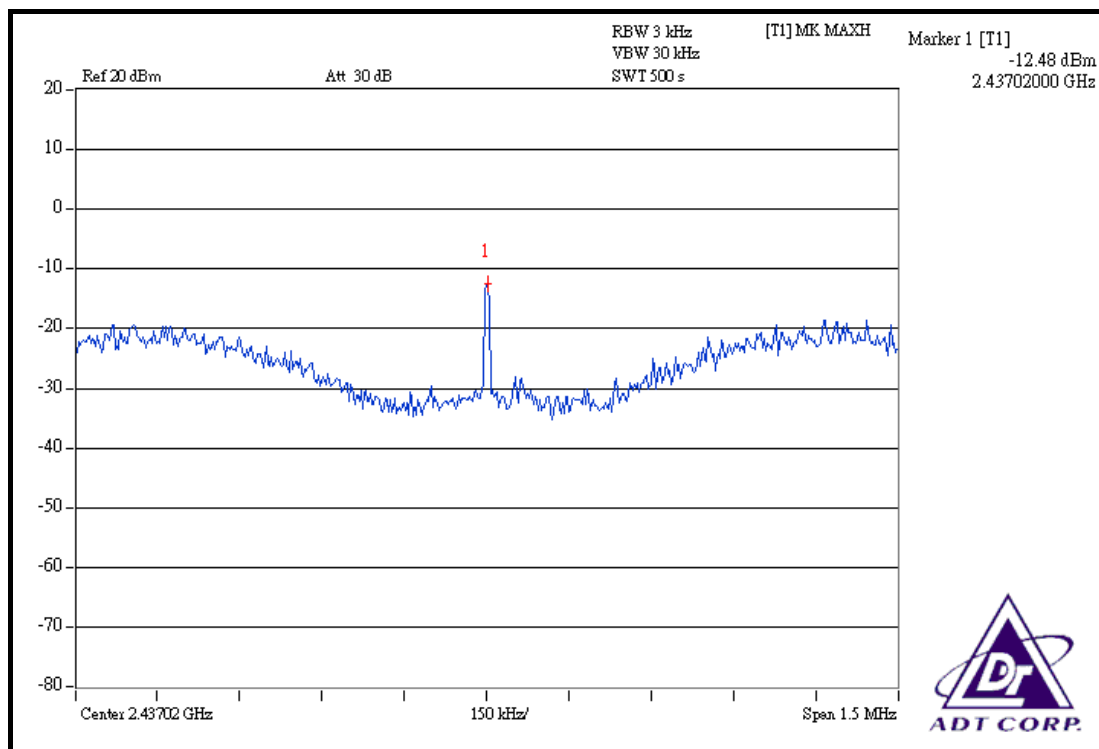



4.6 BAND EDGES MEASUREMENT

4.6.1 LIMITS OF BAND EDGES MEASUREMENT

Below -20dB of the highest emission level of operating band (in 100kHz Resolution Bandwidth).

4.6.2 TEST INSTRUMENTS

DESCRIPTION & MANUFACTURER	MODEL NO.	SERIAL NO.	CALIBRATED UNTIL
R&S SPECTRUM ANALYZER	FSP 40	100040	Jun. 28, 2008

NOTE: The calibration interval of the above test instruments is 12 months and the calibrations are traceable to NML/ROC and NIST/USA.

4.6.3 TEST PROCEDURE

The transmitter output was connected to the spectrum analyzer via a low loss cable. Set both RBW and VBW of spectrum analyzer to 100kHz and 300kHz with suitable frequency span including 100MHz bandwidth from band edge. The band edges was measured and recorded.

The spectrum plots (Peak RBW=100kHz, VBW=300kHz; Average RBW=1MHz, VBW= 10Hz) are attached on the following pages.

4.6.4 DEVIATION FROM TEST STANDARD

No deviation.

4.6.5 EUT OPERATING CONDITION

Same as 4.3.6.

4.6.6 TEST RESULTS

The spectrum plots are attached on the following 12 images. D1 line indicates the highest level, and D2 line indicates the 20dB offset below D1. It shows compliance with the requirement in part 15.247(d).

802.11b DSSS MODULATION FOR TEST MODE A

NOTE 1: The band edge emission plot on the next second page shows 47.39dBc between carrier maximum power and local maximum emission in restrict band (2.3818GHz). The emission of carrier strength list in the test result of channel 1 at the item 4.2.7 is 111.82dBuV/m (Peak), so the maximum field strength in restrict band is $111.82 - 47.39 = 64.43$ dBuV/m which is under 74dBuV/m limit.

The band edge emission plot on the next second page shows 55.73dBc between carrier maximum power and local maximum emission in restrict band (2.3900GHz). The emission of carrier strength list in the test result of channel 1 at the item 4.2.7 is 107.18dBuV/m (Peak), so the maximum field strength in restrict band is $107.18 - 55.73 = 51.45$ dBuV/m which is under 54dBuV/m limit.

NOTE 2: The band edge emission plot on the next third page shows 48.88dBc between carrier maximum power and local maximum emission in restrict band (2.4994GHz). The emission of carrier strength list in the test result of channel 11 at the item 4.2.7 is 112.38dBuV/m (Peak), so the maximum field strength in restrict band is $112.38 - 48.88 = 63.50$ dBuV/m which is under 74dBuV/m limit.

The band edge emission plot on the next fourth page shows 56.31dBc between carrier maximum power and local maximum emission in restrict band (2.4840GHz). The emission of carrier strength list in the test result of channel 11 at the item 4.2.7 is 108.26dBuV/m (Peak), so the maximum field strength in restrict band is $108.26 - 56.31 = 51.95$ dBuV/m which is under 54dBuV/m limit.

FOR TEST MODE B

NOTE 1: The band edge emission plot on the next page shows 47.39dBc between carrier maximum power and local maximum emission in restrict band (2.3818GHz). The emission of carrier strength list in the test result of channel 1 at the item 4.2.7 is 105.00dBuV/m (Peak), so the maximum field strength in restrict band is $105.00 - 47.39 = 57.61$ dBuV/m which is under 74dBuV/m limit.

The band edge emission plot on the next page shows 55.73dBc between carrier maximum power and local maximum emission in restrict band (2.3900GHz). The emission of carrier strength list in the test result of channel 1 at the item 4.2.7 is 100.34dBuV/m (Peak), so the maximum field strength in restrict band is $100.34 - 55.73 = 44.61$ dBuV/m which is under 54dBuV/m limit.

NOTE 2: The band edge emission plot on the next second page shows 48.88dBc between carrier maximum power and local maximum emission in restrict band (2.4994GHz). The emission of carrier strength list in the test result of channel 11 at the item 4.2.7 is 105.67dBuV/m (Peak), so the maximum field strength in restrict band is $105.67 - 48.88 = 56.79$ dBuV/m which is under 74dBuV/m limit.

The band edge emission plot on the next third page shows 56.31dBc between carrier maximum power and local maximum emission in restrict band (2.4840GHz). The emission of carrier strength list in the test result of channel 11 at the item 4.2.7 is 100.89dBuV/m (Peak), so the maximum field strength in restrict band is $100.89 - 56.31 = 44.58$ dBuV/m which is under 54dBuV/m limit.

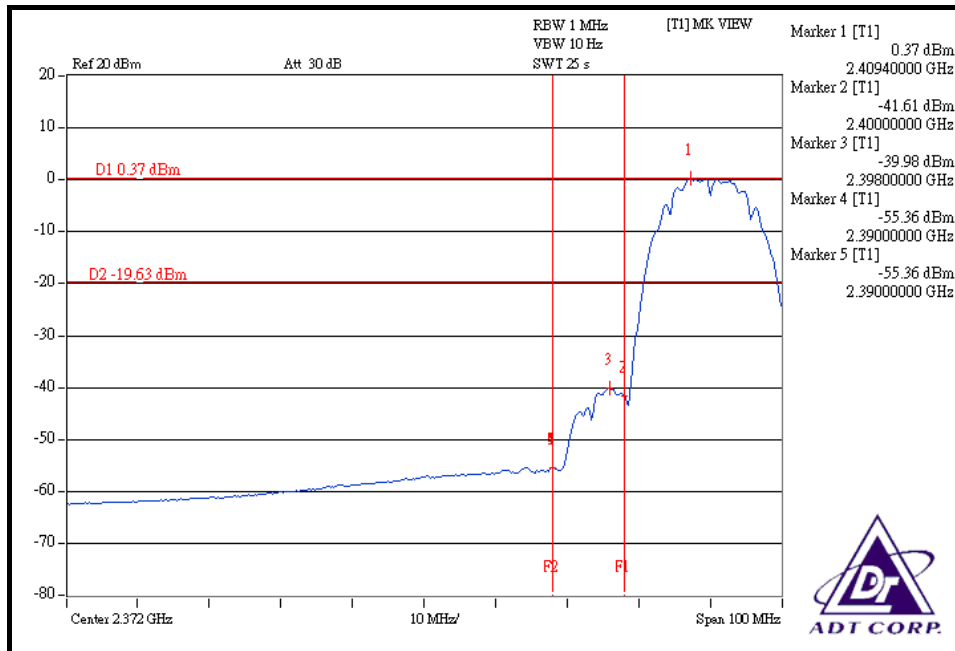
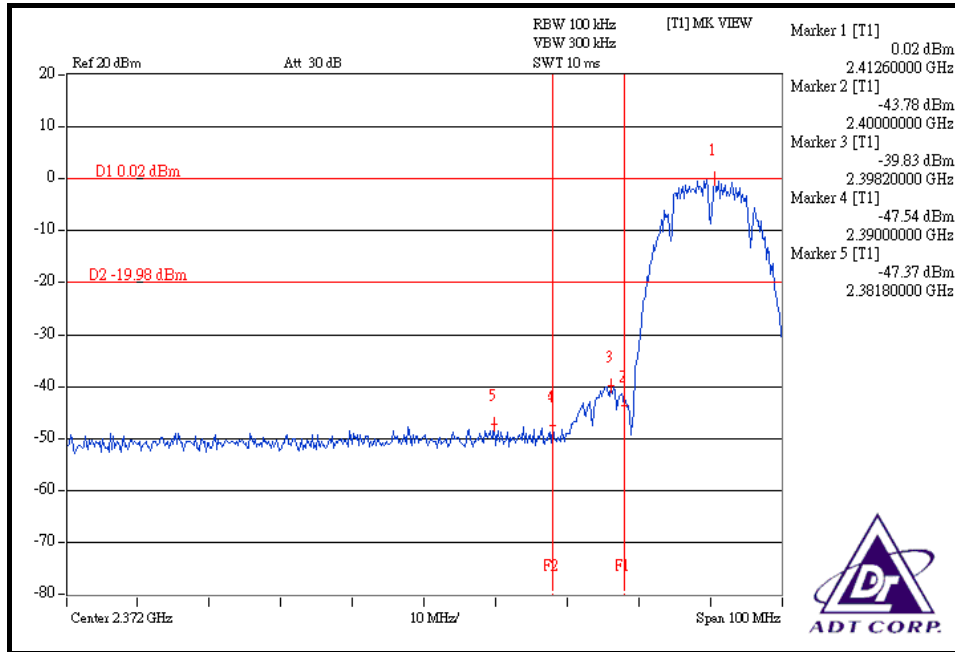

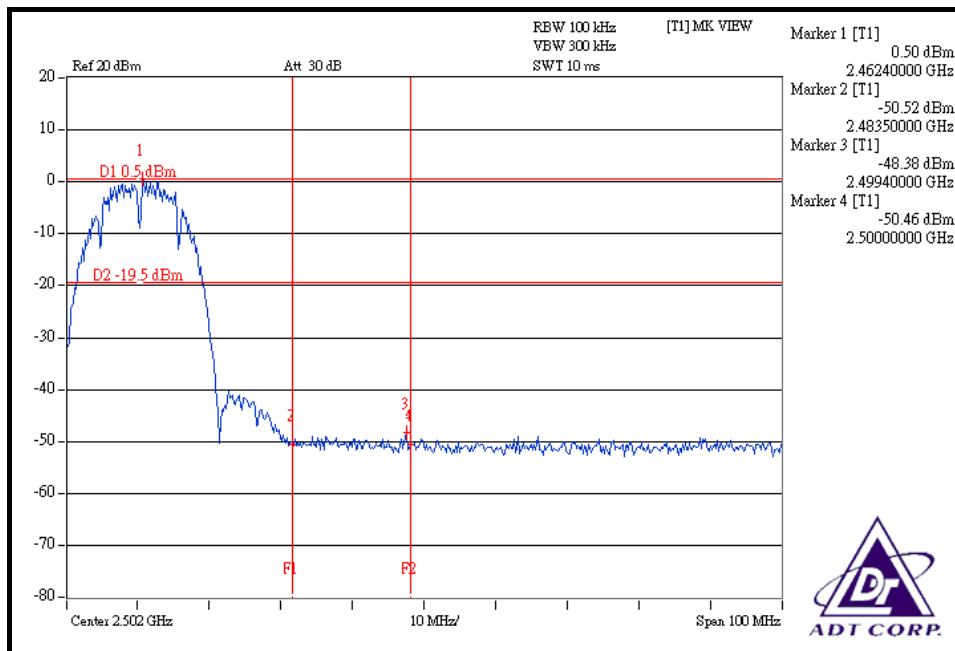
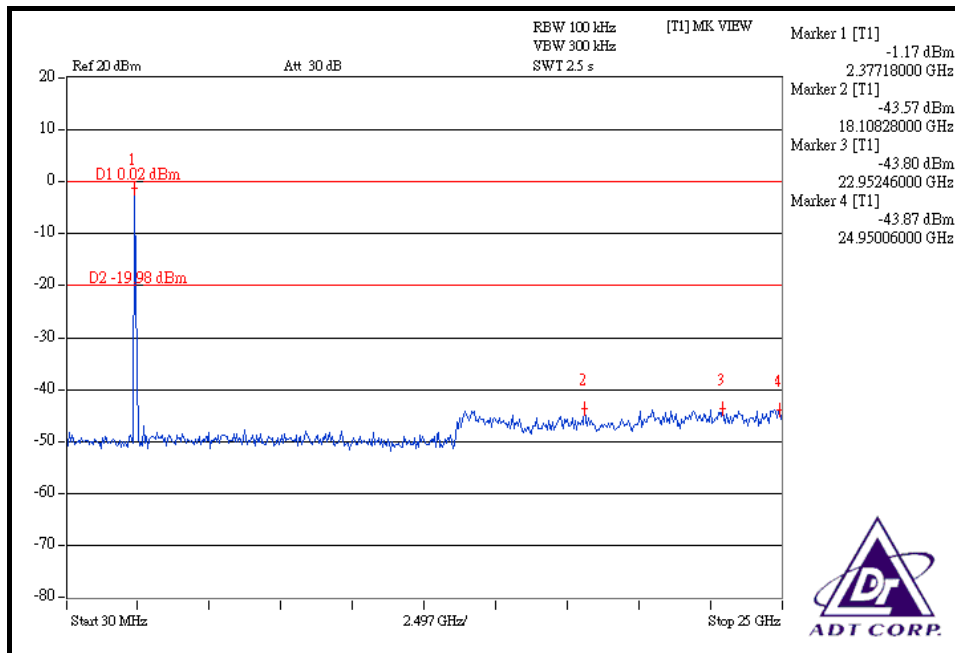

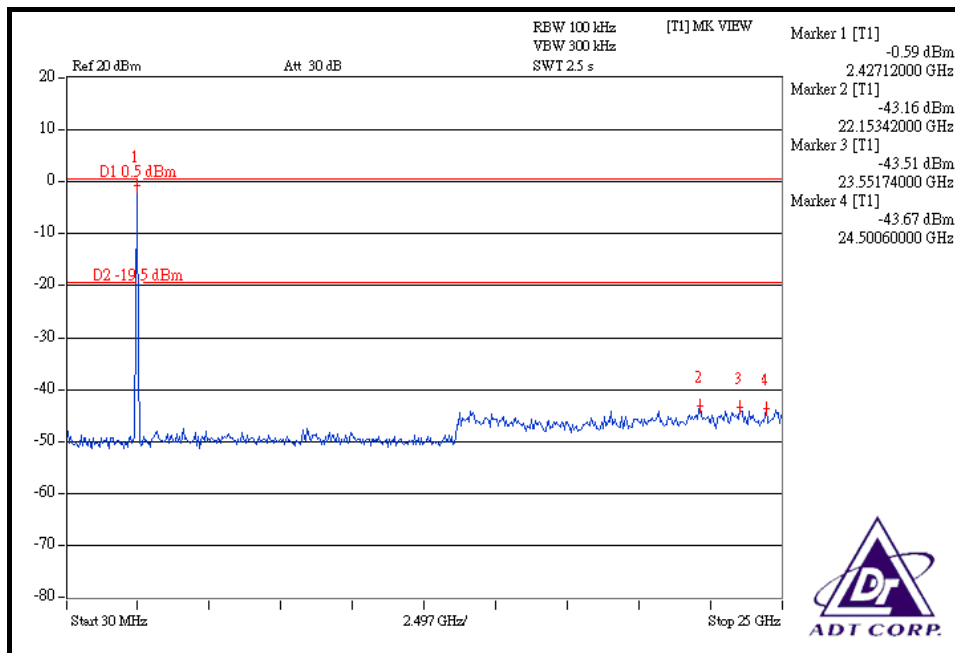
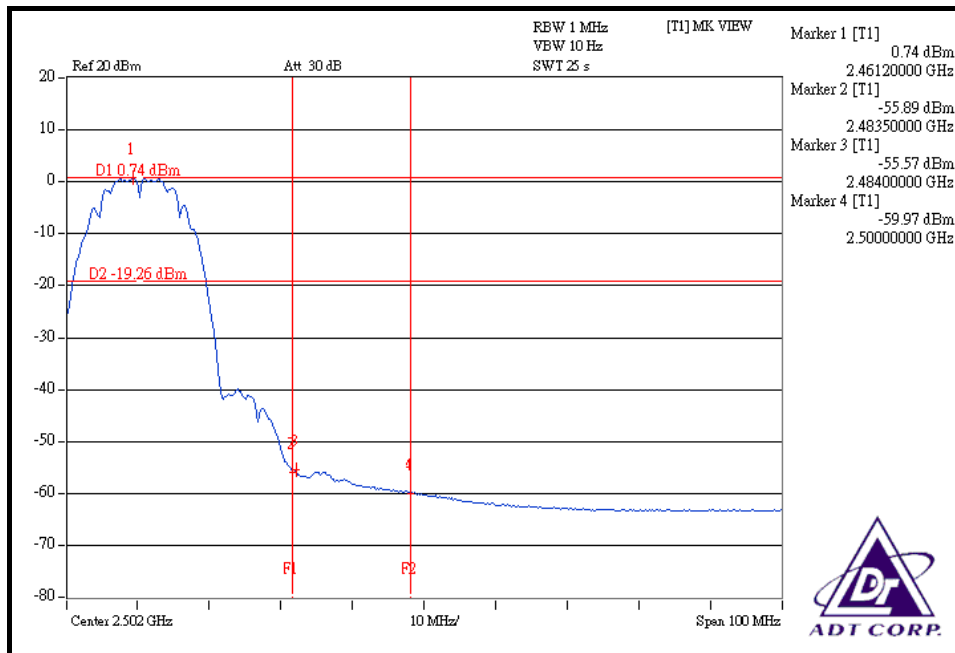



802.11g OFDM MODULATION _NORMAL MODE TEST MODE A

NOTE 1: The band edge emission plot on the next second page shows 43.39dBc between carrier maximum power and local maximum emission in restrict band (2.3790GHz). The emission of carrier strength list in the test result of channel 1 at the item 4.2.7 is 111.17dBuV/m (Peak), so the maximum field strength in restrict band is $111.17 - 43.39 = 67.78$ dBuV/m which is under 74dBuV/m limit.

The band edge emission plot on the next second page shows 48.87dBc between carrier maximum power and local maximum emission in restrict band (2.39000GHz). The emission of carrier strength list in the test result of channel 1 at the item 4.2.7 is 101.02dBuV/m (Peak), so the maximum field strength in restrict band is $101.02 - 48.87 = 52.15$ dBuV/m which is under 54dBuV/m limit.

NOTE 2: The band edge emission plot on the next third page shows 43.18dBc between carrier maximum power and local maximum emission in restrict band (2.4842GHz). The emission of carrier strength list in the test result of channel 11 at the item 4.2.7 is 111.77 dBuV/m (Peak), so the maximum field strength in restrict band is $111.77 - 43.18 = 68.59$ dBuV/m which is under 74dBuV/m limit.

The band edge emission plot on the next fourth page shows 48.95Bc between carrier maximum power and local maximum emission in restrict band (2.4835GHz). The emission of carrier strength list in the test result of channel 11 at the item 4.2.7 is 101.75dBuV/m (Peak), so the maximum field strength in restrict band is $101.75 - 48.95 = 52.80$ dBuV/m which is under 54dBuV/m limit.

FOR TEST MODE B

NOTE 1: The band edge emission plot on the next page shows 43.39dBc between carrier maximum power and local maximum emission in restrict band (2.3790GHz). The emission of carrier strength list in the test result of channel 1 at the item 4.2.7 is 102.67dBuV/m (Peak), so the maximum field strength in restrict band is $102.67 - 43.39 = 59.28$ dBuV/m which is under 74dBuV/m limit.

The band edge emission plot on the next page shows 48.87dBc between carrier maximum power and local maximum emission in restrict band (2.39000GHz). The emission of carrier strength list in the test result of channel 1 at the item 4.2.7 is 92.78dBuV/m (Peak), so the maximum field strength in restrict band is $92.78 - 48.87 = 43.91$ dBuV/m which is under 54dBuV/m limit.

NOTE 2: The band edge emission plot on the next second page shows 43.18dBc between carrier maximum power and local maximum emission in restrict band (2.4842GHz). The emission of carrier strength list in the test result of channel 11 at the item 4.2.7 is 103.21 dBuV/m (Peak), so the maximum field strength in restrict band is $103.21 - 43.18 = 60.03$ dBuV/m which is under 74dBuV/m limit.

The band edge emission plot on the next third page shows 48.95Bc between carrier maximum power and local maximum emission in restrict band (2.4835GHz). The emission of carrier strength list in the test result of channel 11 at the item 4.2.7 is 93.18dBuV/m (Peak), so the maximum field strength in restrict band is $93.18 - 48.95 = 44.23$ dBuV/m which is under 54dBuV/m limit.

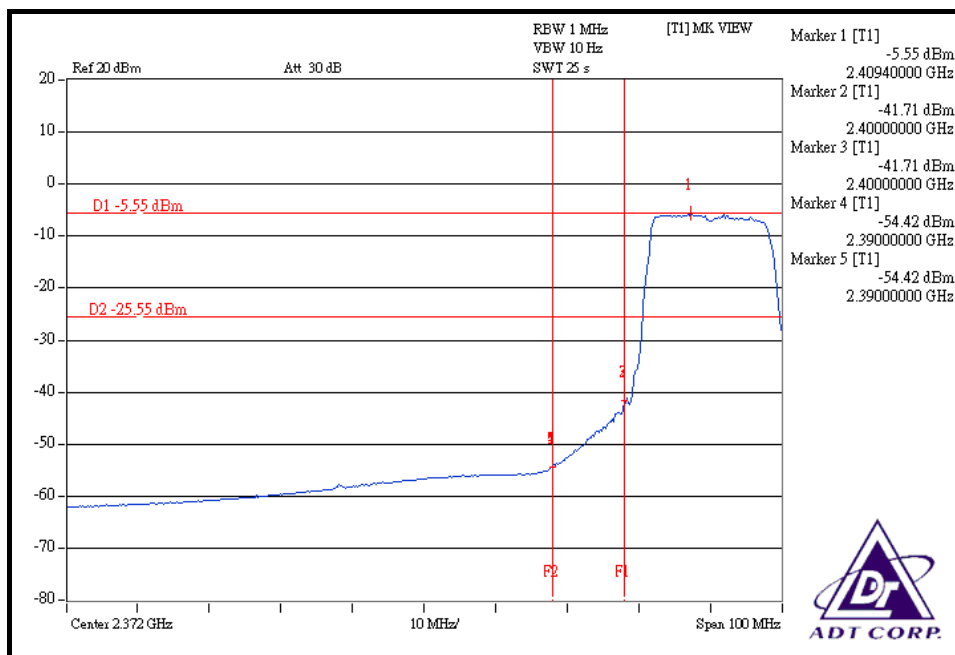
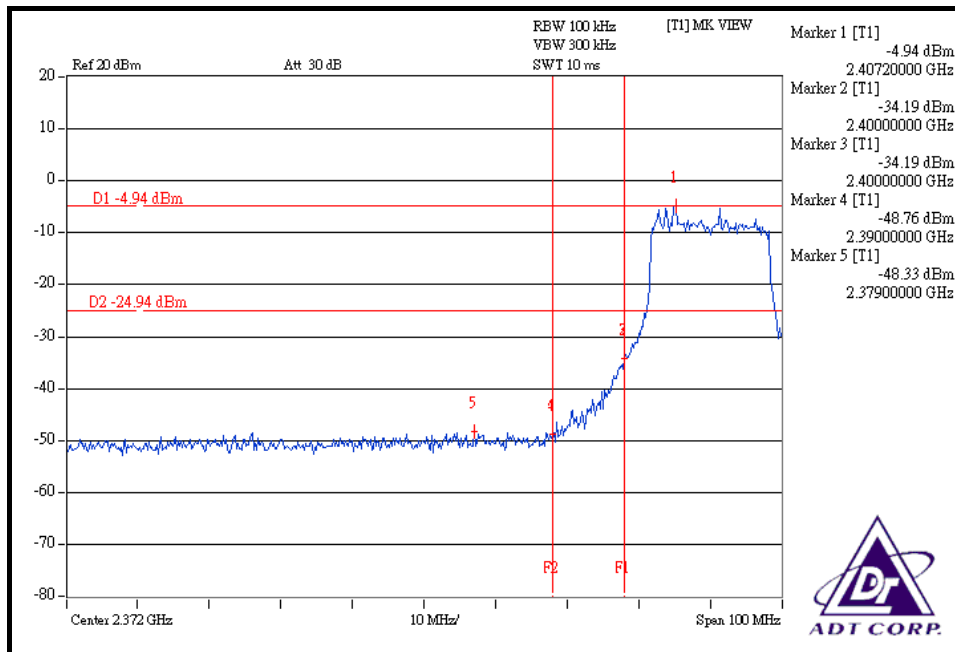

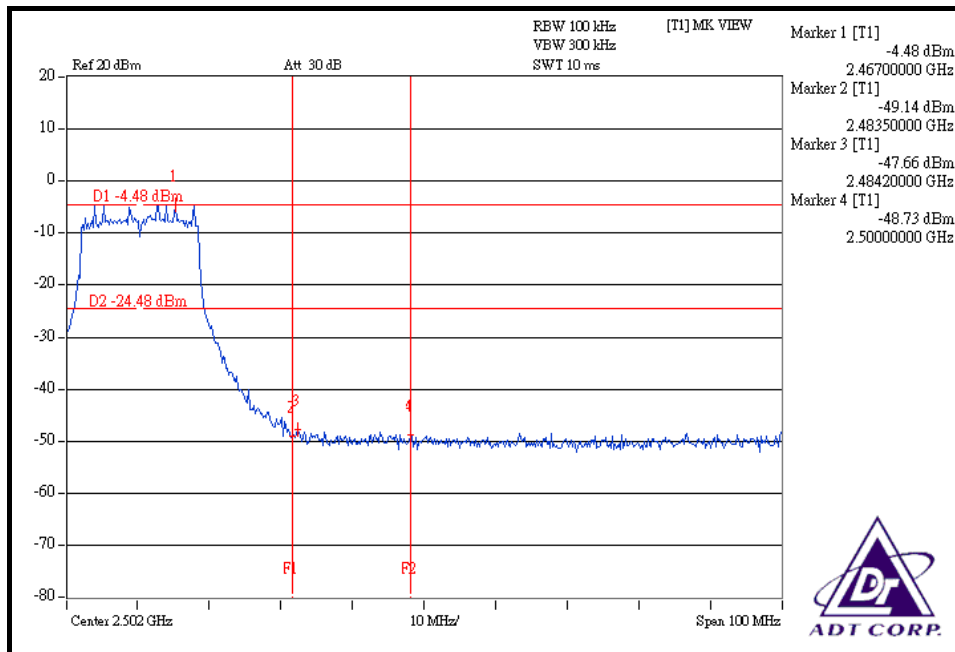
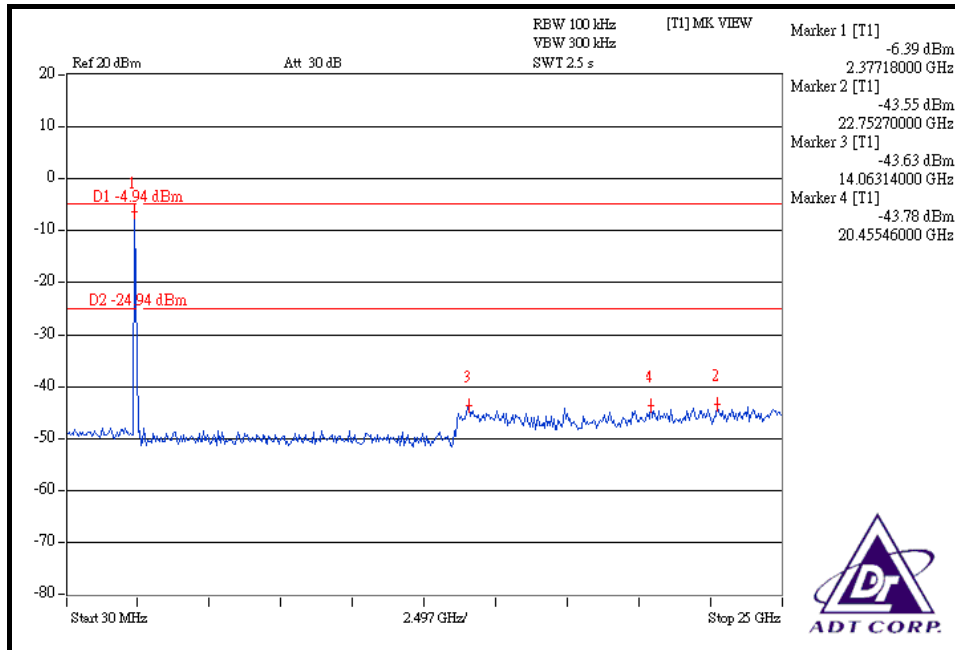

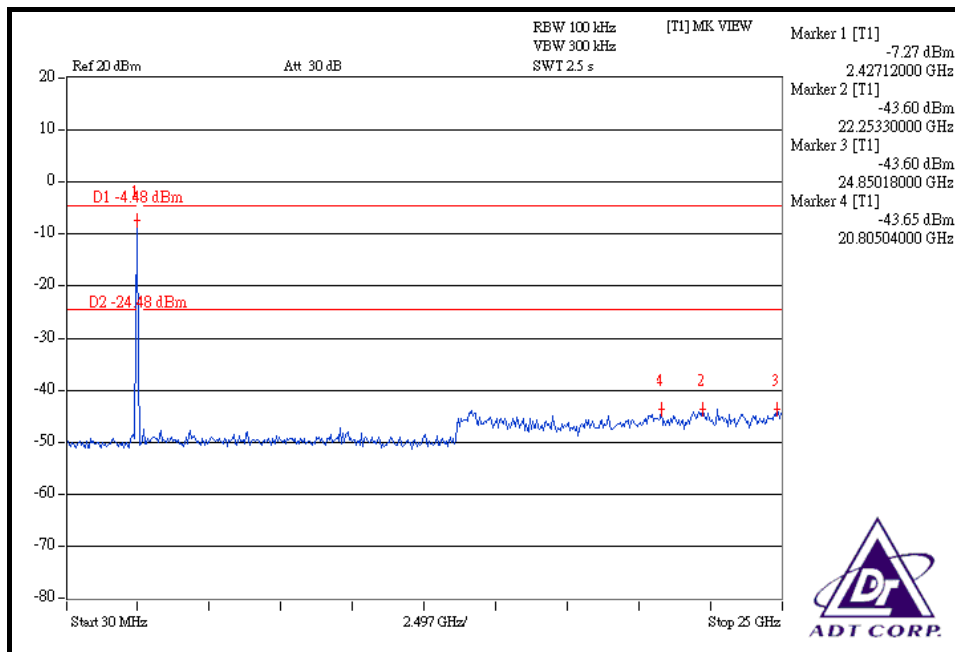
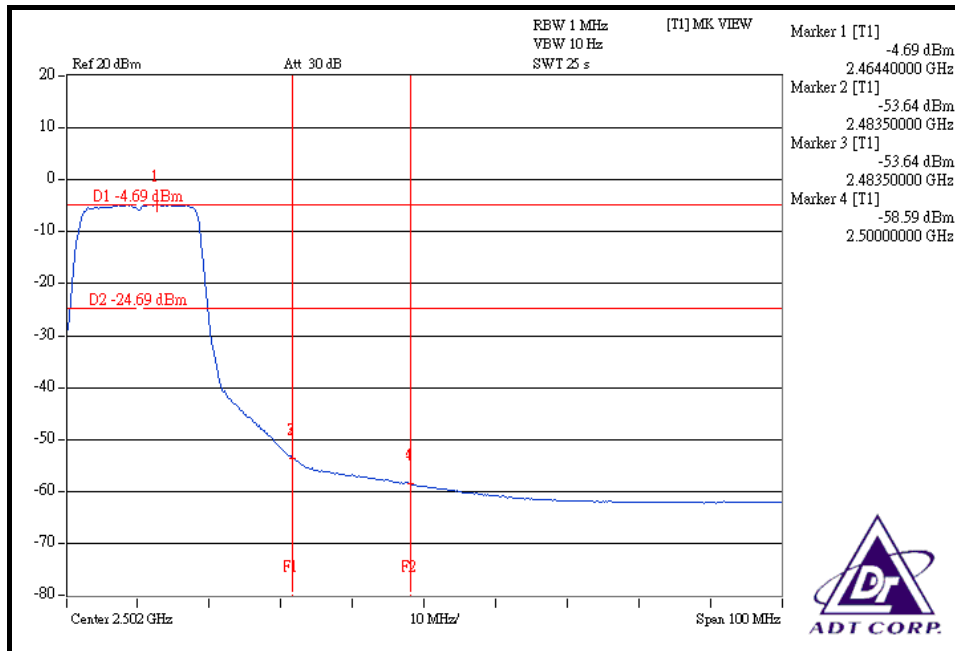

802.11g OFDM MODULATION _TURBO MODE

TEST MODE A

NOTE 1: The band edge emission plot on the next second page shows 45.54dBc between carrier maximum power and local maximum emission in restrict band (2.3790GHz). The emission of carrier strength list in the test result of channel 6 at the item 4.2.7 is 110.85dBuV/m (Peak), so the maximum field strength in restrict band is $110.85 - 45.54 = 65.31$ dBuV/m which is under 74dBuV/m limit.

The band edge emission plot on the next second page shows 50.31dBc between carrier maximum power and local maximum emission in restrict band (2.3900GHz). The emission of carrier strength list in the test result of channel 6 at the item 4.2.7 is 101.32dBuV/m (Peak), so the maximum field strength in restrict band is $101.32 - 50.31 = 51.01$ dBuV/m which is under 54dBuV/m limit.

NOTE 2: The band edge emission plot on the next third page shows 44.70dBc between carrier maximum power and local maximum emission in restrict band (2.4916GHz). The emission of carrier strength list in the test result of channel 6 at the item 4.2.7 is 111.77 dBuV/m (Peak), so the maximum field strength in restrict band is $110.85 - 44.70 = 66.15$ dBuV/m which is under 74dBuV/m limit.

The band edge emission plot on the next fourth page shows 48.57dBc between carrier maximum power and local maximum emission in restrict band (2.4835GHz). The emission of carrier strength list in the test result of channel 6 at the item 4.2.7 is 101.32dBuV/m (Peak), so the maximum field strength in restrict band is $101.32 - 48.57 = 52.75$ dBuV/m which is under 54dBuV/m limit.

FOR TEST MODE B

NOTE 1: The band edge emission plot on the next page shows 45.54dBc between carrier maximum power and local maximum emission in restrict band (2.3790GHz). The emission of carrier strength list in the test result of channel 6 at the item 4.2.7 is 106.11dBuV/m (Peak), so the maximum field strength in restrict band is $106.11 - 45.54 = 60.57$ dBuV/m which is under 74dBuV/m limit.

The band edge emission plot on the next page shows 50.31dBc between carrier maximum power and local maximum emission in restrict band (2.3900GHz). The emission of carrier strength list in the test result of channel 6 at the item 4.2.7 is 96.62dBuV/m (Peak), so the maximum field strength in restrict band is $96.62 - 50.31 = 46.31$ dBuV/m which is under 54dBuV/m limit.

NOTE 2: The band edge emission plot on the next second page shows 44.70dBc between carrier maximum power and local maximum emission in restrict band (2.4916GHz). The emission of carrier strength list in the test result of channel 6 at the item 4.2.7 is 106.11 dBuV/m (Peak), so the maximum field strength in restrict band is $106.11 - 44.70 = 61.41$ dBuV/m which is under 74dBuV/m limit.

The band edge emission plot on the next third page shows 48.57dBc between carrier maximum power and local maximum emission in restrict band (2.4835GHz). The emission of carrier strength list in the test result of channel 6 at the item 4.2.7 is 96.62dBuV/m (Peak), so the maximum field strength in restrict band is $96.62 - 48.57 = 48.05$ dBuV/m which is under 54dBuV/m limit.

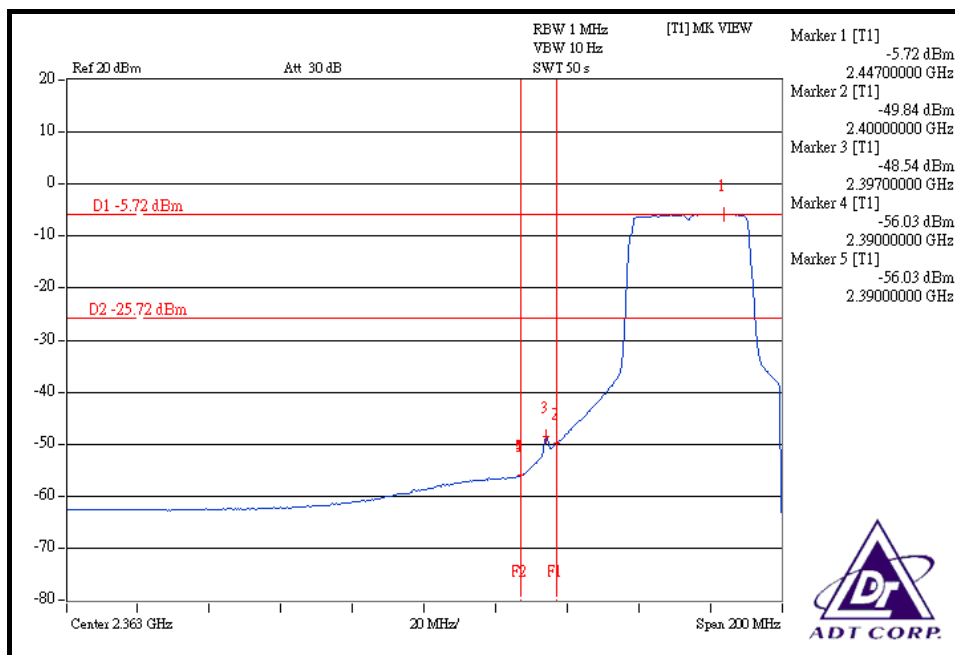
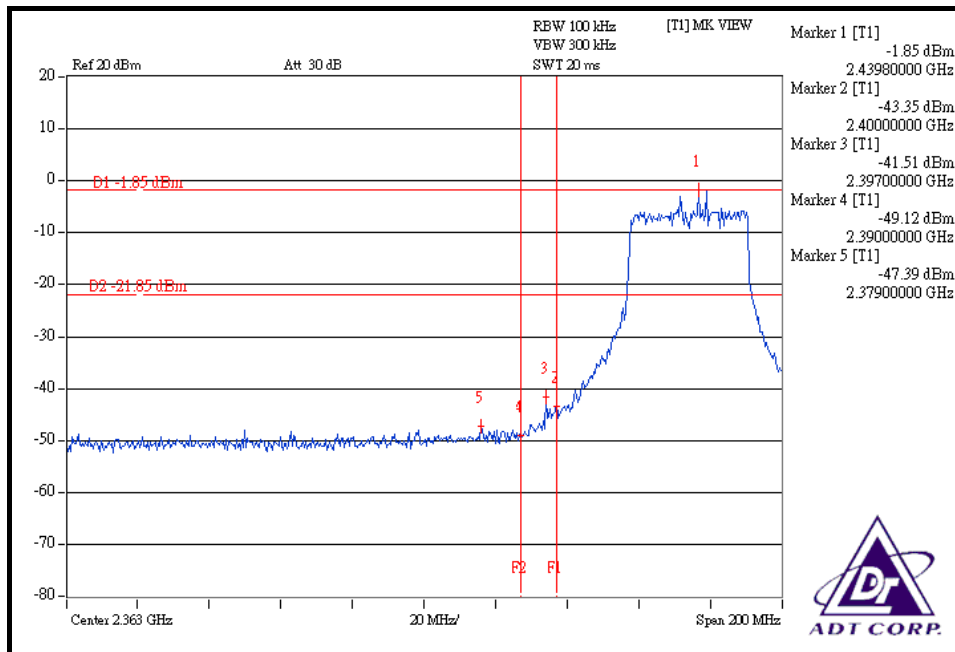

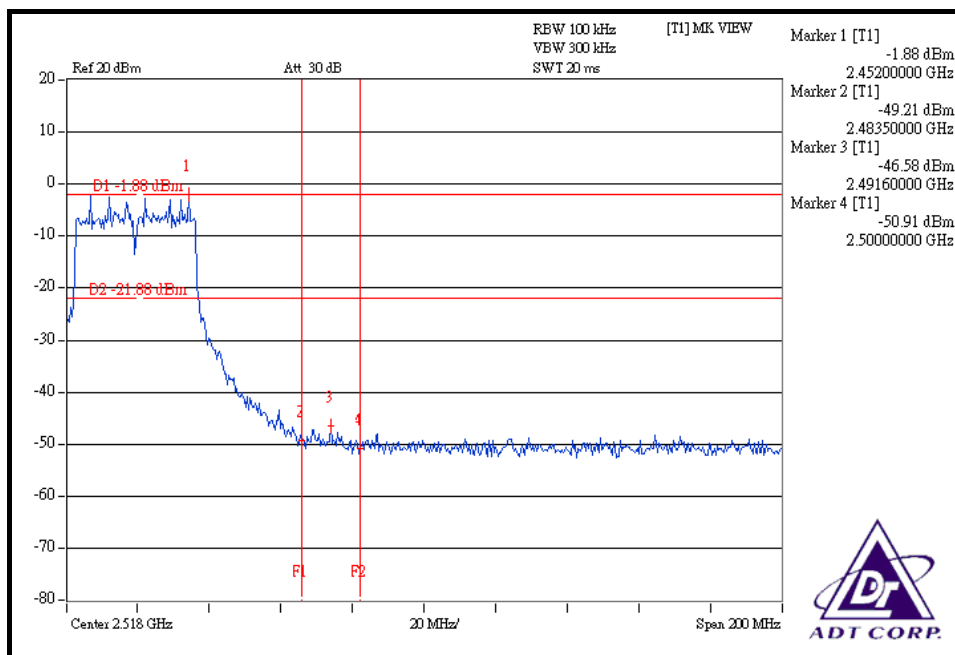
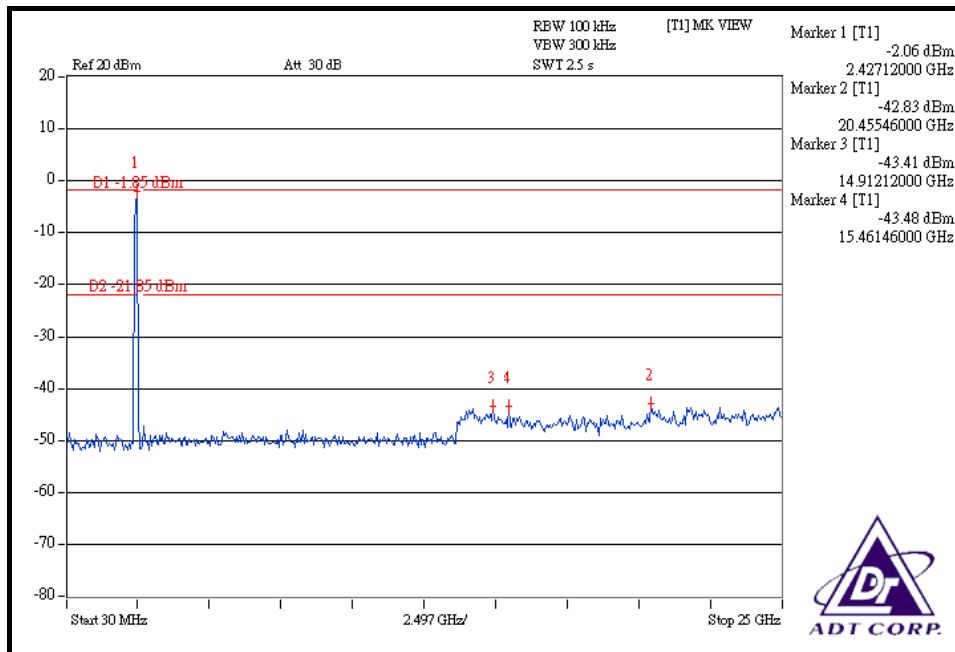

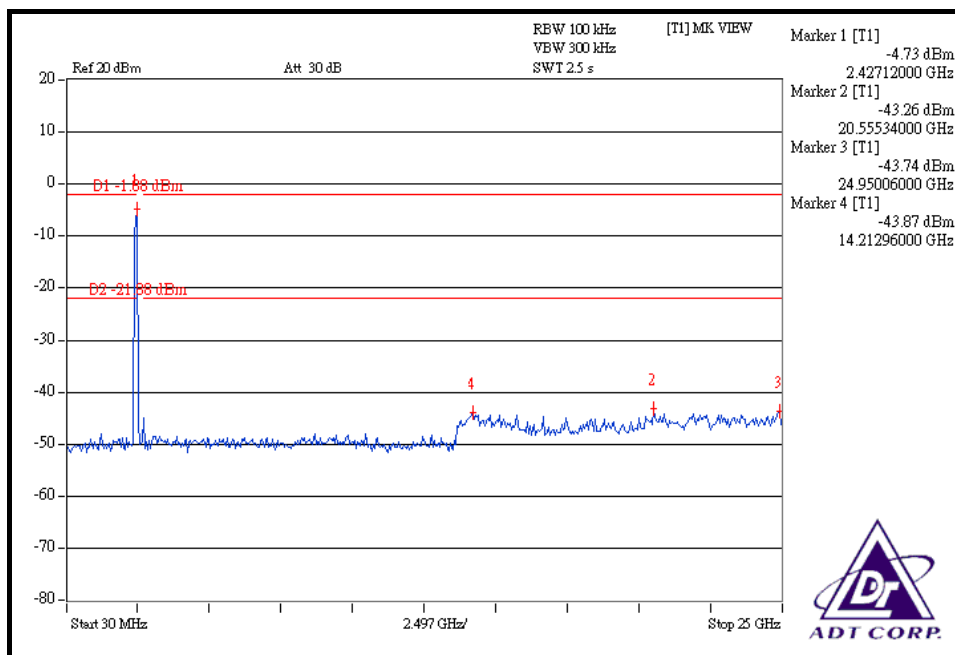
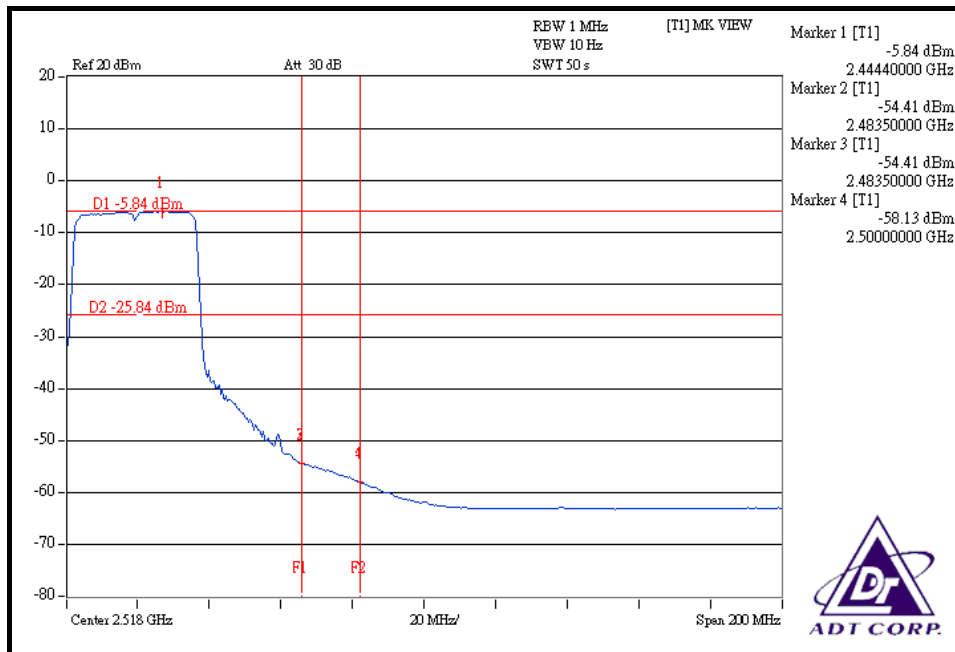

4.7 ANTENNA REQUIREMENT

4.7.1 STANDARD APPLICABLE

For intentional device, according to FCC 47 CFR Section 15.203, an intentional radiator shall be designed to ensure that no antenna other than that furnished by the responsible party shall be used with the device.

And according to FCC 47 CFR Section 15.247 (b), if transmitting antennas of directional gain greater than 6dBi are used, the power shall be reduced by the amount in dB that the directional gain of the antenna exceeds 6dBi.

4.7.2 ANTENNA CONNECTED CONSTRUCTION

The antennas used in this product are Panel antenna without connector and Omni-directional antenna with N type antenna connector. The maximum Gain of the antenna is 9dBi.



5 PHOTOGRAPHS OF THE TEST CONFIGURATION

Please refer to the attached file (Test Setup Photo).



6 INFORMATION ON THE TESTING LABORATORIES

We, ADT Corp., were founded in 1988 to provide our best service in EMC, Radio, Telecom and Safety consultation. Our laboratories are accredited and approved by the following approval agencies according to ISO/IEC 17025.

USA	FCC, UL, A2LA
Germany	TUV Rheinland
Japan	VCCI
Norway	NEMKO
Canada	INDUSTRY CANADA , CSA
R.O.C.	TAF, BSMI, NCC
Netherlands	Telefication
Singapore	GOST-ASIA(MOU)
Russia	CERTIS(MOU)

Copies of accreditation certificates of our laboratories obtained from approval agencies can be downloaded from our web site: www.adt.com.tw/index.5/phtml. If you have any comments, please feel free to contact us at the following:

Linko EMC/RF Lab

Tel: 886-2-26052180
Fax: 886-2-26051924

Hsin Chu EMC/RF Lab

Tel: 886-3-5935343
Fax: 886-3-5935342

Hwa Ya EMC/RF/Safety/Telecom Lab

Tel: 886-3-3183232
Fax: 886-3-3185050

Web Site: www.adt.com.tw

The address and road map of all our labs can be found in our web site also.

7 APPENDIX A – MODIFICATIONS RECORDERS FOR ENGINEERING CHANGES TO THE EUT BY THE LAB

No any modifications are made to the EUT by the lab during the test.