



## TEST REPORT

**Report Number: 0233002U2.doc**

**Project Number: 3033002**

**October 31, 2002**

**Evaluation of the  
Dual Band GSM Cellular Phone**

**Model Number: T316**

**FCC ID: PXITR-G1202**

**IC: 4170A-G1202**

**to**

**FCC Part 15**

**FCC Part 22 Subpart H**

**FCC Part 24 Subpart E**

**IC RSS-128**

**IC RSS-133**

**For**

**Sony Ericsson Mobile Communications Inc.**

Test Performed by:

Intertek Testing Services  
1950 Evergreen Blvd, Suite 100  
Duluth, GA 30096

Test Authorized by:

Sony Ericsson Mobile Communications Inc.  
7001 Development Drive  
Research Triangle Park, NC 27709

Prepared by:

Jeffrey D. Hiday, Senior Project Engineer

Date: 10/31/02

Reviewed by:

David J. Schramm, EMC Team Leader

Date: 10/31/02

*All services undertaken are subject to the following general policy: Reports are submitted for exclusive use of the client to whom they are addressed. Their significance is subject to the adequacy and representative character of the samples and to the comprehensiveness of the tests, examinations or surveys made. This report shall not be reproduced except in full, without written consent of Intertek Testing Services NA Inc. This report must not be used to claim product endorsement by A2LA, NIST nor any other agency of the U.S. Government.*

**TABLE OF CONTENTS**

**EXECUTIVE SUMMARY ..... 4**

**1 JOB DESCRIPTION..... 5**

1.1 CLIENT INFORMATION.....5

1.2 TEST PLAN REFERENCE:.....5

1.3 EQUIPMENT UNDER TEST (EUT) .....6

    1.3.1 System Support Equipment..... 7

    1.3.2 Cables associated with EUT..... 7

    1.3.3 System Block Diagram..... 7

    1.3.4 Justification..... 8

    1.3.5 Mode(s) of operation..... 8

1.4 MODIFICATIONS REQUIRED FOR COMPLIANCE .....8

1.5 RELATED SUBMITTAL(S) GRANTS.....8

**2 TEST FACILITY..... 9**

**3 CONDUCTED RF POWER..... 10**

3.1 TEST PROCEDURE..... 10

3.2 TEST EQUIPMENT ..... 10

3.3 TEST RESULTS..... 10

**4 RADIATED RF POWER..... 12**

4.1 TEST PROCEDURE..... 12

4.2 TEST EQUIPMENT ..... 12

4.3 TEST RESULTS..... 13

**5 EMISSION LIMITATIONS, OCCUPIED BANDWIDTH..... 14**

5.1 TEST PROCEDURE..... 14

5.2 TEST EQUIPMENT ..... 14

5.3 TEST RESULTS..... 15

**6 OUT OF BAND EMISSION AT ANTENNA TERMINALS ..... 16**

6.1 TEST PROCEDURE..... 16

6.2 TEST EQUIPMENT ..... 16

6.3 TEST RESULTS..... 17

**7 FIELD STRENGTH OF SPURIOUS RADIATION ..... 23**

7.1 TEST PROCEDURE..... 23

7.2 TEST EQUIPMENT ..... 23

7.3 TEST RESULTS..... 23

**8 POWER LINE CONDUCTED EMISSIONS..... 25**

8.1 TEST PROCEDURE..... 25

8.2 TEST EQUIPMENT ..... 25

8.3 TEST RESULTS..... 25

8.4 TEST CONFIGURATION PHOTOGRAPH..... 27

**9 FREQUENCY STABILITY VS TEMPERATURE..... 29**

9.1 TEST PROCEDURE..... 29

# Intertek Testing Services

---

9.2	TEST EQUIPMENT .....	29
9.3	TEST RESULTS .....	29
<b>10</b>	<b>FREQUENCY STABILITY VS VOLTAGE .....</b>	<b>31</b>
10.1	TEST PROCEDURE.....	31
10.2	TEST EQUIPMENT .....	31
10.3	TEST RESULTS .....	31
<b>11</b>	<b>RECEIVER SPURIOUS EMISSIONS.....</b>	<b>33</b>
11.1	TEST LIMITS.....	33
11.2	TEST EQUIPMENT .....	33
11.3	TEST PROCEDURE.....	33
11.4	TEST RESULTS .....	34
11.5	TEST CONFIGURATION PHOTOGRAPH.....	35

## Executive Summary

Testing performed for: Sony Ericsson Mobile Communications Inc.

Equipment Under Test: T316, Dual Band GSM Cellular Phone

FCC RULE	IC RULE	DESCRIPTION OF TEST	RESULT	PAGE
§2.1046	RSS-128 §7.1 RSS-133 §6.2	RF Power Output	Passed	10
§22.913, §24.232	RSS-128 §7.1 RSS-133 §6.2	ERP, EIRP	Passed	13
§2.1049 §22.917(b)(d)	RSS-128 §7.4	Emission Limitation, Occupied Bandwidth	Passed	14
§2.1051 §22.917(e) §22.917(f) §24.238(a)	RSS-128 §7.4 RSS-133 §6.3	Out of Band Emissions at Antenna Terminals  Mobile Emissions In Base Frequency Range	Passed	16
§2.1053	RSS-128 §7.4 RSS-133 §6.3	Field Strength of Spurious Radiation	Passed	23
§15.107, §15.207	IC ES-003	Power Line Conducted Emissions	Passed	25
§2.1055, §22.355, §24.235	RSS-128 §9 RSS-133 §7	Frequency Stability vs. Temperature	Passed	29
§2.1055, §22.355, §24.235	RSS-128 §9 RSS-133 §7	Frequency Stability vs. Voltage	Passed	31
§2.1091, §2.1093	RSS-128 §21, RSS-133 §8	Specific Absorption Rate	N/S	See Note <sup>1</sup>
§15.109	IC ES-003 RSS-128 §9, RSS-133 §9	Receiver Spurious Emission	Passed	33

N/S: Not under scope of this evaluation

---

<sup>1</sup> Specific Absorption Rate testing was not under the scope of this evaluation.

## 1 JOB DESCRIPTION

### 1.1 Client information

The Dual Band GSM Cellular Phone has been tested at the request of

**Company:** Sony Ericsson Mobile Communications Inc.  
7001 Development Drive  
Research Triangle Park, NC 27709

**Name of contact:** Pierre Chery  
**Telephone:** 919-472-1697  
**Fax:** 919-472-6382

### 1.2 Test plan reference:

Tests were performed to the following standards:

- FCC Part 15
- FCC Part 22 Subpart H rules for an intentional radiator
- FCC Part 24 Subpart E rules for an intentional radiator
- IC RSS-128
- IC RSS-133

The test procedures described in this test report and ANSI C63.4: 1992 were employed.

# Intertek Testing Services

---

## 1.3 Equipment Under Test (EUT)

Product	Dual Band GSM Cellular Phone
EUT Model Number	T316
EUT Serial Number	A6101TS43K and A6101TS41W (for conducted test)
Whether quantity (>1) production is planned	Quantity production is planned.
Cellular Phone standards	GSM800 and GSM1900
Type(s) of Emission	255KGXW
RF Output Power	824-849 MHz: 29.3 dBm – GSM800 1850-1910 MHz: 30.1 dBm – GSM1900
Frequency Range	824 – 849 GSM800
	1850 – 1910 GSM1900
Antenna & Gain	Integrated, non-retractable
Detachable Antenna ?	No

EUT receive date: October 15, 2002  
EUT receive condition: The EUT was received in good condition with no apparent damage.  
Test start date: October 15, 2002  
Test completion date: October 30, 2002

The test results in this report pertain only to the item tested.

### 1.3.1 System Support Equipment

Table 1-1 contains the details of the support equipment associated with the Equipment Under Test during the FCC Part 15 and ICES-003 testing.

*Table 1-1: System Support Equipment*

Description	Manufacturer	Model Number	Serial Number	FCC ID number
Hands-free accessory	Sony Ericsson	RLF 501 25/03	Not labeled	Not labeled
Home charging base	Sony Ericsson	Type 402 0068-US BML 162 1029 R1A CST-12	0111	Not labeled

### 1.3.2 Cables associated with EUT

Table 1-2 contains the details of the cables associated with the EUT.

*Table 1-2: Interconnecting cables between modules of EUT*

Cables					
Description	Length	Shielding	Ferrites	Connection	
				From	To
Adapter cable	2m	None	None	EUT	Charging adapter
Hands free	1.2m	None	None	EUT	Ear piece

### 1.3.3 System Block Diagram

The diagram shown below details the interconnection of the EUT and its accessories during FCC Part 15 testing. For specific layout, refer to the test configuration photograph in the relevant section of this report.

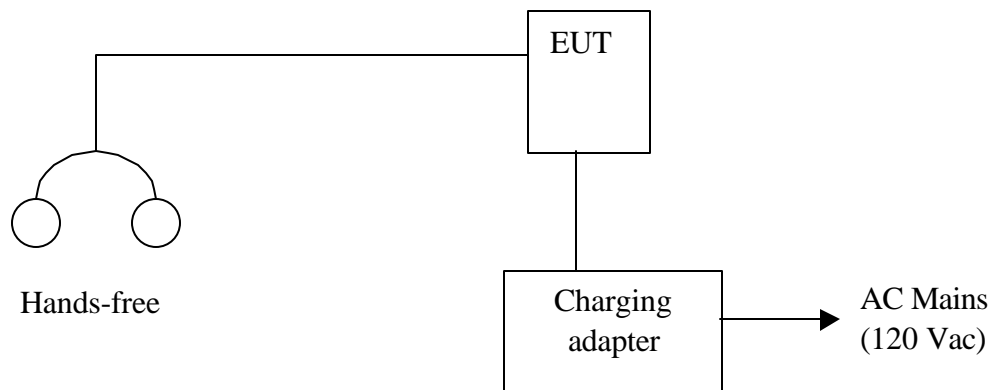

### **1.3.4 Justification**

The EUT was operated in the stand-alone configuration.

### **1.3.5 Mode(s) of operation**

The EUT was powered from 3.8 Vdc. For the radiated transmitter power and radiated transmitter spurious emissions, a fully charged battery was used. For antenna port measurements, the 3.8 Vdc was supplied by a bench top power supply. The EUT was set to the GSM800, or GSM1900 mode during testing.

### **1.4 Modifications required for compliance**

No modifications were implemented by Intertek Testing Services.

### **1.5 Related Submittal(s) Grants**

None



## 2 TEST FACILITY

The ITS-Duluth site is located at 1950 Evergreen Blvd., Suite 100, Duluth, Georgia. The radiated emission test site is a 10-meter semi-anechoic chamber. The chamber meets the characteristics of CISPR 16-1: 1993 and ANSI C63.4: 1992. For measurements, a remotely controlled flush-mount metal-top turntable is used to rotate the EUT a full 360 degrees. A remote controlled non-conductive antenna mast is used to scan the antenna height from one to four meters.

This site is on file with the FCC.

The Industry Canada file number for this site is IC 2077.

**3 CONDUCTED RF POWER**

FCC §2.1046, RSS-128, RSS-133

**3.1 Test Procedure**

The transmitter output was connected to a calibrated coaxial attenuator, the other end of which was connected to a power meter. Transmitter output was read off the power meter in dBm. The power output at the transmitter antenna port was determined by adding the value of the attenuator to the power meter reading.

Tests were performed at three frequencies (low, middle, and high channels) and on the highest power levels, which can be setup on the transmitters.

**3.2 Test Equipment**

Description	Manufacturer	Model Number	Serial Number	Calibration due date
Power meter	HP	436A	1930A05553	3/29/03
Power sensor	HP	8481A	173690	3/29/03
Attenuator	Weinschel	2 (10 dB)	BK2313	5/6/03

**3.3 Test Results**

The Dual Band GSM Cellular Phone met the RF power output requirements of FCC Part 22 Subpart H, FCC Part 24 Subpart E, RSS-128, and RSS-133. The test results are located in Table 3-1 and Table 3-2.

*Table 3-1 Conducted RF Power*

EUT Mode	Frequency MHz	Channel	Measured Power dBm
GSM800	824.2	128	29.1
	936.4	189	29.2
	848.8	251	29.3
GSM1900	1850.2	512	30.1
	1880.0	661	29.8
	1909.80	810	29.7

*Table 3-2 RF Power Variation with temperature*

EUT Mode	Frequency MHz	Channel	Measured Power DBm		
			+60°C	+20°C	-30°C
GSM800	824.2	128	28.6	29.1	29.2
	936.4	189	28.6	29.3	29.3
	848.8	251	28.8	29.2	29.4
GSM1900	1850.2	512	29.3	29.8	30.4
	1880.0	661	29.2	29.8	30.4
	1909.80	810	29.2	29.7	30.0

**4 RADIATED RF POWER**

FCC §22.913 and IC RSS-128 §7.1 and §9.1: The Effective Radiated Power (ERP) of mobile transmitters and auxiliary test transmitters must not exceed 7 Watts.

FCC §24.232 and IC RSS-133 §6.2: The equivalent Isotropic Radiated Power (EIRP) must not exceed 2 Watts.

**4.1 Test Procedure**

The EUT was placed on a non-conductive turntable with the earpiece attached. The earpiece was extended vertically above the EUT using a non-conductive support. The radiated emission at the fundamental frequency was measured at 3m with a test antenna and EMI receiver.

During the measurement of the EUT, the receiver resolution bandwidth was set to 3 MHz and the average bandwidth was set to 10 kHz. These settings matched the power readings of a power meter with a thermocouple power sensor. The highest emission was recorded with the rotation of the turntable and the raising and lowering of the test antenna. The receiver reading was recorded and the field strength (E in dBμV/m) was calculated.

ERP in frequency band 824-849 MHz, and EIRP in frequency band 1851.25-1910 MHz were measured using a substitution method. The EUT was replaced by half-wave dipole (824-849 MHz) or horn antenna (1851.25-1910 MHz) connected to a signal generator, which was set to approximately -10 dBm. The spectrum analyzer reading was recorded and ERP/EIRP was calculated as follows:

$$ERP = E_1 - E_2 + V_g$$

$$EIRP = E_1 - E_2 + V_g + G$$

where,

$E_1$  is the receiver reading in dBμV/m when measuring the field strength of the EUT

$E_2$  is the receiver reading in dBμV/m when measured field strength from the generator

$V_g$  is the generator output in dBm

$G$  is the gain of the transmitting antenna in dBi.

**4.2 Test Equipment**

Description	Manufacturer	Model Number	Serial Number	Calibration due date
Power Meter	HP	436A	1930A05553	3/29/03
Power Sensor	HP	8481A	173690	3/29/03
Signal Generator	HP	83620B	3722A00537	2/11/03
Dipole Antenna	CDI	A100	R4	9/6/03
Horn Antenna	A.H. Systems	SAS-200/571	246	1/13/03
Receive Antenna	Schaffner-Chase	CBL6112B	2622	8/14/03
EMI Receiver	HP	8546A	3410A00173/ 3448A00203	3/28/03
Attenuator	Weinschel	2 (10dB)	BK2313	5/6/03

# Intertek Testing Services

---

## 4.3 Test Results

The Dual Band GSM Cellular Phone met the radiated power requirements of FCC §22.913, FCC §24.232, RSS-128, and RSS-133. The test results are located in Table 4-1.

*Table 4-1 Radiated RF Power*

EUT Mode	Measurement Method	Frequency MHz	Channel	Measured Power dBm
GSM800	ERP	824.2	128	26.9
	ERP	936.4	189	28.2
	ERP	848.8	251	29.3
GSM1900	EIRP	1850.2	512	28.2
	EIRP	1880.0	661	26.4
	EIRP	1909.80	810	27.5

## 5 EMISSION LIMITATIONS, OCCUPIED BANDWIDTH

CFR 47 §2.1049, §22.917(b)(d), RSS-128

For F3E/F3D emission mask uses with audio filter, the mean power of emissions must be attenuated below the mean power of the unmodulated carrier wave (P) as follows:

- On any frequency removed from the carrier frequency by more than 20 kHz but not more than 45 kHz: at least 26 dB;
- On any frequency removed from the carrier frequency by more than 45 kHz, up to the first multiple of the carrier frequency: at least 60 dB or  $43 + 10 \log P$  dB, whichever is the lesser attenuation.

For F1D emission mask, the mean power of emissions must be attenuated below the mean power of the unmodulated carrier (P) as follows:

- On any frequency removed from the carrier frequency by more than 20 kHz but no more than 45 kHz: at least 26 dB;
- On any frequency removed from the carrier frequency by more than 45 kHz but not more than 90 kHz: at least 45 dB;
- On any frequency removed from the carrier frequency by more than 90 kHz, up to the first multiple of the carrier frequency: at least 60 dB or  $43 + 10 \log P$  db, whichever is the lesser attenuation.

### 5.1 Test Procedure

The 99% Bandwidth function of the EMI Receiver (HP8546) was used to measure the bandwidth.

### 5.2 Test Equipment

Description	Manufacturer	Model Number	Serial Number	Calibration due date
Spectrum Analyzer	HP	8546B	3650A000369/ 3448A00284	5/24/03
Attenuator	Weinschel	2 (10dB)	BK2313	5/6/03

## 5.3 Test Results

The Dual Band GSM Cellular Phone met the occupied bandwidth requirements of FCC §22.917(b)(d) and RSS-128.

*Table 5-1: Occupied bandwidth measurements for GSM modes*

Mode	Channel	Resolution Bandwidth	Video Bandwidth	Sweep time	Measured Bandwidth MHz
GSM800	128	3 kHz	3 kHz	500 ms	255.0
GSM800	189	3 kHz	3 kHz	500 ms	255.0
GSM800	251	3 kHz	3 kHz	500 ms	245.0
GSM1900	512	3 kHz	3 kHz	500 ms	255.0
GSM1900	661	3 kHz	3 kHz	500 ms	250.0
GSM1900	810	3 kHz	3 kHz	500 ms	255.0

## 6 OUT OF BAND EMISSION AT ANTENNA TERMINALS

FCC §2.1047, FCC §22.917(f), FCC §24.238(a), RSS-128 and RSS-133

Out of Band Emissions: The mean power of emissions must be attenuated below the mean power of the unmodulated carrier (P) on any frequency twice or more than twice the fundamental frequency by at least  $43 + 10 \log P$  dB.

Mobile Emissions in Base Frequency Range: The mean power of any emissions appearing in the base station frequency range from cellular mobile transmitters operated must be attenuated to a level not to exceed -80 dBm at the transmit antenna connector.

Band Edge Requirements: In the 1 MHz bands immediately outside and adjacent to the frequency block, a resolution bandwidth of at least 1 percent of the emission bandwidth of the fundamental emission of the transmitter may be employed to measure the Out of Band Emissions.

### 6.1 Test Procedure

The RF output of the transceiver was connected to a spectrum analyzer through appropriate attenuation. The resolution bandwidth of the spectrum analyzer was set at 1 MHz. The audio modulating signal was adjusted like it is described in Section 6.1 of this report. Sufficient scans were taken to show the out of band Emissions if any up to 10th harmonic.

### 6.2 Test Equipment

Description	Manufacturer	Model Number	Serial Number	Calibration due date
Spectrum Analyzer	HP	8566B	2134A01032/ 2344A05843	12/3/02
Highpass Filter	FILTEK	HP12/1000-5AB	ITS213156	5/6/03
Highpass Filter	FILTEK	HP12/2000-5AB	ITS213156	5/6/03
Attenuator	Weinschel	2 (10dB)	BK2313	5/6/03



## 6.3 Test Results

The Dual Band GSM Cellular Phone met the out of band emission at antenna terminal requirements of FCC §22.917(f), FCC §24.238(a), RSS-128 and RSS-133

*Table 6-1: Summary of test result locations*

Location	Mode (Band)	Channel	Description
Figure 6-1	GSM800	128	Conducted spurious emissions, 30MHz to 10 GHz
Figure 6-2	GSM800	189	Conducted spurious emissions, 30MHz to 10 GHz
Figure 6-3	GSM800	251	Conducted spurious emissions, 30MHz to 10 GHz
Figure 6-4	GSM1900	512	Conducted spurious emissions, 30MHz to 20 GHz
Figure 6-5	GSM1900	661	Conducted spurious emissions, 30MHz to 20 GHz
Figure 6-6	GSM1900	810	Conducted spurious emissions, 30MHz to 20 GHz
Figure 6-7	GSM800	128	Emissions within 1 MHz of band edge
Figure 6-8	GSM800	251	Emissions within 1 MHz of band edge
Figure 6-9	GSM1900	512	Emissions within 1 MHz of band edge
Figure 6-10	GSM1900	810	Emissions within 1 MHz of band edge

Figure 6-1: Out of band emissions at antenna terminals – GSM800 Channel 128

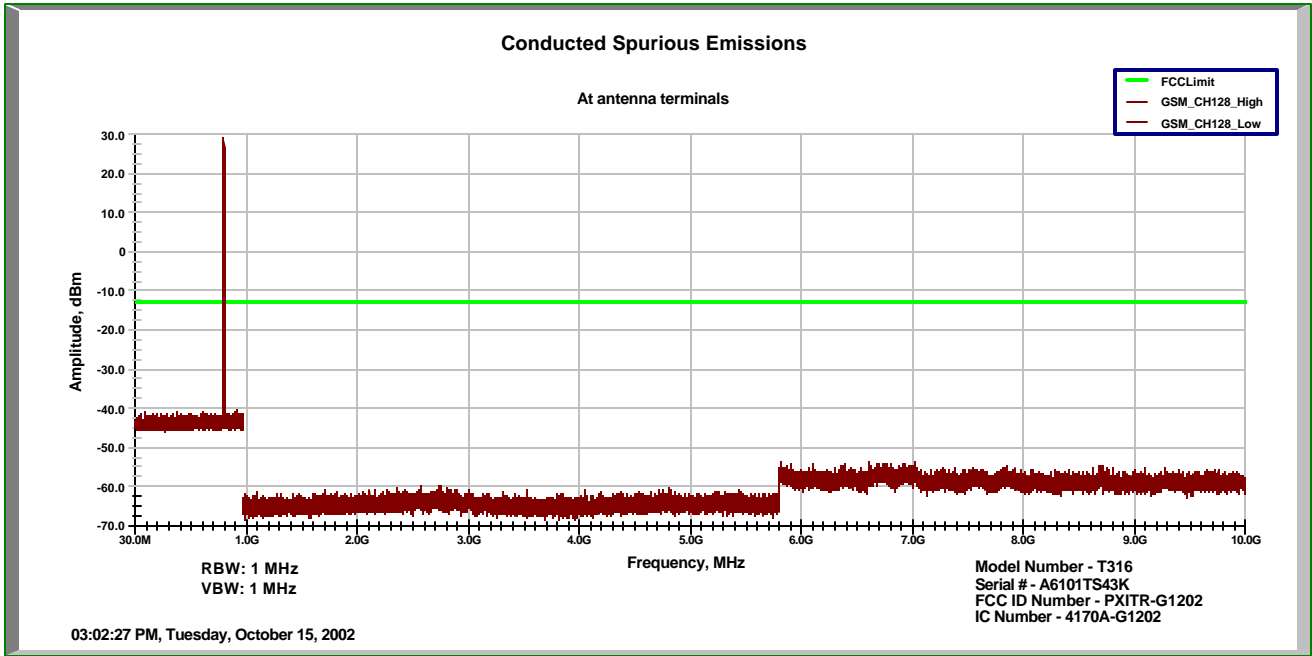

Figure 6-2: Out of band emissions at antenna terminals – GSM800 Channel 189

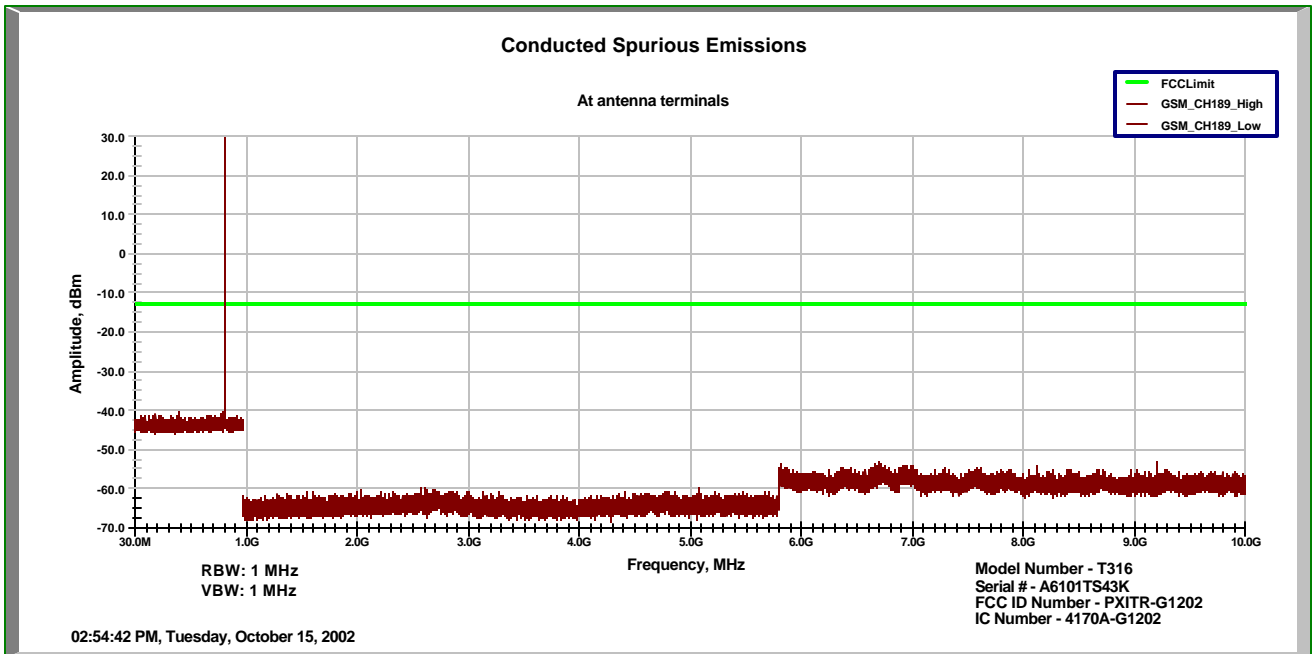

Figure 6-3: Out of band emissions at antenna terminals – GSM800 Channel 251

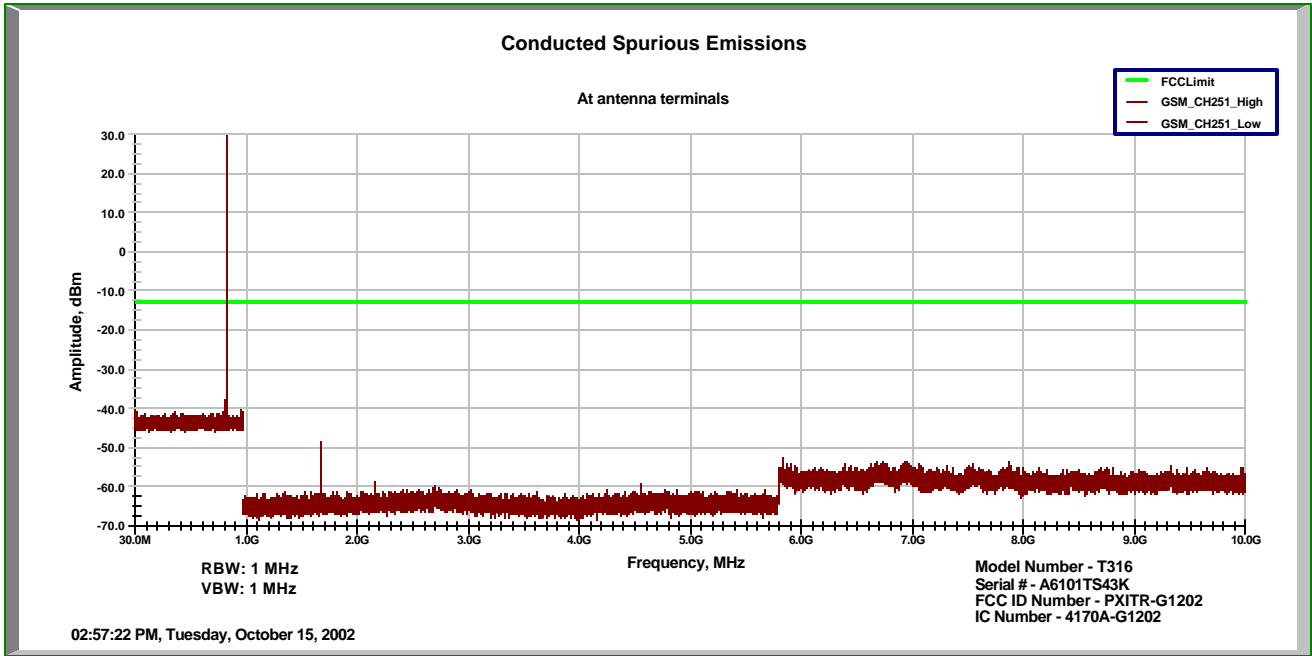

Figure 6-4: Out of band emissions at antenna terminals – GSM1900 Channel 512

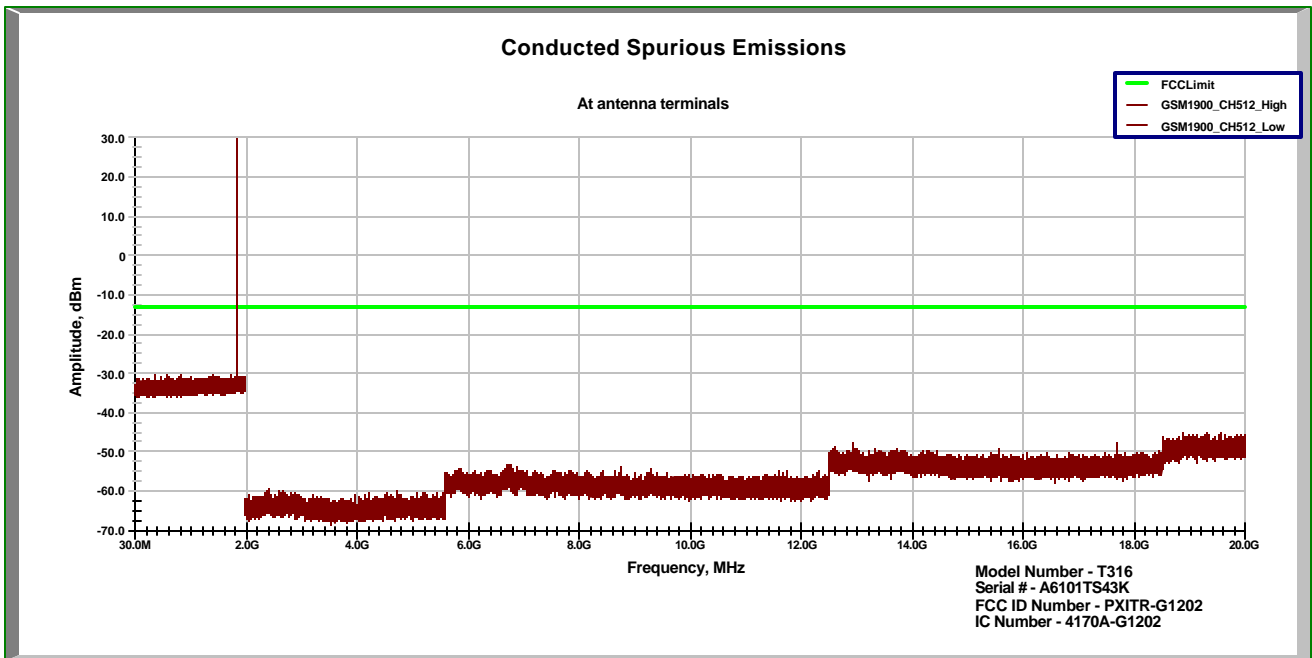

Figure 6-5: Out of band emissions at antenna terminals – GSM800 Channel 661

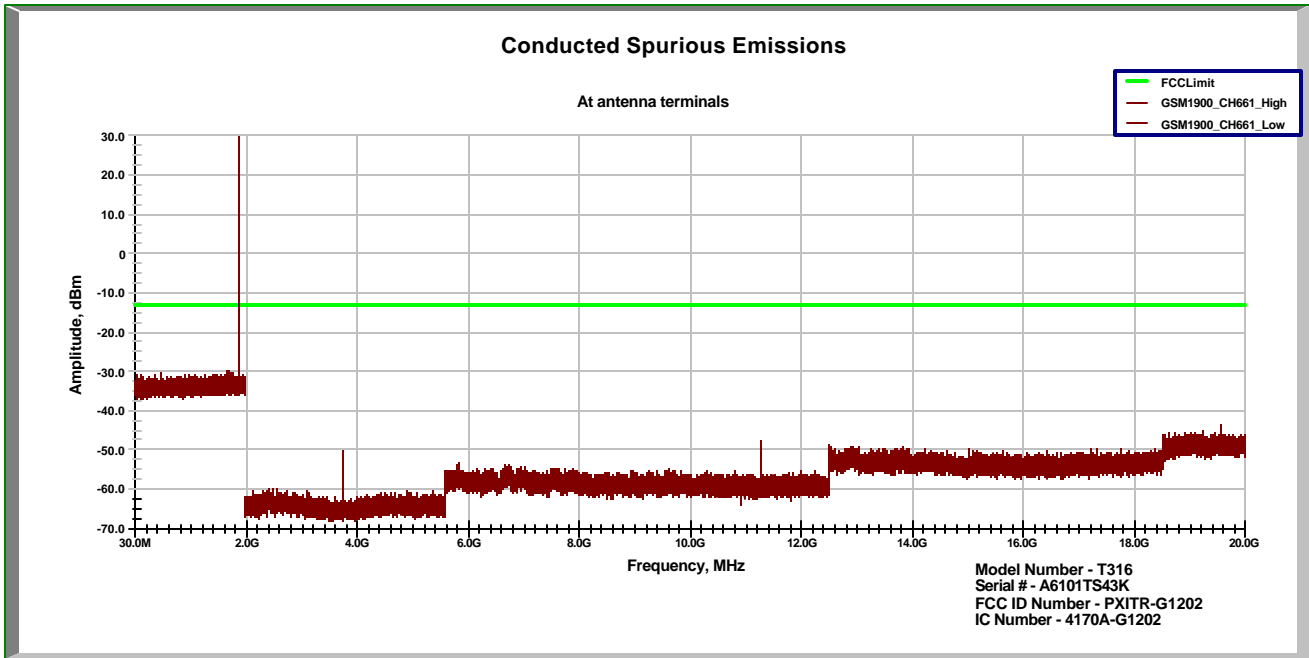

Figure 6-6: Out of band emissions at antenna terminals – GSM1900 Channel 810

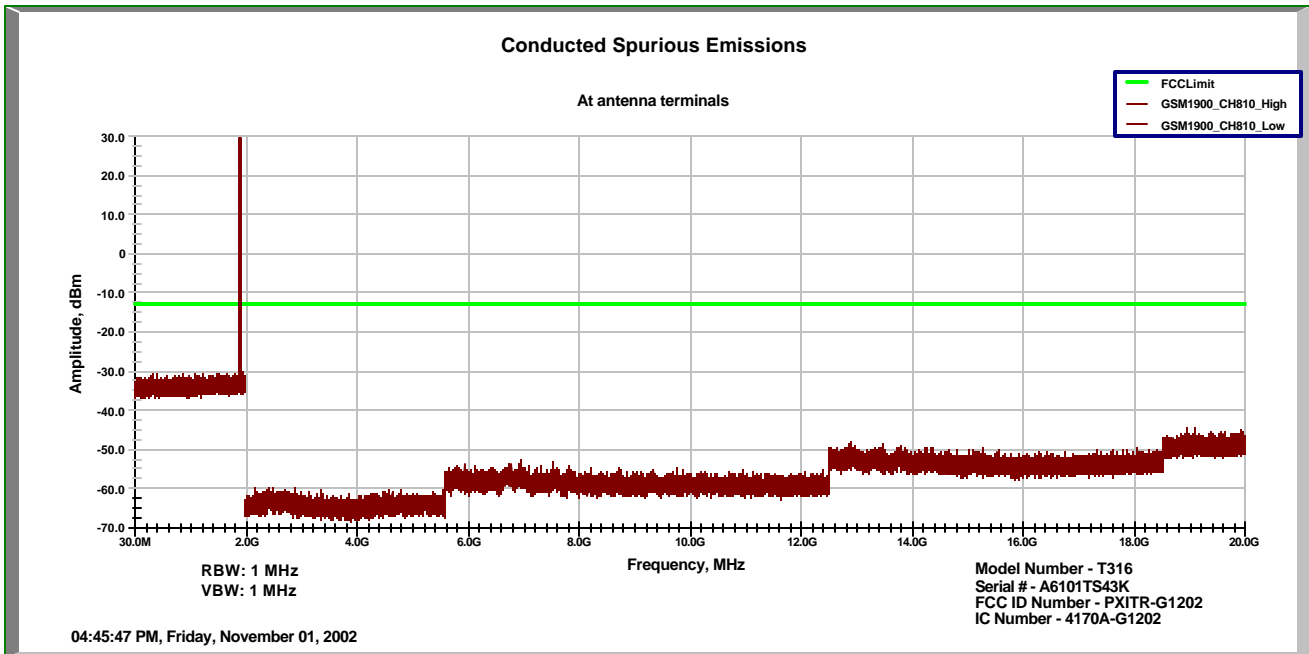

Figure 6-7: Emissions within 1 MHz of band edge, GSM 800 Channel 128

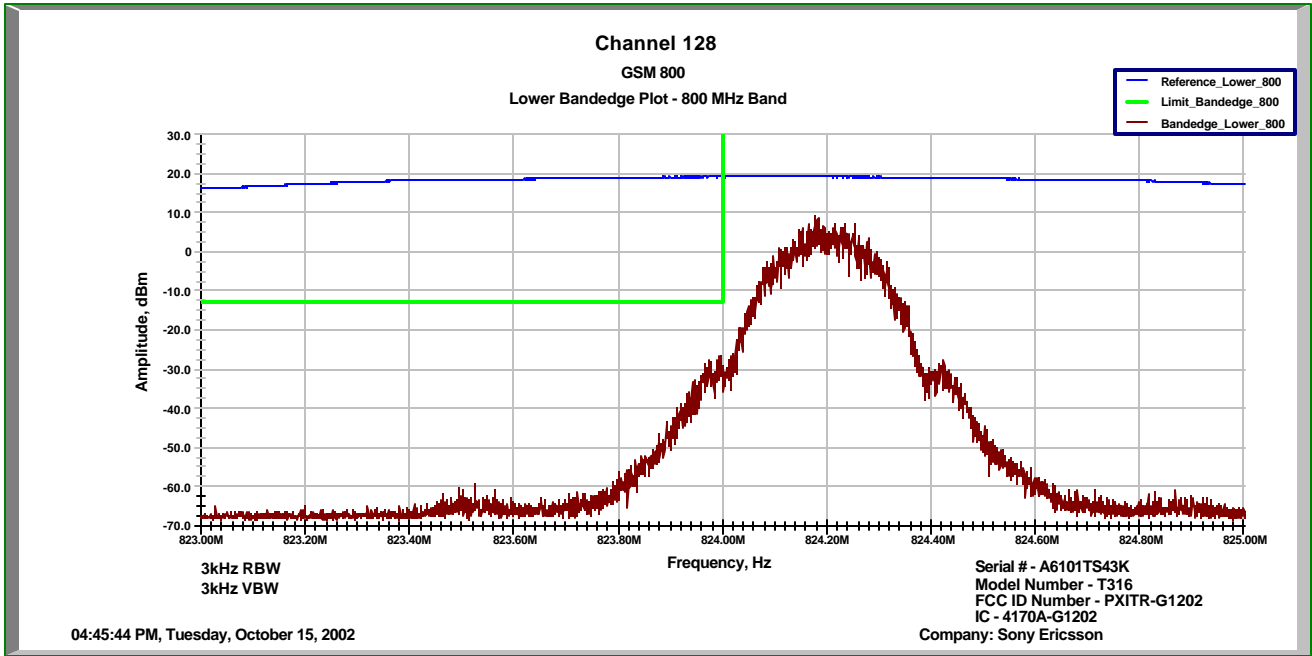

Figure 6-8: Emissions within 1 MHz of band edge, GSM 800 Channel 251

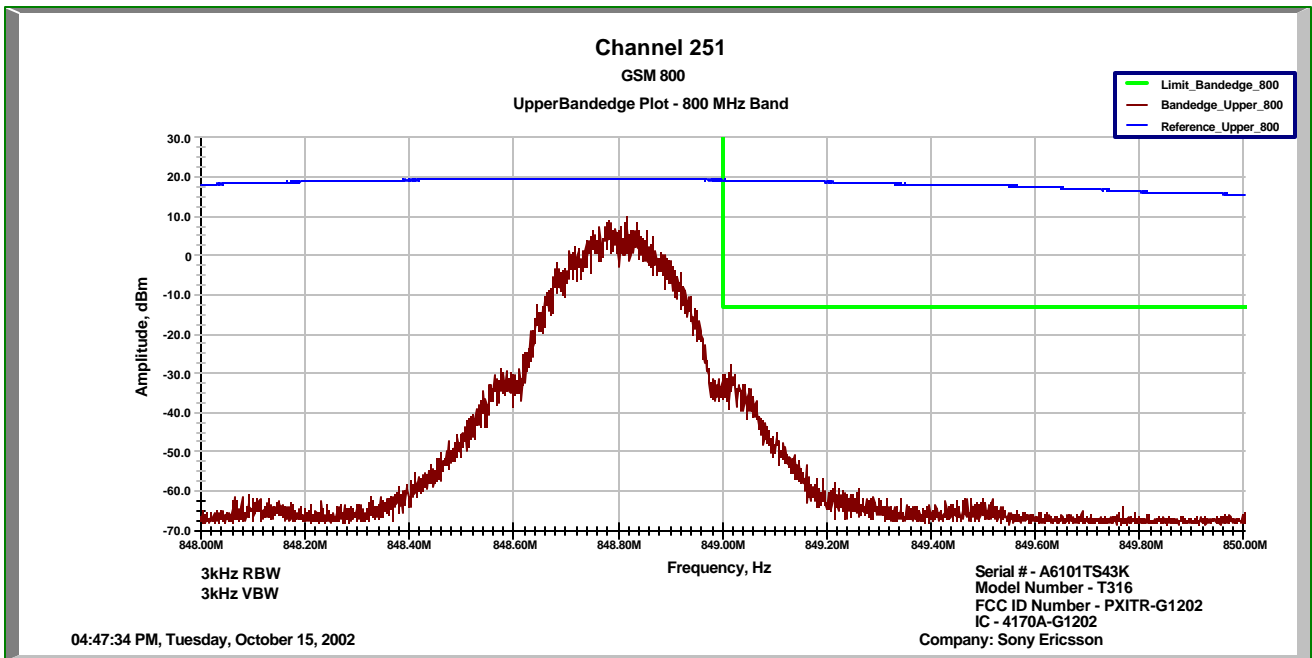

Figure 6-9: Emissions within 1 MHz of band edge, GSM 1900 Channel 512

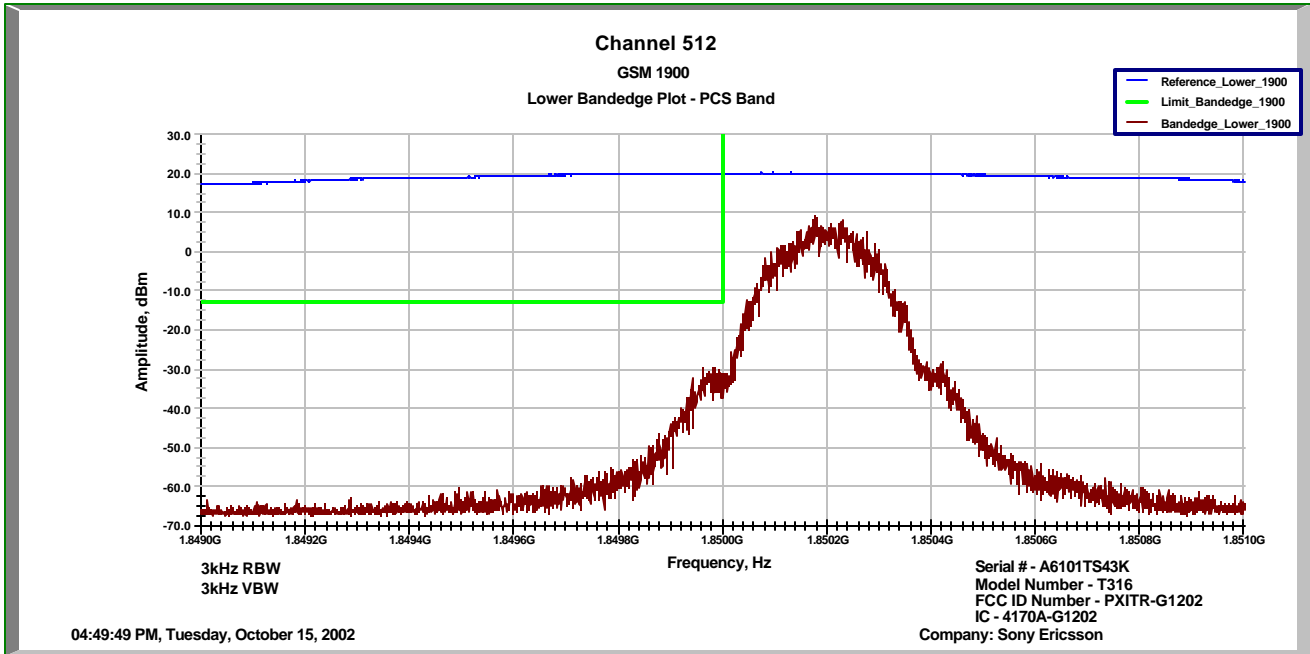
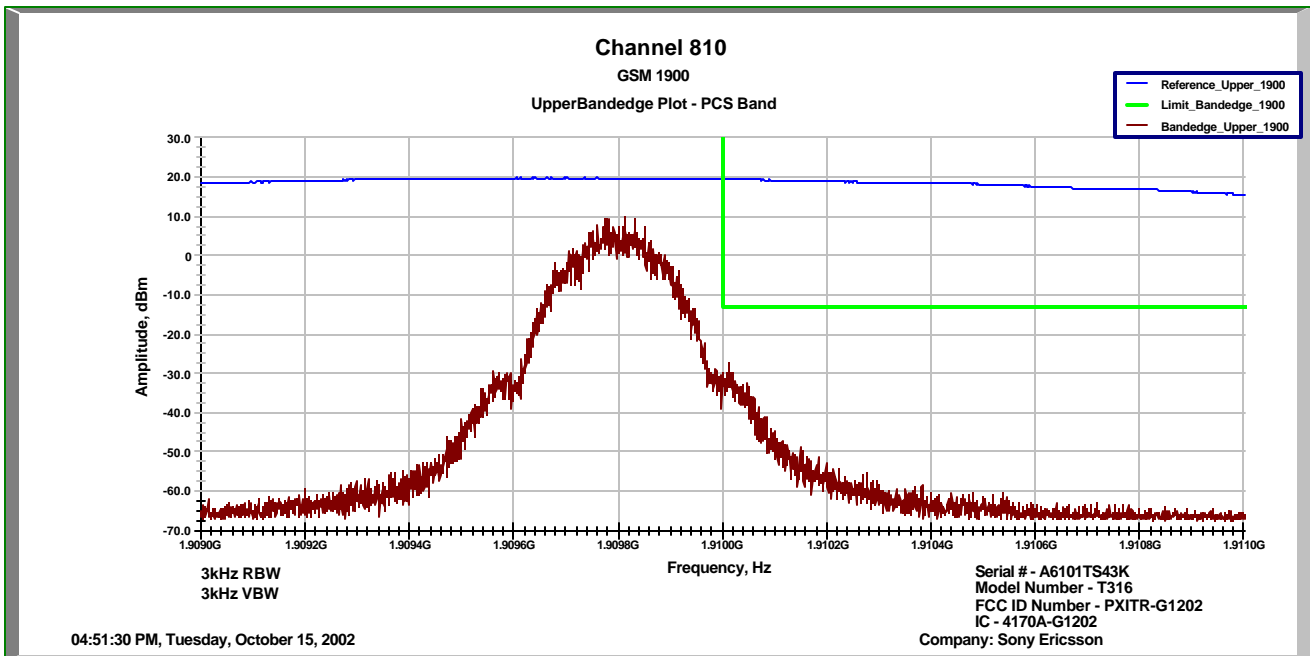

Figure 6-10: Emissions within 1 MHz of band edge, GSM 1900 Channel 810



**7 FIELD STRENGTH OF SPURIOUS RADIATION**

FCC §2.1053, RSS-128

**7.1 Test Procedure**

The EUT was placed on a non-conductive turntable with the earpiece attached. The earpiece was extended vertically above the EUT using a non-conductive support. The measurement antenna was placed at a distance of 3 meters from the EUT. During the tests, the antenna height and EUT azimuth were varied in order to identify the maximum level of emissions from the EUT. This maximization process was repeated with the EUT positioned in each of its three orthogonal orientations.

The frequency range up to tenth harmonic was investigated for each of three fundamental frequencies (low, middle, and high channels). Once spurious emissions were identified, the power of the emission was determined using the substitution method.

The spurious emissions attenuation was calculated as the difference between radiated power at the fundamental frequency and at the spurious emissions frequency.

**7.2 Test Equipment**

Description	Manufacturer	Model Number	Serial Number	Calibration due date
Spectrum Analyzer	HP	8566B	2134A01032/ 2344A05843	12/3/02
Spectrum Analyzer	HP	8546A	3410A00173/ 3448A00203	3/28/03
Preamplifier	HP	8447D	2648A04926	2/22/03
Preamplifier	HP	8449B	3008A00989	10/24/02
Antenna	Schaffner-Chase	CBL6112B	2622	8/14/02
High pass Filter	FILTEK	HP12/1000-5AB	ITS213156	5/6/03
High pass Filter	FILTEK	HP12/2000-5AB	ITS213156	5/6/03
Receiving Biconilog Antenna	Chase	CBL6112	2622	8/15/02
Receiving Horn Antenna	AH-Systems	SAS-200/571	246	1/13/03
Transmitting Dipole Antenna	CDI	A100	R4	8/1/02
Transmitting Horn Antenna	EMCO	3115	9208-3919	2/20/03

**7.3 Test Results**

The Dual Band GSM Cellular Phone met the field strength of spurious radiation requirements of FCC §2.1053 and RSS-128. There were no emissions detected within 20 dB of the limit. Table 7.1 shows the measured emissions.

# Intertek Testing Services

*Table 7-1: Measured Field Strength of Spurious Radiation*

Company: **Sony Ericsson**

Model: **T316**

Project No.: **3033002**

Date: 10/17/02

Standard: FCC15

Class: A

Group: None

Notes: S/N - A61017TS43H

Tested by: Matthew Van Steen

Location: Duluth

Detector: HP8546

Antenna: AH571

PreAmp: hp8449b

Cable(s): HS7000 N-SMATW3 + HS4000 N-N

Distance: **3**

Ant. Pol. (V/H)	Frequency MHz	Reading dB(uV)	Antenna Factor dB(1/m)	Cable Loss dB	Pre-amp Factor dB	Distance Factor dB	Net dB(uV/m)	Limit dB(uV/m)	Margin dB
<b>GSM 1900 - ch. 810</b>									
V	5729.605	45.4	35.9	16.6	36.1	0.0	61.8	82.2	-20.4
H	5729.605	42.2	35.9	16.6	36.1	0.0	58.5	82.2	-23.7
<b>GSM 1900 - ch. 661</b>									
V	5640.200	45.8	35.6	16.0	36.1	0.0	61.2	82.2	-21.0
H	5640.200	40.9	35.6	16.0	36.1	0.0	56.3	82.2	-25.9
V	3759.875	42.4	32.7	13.0	36.4	0.0	51.7	82.2	-30.5
H	3759.875	33.6	32.7	13.0	36.4	0.0	42.9	82.2	-39.3
<b>GSM 1900 - ch. 512</b>									
V	5550.700	45.5	35.3	15.8	36.0	0.0	60.5	82.2	-21.7
H	5550.700	41.0	35.3	15.8	36.0	0.0	56.0	82.2	-26.2
V	3700.250	43.9	32.5	12.7	36.5	0.0	52.6	82.2	-29.6
H	3700.250	37.7	32.5	12.7	36.5	0.0	46.3	82.2	-35.9
<b>GSM 800 - ch. 251</b>									
V	1697.630	63.1	27.7	7.9	37.3	0.0	61.4	82.2	-20.8
H	1697.630	56.8	27.7	7.9	37.3	0.0	55.1	82.2	-27.1
<b>GSM 800 - ch. 189</b>									
V	1672.950	64.2	27.5	7.9	37.4	0.0	62.2	82.2	-20.0
H	1672.950	59.0	27.5	7.9	37.4	0.0	57.0	82.2	-25.2
<b>GSM 800 - ch. 128</b>									
V	1648.550	64.0	27.3	7.8	37.4	0.0	61.7	82.2	-20.5
H	1648.550	59.4	27.3	7.8	37.4	10.5	46.7	82.2	-35.5



**8 POWER LINE CONDUCTED EMISSIONS**

FCC §15.107, FCC §15.207

**8.1 Test Procedure**

Measurements are carried out using quasi-peak and average detector receivers in accordance with CISPR 16. An AMN is required to provide a defined impedance at high frequencies across the power feed at the point of measurement of terminal voltage and also to provide isolation of the circuit under test from the ambient noise on the power lines. An AMN as defined in CISPR 16 shall be used.

The EUT is located so that the distance between the boundary of the EUT and the closest surface of the AMN is 0.8m.

Where a flexible mains cord is provided by the manufacturer, this shall be 1m long or if in excess of 1m, the excess cable is folded back and forth as far as possible so as to form a bundle not exceeding 0.4m in length.

The EUT is arranged and connected with cables terminated in accordance with the product specification.

Conducted disturbance is measured between the phase lead and the reference ground, and between the neutral lead and the reference ground. Both measured values are reported.

The EUT, where intended for tabletop use, is placed on a table whose top is 0.8m above the ground plane. A vertical, metal reference plane is placed 0.4m from the EUT. The vertical metal reference-plane is at least 2m by 2m. The EUT shall be kept at least 0.8m from any other metal surface or other ground plane not being part of the EUT. The table is constructed of non-conductive materials. Its dimensions are 1m by 1.5m, but may be extended for larger EUT.

Equipment setup for conducted disturbance tests followed the guidelines of ANSI C63.4: 1992.

**8.2 Test Equipment**

Description	Manufacturer	Model Number	Serial Number	Calibration due date
Spectrum Analyzer	HP	8566B	2134A010321/ 2344A05843	12/3/02
EMI Receiver	HP	8546A	3410A00173/ 3448A00203	3/28/03
LISN	FCC	FCC-LISN-50-50- M	2020	5/12/03

**8.3 Test Results**

The Dual Band GSM Cellular Phone met the power line conducted emission requirements of FCC §15.107 and §15.207. The test results are located in Figure 8-1.

# Intertek Testing Services

Figure 8-1: FCC §15.107 and §15.207 power line conducted emissions (peak)

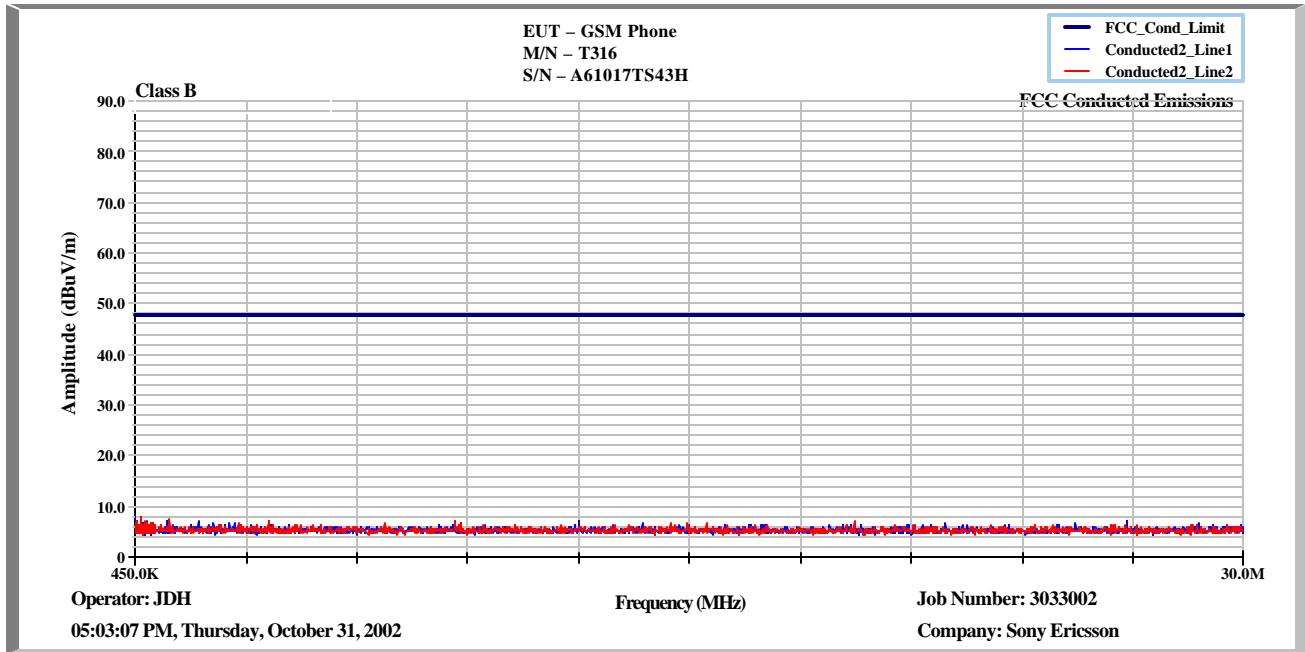

There were no emissions detected within 20 dB of the limit.

## 8.4 Test Configuration Photograph

Figure 8-2 and Figure 8-3 show the testing configurations used.

*Figure 8-2: Configuration photograph, AC mains conducted emission, front view*

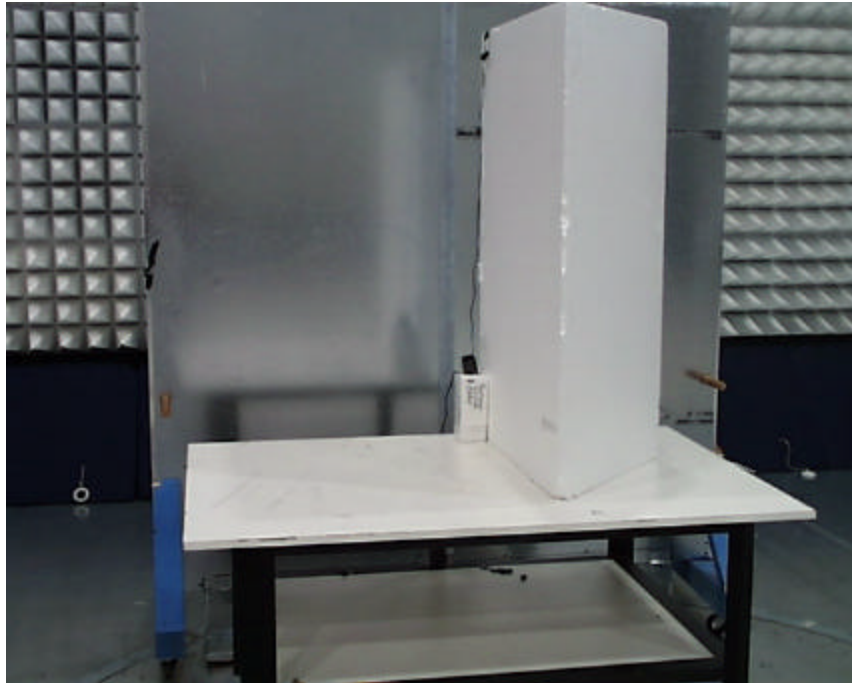

*Figure 8-3: Configuration photograph, AC mains conducted emission, rear view*

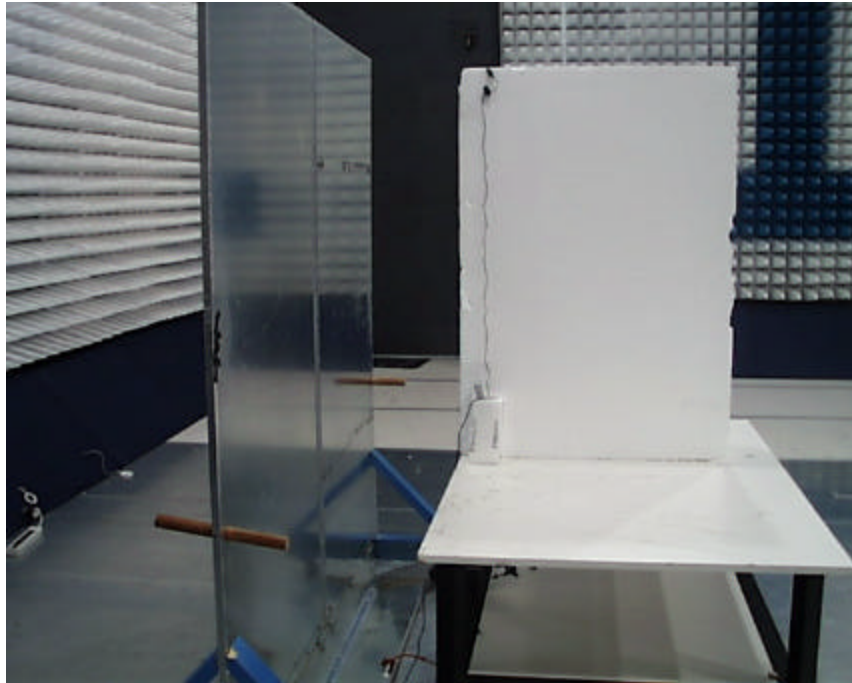

## 9 FREQUENCY STABILITY VS TEMPERATURE

FCC §2.1055, FCC §22.355, FCC §24.235, RSS-133

Frequency tolerance: 2.5ppm

### 9.1 Test Procedure

The equipment under test was connected to an external DC power supply and the RF output was connected to a frequency counter via feedthrough attenuators. The EUT was placed inside the temperature chamber. The DC leads, RF output cable, and external PTT cable exited the chamber through an opening made for that purpose.

After the temperature stabilized for approximately 30 minutes, the external PTT switch was activated, and the frequency output was recorded from the counter.

### 9.2 Test Equipment

Description	Manufacturer	Model Number	Serial Number	Calibration due date
DC Power Supply	Tektronix	PS2352G	TW50199	12/5/02
GSM mobile station test set	ANRITSU	MT8202A	US37111069	9/9/03
Temperature Chamber	Thermotron	SE-600-3-3	29411	2/4/2003

### 9.3 Test Results

The Dual Band GSM Cellular Phone met the frequency stability requirements of FCC §2.1055, FCC §22.355, FCC §24.235, and RSS-133 . The test results are located in Table 9-1 and Table 9-2.

# Intertek Testing Services

---

Table 9-1: GSM800 Channel 189, Frequency stability vs. Temperature

Tx Frequency: 836.400 MHz

Tolerance: +/- 2091 Hz

Temperature (°C)	Frequency (MHz)	Difference (Hz)
60	836.3999815	-18.5
50	836.4000080	+8.0
40	836.3999895	-10.5
30	836.3999760	-24.1
20	836.3999947	-5.4
10	836.4000215	+21.5
0	836.4000115	+11.5
-10	836.4000276	+27.6
-20	836.4000323	+32.3
-30	836.4000534	+53.4

Table 9-2: GSM1900 Channel 661, Frequency stability vs. Temperature

Tx Frequency: 1880 MHz

Tolerance: +/-4700 Hz

Temperature (°C)	Frequency (MHz)	Difference (Hz)
60	1879.9999867	-13.0
50	1879.9999825	-17.5
40	1879.9999788	-21.2
30	1879.9999677	-32.3
20	1880.0000180	+18.0
10	1879.9999783	-21.7
0	1879.9999737	-26.3
-10	1880.0000359	+35.9
-20	1880.0000458	+45.8
-30	1880.0000247	+24.7

## 10 FREQUENCY STABILITY VS VOLTAGE

FCC §2.1055, FCC §22.355

Frequency tolerance: 2.5ppm

### 10.1 Test Procedure

An external variable DC power supply was connected to the battery terminals of the equipment under test. The voltage was set to 115% of the nominal value and was then decreased to the battery end point, which was determined by Sony Ericsson to be 85% of the nominal value. The output frequency was recorded for each battery voltage.

### 10.2 Test Equipment

Description	Manufacturer	Model Number	Serial Number	Calibration due date
DC Power Supply	Tektronix	PS2510G	TW50295	5/10/03
GSM mobile station test set	ANRITSU	MT8202A	US37111069	9/9/03
Temperature Chamber	Thermotron	SM-45	505/25199RF	4/10/03

### 10.3 Test Results

The Dual Band GSM Cellular Phone met the frequency stability requirements of FCC §2.1055, FCC §22.355. The test results are located in Table 10-1 and Table 10-2.

# Intertek Testing Services

---

Table 10-1: GSM 800 Channel 189, Frequency stability vs. input voltage

Tx Frequency: 836.40 MHz

Tolerance: +/- 2091 Hz

Supply (Battery)	Frequency	Difference
Volts	(MHz)	(Hz)
3.4	836.4000022	+22.0
3.5	836.4000027	+27.0
3.6	836.4000034	+34.0
3.7	836.3999790	-21.0
3.8	836.4000020	+20.0
3.9	836.4000014	+14.0
4	836.3999730	-27.0
4.1	836.4000029	+29.0
4.2	836.4000025	+25.0

Table 10-2: GSM 1900 Channel 661, Frequency stability vs. input voltage

Tx Frequency: 1880.00 MHz

Tolerance: +/-4700 Hz

Supply (Battery)	Frequency	Difference
Volts	(MHz)	(Hz)
3.4	1880.000320	+32.0
3.5	1880.000450	+45.0
3.6	1880.000360	+36.0
3.7	1879.999979	-21.0
3.8	1880.000300	+30.0
3.9	1880.000260	+26.0
4.0	1879.999972	-28.0
4.1	1879.999985	-15.0
4.2	1879.999983	-17.0



## 11 RECEIVER SPURIOUS EMISSIONS

### 11.1 Test Limits

*Table 11-1 Radiated Emission Limit for FCC §15.109, RSS-128, and RSS-133*

Radiated Emission Limits at 3 meters	
Frequency (MHz)	Quasi-Peak limits, dB (µV/m)
30 to 88	40.0
88 to 216	43.5
216 to 960	46.0
960 and up	54.0

### 11.2 Test Equipment

Description	Make	Model	Serial #	Cal Due Date
EMI Receiver	HP	85462A	3650A00362	3/28/03
RF Filter Selector	HP	85460A	3704A00331	3/28/03
Spectrum Analyzer	HP	8566B	2134A01032 / 2344A05843	12/4/02
PreAmp	HP	8449B	3008A0089	10/24/02
BiLog Antenna	Chase	CBL6112B	2622	8/14/03
Horn Antenna	AH Systems	SAS200/571	246	1/21/03
Cable	N/A	Cable N2	ITS# 211999a2	6/12/03
Cable	N/A	CableTW2	ITS# 211411	6/12/03
Cable	N/A	CableTW3	ITS# 211412	6/12/03

### 11.3 Test Procedure

Measurements are made over the frequency range of 30 MHz to five times the highest frequency operating within the device. The measuring receiver meets the requirements of Section One of CISPR 16 and the measuring antenna correlates to a balanced dipole. From 30 to 1000 MHz, a quasi-peak detector was used for measurement. Above 1000 MHz, average measurements were performed.

Measurements of the radiated field are made with the antenna located at a distance of 3 meters from the EUT. If the field-strength measurements at 3m cannot be made because of high ambient noise level or for other reasons, measurements may be made at a closer distance, for example 1m. An inverse proportionality factor of 20 dB per decade should be used to normalize the measured data to the specified distance for determining compliance.

The antenna is adjusted between 1m and 4m in height above the ground plane for maximum meter reading at each test frequency.

The antenna-to-EUT azimuth is varied during the measurement to find the maximum field-strength readings.

# Intertek Testing Services

The antenna-to-EUT polarization (horizontal and vertical) is varied during the measurements to find the maximum field-strength readings.

The EUT, where intended for tabletop use, is placed on a table whose top is 0.8m above the ground plane. The table is constructed of non-conductive materials. Its dimensions are 1m by 1.5m, but may be extended for larger EUT.

Equipment setup for radiated disturbance tests followed the guidelines of ANSI C63.4: 1992.

## 11.4 Test Results

The Dual Band GSM Cellular Phone met the radiated disturbance requirements of FCC §15.109, RSS-128, and RSS-133. The test results are located in Figure 11-1.

Figure 11-1 FCC §15.109, RSS-128, and RSS-133 Receiver Spurious Emissions (worse case)

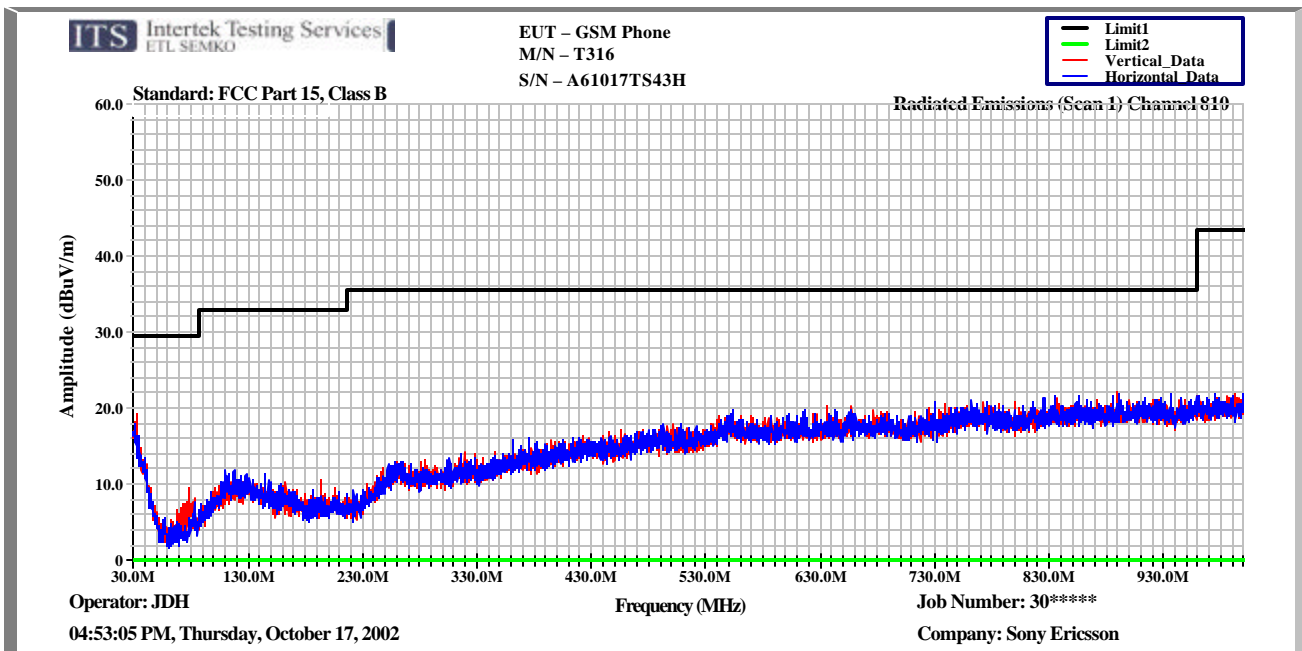

### 11.5 Test Configuration Photograph

Figure 11-1 and Figure 11-2 show the testing configurations used.

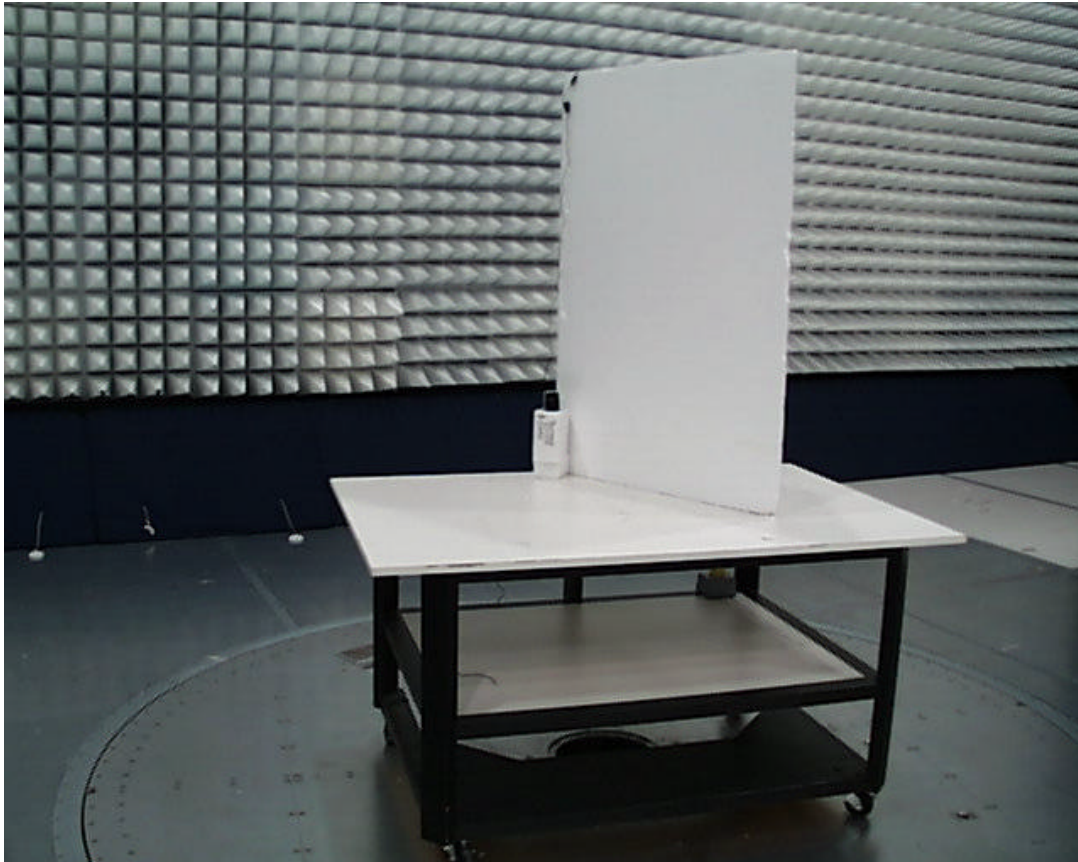

*Figure 11-1: Configuration photograph, radiated emission, front view*



*Figure 11-2: Configuration photograph, radiated emission, rear view*