



# RADIO DFS TEST REPORT

Report No.: STS2212073W14

Issued for

Winmate Inc.

9F, No.111-6, Shing-De Rd., San-Chung District, New Taipei  
City 241, Taiwan

<b>Product Name:</b>	Rugged Tablet PC
<b>Brand:</b>	Winmate
<b>Model Number:</b>	S101TG
<b>Series Model(s):</b>	S101XXXXXXXXXXXX, ("X"= A~Z, a~z, 0~9, "-" Blank or Slash for marketing purpose only, no impact safety related constructions or critical components)
<b>FCC ID:</b>	PX9S10101
<b>Test Standard:</b>	FCC Part 15.407

Any reproduction of this document must be done in full. No single part of this document may be reproduced without permission from STS, all test data presented in this report is only applicable to presented test sample.





TEST REPORT CERTIFICATION

Applicant's Name..... : Winmate Inc.
Address ..... : 9F, No.111-6, Shing-De Rd., San-Chung District, New Taipei City
241, Taiwan
Manufacturer's Name ..... : Winmate Inc.
Address ..... : 9F, No.111-6, Shing-De Rd., San-Chung District, New Taipei City
241, Taiwan

Product Description

Product Name..... : Rugged Tablet PC
Brand ..... : Winmate
Model Number ..... : S101TG
Series Model(s) ..... : S101XXXXXXXXXXXX, ("X"= A~Z, a~z, 0~9,"-" Blank or Slash
for marketing purpose only, no impact safety related constructions
or critical components)

Test Standards..... : FCC Part 15.407

Test Procedure 905462 D02 UNII DFS Compliance Procedures New Rules v02
905462 D03 UNII Clients Without Radar Detection New Rules
v01r02

This device described above has been tested by STS, and the test results show that the
equipment under test (EUT) is in compliance with the FCC requirements. And it is applicable only
to the tested sample identified in the report.

This report shall not be reproduced except in full, without the written approval of STS, this
document only be altered or revised by STS, personal only, and shall be noted in the revision of
the document.

Date of Test..... :

Date of receipt of test item ..... : 07 June 2022

Date (s) of performance of tests..... : 07 June 2022 ~ 15 Mar. 2023

Date of Issue..... : 15 Mar. 2023

Test Result..... : Pass

Testing Engineer : Chris Chen

(Chris Chen)

Technical Manager : Sean She

(Sean she)

Authorized Signatory : Bovey Yang

(Bovey Yang)





## Table of Contents

<b>1. SUMMARY OF TEST RESULTS</b>	<b>5</b>
1.1 TEST FACTORY	5
1.2 MEASUREMENT UNCERTAINTY	5
<b>2. GENERAL INFORMATION</b>	<b>6</b>
2.1 GENERAL DESCRIPTION OF THE EUT	6
2.2 TEST CONDITIONS AND CHANNEL	8
2.3 DFS MEASUREMENT INSTRUMENTATION	10
2.4 EQUIPMENTS LIST FOR ALL TEST ITEMS	11
<b>3. DFS PARAMETERS</b>	<b>12</b>
3.1 DFS PARAMETERS	12
3.2 DFS –TEST RESULTS	16





**Revision History**

Rev.	Issue Date	Report NO.	Effect Page	Contents
00	15 Mar. 2023	STS2212073W14	ALL	Initial Issue





## 1. SUMMARY OF TEST RESULTS

Test procedures according to the technical standards: KDB 905462 D02 UNII DFS Compliance Procedures New Rules v02 and 905462 D03 UNII Clients Without Radar Detection New Rules v01r02

Part 15.407		
Requirement	Operational Mode	RESULTS
	Master	
Non-Occupancy Period	Yes	Pass
DFS Detection Threshold	Yes	Pass
Channel Availability Check Time	Yes	Pass
Channel Closing Transmission Time	Yes	Pass
Channel Move Time	Yes	Pass
U-NII Detection Bandwidth	Yes	Pass

### 1.1 TEST FACTORY

SHENZHEN STS TEST SERVICES CO., LTD

Add. : A 1/F, Building B, Zhuoke Science Park, No.190 Chongqing Road, HepingShequ, Fuyong Sub-District, Bao'an District, Shenzhen, Guang Dong, China

FCC test Firm Registration Number: 625569

IC test Firm Registration Number: 12108A

A2LA Certificate No.: 4338.01

### 1.2 MEASUREMENT UNCERTAINTY

The reported uncertainty of measurement  $y \pm U$ , where expanded uncertainty  $U$  is based on a standard uncertainty multiplied by a coverage factor of  $k=2$ , providing a level of confidence of approximately **95** %.

No.	Item	Uncertainty
1	DFS Threshold (conducted)	$\pm 1.197\text{dB}$
2	Temperature	$\pm 1.028^\circ\text{C}$
3	Humidity	$\pm 4.611\%$



## 2. GENERAL INFORMATION

### 2.1 GENERAL DESCRIPTION OF THE EUT

Product Name	Rugged Tablet PC								
Brand	Winmate								
Model Number	S101TG								
Series Model(s)	S101XXXXXXXXXXXX, ("X"= A~Z, a~z, 0~9,"-" Blank or Slash for marketing purpose only, no impact safety related constructions or critical components)								
Model Difference	Only for Marketing purpose .								
Product Description	<p>The EUT is Rugged Tablet PC</p> <table border="1"> <tr> <td>Operation Frequency:</td> <td>           802.11a/ n(HT20)/ac(VHT20))/ax(HE20):            5.260GHz-5.320GHz            802.11 n(HT40)/ac(VHT40))/ax(HE40):            5.270GHz-5.310GHz            802.11ac(VHT80))/ax(HE80): 5.290GHz            802.11a/ n(HT20)/ac(VHT20))/ax(HE20):            5.500GHz-5.700GHz            802.11 n(HT40)/ac(VHT40))/ax(HE40):            5.510GHz-5.670GHz            802.11ac(VHT80))/ax(HE80):            5.530GHz-5.610GHz            802.11ax (160MHz):5250~5570MHz         </td> </tr> <tr> <td>Modulation Type:</td> <td>           802.11a(OFDM):BPSK,QPSK,16-QAM,64-QAM            802.11n(OFDM):BPSK,QPSK,16-QAM,64-QAM            802.11ac(OFDM):            BPSK,QPSK,16-QAM,64-QAM,256-QAM            802.11ax(OFDM, OFDMA):            BPSK,QPSK,16-QAM,64-QAM,256-QAM,            1024QAM         </td> </tr> <tr> <td>Number Of Channel</td> <td>Please see Note 2.</td> </tr> <tr> <td>Antenna Gain(Peak)</td> <td>           Antenna A gain : 1.3dBi            Antenna B gain : 3.9dBi            MIMO technology Directional gain=5.71dBi         </td> </tr> </table> <p>Based on the application, features, or specification exhibited in User's Manual, the EUT is considered as an ITE/Computing Device. More details of EUT technical specification, please refer to the User's Manual.</p>	Operation Frequency:	802.11a/ n(HT20)/ac(VHT20))/ax(HE20): 5.260GHz-5.320GHz 802.11 n(HT40)/ac(VHT40))/ax(HE40): 5.270GHz-5.310GHz 802.11ac(VHT80))/ax(HE80): 5.290GHz 802.11a/ n(HT20)/ac(VHT20))/ax(HE20): 5.500GHz-5.700GHz 802.11 n(HT40)/ac(VHT40))/ax(HE40): 5.510GHz-5.670GHz 802.11ac(VHT80))/ax(HE80): 5.530GHz-5.610GHz 802.11ax (160MHz):5250~5570MHz	Modulation Type:	802.11a(OFDM):BPSK,QPSK,16-QAM,64-QAM 802.11n(OFDM):BPSK,QPSK,16-QAM,64-QAM 802.11ac(OFDM): BPSK,QPSK,16-QAM,64-QAM,256-QAM 802.11ax(OFDM, OFDMA): BPSK,QPSK,16-QAM,64-QAM,256-QAM, 1024QAM	Number Of Channel	Please see Note 2.	Antenna Gain(Peak)	Antenna A gain : 1.3dBi Antenna B gain : 3.9dBi MIMO technology Directional gain=5.71dBi
Operation Frequency:	802.11a/ n(HT20)/ac(VHT20))/ax(HE20): 5.260GHz-5.320GHz 802.11 n(HT40)/ac(VHT40))/ax(HE40): 5.270GHz-5.310GHz 802.11ac(VHT80))/ax(HE80): 5.290GHz 802.11a/ n(HT20)/ac(VHT20))/ax(HE20): 5.500GHz-5.700GHz 802.11 n(HT40)/ac(VHT40))/ax(HE40): 5.510GHz-5.670GHz 802.11ac(VHT80))/ax(HE80): 5.530GHz-5.610GHz 802.11ax (160MHz):5250~5570MHz								
Modulation Type:	802.11a(OFDM):BPSK,QPSK,16-QAM,64-QAM 802.11n(OFDM):BPSK,QPSK,16-QAM,64-QAM 802.11ac(OFDM): BPSK,QPSK,16-QAM,64-QAM,256-QAM 802.11ax(OFDM, OFDMA): BPSK,QPSK,16-QAM,64-QAM,256-QAM, 1024QAM								
Number Of Channel	Please see Note 2.								
Antenna Gain(Peak)	Antenna A gain : 1.3dBi Antenna B gain : 3.9dBi MIMO technology Directional gain=5.71dBi								
Channel List	Refer to below								
Sub-class	H01								
Adapter	Input: AC100-240V 50-60Hz 2.0A Output: 19V 3.42A								
Battery	Rated Voltage:11.4V Charge Limit Voltage:13.05V Capacity: 3500mAh								
Hardware version number	S101TG-120								
Software version number	005								



Note:

1. For a more detailed features description, please refer to the manufacturer’s specifications or the User Manual, the antenna information refer the manufacturer provide report, applicable only to the tested sample identified in the report.

2

Channel List for 802.11a/n/ac/ax (20MHz)							
Channel	Frequency (MHz)	Channel	Frequency (MHz)	Channel	Frequency (MHz)	Channel	Frequency (MHz)
52	5260	56	5280	60	5300	64	5320
100	5500	104	5520	108	5540	112	5560
116	5580	120	5600	124	5620	128	5640
132	5660	136	5680	140	5700	--	--

Channel List for 802.11n/ac/ax (40 MHz)							
Channel	Frequency (MHz)	Channel	Frequency (MHz)	Channel	Frequency (MHz)	Channel	Frequency (MHz)
54	5270	62	5310	102	5510	110	5550
134	5670	--	--	--	--	--	--

Channel List for 802.11ac/ax (80 MHz)							
Channel	Frequency (MHz)	Channel	Frequency (MHz)	Channel	Frequency (MHz)	Channel	Frequency (MHz)
58	5290	106	5530	122	5610	--	--

Channel List for 802.11ax (160 MHz)							
Channel	Frequency (MHz)	Channel	Frequency (MHz)	Channel	Frequency (MHz)	Channel	Frequency (MHz)
50	5250	114	5570	--	--	--	--



### 3.EQUIPMENT UNDER TEST (EUT) DETAILS

The manufacturer declared values for the EUT operational characteristics that affect DFS are as follows

#### Operating Modes (5250 – 5350 MHz, 5470 – 5725 MHz)

- Master Device  
 Client Device (no In Service Monitoring, no Ad-Hoc mode)  
 Client Device with In-Service Monitoring

#### Antenna Gains / EIRP (5250 – 5350 MHz, 5470 – 5725 MHz)

	5250 – 5350 MHz		5470 – 5725 MHz	
Lowest Antenna Gain (dBi)	ANT A: 1.3 dBi ANT B: 3.9 dBi MIMO A+B: 5.71dBi	ANT A: 1.3 dBi ANT B: 3.9 dBi MIMO A+B: 5.71dBi	ANT A: 1.3 dBi ANT B: 3.9 dBi MIMO A+B: 5.71dBi	ANT A: 1.3 dBi ANT B: 3.9 dBi MIMO A+B: 5.71dBi
Highest Antenna Gain (dBi)	ANT A: 1.3 dBi ANT B: 3.9 dBi MIMO A+B: 5.71dBi	ANT A: 1.3 dBi ANT B: 3.9 dBi MIMO A+B: 5.71dBi	ANT A: 1.3 dBi ANT B: 3.9 dBi MIMO A+B: 5.71dBi	ANT A: 1.3 dBi ANT B: 3.9 dBi MIMO A+B: 5.71dBi
DFS Detection Threshold (dBm)	-62			

#### Channel Protocol

- IP Based  
 Frame Based  
 OTHER \_\_\_\_\_

The EUT did not require modifications during testing in order to comply with the requirements of the standard(s) referenced in this test report.

### 2.2 TEST CONDITIONS AND CHANNEL

	Normal Test Conditions
Temperature	0°C – 40°C
Relative Humidity	20% - 75%
Supply Voltage	DC 11.4V

Channel List		
Band Frequency	EUT Channel	Test Frequency (MHz)
U-NII-2A	CH60	5300
	CH50	5250





Channel List		
Band Frequency	EUT Channel	Test Frequency (MHz)
U-NII-2C	CH116	5580
	CH114	5570





## 2.3 DFS MEASUREMENT INSTRUMENTATION

### a. RADAR GENERATION SYSTEM

An Agilent PSG is used as the radar-generating source. The integral arbitrary waveform generators are programmed using Agilent's "Pulse Building" software and Elliott custom software to produce the required waveforms, with the capability to produce both unmodulated and modulated (FM Chirp) pulses. Where there are multiple values for a specific radar parameter then the software selects a value at random and, for FCC tests, the software verifies that the resulting waveform is truly unique.

With the exception of the hopping waveforms required by the FCC's rules (see below), the radar generator is set to a single frequency within the radar detection bandwidth of the EUT.

Frequency hopping radar waveforms are simulated using a time domain model. A randomly hopping sequence algorithm (which uses each channel in the hopping radar's range once in a hopping sequence) generates a hop sequence. A segment of the first 100 elements of the hop sequence are then examined to determine if it contains one or more frequencies within the radar detection bandwidth of the EUT. If it does not then the first element of the segment is discarded and the next frequency in the sequence is added. The process repeats until a valid segment is produced. The radar system is then programmed to produce bursts at time slots coincident with the frequencies within the segment that fall in the detection bandwidth. The frequency of the generator is stepped in 1 MHz increments across the EUT's detection range.

The radar signal level is verified during testing using a CW signal with the AGC function switched on. Correction factors to account for the fact that pulses are generated with the AGC functions switched off are measured annually and an offset is used to account for this in the software. The generator output is connected to the coupling port of the conducted set-up or to the radar-generating antenna.

### b. CHANNEL MONITORING SYSTEM

Channel monitoring is achieved using a spectrum analyzer and digital storage oscilloscope. The analyzer is configured in a zero-span mode, center frequency set to the radar waveform's frequency or the center frequency of the EUT's operating channel.

The IF output of the analyzer is connected to one input of the oscilloscope and analyzer. A signal generator output is set to send either the modulating signal directly or a pulse gate with an output pulse co-incident with each radar pulse. This output is connected to a second input on the oscilloscope and the oscilloscope displays both the channel traffic (via the if input) and the radar pulses on its display.

For in service monitoring tests the analyzer sweep time is set to > 20 seconds and the oscilloscope is configured with a data record length of 10 seconds for the short duration and frequency hopping waveforms, 20 seconds for the long duration waveforms. Both instruments are set for a single acquisition sequence. The analyzer is triggered 500ms before the start of the waveform and the oscilloscope is triggered directly by the modulating pulse train. Timing measurements for aggregate channel transmission time and channel move time are made from the oscilloscope data, with the end of the waveform clearly identified by the pulse train on one trace. The analyzer trace data is used to confirm that the last transmission occurred within the 10-second record of the oscilloscope. If necessary the record length of the oscilloscope is expanded to capture the last transmission on the channel prior to the channel move.

Channel availability check time timing plots are made using the analyzer. The analyzer is triggered at start of the EUT's channel availability check and used to verify that the EUT does not transmit when radar is applied during the check time.

The analyzer detector and oscilloscope sampling mode is set to peak detect for all plots.



## 2.4 EQUIPMENTS LIST FOR ALL TEST ITEMS

Kind of Equipment	Manufacturer	Type No.	Serial No.	Last calibration	Calibrated until
Signal Generator	Agilent	N5182A	MY46240556	2022.09.28	2023.09.27
Signal Analyzer	Agilent	N9020A	MY51510623	2023.03.01	2024.02.28
Power Splitter	Eastsheep	PD-0.5/0.6-2S	B543	2023.03.02	2024.03.01
Power Splitter	MINI-CIRCUITS	ZN2PD-9G	SF078500430	2023.03.02	2024.03.01
Attenuator	HP	8496B	DC-18G	2023.03.02	2024.03.01
Attenuator	Agilent	8494B	DC-18G	2023.03.02	2024.03.01
Switch control box	MW	MW100-RFCB	N/A	N/A	N/A
Router	TP-LINK (ID:Q87-WRT3200ACM)	TL-WR885N	1125074010735	N.C.R	N.C.R
Temperature & Humidity	HH660	Mieo	N/A	2022.09.30	2023.09.29
Test SW	MW	MTS 8310_2.0.0.0			



### 3. DFS PARAMETERS

#### 3.1 DFS PARAMETERS

Table 1: Applicability of DFS Requirements Prior to Use of a Channel

Requirement	Operational Mode		
	Master	Client Without Radar Detection	Client With Radar Detection
<i>Non-Occupancy Period</i>	Yes	Not required	Yes
<i>DFS Detection Threshold</i>	Yes	Not required	Yes
<i>Channel Availability Check Time</i>	Yes	Not required	Not required
<i>U-NII Detection Bandwidth</i>	Yes	Not required	Yes

Table 2: Applicability of DFS requirements during normal operation

Requirement	Operational Mode	
	Master Device or Client with Radar Detection	Client Without Radar Detection
<i>DFS Detection Threshold</i>	Yes	Not required
<i>Channel Closing Transmission Time</i>	Yes	Yes
<i>Channel Move Time</i>	Yes	Yes
<i>U-NII Detection Bandwidth</i>	Yes	Not required
<b>Additional requirements for devices with multiple bandwidth modes</b>	<b>Master Device or Client with Radar Detection</b>	<b>Client Without Radar Detection</b>
<i>U-NII Detection Bandwidth and Statistical Performance Check</i>	All BW modes must be tested	Not required
<i>Channel Move Time and Channel Closing Transmission Time</i>	Test using widest BW mode available	Test using the widest BW mode available for the link
<i>All other tests</i>	Any single BW mode	Not required
<b>Note:</b> Frequencies selected for statistical performance check (Section 7.8.4) should include several frequencies within the radar detection bandwidth and frequencies near the edge of the radar detection bandwidth. For 802.11 devices it is suggested to select frequencies in each of the bonded 20 MHz channels and the channel center frequency.		



Table 3: DFS Detection Thresholds for Master Devices and Client Devices With Radar Detection

Maximum Transmit Power	Value (See Notes 1, 2, and 3)
EIRP $\geq$ 200 milliwatt	-64 dBm
EIRP < 200 milliwatt and power spectral density < 10 dBm/MHz	-62 dBm
EIRP < 200 milliwatt that do not meet the power spectral density requirement	-64 dBm
<p><b>Note 1:</b> This is the level at the input of the receiver assuming a 0 dBi receive antenna.</p> <p><b>Note 2:</b> Throughout these test procedures an additional 1 dB has been added to the amplitude of the test transmission waveforms to account for variations in measurement equipment. This will ensure that the test signal is at or above the detection threshold level to trigger a DFS response.</p> <p><b>Note 3:</b> EIRP is based on the highest antenna gain. For MIMO devices refer to KDB Publication 662911 D01.</p>	

Table 4: DFS Response Requirement Values

Parameter	Value
<i>Non-occupancy period</i>	Minimum 30 minutes
<i>Channel Availability Check Time</i>	60 seconds
<i>Channel Move Time</i>	10 seconds See Note 1.
<i>Channel Closing Transmission Time</i>	200 milliseconds + an aggregate of 60 milliseconds over remaining 10 second period. See Notes 1 and 2.
<i>U-NII Detection Bandwidth</i>	Minimum 100% of the U-NII 99% transmission power bandwidth. See Note 3.
<p><b>Note 1:</b> <i>Channel Move Time</i> and the <i>Channel Closing Transmission Time</i> should be performed with Radar Type 0. The measurement timing begins at the end of the Radar Type 0 burst.</p> <p><b>Note 2:</b> The <i>Channel Closing Transmission Time</i> is comprised of 200 milliseconds starting at the beginning of the <i>Channel Move Time</i> plus any additional intermittent control signals required to facilitate a <i>Channel move</i> (an aggregate of 60 milliseconds) during the remainder of the 10 second period. The aggregate duration of control signals will not count quiet periods in between transmissions.</p> <p><b>Note 3:</b> During the <i>U-NII Detection Bandwidth</i> detection test, radar type 0 should be used. For each frequency step the minimum percentage of detection is 90 percent. Measurements are performed with no data traffic.</p>	



Table 5 – Short Pulse Radar Test Waveforms

Radar Type	Pulse Width (μsec)	PRI (μsec)	Number of Pulses	Minimum Percentage of Successful Detection	Minimum Number of Trials
0	1	1428	18	See Note 1	See Note 1
1	1	Test A: 15 unique PRI values randomly selected from the list of 23 PRI values in Table 5a	Roundup $\left\{ \left( \frac{1}{360} \right) \cdot \left( \frac{19 \cdot 10^6}{PRI_{\mu sec}} \right) \right\}$	60%	30
		Test B: 15 unique PRI values randomly selected within the range of 518-3066 μsec, with a minimum increment of 1 μsec, excluding PRI values selected in Test A			
2	1-5	150-230	23-29	60%	30
3	6-10	200-500	16-18	60%	30
4	11-20	200-500	12-16	60%	30
Aggregate (Radar Types 1-4)				80%	120
<b>Note 1:</b> Short Pulse Radar Type 0 should be used for the detection bandwidth test, channel move time, and channel closing time tests.					

Table 5a - Pulse Repetition Intervals Values for Test A

Pulse Repetition Frequency Number	Pulse Repetition Frequency (Pulses Per Second)	Pulse Repetition Interval (Microseconds)
1	1930.5	518
2	1858.7	538
3	1792.1	558
4	1730.1	578
5	1672.2	598
6	1618.1	618
7	1567.4	638
8	1519.8	658
9	1474.9	678
10	1432.7	698
11	1392.8	718
12	1355	738
13	1319.3	758
14	1285.3	778
15	1253.1	798
16	1222.5	818
17	1193.3	838
18	1165.6	858
19	1139	878
20	1113.6	898
21	1089.3	918
22	1066.1	938
23	326.2	3066



The aggregate is the average of the percentage of successful detections of Short Pulse Radar Types 1-4. For example, the following table indicates how to compute the aggregate of percentage of successful detections.

Radar Type	Number of Trials	Number of Successful Detections	Minimum Percentage of Successful Detection
1	35	29	82.9%
2	30	18	60%
3	30	27	90%
4	50	44	88%
Aggregate $(82.9\% + 60\% + 90\% + 88\%)/4 = 80.2\%$			

Long Pulse Radar Test Waveform

Table 6 – Long Pulse Radar Test Waveform

Radar Type	Pulse Width (μsec)	Chirp Width (MHz)	PRI (μsec)	Number of Pulses per Burst	Number of Bursts	Minimum Percentage of Successful Detection	Minimum Number of Trials
5	50-100	5-20	1000-2000	1-3	8-20	80%	30

Figure 1 provides a graphical representation of the Long Pulse Radar Test Waveform.

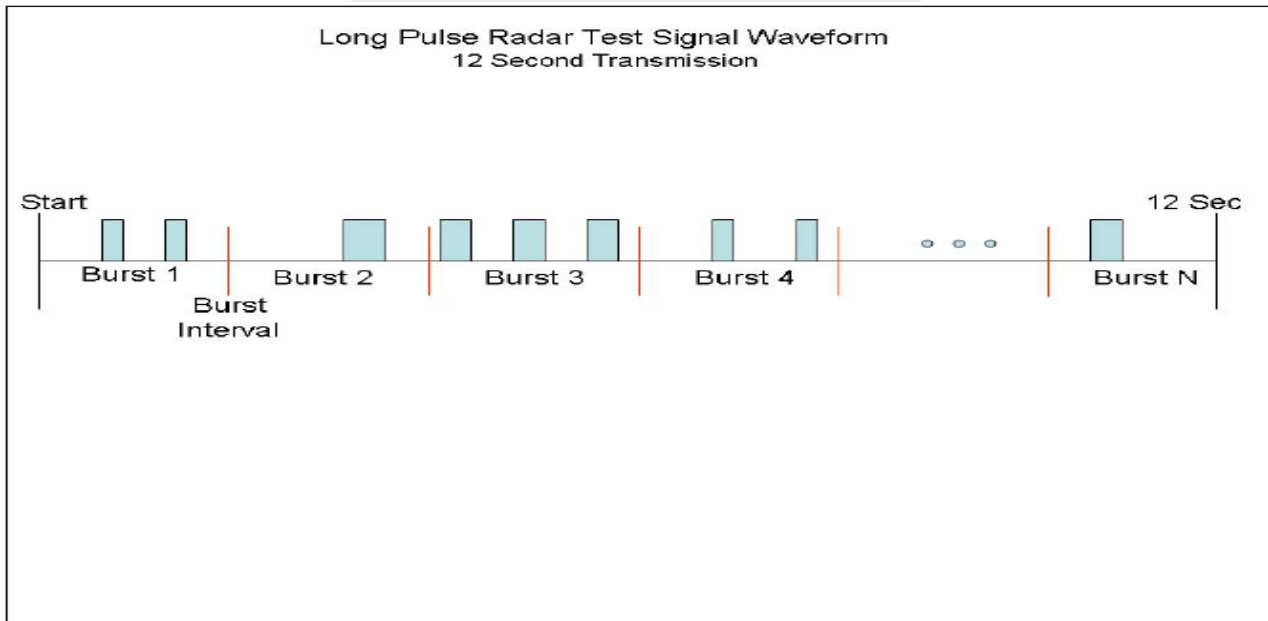

Table 7 – Frequency Hopping Radar Test Waveform

Radar Type	Pulse Width (μsec)	PRI (μsec)	Pulses per Hop	Hopping Rate (kHz)	Hopping Sequence Length (msec)	Minimum Percentage of Successful Detection	Minimum Number of Trials
6	1	333	9	0.333	300	70%	30



## 3.2 DFS –TEST RESULTS

### 3.2.1 TEST RESULTS– FCC Part 15.407 CLIENT DEVICE

#### Shutdown Time

Mode	Frequency (MHz)	Channel Move Time (s)	Limit Channel Move Time (s)	Close Transmission Time (s)	Limit Close Transmission Time (s)	Verdict
ax160	5250	1.2688	10	0.0069	0.26	Pass
ax160	5570	1.3465	10	0.0063	0.26	Pass
a	5300	1.2487	10	0.0384	0.26	Pass
a	5580	1.2542	10	0.0399	0.26	Pass

#### Notes:

- 1) Tests were performed using the conduction test method.
- 2) Channel availability check, detection threshold and non-occupancy period are not applicable to client devices.

### 3.2.2 DFS MEASUREMENT METHODS

#### a. DFS – CHANNEL CLOSING TRANSMISSION TIME AND CHANNEL MOVE TIME

Channel Move Time and the Channel Closing Transmission Time should be performed with Radar Type 0. The measurement timing begins at the end of the Radar Type 0 burst.

The Channel Closing Transmission Time is comprised of 200 milliseconds starting at the beginning of the Channel Move Time plus any additional intermittent control signals required to facilitate a Channel move (an aggregate of 60 milliseconds) during the remainder of the 10 second period. The aggregate duration of control signals will not count quiet periods in between transmissions.

#### b. DFS – CHANNEL NON-OCCUPANCY AND VERIFICATION OF PASSIVE SCANNING

Non-occupancy Period. A channel that has been flagged as containing a radar system, either by a channel availability check or in-service monitoring, is subject to a non-occupancy period of at least 30 minutes. The non-occupancy period starts at the time when the radar system is detected.

#### c. CHANNEL AVAILABILITY CHECK TIME

Channel Availability Check Time. A U-NII device shall check if there is a radar system already operating on the channel before it can initiate a transmission on a channel and when it has to move to a new channel. The U-NII device may start using the channel if no radar signal with a power level greater than the interference threshold values listed in paragraph (h)(2) of this section, is detected within 60 seconds.

#### d. CONTROL (TPC)

Compliance with the transmit power control requirements for devices is demonstrated through measurements showing multiple power levels and manufacturer statements explaining how the power control is implemented.

#### e. DETECTION PROBABILITY / SUCCESS RATE

During the U-NII Detection Bandwidth detection test, radar type 0 should be used. For each frequency step the minimum percentage of detection is 90 percent. Measurements are performed with no data traffic. Minimum 100% of the U-NII 99% transmission power bandwidth.

#### f. NON- OCCUPANCY PERIOD

During the 30 minutes observation time, UUT did not make any transmissions on a channel after a radar signal was detected on that channel by either the Channel Availability Check or the In-Service Monitoring



### 3.2.3 DFS CONDUCTION TEST METHOD

a. The signal level of the simulated waveform is set to a reference level equal to the threshold level (plus 1dB if testing against FCC requirements). Lower levels may also be applied on request of the manufacturer.

The signal level is verified by measuring the CW signal level at the coupling point to the RDD antenna port. The radar signal level is calculated from the measured level, R (dBm) and the lowest gain antenna assembly intended for use with the RDD

If both master and client intended devices have radar detection capability then the radar level at the non RDD is verified to be at least 20dB below the threshold level to ensure that any responses are due to the RDD detecting radar.

The antenna connected to the channel monitoring subsystem is positioned to allow both master and client transmissions to be observed, with the level of the EUT's transmissions between 6 and 10dB higher than those from the other device.

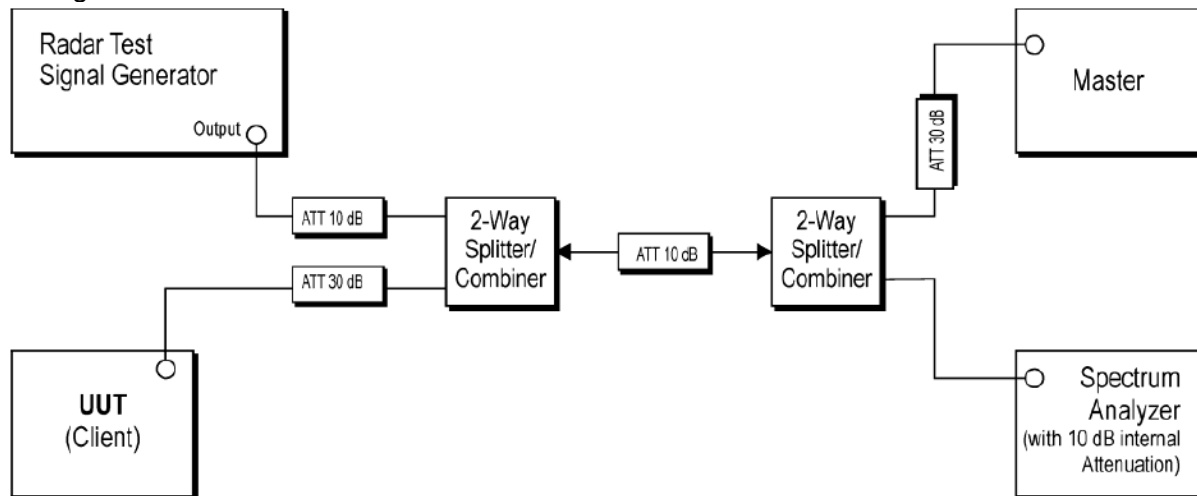

b. *Set-up B* is a set-up whereby the UUT is an RLAN device operating in slave mode, with or without Radar Interference Detection function. This set-up also contains an RLAN device operating in master mode. The radar test signals are injected into the master device. The UUT (slave device) is associated with the master device. Figure 5 shows an example for *Set-up B*. The set-up used shall be documented in the test report.

Channel loading mode:

EUT connects to the router through DFS setup, then controls and switches the EUT channel on the router background page.



### 3.2.4 DFS Test Data

#### Shutdown Time

#### 5250MHz ax160 Shutdown

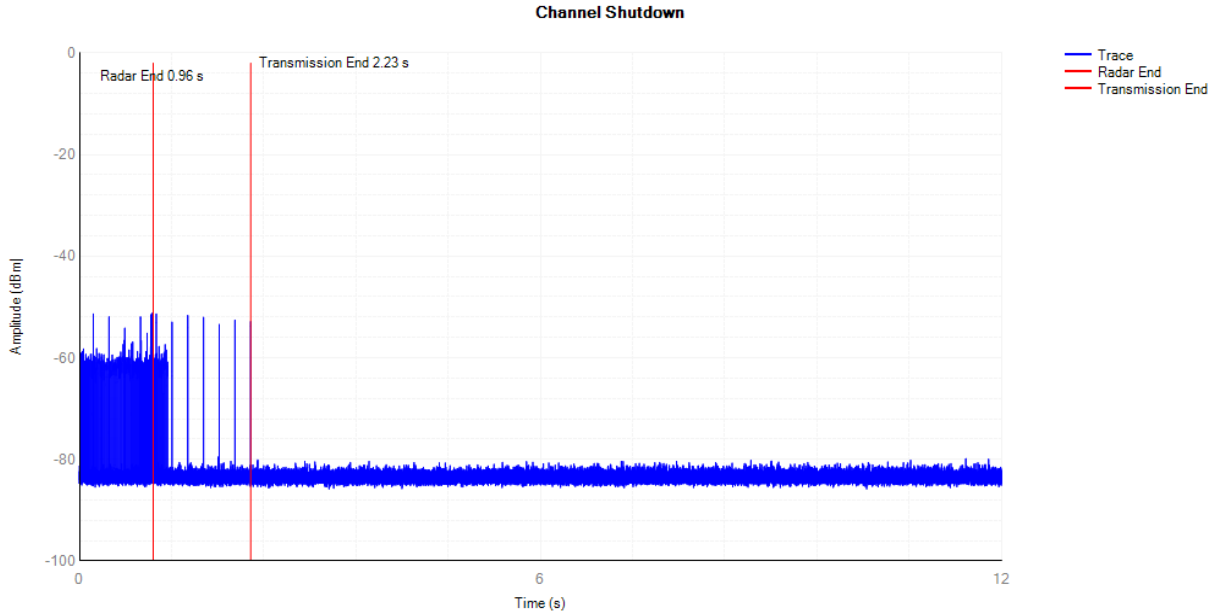

#### 5570MHz ax160 Shutdown

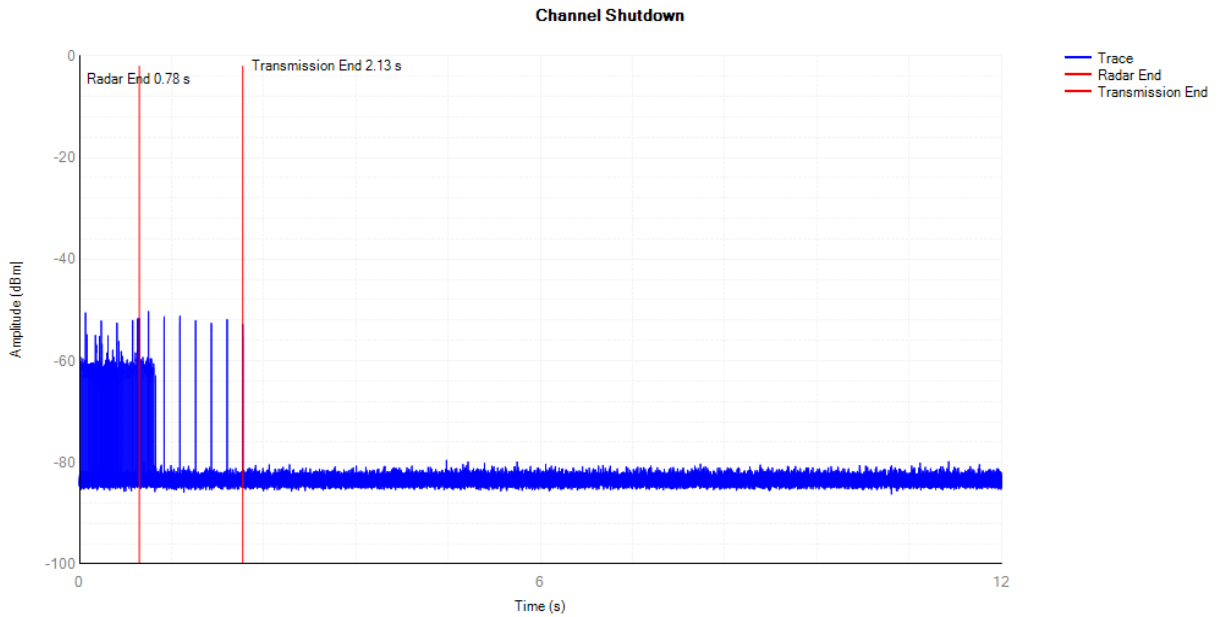



### 5300MHz a Shutdown

Channel Shutdown

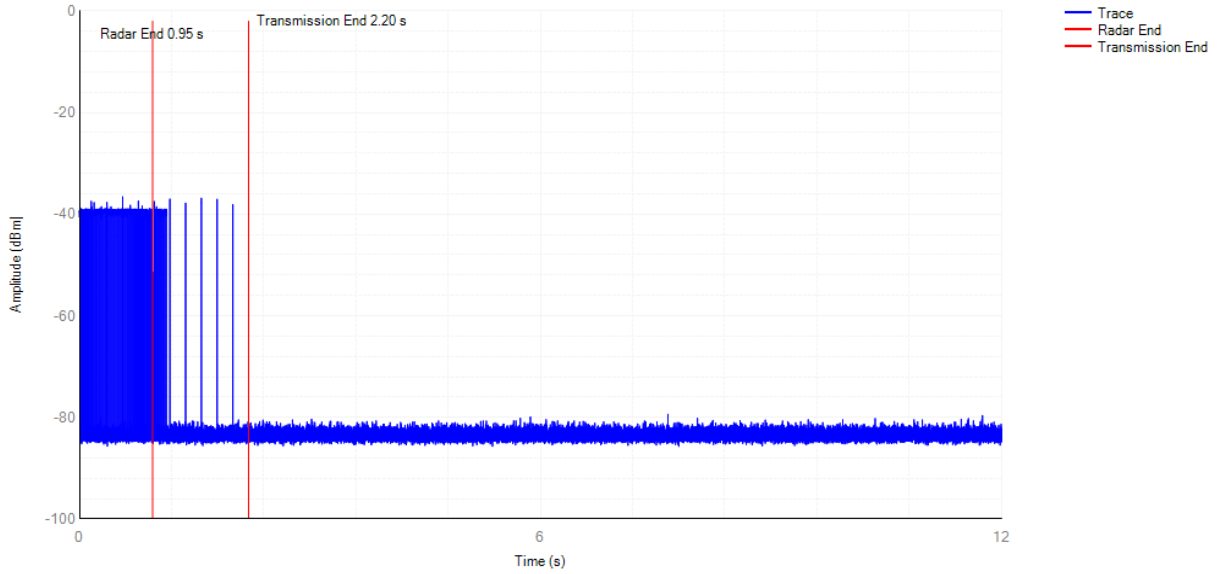

### 5580MHz a Shutdown

Channel Shutdown

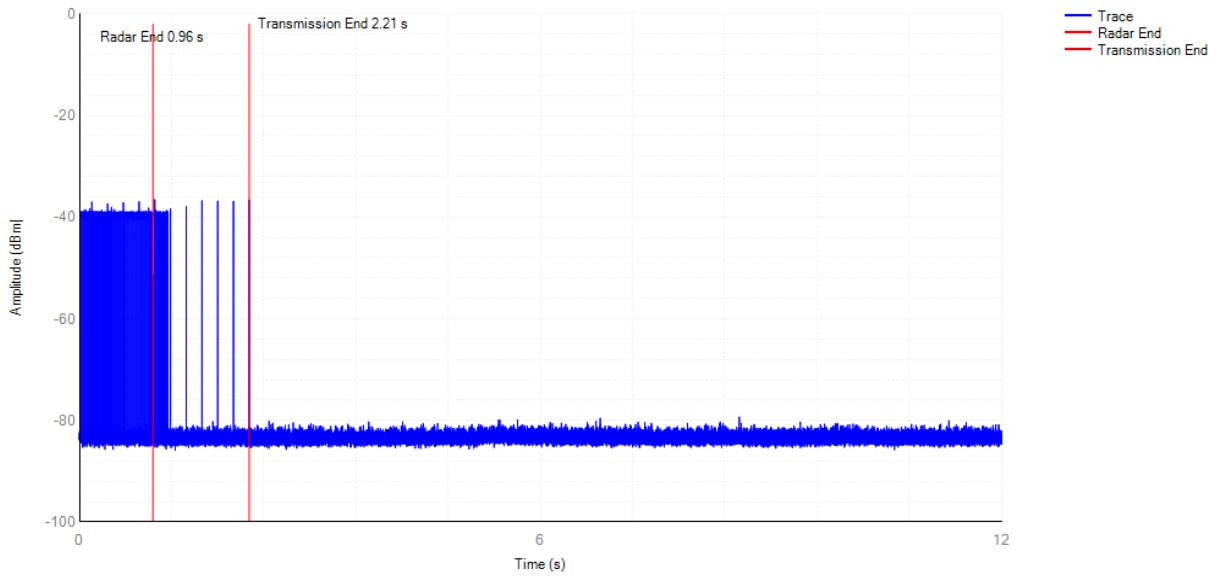



Non-Occupancy

5250MHz ax160 Non-Occupancy

Non-Occupancy period

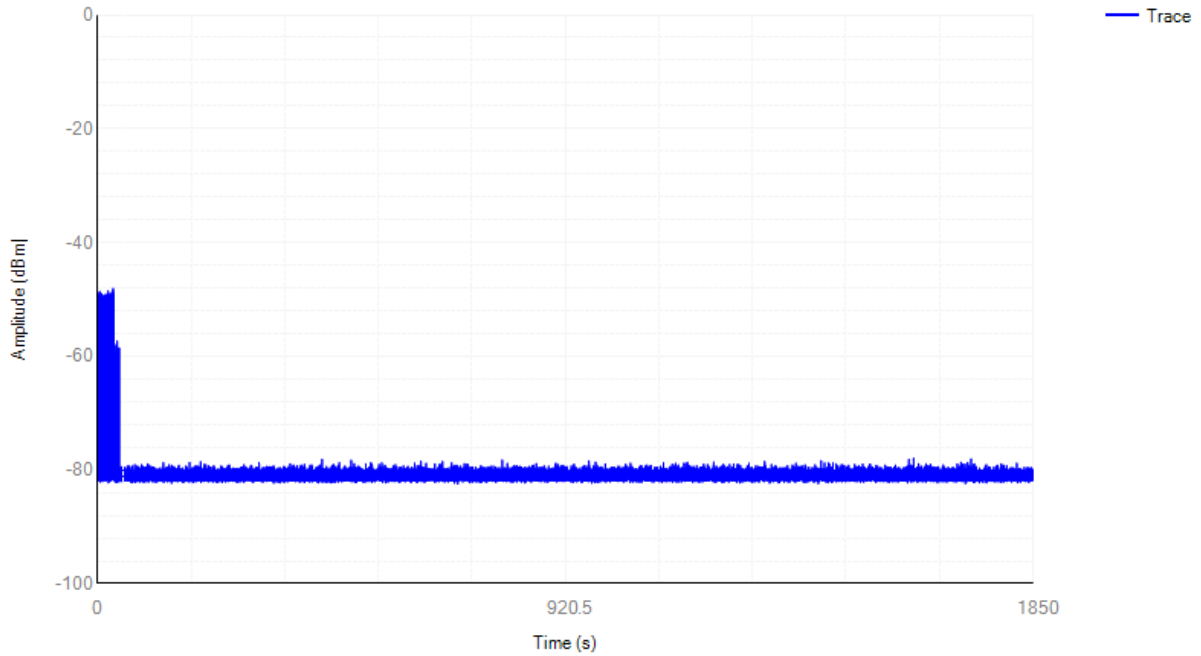

5570MHz ax160 Non-Occupancy

Non-Occupancy period

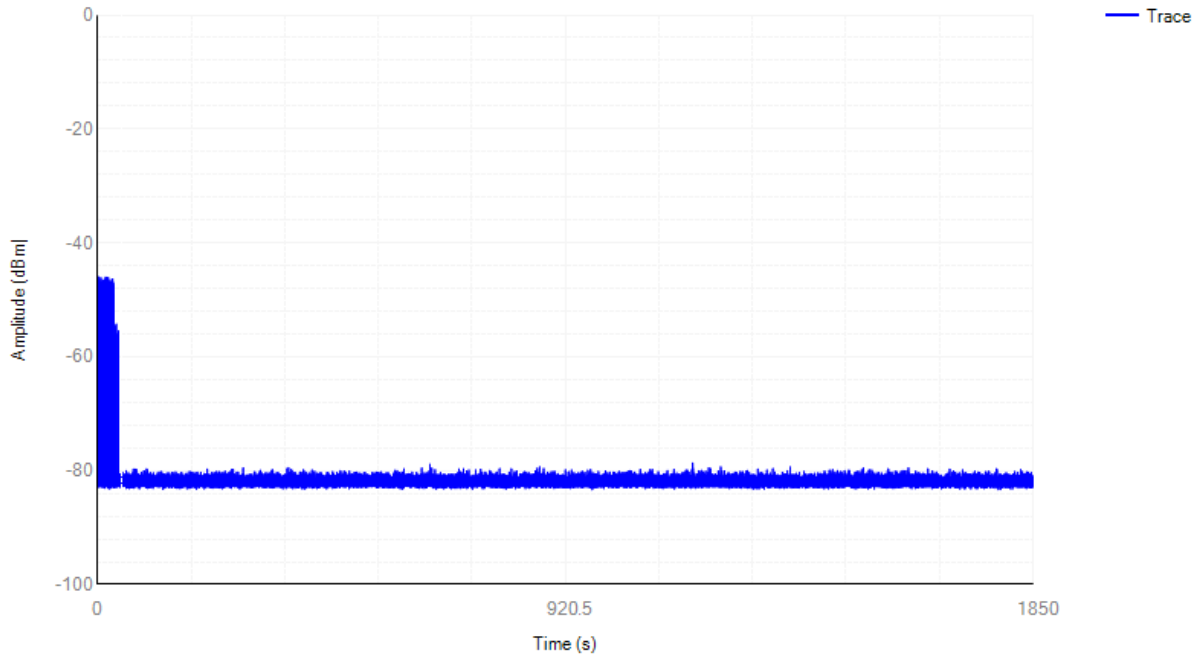



### 5300MHz a Non-Occupancy

Non-Occupancy period

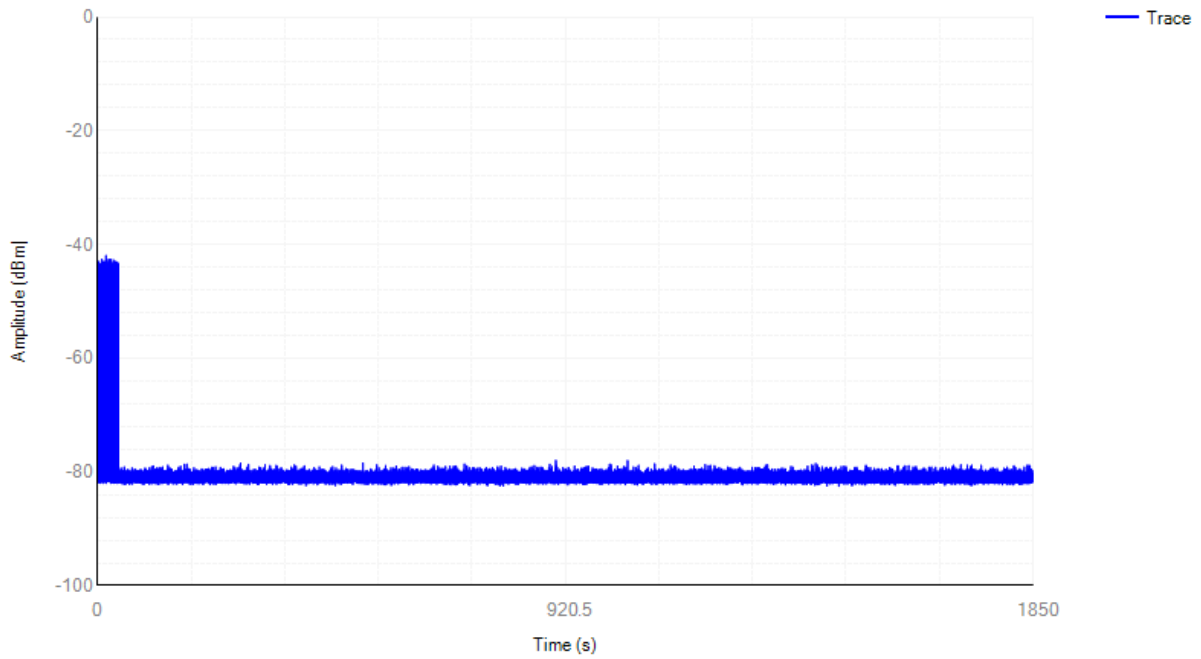

### 5580MHz a Non-Occupancy

Non-Occupancy period

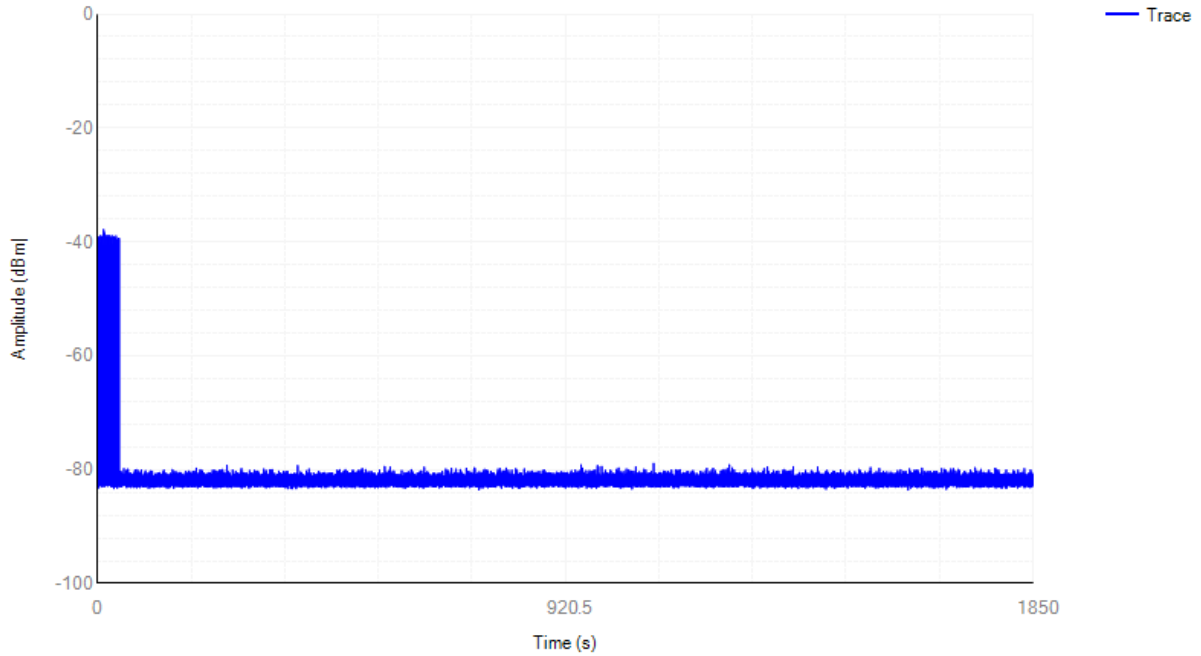



### Radar Waveform Calibration

### Radar Type 0

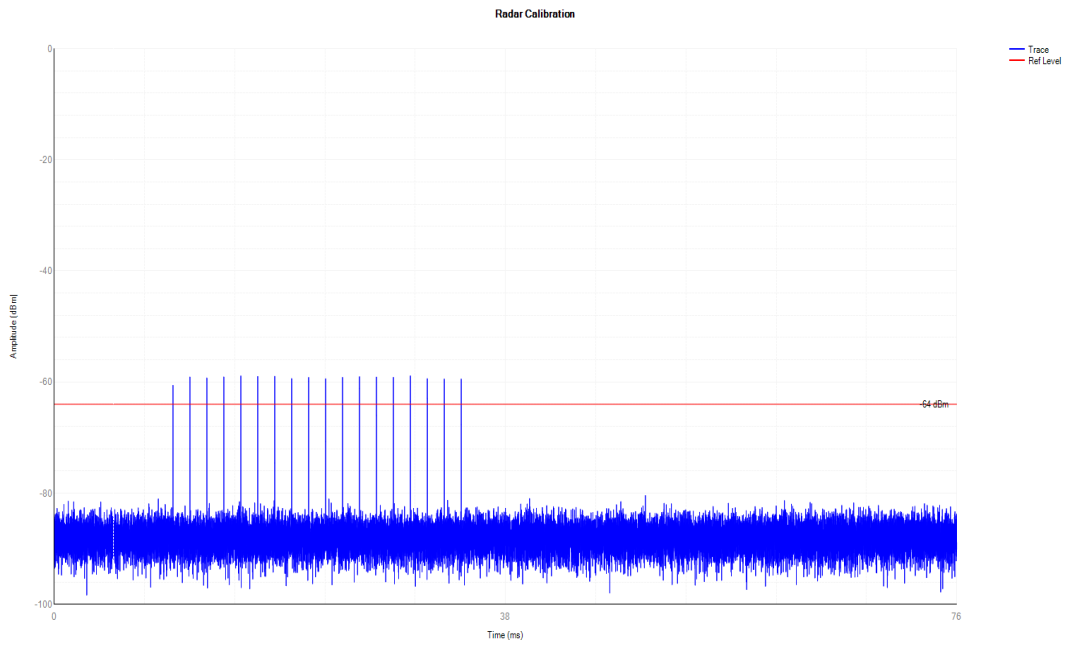

### Radar Type 1 (PRI=918us and the number of pulses=58)

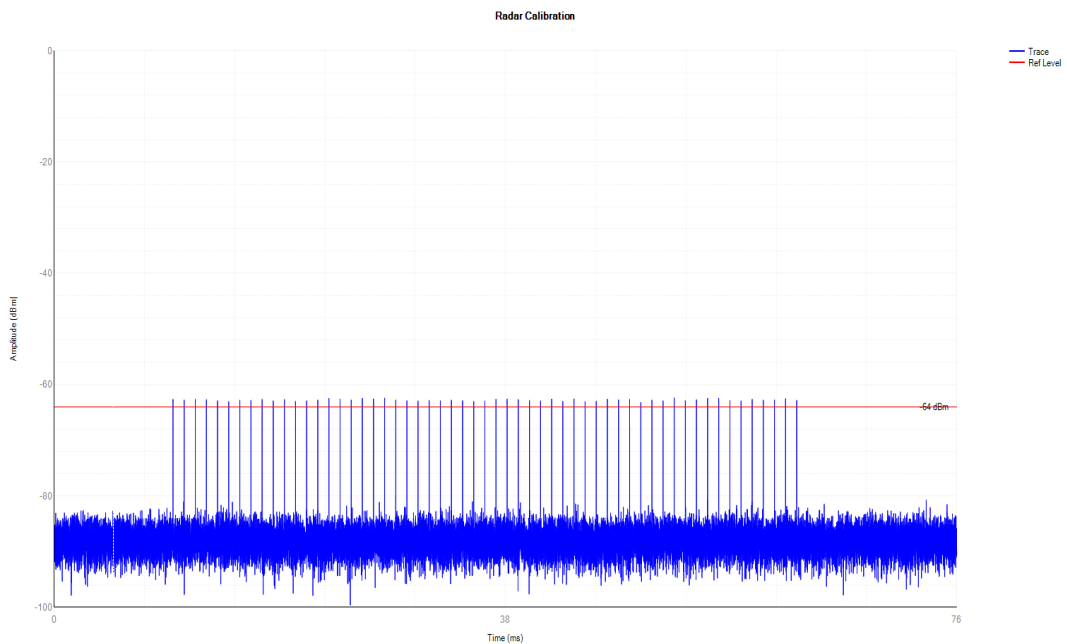



### Radar Type 2

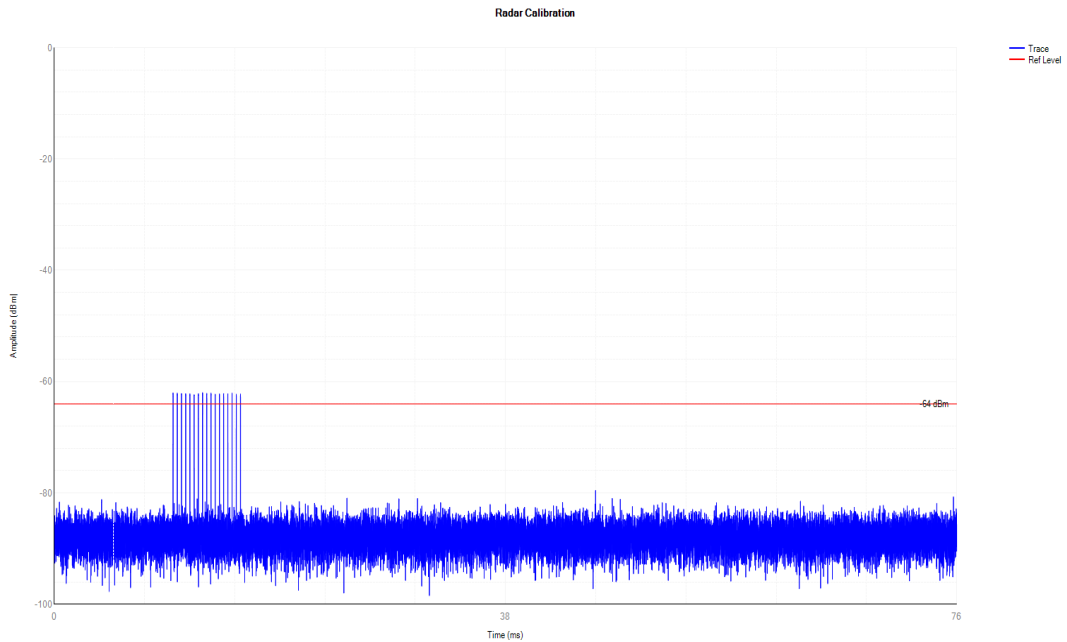
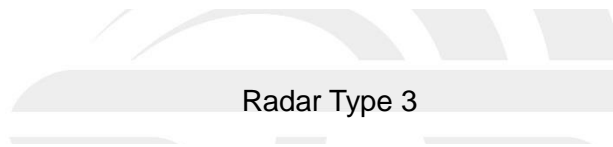
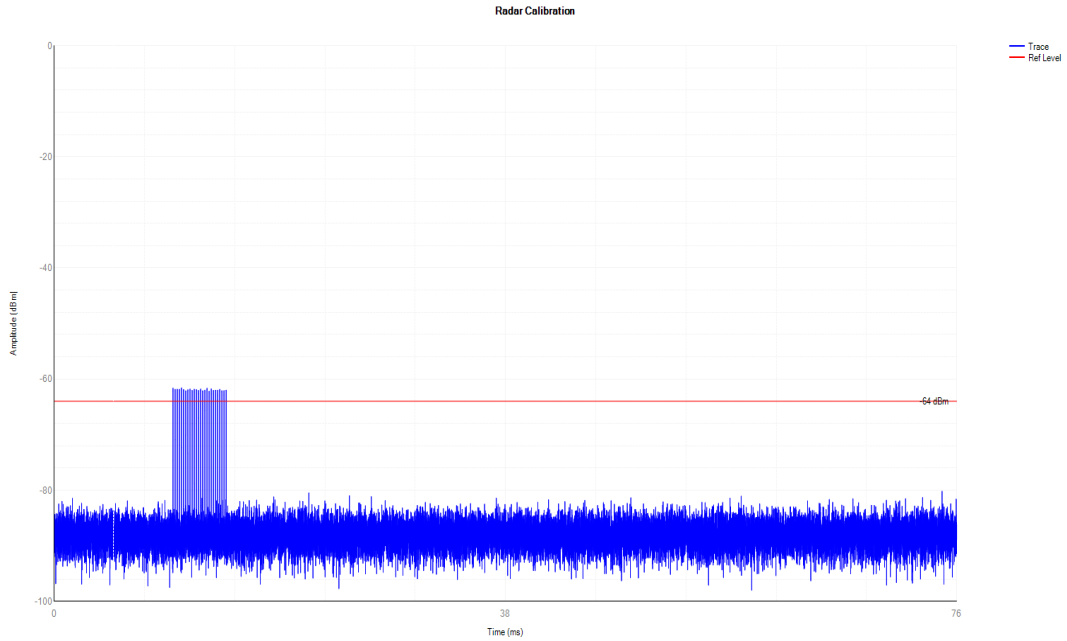



### Radar Type 4

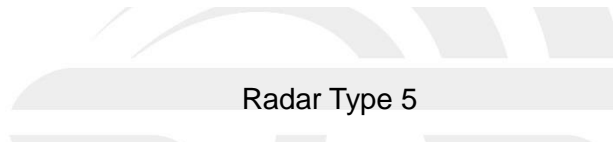
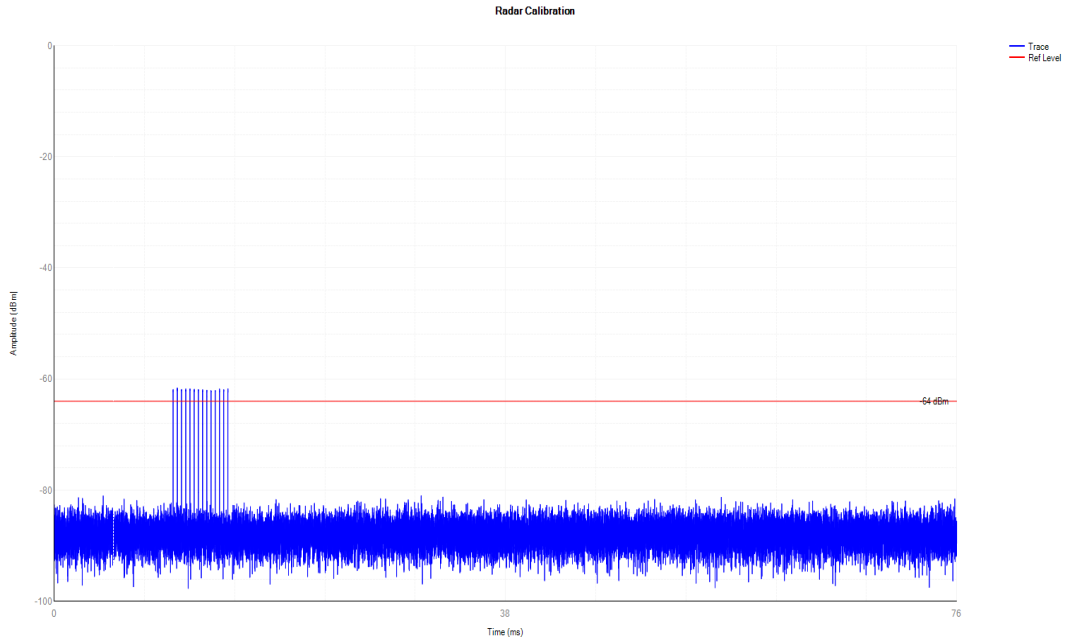

### Radar Type 5

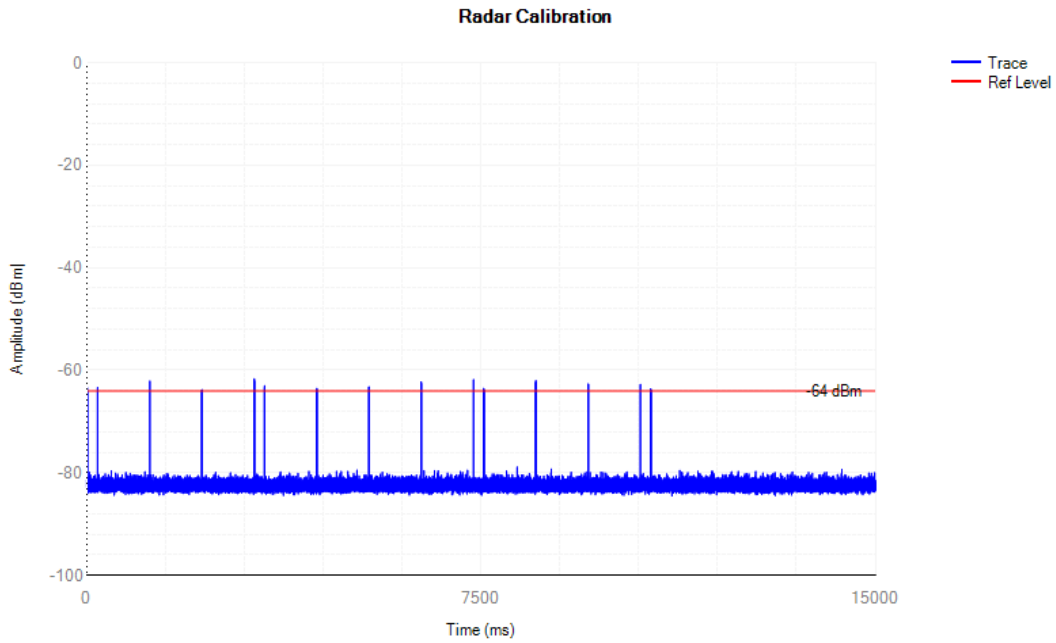





### Radar Type 6

#### Radar Calibration

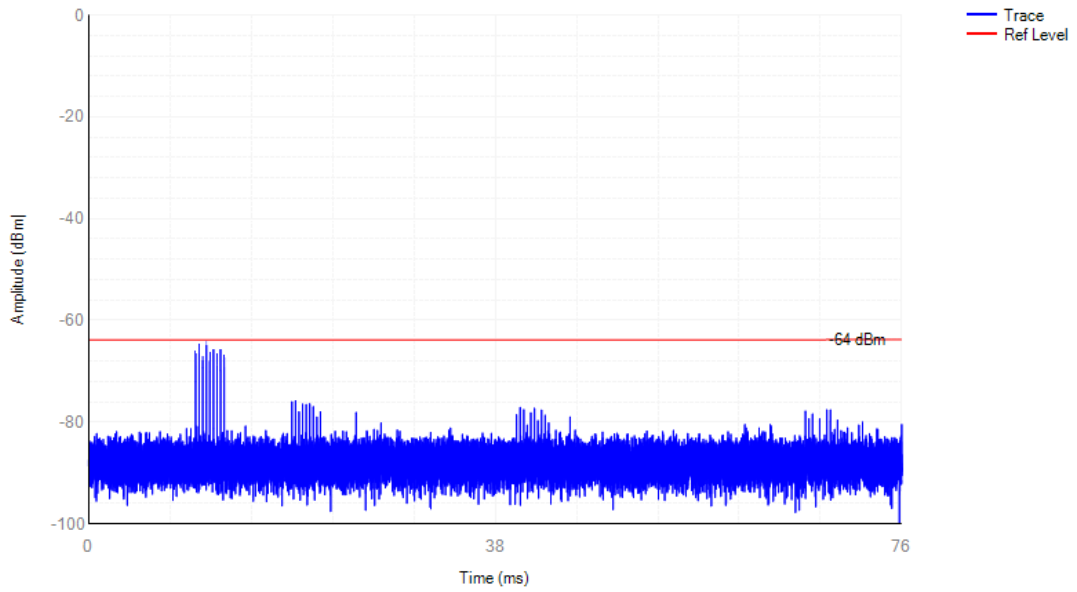

### 3.2.5 DFS Test photo



※※※※END OF THE REPORT※※※※