



RADIO TEST REPORT

Report No.:STS2205155W05

Issued for

Winmate Inc.

9F, No.111-6, Shing-De Rd., San-Chung Dist., New Taipei
City24158, Taiwan, R.O.C

Product Name:	Rugged Tablet PC
Brand Name:	Winmate Inc.
Model Name:	S101TG
Series Model:	S101XXXXXXXXXXXXX , (Where X can be A-Z,a-z,0-9,"-",Blank or Slash)
FCC ID:	PX9S101
Test Standard:	FCC Part 15.407

Any reproduction of this document must be done in full. No single part of this document may be reproduced without permission from STS, all test data presented in this report is only applicable to presented test sample.

Shenzhen STS Test Services Co., Ltd.
A 1/F, Building B, Zhuoke Science Park, No.190 Chongqing Road, HepingShequ,
Fuyong Sub-District, Bao'an District, Shenzhen, Guang Dong, China
TEL: +86-755 3688 6288 FAX: +86-755 3688 6277 E-mail:sts@stsapp.com





TEST RESULT CERTIFICATION

Applicant's Name..... : Winmate Inc.
 Address : 9F, No.111-6, Shing-De Rd., San-Chung Dist., New Taipei City24158, Taiwan, R.O.C
Manufacturer's Name : Winmate Inc.
 Address : 9F, No.111-6, Shing-De Rd., San-Chung Dist., New Taipei City24158, Taiwan, R.O.C

Product Description

Product Name..... : Rugged Tablet PC
 Brand Name : Winmate Inc.
 Model Name : S101TG
 Series Model..... : S101XXXXXXXXXXXXX , (Where X can be A-Z,a-z,0-9,"-","Blank or Slash)

Test Standards : FCC Part15.407

Test Procedure..... ANSI C63.10-2013

This device described above has been tested by STS, the test results show that the equipment under test (EUT) is in compliance with the FCC requirements. And it is applicable only to the tested sample identified in the report.

This report shall not be reproduced except in full, without the written approval of STS, this document only be altered or revised by STS, personal only, and shall be noted in the revision of the document.

Date of Test :
 Date of receipt of test item : 07 June 2022
 Date (s) of performance of tests : 07 June 2022 ~ 17 June 2022
 Date of Issue..... : 17 June 2022
 Test Result..... : **Pass**

Testing Engineer : 

 (Chris Chen)

Technical Manager : 

 (Sean she)

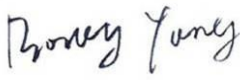
Authorized Signatory : 

 (Bovey Yang)





Table of Contents	Page
1 . SUMMARY OF TEST RESULTS	6
1.1 TEST FACTORY	7
1.2 MEASUREMENT UNCERTAINTY	7
2 . GENERAL INFORMATION	8
2.1 GENERAL DESCRIPTION OF THE EUT	8
2.2 DESCRIPTION OF TEST MODES	12
2.3 TEST SOFTWARE AND POWER LEVEL	13
2.4 BLOCK DIAGRAM SHOWING THE CONFIGURATION OF SYSTEM TESTED	15
2.5 DESCRIPTION OF NECESSARY ACCESSORIES AND SUPPORT UNITS	16
2.6 EQUIPMENTS LIST FOR ALL TEST ITEMS	17
3 . EMC EMISSION TEST	18
3.1 CONDUCTED EMISSION MEASUREMENT	18
3.2 RADIATED EMISSION AND (BANDEDGE) MEASUREMENT	22
4. POWER SPECTRAL DENSITY TEST	67
4.1 LIMIT	67
4.2 TEST PROCEDURE	67
4.3 DEVIATION FROM STANDARD	68
4.4 TEST SETUP	68
4.5 EUT OPERATION CONDITIONS	68
4.6 TEST RESULTS	68
5. BANDWIDTH MEASUREMENT	69
5.1 EMISSION BANDWIDTH (EBW) 26 BANDWID PROCEDURES / LIMIT	69
5.2 OCCUPIED BANDWIDTH (99%) TEST APPLIED PROCEDURES / LIMIT	70
5.3 MINIMUM EMISSION BANDWIDTH(6 DB) PROCEDURES / LIMIT	71
6. MAXIMUM CONDUCTED OUTPUT POWER	72
6.1 LIMIT	72
6.2 TEST PROCEDURE	72
6.3 DEVIATION FROM STANDARD	72
6.4 TEST SETUP	72
6.5 EUT OPERATION CONDITIONS	72
6.6 TEST RESULTS	72
7. AUTOMATICALLY DISCONTINUE TRANSMISSION	73
7.1 LIMIT OF AUTOMATICALLY DISCONTINUE TRANSMISSION	73
7.2 TEST RESULT OF AUTOMATICALLY DISCONTINUE TRANSMISSION	73



Table of Contents	Page
8. ANTENNA REQUIREMENT	74
8.1 STANDARD REQUIREMENT	74
8.2 EUT ANTENNA	74
APPENDIX - PHOTOS OF TEST SETUP	75





Revision History

Rev.	Issue Date	Report NO.	Effect Page	Contents
00	17 June 2022	STS2205155W05	ALL	Initial Issue





1. SUMMARY OF TEST RESULTS

Test procedures according to the technical standards:

§ 15.407, KDB 789033 D02 General U-NII Test Procedures New Rules v02r01

FCC Part 15.407		
FCC standard	Test Item	Results
15.207	AC Conducted Emission	PASS
15.407 (a) /15.407 (e)	26dB/6dB &99% Bandwidth	PASS
15.407(a)	Maximum Conducted Output Power	PASS
15.407(b)/15.205/15.209	Radiated Emission And (bandedge Emissions) Measurement	PASS
15.407(a)	Power Spectral Density	PASS
15.407(c)	Automatically Discontinue Transmission	PASS
15.203/15.204	Antenna Requirement	PASS

NOTE:

- (1) 'N/A' denotes test is not applicable in this Test Report.
- (2) All tests are according to ANSI C63.10-2013.



1.1 TEST FACTORY

SHENZHEN STS TEST SERVICES CO., LTD

Add. : A 1/F, Building B, Zhuoke Science Park, No.190 Chongqing Road, HepingShequ, Fuyong Sub-District, Bao'an District, Shenzhen, Guang Dong, China

FCC test Firm Registration Number: 625569

IC test Firm Registration Number: 12108A

A2LA Certificate No.: 4338.01

1.2 MEASUREMENT UNCERTAINTY

The reported uncertainty of measurement $y \pm U$, where expanded uncertainty U is based on a standard uncertainty multiplied by a coverage factor of $k=2$, providing a level of confidence of approximately **95 %**.

No.	Item	Uncertainty
1	RF output power, conducted	$\pm 0.87\text{dB}$
2	Unwanted Emissions, conducted	$\pm 2.895\text{dB}$
3	All emissions, radiated 9K-30MHz	$\pm 3.80\text{dB}$
4	All emissions, radiated 30M-1GHz	$\pm 4.09\text{dB}$
5	All emissions, radiated 1G-6GHz	$\pm 4.92\text{dB}$
6	All emissions, radiated >6G	$\pm 5.49\text{dB}$
7	Conducted Emission (9KHz-30MHz)	$\pm 2.73\text{dB}$



2. GENERAL INFORMATION
2.1 GENERAL DESCRIPTION OF THE EUT

Product Name	Rugged Tablet PC	
Trade Name	Winmate Inc.	
Model Name	S101TG	
Series Model	S101XXXXXXXXXXXXX , (Where X can be A-Z,a-z,0-9,"-",Blank or Slash)	
Model Difference	Only for Marketing purpose .	
Product Description	The EUT is a Rugged Tablet PC	
	Operation Frequency:	IEEE 802.11a/n(HT20)/ac(VHT20)/ax(HE20): 5.180GHz-5.240GHz IEEE 802.11n(HT40)/ac(VHT40)/ax(HE40): 5.190GHz-5.230GHz IEEE 802.11ac(VHT80)/ax(HE80): 5.210GHz IEEE 802.11a/ n(HT20)/ac(VHT20)/ax(HE20): 5.260GHz-5.320GHz IEEE 802.11 n(HT40)/ac(VHT40)/ax(HE40): 5.270GHz-5.310GHz IEEE 802.11ac(VHT80)/ax(HE80): 5.290GHz IEEE 802.11ax(HE160): 5.250GHz IEEE 802.11a/ n(HT20)/ac(VHT20)/ax(HE20): 5.500GHz-5.700GHz IEEE 802.11 n(HT40)/ac(VHT40)/ax(HE40): 5.510GHz-5.670GHz IEEE 802.11ac(VHT80)/ax(HE80): 5.530GHz-5.610GHz IEEE 802.11ax(HE160): 5.570GHz IEEE 802.11a/ n(HT20)/ac(VHT20)/ax(HE20): 5.745GHz-5.825GHz IEEE 802.11a/ n(HT40)/ac(VHT40)/ax(HE40): 5.755GHz-5.795GHz IEEE 802.11ac(VHT80)/ax(H80): 5.775GHz
	Modulation Type:	IEEE 802.11a/n(HT20)/ac(VHT20)/ax(HE20): 5.180GHz-5.240GHz IEEE 802.11n(HT40)/ac(VHT40)/ax(HE40): 5.190GHz-5.230GHz IEEE 802.11ac(VHT80)/ax(HE80): 5.210GHz 802.11ax(OFDM, OFDMA):BPSK,QPSK, 16-QAM,64-QAM,256-QAM,1024QAM
	Antenna Designation:	Please refer to the Note 3.
	Max.Output Power(Conducted):	14.23 dBm
	More details of EUT technical specification, please refer to the User Manual.	
	Test Channel	Please refer to the Note 2.
	Adapter	Input: AC100-240V 50-60Hz 2.0A Output: 19V 3.42A
	Battery	Rated Voltage:11.4V Charge Limit Voltage:13.05V Capacity: 3500mAh
	Hardware version number	S101TG-100



Software version number	005
Connecting I/O Port(s)	Please refer to the Note 1.

Note

1. For a more detailed features description, please refer to the manufacturer's specifications or the User Manual.

2.

Operation Frequency of channel			
5.180GHz-5.240GHz		5.500GHz-5.720GHz	
Channel	Frequency	Channel	Frequency
36	5180	100	5500
38	5190	102	5510
40	5200	104	5520
42	5210	106	5530
44	5220	108	5540
46	5230	110	5550
48	5240	112	5560
		116	5580
		118	5590
5.260GHz-5.320GHz			
Channel	Frequency		
52	5260	120	5600
54	5270	122	5610
56	5280	124	5620
58	5290	126	5630
60	5300	128	5640
62	5310	132	5660
64	5320	134	5670
		136	5680
		140	5700
5.745GHz-5.825GHz			
Channel	Frequency		
149	5745		
151	5755		
153	5765		
157	5785		
159	5795		
161	5805		
165	5825		

Note:

In section 15.31(m), regards to the operating frequency range over 10 MHz, the Lowest frequency, the middle frequency, and the highest frequency of channel were selected to perform the test, and the selected channel see below:

Carrier Frequency Channel

5GHz:

For 802.11a/n(HT20)/ac(VHT20)/ax(HE20)			
Channel	Freq.(MHz)	Channel	Freq.(MHz)
36	5180	52	5260
40	5200	60	5300
48	5240	64	5320



For 802.11a/n(HT20)/ac(VHT20)/ax(HE20)			
Channel	Freq.(MHz)	Channel	Freq.(MHz)
100	5500	149	5745
116	5580	157	5785
140	5700	165	5825

For 802.11 n(HT40)/ac(VHT40)/ax(HE40)			
Channel	Freq.(MHz)	Channel	Freq.(MHz)
38	5190	54	5270
46	5230	62	5310

For 802.11 n(HT40)/ac(VHT40)/ax(HE40)			
Channel	Freq.(MHz)	Channel	Freq.(MHz)
102	5510	151	5755
110	5550	159	5795
134	5670		

For 802.11ac(VHT80)/ax(HE80)			
Channel	Freq.(MHz)	Channel	Freq.(MHz)
42	5210	58	5290

For 802.11ac(VHT80)/ax(HE80)			
Channel	Freq.(MHz)	Channel	Freq.(MHz)
106	5530	155	5775
122	5610		

For 802.11ax(VHT160)			
Channel	Freq.(MHz)	Channel	Freq.(MHz)
50	5250	114	5570



- 3. KDB 662911 D01 Multiple Transmitter Output v02r01
 - 2) Directional Gain Calculations for In-Band Measurements
 - a) Basic methodology with NANT transmit antennas, each with the same directional gain GANT dBi, being driven by NANT transmitter outputs of equal power. Directional gain is to be computed as follows:
 - (i) If any transmit signals are correlated with each other, Directional gain = GANT + 10 log(NANT) dBi
 - (ii) If all transmit signals are completely uncorrelated with each other, Directional gain = GANT

Antenna number: 2
 Antenna A gain : 1.3dBi
 Antenna B gain : 3.9dBi
 GANT + 10 log(NANT) dBi
 Directional gain= 4.5+10log2=5.71dBi

Ant	Brand	Model Name	Ant Type	Connector	Gain (dBi)	NOTE
A	Winmate Inc.	S101TG	PIFA Antenna	N/A	ANT A: 1.3 ANT B: 3.9 MIMO A+B: 5.71	WLAN Ant

Note: The antenna information refer the manufacturer provide report, applicable only to the tested sample identified in the report.





2.2 DESCRIPTION OF TEST MODES

To investigate the maximum EMI emission characteristics generated from EUT, the test system was pre-scanning tested based on the consideration of following EUT operation mode or test configuration mode which possibly have effect on EMI emission level. Each of these EUT operation mode(s) or test configuration mode(s) mentioned above was evaluated respectively.

Worst Mode	Description	Data Rate
Mode 1	TX IEEE 802.11a HT20 CH36&CH40&CH48	6 Mbps
Mode 2	TX IEEE 802.11a HT20 CH52&CH60&CH64	6 Mbps
Mode 3	TX IEEE 802.11a HT20 CH100&CH116&CH140	6 Mbps
Mode 4	TX IEEE 802.11a HT20 CH149&CH157&CH165	6 Mbps
Mode 5	TX IEEE 802.11n HT20 CH36&CH40&CH48	MCS 0
Mode 6	TX IEEE 802.11ac HT20 CH36&CH40&CH48	NSS1 MCS0
Mode 7	TX IEEE 802.11ax HE20 CH36&CH40&CH48	NSS1 MCS0
Mode 8	TX IEEE 802.11n HT20 CH52&CH60&CH64	MCS 0
Mode 9	TX IEEE 802.11ac HT20 CH52&CH60&CH64	NSS1 MCS0
Mode 10	TX IEEE 802.11ax HE20 CH52&CH60&CH64	NSS1 MCS0
Mode 11	TX IEEE 802.11n HT20 CH100&CH116&CH140	MCS 0
Mode 12	TX IEEE 802.11ac HT20 CH100&CH116&CH140	NSS1 MCS0
Mode 13	TX IEEE 802.11ax HE20 CH100&CH116&CH140	NSS1 MCS0
Mode 14	TX IEEE 802.11n HT20 CH149&CH157&CH165	MCS 0
Mode 15	TX IEEE 802.11ac HT20 CH149&CH157&CH165	NSS1 MCS0
Mode 16	TX IEEE 802.11ax HE20 CH149&CH157&CH165	NSS1 MCS0
Mode 17	TX IEEE 802.11n HT40 CH38&CH46	MCS 0
Mode 18	TX IEEE 802.11ac HT40 CH38&CH46	NSS1 MCS0
Mode 19	TX IEEE 802.11ax HE40 CH38&CH46	NSS1 MCS0
Mode 20	TX IEEE 802.11n HT40 CH54 &CH62	MCS 0
Mode 21	TX IEEE 802.11ac HT40 CH54 &CH62	NSS1 MCS0
Mode 22	TX IEEE 802.11ax HE 40 CH54 &CH62	NSS1 MCS0
Mode 23	TX IEEE 802.11n HT40 CH102&CH110&CH134	MCS 0
Mode 24	TX IEEE 802.11ac HT40 CH102&CH110&CH134	NSS1 MCS0
Mode 25	TX IEEE 802.11ax HE40 CH102&CH110&CH134	NSS1 MCS0
Mode 26	TX IEEE 802.11n HT40 CH151&CH159	MCS 0
Mode 27	TX IEEE 802.11ac HT40 CH151&CH159	NSS1 MCS0



Mode 28	TX IEEE 802.11ax HE40 CH151&CH159	NSS1 MCS0
Mode 29	TX IEEE 802.11ac HT80 CH42	NSS1 MCS0
Mode 30	TX IEEE 802.11ac HT80 CH58	NSS1 MCS0
Mode 31	TX IEEE 802.11ac HT80 CH106&122	NSS1 MCS0
Mode 32	TX IEEE 802.11ac HT80 CH155	NSS1 MCS0
Mode 33	TX IEEE 802.11ax HE160 CH50	NSS1 MCS0
Mode 34	TX IEEE 802.11ax HE160 CH114	NSS1 MCS0

- Note: (1) The measurements are performed at the highest, middle, lowest available channels.
 (2) The measurements are performed at all Bit Rate of Transmitter, the worst data was reported.
 (3) We have be tested for all avaiable U.S. voltage and frequencies(For 120V,50/60Hz and 240V, 50/60Hz) for which the device is capable of operation.
 (4) The battery is fully-charged during the radited and RF conducted test.

AC Conducted Emission

Test Case	
AC Conducted Emission	Mode 35: Keeping TX + WLAN Link

2.3 TEST SOFTWARE AND POWER LEVEL

During testing channel & power controlling software provided by the customer was used to control the operating channel as well as the output power level.

RF Function	Type	Mode Or Modulation type	ANT Gain(dBi)	ANT_A Power Class	ANT_B Power Class	Software For Testing
WIFI(5G)	U-NII-1 (5150MHz-5250MHz)	802.11a	ANT A: 1.3 ANT B: 3.9 MIMO A+B: 5.71	10	10	DRTU
		802.11n(HT20)		10	10	
		802.11n(HT40)		10	10	
		802.11ac(VHT20)		10	10	
		802.11ac(VHT40)		10	10	
		802.11ac(VHT80)		10	10	
		802.11ac(VHT160)		10	10	
		802.11ax(HE20)		10	10	
		802.11ax(HE40)		10	10	
		802.11ax(HE80)		10	10	
		802.11ax(HE160)		10	10	



RF Function	Type	Mode Or Modulation type	ANT Gain(dBi)	ANT_A Power Class	ANT_B Power Class	Software For Testing
WIFI(5G)	U-NII-2A (5250MHz-5350MHz)	802.11a	ANT A: 1.3 ANT B: 3.9 MIMO A+B: 5.71	10	10	DRTU
		802.11n(HT20)		10	10	
		802.11n(HT40)		10	10	
		802.11ac(VHT20)		10	10	
		802.11ac(VHT40)		10	10	
		802.11ac(VHT80)		10	10	
		802.11ac(VHT160)		10	10	
		802.11ax(HE20)		10	10	
		802.11ax(HE40)		10	10	
		802.11ax(HE80)		10	10	
		802.11ax(HE160)		10	10	
RF Function	Type	Mode Or Modulation type	ANT Gain(dBi)	ANT_A Power Class	ANT_B Power Class	Software For Testing
WIFI(5G)	U-NII-2C (5470MHz-5725MHz)	802.11a	ANT A: 1.3 ANT B: 3.9 MIMO A+B: 5.71	10	10	DRTU
		802.11n(HT20)		10	10	
		802.11n(HT40)		10	10	
		802.11ac(VHT20)		10	10	
		802.11ac(VHT40)		10	10	
		802.11ac(VHT80)		10	10	
		802.11ac(VHT160)		10	10	
		802.11ax(HE20)		10	10	
		802.11ax(HE40)		10	10	
		802.11ax(HE80)		10	10	
		802.11ax(HE160)		10	10	

RF Function	Type	Mode Or Modulation type	ANT Gain(dBi)	ANT_A Power Class	ANT_B Power Class	Software For Testing
WIFI(5G)	U-NII-3 (5725MHz-5895MHz)	802.11a	ANT A: 1.3 ANT B: 3.9 MIMO A+B: 5.71	10	10	DRTU
		802.11n(HT20)		10	10	
		802.11n(HT40)		10	10	
		802.11ac(VHT20)		10	10	
		802.11ac(VHT40)		10	10	
		802.11ac(VHT80)		10	10	
		802.11ac(VHT160)		10	10	
		802.11ax(HE20)		10	10	
		802.11ax(HE40)		10	10	
		802.11ax(HE80)		10	10	
		802.11ax(HE160)		10	10	

2.4 BLOCK DIAGRAM SHOWING THE CONFIGURATION OF SYSTEM TESTED

Radiated Spurious Emission Test

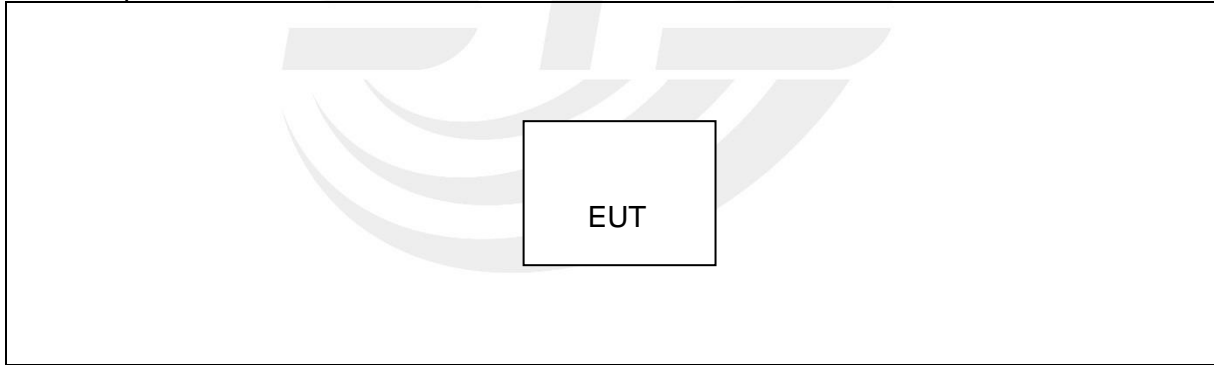

Conducted Emission Test

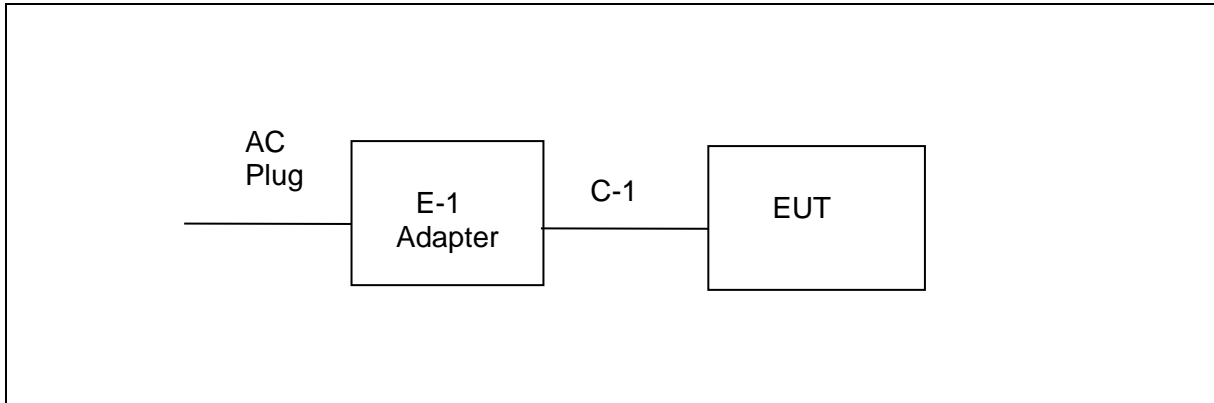



2.5 DESCRIPTION OF NECESSARY ACCESSORIES AND SUPPORT UNITS

The EUT has been tested as an independent unit together with other necessary accessories or support units. The following support units or accessories were used to form a representative test configuration during the tests.

Necessary accessories

Item	Equipment	Mfr/Brand	Model/Type No.	Length	Note
E-1	Adapter	Chicony	A18-065N3A	N/A	N/A
C-1	DC Cable	N/A	N/A	175cm	YES

Support units

Item	Equipment	Mfr/Brand	Model/Type No.	Length	Note
N/A	N/A	N/A	N/A	N/A	N/A

Note:

- (1) For detachable type I/O cable should be specified the length in cm in 『Length』 column.



2.6 EQUIPMENTS LIST FOR ALL TEST ITEMS

Radiation Test equipment

Kind of Equipment	Manufacturer	Type No.	Serial No.	Last calibration	Calibrated until
Test Receiver	R&S	ESCI	101427	2021.09.30	2022.09.29
Signal Analyzer	R&S	FSV 40-N	101823	2021.09.30	2022.09.29
Active loop Antenna	ZHINAN	ZN30900C	16035	2021.04.11	2023.04.10
Bilog Antenna	TESEQ	CBL6111D	34678	2020.10.12	2022.10.11
Horn Antenna	SCHWARZBECK	BBHA 9120D	02014	2021.10.11	2023.10.10
SHF-EHF Horn Antenna (18G-40GHz)	A-INFO	LB-180400-KF	J211020657	2020.10.12	2022.10.11
Pre-Amplifier (0.1M-3GHz)	EM	EM330	060665	2021.10.08	2022.10.07
Pre-Amplifier (1G-18GHz)	SKET	LNPA-01018G-45	SK2018080901	2021.09.30	2022.09.29
Pre-Amplifier (18G-40GHz)	SKET	LNPA-1840-50	SK2018101801	2021.09.28	2022.09.27
Temperature & Humidity	HH660	Mieo	N/A	2021.10.09	2022.10.08
Turn table	EM	SC100_1	60531	N/A	N/A
Antenna mast	EM	SC100	N/A	N/A	N/A
Test SW	FARAD	EZ-EMC(Ver.STSLAB-03A1 RE)			

Conduction Test equipment

Kind of Equipment	Manufacturer	Type No.	Serial No.	Last calibration	Calibrated until
Test Receiver	R&S	ESCI	101427	2021.09.30	2022.09.29
LISN	R&S	ENV216	101242	2021.09.30	2022.09.29
LISN	EMCO	3810/2NM	23625	2021.09.30	2022.09.29
Temperature & Humidity	HH660	Mieo	N/A	2021.10.09	2022.10.08
Test SW	FARAD	EZ-EMC(Ver.STSLAB-03A1 CE)			

RF Connected Test

Kind of Equipment	Manufacturer	Type No.	Serial No.	Last calibration	Calibrated until
Power Sensor	Keysight	U2021XA	MY55520005	2021.09.30	2022.09.29
			MY55520006	2021.09.30	2022.09.29
			MY56120038	2021.09.30	2022.09.29
			MY56280002	2021.09.30	2022.09.29
Signal Analyzer	Agilent	N9020A	MY51110105	2022.03.01	2023.02.28
Temperature & Humidity	HH660	Mieo	N/A	2021.10.09	2022.10.08
Test SW	FARAD	LZ-RF /LzRf-3A3			



3. EMC EMISSION TEST

3.1 CONDUCTED EMISSION MEASUREMENT

3.1.1 POWER LINE CONDUCTED EMISSION Limits (Frequency Range 150KHz-30MHz)

FREQUENCY (MHz)	Class B (dBuV)		Standard
	Quasi-peak	Average	
0.15 -0.5	66 - 56 *	56 - 46 *	CISPR
0.50 -5.0	56.00	46.00	CISPR
5.0 -30.0	60.00	50.00	CISPR

0.15 -0.5	66 - 56 *	56 - 46 *	FCC
0.50 -5.0	56.00	46.00	FCC
5.0 -30.0	60.00	50.00	FCC

Note:

- (1) The tighter limit applies at the band edges.
- (2) The limit of “ * ” marked band means the limitation decreases linearly with the logarithm of the frequency in the range.

The following table is the setting of the receiver

Receiver Parameters	Setting
Attenuation	10 dB
Start Frequency	0.15 MHz
Stop Frequency	30 MHz
IF Bandwidth	9 kHz

3.1.2 TEST PROCEDURE

- a. The EUT is 0.8 m from the horizontal ground plane and 0.4 m from the vertical ground plane with EUT being connected to the power mains through a line impedance stabilization network (LISN). All other support equipments are powered from additional LISN(s). The LISN provides 50 Ohm/ 50uH of coupling impedance for the measuring instrument.
- b. Interconnecting cables that hang closer than 40 cm to the ground plane shall be folded back and forth in the center forming a bundle 30 to 40 cm long.
- c. I/O cables that are not connected to a peripheral shall be bundled in the center. The end of the cable may be terminated, if required, using the correct terminating impedance. The overall length shall not exceed 1 m.
- d. LISN is at least 80 cm from the nearest part of EUT chassis.
- e. For the actual test configuration, please refer to the related Item –EUT Test Photos.

3.1.3 DEVIATION FROM TEST STANDARD

No deviation

3.1.4 TEST SETUP

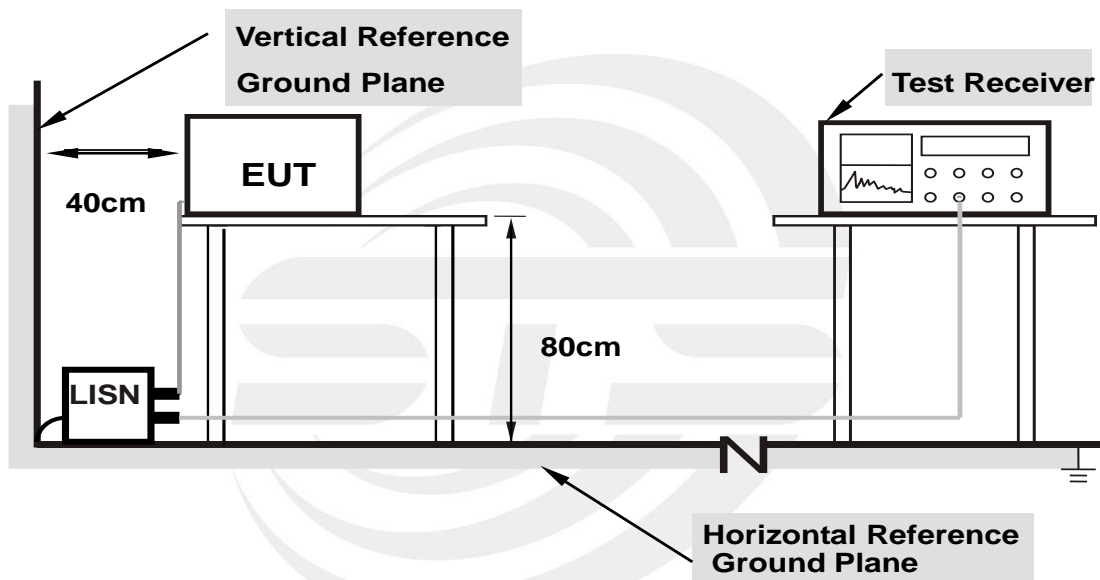

Note: 1. Support units were connected to second LISN.

2. Both of LISNs (AMN) are 80 cm from EUT and at least 80 cm from other units and other metal planes support units.

3.1.5 EUT OPERATING CONDITIONS

The EUT was configured for testing in a typical fashion (as a customer would normally use it). The EUT has been programmed to continuously transmit during test. This operating condition was tested and used to collect the included data.



3.1.6 TEST RESULTS

Temperature:	25.4(C)	Relative Humidity:	51%RH
Test Voltage:	AC 120V/60Hz	Phase:	L
Test Mode :	Mode 35		

No.	Frequency (MHz)	Reading (dBUV)	Correct Factor(dB)	Result (dBUV)	Limit (dBUV)	Margin (dB)	Remark
1	0.1620	41.33	20.33	61.66	65.36	-3.70	QP
2	0.1620	26.20	20.33	46.53	55.36	-8.83	AVG
3	0.2100	32.32	20.35	52.67	63.21	-10.54	QP
4	0.2100	15.92	20.35	36.27	53.21	-16.94	AVG
5	0.2940	26.23	20.72	46.95	60.41	-13.46	QP
6	0.2940	10.85	20.72	31.57	50.41	-18.84	AVG
7	4.3420	19.87	20.42	40.29	56.00	-15.71	QP
8	4.3420	4.96	20.42	25.38	46.00	-20.62	AVG
9	6.1900	20.35	20.53	40.88	60.00	-19.12	QP
10	6.1900	5.36	20.53	25.89	50.00	-24.11	AVG
11	17.2860	27.35	22.27	49.62	60.00	-10.38	QP
12	17.2860	17.49	22.27	39.76	50.00	-10.24	AVG

Remark:

1. All readings are Quasi-Peak and Average values
2. Margin = Result (Result = Reading + Factor) – Limit
3. Factor=LISN factor+Cable loss+Limiter (10dB)

100.0 dBUV

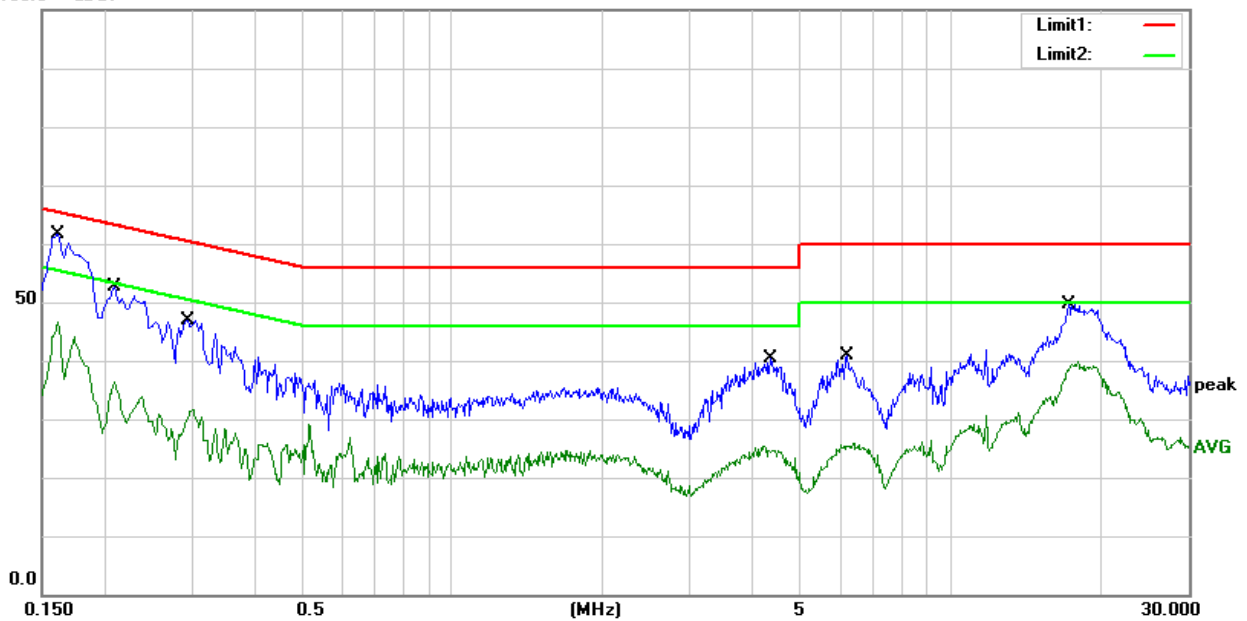



Temperature:	25.4(C)	Relative Humidity:	51%RH
Test Voltage	AC 120V/60Hz	Phase:	N
Test Mode	Mode 35		

No.	Frequency (MHz)	Reading (dBUV)	Correct Factor(dB)	Result (dBUV)	Limit (dBUV)	Margin (dB)	Remark
1	0.1580	40.51	20.31	60.82	65.57	-4.75	QP
2	0.1580	26.83	20.31	47.14	55.57	-8.43	AVG
3	0.2140	30.96	20.46	51.42	63.05	-11.63	QP
4	0.2140	14.49	20.46	34.95	53.05	-18.10	AVG
5	1.8060	14.17	20.38	34.55	56.00	-21.45	QP
6	1.8060	3.72	20.38	24.10	46.00	-21.90	AVG
7	4.3780	16.33	20.52	36.85	56.00	-19.15	QP
8	4.3780	5.40	20.52	25.92	46.00	-20.08	AVG
9	6.0660	17.23	20.55	37.78	60.00	-22.22	QP
10	6.0660	7.37	20.55	27.92	50.00	-22.08	AVG
11	18.5420	26.00	22.52	48.52	60.00	-11.48	QP
12	18.5420	16.64	22.52	39.16	50.00	-10.84	AVG

Remark:

1. All readings are Quasi-Peak and Average values
2. Margin = Result (Result =Reading + Factor) –Limit
3. Factor=LISN factor+Cable loss+Limiter (10dB)

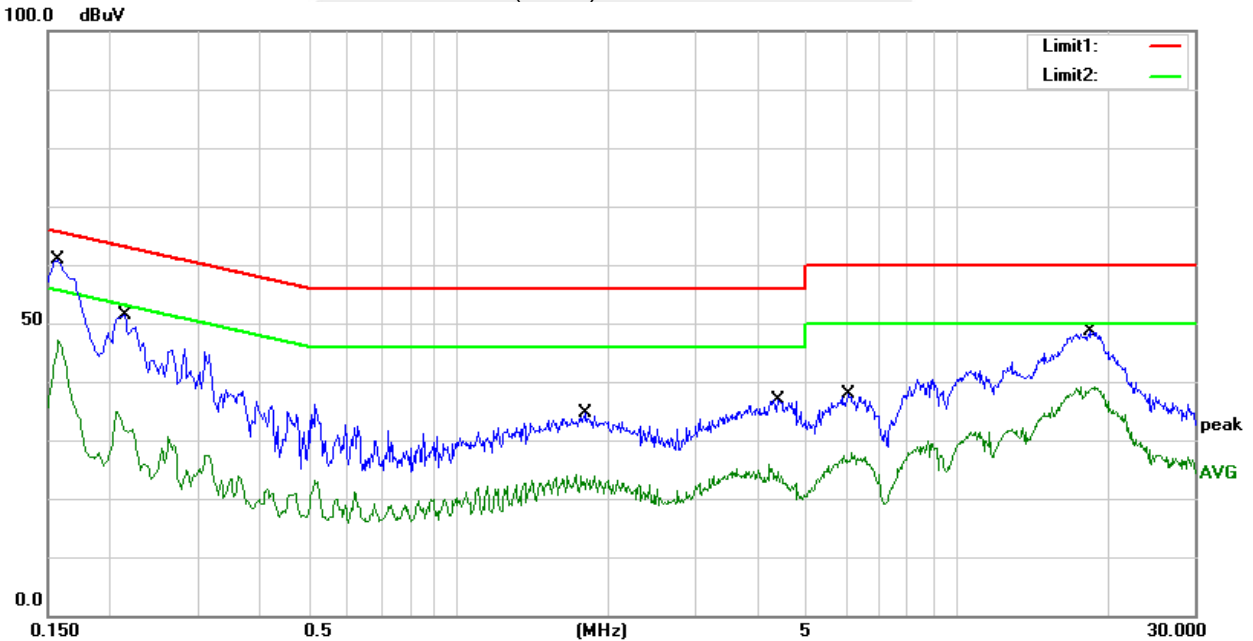

3.2 RADIATED EMISSION AND (BANDEDGE) MEASUREMENT

3.2.1 RADIATED EMISSION LIMITS (Frequency Range 9kHz-1000MHz)

In case the emission fall within the restricted band specified on 15.407(b)7&15.205/209(a), then the limit in the table below has to be followed.

Frequencies (MHz)	Field Strength (microrvolts/meter)	Measurement Distance (meters)
0.009~0.490	2400/F(KHz)	300
0.490~1.705	24000/F(KHz)	30
1.705~30.0	30	30
30~88	100	3
88~216	150	3
216~960	200	3
Above 960	500	3

LIMITS OF RADIATED EMISSION MEASUREMENT (Above 1000MHz)

FREQUENCY (MHz)	Class B (dBuV/m) (at 3M)	
	PEAK	AVERAGE
Above 1000	68.2	54

Notes:

- (1) The limit for radiated test was performed according to FCC PART 15E.
- (2) The tighter limit applies at the band edges.
- (3) Emission level (dBuV/m)=20log Emission level (uV/m).

LIMITS OF RESTRICTED FREQUENCY BANDS

FREQUENCY (MHz)	FREQUENCY (MHz)	FREQUENCY (MHz)	FREQUENCY (GHz)
0.090-0.110	16.42-16.423	399.9-410	4.5-5.15
0.495-0.505	16.69475-16.69525	608-614	5.35-5.46
2.1735-2.1905	16.80425-16.80475	960-1240	7.25-7.75
4.125-4.128	25.5-25.67	1300-1427	8.025-8.5
4.17725-4.17775	37.5-38.25	1435-1626.5	9.0-9.2
4.20725-4.20775	73-74.6	1645.5-1646.5	9.3-9.5
6.215-6.218	74.8-75.2	1660-1710	10.6-12.7
6.26775-6.26825	108-121.94	1718.8-1722.2	13.25-13.4
6.31175-6.31225	123-138	2200-2300	14.47-14.5
8.291-8.294	149.9-150.05	2310-2390	15.35-16.2
8.362-8.366	156.52475-156.52525	2483.5-2500	17.7-21.4
8.37625-8.38675	156.7-156.9	2690-2900	22.01-23.12
8.41425-8.41475	162.0125-167.17	3260-3267	23.6-24.0
12.29-12.293	167.72-173.2	3332-3339	31.2-31.8
12.51975-12.52025	240-285	3345.8-3358	36.43-36.5
12.57675-12.57725	322-335.4	3600-4400	Above 38.6
13.36-13.41			

Note: In case the emission radiated emission above 1000MHz fall within the restricted band the restricted frequency bands, the peak limit is 74 dBuV/m.

**LIMITS OF EMISSIONS OUTSIDE OF THE FREQUENCY BANDS**

Undesirable emission limits. Except as shown in paragraph (b)(7) of this section, the maximum emissions outside of the frequency bands of operation shall be attenuated in accordance with the following limits:

- (1) For transmitters operating in the 5.15-5.25 GHz band: All emissions outside of the 5.15-5.35 GHz band shall not exceed an e.i.r.p. of -27 dBm/MHz.
- (2) For transmitters operating in the 5.25-5.35 GHz band: All emissions outside of the 5.15-5.35 GHz band shall not exceed an e.i.r.p. of -27 dBm/MHz.
- (3) For transmitters operating in the 5.47-5.725 GHz band: All emissions outside of the 5.47-5.725 GHz band shall not exceed an e.i.r.p. of -27 dBm/MHz.
- (4) For transmitters operating in the 5.725-5.85 GHz band:
 - (i) All emissions shall be limited to a level of -27 dBm/MHz at 75 MHz or more above or below the band edge increasing linearly to 10 dBm/MHz at 25 MHz above or below the band edge, and from 25 MHz above or below the band edge increasing linearly to a level of 15.6 dBm/MHz at 5 MHz above or below the band edge, and from 5 MHz above or below the band edge increasing linearly to a level of 27 dBm/MHz at the band edge.

Note: $\text{dBuV/m(at 3M)} = \text{EIRP(dBm)} + 95.2$.

Peak Limit = $-27\text{dBm/MHz} + 95.3 = 68.2$ dBuV/m.

Spectrum Parameter	Setting
Attenuation	Auto
Detector	Peak
Start Frequency	1000 MHz(Peak/AV)
Stop Frequency	10th carrier harmonic (Peak/AV)
RB / VB (emission in restricted band)	1 MHz / 1 MHz, AV=1 MHz /3 MHz

For Band edge

Spectrum Parameter	Setting
Detector	Peak
RB / VB (emission in restricted band)	1 MHz / 1 MHz, AV=1 MHz /3 MHz

Receiver Parameter	Setting
Attenuation	Auto
Start ~ Stop Frequency	9kHz~90kHz / RB 200Hz for PK & AV
Start ~ Stop Frequency	90kHz~110kHz / RB 200Hz for QP
Start ~ Stop Frequency	110kHz~490kHz / RB 200Hz for PK & AV
Start ~ Stop Frequency	490kHz~30MHz / RB 9kHz for QP
Start ~ Stop Frequency	30MHz~1000MHz / RB 120kHz for QP



3.2.2 TEST PROCEDURE

- a. The measuring distance at 3 m shall be used for measurements at frequency 0.009MHz up to 1GHz, and above 1GHz.
- b. The EUT was placed on the top of a rotating table 0.8 m (above 1GHz is 1.5 m) above the ground at a 3 m anechoic chamber test site. The table was rotated 360 degree to determine the position of the highest radiation.
- c. The height of the equipment shall be 0.8 m (above 1GHz is 1.5 m); the height of the test antenna shall vary between 1 m to 4 m. Horizontal and vertical polarization of the antenna are set to make the measurement.
- d. The initial step in collecting conducted emission data is a spectrum analyzer peak detector mode pre-scanning the measurement frequency range. Significant peaks are then marked and QuasiPeak detector mode will be re-measured.
- e. If the Peak Mode measured value is compliance with and lower than Quasi Peak Mode Limit, the EUT shall be deemed to meet QP Limits and no additional QP Mode measurement was performed.
- f. For the actual test configuration, please refer to the related Item –EUT Test Photos.

Note:

Both horizontal and vertical antenna polarities were tested and performed pretest to three orthogonal axis. The worst case emissions were reported.

3.2.2 DEVIATION FROM TEST STANDARD

No deviation



3.2.3 TEST SETUP

(A) Radiated Emission Test-Up Frequency Below 30MHz

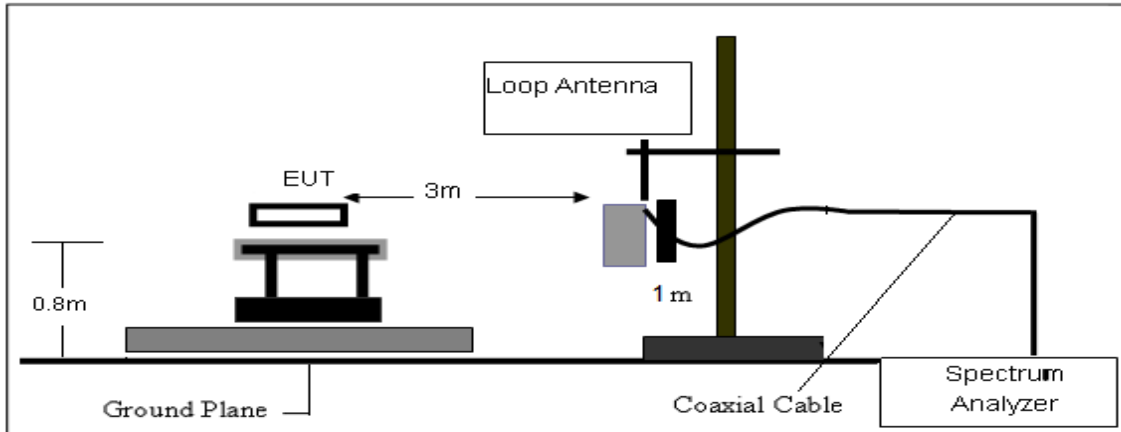

(B) Radiated Emission Test-Up Frequency 30MHz~1GHz

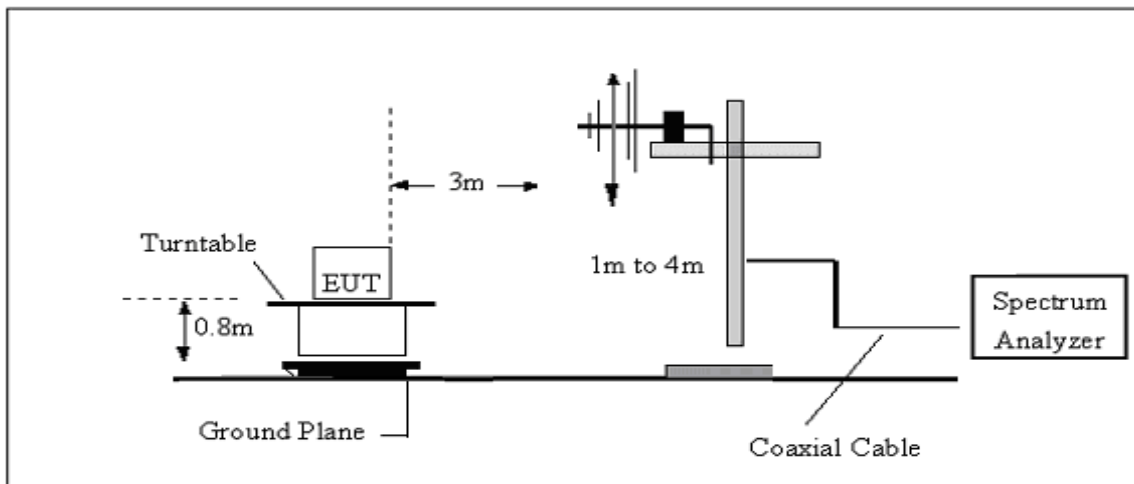

(C) Radiated Emission Test-Up Frequency Above 1GHz

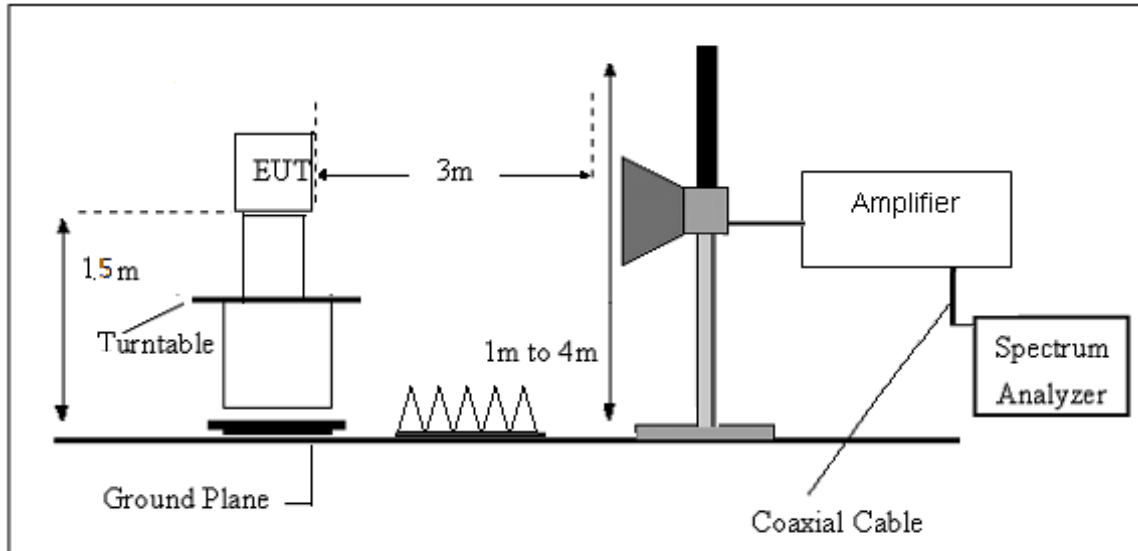



3.2.4 EUT OPERATING CONDITIONS

The EUT tested system was configured as the statements of 2.4 Unless otherwise a special operating condition is specified in the follows during the testing.

3.2.5 FIELD STRENGTH CALCULATION

The field strength is calculated by adding the Antenna Factor and Cable Factor and subtracting the Amplifier Gain and Duty Cycle Correction Factor (if any) from the measured reading. The basic equation with a sample calculation is as follows:

$$FS = RA + AF + CL - AG$$

Where

FS = Field Strength

CL = Cable Attenuation Factor (Cable Loss)

RA = Reading Amplitude

AG = Amplifier Gain

AF = Antenna Factor

For example

Frequency (MHz)	FS (dB μ V/m)	RA (dB μ V/m)	AF (dB)	CL (dB)	AG (dB)	Factor (dB)
300	40	58.1	12.2	1.6	31.9	-18.1

$$\text{Factor} = \text{AF} + \text{CL} - \text{AG}$$

**3.2.6 TEST RESULTS (Between 9KHz – 30 MHz)**

Temperature:	23.1(C)	Relative Humidity:	60%RH
Test Voltage:	DC 11.4V	Polarization :	--
Test Mode:	TX Mode		

Freq.	Reading	Limit	Margin	State
(MHz)	(dBuV/m)	(dBuV/m)	(dB)	P/F
--	--	--	--	PASS
--	--	--	--	PASS

Note:

The amplitude of spurious emissions which are attenuated by more than 20dB below the permissible value has no need to be reported.

Distance extrapolation factor = $40 \log(\text{specific distance}/\text{test distance})$ (dB);

Limit line = specific limits(dBuv) + distance extrapolation factor.

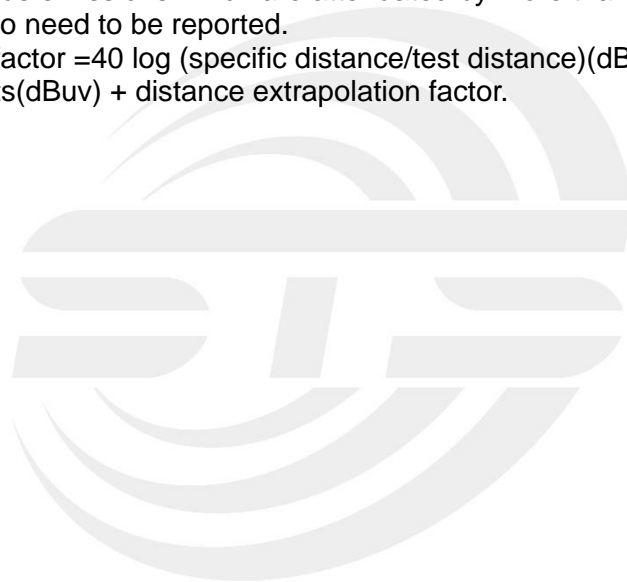



3.2.7 TEST RESULTS (Between 30MHz – 1GHz)

Temperature	23.1(C)	Relative Humidity:	60%RH
Test Voltage	DC 11.4V	Polarization:	Horizontal
Test Mode	Mode 1~34(Mode 23 worst mode)		

No.	Frequency (MHz)	Reading (dBuV)	Correct Factor(dB/m)	Result (dBuV/m)	Limit (dBuV/m)	Margin (dB)	Remark
1	33.8800	41.59	-14.80	26.79	40.00	-13.21	peak
2	161.9200	45.97	-19.01	26.96	43.50	-16.54	peak
3	311.3000	54.13	-14.40	39.73	46.00	-6.27	peak
4	359.8000	50.74	-12.87	37.87	46.00	-8.13	peak
5	546.0400	38.55	-6.20	32.35	46.00	-13.65	peak
6	904.9400	42.18	-0.32	41.86	46.00	-4.14	peak

Remark:

1. Margin = Result (Result =Reading + Factor)-Limit
2. Factor= Antenna factor+Cable attenuation factor(cable loss)-Amplifier gain

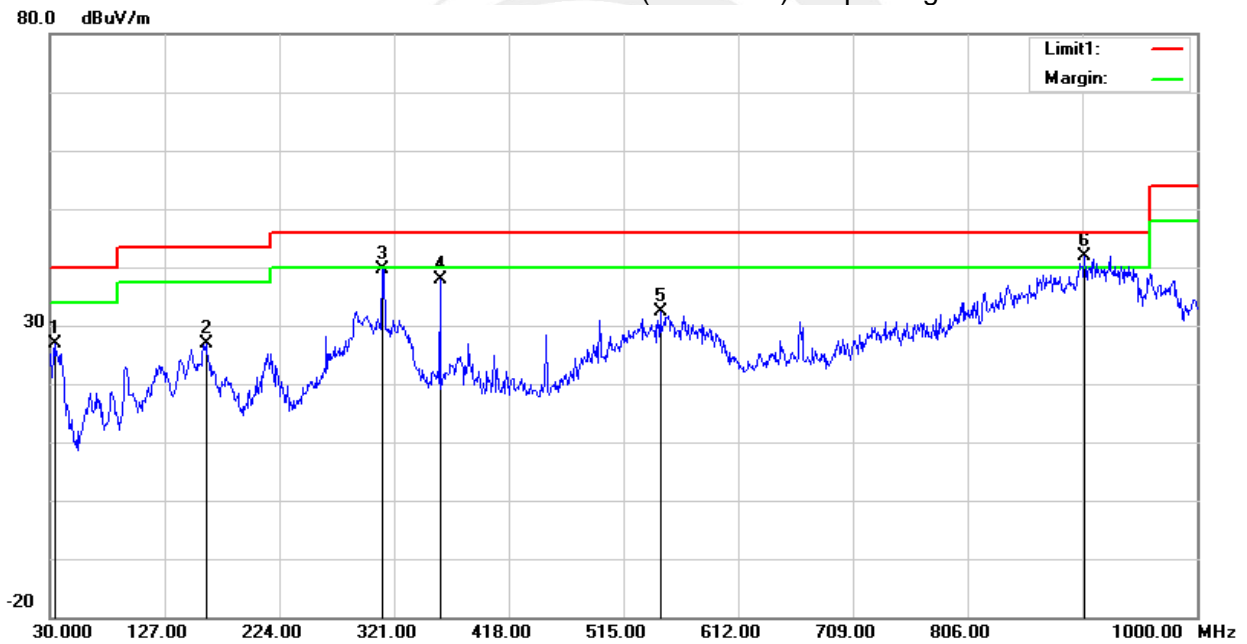



Temperature	23.1(C)	Relative Humidity:	60%RH
Test Voltage	DC 11.4V	Polarization:	Vertical
Test Mode	Mode 1~34(Mode 23 worst mode)		

No.	Frequency (MHz)	Reading (dBuV)	Correct Factor(dB/m)	Result (dBuV/m)	Limit (dBuV/m)	Margin (dB)	Remark
1	35.8200	45.93	-15.91	30.02	40.00	-9.98	peak
2	215.2700	50.96	-20.17	30.79	43.50	-12.71	peak
3	359.8000	47.89	-12.87	35.02	46.00	-10.98	peak
4	592.6000	39.75	-5.83	33.92	46.00	-12.08	peak
5	870.0200	38.23	-0.53	37.70	46.00	-8.30	peak
6	934.0400	37.36	0.89	38.25	46.00	-7.75	peak

Remark:

- Margin = Result (Result =Reading + Factor) –Limit
- Factor= Antenna factor+Cable attenuation factor(cable loss)-Amplifier gain

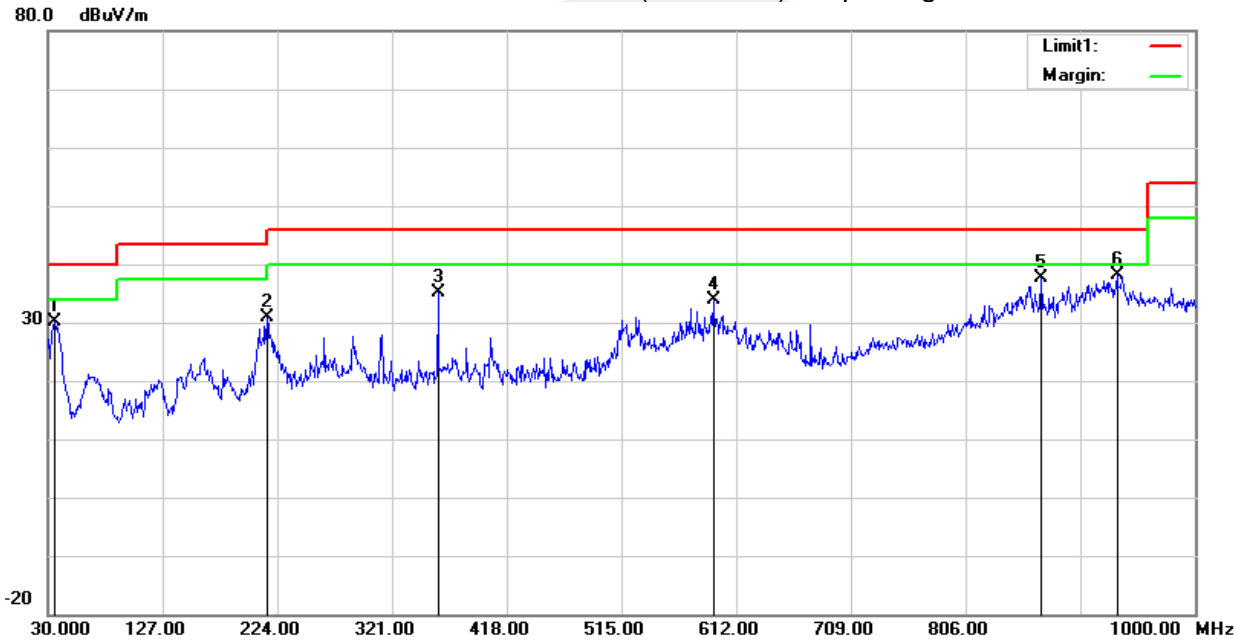



3.2.8 TEST RESULTS (Above 1000 MHz)

U-NII-1 5150-5250MHz

Frequency (MHz)	Reading	Amplifier	Loss	Antenna Factor	Orrected Factor	Emission Level	Limit (dBuV/m)	Margin	Detector	Comment
	(dBuV)	(dB)	(dB)	(dB/m)	(dB)	(dBuV/m)		(dB)		
Low Channel (802.11n(HT40)/ 5190 MHz)										
3264.44	44.39	44.70	6.70	28.20	-9.80	34.59	74.00	-39.41	Pk	Vertical
3264.44	41.63	44.70	6.70	28.20	-9.80	31.83	54.00	-22.17	AV	Vertical
3260.14	43.90	44.70	6.70	28.20	-9.80	34.10	74.00	-39.90	Pk	Horizontal
3260.14	42.12	44.70	6.70	28.20	-9.80	32.32	54.00	-21.68	AV	Horizontal
3999.69	39.65	44.20	7.90	29.70	-6.60	33.05	74.00	-40.95	Pk	Vertical
3999.69	35.86	44.20	7.90	29.70	-6.60	29.26	54.00	-24.74	AV	Vertical
3995.55	39.03	44.20	7.90	29.70	-6.60	32.43	74.00	-41.57	Pk	Horizontal
3995.55	36.35	44.20	7.90	29.70	-6.60	29.75	54.00	-24.25	AV	Horizontal
7231.44	37.85	43.50	11.40	35.50	3.40	41.25	68.20	-26.95	Pk	Vertical
7231.44	33.47	43.50	11.40	35.50	3.40	36.87	54.00	-17.13	AV	Vertical
7235.60	37.06	43.50	11.40	35.50	3.40	40.46	68.20	-27.74	Pk	Horizontal
7235.60	33.60	43.50	11.40	35.50	3.40	37.00	54.00	-17.00	AV	Horizontal
10360.25	39.67	44.50	13.80	38.80	8.10	47.77	68.20	-20.43	Pk	Vertical
10360.25	35.69	44.50	13.80	38.80	8.10	43.79	54.00	-10.21	AV	Vertical
10360.03	38.97	44.50	13.80	38.80	8.10	47.07	68.20	-21.13	Pk	Horizontal
10360.03	35.89	44.50	13.80	38.80	8.10	43.99	54.00	-10.01	AV	Horizontal
11024.13	34.18	43.60	14.30	39.50	10.20	44.38	74.00	-29.62	Pk	Vertical
11024.13	30.79	43.60	14.30	39.50	10.20	40.99	54.00	-13.01	AV	Vertical
11034.24	33.99	43.60	14.30	39.50	10.20	44.19	74.00	-29.81	Pk	Horizontal
11034.24	31.11	43.60	14.30	39.50	10.20	41.31	54.00	-12.69	AV	Horizontal
13292.99	31.81	42.60	15.90	38.90	12.20	44.01	74.00	-29.99	Pk	Vertical
13292.99	29.90	42.60	15.90	38.90	12.20	42.10	54.00	-11.90	AV	Vertical
13290.73	32.88	42.60	15.90	38.90	12.20	45.08	74.00	-28.92	Pk	Horizontal
13290.73	29.07	42.60	15.90	38.90	12.20	41.27	54.00	-12.73	AV	Horizontal
High Channel (802.11n(HT40)/ 5230 MHz)										
3265.18	44.05	44.70	6.70	28.20	-9.80	34.25	74.00	-39.75	Pk	Vertical
3265.18	41.43	44.70	6.70	28.20	-9.80	31.63	54.00	-22.37	AV	Vertical
3262.97	44.63	44.70	6.70	28.20	-9.80	34.83	74.00	-39.17	Pk	Horizontal
3262.97	41.11	44.70	6.70	28.20	-9.80	31.31	54.00	-22.69	AV	Horizontal
3994.62	40.01	44.20	7.90	29.70	-6.60	33.41	74.00	-40.59	Pk	Vertical
3994.62	35.95	44.20	7.90	29.70	-6.60	29.35	54.00	-24.65	AV	Vertical
3982.59	38.95	44.20	7.90	29.70	-6.60	32.35	74.00	-41.65	Pk	Horizontal
3982.59	36.00	44.20	7.90	29.70	-6.60	29.40	54.00	-24.60	AV	Horizontal
7221.52	37.66	43.50	11.40	35.50	3.40	41.06	68.20	-27.14	Pk	Vertical
7221.52	34.60	43.50	11.40	35.50	3.40	38.00	54.00	-16.00	AV	Vertical
7219.54	36.52	43.50	11.40	35.50	3.40	39.92	68.20	-28.28	Pk	Horizontal
7219.54	33.59	43.50	11.40	35.50	3.40	36.99	54.00	-17.01	AV	Horizontal
10400.33	39.92	44.50	13.80	38.80	8.10	48.02	68.20	-20.18	Pk	Vertical
10400.33	36.47	44.50	13.80	38.80	8.10	44.57	54.00	-9.43	AV	Vertical
10400.02	39.30	44.50	13.80	38.80	8.10	47.40	68.20	-20.80	Pk	Horizontal
10400.02	37.12	44.50	13.80	38.80	8.10	45.22	54.00	-8.78	AV	Horizontal
11030.90	32.75	43.60	14.30	39.50	10.20	42.95	74.00	-31.05	Pk	Vertical
11030.90	30.35	43.60	14.30	39.50	10.20	40.55	54.00	-13.45	AV	Vertical
11024.56	32.97	43.60	14.30	39.50	10.20	43.17	74.00	-30.83	Pk	Horizontal
11024.56	30.48	43.60	14.30	39.50	10.20	40.68	54.00	-13.32	AV	Horizontal
13283.96	32.83	42.60	15.90	38.90	12.20	45.03	74.00	-28.97	Pk	Vertical
13283.96	29.65	42.60	15.90	38.90	12.20	41.85	54.00	-12.15	AV	Vertical
13295.23	31.69	42.60	15.90	38.90	12.20	43.89	74.00	-30.11	Pk	Horizontal
13295.23	29.09	42.60	15.90	38.90	12.20	41.29	54.00	-12.71	AV	Horizontal

Remark:

- Factor = Antenna Factor + Cable Loss – Pre-amplifier.
- Scan with 802.11a,802.11n (HT-20),802.11n (HT-40), 802.11ac (VHT-20),802.11ac (VHT-40), 802.11ac (VHT-80), 802.11ax (HE-20),802.11ax (HE-40), 802.11ax (HE-80) the worst case is 802.11n (HT-40).
- The frequency emission of peak points that did not show above the forms are at least 20dB below the limit, the frequency emission is mainly from the environment noise.



U-NII-2A 5250-5350MHz

Frequency (MHz)	Reading	Amplifier	Loss	Antenna Factor	Orrected Factor	Emission Level	Limit (dBuV/m)	Margin	Detector	Comment
	(dBuV)	(dB)	(dB)	(dB/m)	(dB)	(dBuV/m)		(dB)		
802.11ac(VHT160)/ 5250 MHz)										
3263.39	45.05	44.70	6.70	28.20	-9.80	35.25	74.00	-38.75	Pk	Vertical
3263.39	41.20	44.70	6.70	28.20	-9.80	31.40	54.00	-22.60	AV	Vertical
3256.17	44.40	44.70	6.70	28.20	-9.80	34.60	68.20	-33.60	Pk	Horizontal
3256.17	40.80	44.70	6.70	28.20	-9.80	31.00	54.00	-23.00	AV	Horizontal
3980.57	39.50	44.20	7.90	29.70	-6.60	32.90	74.00	-41.10	Pk	Vertical
3980.57	36.87	44.20	7.90	29.70	-6.60	30.27	54.00	-23.73	AV	Vertical
3997.28	38.73	44.20	7.90	29.70	-6.60	32.13	74.00	-41.87	Pk	Horizontal
3997.28	36.92	44.20	7.90	29.70	-6.60	30.32	54.00	-23.68	AV	Horizontal
7224.61	37.78	43.50	11.40	35.50	3.40	41.18	68.20	-27.02	Pk	Vertical
7224.61	34.75	43.50	11.40	35.50	3.40	38.15	54.00	-15.85	AV	Vertical
7221.17	37.36	43.50	11.40	35.50	3.40	40.76	68.20	-27.44	Pk	Horizontal
7221.17	33.62	43.50	11.40	35.50	3.40	37.02	54.00	-16.98	AV	Horizontal
10520.28	39.43	44.50	13.90	38.80	8.20	47.63	68.20	-20.57	Pk	Vertical
10520.28	36.77	44.50	13.90	38.80	8.20	44.97	54.00	-9.03	AV	Vertical
10520.39	38.71	44.50	13.90	38.80	8.20	46.91	68.20	-21.29	Pk	Horizontal
10520.39	36.44	44.50	13.90	38.80	8.20	44.64	54.00	-9.36	AV	Horizontal
11029.92	33.35	43.60	14.30	39.50	10.20	43.55	74.00	-30.45	Pk	Vertical
11029.92	30.53	43.60	14.30	39.50	10.20	40.73	54.00	-13.27	AV	Vertical
11035.51	34.16	43.60	14.30	39.50	10.20	44.36	74.00	-29.64	Pk	Horizontal
11035.51	30.31	43.60	14.30	39.50	10.20	40.51	54.00	-13.49	AV	Horizontal
13287.80	31.83	42.60	15.90	38.90	12.20	44.03	74.00	-29.97	Pk	Vertical
13287.80	29.17	42.60	15.90	38.90	12.20	41.37	54.00	-12.63	AV	Vertical
13284.88	32.73	42.60	15.90	38.90	12.20	44.93	74.00	-29.07	Pk	Horizontal
13284.88	29.45	42.60	15.90	38.90	12.20	41.65	54.00	-12.35	AV	Horizontal
High Channel (802.11n(HT40)/ 5670 MHz)										
3257.15	44.43	44.70	6.70	28.20	-9.80	34.63	68.20	-33.57	Pk	Vertical
3257.15	42.13	44.70	6.70	28.20	-9.80	32.33	54.00	-21.67	AV	Vertical
3259.68	45.14	44.70	6.70	28.20	-9.80	35.34	68.20	-32.86	Pk	Horizontal
3259.68	42.05	44.70	6.70	28.20	-9.80	32.25	54.00	-21.75	AV	Horizontal
3998.40	39.67	44.20	7.90	29.70	-6.60	33.07	74.00	-40.93	Pk	Vertical
3998.40	35.65	44.20	7.90	29.70	-6.60	29.05	54.00	-24.95	AV	Vertical
3989.08	38.66	44.20	7.90	29.70	-6.60	32.06	74.00	-41.94	Pk	Horizontal
3989.08	36.84	44.20	7.90	29.70	-6.60	30.24	54.00	-23.76	AV	Horizontal
7224.40	36.47	43.50	11.40	35.50	3.40	39.87	68.20	-28.33	Pk	Vertical
7224.40	34.46	43.50	11.40	35.50	3.40	37.86	54.00	-16.14	AV	Vertical
7228.93	36.68	43.50	11.40	35.50	3.40	40.08	68.20	-28.12	Pk	Horizontal
7228.93	34.00	43.50	11.40	35.50	3.40	37.40	54.00	-16.60	AV	Horizontal
10474.32	39.76	44.50	13.80	38.80	8.10	47.86	68.20	-20.34	Pk	Vertical
10474.32	36.50	44.50	13.80	38.80	8.10	44.60	54.00	-9.40	AV	Vertical
10470.79	39.20	44.50	13.80	38.80	8.10	47.30	68.20	-20.90	Pk	Horizontal
10470.79	36.84	44.50	13.80	38.80	8.10	44.94	54.00	-9.06	AV	Horizontal
11400.18	34.14	43.60	14.30	39.50	10.20	44.34	74.00	-29.66	Pk	Vertical
11400.18	30.59	43.60	14.30	39.50	10.20	40.79	54.00	-13.21	AV	Vertical
11400.22	32.91	43.60	14.30	39.50	10.20	43.11	74.00	-30.89	Pk	Horizontal
11400.22	30.12	43.60	14.30	39.50	10.20	40.32	54.00	-13.68	AV	Horizontal
13286.52	32.87	42.60	15.90	38.90	12.20	45.07	74.00	-28.93	Pk	Vertical
13286.52	29.56	42.60	15.90	38.90	12.20	41.76	54.00	-12.24	AV	Vertical
13294.36	31.65	42.60	15.90	38.90	12.20	43.85	74.00	-30.15	Pk	Horizontal
13294.36	29.93	42.60	15.90	38.90	12.20	42.13	54.00	-11.87	AV	Horizontal

Remark:

1. Factor = Antenna Factor + Cable Loss – Pre-amplifier.
2. Scan with 802.11a,802.11n (HT-20),802.11n (HT-40), 802.11ac (VHT-20),802.11ac (VHT-40), 802.11ac (VHT-80) , 802.11ax (HE-20),802.11ax (HE-40), 802.11ax (HE-80) the worst case is 802.11n (HT-40).
3. The frequency emission of peak points that did not show above the forms are at least 20dB below the limit, the frequency emission is mainly from the environment noise.



U-NII-2C 5470-5725MHz

Frequency (MHz)	Reading	Amplifier	Loss	Antenna Factor	Orrected Factor	Emission Level	Limit (dBuV/m)	Margin	Detector	Comment
	(dBuV)	(dB)	(dB)	(dB/m)	(dB)	(dBuV/m)		(dB)		
Low Channel (802.11n(HT40)/ 5510 MHz)										
3255.91	43.91	44.70	6.70	28.20	-9.80	34.11	68.20	-34.09	Pk	Vertical
3255.91	40.91	44.70	6.70	28.20	-9.80	31.11	54.00	-22.89	AV	Vertical
3263.21	44.73	44.70	6.70	28.20	-9.80	34.93	74.00	-39.07	Pk	Horizontal
3263.21	41.58	44.70	6.70	28.20	-9.80	31.78	54.00	-22.22	AV	Horizontal
4000.05	39.92	44.20	7.90	29.70	-6.60	33.32	74.00	-40.68	Pk	Vertical
4000.05	35.76	44.20	7.90	29.70	-6.60	29.16	54.00	-24.84	AV	Vertical
3982.37	39.51	44.20	7.90	29.70	-6.60	32.91	74.00	-41.09	Pk	Horizontal
3982.37	36.86	44.20	7.90	29.70	-6.60	30.26	54.00	-23.74	AV	Horizontal
7234.77	37.54	43.50	11.40	35.50	3.40	40.94	68.20	-27.26	Pk	Vertical
7234.77	34.42	43.50	11.40	35.50	3.40	37.82	54.00	-16.18	AV	Vertical
7233.50	37.55	43.50	11.40	35.50	3.40	40.95	68.20	-27.25	Pk	Horizontal
7233.50	34.78	43.50	11.40	35.50	3.40	38.18	54.00	-15.82	AV	Horizontal
10359.03	38.95	44.50	13.80	38.80	8.10	47.05	68.20	-21.15	Pk	Vertical
10359.03	36.64	44.50	13.80	38.80	8.10	44.74	54.00	-9.26	AV	Vertical
10347.69	39.66	44.50	13.80	38.80	8.10	47.76	68.20	-20.44	Pk	Horizontal
10347.69	35.79	44.50	13.80	38.80	8.10	43.89	54.00	-10.11	AV	Horizontal
11000.34	34.15	43.60	14.30	39.50	10.20	44.35	74.00	-29.65	Pk	Vertical
11000.34	29.72	43.60	14.30	39.50	10.20	39.92	54.00	-14.08	AV	Vertical
11000.33	33.73	43.60	14.30	39.50	10.20	43.93	74.00	-30.07	Pk	Horizontal
11000.33	29.77	43.60	14.30	39.50	10.20	39.97	54.00	-14.03	AV	Horizontal
13295.84	32.72	42.60	15.90	38.90	12.20	44.92	74.00	-29.08	Pk	Vertical
13295.84	29.51	42.60	15.90	38.90	12.20	41.71	54.00	-12.29	AV	Vertical
13289.56	32.58	42.60	15.90	38.90	12.20	44.78	74.00	-29.22	Pk	Horizontal
13289.56	28.98	42.60	15.90	38.90	12.20	41.18	54.00	-12.82	AV	Horizontal
Mid Channel (802.11n(HT40)/ 5550 MHz)										
3257.05	44.32	44.70	6.70	28.20	-9.80	34.52	68.20	-33.68	Pk	Vertical
3257.05	40.92	44.70	6.70	28.20	-9.80	31.12	54.00	-22.88	AV	Vertical
3253.53	44.36	44.70	6.70	28.20	-9.80	34.56	68.20	-33.64	Pk	Horizontal
3253.53	40.84	44.70	6.70	28.20	-9.80	31.04	54.00	-22.96	AV	Horizontal
3984.71	39.26	44.20	7.90	29.70	-6.60	32.66	74.00	-41.34	Pk	Vertical
3984.71	36.84	44.20	7.90	29.70	-6.60	30.24	54.00	-23.76	AV	Vertical
3984.38	39.95	44.20	7.90	29.70	-6.60	33.35	74.00	-40.65	Pk	Horizontal
3984.38	35.67	44.20	7.90	29.70	-6.60	29.07	54.00	-24.93	AV	Horizontal
7222.26	37.31	43.50	11.40	35.50	3.40	40.71	68.20	-27.49	Pk	Vertical
7222.26	34.23	43.50	11.40	35.50	3.40	37.63	54.00	-16.37	AV	Vertical
7230.21	37.85	43.50	11.40	35.50	3.40	41.25	68.20	-26.95	Pk	Horizontal
7230.21	34.88	43.50	11.40	35.50	3.40	38.28	54.00	-15.72	AV	Horizontal
10390.92	39.77	44.50	13.80	38.80	8.10	47.87	68.20	-20.33	Pk	Vertical
10390.92	36.65	44.50	13.80	38.80	8.10	44.75	54.00	-9.25	AV	Vertical
10388.76	39.31	44.50	13.80	38.80	8.10	47.41	68.20	-20.79	Pk	Horizontal
10388.76	36.39	44.50	13.80	38.80	8.10	44.49	54.00	-9.51	AV	Horizontal
11159.96	34.12	43.60	14.30	39.50	10.20	44.32	74.00	-29.68	Pk	Vertical
11159.96	30.87	43.60	14.30	39.50	10.20	41.07	54.00	-12.93	AV	Vertical
11160.24	33.14	43.60	14.30	39.50	10.20	43.34	74.00	-30.66	Pk	Horizontal
11160.24	30.11	43.60	14.30	39.50	10.20	40.31	54.00	-13.69	AV	Horizontal
13295.94	32.24	42.60	15.90	38.90	12.20	44.44	74.00	-29.56	Pk	Vertical
13295.94	28.72	42.60	15.90	38.90	12.20	40.92	54.00	-13.08	AV	Vertical
13289.47	31.94	42.60	15.90	38.90	12.20	44.14	74.00	-29.86	Pk	Horizontal
13289.47	29.08	42.60	15.90	38.90	12.20	41.28	54.00	-12.72	AV	Horizontal



High Channel (802.11n(HT40)/ 5670 MHz)										
3257.15	44.43	44.70	6.70	28.20	-9.80	34.63	68.20	-33.57	Pk	Vertical
3257.15	42.13	44.70	6.70	28.20	-9.80	32.33	54.00	-21.67	AV	Vertical
3259.68	45.14	44.70	6.70	28.20	-9.80	35.34	68.20	-32.86	Pk	Horizontal
3259.68	42.05	44.70	6.70	28.20	-9.80	32.25	54.00	-21.75	AV	Horizontal
3998.40	39.67	44.20	7.90	29.70	-6.60	33.07	74.00	-40.93	Pk	Vertical
3998.40	35.65	44.20	7.90	29.70	-6.60	29.05	54.00	-24.95	AV	Vertical
3989.08	38.66	44.20	7.90	29.70	-6.60	32.06	74.00	-41.94	Pk	Horizontal
3989.08	36.84	44.20	7.90	29.70	-6.60	30.24	54.00	-23.76	AV	Horizontal
7224.40	36.47	43.50	11.40	35.50	3.40	39.87	68.20	-28.33	Pk	Vertical
7224.40	34.46	43.50	11.40	35.50	3.40	37.86	54.00	-16.14	AV	Vertical
7228.93	36.68	43.50	11.40	35.50	3.40	40.08	68.20	-28.12	Pk	Horizontal
7228.93	34.00	43.50	11.40	35.50	3.40	37.40	54.00	-16.60	AV	Horizontal
10474.32	39.76	44.50	13.80	38.80	8.10	47.86	68.20	-20.34	Pk	Vertical
10474.32	36.50	44.50	13.80	38.80	8.10	44.60	54.00	-9.40	AV	Vertical
10470.79	39.20	44.50	13.80	38.80	8.10	47.30	68.20	-20.90	Pk	Horizontal
10470.79	36.84	44.50	13.80	38.80	8.10	44.94	54.00	-9.06	AV	Horizontal
11400.18	34.14	43.60	14.30	39.50	10.20	44.34	74.00	-29.66	Pk	Vertical
11400.18	30.59	43.60	14.30	39.50	10.20	40.79	54.00	-13.21	AV	Vertical
11400.22	32.91	43.60	14.30	39.50	10.20	43.11	74.00	-30.89	Pk	Horizontal
11400.22	30.12	43.60	14.30	39.50	10.20	40.32	54.00	-13.68	AV	Horizontal
13286.52	32.87	42.60	15.90	38.90	12.20	45.07	74.00	-28.93	Pk	Vertical
13286.52	29.56	42.60	15.90	38.90	12.20	41.76	54.00	-12.24	AV	Vertical
13294.36	31.65	42.60	15.90	38.90	12.20	43.85	74.00	-30.15	Pk	Horizontal
13294.36	29.93	42.60	15.90	38.90	12.20	42.13	54.00	-11.87	AV	Horizontal

Remark:

- Factor = Antenna Factor + Cable Loss – Pre-amplifier.
- Scan with 802.11a,802.11n (HT-20),802.11n (HT-40), 802.11ac (VHT-20),802.11ac (VHT-40), 802.11ac (VHT-80) , 802.11ax (HE-20),802.11ax (HE-40), 802.11ax (HE-80) the worst case is 802.11n (HT-40).
- The frequency emission of peak points that did not show above the forms are at least 20dB below the limit, the frequency emission is mainly from the environment noise.



U-NII-3 (5.725-5.850) GHz

Frequency (MHz)	Reading	Amplifier	Loss	Antenna Factor	Orrected Factor	Emission Level	Limit (dBuV/m)	Margin	Detector	Comment
	(dBuV)	(dB)	(dB)	(dB/m)	(dB)	(dBuV/m)		(dB)		
Low Channel (802.11n(HT40)/ 5755 MHz)										
3252.97	44.20	44.70	6.70	28.20	-9.80	34.40	68.20	-33.80	Pk	Vertical
3252.97	41.67	44.70	6.70	28.20	-9.80	31.87	54.00	-22.13	AV	Vertical
3246.30	44.77	44.70	6.70	28.20	-9.80	34.97	68.20	-33.23	Pk	Horizontal
3246.30	41.47	44.70	6.70	28.20	-9.80	31.67	54.00	-22.33	AV	Horizontal
3999.94	39.65	44.20	7.90	29.70	-6.60	33.05	74.00	-40.95	Pk	Vertical
3999.94	36.74	44.20	7.90	29.70	-6.60	30.14	54.00	-23.86	AV	Vertical
3988.18	39.82	44.20	7.90	29.70	-6.60	33.22	74.00	-40.78	Pk	Horizontal
3988.18	35.64	44.20	7.90	29.70	-6.60	29.04	54.00	-24.96	AV	Horizontal
7218.93	37.85	43.50	11.40	35.50	3.40	41.25	68.20	-26.95	Pk	Vertical
7218.93	33.96	43.50	11.40	35.50	3.40	37.36	54.00	-16.64	AV	Vertical
7226.27	36.86	43.50	11.40	35.50	3.40	40.26	68.20	-27.94	Pk	Horizontal
7226.27	34.54	43.50	11.40	35.50	3.40	37.94	54.00	-16.06	AV	Horizontal
10506.49	39.25	44.50	13.90	38.80	8.20	47.45	68.20	-20.75	Pk	Vertical
10506.49	36.55	44.50	13.90	38.80	8.20	44.75	54.00	-9.25	AV	Vertical
10500.99	39.30	44.50	13.90	38.80	8.20	47.50	68.20	-20.70	Pk	Horizontal
10500.99	36.54	44.50	13.90	38.80	8.20	44.74	54.00	-9.26	AV	Horizontal
11490.15	33.91	43.60	14.30	39.50	10.20	44.11	74.00	-29.89	Pk	Vertical
11490.15	30.05	43.60	14.30	39.50	10.20	40.25	54.00	-13.75	AV	Vertical
11490.04	32.91	43.60	14.30	39.50	10.20	43.11	74.00	-30.89	Pk	Horizontal
11490.04	30.73	43.60	14.30	39.50	10.20	40.93	54.00	-13.07	AV	Horizontal
13284.26	31.66	42.60	15.90	38.90	12.20	43.86	74.00	-30.14	Pk	Vertical
13284.26	29.70	42.60	15.90	38.90	12.20	41.90	54.00	-12.10	AV	Vertical
13289.69	31.77	42.60	15.90	38.90	12.20	43.97	74.00	-30.03	Pk	Horizontal
13289.69	29.75	42.60	15.90	38.90	12.20	41.95	54.00	-12.05	AV	Horizontal
High Channel (802.11n(HT40)/ 5795 MHz)										
3256.12	44.47	44.70	6.70	28.20	-9.80	34.67	68.20	-33.53	Pk	Vertical
3256.12	41.66	44.70	6.70	28.20	-9.80	31.86	54.00	-22.14	AV	Vertical
3250.60	44.39	44.70	6.70	28.20	-9.80	34.59	68.20	-33.61	Pk	Horizontal
3250.60	41.46	44.70	6.70	28.20	-9.80	31.66	54.00	-22.34	AV	Horizontal
3997.01	39.53	44.20	7.90	29.70	-6.60	32.93	74.00	-41.07	Pk	Vertical
3997.01	36.27	44.20	7.90	29.70	-6.60	29.67	54.00	-24.33	AV	Vertical
3999.01	39.93	44.20	7.90	29.70	-6.60	33.33	74.00	-40.67	Pk	Horizontal
3999.01	36.70	44.20	7.90	29.70	-6.60	30.10	54.00	-23.90	AV	Horizontal
7230.99	36.53	43.50	11.40	35.50	3.40	39.93	68.20	-28.27	Pk	Vertical
7230.99	34.85	43.50	11.40	35.50	3.40	38.25	54.00	-15.75	AV	Vertical
7224.37	37.64	43.50	11.40	35.50	3.40	41.04	68.20	-27.16	Pk	Horizontal
7224.37	33.72	43.50	11.40	35.50	3.40	37.12	54.00	-16.88	AV	Horizontal
10587.34	38.92	44.50	13.80	38.80	8.10	47.02	68.20	-21.18	Pk	Vertical
10587.34	35.79	44.50	13.80	38.80	8.10	43.89	54.00	-10.11	AV	Vertical
10600.31	39.01	44.50	13.80	38.80	8.10	47.11	74.00	-26.89	Pk	Horizontal
10600.31	37.05	44.50	13.80	38.80	8.10	45.15	54.00	-8.85	AV	Horizontal
11570.16	33.56	43.60	14.30	39.50	10.20	43.76	74.00	-30.24	Pk	Vertical
11570.16	30.59	43.60	14.30	39.50	10.20	40.79	54.00	-13.21	AV	Vertical
11570.18	32.86	43.60	14.30	39.50	10.20	43.06	74.00	-30.94	Pk	Horizontal
11570.18	31.05	43.60	14.30	39.50	10.20	41.25	54.00	-12.75	AV	Horizontal
13299.27	32.01	42.60	15.90	38.90	12.20	44.21	74.00	-29.79	Pk	Vertical
13299.27	28.90	42.60	15.90	38.90	12.20	41.10	54.00	-12.90	AV	Vertical
13288.26	32.31	42.60	15.90	38.90	12.20	44.51	74.00	-29.49	Pk	Horizontal
13288.26	29.75	42.60	15.90	38.90	12.20	41.95	54.00	-12.05	AV	Horizontal

Remark:

- Factor = Antenna Factor + Cable Loss – Pre-amplifier.
- Scan with 802.11a,802.11n (HT-20),802.11n (HT-40), 802.11ac (VHT-20),802.11ac (VHT-40), 802.11ac (VHT-80) , 802.11ax (HE-20),802.11ax (HE-40), 802.11ax (HE-80) the worst case is 802.11n (HT-20).
- The frequency emission of peak points that did not show above the forms are at least 20dB below the limit, the frequency emission is mainly from the environment noise.

3.2.9 RESTRICTED FREQUENCY BANDS AND BAND EDGE

U-NII-1 5150-5250MHz

802.11ax20-L-H

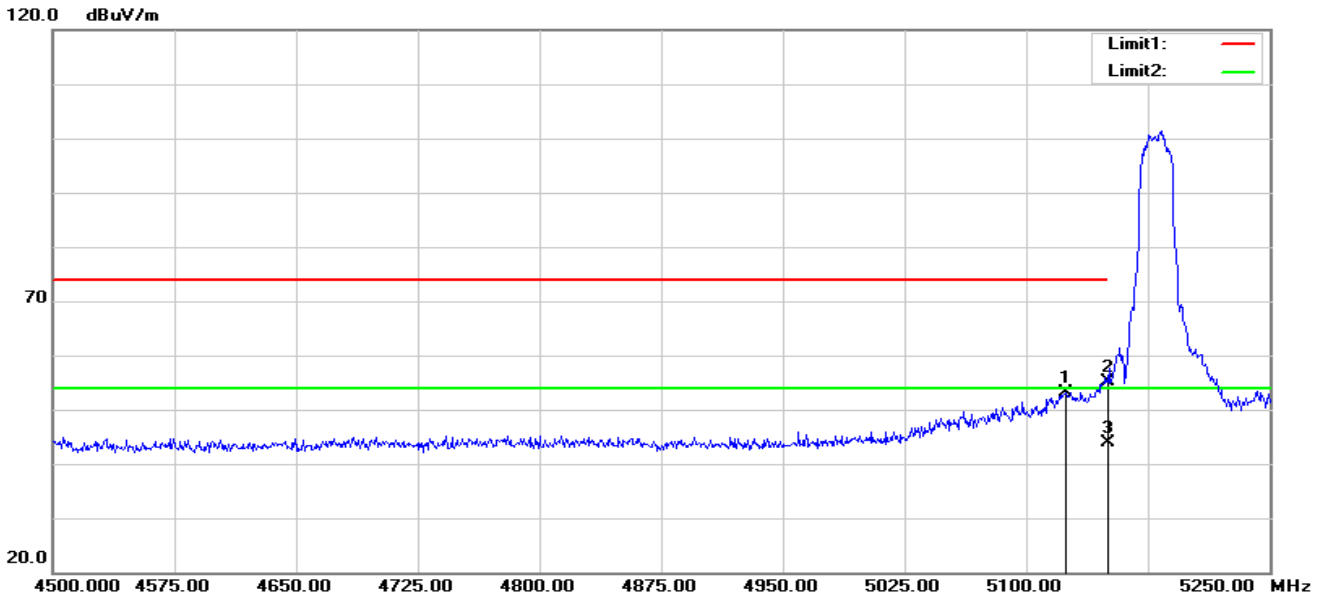

No.	Frequency (MHz)	Reading (dBuV)	Correct Factor(dB/m)	Result (dBuV/m)	Limit (dBuV/m)	Margin (dB)	Remark
1	5124.750	58.76	-5.74	53.02	74.00	-20.98	peak
2	5150.000	60.75	-5.73	55.02	74.00	-18.98	peak
3	5150.000	49.54	-5.73	43.81	54.00	-10.19	AVG

802.11ax20-L-V

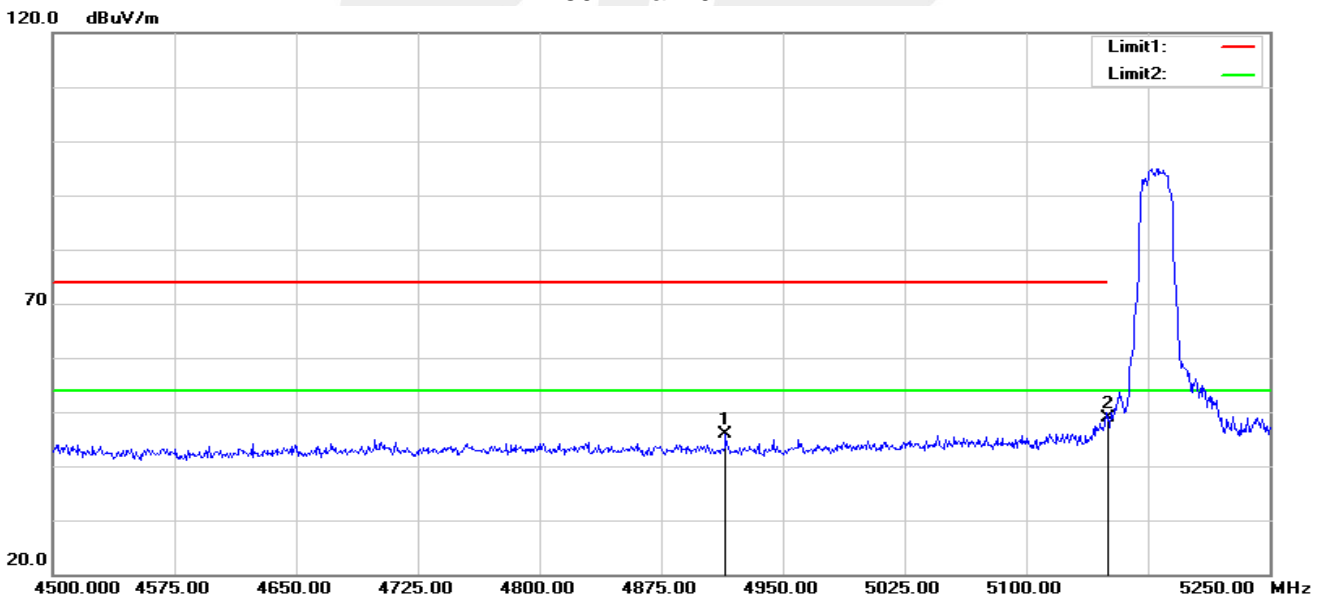

No.	Frequency (MHz)	Reading (dBuV)	Correct Factor(dB/m)	Result (dBuV/m)	Limit (dBuV/m)	Margin (dB)	Remark
1	4914.750	52.61	-6.74	45.87	74.00	-28.13	peak
2	5150.000	54.57	-5.73	48.84	74.00	-25.16	peak



802.11ax20-H-H

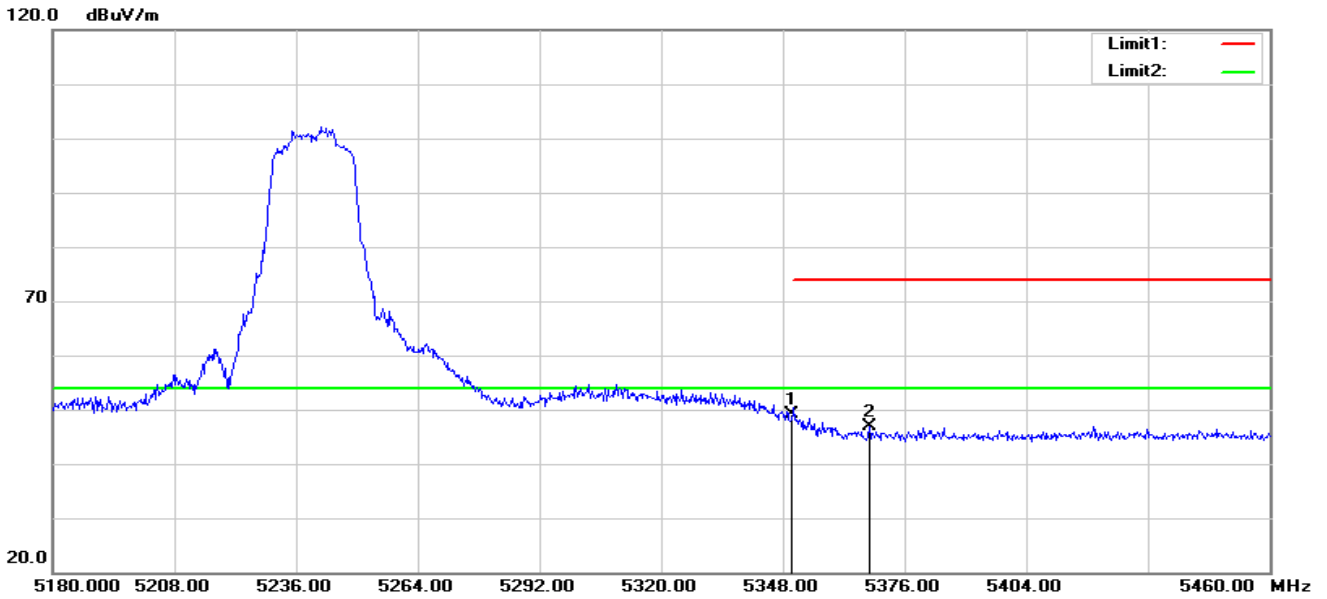

No.	Frequency (MHz)	Reading (dBuV)	Correct Factor(dB/m)	Result (dBuV/m)	Limit (dBuV/m)	Margin (dB)	Remark
1	5350.000	54.27	-5.23	49.04	74.00	-24.96	peak
2	5367.880	52.23	-5.24	46.99	74.00	-27.01	peak

802.11ax20-H-V

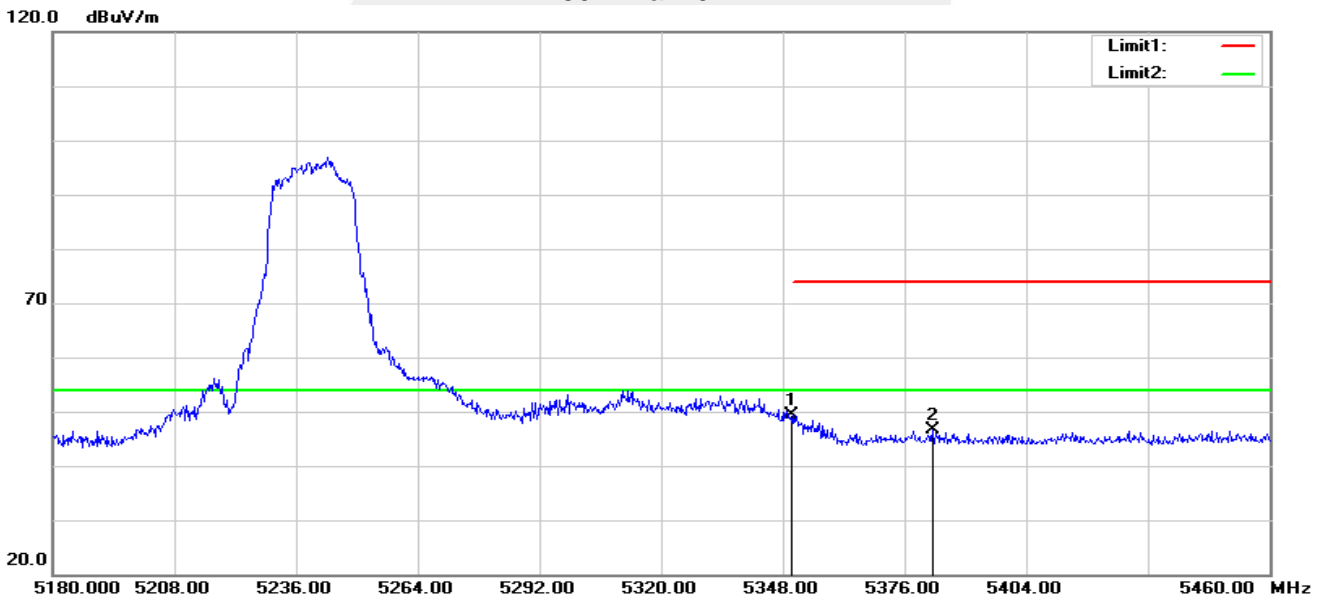

No.	Frequency (MHz)	Reading (dBuV)	Correct Factor(dB/m)	Result (dBuV/m)	Limit (dBuV/m)	Margin (dB)	Remark
1	5350.000	54.71	-5.23	49.48	74.00	-24.52	peak
2	5382.440	51.86	-5.24	46.62	74.00	-27.38	peak



802.11n40-L-H

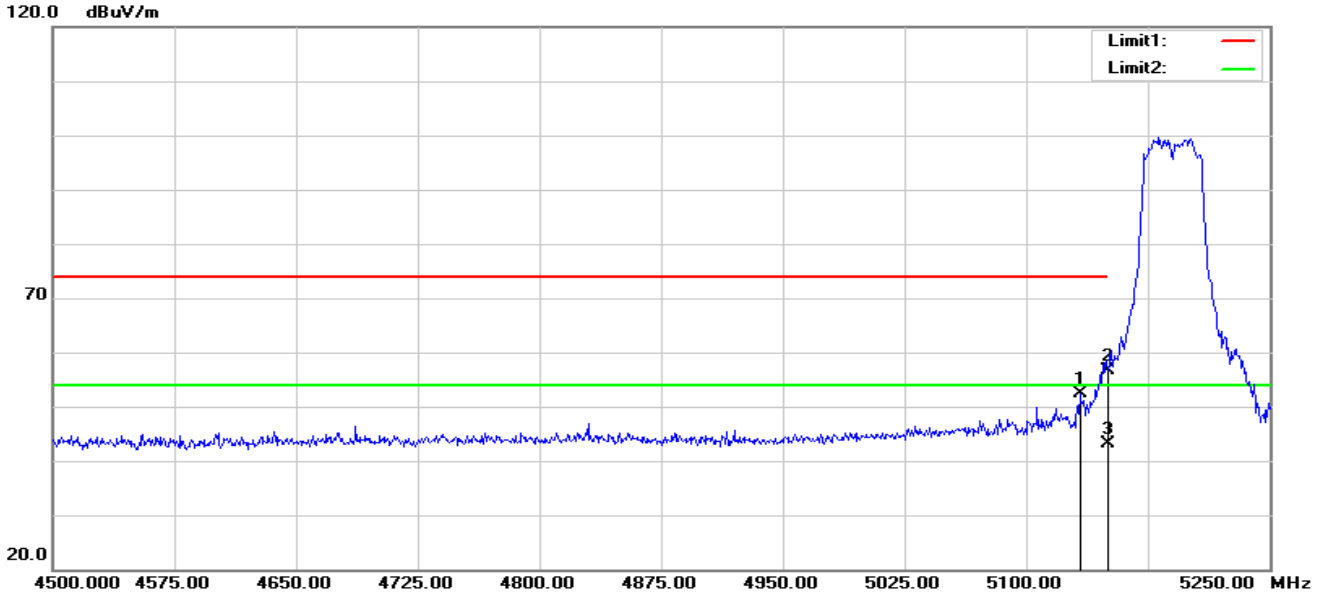

No.	Frequency (MHz)	Reading (dBuV)	Correct Factor(dB/m)	Result (dBuV/m)	Limit (dBuV/m)	Margin (dB)	Remark
1	5133.000	58.18	-5.73	52.45	74.00	-21.55	peak
2	5150.000	62.41	-5.73	56.68	74.00	-17.32	peak
3	5150.000	48.87	-5.73	43.14	54.00	-10.86	AVG

802.11n40-L-V

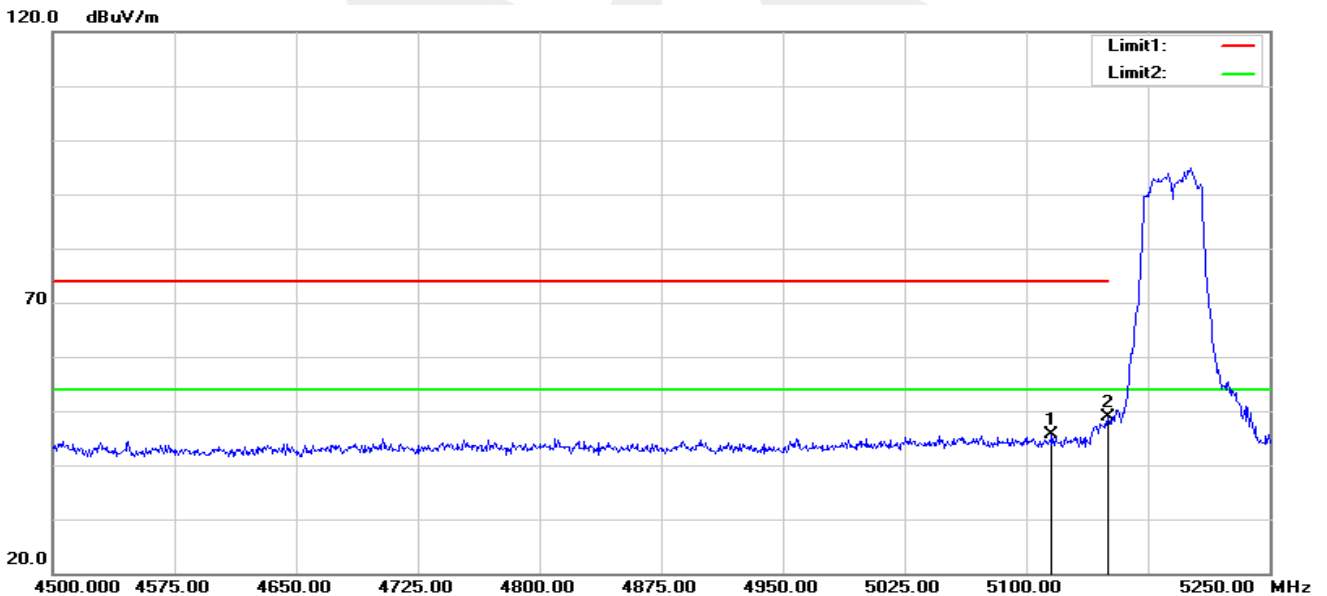

No.	Frequency (MHz)	Reading (dBuV)	Correct Factor(dB/m)	Result (dBuV/m)	Limit (dBuV/m)	Margin (dB)	Remark
1	5115.750	51.29	-5.74	45.55	74.00	-28.45	peak
2	5150.000	54.66	-5.73	48.93	74.00	-25.07	peak



802.11n40-H-H

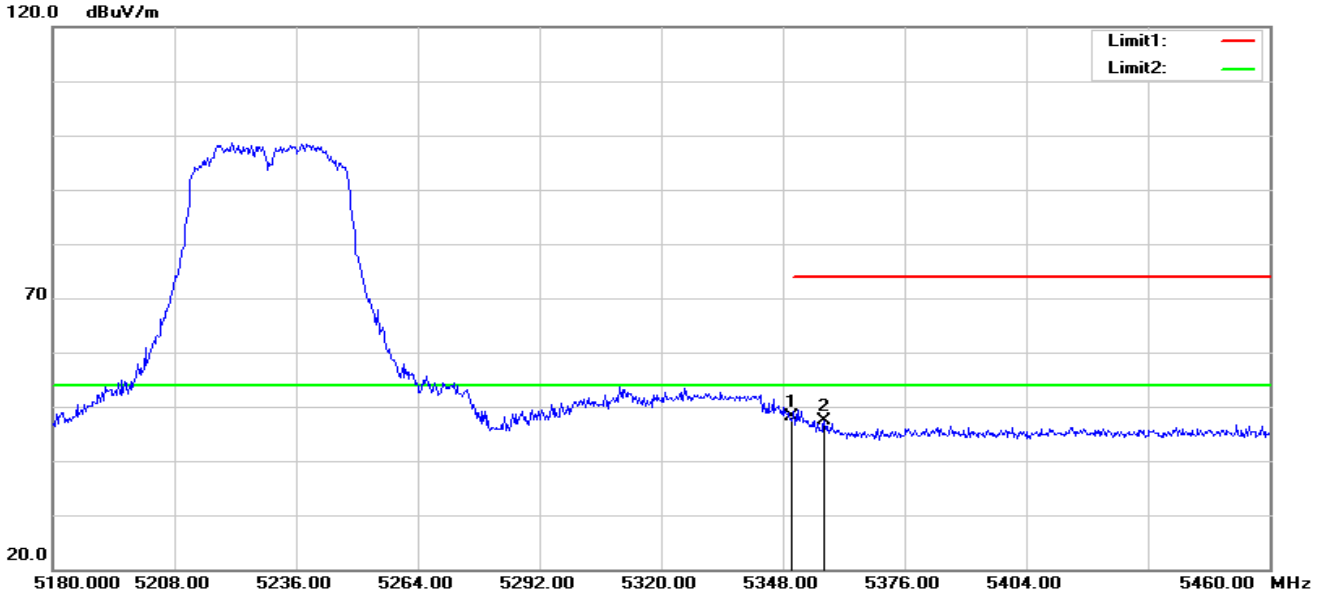

No.	Frequency (MHz)	Reading (dBuV)	Correct Factor(dB/m)	Result (dBuV/m)	Limit (dBuV/m)	Margin (dB)	Remark
1	5350.000	53.43	-5.23	48.20	74.00	-25.80	peak
2	5357.520	52.59	-5.23	47.36	74.00	-26.64	peak

802.11n40-H-V

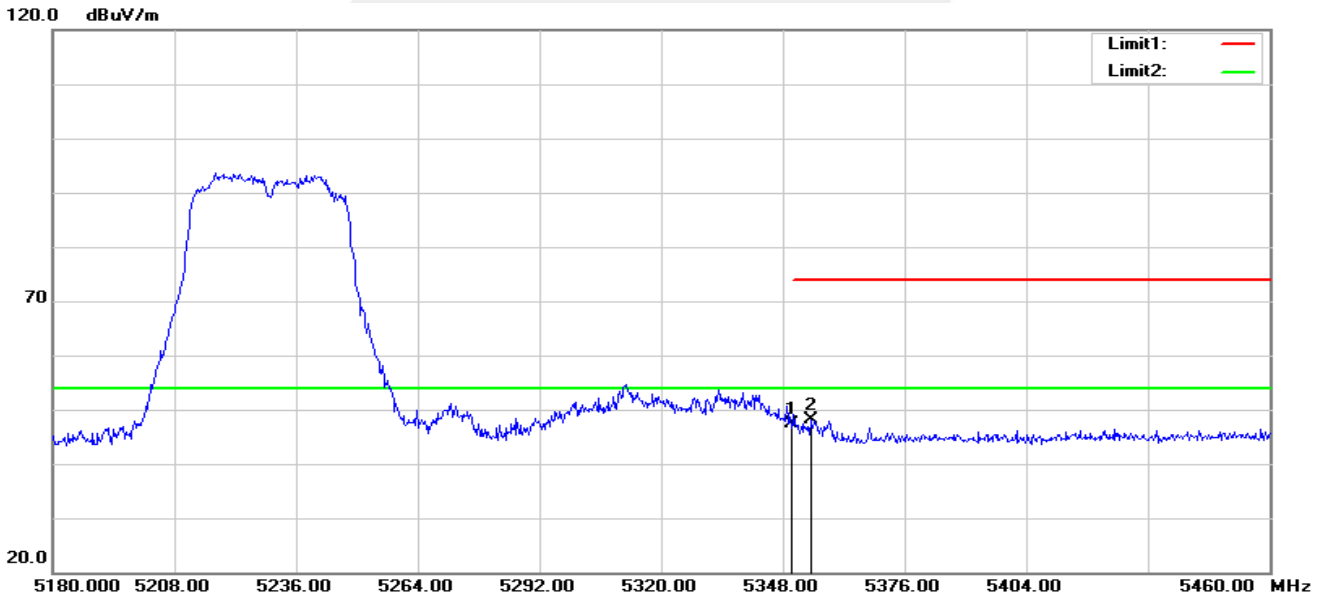

No.	Frequency (MHz)	Reading (dBuV)	Correct Factor(dB/m)	Result (dBuV/m)	Limit (dBuV/m)	Margin (dB)	Remark
1	5350.000	52.49	-5.23	47.26	74.00	-26.74	peak
2	5354.440	53.41	-5.24	48.17	74.00	-25.83	peak



802.11ac80-L-H

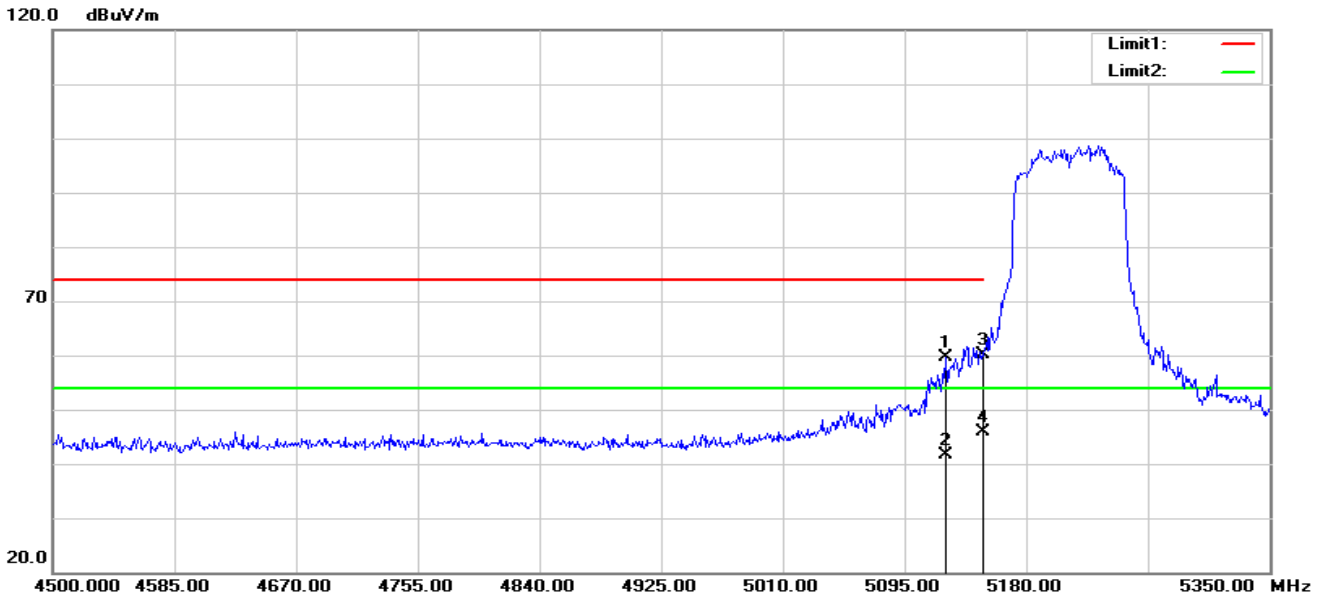

No.	Frequency (MHz)	Reading (dBuV)	Correct Factor(dB/m)	Result (dBuV/m)	Limit (dBuV/m)	Margin (dB)	Remark
1	5123.900	65.43	-5.74	59.69	74.00	-14.31	peak
2	5123.900	47.32	-5.74	41.58	54.00	-12.42	AVG
3	5150.000	65.98	-5.73	60.25	74.00	-13.75	peak
4	5150.000	51.72	-5.73	45.99	54.00	-8.01	AVG

802.11ac80-L-V

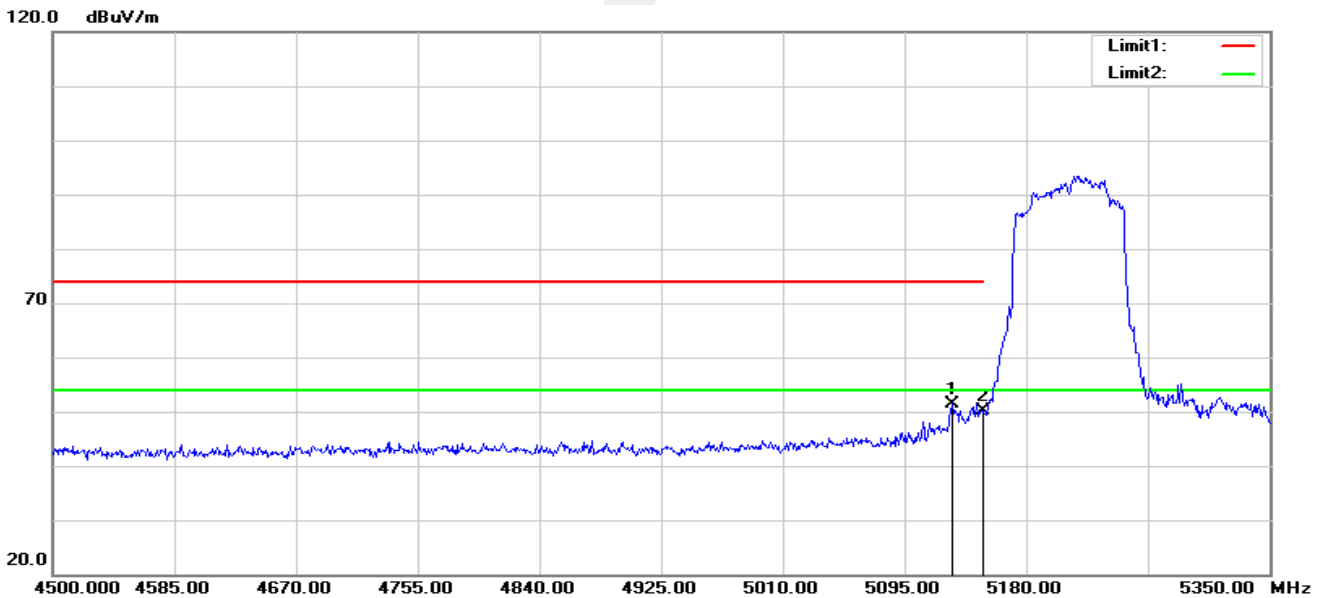

No.	Frequency (MHz)	Reading (dBuV)	Correct Factor(dB/m)	Result (dBuV/m)	Limit (dBuV/m)	Margin (dB)	Remark
1	5128.150	57.15	-5.74	51.41	74.00	-22.59	peak
2	5150.000	55.91	-5.73	50.18	74.00	-23.82	peak



802.11ac80-H-H

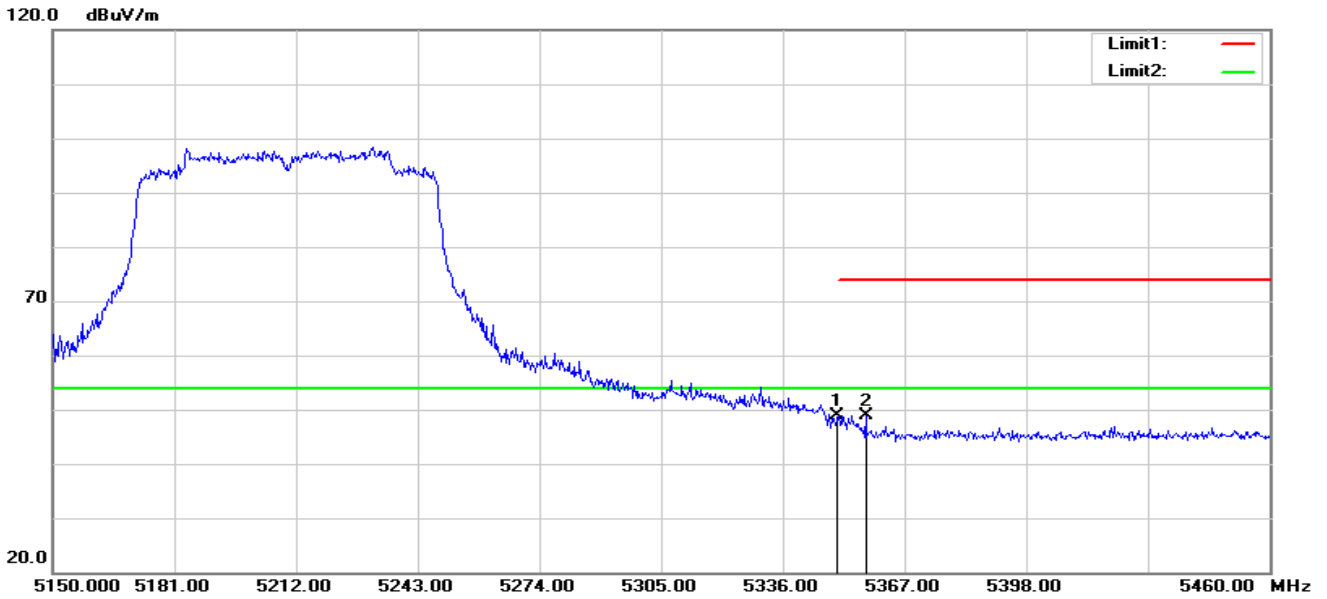

No.	Frequency (MHz)	Reading (dBuV)	Correct Factor(dB/m)	Result (dBuV/m)	Limit (dBuV/m)	Margin (dB)	Remark
1	5350.000	54.04	-5.23	48.81	74.00	-25.19	peak
2	5357.080	54.07	-5.23	48.84	74.00	-25.16	peak

802.11ac80-H-V

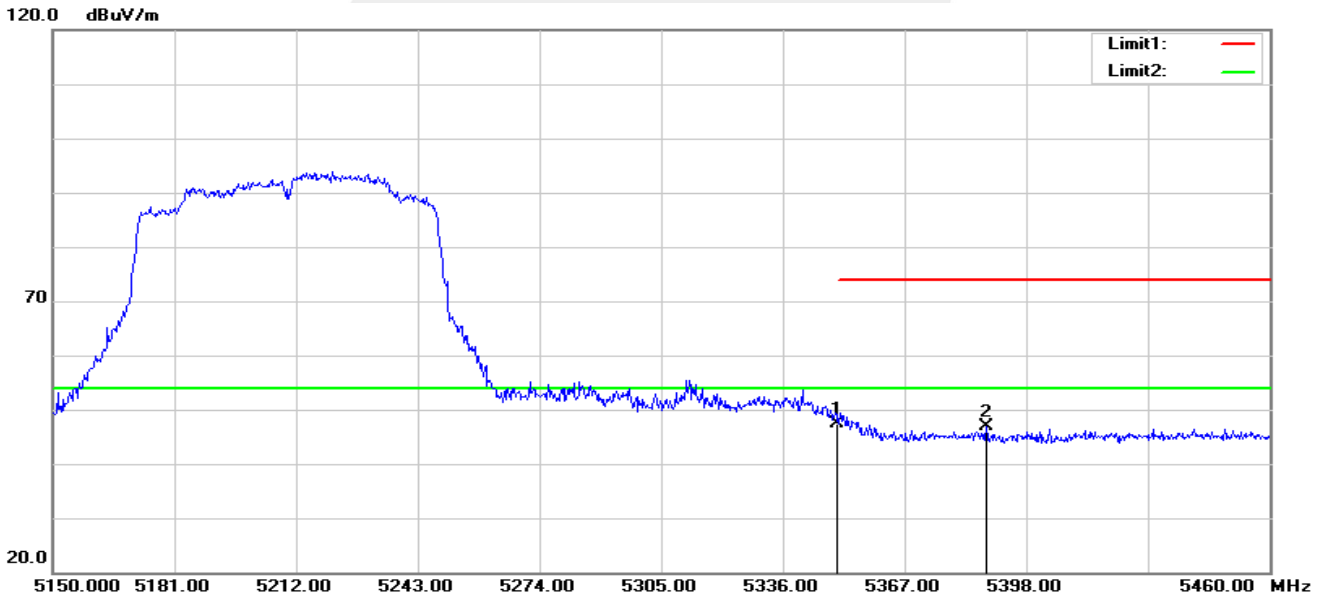

No.	Frequency (MHz)	Reading (dBuV)	Correct Factor(dB/m)	Result (dBuV/m)	Limit (dBuV/m)	Margin (dB)	Remark
1	5350.000	52.61	-5.23	47.38	74.00	-26.62	peak
2	5387.770	52.10	-5.25	46.85	74.00	-27.15	peak

Note: All modes have been tested. Only the worst mode shown in the report.



U-NII-2A 5250-5350MHz

802.11ax20-L-H

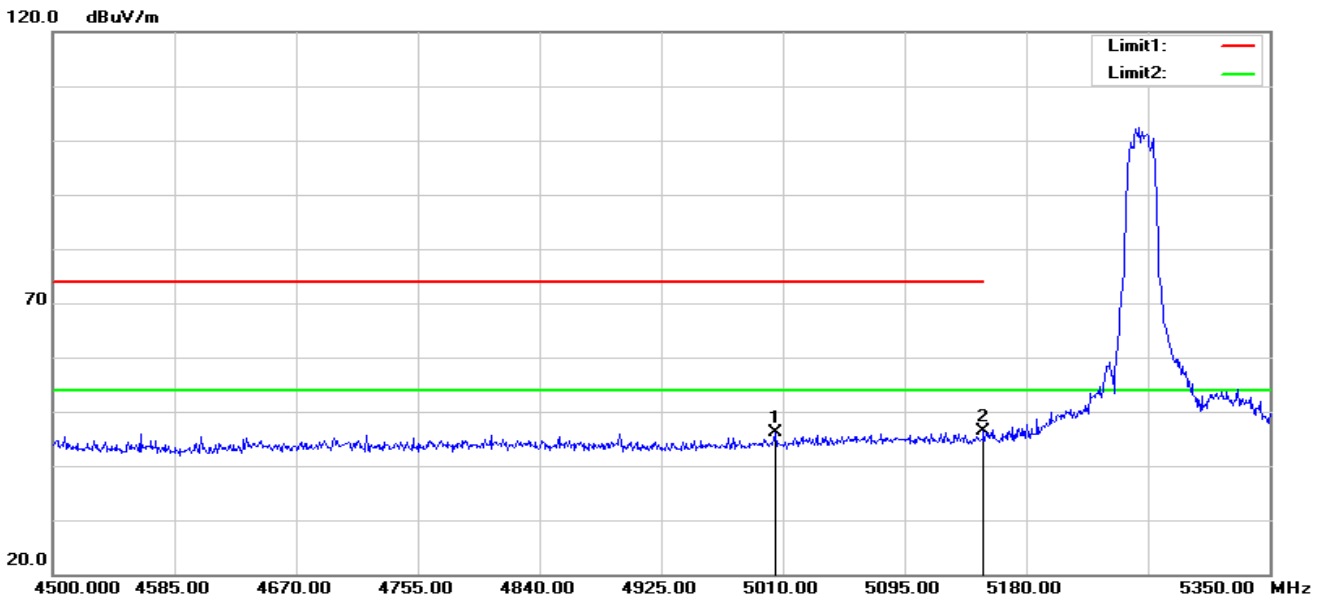

No.	Frequency (MHz)	Reading (dBuV)	Correct Factor(dB/m)	Result (dBuV/m)	Limit (dBuV/m)	Margin (dB)	Remark
1	5004.900	52.22	-6.17	46.05	74.00	-27.95	peak
2	5150.000	52.15	-5.73	46.42	74.00	-27.58	peak

802.11ax20-L-V

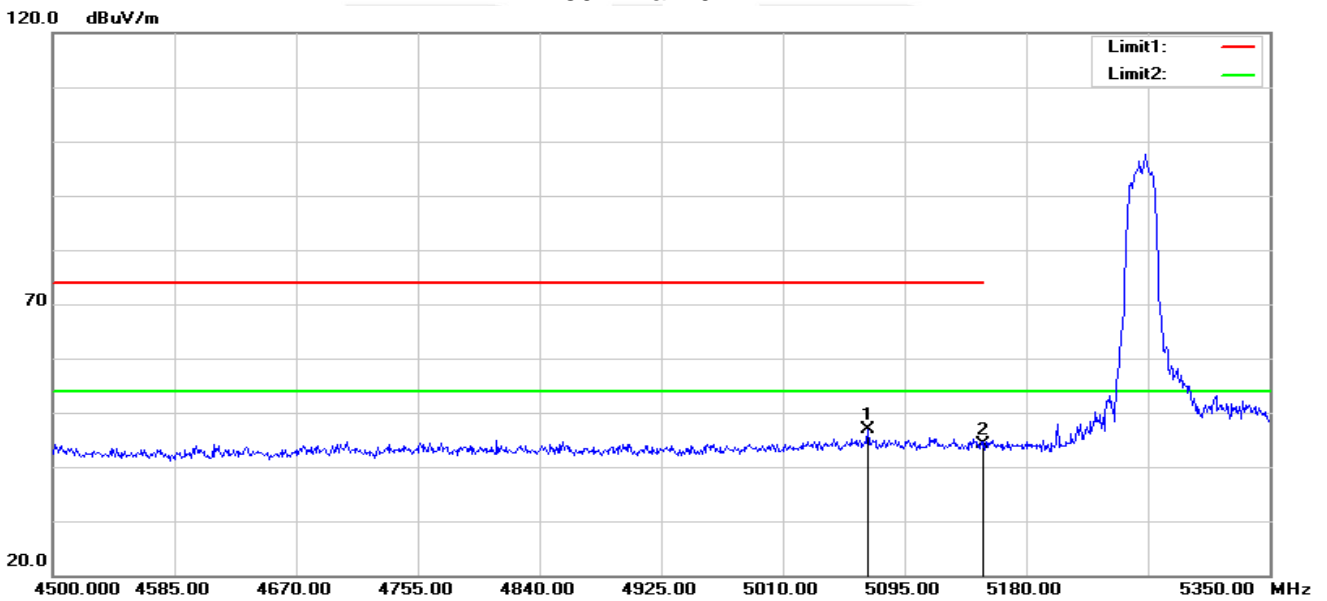

No.	Frequency (MHz)	Reading (dBuV)	Correct Factor(dB/m)	Result (dBuV/m)	Limit (dBuV/m)	Margin (dB)	Remark
1	5069.500	52.86	-5.87	46.99	74.00	-27.01	peak
2	5150.000	49.89	-5.73	44.16	74.00	-29.84	peak



802.11ax20-H-H

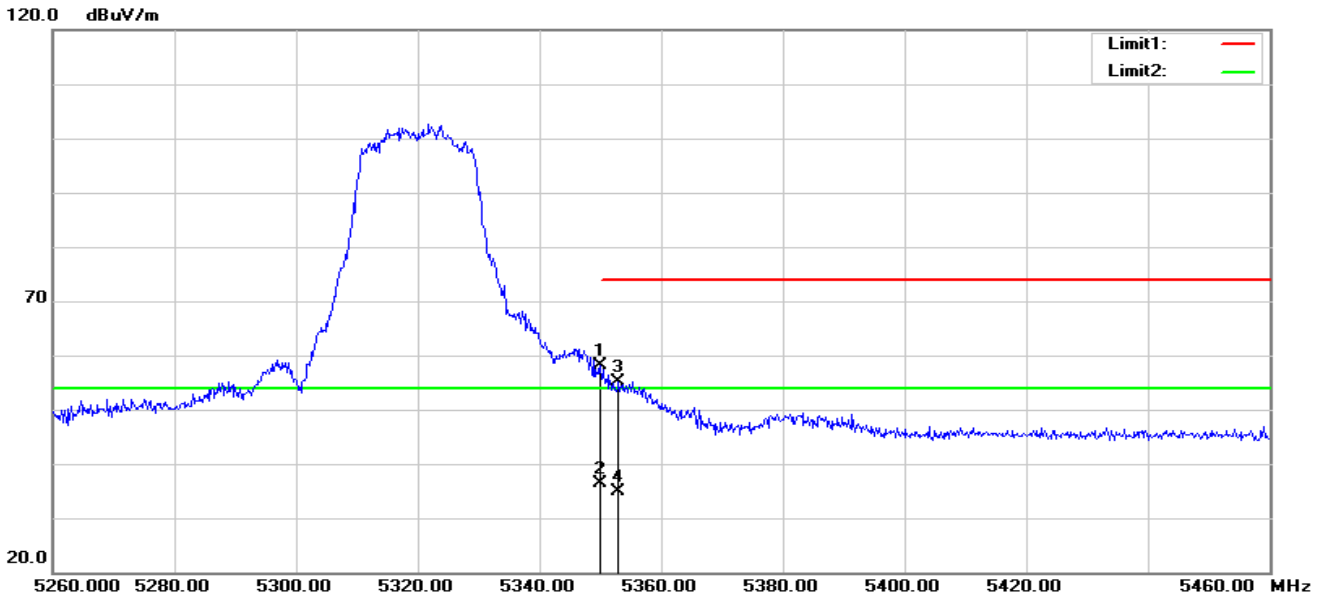

No.	Frequency (MHz)	Reading (dBuV)	Correct Factor(dB/m)	Result (dBuV/m)	Limit (dBuV/m)	Margin (dB)	Remark
1	5350.000	63.32	-5.23	58.09	74.00	-15.91	peak
2	5350.000	41.66	-5.23	36.43	54.00	-17.57	AVG
3	5353.000	60.46	-5.23	55.23	74.00	-18.77	peak
4	5353.000	40.17	-5.23	34.94	54.00	-19.06	AVG

802.11ax20-H-V

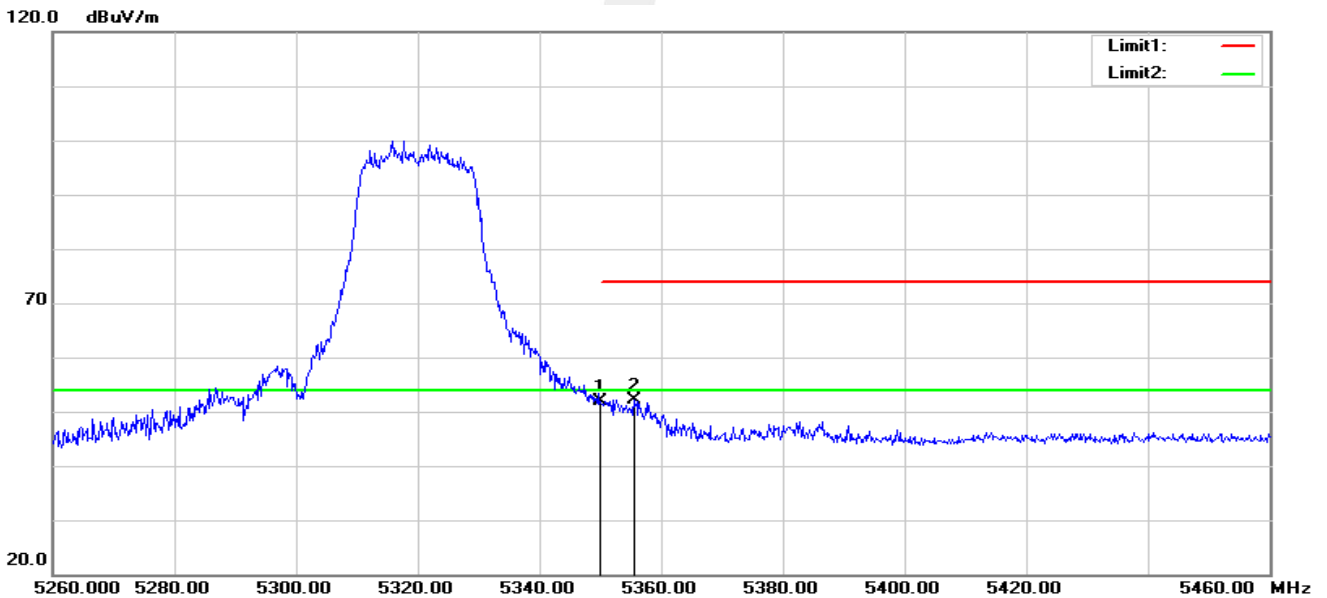

No.	Frequency (MHz)	Reading (dBuV)	Correct Factor(dB/m)	Result (dBuV/m)	Limit (dBuV/m)	Margin (dB)	Remark
1	5350.000	57.13	-5.23	51.90	74.00	-22.10	peak
2	5355.600	57.27	-5.24	52.03	74.00	-21.97	peak



802.11n40-L-H

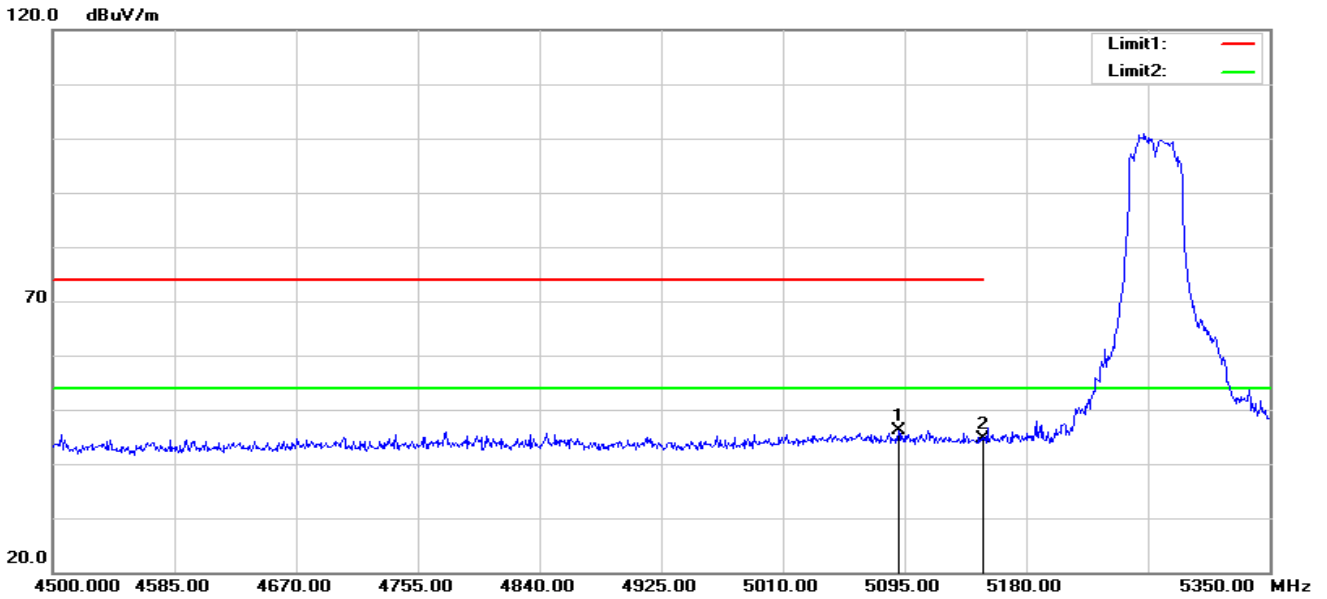

No.	Frequency (MHz)	Reading (dBuV)	Correct Factor(dB/m)	Result (dBuV/m)	Limit (dBuV/m)	Margin (dB)	Remark
1	5090.750	51.98	-5.78	46.20	74.00	-27.80	peak
2	5150.000	50.36	-5.73	44.63	74.00	-29.37	peak

802.11n40-L-V

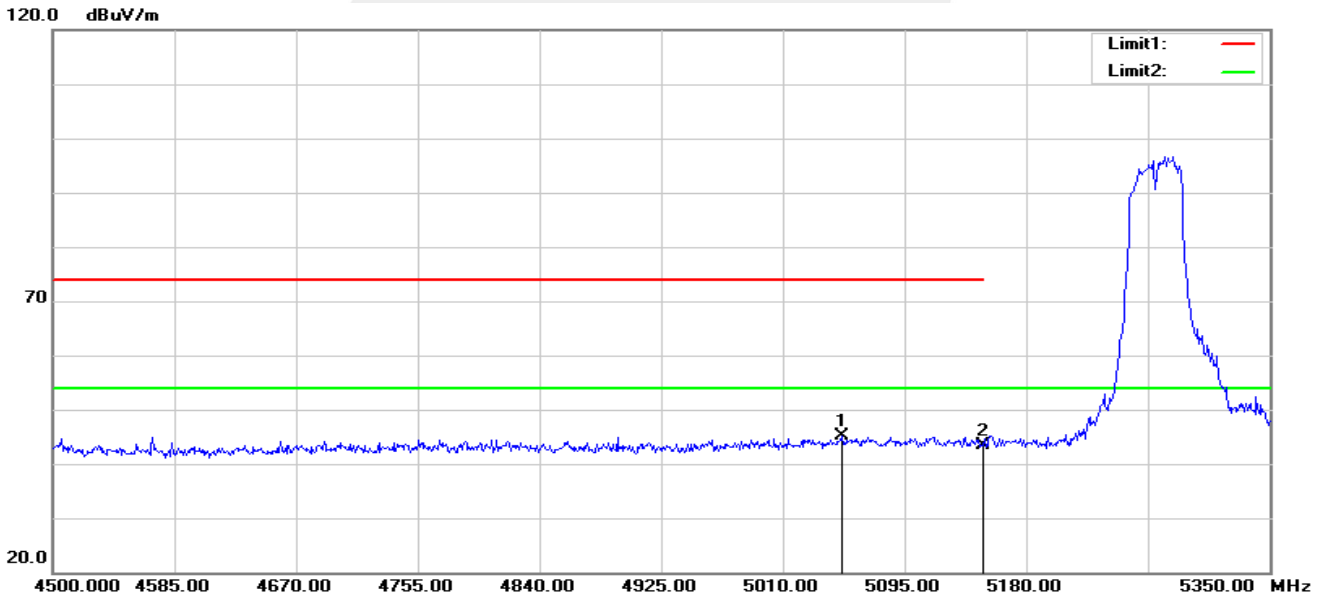

No.	Frequency (MHz)	Reading (dBuV)	Correct Factor(dB/m)	Result (dBuV/m)	Limit (dBuV/m)	Margin (dB)	Remark
1	5050.800	51.00	-5.96	45.04	74.00	-28.96	peak
2	5150.000	49.03	-5.73	43.30	74.00	-30.70	peak



802.11n40-H-H

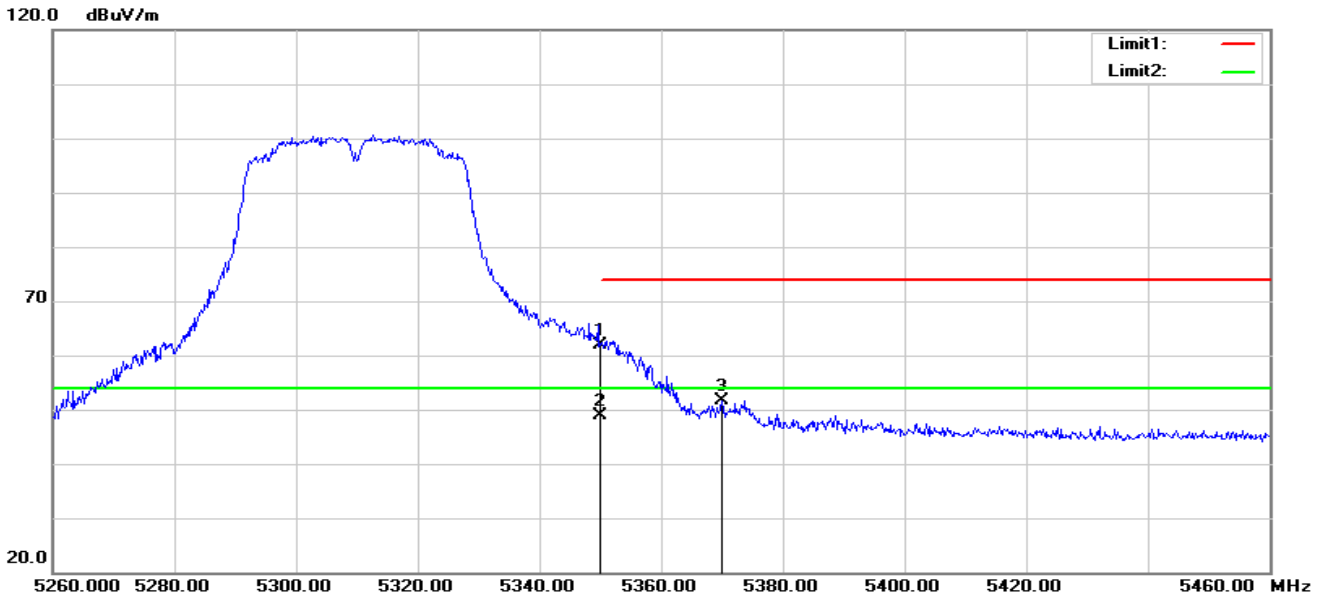

No.	Frequency (MHz)	Reading (dBuV)	Correct Factor(dB/m)	Result (dBuV/m)	Limit (dBuV/m)	Margin (dB)	Remark
1	5350.000	67.14	-5.23	61.91	74.00	-12.09	peak
2	5350.000	54.20	-5.23	48.97	54.00	-5.03	AVG
3	5370.000	56.98	-5.23	51.75	74.00	-22.25	peak

802.11n40-H-V

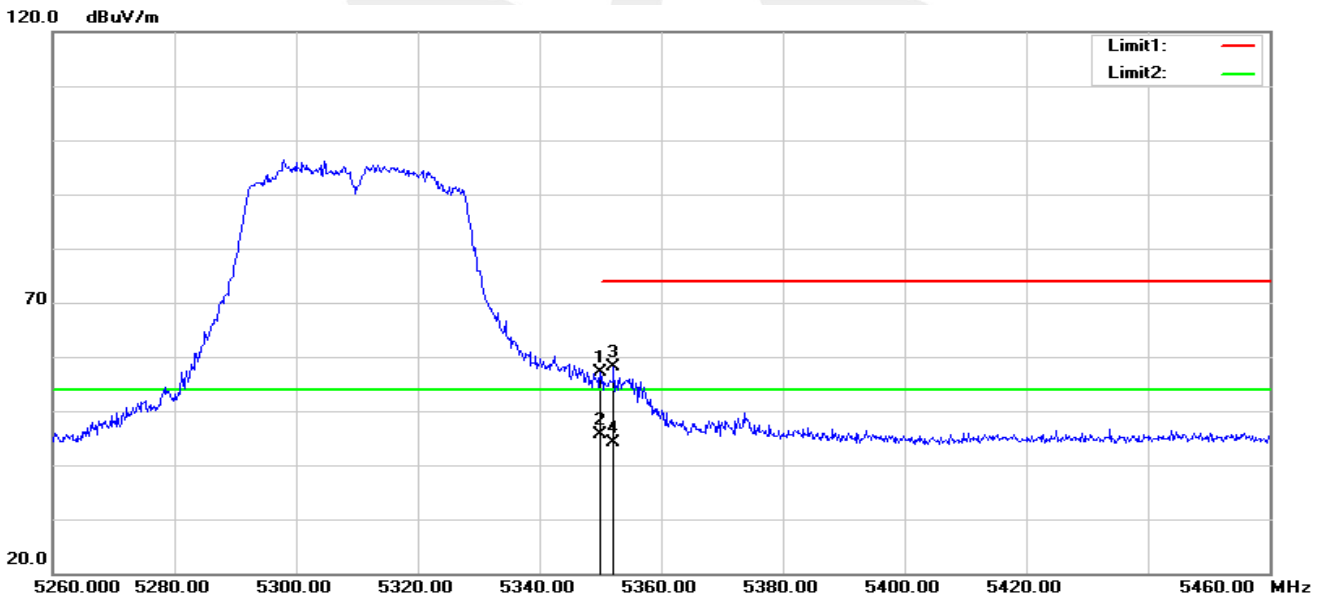

No.	Frequency (MHz)	Reading (dBuV)	Correct Factor(dB/m)	Result (dBuV/m)	Limit (dBuV/m)	Margin (dB)	Remark
1	5350.000	62.36	-5.23	57.13	74.00	-16.87	peak
2	5350.000	50.95	-5.23	45.72	54.00	-8.28	AVG
3	5352.200	63.35	-5.23	58.12	74.00	-15.88	peak
4	5352.200	49.32	-5.23	44.09	54.00	-9.91	AVG



802.11ac80-L-H

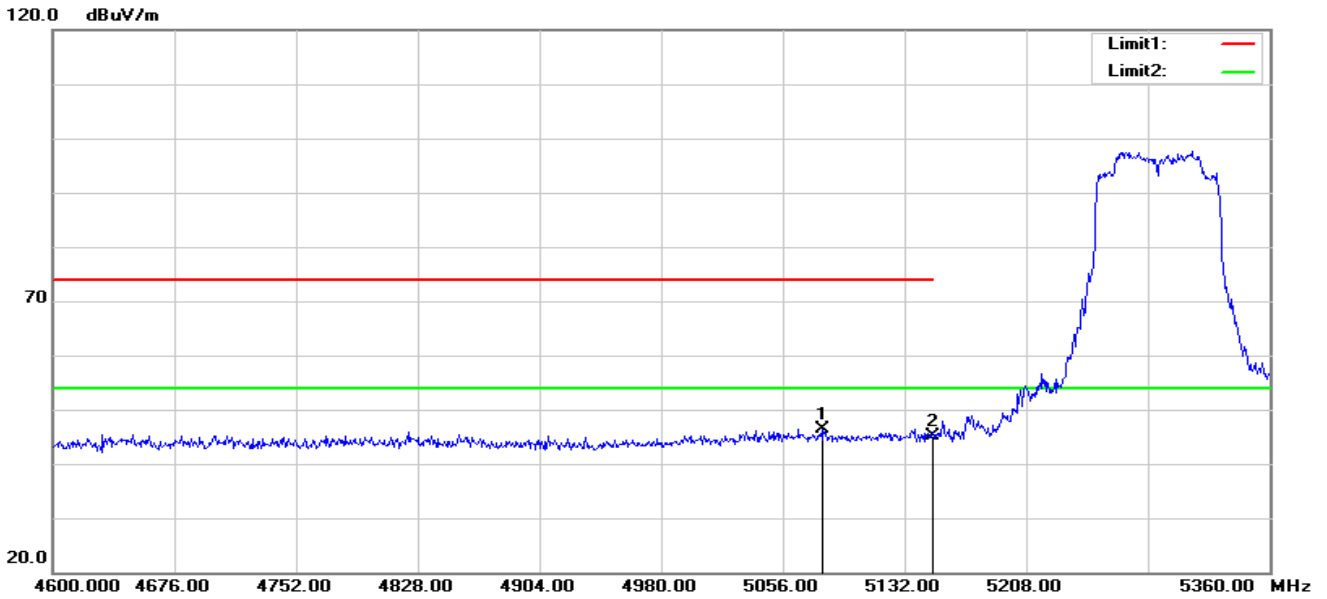

No.	Frequency (MHz)	Reading (dBuV)	Correct Factor(dB/m)	Result (dBuV/m)	Limit (dBuV/m)	Margin (dB)	Remark
1	5081.080	52.18	-5.83	46.35	74.00	-27.65	peak
2	5150.000	50.86	-5.73	45.13	74.00	-28.87	peak

802.11ac80-L-V

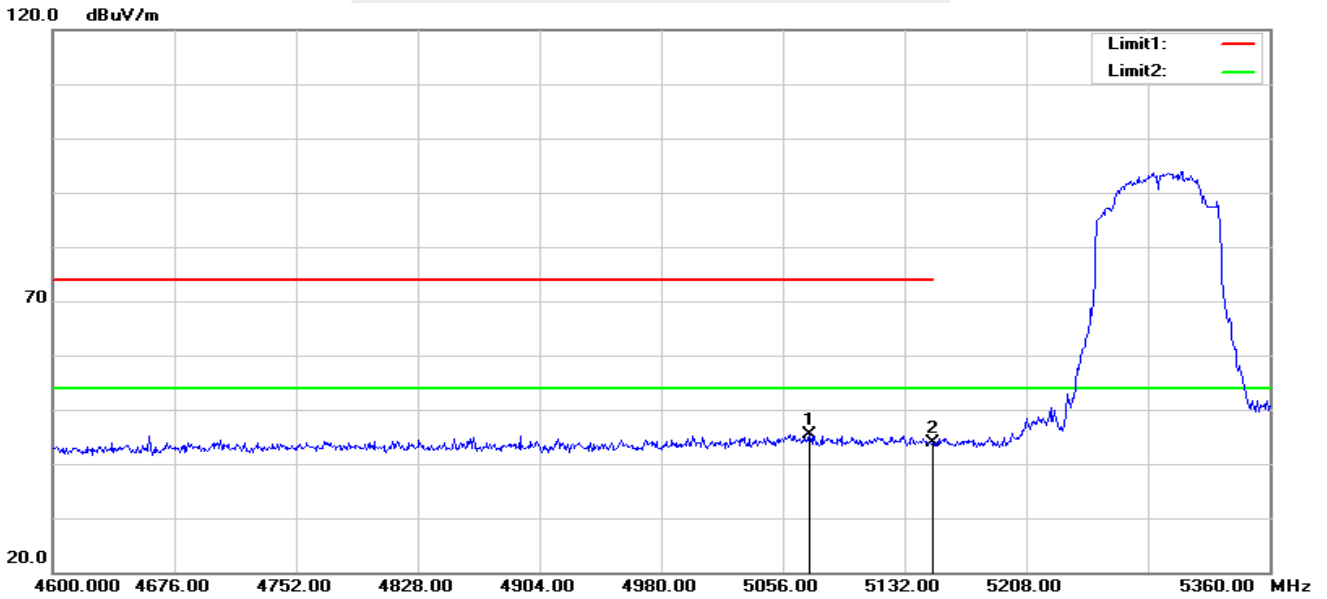

No.	Frequency (MHz)	Reading (dBuV)	Correct Factor(dB/m)	Result (dBuV/m)	Limit (dBuV/m)	Margin (dB)	Remark
1	5072.720	51.20	-5.86	45.34	74.00	-28.66	peak
2	5150.000	49.60	-5.73	43.87	74.00	-30.13	peak



802.11ac80-H-H

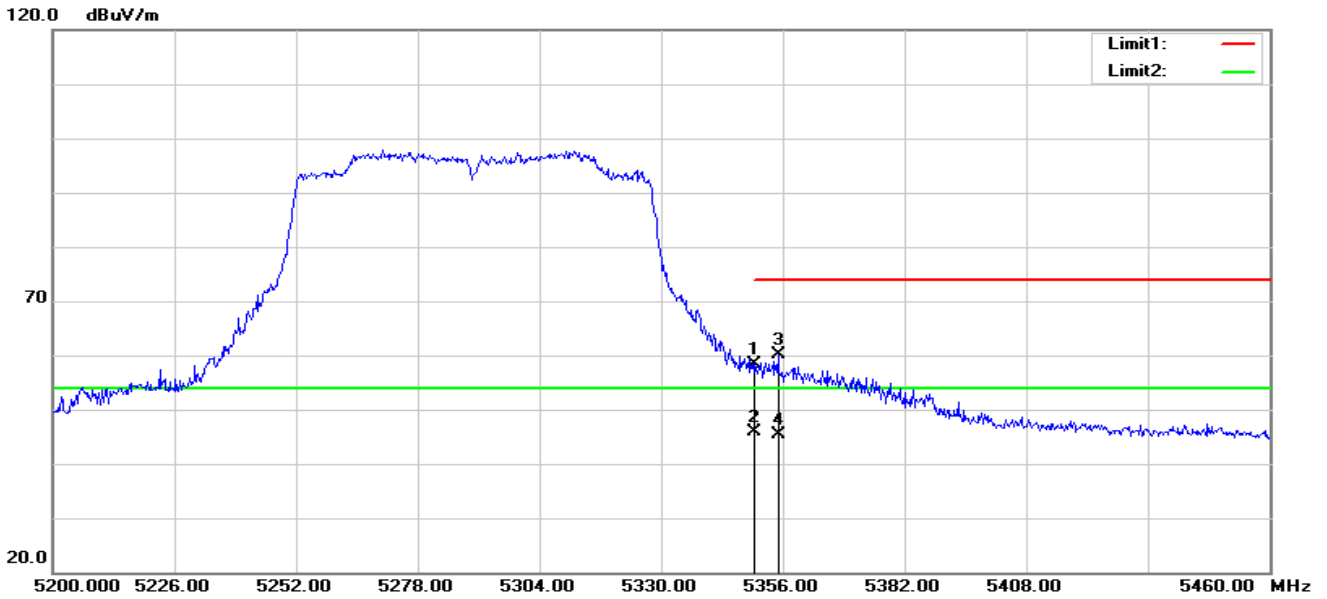

No.	Frequency (MHz)	Reading (dBuV)	Correct Factor(dB/m)	Result (dBuV/m)	Limit (dBuV/m)	Margin (dB)	Remark
1	5350.000	63.67	-5.23	58.44	74.00	-15.56	peak
2	5350.000	51.08	-5.23	45.85	54.00	-8.15	AVG
3	5354.960	65.42	-5.24	60.18	74.00	-13.82	peak
4	5354.960	50.69	-5.24	45.45	54.00	-8.55	AVG

802.11ac80-H-V

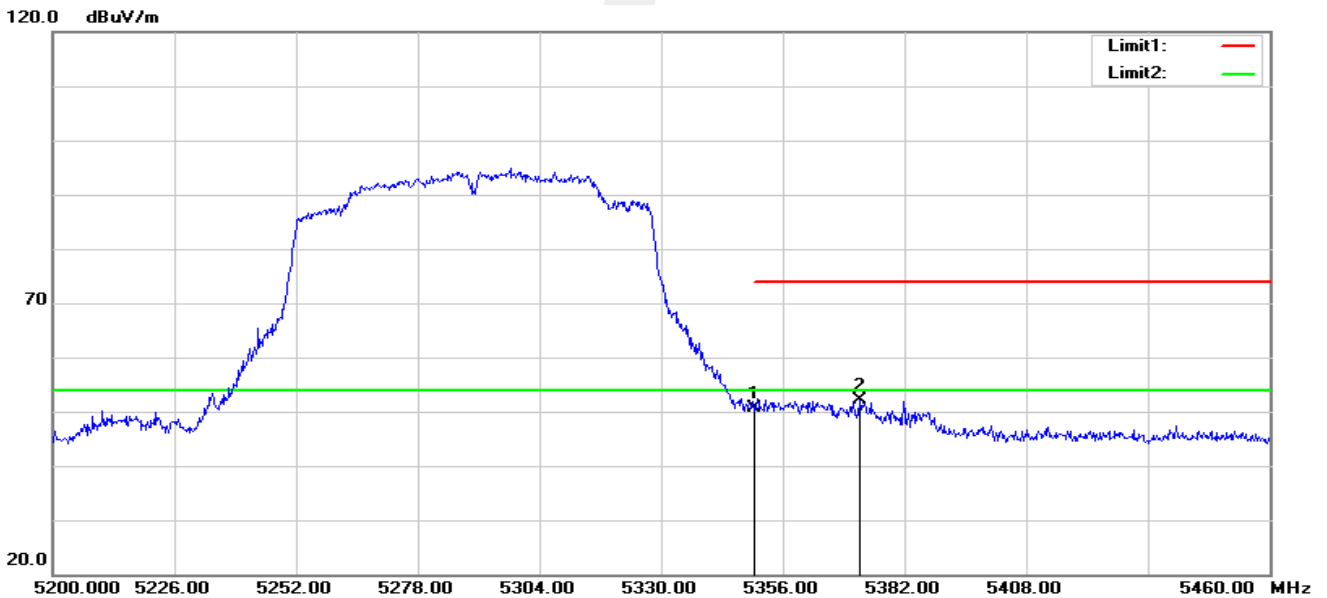

No.	Frequency (MHz)	Reading (dBuV)	Correct Factor(dB/m)	Result (dBuV/m)	Limit (dBuV/m)	Margin (dB)	Remark
1	5350.000	55.74	-5.23	50.51	74.00	-23.49	peak
2	5372.380	57.26	-5.24	52.02	74.00	-21.98	peak



802.11ac160-L-H

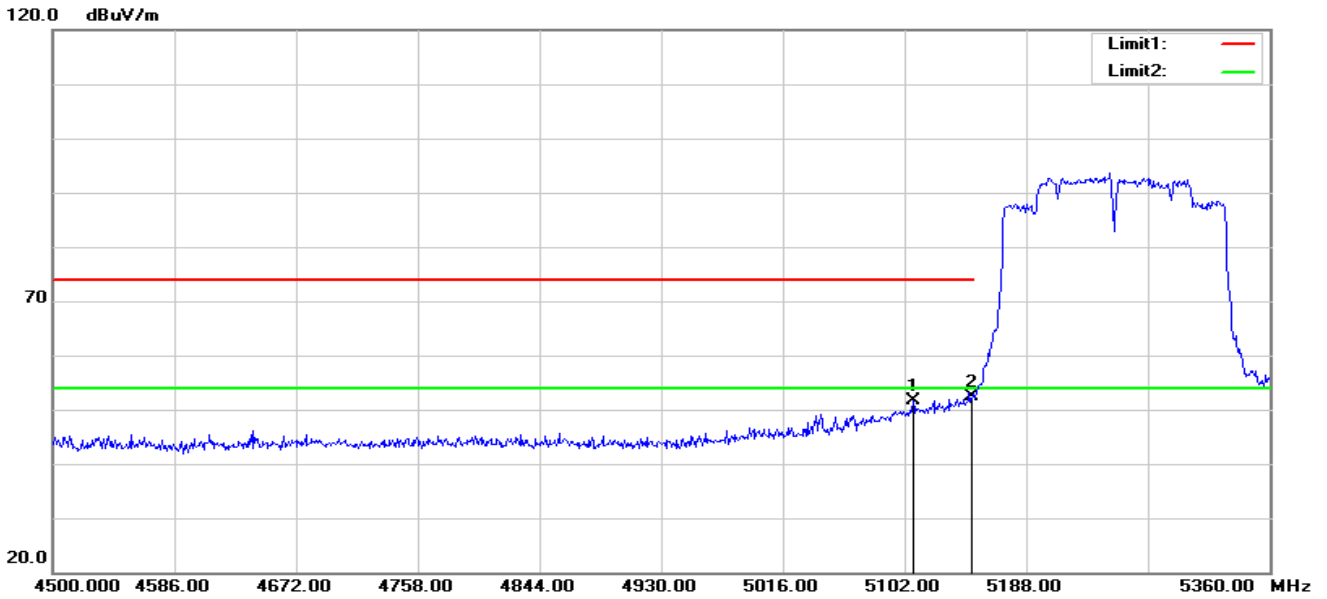

No.	Frequency (MHz)	Reading (dBuV)	Correct Factor(dB/m)	Result (dBuV/m)	Limit (dBuV/m)	Margin (dB)	Remark
1	5108.020	57.41	-5.74	51.67	74.00	-22.33	peak
2	5150.000	57.99	-5.73	52.26	74.00	-21.74	peak

802.11ac160-L-V

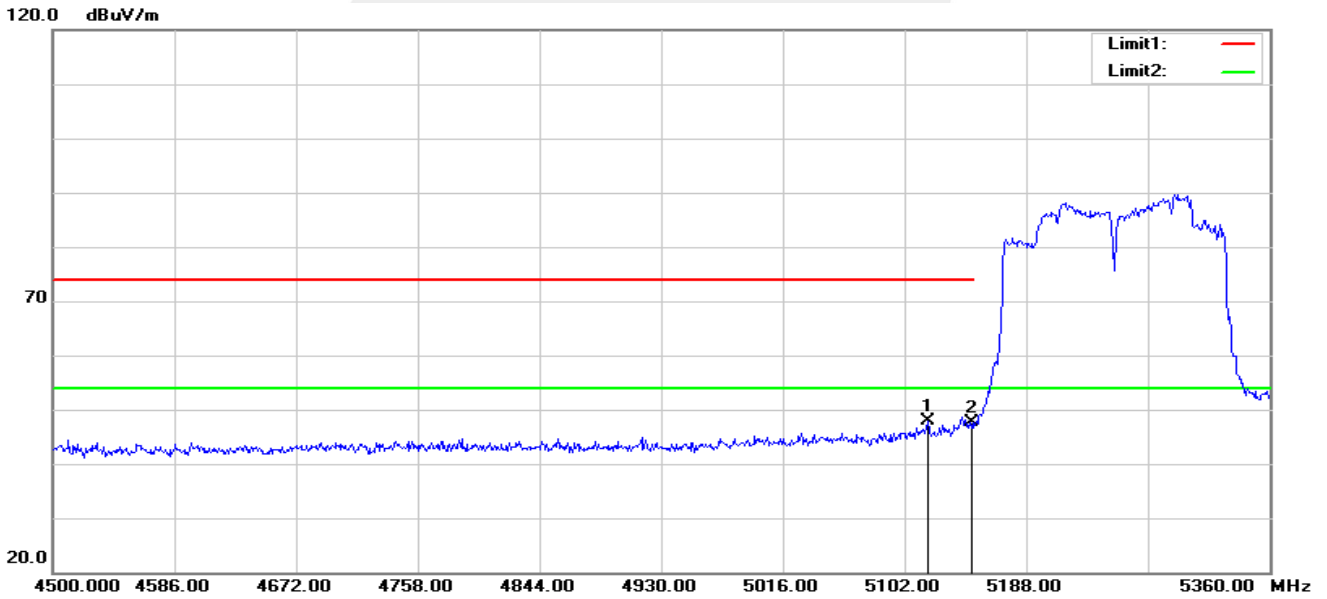

No.	Frequency (MHz)	Reading (dBuV)	Correct Factor(dB/m)	Result (dBuV/m)	Limit (dBuV/m)	Margin (dB)	Remark
1	5118.340	53.63	-5.74	47.89	74.00	-26.11	peak
2	5150.000	53.38	-5.73	47.65	74.00	-26.35	peak



802.11ac160-H-H

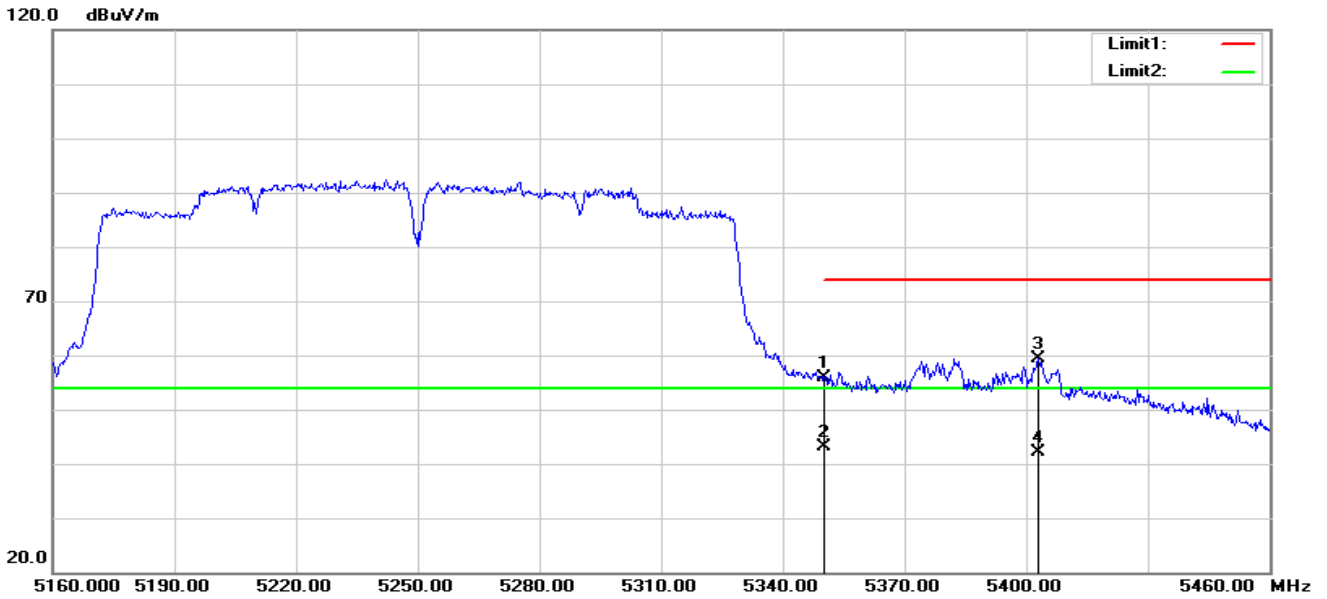

No.	Frequency (MHz)	Reading (dBuV)	Correct Factor(dB/m)	Result (dBuV/m)	Limit (dBuV/m)	Margin (dB)	Remark
1	5350.000	61.05	-5.23	55.82	74.00	-18.18	peak
2	5350.000	48.32	-5.23	43.09	54.00	-10.91	AVG
3	5403.000	64.71	-5.25	59.46	74.00	-14.54	peak
4	5403.000	47.50	-5.25	42.25	54.00	-11.75	AVG

802.11ac160-H-V

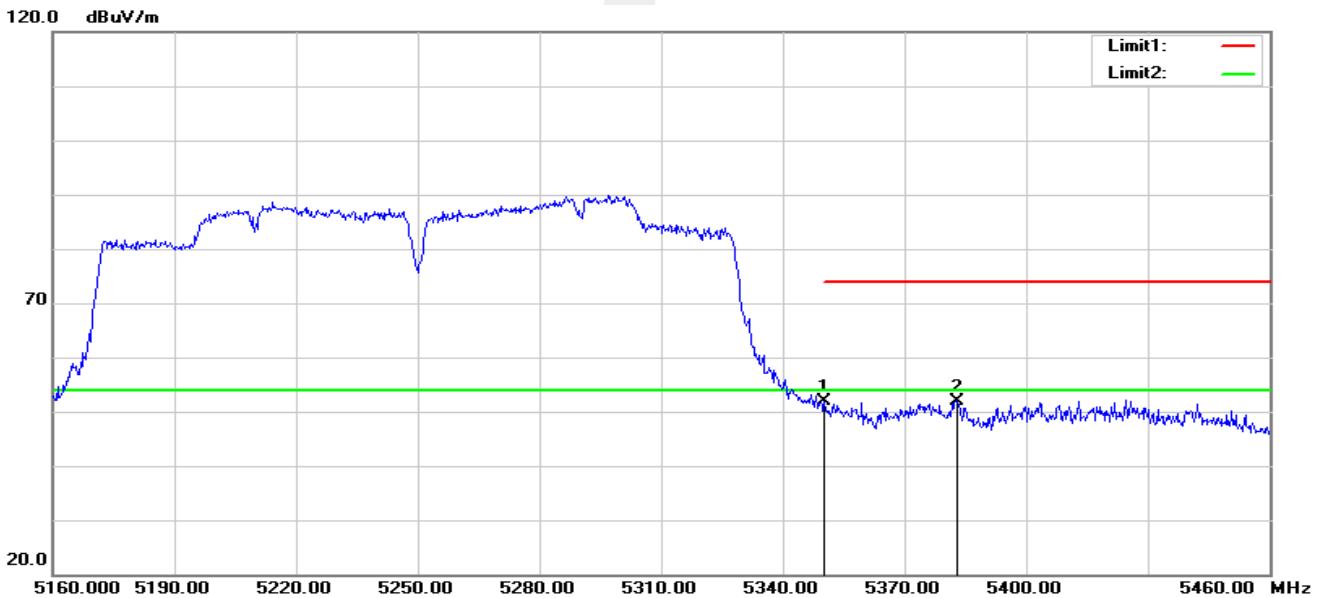

No.	Frequency (MHz)	Reading (dBuV)	Correct Factor(dB/m)	Result (dBuV/m)	Limit (dBuV/m)	Margin (dB)	Remark
1	5350.000	57.10	-5.23	51.87	74.00	-22.13	peak
2	5382.900	57.17	-5.24	51.93	74.00	-22.07	peak

Note: All modes have been tested. Only the worst mode shown in the report.



U-NII-2C 5470-5725MHz

802.11ax20-L-H

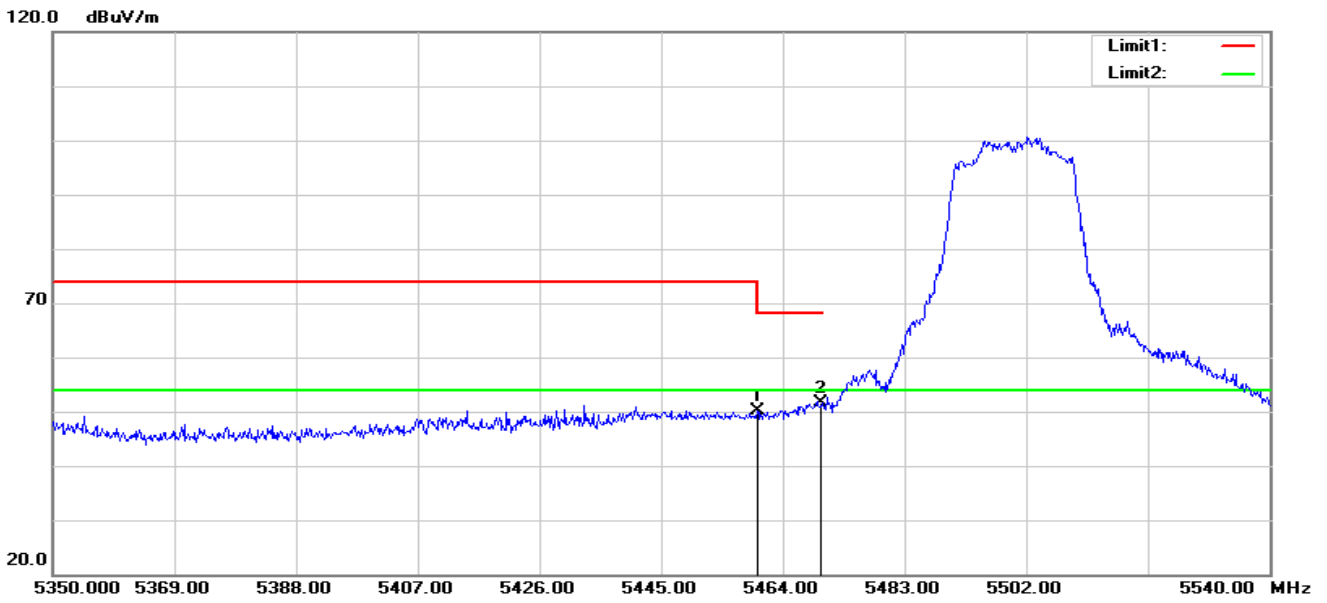

No.	Frequency (MHz)	Reading (dBuV)	Correct Factor(dB/m)	Result (dBuV/m)	Limit (dBuV/m)	Margin (dB)	Remark
1	5460.000	55.32	-5.11	50.21	68.20	-17.99	peak
2	5470.000	56.70	-5.09	51.61	68.20	-16.59	peak

802.11ax20-L-V

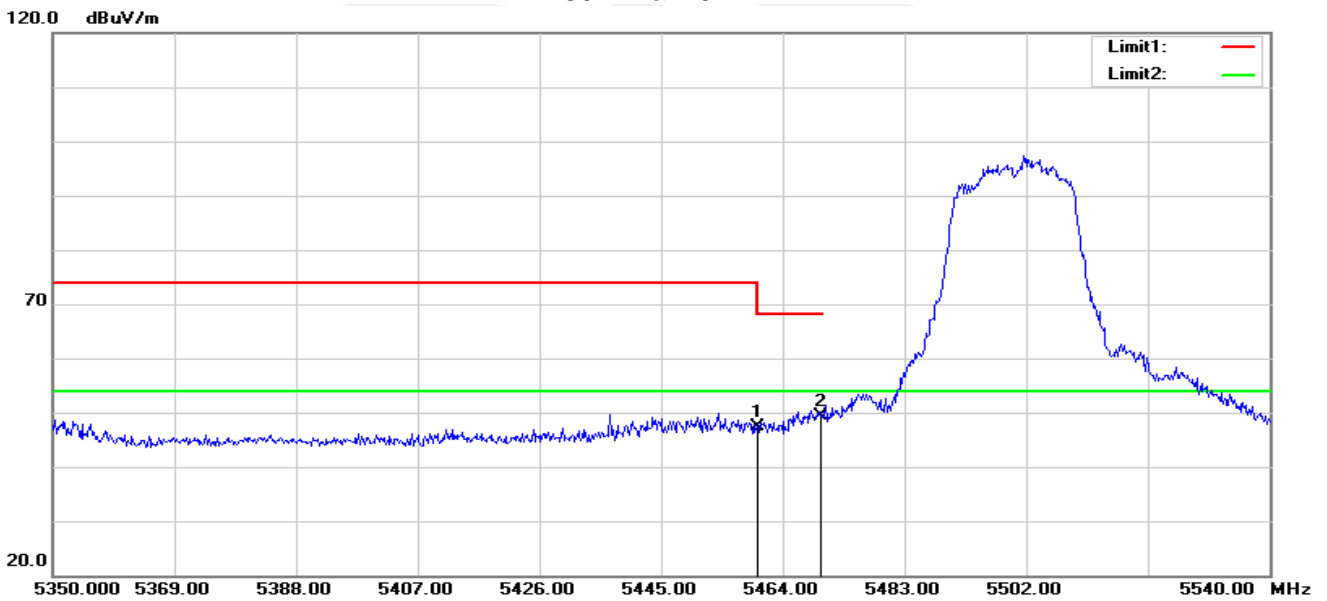

No.	Frequency (MHz)	Reading (dBuV)	Correct Factor(dB/m)	Result (dBuV/m)	Limit (dBuV/m)	Margin (dB)	Remark
1	5460.000	52.56	-5.11	47.45	68.20	-20.75	peak
2	5470.000	54.47	-5.09	49.38	68.20	-18.82	peak



802.11ax20-H-H

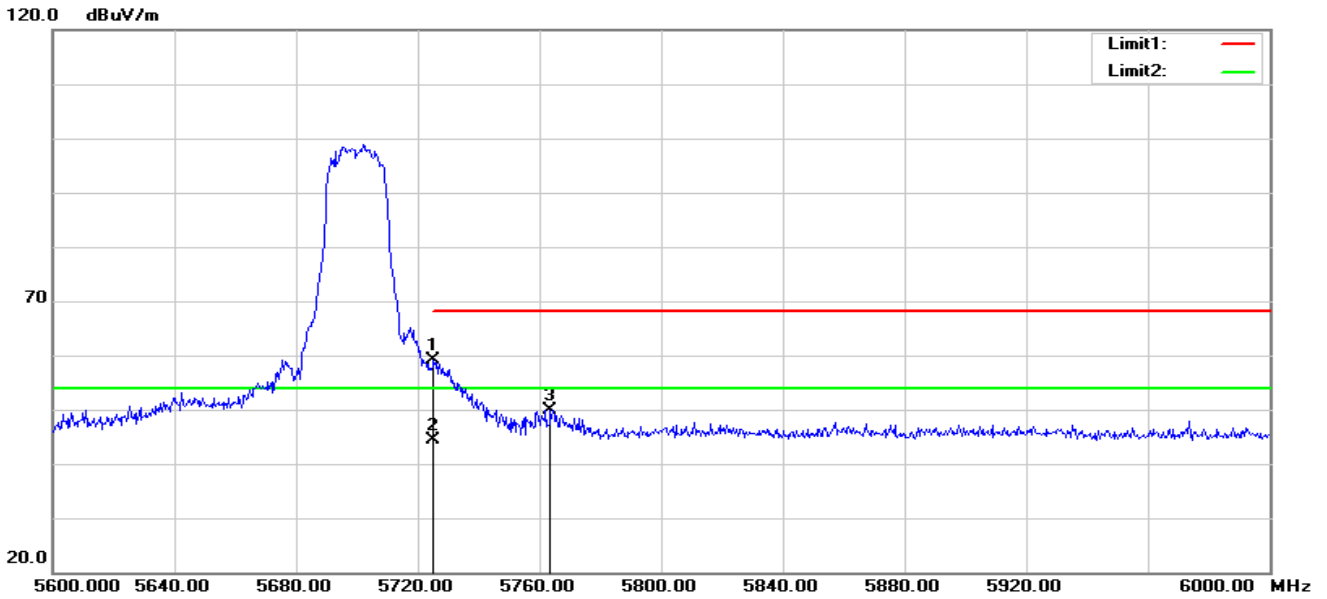

No.	Frequency (MHz)	Reading (dBuV)	Correct Factor(dB/m)	Result (dBuV/m)	Limit (dBuV/m)	Margin (dB)	Remark
1	5725.000	63.59	-4.57	59.02	68.20	-9.18	peak
2	5725.000	48.99	-4.57	44.42	54.00	-9.58	AVG
3	5763.600	54.38	-4.45	49.93	68.20	-18.27	peak

802.11ax20-H-V

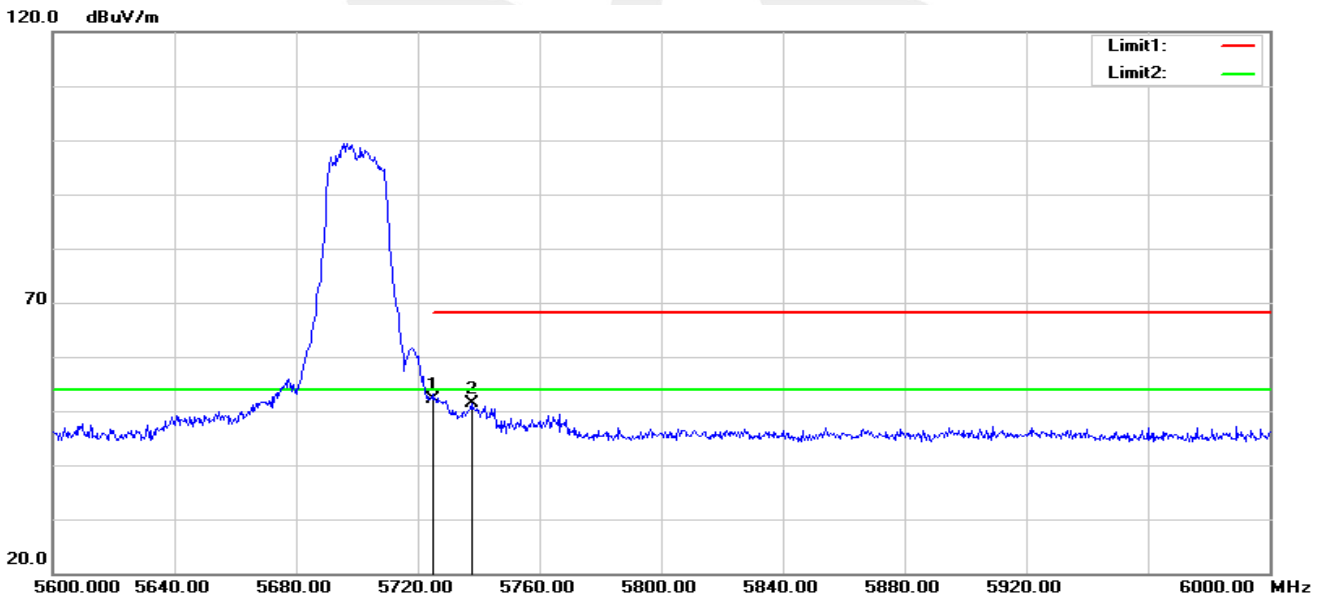

No.	Frequency (MHz)	Reading (dBuV)	Correct Factor(dB/m)	Result (dBuV/m)	Limit (dBuV/m)	Margin (dB)	Remark
1	5725.000	56.63	-4.57	52.06	68.20	-16.14	peak
2	5737.600	55.91	-4.53	51.38	68.20	-16.82	peak



802.11n40-L-H

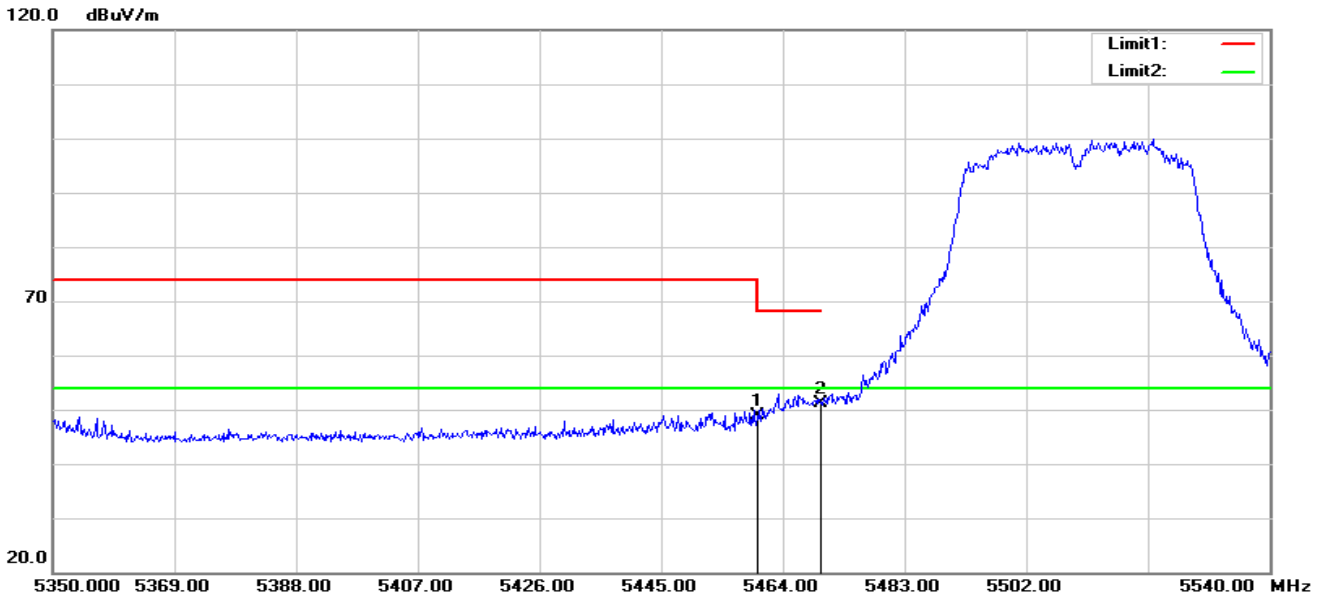

No.	Frequency (MHz)	Reading (dBuV)	Correct Factor(dB/m)	Result (dBuV/m)	Limit (dBuV/m)	Margin (dB)	Remark
1	5460.000	53.99	-5.11	48.88	68.20	-19.32	peak
2	5470.000	56.19	-5.09	51.10	68.20	-17.10	peak

802.11n40-L-V

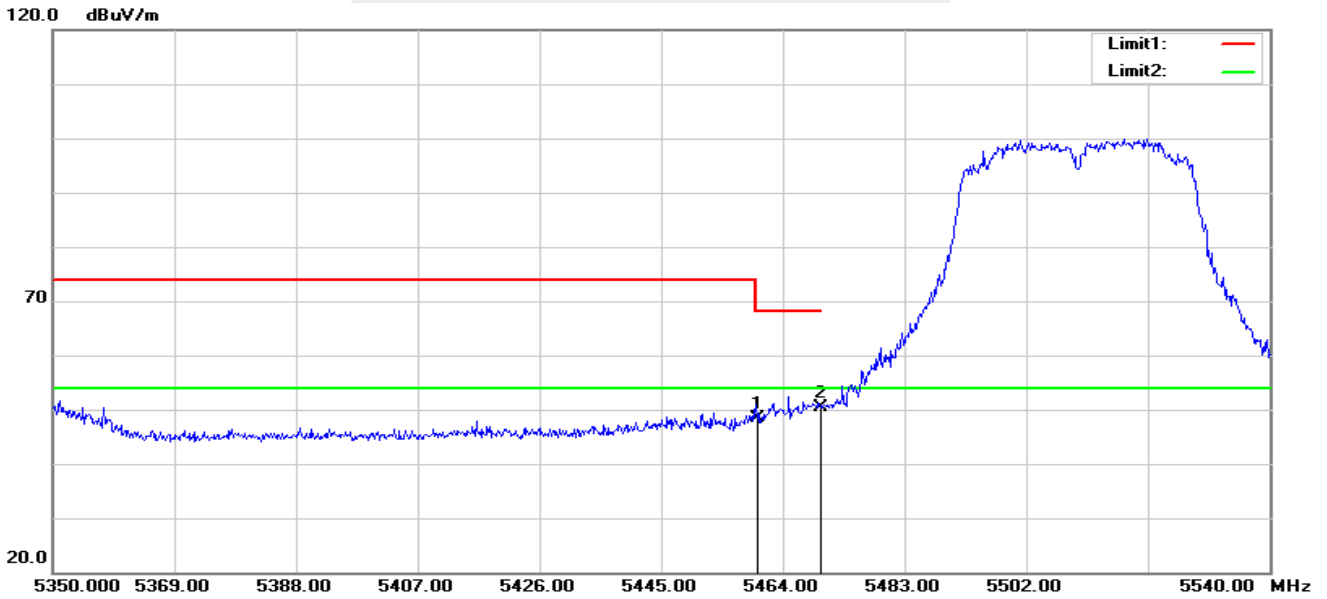

No.	Frequency (MHz)	Reading (dBuV)	Correct Factor(dB/m)	Result (dBuV/m)	Limit (dBuV/m)	Margin (dB)	Remark
1	5460.000	53.39	-5.11	48.28	68.20	-19.92	peak
2	5470.000	55.47	-5.09	50.38	68.20	-17.82	peak



802.11n40-H-H

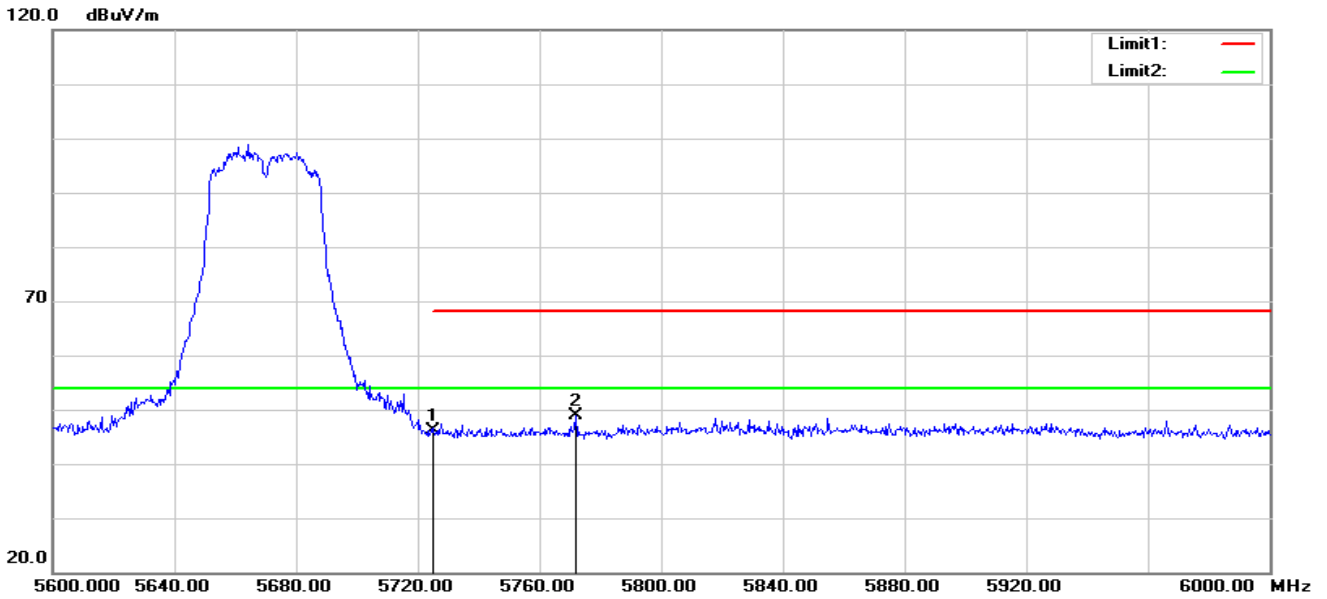

No.	Frequency (MHz)	Reading (dBuV)	Correct Factor(dB/m)	Result (dBuV/m)	Limit (dBuV/m)	Margin (dB)	Remark
1	5725.000	50.64	-4.57	46.07	68.20	-22.13	peak
2	5772.000	53.18	-4.41	48.77	68.20	-19.43	peak

802.11n40-H-V

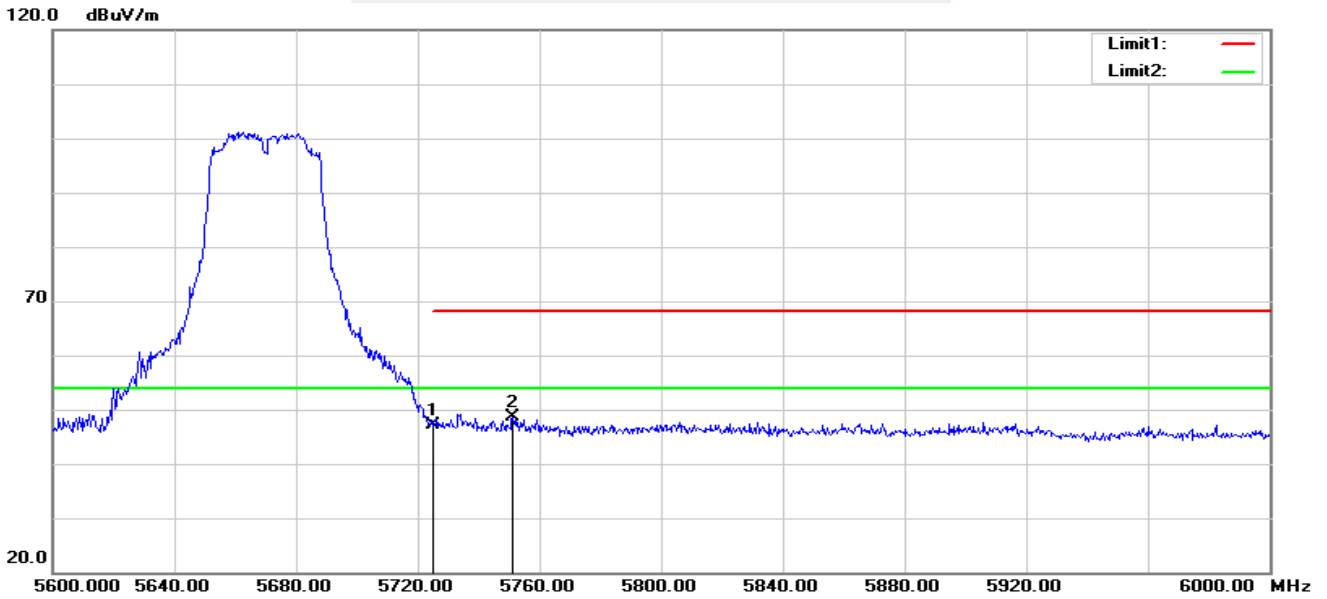

No.	Frequency (MHz)	Reading (dBuV)	Correct Factor(dB/m)	Result (dBuV/m)	Limit (dBuV/m)	Margin (dB)	Remark
1	5725.000	51.59	-4.57	47.02	68.20	-21.18	peak
2	5751.200	53.11	-4.49	48.62	68.20	-19.58	peak



802.11ac80-L-H

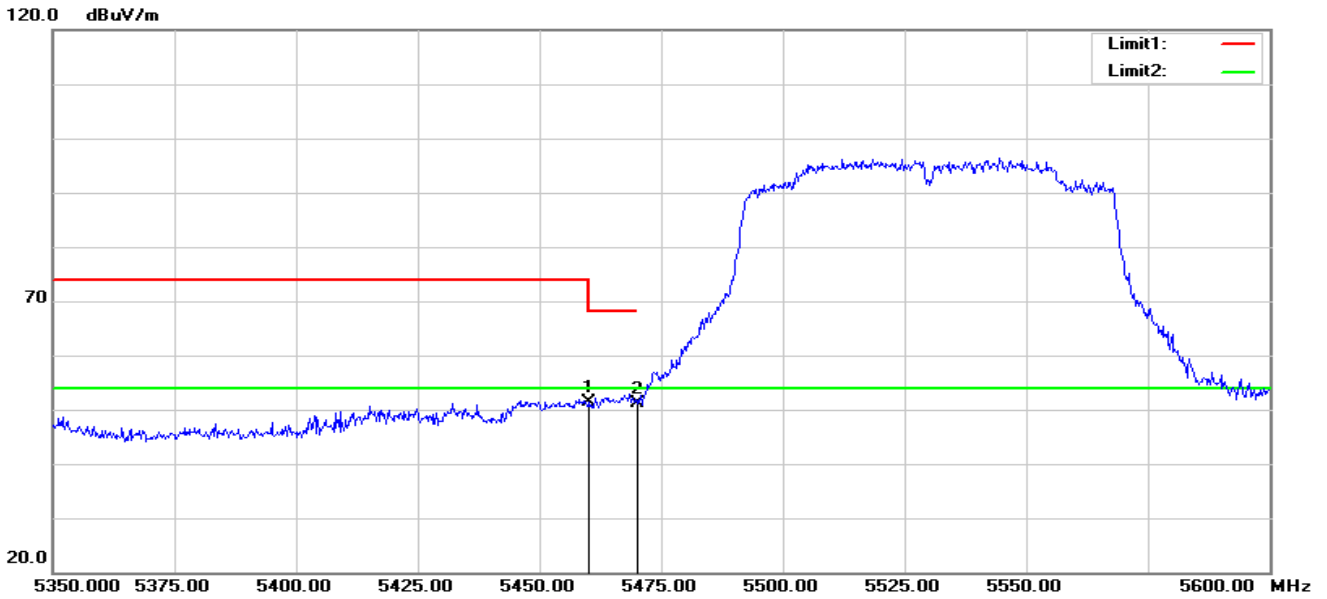

No.	Frequency (MHz)	Reading (dBuV)	Correct Factor(dB/m)	Result (dBuV/m)	Limit (dBuV/m)	Margin (dB)	Remark
1	5460.000	56.49	-5.11	51.38	68.20	-16.82	peak
2	5470.000	56.34	-5.09	51.25	68.20	-16.95	peak

802.11ac80-L-V

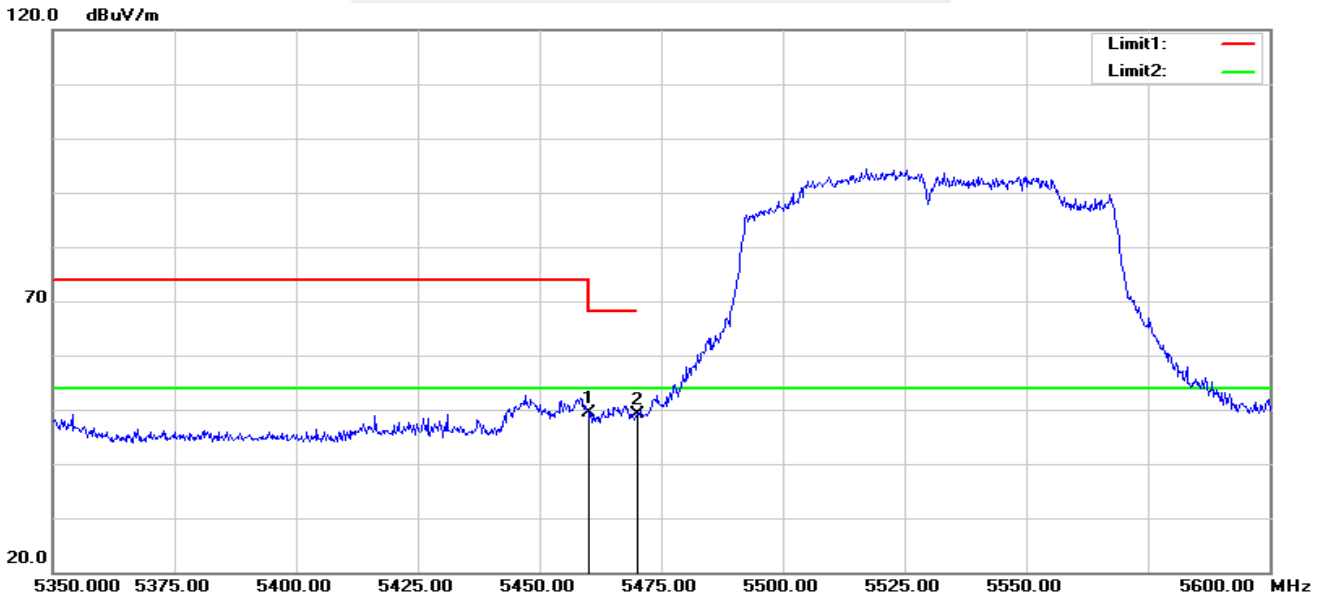

No.	Frequency (MHz)	Reading (dBuV)	Correct Factor(dB/m)	Result (dBuV/m)	Limit (dBuV/m)	Margin (dB)	Remark
1	5460.000	54.61	-5.11	49.50	68.20	-18.70	peak
2	5470.000	54.24	-5.09	49.15	68.20	-19.05	peak



802.11ac80-H-H

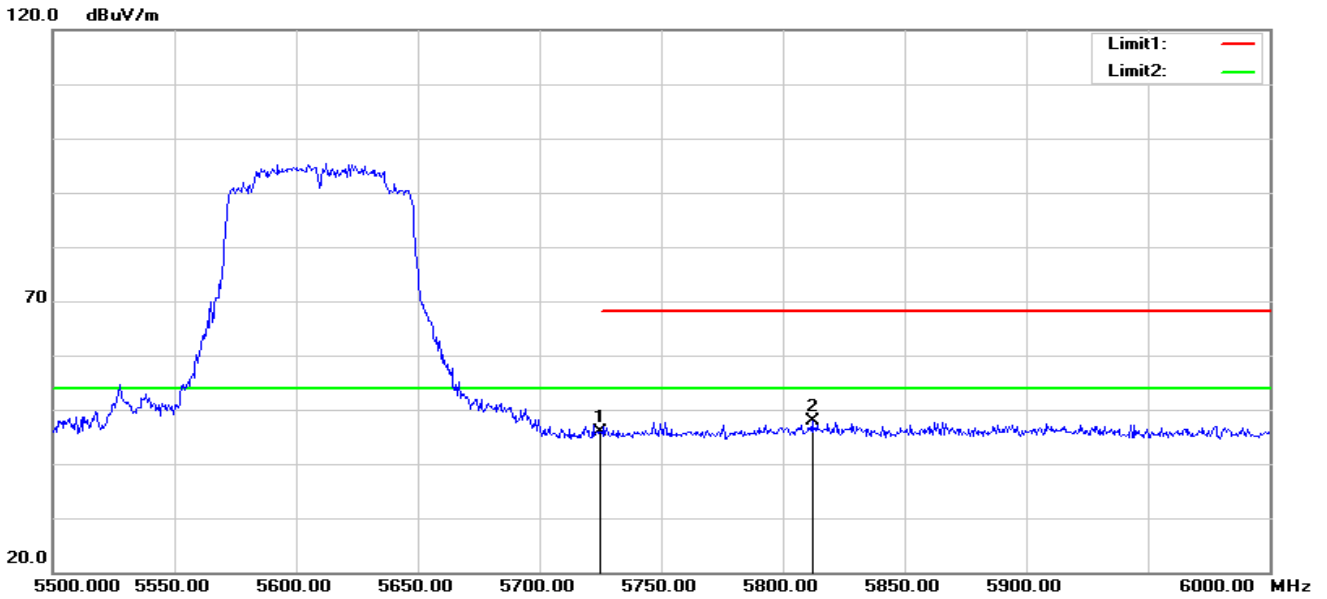

No.	Frequency (MHz)	Reading (dBuV)	Correct Factor(dB/m)	Result (dBuV/m)	Limit (dBuV/m)	Margin (dB)	Remark
1	5725.000	50.51	-4.57	45.94	68.20	-22.26	peak
2	5812.000	52.26	-4.27	47.99	68.20	-20.21	peak

802.11ac80-H-V

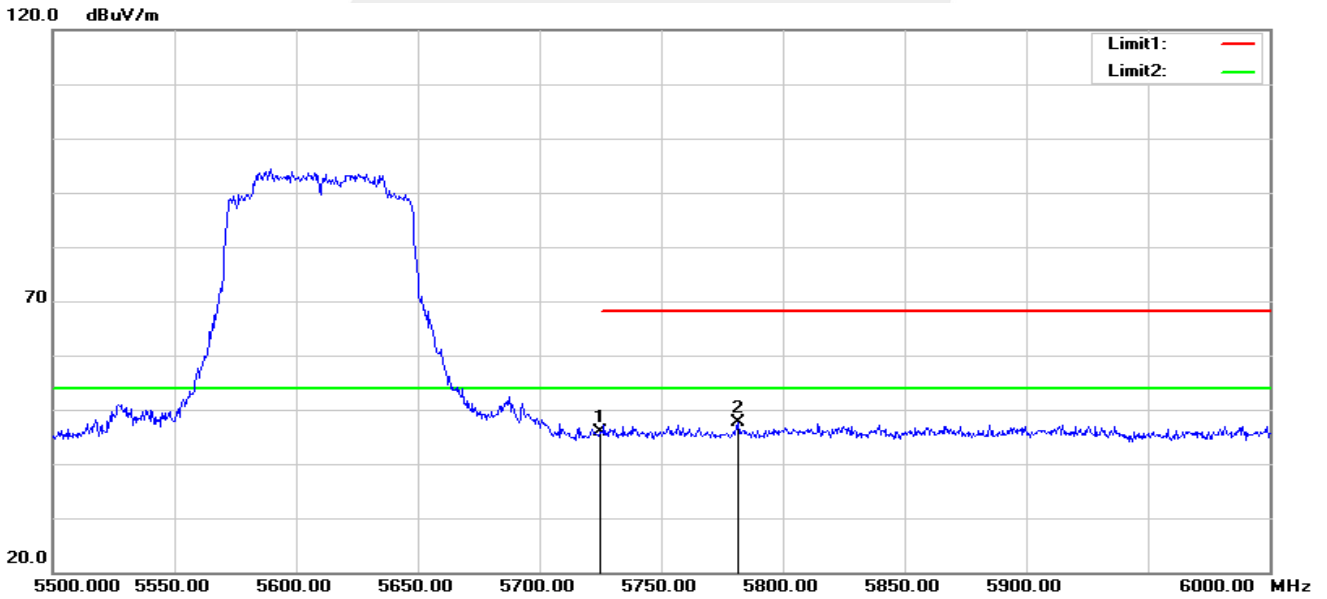

No.	Frequency (MHz)	Reading (dBuV)	Correct Factor(dB/m)	Result (dBuV/m)	Limit (dBuV/m)	Margin (dB)	Remark
1	5725.000	50.56	-4.57	45.99	68.20	-22.21	peak
2	5781.500	51.97	-4.38	47.59	68.20	-20.61	peak



802.11ac160-L-H

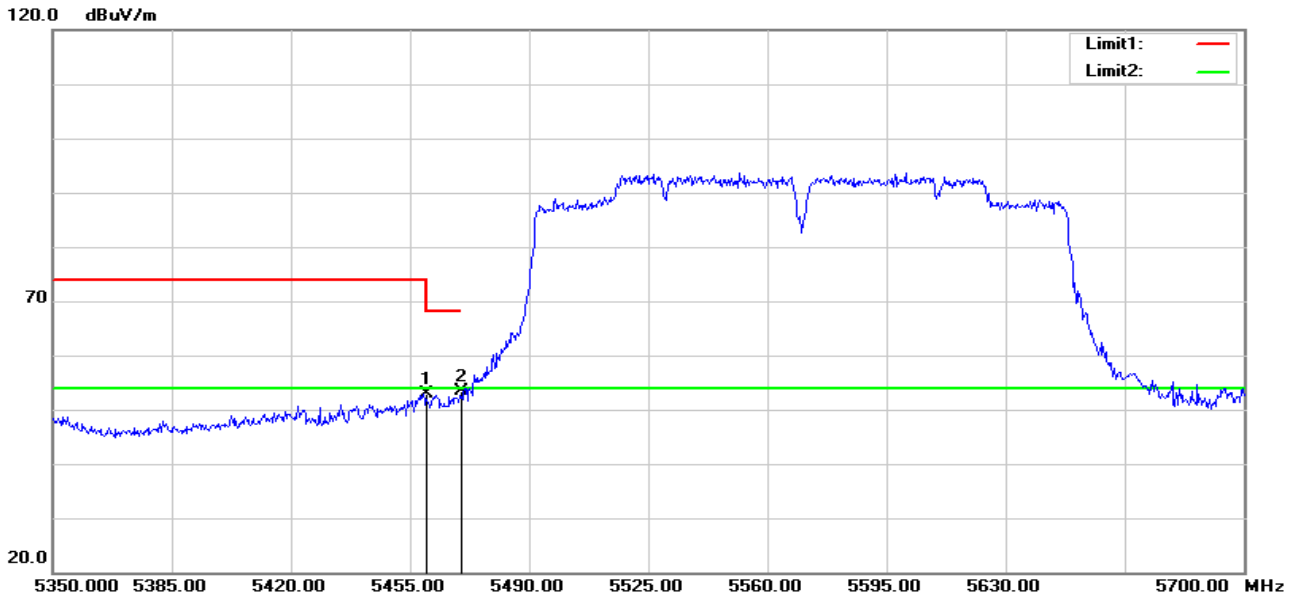

No.	Frequency (MHz)	Reading (dBuV)	Correct Factor(dB/m)	Result (dBuV/m)	Limit (dBuV/m)	Margin (dB)	Remark
1	5460.000	58.01	-5.11	52.90	68.20	-15.30	peak
2	5470.000	58.35	-5.09	53.26	68.20	-14.94	peak

802.11ac160-L-V

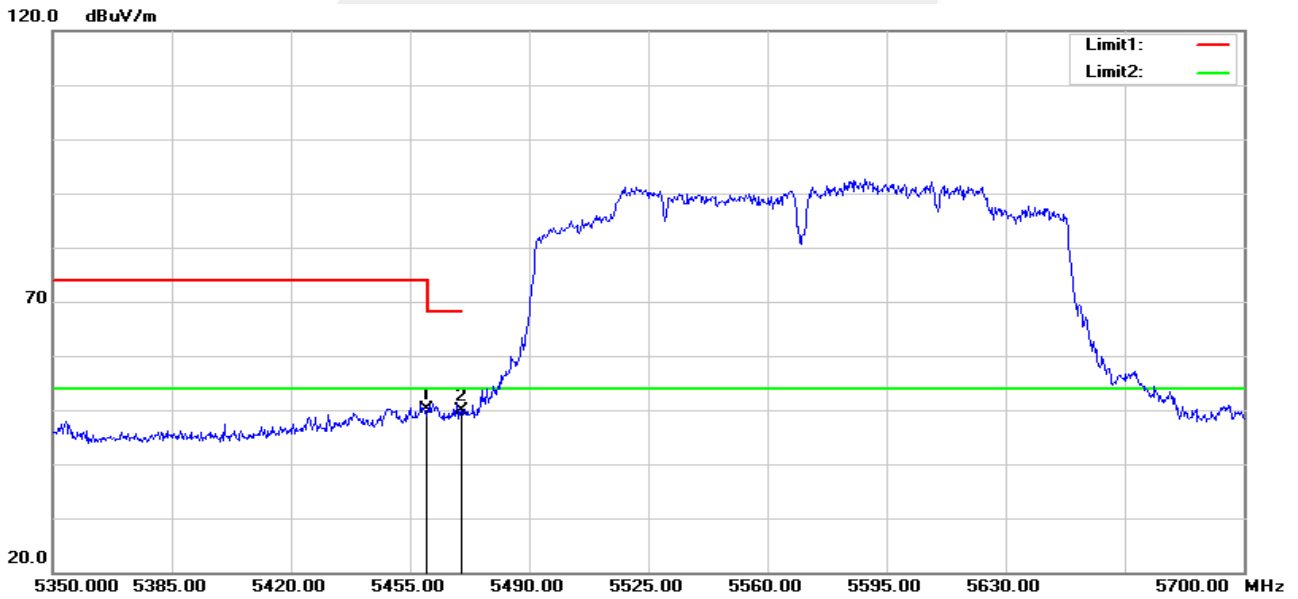

No.	Frequency (MHz)	Reading (dBuV)	Correct Factor(dB/m)	Result (dBuV/m)	Limit (dBuV/m)	Margin (dB)	Remark
1	5460.000	55.34	-5.11	50.23	68.20	-17.97	peak
2	5470.000	55.00	-5.09	49.91	68.20	-18.29	peak



802.11ac160-H-H

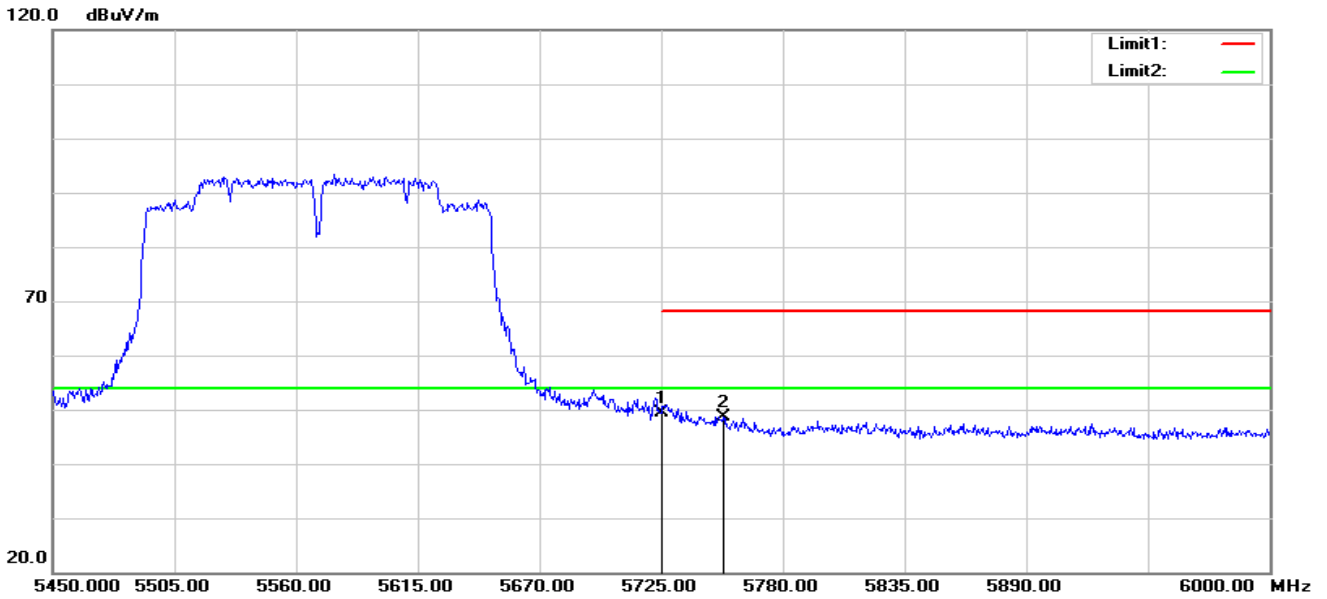

No.	Frequency (MHz)	Reading (dBuV)	Correct Factor(dB/m)	Result (dBuV/m)	Limit (dBuV/m)	Margin (dB)	Remark
1	5725.000	53.96	-4.57	49.39	68.20	-18.81	peak
2	5753.050	53.18	-4.48	48.70	68.20	-19.50	peak

802.11ac160-H-V

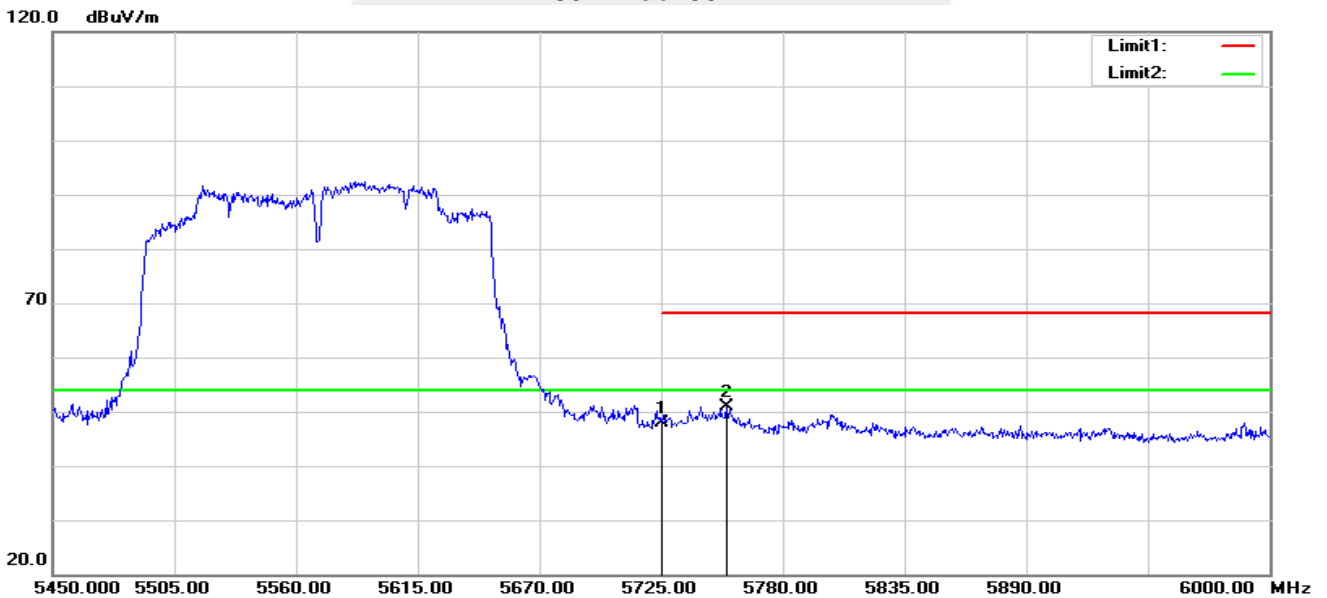

No.	Frequency (MHz)	Reading (dBuV)	Correct Factor(dB/m)	Result (dBuV/m)	Limit (dBuV/m)	Margin (dB)	Remark
1	5725.000	52.55	-4.57	47.98	68.20	-20.22	peak
2	5754.700	55.45	-4.47	50.98	68.20	-17.22	peak

Note: All modes have been tested. Only the worst mode shown in the report.



U-NII-3 (5.725-5.85 GHz)

802.11ax20-L-H

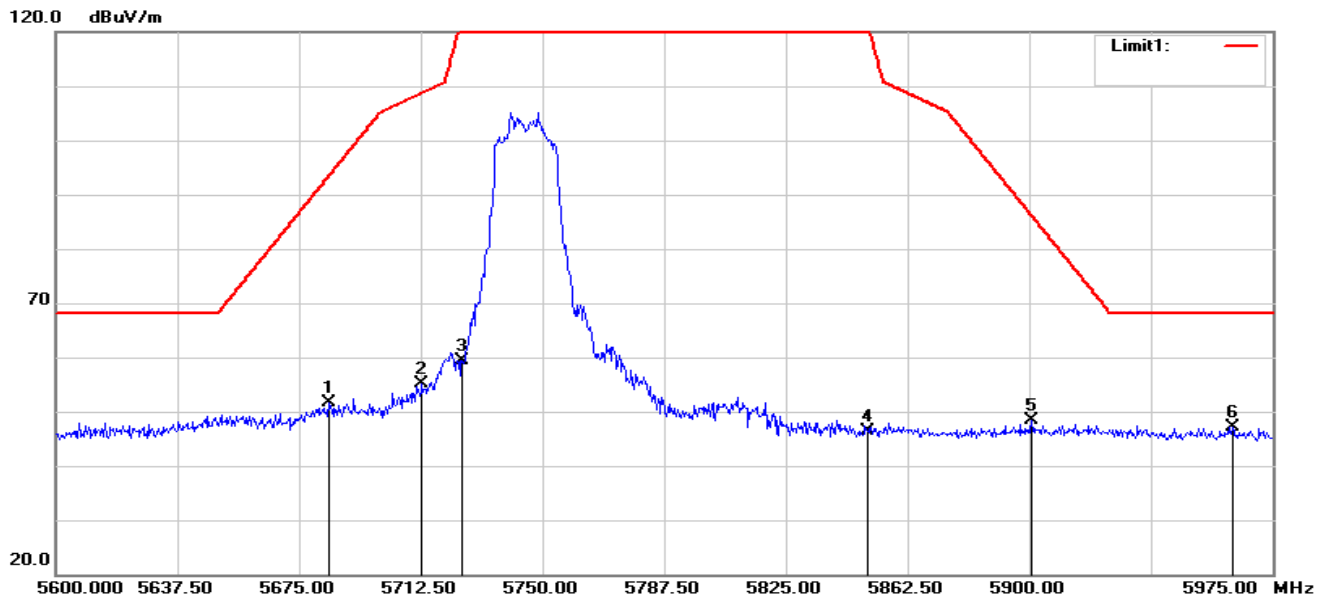

No.	Frequency (MHz)	Reading (dBuV)	Correct Factor(dB/m)	Result (dBuV/m)	Limit (dBuV/m)	Margin (dB)	Remark
1	5684.000	56.31	-4.67	51.64	93.36	-41.72	peak
2	5712.875	59.86	-4.62	55.24	108.80	-53.56	peak
3	5725.000	64.02	-4.57	59.45	122.20	-62.75	peak
4	5850.000	50.56	-4.10	46.46	122.20	-75.74	peak
5	5900.750	52.16	-3.88	48.28	86.14	-37.86	peak
6	5962.625	51.24	-3.99	47.25	68.20	-20.95	peak



802.11ax20-L-V

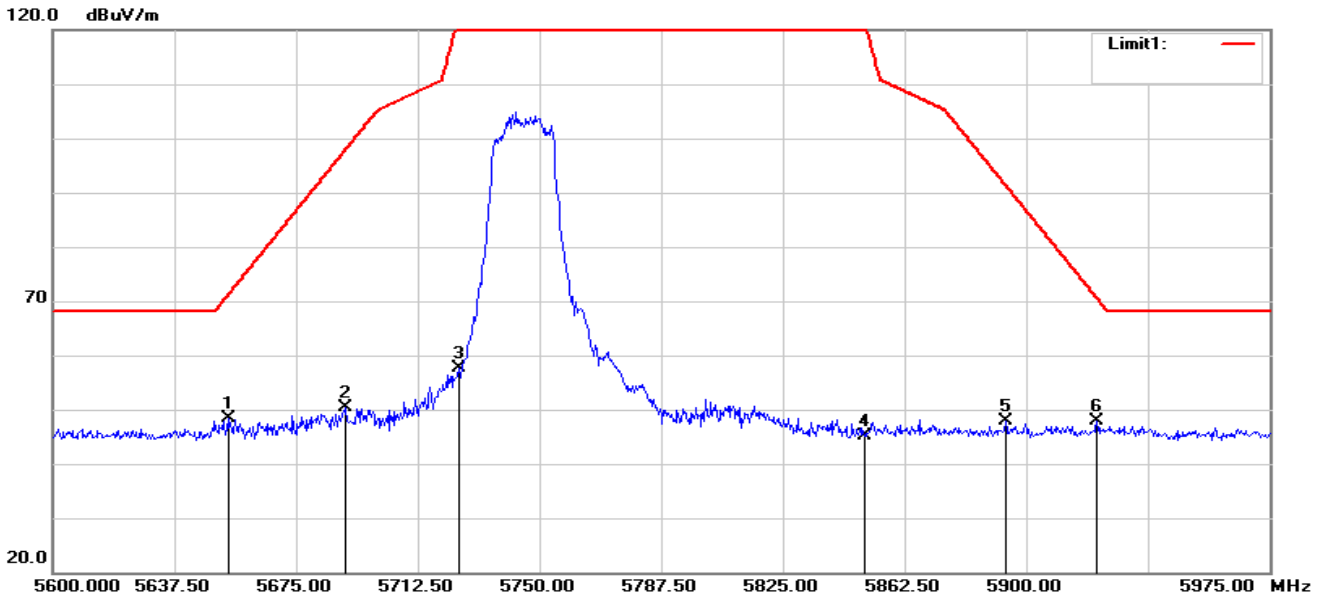

No.	Frequency (MHz)	Reading (dBuV)	Correct Factor(dB/m)	Result (dBuV/m)	Limit (dBuV/m)	Margin (dB)	Remark
1	5654.000	52.97	-4.67	48.30	71.16	-22.86	peak
2	5690.375	54.94	-4.67	50.27	98.08	-47.81	peak
3	5725.000	62.20	-4.57	57.63	122.20	-64.57	peak
4	5850.000	49.27	-4.10	45.17	122.20	-77.03	peak
5	5893.625	51.88	-3.91	47.97	91.42	-43.45	peak
6	5921.750	51.76	-3.92	47.84	70.61	-22.77	peak



802.11ax20-H-H

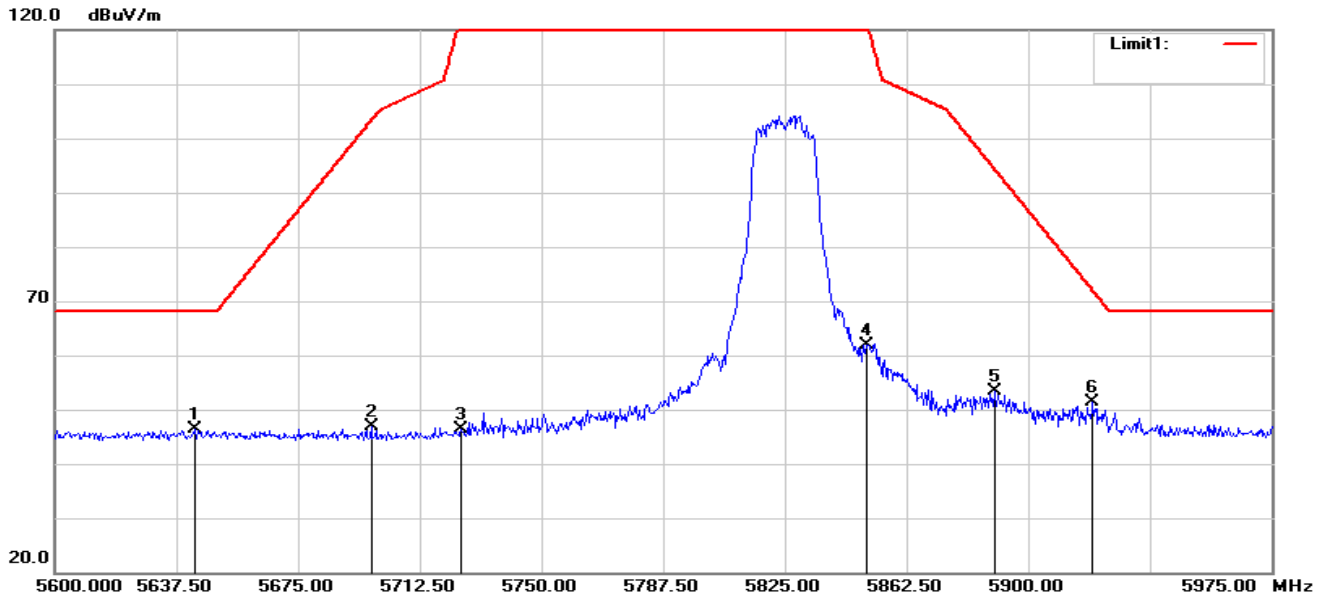

No.	Frequency (MHz)	Reading (dBuV)	Correct Factor(dB/m)	Result (dBuV/m)	Limit (dBuV/m)	Margin (dB)	Remark
1	5643.125	51.16	-4.68	46.48	68.20	-21.72	peak
2	5697.500	51.42	-4.66	46.76	103.35	-56.59	peak
3	5725.000	51.07	-4.57	46.50	122.20	-75.70	peak
4	5850.000	66.09	-4.10	61.99	122.20	-60.21	peak
5	5889.500	57.38	-3.93	53.45	94.47	-41.02	peak
6	5919.875	55.18	-3.92	51.26	71.99	-20.73	peak



802.11ax20-H-V

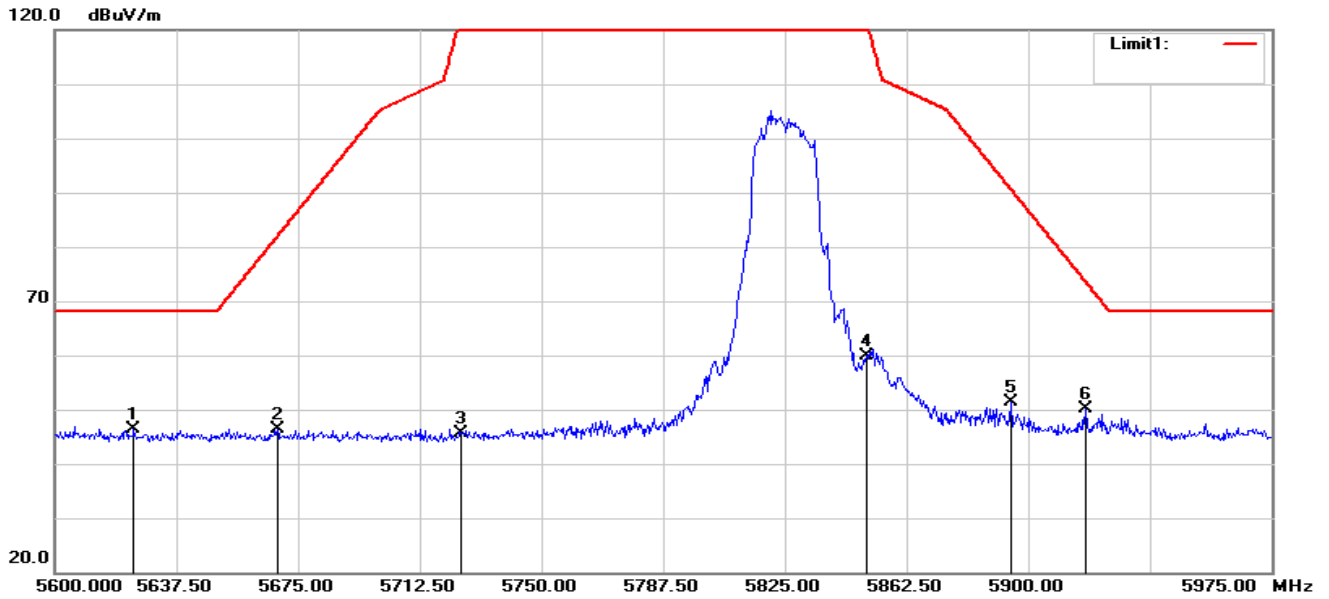

No.	Frequency (MHz)	Reading (dBuV)	Correct Factor(dB/m)	Result (dBuV/m)	Limit (dBuV/m)	Margin (dB)	Remark
1	5624.375	51.02	-4.69	46.33	68.20	-21.87	peak
2	5668.625	50.99	-4.67	46.32	81.98	-35.66	peak
3	5725.000	50.17	-4.57	45.60	122.20	-76.60	peak
4	5850.000	63.86	-4.10	59.76	122.20	-62.44	peak
5	5894.750	55.18	-3.90	51.28	90.59	-39.31	peak
6	5917.625	54.04	-3.91	50.13	73.66	-23.53	peak



802.11n40-L-H

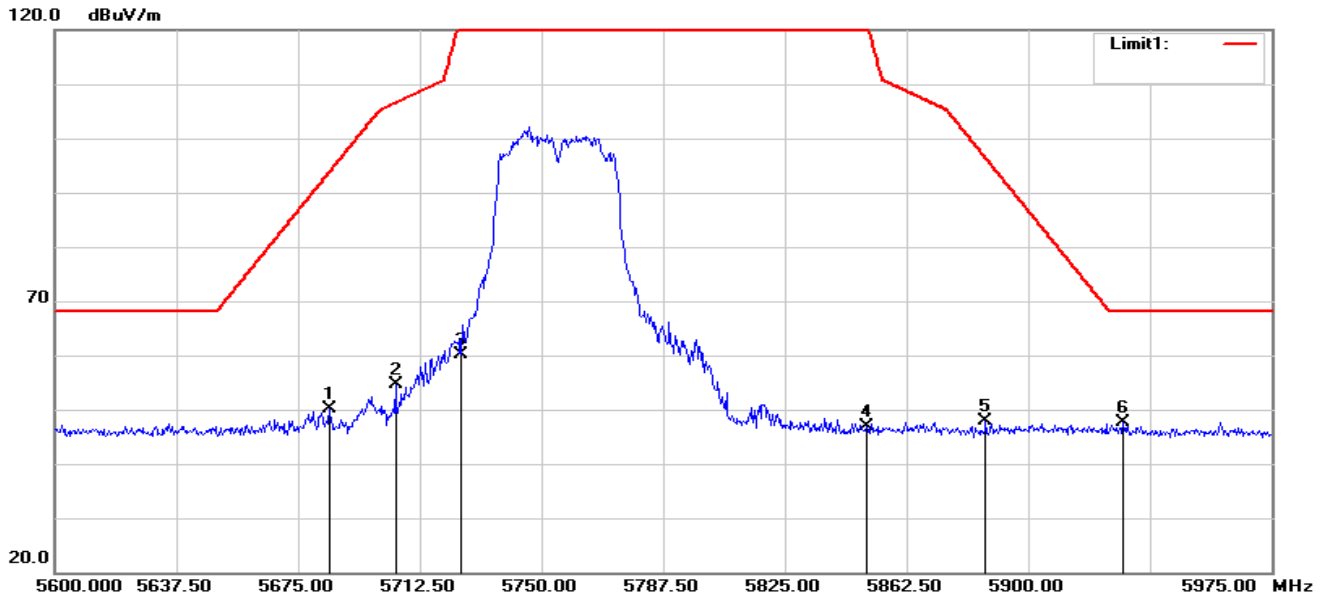

No.	Frequency (MHz)	Reading (dBuV)	Correct Factor(dB/m)	Result (dBuV/m)	Limit (dBuV/m)	Margin (dB)	Remark
1	5684.750	54.75	-4.66	50.09	93.92	-43.83	peak
2	5705.000	59.36	-4.64	54.72	106.60	-51.88	peak
3	5725.000	64.73	-4.57	60.16	122.20	-62.04	peak
4	5850.000	51.02	-4.10	46.92	122.20	-75.28	peak
5	5886.875	51.81	-3.94	47.87	96.41	-48.54	peak
6	5929.250	51.51	-3.93	47.58	68.20	-20.62	peak



802.11n40-L-V

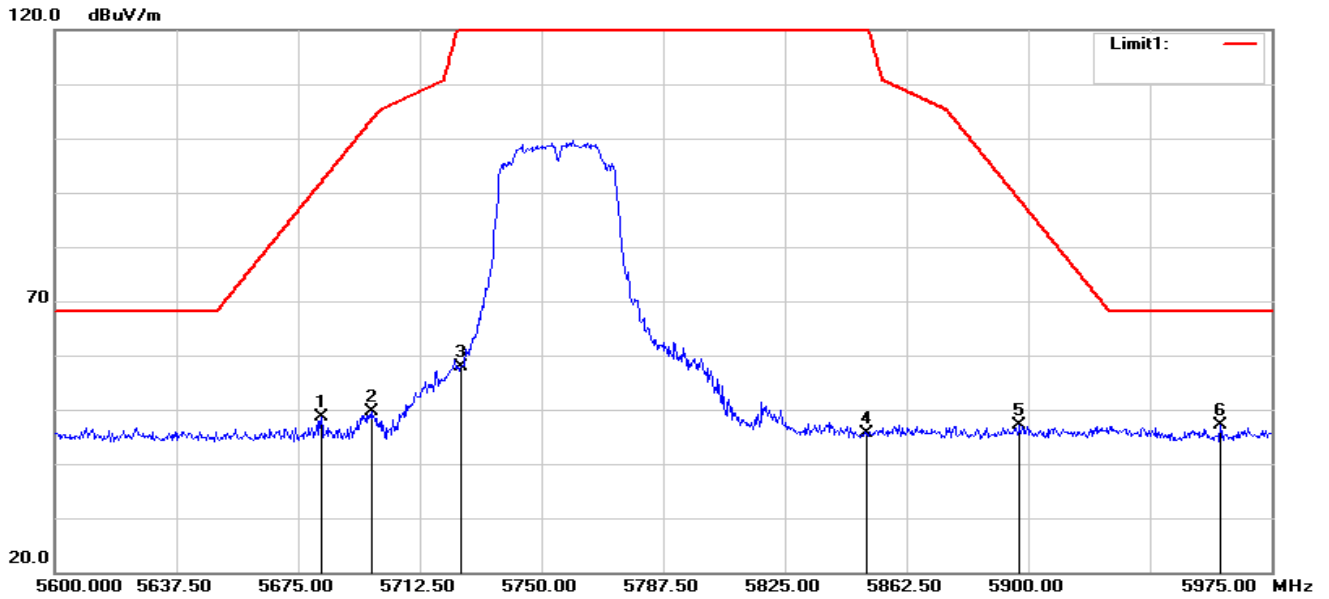

No.	Frequency (MHz)	Reading (dBuV)	Correct Factor(dB/m)	Result (dBuV/m)	Limit (dBuV/m)	Margin (dB)	Remark
1	5682.125	53.31	-4.67	48.64	91.97	-43.33	peak
2	5697.500	54.31	-4.66	49.65	103.35	-53.70	peak
3	5725.000	62.46	-4.57	57.89	122.20	-64.31	peak
4	5850.000	49.76	-4.10	45.66	122.20	-76.54	peak
5	5897.375	50.92	-3.89	47.03	88.64	-41.61	peak
6	5959.250	51.08	-3.99	47.09	68.20	-21.11	peak



802.11n40-H-H

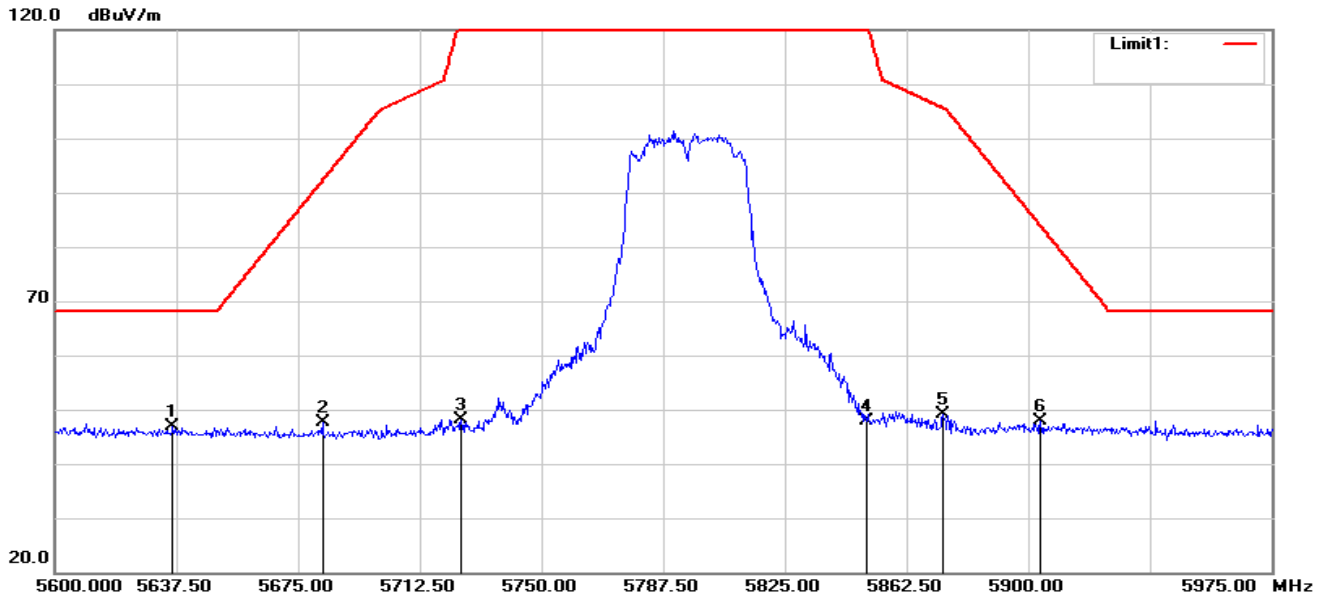

No.	Frequency (MHz)	Reading (dBuV)	Correct Factor(dB/m)	Result (dBuV/m)	Limit (dBuV/m)	Margin (dB)	Remark
1	5636.375	51.51	-4.68	46.83	68.20	-21.37	peak
2	5682.500	52.34	-4.67	47.67	92.25	-44.58	peak
3	5725.000	52.62	-4.57	48.05	122.20	-74.15	peak
4	5850.000	51.97	-4.10	47.87	122.20	-74.33	peak
5	5873.750	53.09	-3.99	49.10	105.55	-56.45	peak
6	5903.750	51.79	-3.88	47.91	83.92	-36.01	peak



802.11n40-H-V

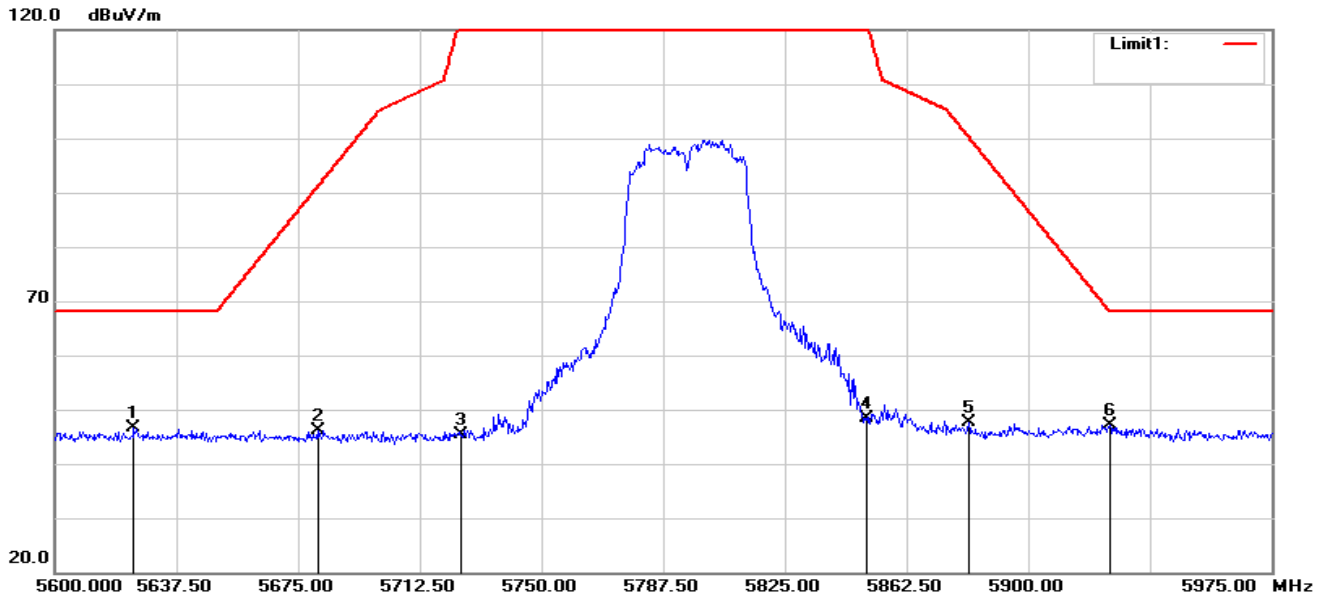

No.	Frequency (MHz)	Reading (dBuV)	Correct Factor(dB/m)	Result (dBuV/m)	Limit (dBuV/m)	Margin (dB)	Remark
1	5624.375	51.29	-4.69	46.60	68.20	-21.60	peak
2	5681.000	50.88	-4.67	46.21	91.14	-44.93	peak
3	5725.000	49.99	-4.57	45.42	122.20	-76.78	peak
4	5850.000	52.37	-4.10	48.27	122.20	-73.93	peak
5	5881.625	51.50	-3.96	47.54	100.30	-52.76	peak
6	5925.125	51.07	-3.92	47.15	68.20	-21.05	peak



802.11ac80-H

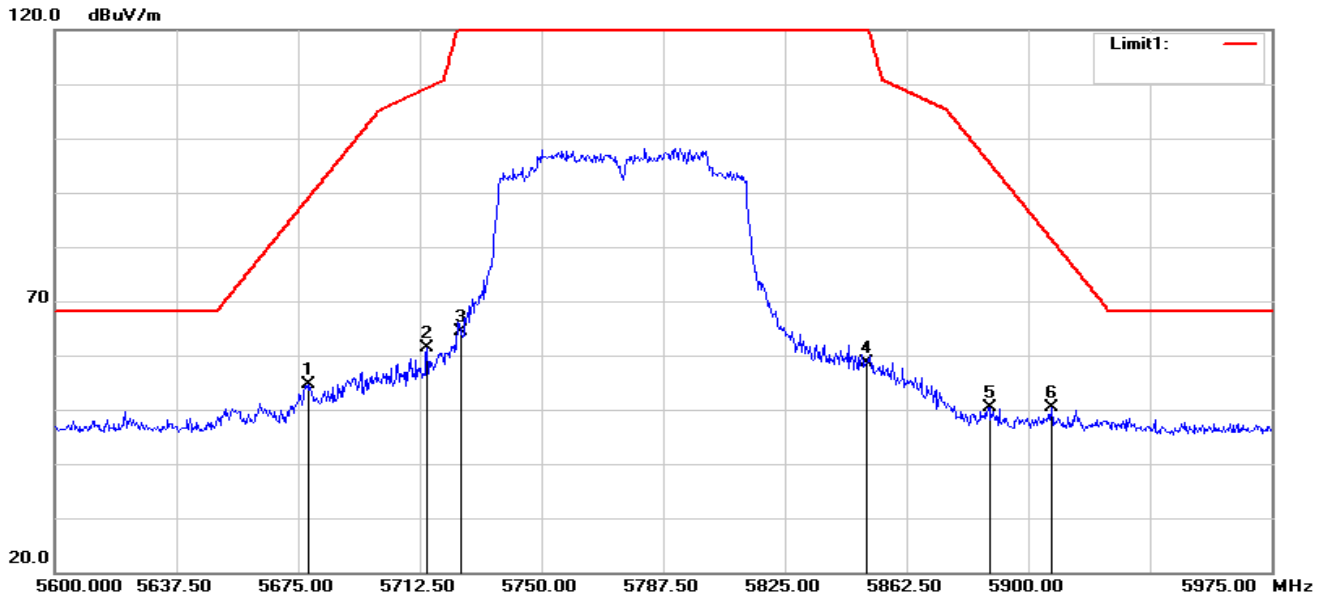

No.	Frequency (MHz)	Reading (dBuV)	Correct Factor(dB/m)	Result (dBuV/m)	Limit (dBuV/m)	Margin (dB)	Remark
1	5678.375	59.35	-4.66	54.69	89.20	-34.51	peak
2	5714.750	66.07	-4.61	61.46	109.33	-47.87	peak
3	5725.000	68.90	-4.57	64.33	122.20	-57.87	peak
4	5850.000	62.74	-4.10	58.64	122.20	-63.56	peak
5	5888.000	54.38	-3.93	50.45	95.58	-45.13	peak
6	5907.125	54.20	-3.89	50.31	81.43	-31.12	peak



802.11ac80-V

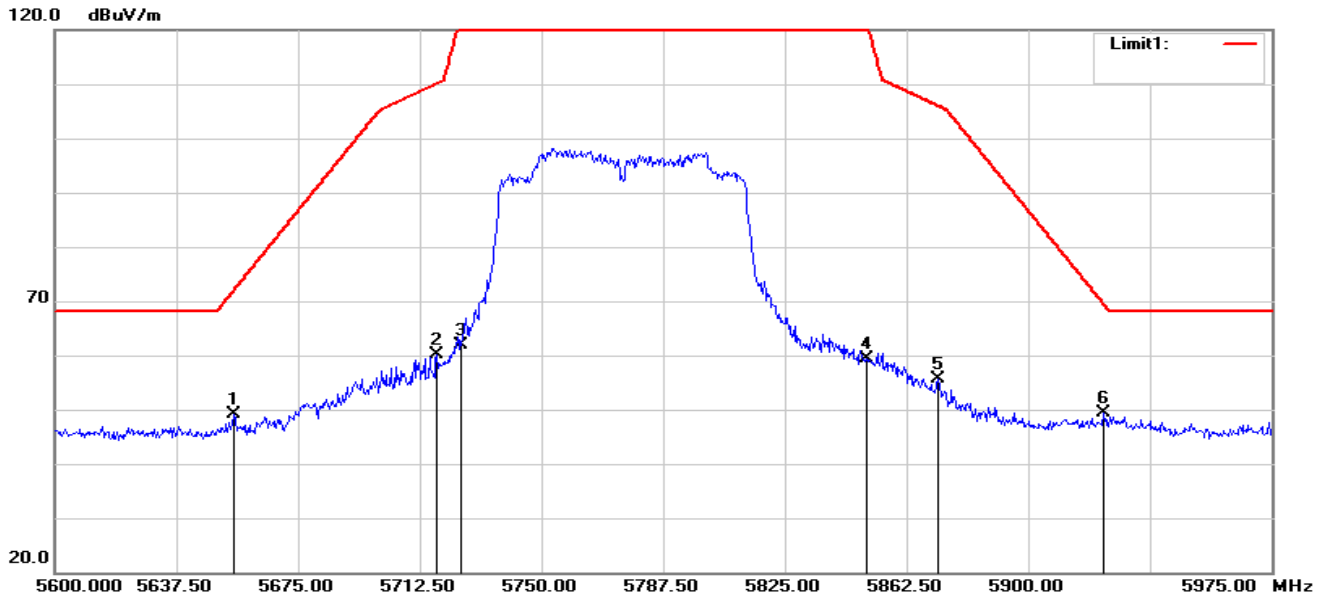

No.	Frequency (MHz)	Reading (dBuV)	Correct Factor(dB/m)	Result (dBuV/m)	Limit (dBuV/m)	Margin (dB)	Remark
1	5655.125	53.79	-4.68	49.11	71.99	-22.88	peak
2	5717.750	64.62	-4.60	60.02	110.17	-50.15	peak
3	5725.000	66.37	-4.57	61.80	122.20	-60.40	peak
4	5850.000	63.42	-4.10	59.32	122.20	-62.88	peak
5	5872.250	59.51	-4.00	55.51	105.97	-50.46	peak
6	5923.250	53.23	-3.92	49.31	69.50	-20.19	peak

Note: All modes have been tested. Only the worst mode shown in the report.



4. POWER SPECTRAL DENSITY TEST

4.1 LIMIT

1. For mobile and portable client devices in the 5.15-5.25 GHz band, the maximum power spectral density shall not exceed 11 dBm in any 1 megahertz band. If transmitting antennas of directional gain greater than 6 dBi are used, both the maximum conducted output power and the maximum power spectral density shall be reduced by the amount in dB that the directional gain of the antenna exceeds 6 dBi.
2. For the 5.25-5.35 GHz and 5.47-5.725 GHz bands, the maximum power spectral density shall not exceed 11 dBm in any 1 megahertz band. If transmitting antennas of directional gain greater than 6 dBi are used, both the maximum conducted output power and the maximum power spectral density shall be reduced by the amount in dB that the directional gain of the antenna exceeds 6 dBi.
3. For the band 5.725-5.850 GHz, the peak power spectral density shall not exceed 30 dBm in any 500KHz band. If transmitting antenna directional gain is greater than 6 dBi, both the maximum conducted output power and the peak power spectral density shall be reduced by the amount in dB that the directional gain of the antenna exceeds 6 dBi.

4.2 TEST PROCEDURE

1. The setting follows Method SA-1 of FCC KDB 789033 D02 General U-NII Test Procedures New Rules v02r01.

For devices operating in the band, the rules specify a measurement bandwidth of 500 kHz.

Many spectrum analyzers do not have 500 kHz RBW, thus a narrower RBW may need to be used.

The rules permit the use of a RBWs less than 1 MHz, or 500 kHz, "provided that the measured power is integrated over the full reference bandwidth" to show the total power over the specified measurement bandwidth (*i.e.*, 1 MHz, or 500 kHz). If measurements are performed using a reduced resolution bandwidth (< 1 MHz, or < 500 kHz) and integrated over 1 MHz, or 500 KHz bandwidth, the following adjustments to the procedures apply:

- a) Set $RBW \geq 1/T$, where T is defined in section II.B.I.a).
- b) Set $VBW \geq 3 RBW$.
- c) If measurement bandwidth of Maximum PSD is specified in 500 kHz, add $10 \log (500\text{kHz}/RBW)$ to the measured result, whereas $RBW (< 500 \text{ kHz})$ is the reduced resolution bandwidth of the spectrum analyzer set during measurement.
- d) If measurement bandwidth of Maximum PSD is specified in 1 MHz, add $10 \log (1\text{MHz}/RBW)$ to the measured result, whereas $RBW (< 1 \text{ MHz})$ is the reduced resolution bandwidth of spectrum analyzer set during measurement.
- e) Care must be taken to ensure that the measurements are performed during a period of continuous transmission or are corrected upward for duty cycle.

Note: As a practical matter, it is recommended to use reduced RBW of 100 kHz for the sections 5.c) and 5.d) above, since $RBW=100 \text{ KHZ}$ is available on nearly all spectrum analyzers.

4.3 DEVIATION FROM STANDARD

No deviation.

4.4 TEST SETUP



4.5 EUT OPERATION CONDITIONS

The EUT tested system was configured as the statements of 2.1 Unless otherwise a special operating condition is specified in the follows during the testing.

4.6 TEST RESULTS

Note: The test data please reference to attachment "STS2205155W05_Appendix 5G WIFI".

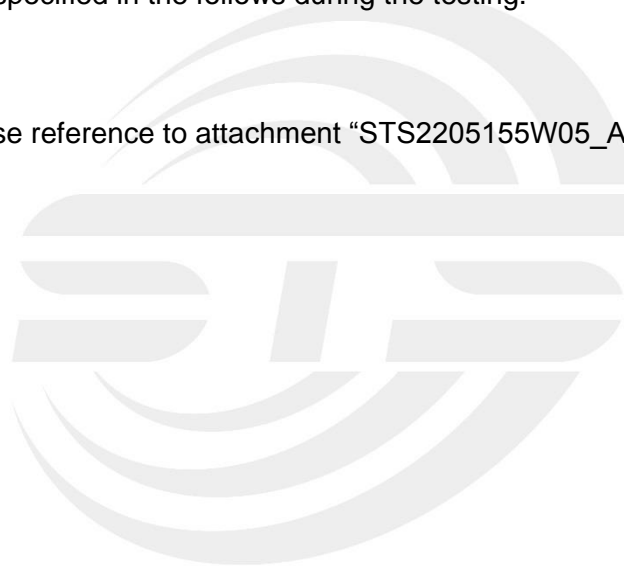

5. BANDWIDTH MEASUREMENT

5.1 EMISSION BANDWIDTH (EBW) 26 BANDWID PROCEDURES / LIMIT

The following procedure shall be used for measuring 26 bandwidth.

5.1.1 TEST PROCEDURE

1. The testing follows FCC KDB 789033 D02 General UNII Test Procedures New Rules v02r01.
2. Set RBW = approximately 1% of the emission bandwidth.
3. Set the VBW \geq RBW.
4. Detector = Peak.
5. Trace mode = max hold.
6. Measure the maximum width of the emission that is 26 dB down from the peak of the emission. Compare this with the RBW setting of the analyzer. Readjust RBW and repeat measurement as needed until the RBW/EBW ratio is approximately 1%.

5.1.2 DEVIATION FROM STANDARD

No deviation.

5.1.3 TEST SETUP



5.1.4 EUT OPERATION CONDITIONS

The EUT tested system was configured as the statements of 2.4 Unless otherwise a special operating condition is specified in the follows during the testing.

5.1.5 TEST RESULTS

- Note: 1. ANT A Power > ANT B Power, Both ANT A and B have been test, Only show the worst data of ANT A.
2. The test data please reference to attachment "STS2205155W05_Appendix 5G WIFI".

5.2 OCCUPIED BANDWIDTH (99%) TEST APPLIED PROCEDURES / LIMIT

The following procedure shall be used for measuring (99 %) power bandwidth.

5.2.1 TEST PROCEDURE

1. The testing follows FCC KDB 789033 D02 General UNII Test Procedures v02r01.

The following procedure shall be used for measuring (99 %) power bandwidth:

1. Set center frequency to the nominal EUT channel center frequency.
2. Set span = 1.5 times to 5.0 times the OBW.
3. Set RBW = 1 % to 5 % of the OBW
4. Set VBW $\geq 3 \cdot$ RBW
5. Video averaging is not permitted. Where practical, a sample detection and single sweep mode shall be used. Otherwise, peak detection and max hold mode (until the trace stabilizes) shall be used.
6. Use the 99 % power bandwidth function of the instrument (if available).
7. If the instrument does not have a 99 % power bandwidth function, the trace data points are recovered and directly summed in power units. The recovered amplitude data points, beginning at the lowest frequency, are placed in a running sum until 0.5 % of the total is reached; that frequency is recorded as the lower frequency. The process is repeated until 99.5 % of the total is reached; that frequency is recorded as the upper frequency. The 99% occupied bandwidth is the difference between these two frequencies.

5.2.2 DEVIATION FROM STANDARD

No deviation.

5.2.3 TEST SETUP



5.2.4 EUT OPERATION CONDITIONS

The EUT tested system was configured as the statements of 2.4 Unless otherwise a special operating condition is specified in the follows during the testing.

5.2.5 TEST RESULTS

Note: 1. ANT A Power > ANT B Power, Both ANT A and B have been test, Only show the worst data of ANT A.

2. The test data please reference to attachment “STS2205155W05_Appendix 5G WIFI”.

5.3 MINIMUM EMISSION BANDWIDTH(6 DB) PROCEDURES / LIMIT

Section 15.407(e) specifies the minimum 6 dB emission bandwidth of at least 500 KHz for the band 5.725-5.85 GHz. The following procedure shall be used for measuring this bandwidth.

5.3.1 TEST PROCEDURE

1. The testing follows FCC KDB 789033 D02 General UNII Test Procedures v02r01.
 - a) Set RBW = 100 kHz.
 - b) Set the video bandwidth (VBW) $\geq 3 \times$ RBW.
 - c) Detector = Peak.
 - d) Trace mode = max hold.
 - e) Sweep = auto couple.
 - f) Allow the trace to stabilize.
 - g) Measure the maximum width of the emission that is constrained by the frequencies associated with the two outermost amplitude points (upper and lower frequencies) that are attenuated by 6 dB relative to the maximum level measured in the fundamental emission.

5.3.2 DEVIATION FROM STANDARD

No deviation.

5.3.3 TEST SETUP



5.3.4 EUT OPERATION CONDITIONS

The EUT tested system was configured as the statements of 2.4 Unless otherwise a special operating condition is specified in the follows during the testing.

5.3.5 TEST RESULTS

- Note: 1. ANT A Power > ANT B Power, Both ANT A and B have been test, Only show the worst data of ANT A.
2. The test data please reference to attachment "STS2205155W05_Appendix 5G WIFI".

6. MAXIMUM CONDUCTED OUTPUT POWER

6.1 LIMIT

For mobile and portable client devices in the 5.15-5.25 GHz band, the maximum conducted output power over the frequency band of operation shall not exceed 250 mW provided the maximum antenna gain does not exceed 6 dBi. If transmitting antennas of directional gain greater than 6 dBi are used, both the maximum conducted output power and the maximum power spectral density shall be reduced by the amount in dB that the directional gain of the antenna exceeds 6 dBi.

For the 5.25-5.35 GHz and 5.47-5.725 GHz bands, the maximum conducted output power over the frequency bands of operation shall not exceed the lesser of 250 mW or 11 dBm + 10 log B, where B is the 26 dB emission bandwidth in megahertz, If transmitting antennas of directional gain greater than 6 dBi are used.

For the band 5.725-5.85 GHz, the maximum conducted output power over the frequency band of operation shall not exceed 1 W. If transmitting antennas of directional gain greater than 6 dBi are used.

FCC Part15 (15.407) , Subpart E				
Section	Test Item	Limit	Frequency Range (MHz)	Result
15.407(a) (1) (iv)	Peak Output Power	0.25 watt	5150-5250	PASS
		The lesser of 250 mW or 11 dBm + 10 log (26 dB emission bandwidth)	5250-5350 5470-5725	
15.407(a) (3)		1 watt	5725-5825	

6.2 TEST PROCEDURE

The EUT was directly connected to the Power Sensor&PC

6.3 DEVIATION FROM STANDARD

No deviation.

6.4 TEST SETUP

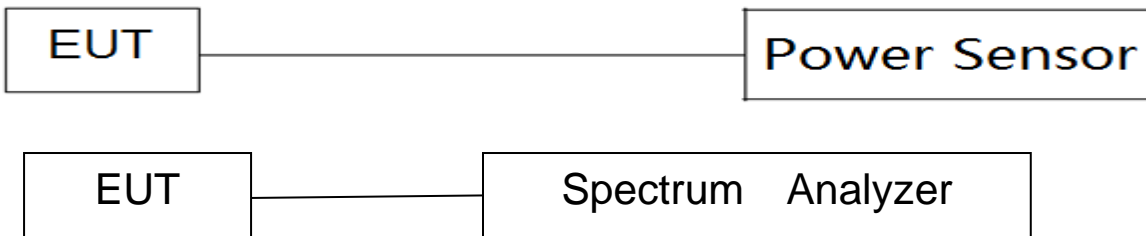

6.5 EUT OPERATION CONDITIONS

The EUT tested system was configured as the statements of 5 Unless otherwise a special operating condition is specified in the follows during the testing.

6.6 TEST RESULTS

Note: The test data please reference to attachment “STS2205155W05_Appendix 5G WIFI”.



7. AUTOMATICALLY DISCONTINUE TRANSMISSION

7.1 LIMIT OF AUTOMATICALLY DISCONTINUE TRANSMISSION

The device shall automatically discontinue transmission in case of either absence of information to transmit or operational failure. These provisions are not intended to preclude the transmission of control or signaling information or the use of repetitive codes used by certain digital technologies to complete frame or burst intervals. Applicants shall include in their application for equipment authorization to describe how this requirement is met.

7.2 TEST RESULT OF AUTOMATICALLY DISCONTINUE TRANSMISSION

During no any information transmission, the EUT can automatically discontinue transmission and become standby mode for power saving. The EUT can detect the controlling signal of ACK message transmitting from remote device and verify whether it shall resend or discontinue transmission





8. ANTENNA REQUIREMENT

8.1 STANDARD REQUIREMENT

15.203 requirement: For intentional device, according to 15.203: an intentional radiator shall be designed to ensure that no antenna other than that furnished by the responsible party shall be used with the device.

8.2 EUT ANTENNA

The EUT antenna is PIFA Antenna. It comply with the standard requirement.





APPENDIX - PHOTOS OF TEST SETUP

Note: See test photos in setup photo document for the actual connections between Product and support equipment.

※※※※※END OF THE REPORT※※※※※

