

FCC

SAR

TEST REPORT

ISSUED BY
Shenzhen BALUN Technology Co., Ltd.



FOR
Rugged Tablet PC

ISSUED TO
Winmate Communication INC.

9F, No. 111-6, Shing-De Rd., San-Chung Dist, New Taipei 24158,
Taiwan, R.O.C.

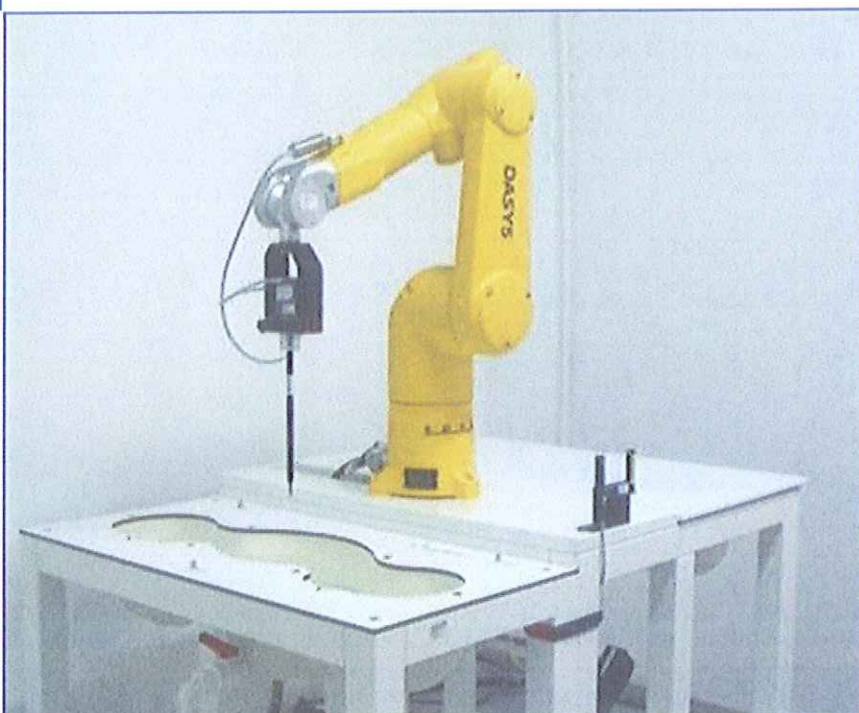

Tested by:

Tu Lang

Tu Lang
(Engineer)

Date

Jun. 20, 2016

Approved by:

Lao Jieming

Lao Jieming
(Technical Director)

Date

Jun. 20, 2016

Report No.: BL-SZ1640251-701

EUT Type: Rugged Tablet PC

Model Name: MMX-070, FlexCommand-7 ,
M700xxxxxxxxxxxx(The "X" can be 0-9, A-Z,
a-z, or blank for marketing purpose)

Brand Name: Winmate

FCC ID: PX9M700

Test Standard: FCC 47 CFR Part 2.1093

ANSI C95.1: 1992, IEEE 1528: 2013

Maximum SAR: Body (1 g): 0.351 W/kg

Test Conclusion: Pass

Test Date: May 5, 2016

Date of Issue: Jun. 20, 2016

NOTE: This test report can be duplicated completely for the legal use with the approval of the applicant; it shall not be reproduced except in full, without the written approval of Shenzhen BALUN Technology Co., Ltd. BALUN Laboratory. Any objections should be raised within thirty days from the date of issue. To validate the report, please visit BALUN website.

Revision History

Version	Issue Date	Revisions Content
<u>Rev. 01</u>	<u>Jun. 17, 2016</u>	<u>Initial Issue</u>
<u>Rev. 02</u>	<u>Jun. 20, 2016</u>	<u>The version of KDB 248227 D01 was updated to the current version</u> <u>The maximum measurement SAR and maximum report SAR values in table 3.3.1 were revised</u> <u>The description about Bluetooth Low Energy was deleted</u>

TABLE OF CONTENTS

- 1 GENERAL INFORMATION.....4
 - 1.1 Identification of the Testing Laboratory4
 - 1.2 Identification of the Responsible Testing Location4
 - 1.3 Test Environment Condition4
 - 1.4 Announce5
- 2 PRODUCT INFORMATION6
 - 2.1 Applicant6
 - 2.2 Manufacturer6
 - 2.3 Factory Information.....6
 - 2.4 General Description for Equipment under Test (EUT).....6
 - 2.5 Ancillary Equipment.....7
 - 2.6 Technical Information8
- 3 SUMMARY OF TEST RESULT9
 - 3.1 Test Standards9
 - 3.2 Device Category and SAR Limit10
 - 3.3 Test Result Summary12
 - 3.4 Test Uncertainty13
- 4 MEASUREMENT SYSTEM14
 - 4.1 Specific Absorption Rate (SAR) Definition14
 - 4.2 DASY SAR System15
- 5 SYSTEM VERIFICATION23
 - 5.1 Purpose of System Check23
 - 5.2 System Check Setup23

6	TEST POSITION CONFIGURATIONS	24
6.1	Head Exposure Conditions	24
6.2	Body-worn Position Conditions	26
6.3	Hotspot Mode Exposure Position Conditions	27
7	MEASUREMENT PROCEDURE	28
7.1	Measurement Process Diagram	28
7.2	SAR Scan General Requirement	29
7.3	Measurement Procedure	30
7.4	Area & Zoom Scan Procedure	30
8	CONDUCTED RF OUPUT POWER	31
8.1	WIFI.....	31
8.2	Bluetooth	31
9	TEST EXCLUSION CONSIDERATION	33
9.1	SAR Test Exclusion Consideration Table	34
9.2	10g Extremity Exposure Consideration	36
10	TEST RESULT	37
10.1	2.4G WIFI.....	37
11	SAR Measurement Variability	38
12	SIMULTANEOUS TRANSMISSION.....	39
13	TEST EQUIPMENTS LIST	40
ANNEX A	SIMULATING LIQUID VERIFICATION RESULT	41
ANNEX B	SYSTEM CHECK RESULT	42
ANNEX C	TEST DATA.....	44
ANNEX D	EUT EXTERNAL PHOTOS	47
ANNEX E	SAR TEST SETUP PHOTOS	47
ANNEX F	CALIBRATION REPORT	48
F.1	E-Field Probe	48
F.2	Data Acquisition Electronics	59
F.3	Dual Logo-CTTL-SPEAG-certificates.....	62
F.4	Dipole Performance Measurement Report.....	63
F.5	2450MHz Dipole	95

1 GENERAL INFORMATION

1.1 Identification of the Testing Laboratory

Company Name	Shenzhen BALUN Technology Co.,Ltd.
Address	Block B, 1st FL, Baisha Science and Technology Park, Shahe Xi Road, Nanshan District, Shenzhen, Guangdong Province,P. R. China
Phone Number	+86 755 6685 0100
Fax Number	+86 755 6182 4271

1.2 Identification of the Responsible Testing Location

Test Location	Shenzhen BALUN Technology Co.,Ltd.
Address	Block B, 1st FL, Baisha Science and Technology Park, Shahe Xi Road, Nanshan District, Shenzhen, Guangdong Province,P. R. China
Accreditation Certificate	<p>The laboratory has been listed by Industry Canada to perform electromagnetic emission measurements. The recognition numbers of test site are 11524A-1.</p> <p>The laboratory has been listed by US Federal Communications Commission to perform electromagnetic emission measurements. The recognition numbers of test site are 832625.</p> <p>The laboratory is a testing organization accredited by China National Accreditation Service for Conformity Assessment (CNAS) according to ISO/IEC 17025. The accreditation certificate number is L6791.</p>
Description	All measurement facilities used to collect the measurement data are located at Block B, FL 1, Baisha Science and Technology Park, Shahe Xi Road, Nanshan District, Shenzhen, Guangdong Province, P. R. China 518055

1.3 Test Environment Condition

Ambient Temperature	21 to 23°C
Ambient Relative Humidity	34 to 45%
Ambient Pressure	100 to 102 KPa

1.4 Announce

- (1) The test report reference to the report template version v2.2.
- (2) The test report is invalid if not marked with the signatures of the persons responsible for preparing and approving the test report.
- (3) The test report is invalid if there is any evidence and/or falsification.
- (4) The results documented in this report apply only to the tested sample, under the conditions and modes of operation as described herein.
- (5) This document may not be altered or revised in any way unless done so by BALUN and all revisions are duly noted in the revisions section.
- (6) Content of the test report, in part or in full, cannot be used for publicity and/or promotional purposes without prior written approval from the laboratory.

2 PRODUCT INFORMATION

2.1 Applicant

Applicant	Winmate Communication INC.
Address	9F, No. 111-6, Shing-De Rd., San-Chung Dist, New Taipei 24158, Taiwan, R.O.C.

2.2 Manufacturer

Manufacturer	Winmate Communication INC.
Address	9F, No. 111-6, Shing-De Rd., San-Chung Dist, New Taipei 24158, Taiwan, R.O.C.

2.3 Factory Information

Factory	Winmate Communication INC.
Address	9F, No. 111-6, Shing-De Rd., San-Chung Dist, New Taipei 24158, Taiwan, R.O.C.

2.4 General Description for Equipment under Test (EUT)

EUT Type	Rugged Tablet PC
Model Name Under Test	M700xxxxxxxxxxx
Series Model Name	MMX-070, FlexCommand-7, M700xxxxxxxxxxx(The "X" can be 0-9, A-Z, a-z, or blank for marketing purpose)
Description of Model Name Differentiation	all models are same with electrical parameters and internal circuit structure, but only differ in model name which for the different marketing sales area
Hardware Version	MK8-200
Software Version	151110
Dimensions (Approx.)	Please refer to "BL-SZ1640251-AW"
Weight (Approx.)	574 g
Network and Wireless connectivity	2.4G WLAN, Bluetooth, GPS

2.5 Ancillary Equipment

Ancillary Equipment 1	Battery	
	Brand Name	Winmate
	Model No.	M700DT4
	Serial No.	N/A
	Capacitance	5300 mAh
	Rated Voltage	3.7 V
	Charge Limit	4.2 V
Ancillary Equipment 2	Charger	
	Brand Name	ADT
	Model No.	6A-182WP05-040
	Rated Input	100-240 V~, 50/60 Hz
	Rated Output	5 V $\overline{\text{---}}$, 3000 mA

2.6 Technical Information

The requirement for the following technical information of the EUT was tested in this report:

Operating Mode	2.4G WLAN, Bluetooth	
Frequency Range	802.11b/g /n(HT20/HT40)	2400~2483.5 MHz
	Bluetooth	2400~2483.5 MHz
Antenna Type	WLAN: PIFA Antenna	
Hotspot Function	Not Support	
Exposure Category	General Population/Uncontrolled exposure	
EUT Stage	Portable Device	
Product	Type	
	<input checked="" type="checkbox"/> Production unit	<input type="checkbox"/> Identical prototype

3 SUMMARY OF TEST RESULT

3.1 Test Standards

No.	Identity	Document Title
1	47 CFR Part 2	Frequency Allocations and Radio Treaty Matters; General Rules and Regulations
2	ANSI/IEEE Std. C95.1-1999	IEEE Standard for Safety Levels with Respect to Human Exposure to Radio Frequency Electromagnetic Fields, 3 kHz to 300 GHz
3	IEEE Std. 1528-2013	Recommended Practice for Determining the Peak Spatial-Average Specific Absorption Rate (SAR) in the Human Head from Wireless Communications Devices: Measurement Techniques
4	FCC KDB 447498 D01 v06	Mobile and Portable Device RF Exposure Procedures and Equipment Authorization Policies
5	FCC KDB 865664 D01 v01r04	SAR Measurement 100 MHz to 6 GHz
6	FCC KDB 865664 D02 v01r02	RF Exposure Reporting
7	FCC KDB 616217 D04 SAR for laptop and tablets v01r02	SAR Evaluation Considerations for Laptop, Notebook, Netbook and Tablet Computers
8	FCC KDB 248227 D01 v02r02	SAR GUIDANCE FOR IEEE 802.11 (Wi-Fi) TRANSMITTERS

3.2 Device Category and SAR Limit

This device belongs to portable device category because its radiating structure is allowed to be used within 20 centimeters of the body of the user.

Limit for General Population/Uncontrolled exposure should be applied for this device, it is 1.6 W/kg as averaged over any 1 gram of tissue.

Table of Exposure Limits:

Body Position	SAR Value (W/Kg)	
	General Population/ Uncontrolled Exposure	Occupational/ Controlled Exposure
Whole-Body SAR (averaged over the entire body)	0.08	0.4
Partial-Body SAR (averaged over any 1 gram of tissue)	1.60	8.0
SAR for hands, wrists, feet and ankles (averaged over any 10 grams of tissue)	4.0	20.0

NOTE:

General Population/Uncontrolled Exposure: Locations where there is the exposure of individuals who have no knowledge or control of their exposure. General population/uncontrolled exposure limits are applicable to situations in which the general public may be exposed or in which persons who are exposed as a consequence of their employment may not be made fully aware of the potential for exposure or cannot exercise control over their exposure. Members of the general public would come under this category when exposure is not employment-related; for example, in the case of a wireless transmitter that exposes persons in its vicinity.

Occupational/Controlled Exposure: Locations where there is exposure that may be incurred by persons who are aware of the potential for exposure, In general, occupational/controlled exposure limits are applicable to situations in which persons are exposed as a consequence of their employment, who have been made fully aware of the potential for exposure and can exercise control over their exposure. This exposure category is also applicable when the exposure is of a transient nature due to incidental passage through a location where the exposure levels may be higher than the general population/uncontrolled limits, but the exposed person is fully aware of the potential for exposure and can exercise control over his or her exposure by leaving the area or by some other appropriate means.

3.3 Test Result Summary

3.3.1 Highest SAR (1 g Value)

Band	Mode	Maximum Measurement SAR (W/kg)	Maximum Report SAR (W/kg)	Limit (W/kg)
		Body-worn	Body-worn	
2.4G WLAN	802.11b	0.344	0.351	1.6
Verdict		Pass		

3.3.2 Highest Simultaneous SAR

2.4G WIFI and Bluetooth share the same antenna and cannot transmit simultaneously. So the simultaneous multi-band transmission evaluation is not required in this report.

3.4 Test Uncertainty

According to KDB 865664 D01, when the highest measured 1 g SAR within a frequency band is < 1.5 W/kg, the extensive SAR measurement uncertainty analysis is not required in SAR reports submitted for equipment approval.

The maximum 1 g SAR for the EUT in this report is 0.351 W/kg, which is lower than 1.5 W/kg, so the the extensive SAR measurement uncertainty analysis is not required in this report.

4 MEASUREMENT SYSTEM

4.1 Specific Absorption Rate (SAR) Definition

SAR is related to the rate at which energy is absorbed per unit mass in an object exposed to a radio field. The SAR distribution in a biological body is complicated and is usually carried out by experimental techniques or numerical modeling. The standard recommends limits for two tiers of groups, occupational/controlled and general population/uncontrolled, based on a person's awareness and ability to exercise control over his or her exposure. In general, occupational/controlled exposure limits are higher than the limits for general population/uncontrolled.

The SAR definition is the time derivative (rate) of the incremental energy (dW) absorbed by (dissipated in) an incremental mass (dm) contained in a volume element (dv) of a given density (ρ). The equation description is as below:

$$\text{SAR} = \frac{d}{dt} \left(\frac{dW}{dm} \right) = \frac{d}{dt} \left(\frac{dW}{\rho dv} \right)$$

SAR is expressed in units of Watts per kilogram (W/kg) SAR measurement can be related to the electrical field in the tissue by

$$\text{SAR} = \frac{\sigma E^2}{\rho}$$

Where: σ is the conductivity of the tissue,

ρ is the mass density of the tissue and E is the RMS electrical field strength.

4.2 DASY SAR System

4.2.1 DASY SAR System Diagram

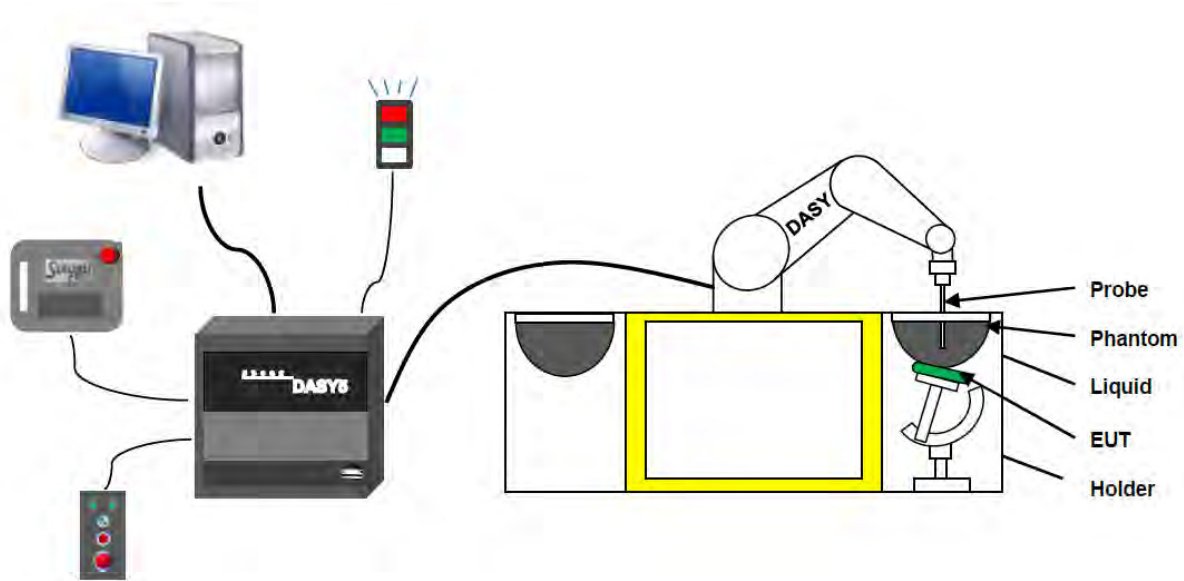

The DASY5 system for performing compliance tests consists of the following items:

1. A standard high precision 6-axis robot (Stäubli RX family) with controller and software. An arm extension for accommodating the data acquisition electronics (DAE).
2. A dosimetric probe, i.e. an isotropic E-field probe optimized and calibrated for usage in tissue simulating liquid. The probe is equipped with an optical surface detector system.
3. A data acquisition electronic (DAE) which performs the signal amplification, signal multiplexing, AD-conversion, offset measurements, mechanical surface detection, collision detection, etc. The unit is battery powered with standard or rechargeable batteries. The signal is optically transmitted to the EOC.
4. A unit to operate the optical surface detector which is connected to the EOC.
5. The Electro-Optical Coupler (EOC) performs the conversion from the optical into a digital electric signal of the DAE. The EOC is connected to the DASY5 measurement server.
6. The DASY5 measurement server, which performs all real-time data evaluation for field measurements and surface detection, controls robot movements and handles safety operation.
7. DASY5 software and SEMCAD data evaluation software.
8. Remote control with teach panel and additional circuitry for robot safety such as warning lamps, etc.
9. The generic twin phantom enabling the testing of left-hand and right-hand usage.
10. The device holder for handheld mobile phones.
11. Tissue simulating liquid mixed according to the given recipes.
12. System validation dipoles allowing to validate the proper functioning of the system.

4.2.2 Robot

The Dasy SAR system uses the high precision robots. Symmetrical design with triangular core Built-in optical fiber for surface detection system For the 6-axis controller system, Built-in shielding against static charges PEEK enclosure material (resistant to organic solvents). The robot series have many features that are important for our application:



- **High precision**
(repeatability ± 0.02 mm)
- **High reliability**
(industrial design)
- **Low maintenance costs**
(virtually maintenance free due to direct drive gears; no belt drives)
- **Jerk-free straight movements**
(brush less synchron motors; no stepper motors)
- **Low ELF interference**
(motor control fields shielded via the closed metallic construction shields)

4.2.3 E-Field Probe

The probe is specially designed and calibrated for use in liquids with high permittivities for the measurements the Specific Dosimetric E-Field Probe EX3DV4-SN:7340 with following specifications is used.

Construction	Symmetrical design with triangular core Built-in optical fiber for surface detection system Built-in shielding against static charges PEEK enclosure material (resistant to organic solvents, e.g., glycolether)
Calibration	ISO/IEC 17025 calibration service available
Frequency	10 MHz to 6 GHz; Linearity: ± 0.2 dB (30 MHz to 6 GHz)
Directivity	± 0.2 dB in HSL (rotation around probe axis) ; ± 0.4 dB in HSL (rotation normal to probe axis)
Dynamic range	5 μ W/g to > 100 mW/g; Linearity: ± 0.2 dB
Dimensions	Overall length: 337 mm (Tip: 9 mm) Tip diameter: 2.5 mm (Body: 10 mm) Distance from probe tip to dipole centers: 1.0 mm
Application	General dosimetry up to 3 GHz Compliance tests of mobile phones Fast automatic scanning in arbitrary phantoms (EX3DV4)



E-Field Probe Calibration Process

Probe calibration is realized, in compliance with CENELEC EN 62209-1/-2 and IEEE 1528 std, with CALISAR, Antennessa proprietary calibration system. The calibration is performed with the EN 62209-1/2 annexe technique using reference guide at the five frequencies.

4.2.4 Data Acquisition Electronics

The data acquisition electronics (DAE) consist of a highly sensitive electrometer-grade preamplifier with auto-zeroing, a channel and gain-switching multiplexer, a fast 16 bit AD-converte and a command decoder with a control logic unit. Transmission to the measurement server is accomplished through an optical downlink for data and status information, as well as an optical uplink for commands and the clock.



- Input Impedance: 200M Ω
- The Inputs: Symmetrical and Floating
- Commom Mode Rejection: Above 80dB

4.2.5 Phantoms

For the measurements the Specific Anthropomorphic Mannequin (SAM) defined by the IEEE SCC-34/SC2 group is used. The phantom is a polyurethane shell integrated in a wooden table. The thickness of the phantom amounts to 2mm +/- 0.2mm. It enables the dosimetric evaluation of left and right phone usage and includes an additional flat phantom part for the simplified performance check. The phantom set-up includes a cover, which prevents the evaporation of the liquid.



- Left hand
- Right hand
- Flat phantom

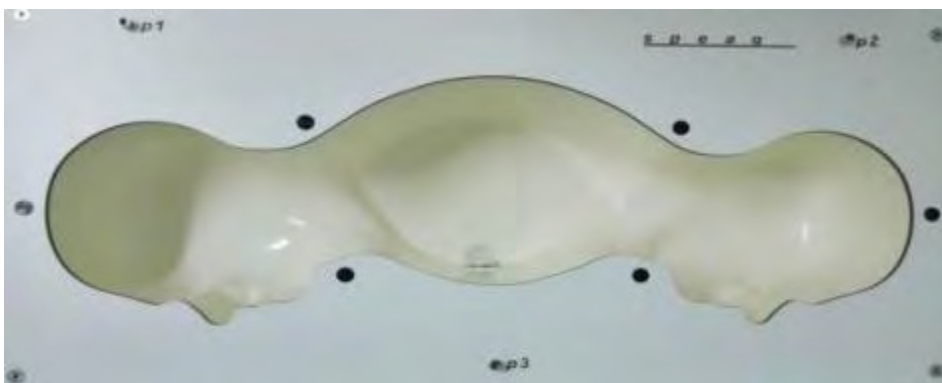
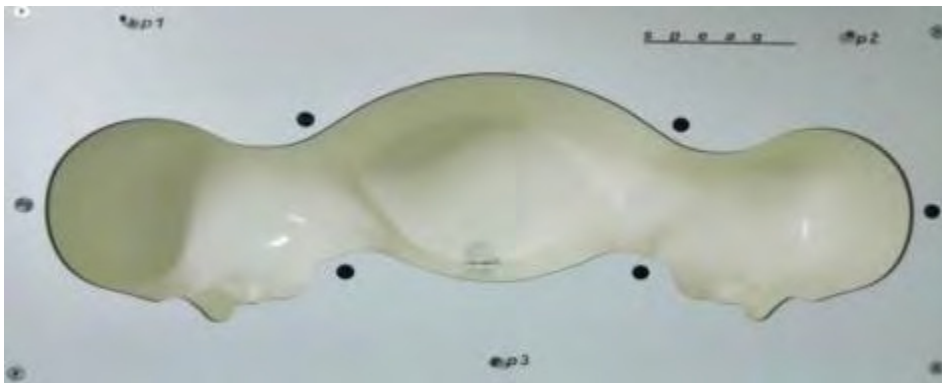

Serial Number	Material	Length	Height
SN 1857 SAM1	Vinylester, glass fiber reinforced	1000	500
SN 1859 SAM2	Vinylester, glass fiber reinforced	1000	500

4.2.6 Device Holder

The DASY5 device holder has two scales for device rotation (with respect to the body axis) and the device inclination (with respect to the line between the ear openings). The plane between the ear openings and the mouth tip has a rotation angle of 65° . The bottom plate contains three pair of bolts for locking the device holder. The device holder positions are adjusted to the standard measurement positions in the three sections. This device holder is used for standard mobile phones or PDA's only. If necessary an additional support of polystyrene material is used. Larger DUT's (e.g. notebooks) cannot be tested using this device holder. Instead a support of bigger polystyrene cubes and thin polystyrene plates is used to position the DUT in all relevant positions to find and measure spots with maximum SAR values. Therefore those devices are normally only tested at the flat part of the SAM.



The positioning system allows obtaining cheek and tilting position with a very good accuracy. Incompliance with CENELEC, the tilt angle uncertainty is lower than 1° .

4.2.7 Simulating Liquid

For SAR measurement of the field distribution inside the phantom, the phantom must be filled with homogeneous tissue simulating liquid to a depth of at least 15 cm. For head SAR testing, the liquid height from the ear reference point (ERP) of the phantom to the liquid top surface is larger than 15 cm. For body SAR testing, the liquid height from the center of the flat phantom to the liquid top surface is larger than 15 cm. The nominal dielectric values of the tissue simulating liquids in the phantom and the tolerance of 5%.

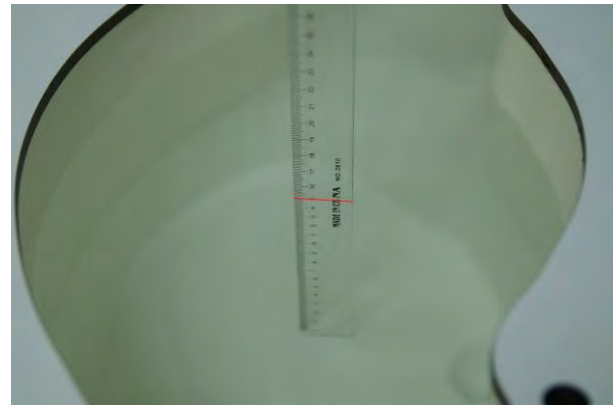
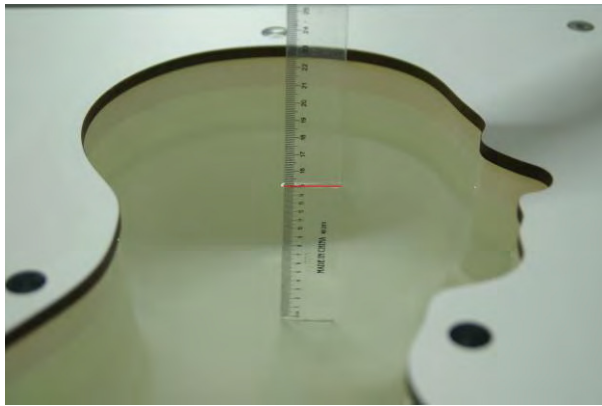

The following table gives the recipes for tissue simulating liquid and the theoretical Conductivity/Permittivity.

Head (Reference IEEE1528)								
Frequency (MHz)	Water (%)	Sugar (%)	Cellulose (%)	Salt (%)	Preventol (%)	DGBE (%)	Conductivity σ (S/m)	Permittivity ϵ
750	41.1	57.0	0.2	1.4	0.2	0	0.89	41.9
835	40.3	57.9	0.2	1.4	0.2	0	0.90	41.5
900	40.3	57.9	0.2	1.4	0.2	0	0.97	41.5
1800, 1900, 2000	55.2	0	0	0.3	0	44.5	1.4	40.0
2450	55.0	0	0	0.1	0	44.9	1.80	39.2
2600	54.9	0	0	0.1	0	45.0	1.96	39.0
Frequency (MHz)	Water (%)	Hexyl Carbitol (%)			Triton X-100 (%)		Conductivity σ (S/m)	Permittivity ϵ
5200	62.52	17.24			17.24		4.66	36.0
5800	62.52	17.24			17.24		5.27	35.3
Body (From instrument manufacturer)								
Frequency (MHz)	Water (%)	Sugar (%)	Cellulose (%)	Salt (%)	Preventol (%)	DGBE (%)	Conductivity σ (S/m)	Permittivity ϵ
750	51.7	47.2	0	0.9	0.1	0	0.96	55.5
835	50.8	48.2	0	0.9	0.1	0	0.97	55.2
900	50.8	48.2	0	0.9	0.1	0	1.05	55.0
1800, 1900, 2000	70.2	0	0	0.4	0	29.4	1.52	53.3
2450	68.6	0	0	0.1	0	31.3	1.95	52.7
2600	68.2	0	0	0.1	0	31.7	2.16	52.5

Frequency(MHz)	Water	DGBE (%)	Salt (%)	Conductivity σ (S/m)	Permittivity ϵ
5200	78.60	21.40	/	5.54	47.86
5800	78.50	21.40	0.1	6.0	48.20

5 SYSTEM VERIFICATION

5.1 Purpose of System Check

The system performance check verifies that the system operates within its specifications. System and operator errors can be detected and corrected. It is recommended that the system performance check be performed prior to any usage of the system in order to guarantee reproducible results. The system performance check uses normal SAR measurements in a simplified setup with a well characterized source. This setup was selected to give a high sensitivity to all parameters that might fail or vary over time. The system check does not intend to replace the calibration of the components, but indicates situations where the system uncertainty is exceeded due to drift or failure.

5.2 System Check Setup

In the simplified setup for system evaluation, the EUT is replaced by a calibrated dipole and the power source is replaced by a continuous wave that comes from a signal generator. The calibrated dipole must be placed beneath the flat phantom section of the SAM twin phantom with the correct distance holder. The distance holder should touch the phantom surface with a light pressure at the reference marking and be oriented parallel to the long side of the phantom. The equipment setup is shown below:

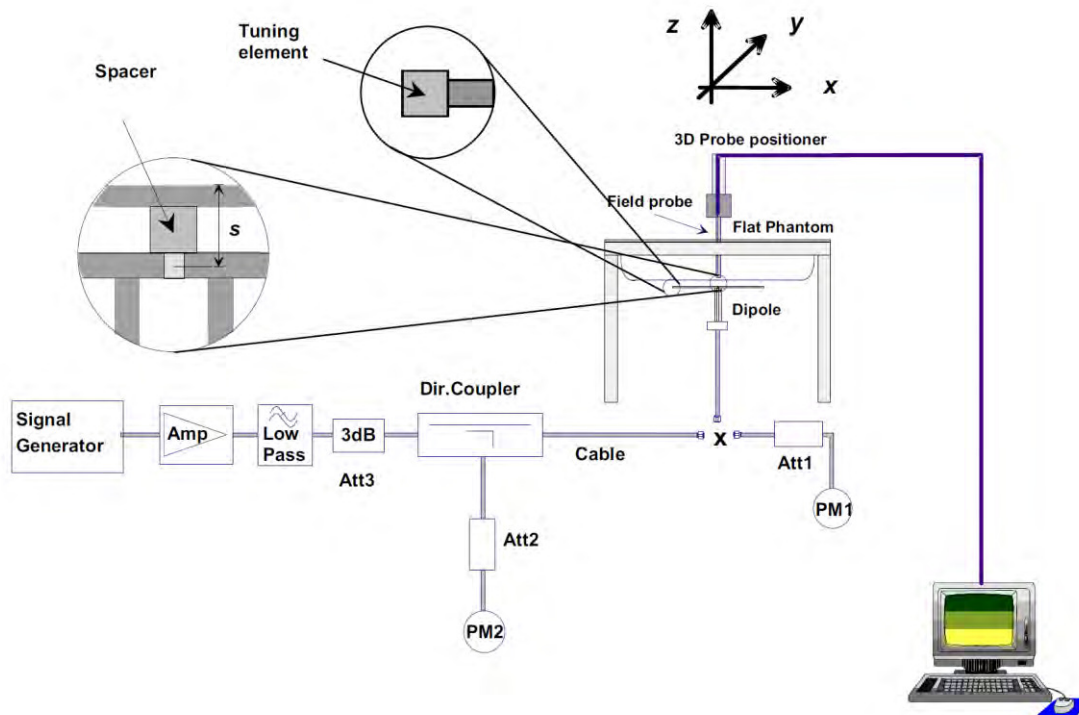

6 TEST POSITION CONFIGURATIONS

According to KDB 648474 D04 Handset, handsets are tested for SAR compliance in head, body-worn accessory and other use configurations described in the following subsections.

6.1 Head Exposure Conditions

Head exposure is limited to next to the ear voice mode operations. Head SAR compliance is tested according to the test positions defined in IEEE Std 1528-2013 using the SAM phantom illustrated as below.

6.1.1 Two Imaginary Lines on the Handset

- The vertical centerline passes through two points on the front side of the handset - the midpoint of the width w_t of the handset at the level of the acoustic output, and the midpoint of the width w_b of the bottom of the handset.
- The horizontal line is perpendicular to the vertical centerline and passes through the center of the acoustic output. The horizontal line is also tangential to the face of the handset at point A.
- The two lines intersect at point A. Note that for many handsets, point A coincides with the center of the acoustic output; however, the acoustic output may be located elsewhere on the horizontal line. Also note that the vertical centerline is not necessarily parallel to the front face of the handset, especially for clamshell handsets, handsets with flip covers, and other irregularly shaped handsets.

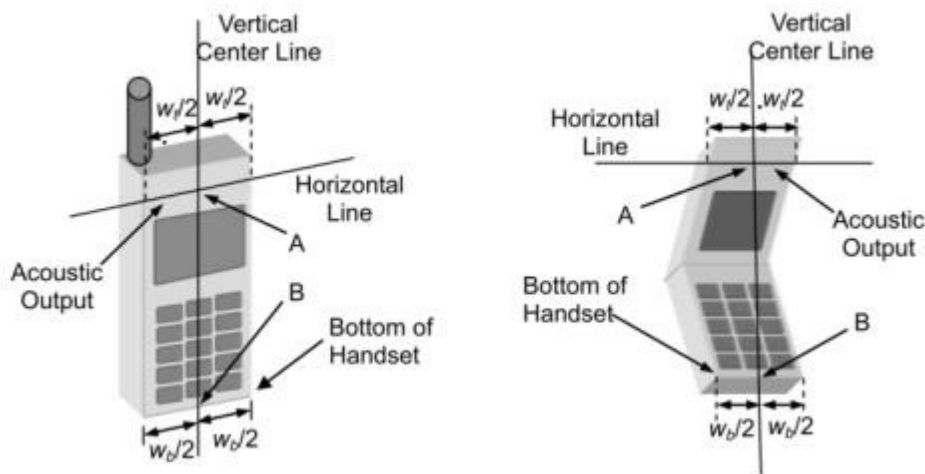

6.1.2 Cheek Position

- To position the device with the vertical center line of the body of the device and the horizontal line crossing the center piece in a plane parallel to the sagittal plane of the phantom. While maintaining the device in this plane, align the vertical center line with the reference plane containing the three ear and mouth reference point (M: Mouth, RE: Right Ear, and LE: Left Ear) and align the center of the ear piece with the line RE-LE.
- To move the device towards the phantom with the ear piece aligned with the line LE-RE until the phone touched the ear. While maintaining the device in the reference plane and maintaining the phone contact with the ear, move the bottom of the phone until any point on the front side is in contact with the cheek of the phantom or until contact with the ear is lost.

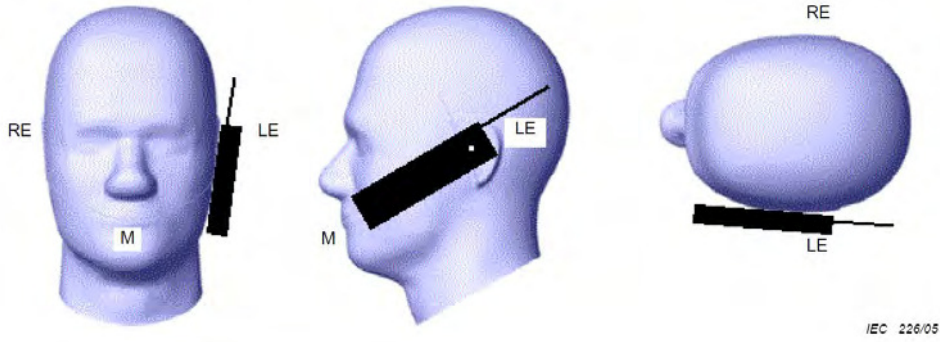

6.1.3 Tilted Position

- (a) To position the device in the “cheek” position described above.
- (b) While maintaining the device the reference plane described above and pivoting against the ear, moves it outward away from the mouth by an angle of 15 degrees or until contact with the ear is lost.



6.2 Body-worn Position Conditions

Body-worn accessory exposure is typically related to voice mode operations when handsets are carried in body-worn accessories. The body-worn accessory procedures in EN 62209-2 are used to test for body-worn accessory SAR compliance, without a headset connected to it. This enables the test results for such configuration to be compatible with that required for hotspot mode when the body-worn accessory test separation distance is greater than or equal to that required for hotspot mode. When the reported SAR for a body-worn accessory.

Body-worn accessories that do not contain metallic or conductive components may be tested according to worst-case exposure configurations, typically according to the smallest test separation distance required for the group of body-worn accessories with similar operating and exposure characteristics. All body-worn accessories containing metallic components are tested in conjunction with the host device.

Body-worn accessory SAR compliance is based on a single minimum test separation distance for all wireless and operating modes applicable to each body-worn accessory used by the host, and according to the relevant voice and/or data mode transmissions and operations. If a body-worn accessory supports voice only operations in its normal and expected use conditions, testing of data mode for body-worn compliance is not required. A conservative minimum test separation distance for supporting off-the-shelf body-worn accessories that may be acquired by users of consumer handsets is used to test for body-worn accessory SAR compliance. This distance is determined by the handset manufacturer, according to the requirements of Supplement C 01-01. Devices that are designed to operate on the body of users using lanyards and straps, or without requiring additional body-worn accessories, will be tested using a conservative minimum test separation distance ≤ 5 mm to support compliance.

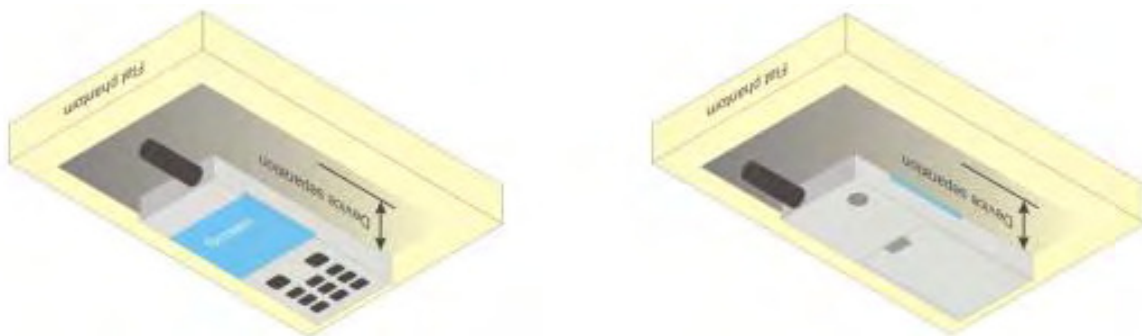

6.3 Hotspot Mode Exposure Position Conditions

For handsets that support hotspot mode operations, with wireless router capabilities and various web browsing functions, the relevant hand and body exposure conditions are tested according to the hotspot SAR procedures in KDB 941225. A test separation distance of 10 mm is required between the phantom and all surfaces and edges with a transmitting antenna located within 25 mm from that surface or edge. When the form factor of a handset is smaller than 9 cm x 5 cm, a test separation distance of 5 mm (instead of 10 mm) is required for testing hotspot mode. When the separation distance required for body-worn accessory testing is larger than or equal to that tested for hotspot mode, in the same wireless mode and for the same surface of the phone, the hotspot mode SAR data may be used to support body-worn accessory SAR compliance for that particular configuration (surface).

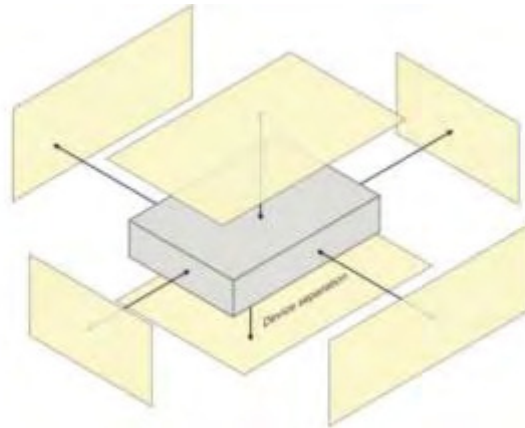

7 MEASUREMENT PROCEDURE

7.1 Measurement Process Diagram

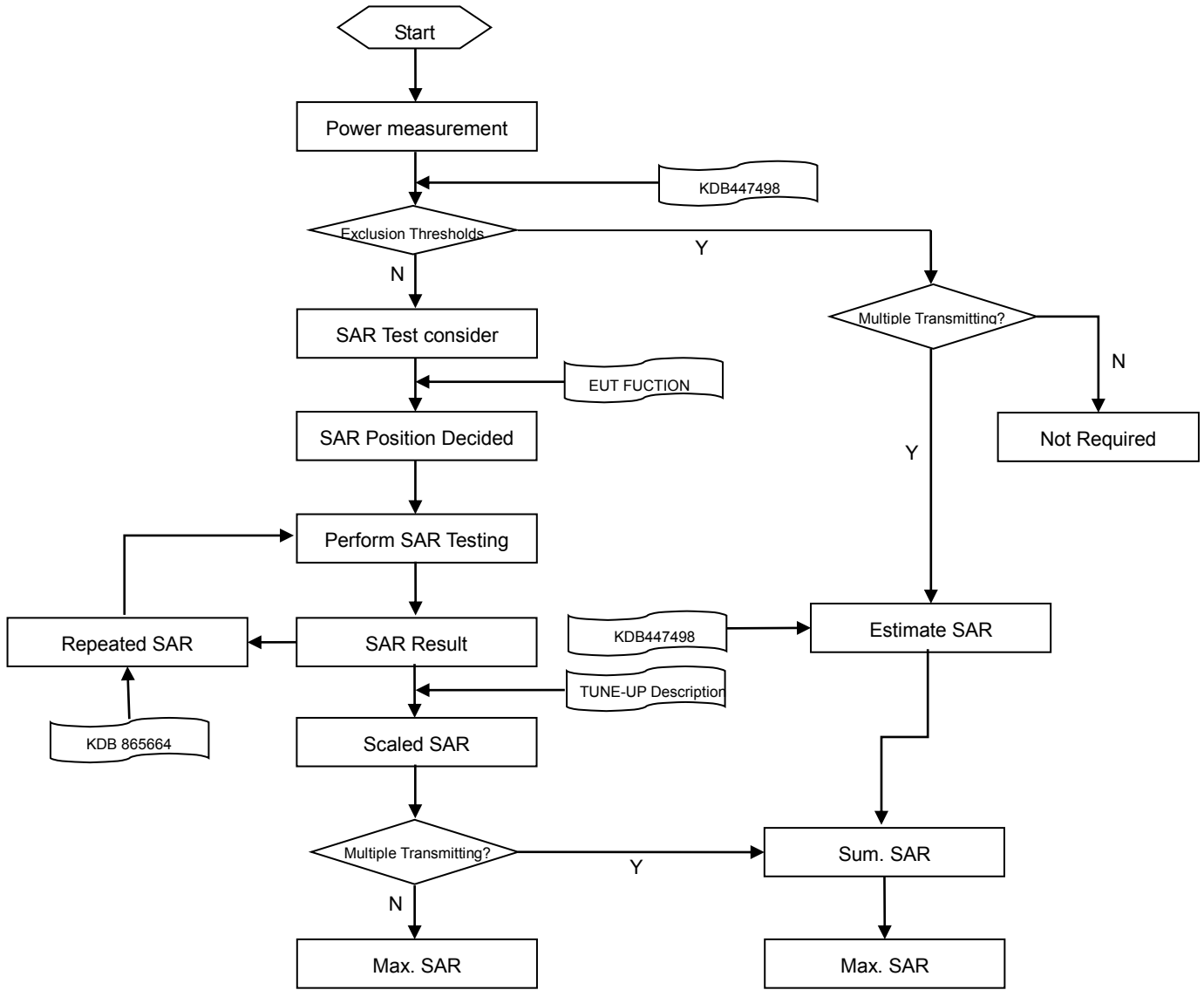

7.2 SAR Scan General Requirement

Probe boundary effect error compensation is required for measurements with the probe tip closer than half a probe tip diameter to the phantom surface. Both the probe tip diameter and sensor offset distance must satisfy measurement protocols; to ensure probe boundary effect errors are minimized and the higher fields closest to the phantom surface can be correctly measured and extrapolated to the phantom surface for computing 1 g SAR. Tolerances of the post-processing algorithms must be verified by the test laboratory for the scan resolutions used in the SAR measurements, according to the reference distribution functions specified in IEEE Std 1528-2013.

			≤3GHz	>3GHz
Maximum distance from closest measurement point (geometric center of probe sensors) to phantom surface			5±1 mm	$\frac{1}{2} \cdot \delta \cdot \ln(2) \pm 0.5$ mm
Maximum probe angle from probe axis to phantom surface normal at the measurement location			30°±1°	20°±1°
Maximum area scan spatial resolution: Δx Area , Δy Area			≤ 2 GHz: ≤ 15 mm 2 – 3 GHz: ≤ 12 mm	3–4 GHz: ≤ 12 mm 4 – 6 GHz: ≤ 10 mm
			When the x or y dimension of the test device, in the measurement plane orientation, is smaller than the above, the measurement resolution must be ≤ the corresponding x or y dimension of the test device with at least one measurement point on the test device.	
Maximum zoom scan spatial resolution: Δx Zoom , Δy Zoom			≤ 2 GHz: ≤ 8 mm 2 – 3 GHz: ≤ 5 mm*	3–4 GHz: ≤ 5 mm* 4 – 6 GHz: ≤ 4 mm*
Maximum zoom scan spatial resolution, normal to phantom surface	uniform grid: Δz Zoom (n)		≤ 5 mm	3–4 GHz: ≤ 4 mm
				4–5 GHz: ≤ 3 mm
				5–6 GHz: ≤ 2 mm
	graded grid	Δz Zoom (1): between 1st two points closest to phantom surface	≤ 4 mm	3–4 GHz: ≤ 3 mm
Δz Zoom (n>1): between subsequent points		4–5 GHz: ≤ 2.5 mm		
			5–6 GHz: ≤ 2 mm	
			≤ 1.5· Δz Zoom (n-1)	
Minimum zoom scan volume	x, y, z		≥30 mm	3–4 GHz: ≥ 28 mm
				4–5 GHz: ≥ 25 mm
				5–6 GHz: ≥ 22 mm
Note: 1. δ is the penetration depth of a plane-wave at normal incidence to the tissue medium; see draft standard IEEE P1528-2011 for details. 2. * When zoom scan is required and the reported SAR from the area scan based 1 g SAR estimation procedures of KDB 447498 is ≤ 1.4 W/kg, ≤ 8 mm, ≤ 7 mm and ≤ 5 mm zoom scan resolution may be applied, respectively, for 2 GHz to 3GHz, 3 GHz to 4 GHz and 4 GHz to 6 GHz.				

7.3 Measurement Procedure

The following steps are used for each test position

- a. Establish a call with the maximum output power with a base station simulator. The connection between the mobile and the base station simulator is established via air interface
- b. Measurement of the local E-field value at a fixed location. This value serves as a reference value for calculating a possible power drift.
- c. Measurement of the SAR distribution with a grid of 8 to 16mm * 8 to 16 mm and a constant distance to the inner surface of the phantom. Since the sensors cannot directly measure at the inner phantom surface, the values between the sensors and the inner phantom surface are extrapolated. With these values the area of the maximum SAR is calculated by an interpolation scheme.
- d. Around this point, a cube of 30 * 30 * 30 mm or 32 * 32 * 32 mm is assessed by measuring 5 or 8 * 5 or 8*4 or 5 mm. With these data, the peak spatial-average SAR value can be calculated.

7.4 Area & Zoom Scan Procedure

First Area Scan is used to locate the approximate location(s) of the local peak SAR value(s). The measurement grid within an Area Scan is defined by the grid extent, grid step size and grid offset. Next, in order to determine the EM field distribution in a three-dimensional spatial extension, Zoom Scan is required. The Zoom Scan is performed around the highest E-field value to determine the averaged SAR-distribution over 10 g. Area scan and zoom scan resolution setting follows KDB 865664 quoted below.

When the 1 g SAR of the highest peak is within 2 dB of the SAR limit, additional zoom scans are required for other peaks within 2 dB of the highest peak that have not been included in any zoom scan to ensure there is no increase in SAR.

8 CONDUCTED RF OUTPUT POWER

8.1 WIFI

8.1.1 2.4G WIFI

Band (GHz)	Mode	Channel	Freq. (MHz)	Avg. Power (dBm)	SAR Test Require.
2.4 (2.4~2.4835)	802.11b	1	2412	14.71	Yes
		6	2437	14.55	No
		11	2462	13.86	No
	802.11g	1	2412	14.59	No
		6	2437	14.33	No
		11	2462	14.01	No
	802.11n(HT20)	1	2412	14.63	No
		6	2437	14.25	No
		11	2462	14.18	No
	802.11n(HT40)	3	2422	13.44	No
		6	2437	14.18	No
		9	2452	13.99	No

8.2 Bluetooth

Mode	GFSK			$\pi/4$ -DQPSK		
Channel	0	39	78	0	39	78
Frequency (MHz)	2402	2441	2480	2402	2441	2480
Avg. Power (dBm)	5.26	4.43	3.88	1.91	1.23	0.72
Mode	8-DPSK			N/A		
Channel	0	39	78	N/A		
Frequency (MHz)	2402	2441	2480			
Avg. Power (dBm)	1.91	1.23	0.71			

Rated RF power output:

Band (GHz)	Mode	Channel	Range(dBm)
2.4 (2.4~2.4835)	IEEE 802.11b	1	14.60-14.80
		6	14.50-14.60
		11	13.80-14.00
	IEEE 802.11g	1	14.50-14.70
		6	14.30-14.40
		11	13.90-14.10
	IEEE 802.11n(HT20)	1	14.60-14.70
		6	14.20-14.30
		11	14.10-14.30
	IEEE 802.11n(HT40)	3	13.40-13.50
		6	14.10-14.25
		9	13.90-14.10

Band (GHz)	Mode	Modulation	Range(dBm)
Bluetooth	BR/EDR	GFSK	3.80-5.30
		$\pi/4$ -DQPSK	1.65-2.00
		8-DPSK	0.60-2.00

9 TEST EXCLUSION CONSIDERATION

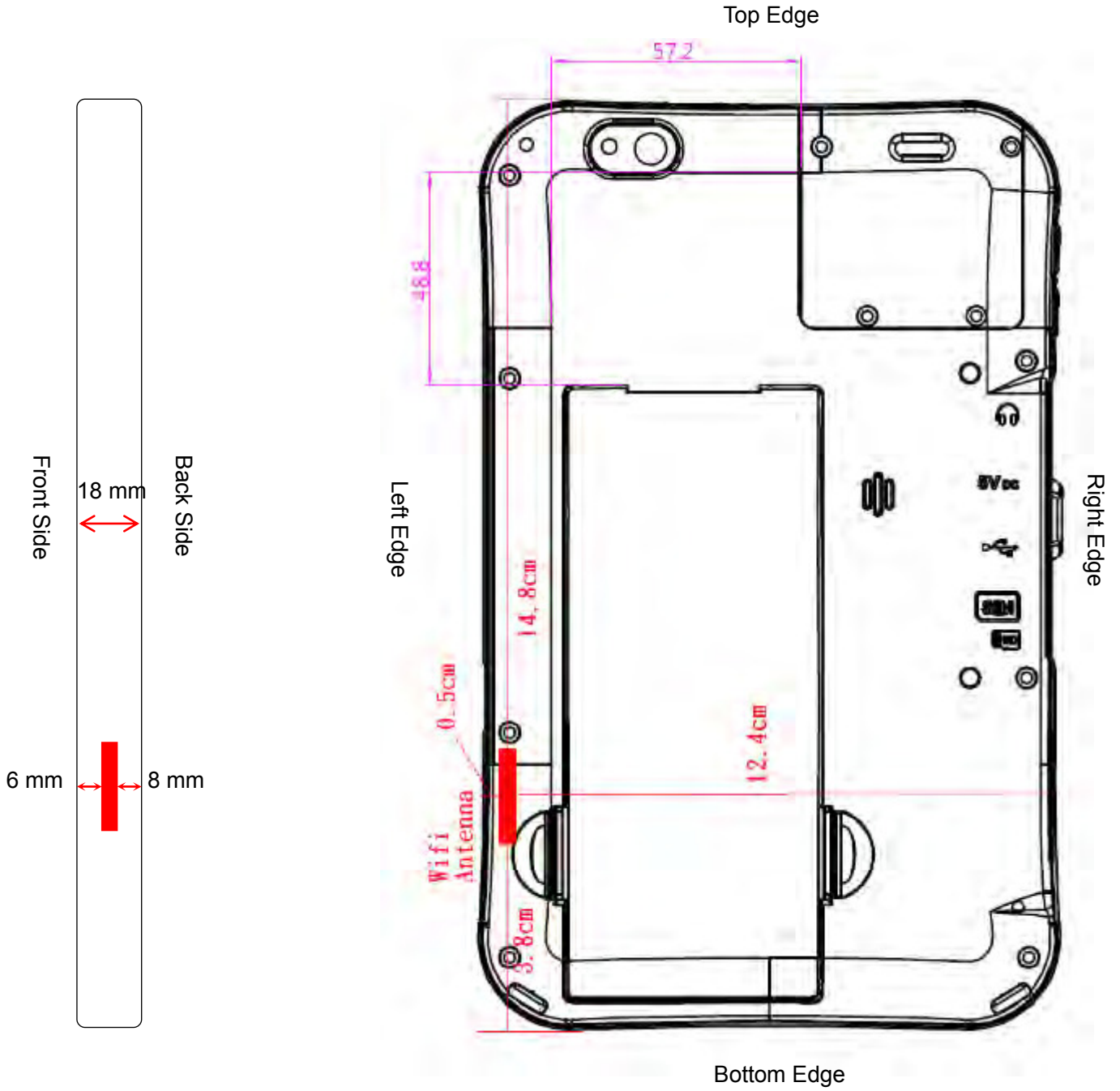

9.1 SAR Test Exclusion Consideration Table

According with FCC KDB 447498 D01, Appendix A, <SAR Test Exclusion Thresholds for 100 MHz – 6 GHz and ≤ 50 mm> Table, this Device SAR test configurations consider as following :

Band	Mode	Max. Avg. Power		Test Position Configurations					
		dBm	mW	Back	Front	Left Edge	Right Edge	Top Edge	Bottom Edge
WLAN 2.4 G	Distance to User			8mm	6mm	5mm	124mm	148mm	38mm
	802.11b	14.80	30.20	Yes	No	Yes	No	No	Yes
	802.11g	14.70	29.51	No	No	No	No	No	No
	802.11n(HT20)	14.70	29.51	No	No	No	No	No	No
	802.11n(HT40)	14.25	26.61	No	No	No	No	No	No
Bluetooth	Distance to User			8mm	6mm	5mm	124mm	148mm	38mm
	BR/EDR	5.30	3.39	No	No	No	No	No	No

Note:

- Maximum power is the source-based time-average power and represents the maximum RF output power including tune-up tolerance among production units
- Per KDB 447498 D01, for larger devices, the test separation distance of adjacent edge configuration is determined by the closest separation between the antenna and the user.
- Per KDB 447498 D01, standalone SAR test exclusion threshold is applied; If the distance of the antenna to the user is < 5mm, 5mm is used to determine SAR exclusion threshold
- Per KDB 447498 D01, the 1-g and 10-g SAR test exclusion thresholds for 100 MHz to 6 GHz at test separation distances ≤ 50 mm are determined by:

$$[(\text{max. power of channel, including tune-up tolerance, mW}) / (\text{min. test separation distance, mm})] \cdot [\sqrt{f(\text{GHz})}] \leq 3.0$$
 for 1-g SAR and ≤ 7.5 for 10-g extremity SAR
 - f(GHz) is the RF channel transmit frequency in GHz
 - Power and distance are rounded to the nearest mW and mm before calculation
 - The result is rounded to one decimal place for comparison
 - For < 50 mm distance, we just calculate mW of the exclusion threshold value (3.0) to do compare.
 This formula is $[3.0] / [\sqrt{f(\text{GHz})}] \cdot [(\text{min. test separation distance, mm})] = \text{exclusion threshold of mW}$.
- Per KDB 447498 D01, at 100 MHz to 6 GHz and for test separation distances > 50 mm, the SAR test exclusion threshold is determined according to the following
 - [Threshold at 50 mm in step 1) + (test separation distance - 50 mm) · (f(MHz)/150)] mW, at 100 MHz to 1500 MHz
 - [Threshold at 50 mm in step 1) + (test separation distance - 50 mm) · 10] mW at > 1500 MHz and ≤ 6 GHz
- Per KDB 248227 D01, choose the highest output power channel to test SAR and determine further SAR exclusion. For each frequency band, testing at higher data rates and higher order modulations is not required when the maximum average output power for each of these configurations is less than 1/4dB higher than those measured at the lowest data rate
- Per KDB 248227 D01 SAR is not required for the following 2.4 GHz OFDM conditions.
 - When KDB Publication 447498 D01 SAR test exclusion applies to the OFDM configuration.
 - When the highest reported SAR for DSSS is adjusted by the ratio of OFDM to DSSS specified maximum output power and the adjusted SAR is ≤ 1.2 W/kg.
- Per KDB 248227 D01 SAR is not required for the following U-NII-1 and U-NII-2A bands conditions.
 - When the same maximum output power is specified for both bands, begin SAR measurement in U-NII-2A band by applying the OFDM SAR requirements. If the highest reported SAR for a test configuration is ≤

1.2 W/kg, SAR is not required for U-NII-1 band for that configuration (802.11 mode and exposure condition); otherwise, each band is tested independently for SAR.

- b. When different maximum output power is specified for the bands, begin SAR measurement in the band with higher specified maximum output power. The highest reported SAR for the tested configuration is adjusted by the ratio of lower to higher specified maximum output power for the two bands. When the adjusted SAR is ≤ 1.2 W/kg, SAR is not required for the band with lower maximum output power in that test configuration; otherwise, each band is tested independently for SAR.

9.2 10g Extremity Exposure Consideration

According with FCC KDB 648474 D04, for smart phones with a display diagonal dimension > 15.0 cm or an overall diagonal dimension > 16.0 cm that provide similar mobile web access and multimedia support found in mini-tablets or UMPC mini-tablets that support voice calls next to the ear, unless it is confirmed otherwise through KDB inquiries, the following phablet procedures should be applied to evaluate SAR compliance for each applicable wireless modes and frequency band. Devices marketed as phablets, regardless of form factors and operating characteristics must be tested as a phablet to determine SAR compliance;

The UMPC mini-tablet procedures must also be applied to test the SAR of all surfaces and edges with an antenna located at ≤ 25 mm from that surface or edge, in direct contact with a flat phantom, for 10-g extremity SAR according to the body-equivalent tissue dielectric parameters in KDB 865664 to address interactive hand use exposure conditions. The UMPC mini-tablet 1-g SAR at 5 mm is not required. When hotspot mode applies, 10-g extremity SAR is required only for the surfaces and edges with hotspot mode 1-g reported SAR > 1.2 W/kg.

Conclusion:

The maximum 1g SAR for EUT is 0.351 W/Kg, which is less than 1.2W/Kg, 10-g extremity SAR is not required.

10 TEST RESULT

10.1 2.4G WIFI

Mode	Position	Dist. (mm)	Ch.	Freq. (MHz)	Power Drift (%)	1 g Meas. SAR (W/Kg)	Meas. Power (dBm)	Max. tune-up Power(dBm)	Scaling Factor	1 g Scaled SAR (W/Kg)	Meas. No.
Battery 1 (4000 mAh)											
802.11 b	Back Side	0	1	2412	4.23	0.344	14.71	14.80	1.02	0.351	1#
	Left Edge	0	1	2412	1.16	0.176	14.71	14.80	1.02	0.180	2#
	Bottom Edge	0	1	2412	3.75	0.064	14.71	14.80	1.02	0.065	3#

Note :

1. Refer to ANNEX C for the detailed test data for each test configuration.
2. $Power\ Drift(\%) = 10^{[Meas\ Power\ Drift(dB)/10]} - 1$.
3. According to KDB 616217 D04, SAR evaluation for the front of the surface display screens are not necessary.
4. According to KDB 248227 D01
 - a. When the reported SAR of the highest measured maximum output power channel for the exposure configuration is $\leq 0.8\ W/kg$, no further SAR testing is required in that exposure configuration.
 - b. When the reported SAR is $> 0.8\ W/kg$, SAR is required for that exposure configuration using the next highest measured output power channel. When any reported SAR is $> 1.2\ W/kg$, SAR is required for the third channel; i.e., all channels require testing.

11 SAR Measurement Variability

According to KDB 865664 D01, SAR measurement variability was assessed for each frequency band, which is determined by the SAR probe calibration point and tissue-equivalent medium used for the device measurements. When both head and body tissue-equivalent media are required for SAR measurements in a frequency band, the variability measurement procedures should be applied to the tissue medium with the highest measured SAR, using the highest measured SAR configuration for that tissue-equivalent medium. Alternatively, if the highest measured SAR for both head and body tissue-equivalent media are ≤ 1.45 W/kg and the ratio of these highest SAR values, i.e., largest divided by smallest value, is ≤ 1.10 , the highest SAR configuration for either head or body tissue-equivalent medium may be used to perform the repeated measurement. These additional measurements are repeated after the completion of all measurements requiring the same head or body tissue-equivalent medium in a frequency band. The test device should be returned to ambient conditions (normal room temperature) with the battery fully charged before it is re-mounted on the device holder for the repeated measurement(s) to minimize any unexpected variations in the repeated results.

SAR repeated measurement procedure:

1. When the highest measured SAR is < 0.80 W/kg, repeated measurement is not required.
2. When the highest measured SAR is ≥ 0.80 W/kg, repeat that measurement once.
3. If the ratio of largest to smallest SAR for the original and first repeated measurements is > 1.20 , or when the original or repeated measurement is ≥ 1.45 W/kg, perform a second repeated measurement.
4. If the ratio of largest to smallest SAR for the original, first and second repeated measurements is > 1.20 , and the original, first or second repeated measurement is ≥ 1.5 W/kg, perform a third repeated measurement.

SAR Repeated Measurement

The highest measured SAR is 0.344 W/kg, which is less than 0.80 W/kg, repeated measurement is not required.

12 SIMULTANEOUS TRANSMISSION

2.4G WIFI and Bluetooth share the same antenna and cannot transmit simultaneously. So the simultaneous multi-band transmission evaluation is not required in this report.

13 TEST EQUIPMENTS LIST

Description	Manufacturer	Model	Serial No.	Cal. Date	Cal. Due
PC	Dell	N/A	N/A	N/A	N/A
2450MHz Validation Dipole	Speag	D2450V2	SN: 952	2014/11/27	2017/11/26
E-Field Probe	Speag	EX3DV4	SN: 7340	2015/12/10	2016/12/09
Phantom1	Speag	SAM	SN: 1859	N/A	N/A
Phantom2	Speag	SAM	SN: 1857	N/A	N/A
Data acquisition electronics	Speag	DAE4	SN: 1454	2015/12/08	2016/12/07
Signal Generator	R&S	SMBV100A	260592	2015/07/16	2016/07/15
Power Meter	Agilent	E4419B	GB40201833	2015/10/14	2016/10/13
Power Sensor	R&S	NRP-Z21	103971	2015/07/16	2016/07/15
Power Amplifier	SATIMO	6552B	22374	N/A	N/A
Dielectric Probe Kit	SATIMO	SCLMP	SN 25/13 OCPG56	2015/08/17	2016/08/16
Wireless Communication Test Set	R&S	CMW 500	138884	2015/07/16	2016/07/15
Network Analyzer	R&S	ZVL-6	EMY46103472	2015/07/16	2016/07/15
Attenuator	COM-MW	ZA-S1-31	1305003187	N/A	N/A
Directional coupler	AA-MCS	AAMCS-UDC	000272	N/A	N/A

Note: Per KDB 865664 D01 Dipole SAR Validation Verification, BALUN LAB has adopted 3 years calibration intervals. On annual basis, every measurement dipole has been evaluated and is in compliance with the following criteria:

1. There is no physical damage on the dipole;
2. System validation with specific dipole is within 10% of calibrated value;
3. Return-loss is within 20% of calibrated measurement;

ANNEX A SIMULATING LIQUID VERIFICATION RESULT

The dielectric parameters of the liquids were verified prior to the SAR evaluation using an SCLMP Dielectric Probe Kit.

Date	Liquid Type	Freq. (MHz)	Temp. (°C)	Meas. Conductivity (σ) (S/m)	Meas. Permittivity (ϵ)	Target Conductivity (σ) (S/m)	Target Permittivity (ϵ)	Conductivity Tolerance (%)	Permittivity Tolerance (%)
2016.5.05	Body	2450	21.4	2.02	50.71	1.95	52.70	3.59	-3.78

Note: The tolerances limit of Conductivity and Permittivity is $\pm 5\%$.

ANNEX B SYSTEM CHECK RESULT

Comparing to the original SAR value provided by SPEAG, the validation data should be within its specification of 10 % (for 1 g).

Date	Freq. (MHz)	Power (mW)	Measured SAR (W/kg)	Normalized SAR (W/kg)	Dipole SAR (W/kg)	Tolerance (%)	Targeted SAR(W/kg)	Tolerance (%)
2016.5.05	2450	100	4.96	49.60	50.60	-1.98	52.40	-5.34

Note: The tolerance limit of System validation $\pm 10\%$.

System Performance Check Data (2450MHz Body)

Date/Time: 5/5/2016

Communication System Band: CD2450 (2450.0 MHz); Frequency: 2450 MHz; Duty Cycle: 1:1

Medium parameters used: $f = 2450$ MHz; $\sigma = 2.02$ S/m; $\epsilon_r = 50.71$; $\rho = 1000$ kg/m³

Phantom section: Flat Section

Ambient Temperature: 22.3 Liquid Temperature: 21.4

DASY5 Configuration:

- Probe: EX3DV4 - SN7340; ConvF(7.55, 7.55, 7.55); Calibrated: 12/2/2014;
- Sensor-Surface: 4mm (Mechanical Surface Detection)
- Electronics: DAE4 Sn1454; Calibrated: 12/1/2014
- Phantom: SAM (30deg probe tilt) with CRP v5.0 on left 1859; Type: QD000P40CD; Serial: TP:1859
- Measurement SW: DASY52, Version 52.8 (8); SEMCAD X Version 14.6.10 (7331)

Configuration/CW 2450 100mW BODY/Zoom Scan (7x7x7)/Cube 0: Measurement grid: dx=5mm, dy=5mm, dz=5mm

Reference Value = 52.83 V/m; Power Drift = -0.01 dB

Peak SAR (extrapolated) = 10.6 W/kg

SAR(1 g) = 4.96 W/kg; SAR(10 g) = 2.24 W/kg

Maximum value of SAR (measured) = 5.65 W/kg

Configuration/CW 2450 100mW BODY/Area Scan (81x101x1): Interpolated grid: dx=1.000 mm, dy=1.000 mm

Maximum value of SAR (interpolated) = 5.76 W/kg

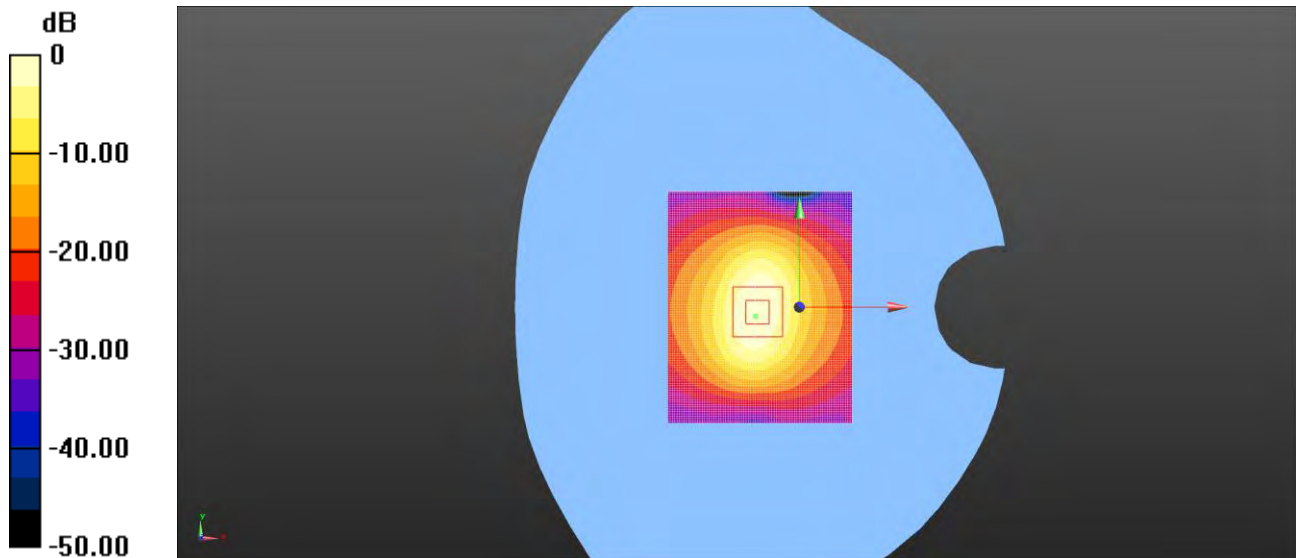

0 dB = 5.76 W/kg = 7.60 dBW/kg

ANNEX C TEST DATA

Meas.1 Body plane with Back side on Low channel in WIFI 802.11b mode

Communication System Band: WLAN(b); Frequency: 2412 MHz; Duty Cycle: 1:1

Medium parameters used: $f = 2412$ MHz; $\sigma = 1.95$ S/m; $\epsilon_r = 51.72$; $\rho = 1000$ kg/m³

Phantom section: Flat Section

Ambient Temperature: 22.3 Liquid Temperature: 21.4

DASY5 Configuration:

- Probe: EX3DV4 - SN7340; ConvF(7.38, 7.38, 7.38); Calibrated: 12/10/2015;
- Sensor-Surface: 4mm (Mechanical Surface Detection)
- Electronics: DAE4 Sn1454; Calibrated: 12/8/2015
- Phantom: SAM (30deg probe tilt) with CRP v5.0 Right 1857; Type: QD000P40CD; Serial: TP1857
- Measurement SW: DASY52, Version 52.8 (8); SEMCAD X Version 14.6.10 (7331)

Configuration/Body plane with Back side on Low channel in WIFI 802.11b mode/Area Scan (71x81x1):

Interpolated grid: $dx=1.200$ mm, $dy=1.200$ mm

Maximum value of SAR (interpolated) = 0.406 W/kg

Configuration/Body plane with Back side on Low channel in WIFI 802.11b mode/Zoom Scan (5x5x7)/Cube 0: Measurement grid: $dx=8$ mm, $dy=8$ mm, $dz=5$ mm

Reference Value = 11.64 V/m; Power Drift = 0.18 dB

Peak SAR (extrapolated) = 0.652 W/kg

SAR(1 g) = 0.344 W/kg; SAR(10 g) = 0.183 W/kg

Maximum value of SAR (measured) = 0.373 W/kg

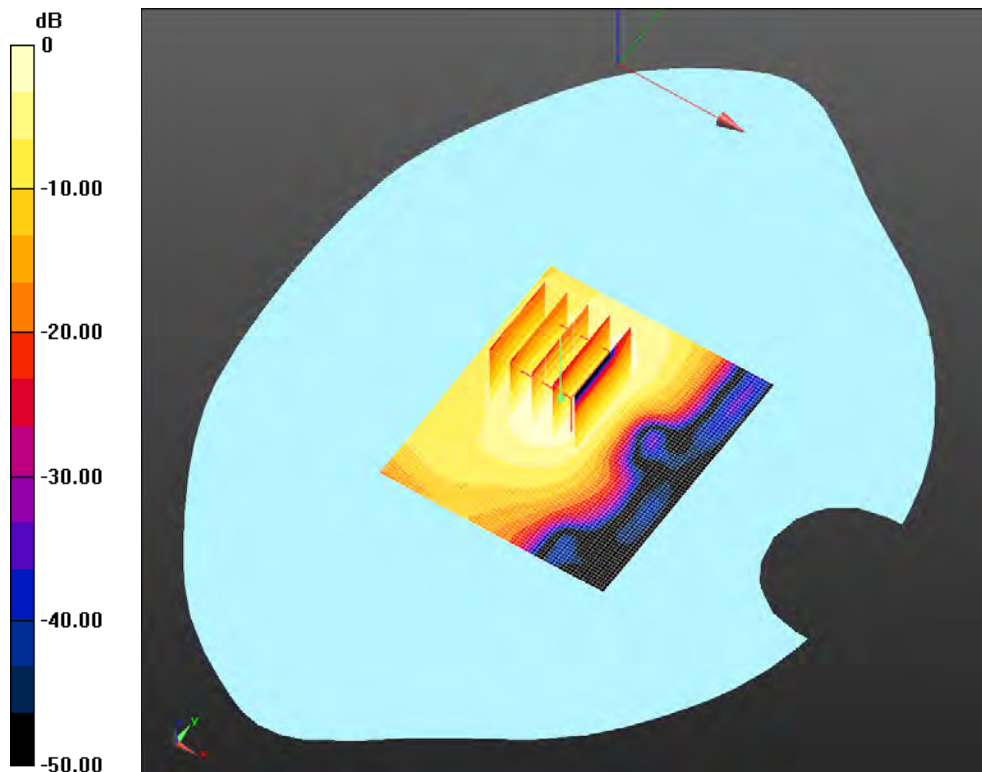

0 dB = 0.406 W/kg = -3.91 dBW/kg

Meas.2 Body plane with Left Edge on Low channel in WIFI 802.11b mode

Date/Time: 5/5/2016

Communication System Band: WLAN(b); Frequency: 2412 MHz; Duty Cycle: 1:1

Medium parameters used: $f = 2412$ MHz; $\sigma = 1.95$ S/m; $\epsilon_r = 51.72$; $\rho = 1000$ kg/m³

Phantom section: Flat Section

Ambient Temperature: 22.3 Liquid Temperature: 21.4

DASY5 Configuration:

- Probe: EX3DV4 - SN7340; ConvF(7.38, 7.38, 7.38); Calibrated: 12/10/2015;
- Sensor-Surface: 4mm (Mechanical Surface Detection)
- Electronics: DAE4 Sn1454; Calibrated: 12/8/2015
- Phantom: SAM (30deg probe tilt) with CRP v5.0 Right 1857; Type: QD000P40CD; Serial: TP1857
- Measurement SW: DASY52, Version 52.8 (8); SEMCAD X Version 14.6.10 (7331)

Configuration/Body plane with Left Edge on Low channel in WIFI 802.11b mode/Area Scan (71x81x1):

Interpolated grid: $dx=1.200$ mm, $dy=1.200$ mm

Maximum value of SAR (interpolated) = 0.207 W/kg

Configuration/Body plane with Left Edge on Low channel in WIFI 802.11b mode/Zoom Scan

(5x5x7)/Cube 0: Measurement grid: $dx=8$ mm, $dy=8$ mm, $dz=5$ mm

Reference Value = 7.458 V/m; Power Drift = 0.05 dB

Peak SAR (extrapolated) = 0.341 W/kg

SAR(1 g) = 0.176 W/kg; SAR(10 g) = 0.084 W/kg

Maximum value of SAR (measured) = 0.198 W/kg

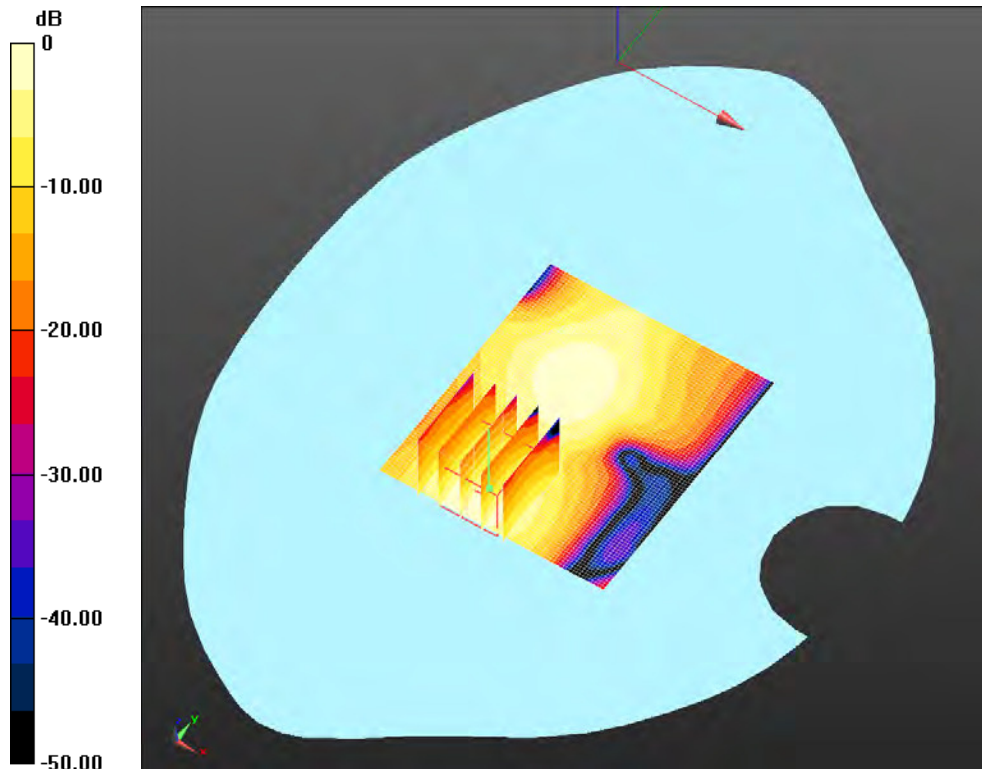

0 dB = 0.207 W/kg = -6.84 dBW/kg

Meas.3 Body plane with Bottom Edge on Low channel in WIFI 802.11b mode

Date/Time: 5/5/2016

Communication System Band: WLAN(b); Frequency: 2412 MHz; Duty Cycle: 1:1

Medium parameters used: $f = 2412$ MHz; $\sigma = 1.95$ S/m; $\epsilon_r = 51.72$; $\rho = 1000$ kg/m³

Phantom section: Flat Section

Ambient Temperature: 22.3 Liquid Temperature: 21.4

DASY5 Configuration:

- Probe: EX3DV4 - SN7340; ConvF(7.38, 7.38, 7.38); Calibrated: 12/10/2015;
- Sensor-Surface: 4mm (Mechanical Surface Detection)
- Electronics: DAE4 Sn1454; Calibrated: 12/8/2015
- Phantom: SAM (30deg probe tilt) with CRP v5.0 Right 1857; Type: QD000P40CD; Serial: TP1857
- Measurement SW: DASY52, Version 52.8 (8); SEMCAD X Version 14.6.10 (7331)

Configuration/Body plane with Bottom Edge on Low channel in WIFI 802.11b mode/Area Scan (71x81x1):

Interpolated grid: $dx=1.200$ mm, $dy=1.200$ mm

Maximum value of SAR (interpolated) = 0.0821 W/kg

Configuration/Body plane with Bottom Edge on Low channel in WIFI 802.11b mode/Zoom Scan (5x5x7)/Cube 0:

Measurement grid: $dx=8$ mm, $dy=8$ mm, $dz=5$ mm

Reference Value = 5.683 V/m; Power Drift = 0.16 dB

Peak SAR (extrapolated) = 0.122 W/kg

SAR(1 g) = 0.064 W/kg; SAR(10 g) = 0.032 W/kg

Maximum value of SAR (measured) = 0.0687 W/kg

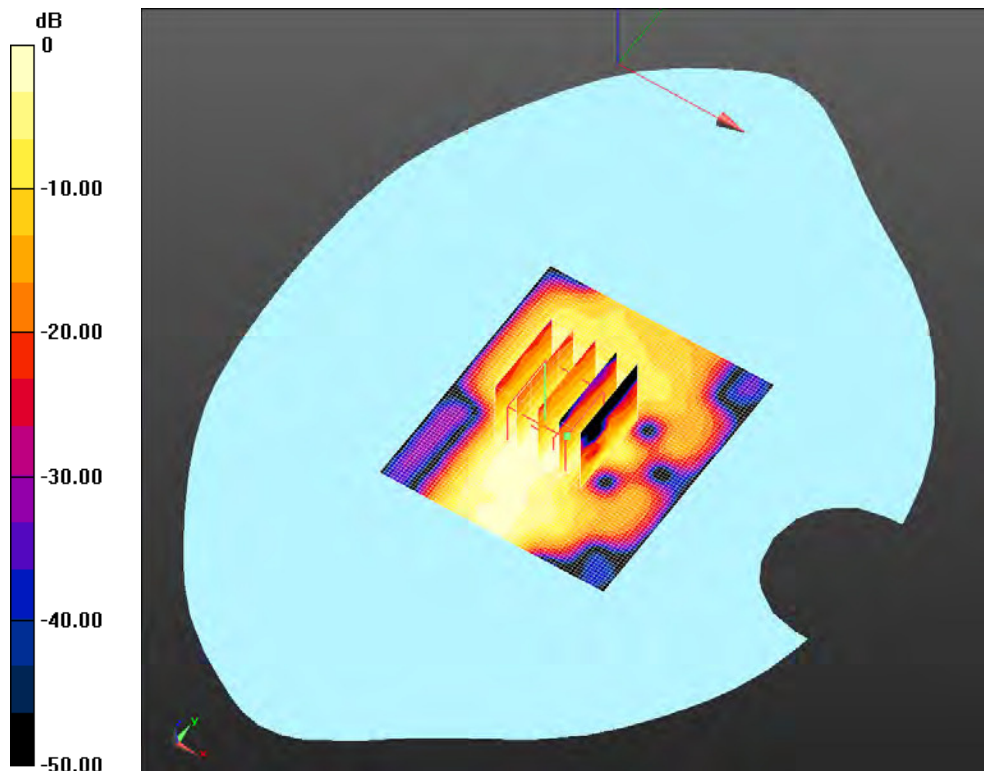

0 dB = 0.0821 W/kg = -10.86 dBW/kg

ANNEX D EUT EXTERNAL PHOTOS

Please refer the document "BL-SZ1640251-AW.pdf".

ANNEX E SAR TEST SETUP PHOTOS

Please refer the document "BL-SZ1640251-AS.pdf".

ANNEX F CALIBRATION REPORT

F.1 E-Field Probe



Add: No.51 Xueyuan Road, Haidian District, Beijing, 100191, China
 Tel: +86-10-62304633-2218 Fax: +86-10-62304633-2209
 E-mail: cttl@chinattl.com Http://www.chinattl.cn



Client **baluntek** Certificate No: **Z15-97196**

CALIBRATION CERTIFICATE				
Object	EX3DV4 - SN:7340			
Calibration Procedure(s)	FD-Z11-2-004-01 Calibration Procedures for Dosimetric E-field Probes			
Calibration date:	December 10, 2015			
<p>This calibration Certificate documents the traceability to national standards, which realize the physical units of measurements(SI). The measurements and the uncertainties with confidence probability are given on the following pages and are part of the certificate.</p> <p>All calibrations have been conducted in the closed laboratory facility: environment temperature(22±3)°C and humidity<70%.</p> <p>Calibration Equipment used (M&TE critical for calibration)</p>				
Primary Standards	ID #	Cal Date(Calibrated by, Certificate No.)		Scheduled Calibration
Power Meter NRP2	101919	01-Jul-15 (CTTL, No.J15X04256)		Jun-16
Power sensor NRP-Z91	101547	01-Jul-15 (CTTL, No.J15X04256)		Jun-16
Power sensor NRP-Z91	101548	01-Jul-15 (CTTL, No.J15X04256)		Jun-16
Reference10dBAttenuator	18N50W-10dB	13-Mar-14(TMC,No.JZ14-1103)		Mar-16
Reference20dBAttenuator	18N50W-20dB	13-Mar-14(TMC,No.JZ14-1104)		Mar-16
Reference Probe EX3DV4	SN 7307	27-Feb-15(SPEAG,No.EX3-7307_Feb15)		Feb-16
DAE4	SN 771	27-Jan-15(SPEAG, No.DAE4-771_Jan15)		Jan -16
Secondary Standards	ID #	Cal Date(Calibrated by, Certificate No.)		Scheduled Calibration
SignalGeneratorMG3700A	6201052605	01-Jul-15 (CTTL, No.J15X04255)		Jun-16
Network Analyzer E5071C	MY46110673	03-Feb-15 (CTTL, No.J15X00728)		Feb-16
	Name	Function	Signature	
Calibrated by:	Yu Zongying	SAR Test Engineer		
Reviewed by:	Qi Dianyuan	SAR Project Leader		
Approved by:	Lu Bingsong	Deputy Director of the laboratory		
Issued: December 11, 2015				
This calibration certificate shall not be reproduced except in full without written approval of the laboratory.				



In Collaboration with
Add: No.51 Xueyuan Road, Haidian District, Beijing, 100191, China
Tel: +86-10-62304633-2218 Fax: +86-10-62304633-2209
E-mail: cttl@chinattl.com <http://www.chinattl.cn>

Glossary:

TSL	tissue simulating liquid
NORM _{x,y,z}	sensitivity in free space
ConvF	sensitivity in TSL / NORM _{x,y,z}
DCP	diode compression point
CF	crest factor (1/duty_cycle) of the RF signal
A,B,C,D	modulation dependent linearization parameters
Polarization Φ	Φ rotation around probe axis
Polarization θ	θ rotation around an axis that is in the plane normal to probe axis (at measurement center), $\theta=0$ is normal to probe axis

Connector Angle information used in DASY system to align probe sensor X to the robot coordinate system

Calibration is Performed According to the Following Standards:

- IEEE Std 1528-2013, "IEEE Recommended Practice for Determining the Peak Spatial-Averaged Specific Absorption Rate (SAR) in the Human Head from Wireless Communications Devices: Measurement Techniques", June 2013
- IEC 62209-1, "Procedure to measure the Specific Absorption Rate (SAR) for hand-held devices used in close proximity to the ear (frequency range of 300MHz to 3GHz)", February 2005

Methods Applied and Interpretation of Parameters:

- NORM_{x,y,z}**: Assessed for E-field polarization $\theta=0$ ($f \leq 900$ MHz in TEM-cell; $f > 1800$ MHz: waveguide). NORM_{x,y,z} are only intermediate values, i.e., the uncertainties of NORM_{x,y,z} does not effect the E^2 -field uncertainty inside TSL (see below ConvF).
- NORM(f)_{x,y,z} = NORM_{x,y,z} * frequency_response** (see Frequency Response Chart). This linearization is implemented in DASY4 software versions later than 4.2. The uncertainty of the frequency response is included in the stated uncertainty of ConvF.
- DCP_{x,y,z}**: DCP are numerical linearization parameters assessed based on the data of power sweep (no uncertainty required). DCP does not depend on frequency nor media.
- PAR**: PAR is the Peak to Average Ratio that is not calibrated but determined based on the signal characteristics.
- A_{x,y,z}; B_{x,y,z}; C_{x,y,z}; VR_{x,y,z}; A,B,C** are numerical linearization parameters assessed based on the data of power sweep for specific modulation signal. The parameters do not depend on frequency nor media. VR is the maximum calibration range expressed in RMS voltage across the diode.
- ConvF and Boundary Effect Parameters**: Assessed in flat phantom using E-field (or Temperature Transfer Standard for $f \leq 800$ MHz) and inside waveguide using analytical field distributions based on power measurements for $f > 800$ MHz. The same setups are used for assessment of the parameters applied for boundary compensation (alpha, depth) of which typical uncertainty valued are given. These parameters are used in DASY4 software to improve probe accuracy close to the boundary. The sensitivity in TSL corresponds to NORM_{x,y,z} ConvF whereby the uncertainty corresponds to that given for ConvF. A frequency dependent ConvF is used in DASY version 4.4 and higher which allows extending the validity from ± 50 MHz to ± 100 MHz.
- Spherical isotropy (3D deviation from isotropy)**: in a field of low gradients realized using a flat phantom exposed by a patch antenna.
- Sensor Offset**: The sensor offset corresponds to the offset of virtual measurement center from the probe tip (on probe axis). No tolerance required.
- Connector Angle**: The angle is assessed using the information gained by determining the NORM_x (no uncertainty required).



Add: No.51 Xueyuan Road, Haidian District, Beijing, 100191, China
Tel: +86-10-62304633-2218 Fax: +86-10-62304633-2209
E-mail: cttl@chinattl.com [Http://www.chinattl.cn](http://www.chinattl.cn)

Probe EX3DV4

SN: 7340

Calibrated: December 10, 2015

Calibrated for DASY/EASY Systems

(Note: non-compatible with DASY2 system!)



In Collaboration with
 Add: No.51 Xueyuan Road, Haidian District, Beijing, 100191, China
 Tel: +86-10-62304633-2218 Fax: +86-10-62304633-2209
 E-mail: cttl@chinattl.com [Http://www.chinattl.cn](http://www.chinattl.cn)

DASY/EASY – Parameters of Probe: EX3DV4 – SN: 7340

Basic Calibration Parameters

	Sensor X	Sensor Y	Sensor Z	Unc (k=2)
Norm($\mu\text{V}/(\text{V}/\text{m})^2$) ^A	0.51	0.48	0.45	±10.8%
DCP(mV) ^B	100.7	101.8	105.1	

Modulation Calibration Parameters

UID	Communication System Name		A dB	B dB $\sqrt{\mu\text{V}}$	C	D dB	VR mV	Unc ^E (k=2)
0	CW	X	0.0	0.0	1.0	0.00	194.7	±2.2%
		Y	0.0	0.0	1.0		188.5	
		Z	0.0	0.0	1.0		183.1	

The reported uncertainty of measurement is stated as the standard uncertainty of Measurement multiplied by the coverage factor k=2, which for a normal distribution Corresponds to a coverage probability of approximately 95%.

^A The uncertainties of Norm X, Y, Z do not affect the E²-field uncertainty inside TSL (see Page 5 and Page 6).
^B Numerical linearization parameter: uncertainty not required.
^E Uncertainty is determined using the max. deviation from linear response applying rectangular distribution and is expressed for the square of the field value.



In Collaboration with
TTL s p e a g
CALIBRATION LABORATORY
 Add: No.51 Xueyuan Road, Haidian District, Beijing, 100191, China
 Tel: +86-10-62304633-2218 Fax: +86-10-62304633-2209
 E-mail: ttl@chinattl.com <http://www.chinattl.cn>

DASY/EASY – Parameters of Probe: EX3DV4 – SN: 7340

Calibration Parameter Determined in Head Tissue Simulating Media

f [MHz] ^C	Relative Permittivity ^F	Conductivity (S/m) ^F	ConvF X	ConvF Y	ConvF Z	Alpha ^G	Depth ^G (mm)	Unct. (k=2)
850	41.5	0.92	9.56	9.56	9.56	0.12	1.42	±12%
1750	40.1	1.37	8.22	8.22	8.22	0.22	1.08	±12%
1900	40.0	1.40	8.15	8.15	8.15	0.21	1.09	±12%
2450	39.2	1.80	7.62	7.62	7.62	0.48	0.72	±12%
2600	39.0	1.96	7.42	7.42	7.42	0.34	0.98	±12%
5200	36.0	4.66	5.33	5.33	5.33	0.39	1.21	±13%
5800	35.5	5.07	4.70	4.70	4.70	0.39	1.20	±13%
5800	35.3	5.27	4.68	4.68	4.68	0.39	1.25	±13%

^C Frequency validity of ±100MHz only applies for DASY v4.4 and higher (Page 2), else it is restricted to ±50MHz. The uncertainty is the RSS of ConvF uncertainty at calibration frequency and the uncertainty for the indicated frequency band.

^F At frequency below 3 GHz, the validity of tissue parameters (ϵ and σ) can be relaxed to ±10% if liquid compensation formula is applied to measured SAR values. At frequencies above 3 GHz, the validity of tissue parameters (ϵ and σ) is restricted to ±5%. The uncertainty is the RSS of the ConvF uncertainty for indicated target tissue parameters.

^G Alpha/Depth are determined during calibration. SPEAG warrants that the remaining deviation due to the boundary effect after compensation is always less than ± 1% for frequencies below 3 GHz and below ± 2% for the frequencies between 3-6 GHz at any distance larger than half the probe tip diameter from the boundary.



In Collaboration with
TTL SPEAG
 CALIBRATION LABORATORY
 Add: No.51 Xueyuan Road, Haidian District, Beijing, 100191, China
 Tel: +86-10-62304633-2218 Fax: +86-10-62304633-2209
 E-mail: cttl@chinattl.com [Http://www.chinattl.cn](http://www.chinattl.cn)

DASY/EASY – Parameters of Probe: EX3DV4 – SN: 7340

Calibration Parameter Determined in Body Tissue Simulating Media

f [MHz] ^C	Relative Permittivity ^F	Conductivity (S/m) ^F	ConvF X	ConvF Y	ConvF Z	Alpha ^G	Depth ^G (mm)	Unct. (k=2)
850	55.2	0.99	9.83	9.83	9.83	0.15	1.46	±12%
1750	53.4	1.49	7.87	7.87	7.87	0.20	1.16	±12%
1900	53.3	1.52	7.51	7.51	7.51	0.18	1.30	±12%
2450	52.7	1.95	7.38	7.38	7.38	0.35	0.97	±12%
2600	52.5	2.16	6.99	6.99	6.99	0.34	1.02	±12%
5200	49.0	5.30	4.56	4.56	4.56	0.45	1.31	±13%
5600	48.5	5.77	3.98	3.98	3.98	0.48	1.33	±13%
5800	48.2	6.00	4.15	4.15	4.15	0.50	1.18	±13%

^C Frequency validity of ±100MHz only applies for DASY v4.4 and higher (Page 2), else it is restricted to ±50MHz. The uncertainty is the RSS of ConvF uncertainty at calibration frequency and the uncertainty for the indicated frequency band.

^F At frequency below 3 GHz, the validity of tissue parameters (ϵ and σ) can be relaxed to ±10% if liquid compensation formula is applied to measured SAR values. At frequencies above 3 GHz, the validity of tissue parameters (ϵ and σ) is restricted to ±5%. The uncertainty is the RSS of the ConvF uncertainty for indicated target tissue parameters.

^G Alpha/Depth are determined during calibration. SPEAG warrants that the remaining deviation due to the boundary effect after compensation is always less than ± 1% for frequencies below 3 GHz and below ± 2% for the frequencies between 3-6 GHz at any distance larger than half the probe tip diameter from the boundary.



Add: No.51 Xueyuan Road, Haidian District, Beijing, 100191, China
Tel: +86-10-62304633-2218 Fax: +86-10-62304633-2209
E-mail: cttl@chinattl.com [Http://www.chinattl.cn](http://www.chinattl.cn)

Frequency Response of E-Field (TEM-Cell: ifi110 EXX, Waveguide: R22)

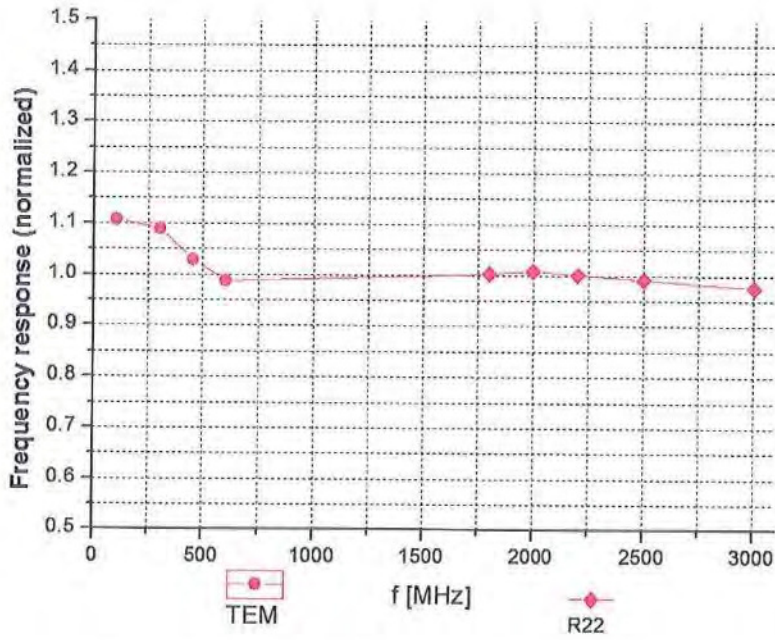

Uncertainty of Frequency Response of E-field: $\pm 7.5\%$ (k=2)



Add: No.51 Xueyuan Road, Haidian District, Beijing, 100191, China
Tel: +86-10-62304633-2218 Fax: +86-10-62304633-2209
E-mail: cttl@chinattl.com [Http://www.chinattl.cn](http://www.chinattl.cn)

Receiving Pattern (Φ), $\theta=0^\circ$

f=600 MHz, TEM

f=1800 MHz, R22

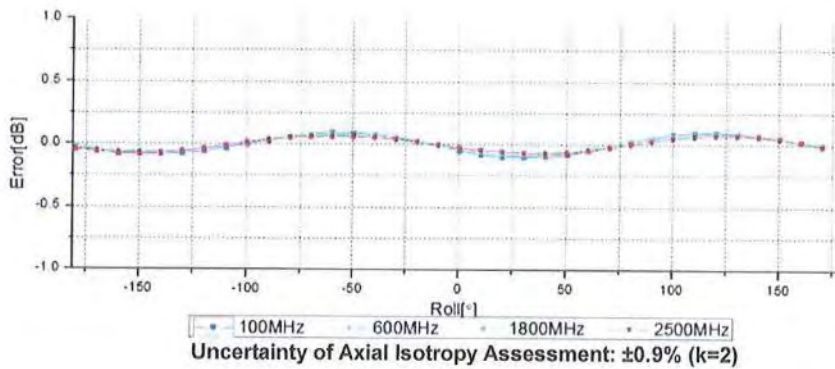
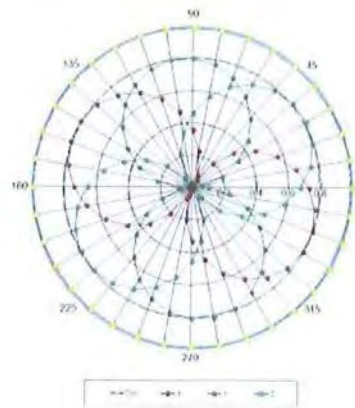
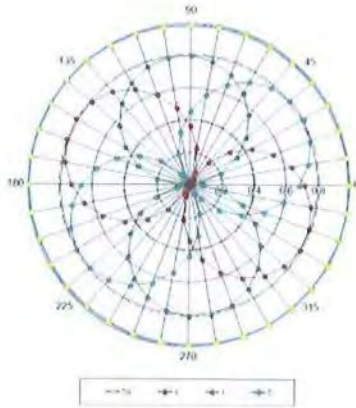



Add: No.51 Xueyuan Road, Haidian District, Beijing, 100191, China
Tel: +86-10-62304633-2218 Fax: +86-10-62304633-2209
E-mail: cttl@chinattl.com [Http://www.chinattl.cn](http://www.chinattl.cn)

Dynamic Range f(SAR_{head}) (TEM cell, f = 900 MHz)

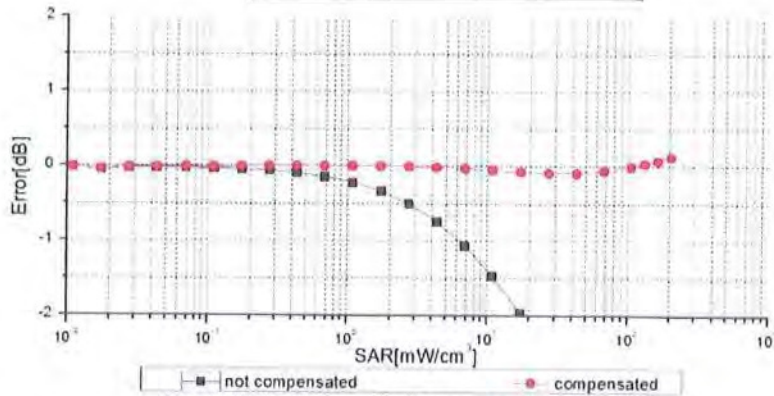
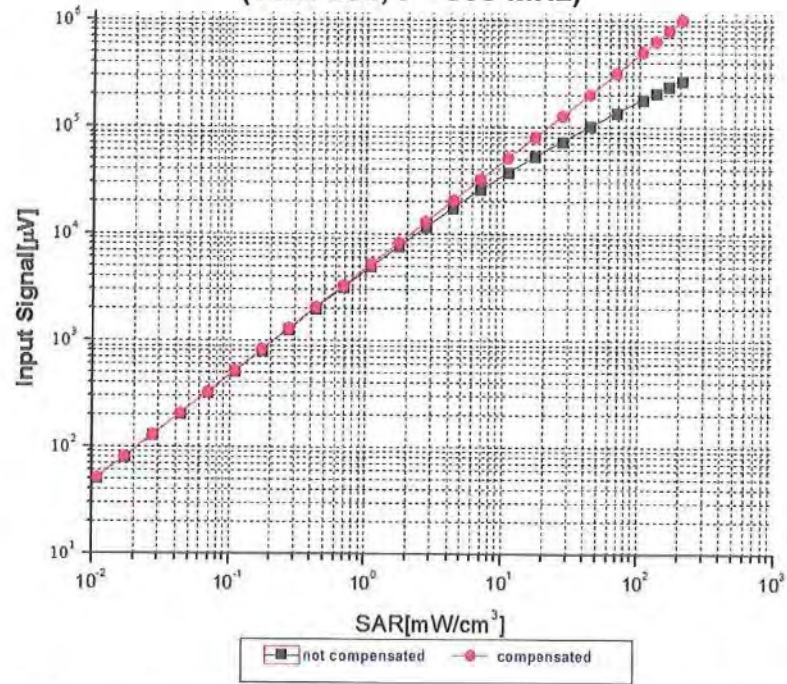

Uncertainty of Linearity Assessment: $\pm 0.9\%$ (k=2)



Add: No.51 Xueyuan Road, Haidian District, Beijing, 100191, China
Tel: +86-10-62304633-2218 Fax: +86-10-62304633-2209
E-mail: cttl@chinattl.com [Http://www.chinattl.cn](http://www.chinattl.cn)

Conversion Factor Assessment

f=850 MHz, WGLS R9(H_convF)

f=1750 MHz, WGLS R22(H_convF)

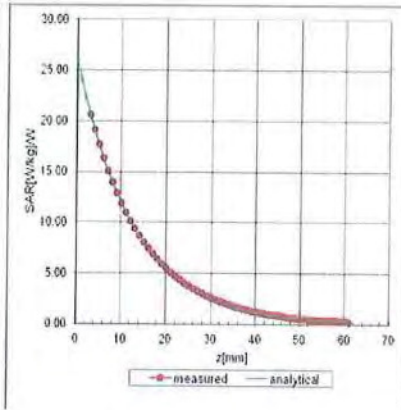
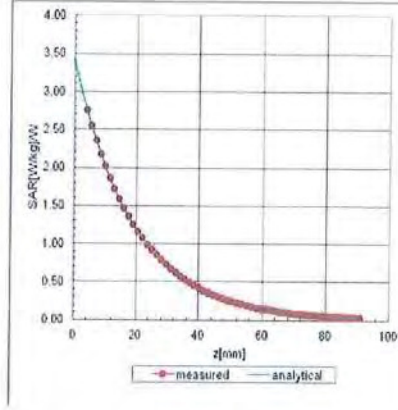

Deviation from Isotropy in Liquid

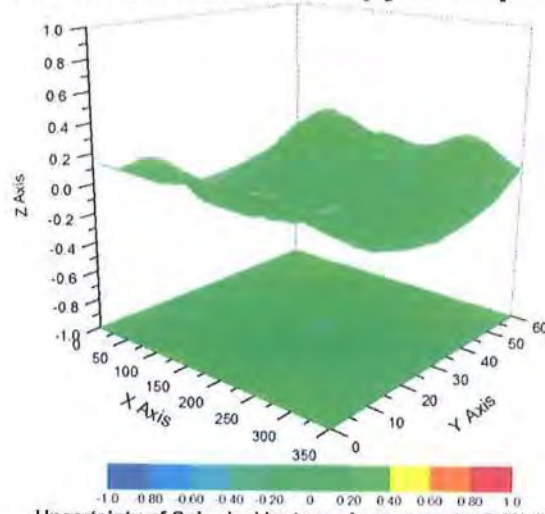

Uncertainty of Spherical Isotropy Assessment: $\pm 2.8\%$ (K=2)



Add: No.51 Xueyuan Road, Haidian District, Beijing, 100191, China
Tel: +86-10-62304633-2218 Fax: +86-10-62304633-2209
E-mail: cttl@chinattl.com [Http://www.chinattl.cn](http://www.chinattl.cn)

DASY/EASY – Parameters of Probe: EX3DV4 – SN: 7340

Other Probe Parameters

Sensor Arrangement	Triangular
Connector Angle (°)	130.2
Mechanical Surface Detection Mode	enabled
Optical Surface Detection Mode	disable
Probe Overall Length	337mm
Probe Body Diameter	10mm
Tip Length	9mm
Tip Diameter	2.5mm
Probe Tip to Sensor X Calibration Point	1mm
Probe Tip to Sensor Y Calibration Point	1mm
Probe Tip to Sensor Z Calibration Point	1mm
Recommended Measurement Distance from Surface	1.4mm

F.2 Data Acquisition Electronics



In Collaboration with
s p e a g
CALIBRATION LABORATORY

Add: No.51 Xueyuan Road, Haidian District, Beijing, 100191, China
Tel: +86-10-62304633-2218 Fax: +86-10-62304633-2209
E-mail: cttl@chinattl.com [Http://www.chinattl.cn](http://www.chinattl.cn)



CALIBRATION
No. L0570

Client : **baluntek** Certificate No: **Z15-97195**

CALIBRATION CERTIFICATE

Object: **DAE4 - SN: 1454**

Calibration Procedure(s): **FD-Z11-2-002-01
Calibration Procedure for the Data Acquisition Electronics (DAEx)**

Calibration date: **December 08, 2015**

This calibration Certificate documents the traceability to national standards, which realize the physical units of measurements(SI). The measurements and the uncertainties with confidence probability are given on the following pages and are part of the certificate.

All calibrations have been conducted in the closed laboratory facility: environment temperature(22±3)°C and humidity<70%.

Calibration Equipment used (M&TE critical for calibration)

Primary Standards	ID #	Cal Date(Calibrated by, Certificate No.)	Scheduled Calibration
Process Calibrator 753	1971018	06-July-15 (CTTL, No:J15X04257)	July-16

	Name	Function	Signature
Calibrated by:	Yu Zongying	SAR Test Engineer	
Reviewed by:	Qi Dianyuan	SAR Project Leader	
Approved by:	Lu Bingsong	Deputy Director of the laboratory	

Issued: December 09, 2015

This calibration certificate shall not be reproduced except in full without written approval of the laboratory.

Certificate No: Z15-97195

Page 1 of 3



Add: No.51 Xueyuan Road, Haidian District, Beijing, 100191, China
Tel: +86-10-62304633-2218 Fax: +86-10-62304633-2209
E-mail: ettl@chinattl.com [Http://www.chinattl.cn](http://www.chinattl.cn)

Glossary:

DAE data acquisition electronics
Connector angle information used in DASY system to align probe sensor X to the robot coordinate system.

Methods Applied and Interpretation of Parameters:

- *DC Voltage Measurement*: Calibration Factor assessed for use in DASY system by comparison with a calibrated instrument traceable to national standards. The figure given corresponds to the full scale range of the voltmeter in the respective range.
- *Connector angle*: The angle of the connector is assessed measuring the angle mechanically by a tool inserted. Uncertainty is not required.
- The report provide only calibration results for DAE, it does not contain other performance test results.



Add: No.51 Xueyuan Road, Haidian District, Beijing, 100191, China
Tel: +86-10-62304633-2218 Fax: +86-10-62304633-2209
E-mail: ctll@chinattl.com Http://www.chinattl.cn

DC Voltage Measurement

A/D - Converter Resolution nominal

High Range: 1LSB = 6.1 μ V, full range = -100...+300 mV

Low Range: 1LSB = 61nV, full range = -1.....+3mV

DASY measurement parameters: Auto Zero Time: 3 sec; Measuring time: 3 sec

Calibration Factors	X	Y	Z
High Range	404.175 \pm 0.15% (k=2)	403.666 \pm 0.15% (k=2)	403.739 \pm 0.15% (k=2)
Low Range	4.01281 \pm 0.7% (k=2)	3.9916 \pm 0.7% (k=2)	3.99929 \pm 0.7% (k=2)

Connector Angle

Connector Angle to be used in DASY system	317.5 $^{\circ}$ \pm 1 $^{\circ}$
---	-------------------------------------

F.3 Dual Logo-CTTL-SPEAG-certificates

Schmid & Partner Engineering AG

s p e a g

Zeughausstrasse 43, 8004 Zurich, Switzerland
Phone +41 44 245 9700, Fax +41 44 245 9779
info@speag.com, <http://www.speag.com>

Tolan Tu
Shenzhen BALUN Technology Co., Ltd.
Block B, FL 1, Baisha Science and Technology
Park, Shahe Xi Road, Nanshan District,
ShenZhen, GuangDong Province,
P. R. China

Email: tulang@baluntek.com

Zurich, March 4, 2016/ kp

To whom it may concern:

Schmid & Partner Engineering AG (SPEAG), established and reputable manufacturers of dosimetry equipment at Zeughausstrasse 43 CH - 8004 Zurich Switzerland, do hereby certify that below listed calibration certificates have been approved for release under CTTL-SPEAG dual-logo as per QAP4CAL agreement between SPEAG and CTTL Beijing SAR calibration lab.

Certificate No. Z15-97195 (calibration of DAE4 – SN: 1454)
Certificate No. Z15-97196 (calibration of EX3DV4 – SN: 7340)

Yours sincerely,

Schmid & Partner Engineering AG



s p e a g

Schmid & Partner Engineering AG
Zeughausstrasse 43, 8004 Zurich, Switzerland
Phone +41 44 245 9700, Fax +41 44 245 9779
info@speag.com, <http://www.speag.com>



Dr. Katja Pokovic
Director Laboratory & Services

F.4 Dipole Performance Measurement Report

<p><i>SAR Dipole</i></p> <p>Performance Measurement Report</p>	<p>ISSUED BY Shenzhen BALUN Technology Co., Ltd.</p>  <p>FOR Validation Dipoles</p>
	
<p>Tested by: <i>Tu Lang</i> Tu Lang (Engineer)</p> <p>Approved by: <i>Wei Yanqian</i> Wei Yanqian (Chief Engineer)</p> 	<p>Report No.: LW-SZ15C0264-701 EUT Type: SAR Validation Dipole Model Name: D835V2, D1750V2 D1900V2, D2450V2 D2600V2, D5GHzV2 Brand Name: Speag</p> <p>Test Conclusion: Pass Test Date: Oct. 23, 2015 ~ Oct. 26, 2015 Date of Issue: Oct. 29, 2015</p>

NOTE: This test report can be duplicated completely for the legal use with the approval of the applicant; it shall not be reproduced except in full, without the written approval of Shenzhen BALUN Technology Co., Ltd. BALUN Laboratory. Any objections should be raised within thirty days from the date of issue. To validate the report, please visit BALUN website.



1 GENERAL INFORMATION

1.1 Introduction

This document contains a summary of the requirements set forth by the IEEE 1528, FCC KDB 865664 D01 for reference dipoles used for SAR measurement system validations. Instead of the typical annual calibration recommended by measurement standards, the reference dipoles were demonstrated that the SAR target, impedance and return loss have remain stable, so the longer calibration interval is acceptable.

1.2 General Description for Equipment under Test (EUT)



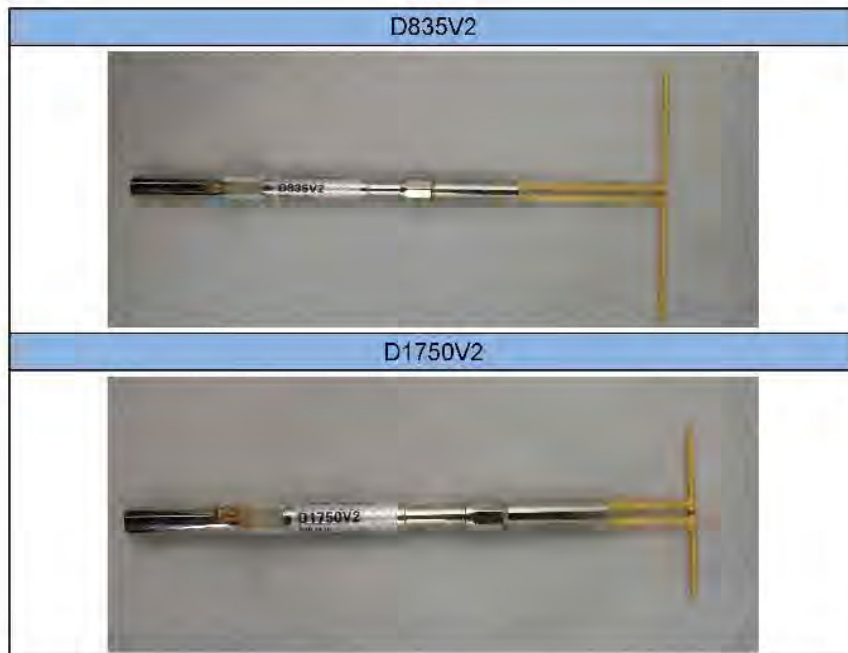

EUT Type	DASY 52 Reference Dipoles
Manufacturer	Speag

Parameter	EUT 1	EUT 2	EUT 3	EUT 4	EUT 5	EUT 6
Model	D835V2	D1750V2	D1900V2	D2450V2	D2600V2	D5GHzV2
Frequency	835 MHz	1750 MHz	1900 MHz	2450 MHz	2600 MHz	5GHz-6GHz
Serial Number	SN 4d187	SN 1130	SN 5d193	SN 952	SN 1095	SN 1200
Product Condition (New/ Used)	Used	Used	Used	Used	Used	Used
Last Cal. Date	2014/11/26	2014/11/28	2014/11/28	2014/11/27	2014/11/27	2014/12/4

1.3 EUT Photos





D1900V2

D2450V2

D2600V2

D5GHzV2



2 SIMULATING LIQUID VERIFICATION

Liquid Type	Fre. (MHz)	Meas. Conductivity (σ) (S/m)	Meas. Permittivity (ϵ)	Target Conductivity (σ) (S/m)	Target Permittivity (ϵ)	Conductivity Tolerance (%)	Permittivity Tolerance (%)
Head	835	0.89	41.83	0.90	41.50	-1.11	0.80
Body	835	0.98	53.88	0.97	55.20	1.03	-2.39
Head	1750	1.38	39.23	1.37	40.10	0.73	-2.17
Body	1750	1.45	51.75	1.49	53.40	-2.68	-3.09
Head	1900	1.43	39.44	1.40	40.00	2.14	-1.40
Body	1900	1.55	51.61	1.52	53.30	1.97	-3.17
Head	2450	1.84	38.53	1.80	39.20	2.22	-1.71
Body	2450	1.99	51.17	1.95	52.70	2.05	-2.90
Head	2600	1.97	38.09	1.96	39.00	0.51	-2.33
Body	2600	2.20	50.81	2.16	52.50	1.85	-3.22
Head	5200	4.78	36.52	4.66	35.99	2.58	1.47
Body	5200	5.38	48.74	5.30	49.01	1.51	-0.55
Head	5600	5.20	35.06	5.07	35.53	2.56	-1.32
Body	5600	5.72	46.31	5.77	48.47	-0.87	-4.46
Head	5800	5.42	34.40	5.27	35.30	2.85	-2.55
Body	5800	5.92	46.06	6.00	48.20	-1.33	-4.44



3 DIPOLE IMPEDANCE AND RETURN LOSS

The dipoles are designed to have low return loss when presented against a flat phantom at the specified distance. A Vector Network Analyser was used to perform a return loss measurement on the specific dipole when in the measurement location against the phantom and the distance was specified by the manufacturer with a special, low loss and low relative permittivity spacer.

The impedance was measured at the SMA-connector with the network analyser.

3.1 D835V2

RETURN LOSS AND IMPEDANCE IN HEAD LIQUID

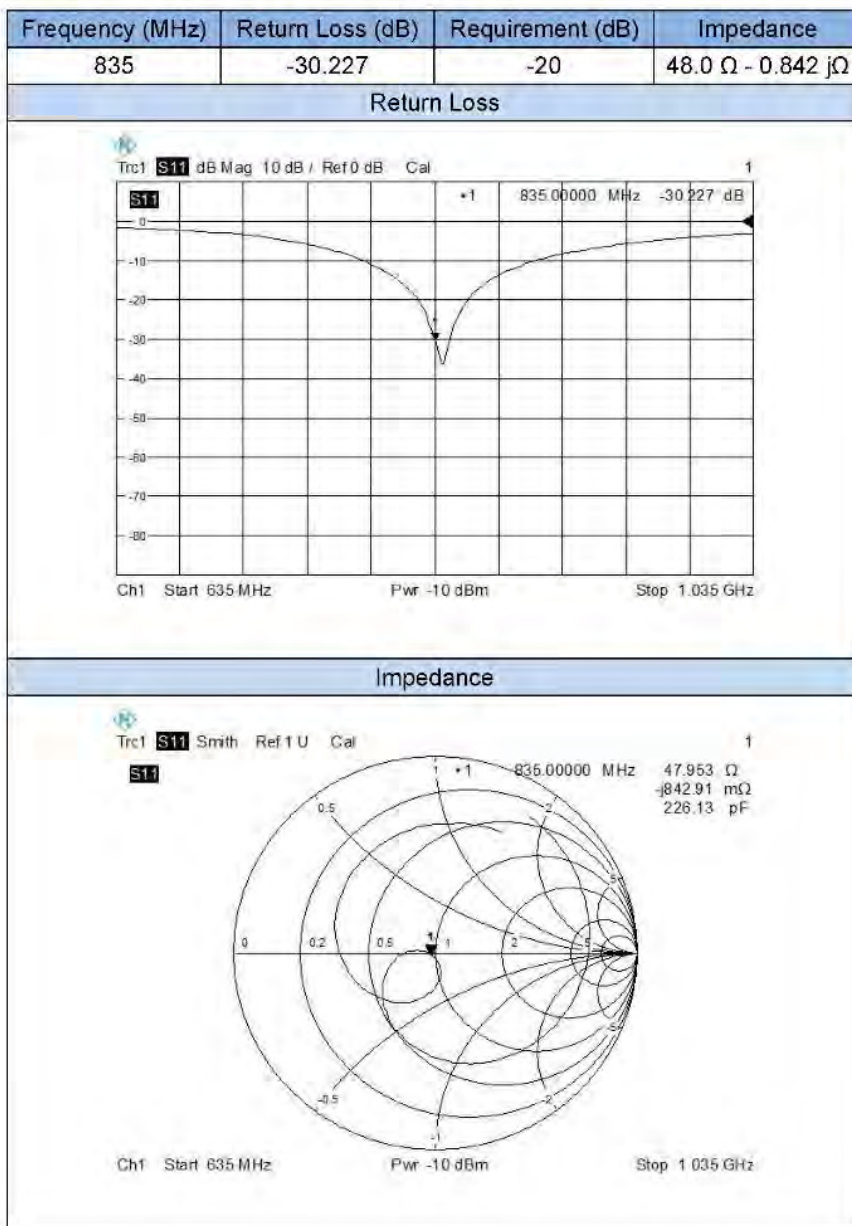



RETURN LOSS AND IMPEDANCE IN BODY LIQUID

Frequency (MHz)	Return Loss (dB)	Requirement (dB)	Impedance
835	-24.404	-20	46.9 Ω + 4.997 jΩ

Return Loss

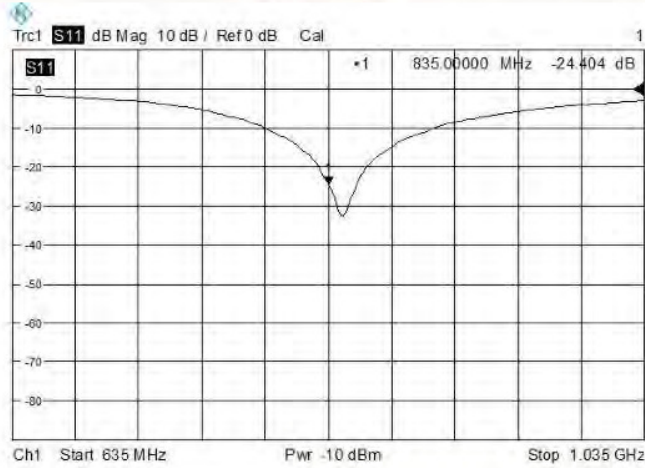

Impedance

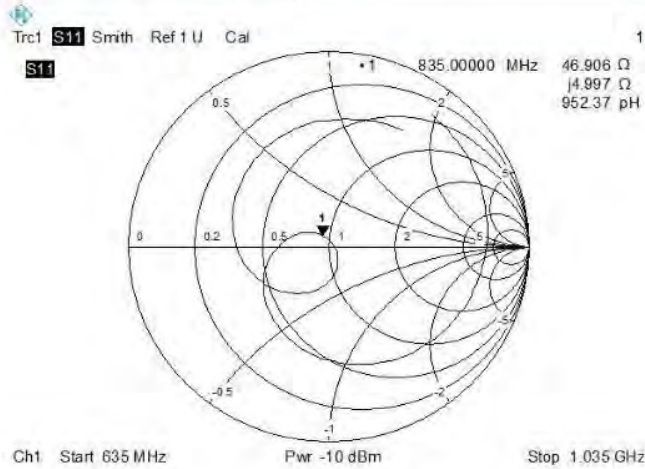



3.2 D1750V2

RETURN LOSS AND IMPEDANCE IN HEAD LIQUID

Frequency (MHz)	Return Loss (dB)	Requirement (dB)	Impedance
1750	-37.494	-20	48.8 Ω - 0.448 jΩ

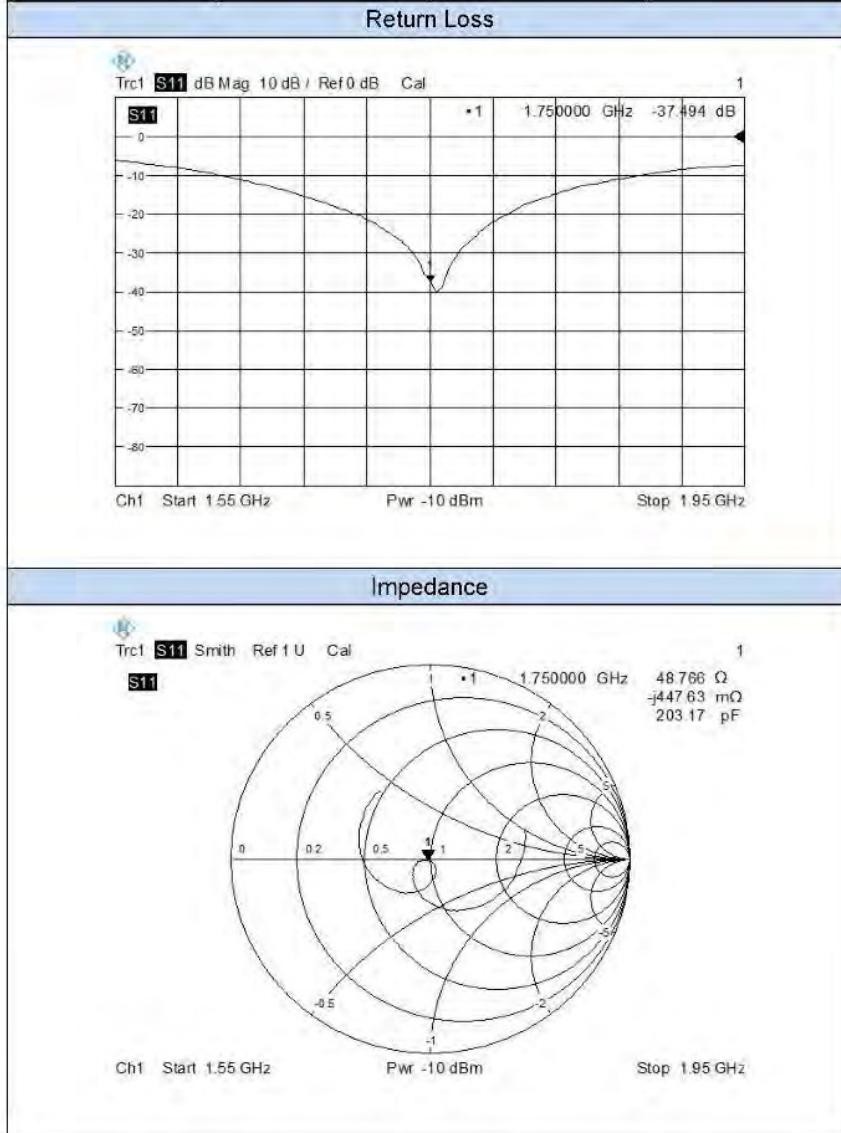



RETURN LOSS AND IMPEDANCE IN BODY LIQUID

Frequency (MHz)	Return Loss (dB)	Requirement (dB)	Impedance
1750	-25.849	-20	48.0 Ω + 4.534 jΩ

Return Loss

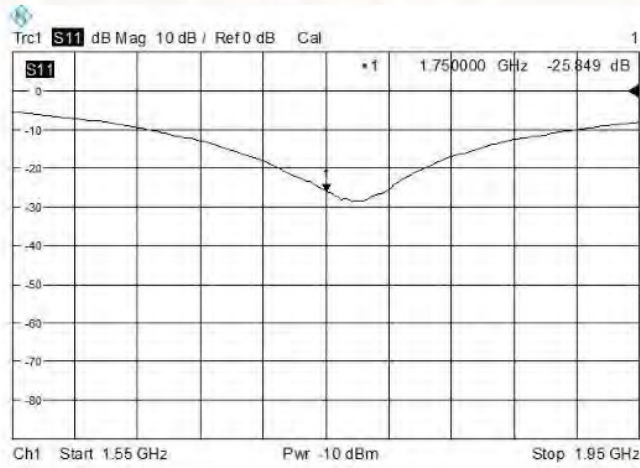

Impedance

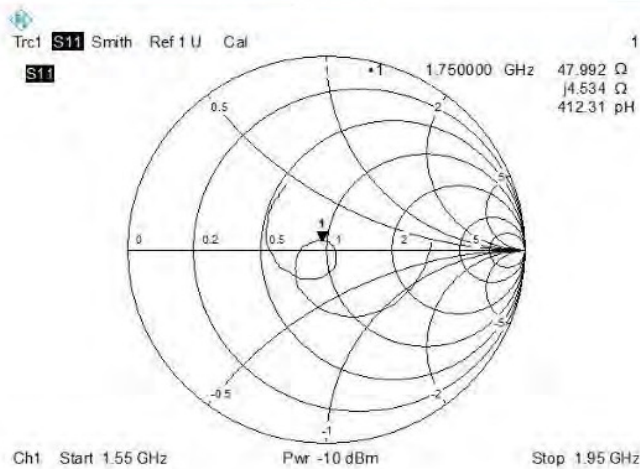



3.3 D1900V2

RETURN LOSS AND IMPEDANCE IN HEAD LIQUID

Frequency (MHz)	Return Loss(dB)	Requirement (dB)	Impedance
1900	-31.607	-20	47.520 Ω -0.735 j Ω

Return Loss

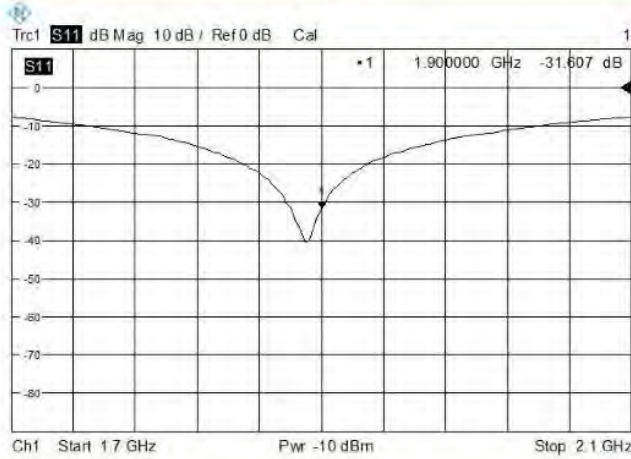

Impedance

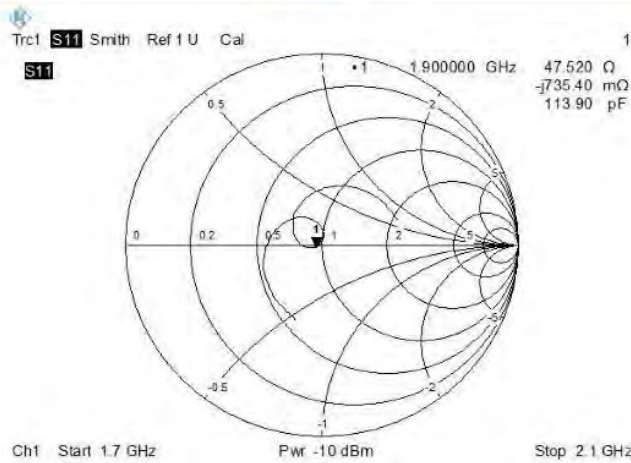



RETURN LOSS AND IMPEDANCE IN BODY LIQUID

Frequency (MHz)	Return Loss (dB)	Requirement (dB)	Impedance
1900	-25.957	-20	48.4 Ω - 4.6 jΩ

Return Loss

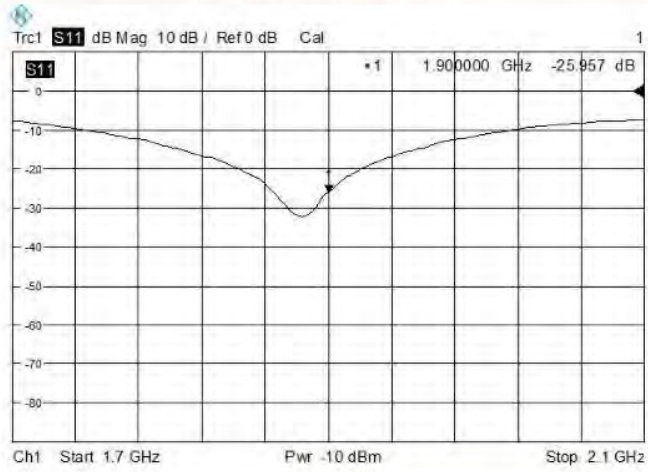

Impedance

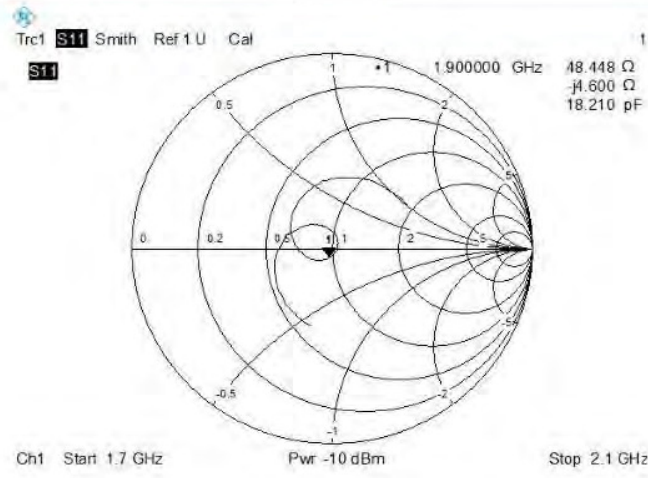



3.4 D2450V2

RETURN LOSS AND IMPEDANCE IN HEAD LIQUID

Frequency (MHz)	Return Loss (dB)	Requirement (dB)	Impedance
2450	-27.642	-20	46.5 Ω + 1.998 jΩ

Return Loss

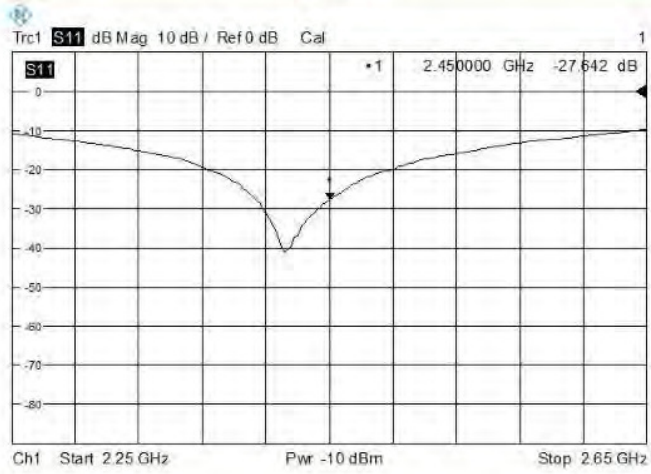

Impedance

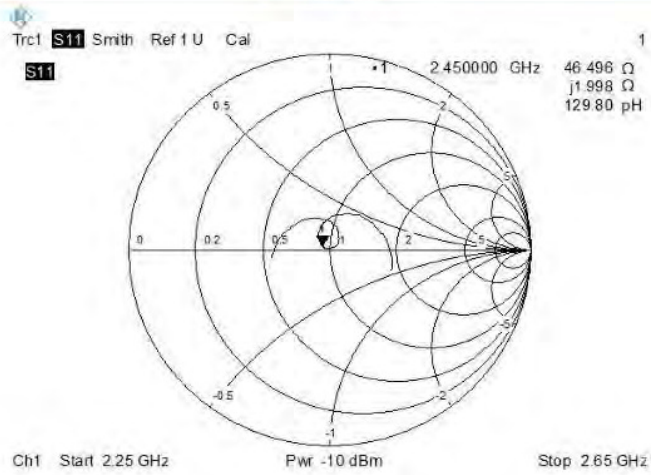



RETURN LOSS AND IMPEDANCE IN BODY LIQUID

Frequency (MHz)	Return Loss (dB)	Requirement (dB)	Impedance
2450	-27.494	-20	46.8 Ω - 2.446 jΩ

Return Loss

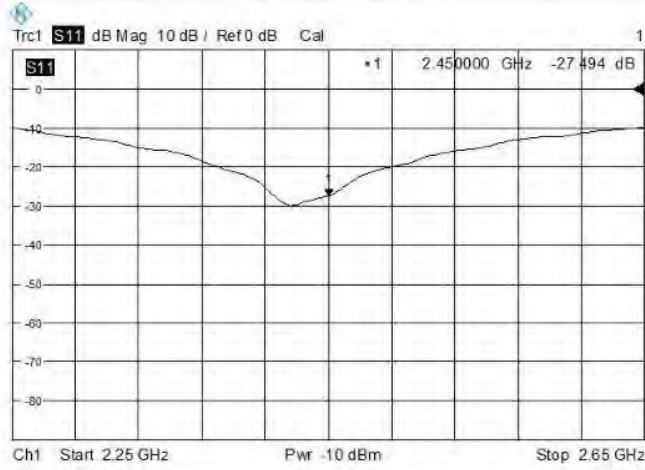

Impedance

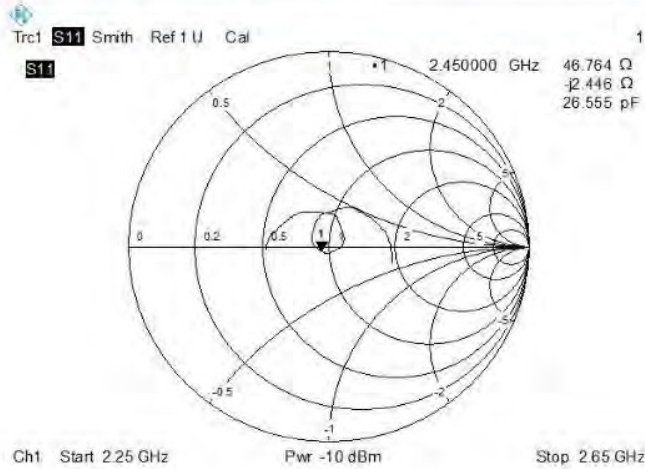



3.5 D2600V2

RETURN LOSS AND IMPEDANCE IN HEAD LIQUID

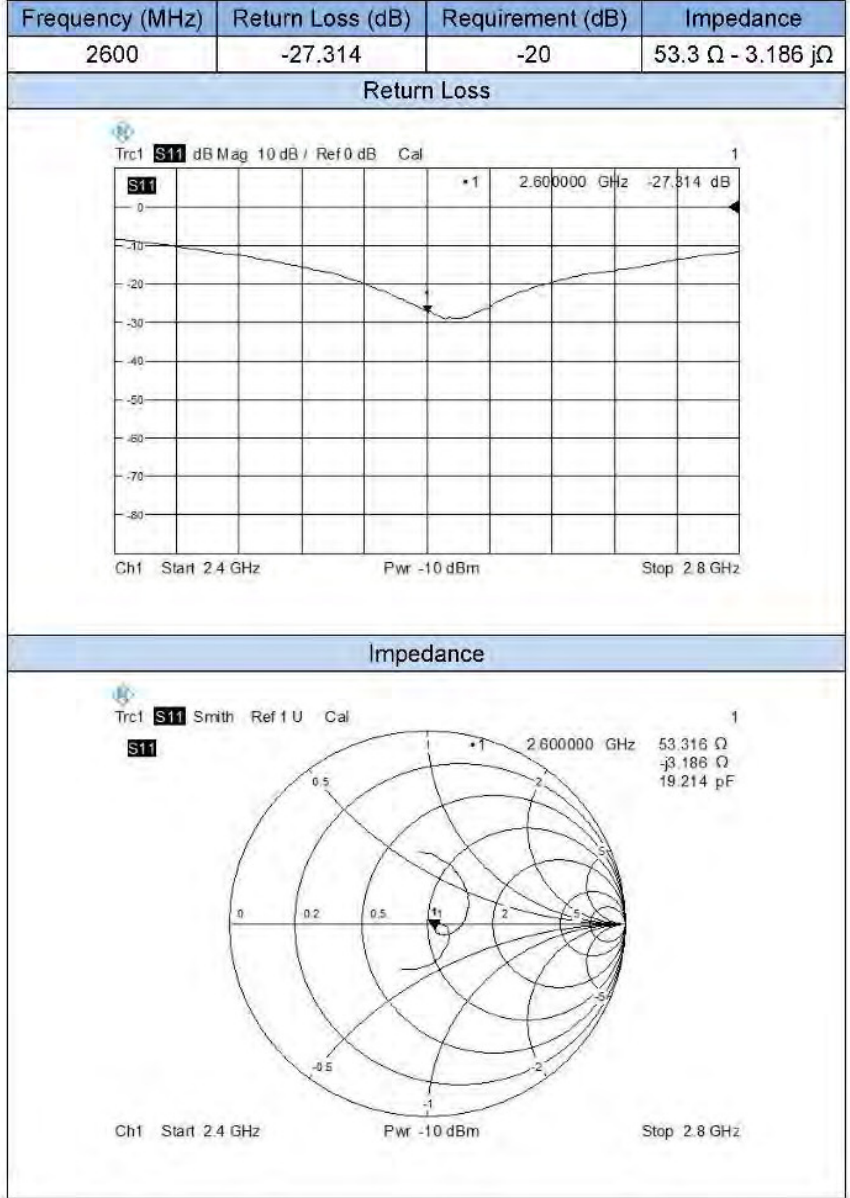



RETURN LOSS AND IMPEDANCE IN BODY LIQUID

Frequency (MHz)	Return Loss (dB)	Requirement (dB)	Impedance
2600	-30.161	-20	50.6 Ω - 3.015 $j\Omega$

Return Loss

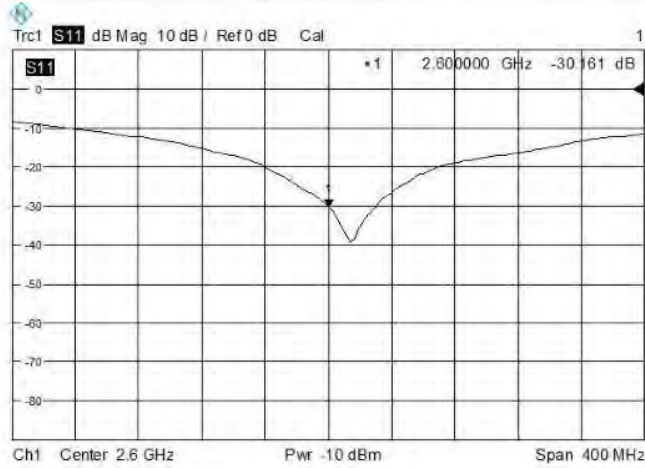

Impedance

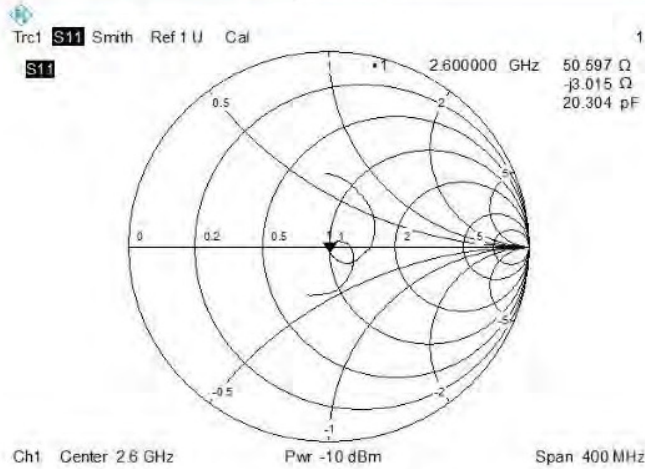



3.6 D5GHzV2

RETURN LOSS AND IMPEDANCE IN HEAD LIQUID

Frequency (MHz)	Return Loss (dB)	Requirement (dB)	Impedance
5200	-31.668	-20	47.8 Ω + 1.189 j Ω
5600	-22.615	-20	53.4 Ω - 3.757 j Ω
5800	-29.503	-20	51.1 Ω + 1.415 j Ω

Return Loss

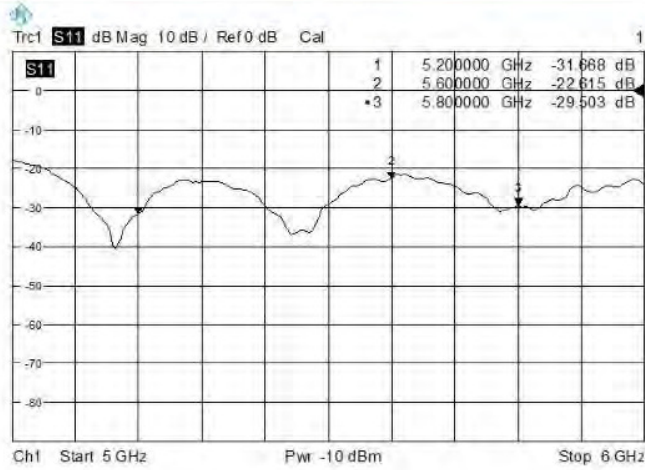

Impedance

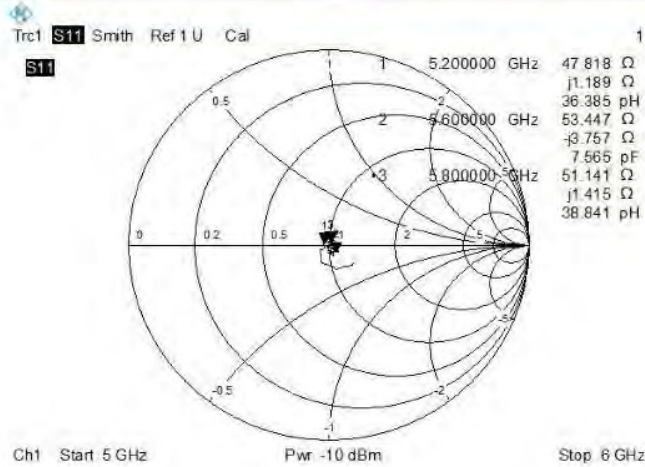



RETURN LOSS AND IMPEDANCE IN BODY LIQUID

Frequency (MHz)	Return Loss (dB)	Requirement (dB)	Impedance
5200	-30.037	-20	47.2 Ω + 1.088 jΩ
5600	-21.932	-20	52.0 Ω - 3.425 jΩ
5800	-28.420	-20	51.6 Ω + 1.436 jΩ

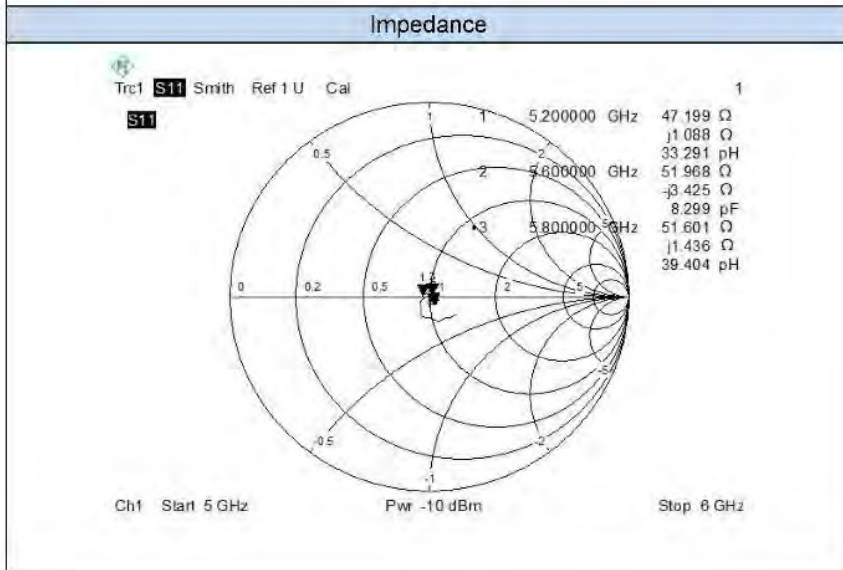
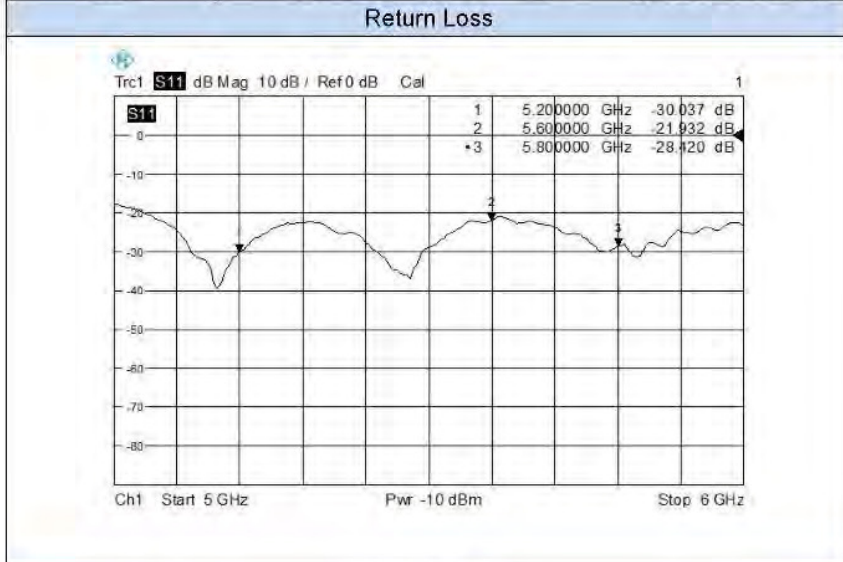



4 VALIDATION MEASUREMENT

The IEEE Std. 1528, FCC KDBs and CEI/IEC 62209 standards state that the system validation measurements must be performed using a reference dipole meeting the fore mentioned return loss and mechanical dimension requirements. The validation measurement must be performed against a liquid filled flat phantom, with the phantom constructed as outlined in the fore mentioned standards. Per the standards, the dipole shall be positioned below the bottom of the phantom, with the dipole length centered and parallel to the longest dimension of the flat phantom, with the top surface of the dipole at the described distance from the bottom surface of the phantom.

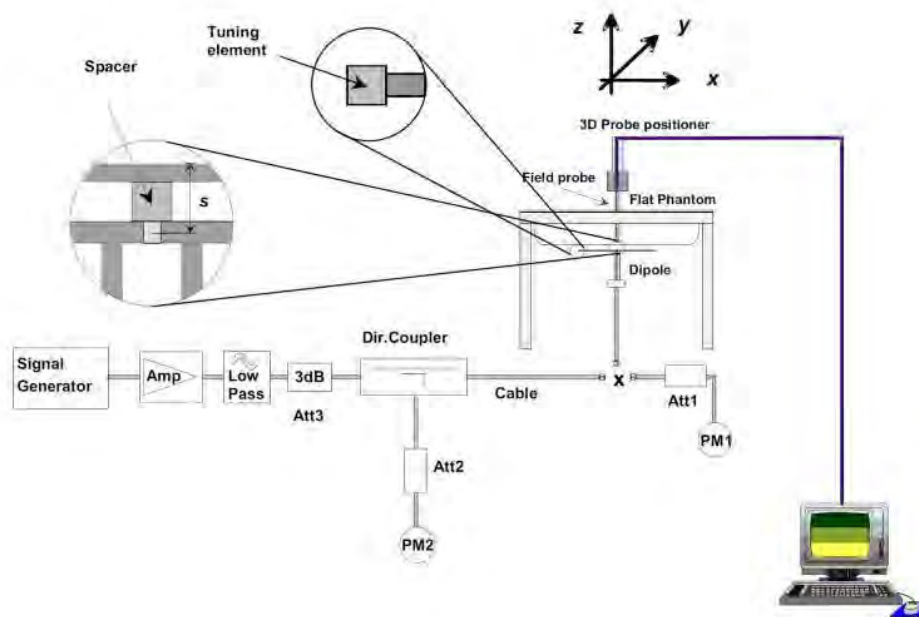

4.1 Dipole SAR Validation Measurement Result

Freq. (MHz)	Liquid Type	Power (mW)	1 g Measured SAR (W/kg)	Normalized SAR (W/kg)	10 g Measured SAR (W/kg)	Normalized SAR (W/kg)	1 g Targeted SAR (W/kg)	Tolerance (%)	10 g Targeted SAR (W/kg)	Tolerance (%)
835	Head	100	0.959	9.59	0.627	6.27	9.56	0.31	6.22	0.80
	Body	100	0.961	9.61	0.634	6.34	9.56	0.52	6.22	1.93
1750	Head	100	3.440	34.40	1.810	18.10	36.40	-5.49	19.30	-6.22
	Body	100	3.660	36.60	1.950	19.50	36.40	0.55	19.30	1.04
1900	Head	100	3.960	39.60	2.070	20.70	39.70	-0.25	20.50	0.98
	Body	100	4.010	40.10	2.090	20.90	39.70	1.01	20.50	1.95
2450	Head	100	5.260	52.60	2.410	24.10	52.40	0.38	24.00	0.42
	Body	100	5.130	51.30	2.330	23.30	52.40	-2.10	24.00	-2.92
2600	Head	100	5.410	54.10	2.360	23.60	55.30	-2.17	24.60	-4.07



	Body	100	5.580	55.80	2.420	24.20	55.30	0.90	24.60	-1.63
5200	Head	100	8.220	82.20	2.240	22.40	76.50	7.45	21.60	3.70
	Body	100	8.320	83.20	2.280	22.80	76.50	8.76	21.60	5.56
5600	Head	100	8.240	82.40	2.260	22.60				
	Body	100	8.410	84.10	2.330	23.30				
5800	Head	100	7.280	72.80	2.120	21.20	78.0	-6.67	21.90	-3.20
	Body	100	8.240	82.40	2.300	23.00	78.0	5.64	21.90	5.02



4.2 D835V2

4.2.1 Dipole 835 MHz Validation Measurement for Head Tissue

Dipole 835 MHz; Type: D835V2; Serial: D835V2-SN: 4d187

Date/Time: 10/25/2015

Communication System Band: D835 (835.0 MHz); Frequency: 835 MHz; Duty Cycle: 1:1

Medium parameters used: $f = 835$ MHz; $\sigma = 0.89$ S/m; $\epsilon_r = 41.83$; $\rho = 1000$ kg/m³

Phantom section: Flat Section

Ambient Temperature: 21.4 Liquid Temperature: 20.8

DASY5 Configuration:

- Probe: EX3DV4 - SN7340; ConvF(9.56, 9.56, 9.56);
- Sensor-Surface: 4mm (Mechanical Surface Detection)
- Electronics: DAE4 Sn1454;
- Phantom: SAM (30deg probe tilt) with CRP v5.0 Right 1857; Type: QD000P40CD; Serial: TP1857
- Measurement SW: DASY52, Version 52.8 (8); SEMCAD X Version 14.6.10 (7331)

Dipole validation measurement for Head Tissue/Pin= 100mW , d=15mm/Zoom

Scan (7x7x7)/Cube 0: Measurement grid: dx=5mm, dy=5mm, dz=5mm

Reference Value = 34.03 V/m; Power Drift = -0.01 dB

Peak SAR (extrapolated) = 1.44 W/kg

SAR(1 g) = 0.959 W/kg; SAR(10 g) = 0.627 W/kg

Maximum value of SAR (measured) = 1.03 W/kg

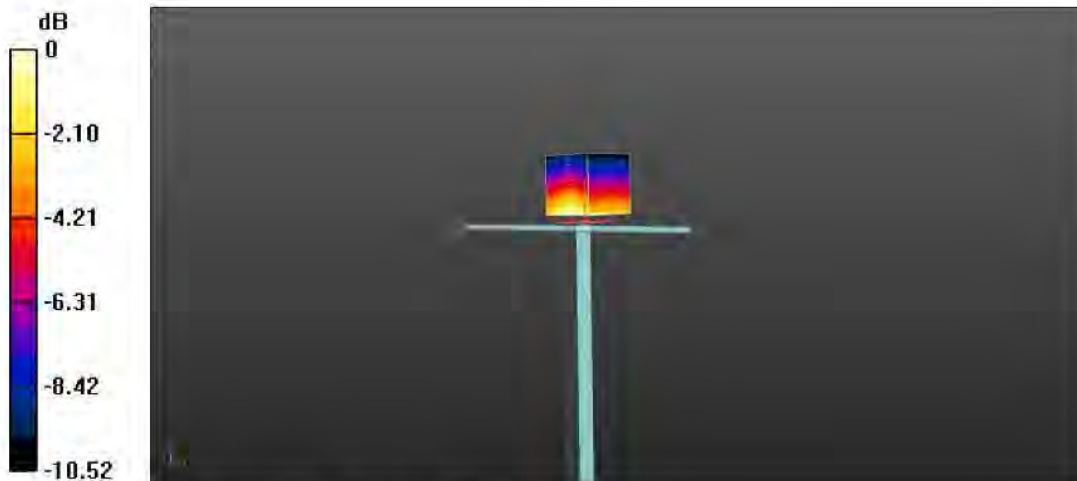

0 dB = 1.03 W/kg = 0.13 dBW/kg



4.2.2 Dipole 835 MHz Validation Measurement for Body Tissue

Dipole 835 MHz; Type: D835V2; Serial: D835V2-SN: 4d187

Date/Time: 10/25/2015

Communication System Band: D835 (835.0 MHz); Frequency: 835 MHz; Duty Cycle: 1:1

Medium parameters used: $f = 835$ MHz; $\sigma = 0.98$ S/m; $\epsilon_r = 53.88$; $\rho = 1000$ kg/m³

Phantom section: Flat Section

Ambient Temperature: 22.4 Liquid Temperature: 21.8

DASY5 Configuration:

- Probe: EX3DV4 - SN7340; ConvF(9.83, 9.83, 9.83);
- Sensor-Surface: 4mm (Mechanical Surface Detection)
- Electronics: DAE4 Sn1454;
- Phantom: SAM (30deg probe tilt) with CRP v5.0 on left 1859; Type: QD000P40CD; Serial: TP:1859
- Measurement SW: DASY52, Version 52.8 (8); SEMCAD X Version 14.6.10 (7331)

Dipole validation measurement for Body Tissue/Pin= 100mW , d=15mm /Zoom

Scan (7x7x7)/Cube 0: Measurement grid: dx=5mm, dy=5mm, dz=5mm

Reference Value = 31.63 V/m; Power Drift = -0.10 dB

Peak SAR (extrapolated) = 1.40 W/kg

SAR(1 g) = 0.961 W/kg; SAR(10 g) = 0.634 W/kg

Maximum value of SAR (measured) = 1.04 W/kg

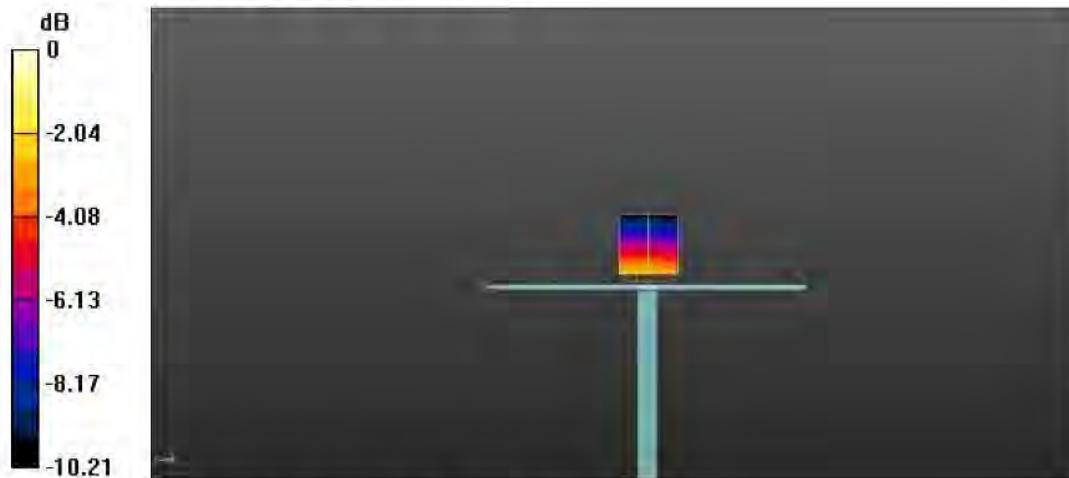

0 dB = 1.04 W/kg = 0.17 dBW/kg



4.3D1750V2

4.3.1 Dipole 1750 MHz Validation Measurement for Head Tissue

Dipole 1750 MHz; Type: D1750V2; Serial: D1750V2-SN: 1130

Date/Time: 10/23/2015

Communication System Band: D1750 (1750.0 MHz); Frequency: 1750 MHz; Duty Cycle: 1:1

Medium parameters used: $f = 1750$ MHz; $\sigma = 1.38$ S/m; $\epsilon_r = 39.23$; $\rho = 1000$ kg/m³

Phantom section: Flat Section

Ambient Temperature: 21.8 Liquid Temperature: 21.2

DASY5 Configuration:

- Probe: EX3DV4 - SN7340; ConvF(9.13, 9.13, 9.13);
- Sensor-Surface: 4mm (Mechanical Surface Detection)
- Electronics: DAE4 Sn1454;
- Phantom: SAM (30deg probe tilt) with CRP v5.0 on left 1859; Type: QD000P40CD; Serial: TP:1859
- Measurement SW: DASY52, Version 52.8 (8); SEMCAD X Version 14.6.10 (7331)

Dipole validation measurement for Head Tissue/Pin= 100mW ,d=10mm /Zoom

Scan (7x7x7)/Cube 0: Measurement grid: dx=5mm, dy=5mm, dz=5mm

Reference Value = 40.68 V/m; Power Drift = -0.17 dB

Peak SAR (extrapolated) = 6.42 W/kg

SAR(1 g) = 3.44 W/kg; SAR(10 g) = 1.81 W/kg

Maximum value of SAR (measured) = 3.87 W/kg

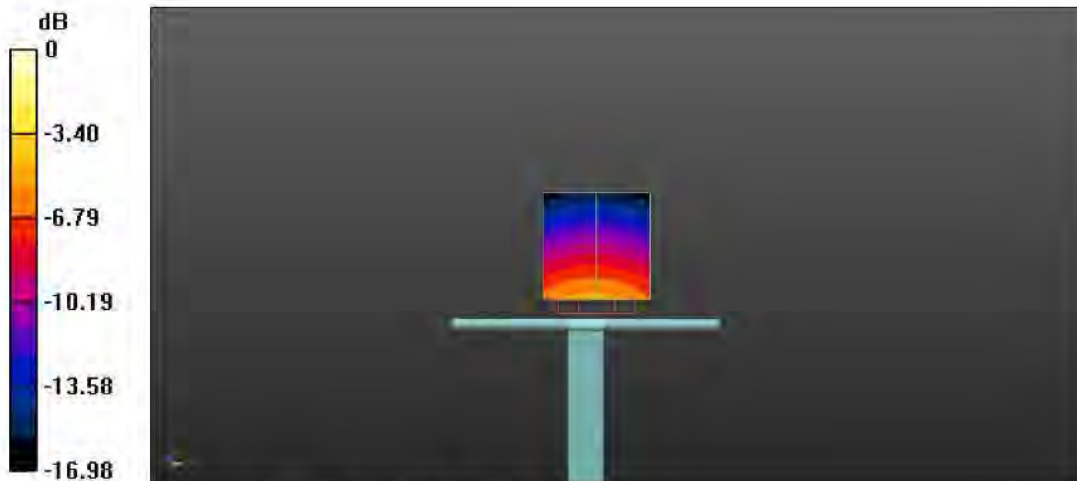

0 dB = 3.87 W/kg = 5.88 dBW/kg



4.3.2 Dipole 1750 MHz Validation Measurement for Body Tissue

Dipole 1750 MHz; Type: D1750V2; Serial: D1750V2-SN: 1130

Date/Time: 10/22/2015

Communication System Band: D1750 (1750.0 MHz); Frequency: 1750 MHz; Duty Cycle: 1:1

Medium parameters used: $f = 1750$ MHz; $\sigma = 1.45$ S/m; $\epsilon_r = 51.75$; $\rho = 1000$ kg/m³

Phantom section: Flat Section

Ambient Temperature: 21.8 Liquid Temperature: 21.2

DASY5 Configuration:

- Probe: EX3DV4 - SN7340; ConvF(7.87, 7.87, 7.87);
- Sensor-Surface: 4mm (Mechanical Surface Detection)
- Electronics: DAE4 Sn1454;
- Phantom: SAM (30deg probe tilt) with CRP v5.0 on left 1859; Type: QD000P40CD; Serial: TP:1859
- Measurement SW: DASY52, Version 52.8 (8); SEMCAD X Version 14.6.10 (7331)

Dipole validation measurement for Body Tissue/Pin= 100mW ,d=10mm /Zoom

Scan (7x7x7)/Cube 0: Measurement grid: dx=5mm, dy=5mm, dz=5mm

Reference Value = 38.41 V/m; Power Drift = -0.13 dB

Peak SAR (extrapolated) = 6.61 W/kg

SAR(1 g) = 3.66 W/kg; SAR(10 g) = 1.95 W/kg

Maximum value of SAR (measured) = 4.14 W/kg

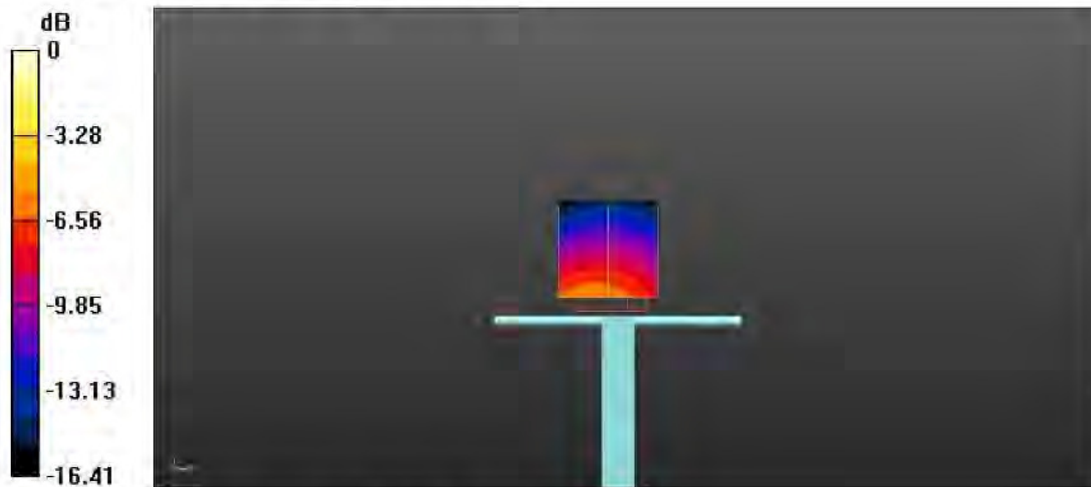

0 dB = 4.14 W/kg = 6.17 dBW/kg



4.4D1900V2

4.4.1 Dipole 1900 MHz Validation Measurement for Head Tissue

Dipole 1900 MHz; Type: D1900V2; Serial: D1900V2-SN: 5d193

Date/Time: 10/25/2015

Communication System Band: D1900 (1900.0 MHz); Frequency: 1900 MHz; Duty Cycle: 1:1

Medium parameters used: $f = 1900$ MHz; $\sigma = 1.43$ S/m; $\epsilon_r = 39.75$; $\rho = 1000$ kg/m³

Phantom section: Flat Section

Ambient Temperature: 21.7 Liquid Temperature: 20.9

DASY5 Configuration:

- Probe: EX3DV4 - SN7340; ConvF(8.15, 8.15, 8.15);
- Sensor-Surface: 4mm (Mechanical Surface Detection)
- Electronics: DAE4 Sn1454;
- Phantom: SAM (30deg probe tilt) with CRP v5.0 on left 1859; Type: QD000P40CD; Serial: TP:1859
- Measurement SW: DASY52, Version 52.8 (8); SEMCAD X Version 14.6.10 (7331)

Dipole validation measurement for Head Tissue/Pin= 100mW ,d=10mm /Zoom Scan (7x7x7)/Cube 0: Measurement grid: dx=5mm, dy=5mm, dz=5mm

Reference Value = 48.36 V/m; Power Drift = -0.08 dB

Peak SAR (extrapolated) = 7.33 W/kg

SAR(1 g) = 3.96 W/kg; SAR(10 g) = 2.07 W/kg

Maximum value of SAR (measured) = 4.40 W/kg

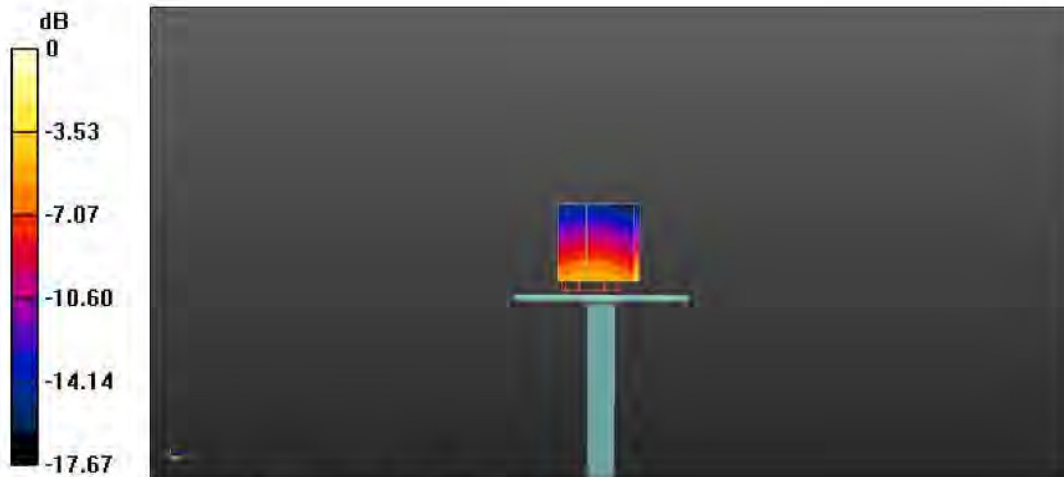

0 dB = 4.40 W/kg = 6.43 dBW/kg



4.4.2 Dipole 1900 MHz Validation Measurement for Body Tissue

Dipole 1900 MHz; Type: D1900V2; Serial: D1900V2-SN: 5d193

Date/Time: 10/25/2015

Communication System Band: D1900 (1900.0 MHz); Frequency: 1900 MHz; Duty Cycle: 1:1

Medium parameters used: $f = 1900$ MHz; $\sigma = 1.55$ S/m; $\epsilon_r = 51.61$; $\rho = 1000$ kg/m³

Phantom section: Flat Section

Ambient Temperature: 21.7 Liquid Temperature: 20.9

DASY5 Configuration:

- Probe: EX3DV4 - SN7340; ConvF(7.51, 7.51, 7.51);
- Sensor-Surface: 4mm (Mechanical Surface Detection)
- Electronics: DAE4 Sn1454;
- Phantom: SAM (30deg probe tilt) with CRP v5.0 Right 1857; Type: QD000P40CD; Serial: TP1857
- Measurement SW: DASY52, Version 52.8 (8); SEMCAD X Version 14.6.10 (7331)

Dipole validation measurement for Body Tissue/Pin= 100mW ,d=10mm /Zoom

Scan (7x7x7)/Cube 0: Measurement grid: dx=5mm, dy=5mm, dz=5mm

Reference Value = 48.99 V/m; Power Drift = -0.07 dB

Peak SAR (extrapolated) = 7.27 W/kg

SAR(1 g) = 4.01 W/kg; SAR(10 g) = 2.09 W/kg

Maximum value of SAR (measured) = 4.55 W/kg

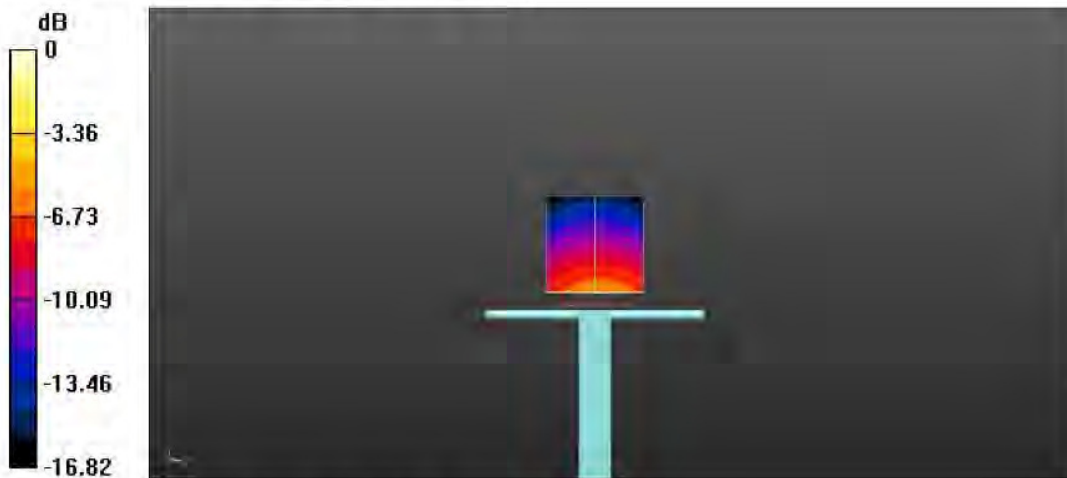

0 dB = 4.55 W/kg = 6.58 dBW/kg



4.5 D2450V2

4.5.1 Dipole 2450 MHz Validation Measurement for Head Tissue

Dipole 2450 MHz; Type: D2450V2; Serial: D2450V2-SN: 952

Date/Time: 10/24/2015

Communication System Band: CD2450 (2450.0 MHz); Frequency: 2450 MHz; Duty Cycle: 1:1

Medium parameters used: $f = 2450$ MHz; $\sigma = 1.84$ S/m; $\epsilon_r = 38.53$; $\rho = 1000$ kg/m³

Phantom section: Flat Section

Ambient Temperature: 22.1 Liquid Temperature: 21.2

DASY5 Configuration:

- Probe: EX3DV4 - SN7340; ConvF(7.62, 7.62, 7.62);
- Sensor-Surface: 4mm (Mechanical Surface Detection)
- Electronics: DAE4 Sn1454;
- Phantom: SAM (30deg probe tilt) with CRP v5.0 Right 1857; Type: QD000P40CD; Serial: TP1857
- Measurement SW: DASY52, Version 52.8 (8); SEMCAD X Version 14.6.10 (7331)

Dipole validation measurement for Head Tissue/Pin= 100mW ,d=10mm /Zoom Scan (7x7x7)/Cube 0: Measurement grid: dx=5mm, dy=5mm, dz=5mm

Reference Value = 53.74 V/m; Power Drift = 0.17 dB

Peak SAR (extrapolated) = 11.3 W/kg

SAR(1 g) = 5.26 W/kg; SAR(10 g) = 2.41 W/kg

Maximum value of SAR (measured) = 6.00 W/kg

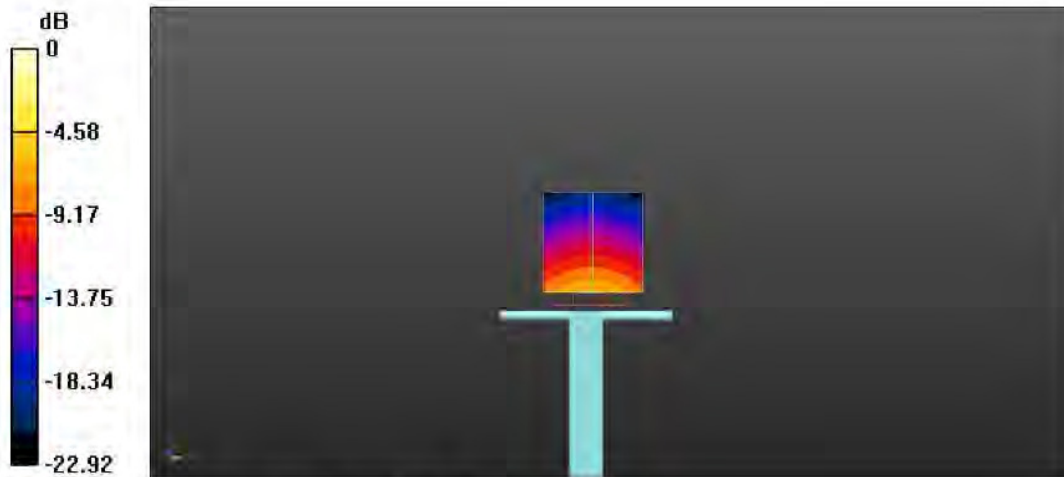

0 dB = 6.00 W/kg = 7.78 dBW/kg



4.5.2 Dipole 2450 MHz Validation Measurement for Body Tissue

Dipole 2450 MHz; Type: D2450V2; Serial: D2450V2-SN: 952

Date/Time: 10/24/2015

Communication System Band: D2450 (2450.0 MHz); Frequency: 2450 MHz; Duty Cycle: 1:1

Medium parameters used: $f = 2450$ MHz; $\sigma = 1.99$ S/m; $\epsilon_r = 51.17$; $\rho = 1000$ kg/m³

Phantom section: Flat Section

Ambient Temperature: 22.1 Liquid Temperature: 21.2

DASY5 Configuration:

- Probe: EX3DV4 - SN7340; ConvF(7.55, 7.55, 7.55);
- Sensor-Surface: 4mm (Mechanical Surface Detection)
- Electronics: DAE4 Sn1454;
- Phantom: SAM (30deg probe tilt) with CRP v5.0 Right 1857; Type: QD000P40CD; Serial: TP1857
- Measurement SW: DASY52, Version 52.8 (8); SEMCAD X Version 14.6.10 (7331)

Dipole validation measurement for Body Tissue/Pin= 100mW ,d=10mm /Zoom

Scan (7x7x7)/Cube 0: Measurement grid: dx=5mm, dy=5mm, dz=5mm

Reference Value = 50.42 V/m; Power Drift = -0.03 dB

Peak SAR (extrapolated) = 10.8 W/kg

SAR(1 g) = 5.13 W/kg; SAR(10 g) = 2.33 W/kg

Maximum value of SAR (measured) = 5.91 W/kg

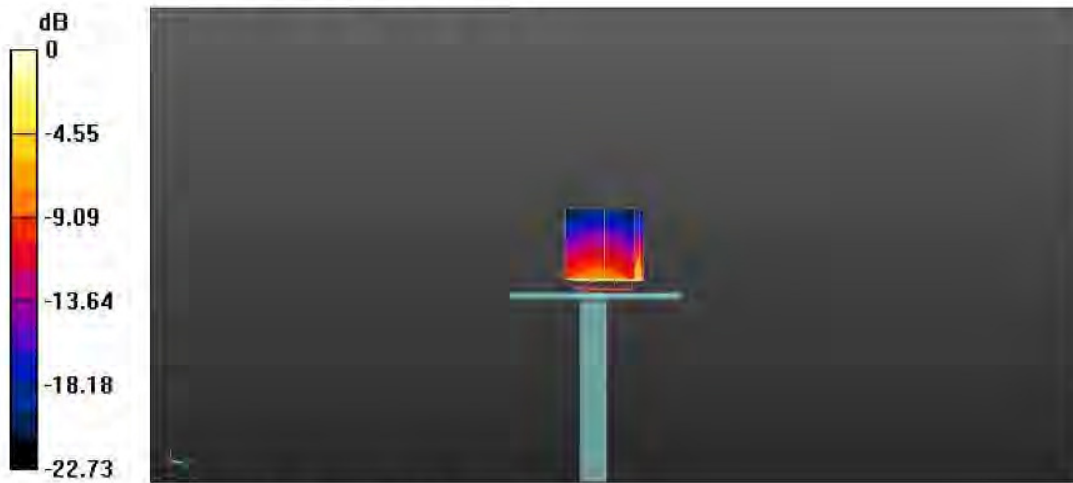

0 dB = 5.91 W/kg = 7.72 dBW/kg



4.6 D2600V2

4.6.1 Dipole 2600 MHz Validation Measurement for Head Tissue

Dipole 2600 MHz; Type: D2600V2; Serial: D2600V2-SN: 1095

Date/Time: 10/24/2015

Communication System Band: D2600 (2600.0 MHz); Frequency: 2600 MHz; Duty Cycle: 1:1

Medium parameters used: $f = 2600$ MHz; $\sigma = 1.97$ S/m; $\epsilon_r = 38.09$; $\rho = 1000$ kg/m³

Phantom section: Flat Section

Ambient Temperature: 21.5 Liquid Temperature: 20.6

DASY5 Configuration:

- Probe: EX3DV4 - SN7340; ConvF(7.64, 7.64, 7.64);
- Sensor-Surface: 4mm (Mechanical Surface Detection)
- Electronics: DAE4 Sn1454;
- Phantom: SAM (30deg probe tilt) with CRP v5.0 Right 1857; Type: QD000P40CD; Serial: TP1857
- Measurement SW: DASY52, Version 52.8 (8); SEMCAD X Version 14.6.10 (7331)

Dipole validation measurement for Head Tissue/Pin= 100mW ,d=10mm /Zoom Scan (7x7x7)/Cube 0: Measurement grid: dx=5mm, dy=5mm, dz=5mm

Reference Value = 52.69 V/m; Power Drift = -0.11 dB

Peak SAR (extrapolated) = 12.2 W/kg

SAR(1 g) = 5.41 W/kg; SAR(10 g) = 2.36 W/kg

Maximum value of SAR (measured) = 6.17 W/kg

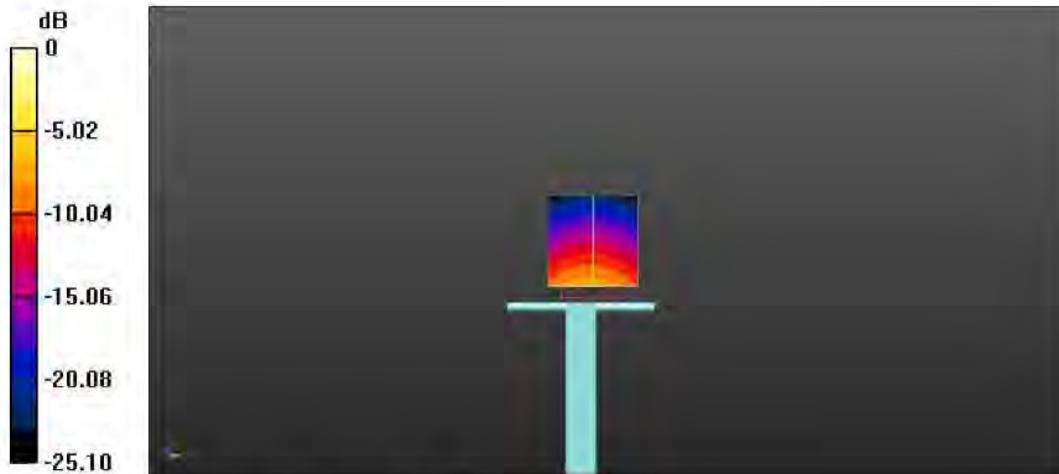

0 dB = 6.17 W/kg = 7.90 dBW/kg



4.6.2 Dipole 2600 MHz Validation Measurement for Body Tissue

Dipole 2600 MHz; Type: D2600V2; Serial: D835V2-SN: 1095

Date/Time: 10/24/2015

Communication System Band: D2600 (2600.0 MHz); Frequency: 2600 MHz; Duty Cycle: 1:1

Medium parameters used: $f = 2600$ MHz; $\sigma = 2.20$ S/m; $\epsilon_r = 50.81$; $\rho = 1000$ kg/m³

Phantom section: Flat Section

Ambient Temperature: 21.5 Liquid Temperature: 20.6

DASY5 Configuration:

- Probe: EX3DV4 - SN7340; ConvF(7.11, 7.11, 7.11);
- Sensor-Surface: 4mm (Mechanical Surface Detection)
- Electronics: DAE4 Sn1454;
- Phantom: SAM (30deg probe tilt) with CRP v5.0 Right 1857; Type: QD000P40CD; Serial: TP1857
- Measurement SW: DASY52, Version 52.8 (8); SEMCAD X Version 14.6.10 (7331)

Dipole validation measurement for Body Tissue/Pin= 100mW ,d=10mm /Zoom

Scan (7x7x7)/Cube 0: Measurement grid: dx=5mm, dy=5mm, dz=5mm

Reference Value = 52.33 V/m; Power Drift = -0.03 dB

Peak SAR (extrapolated) = 12.3 W/kg

SAR(1 g) = 5.58 W/kg; SAR(10 g) = 2.42 W/kg

Maximum value of SAR (measured) = 6.45 W/kg

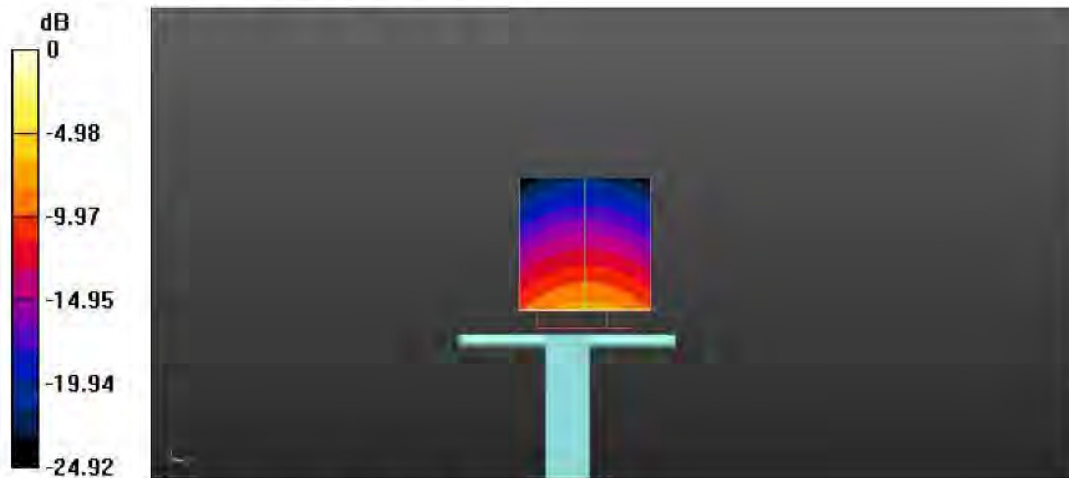

0 dB = 6.45 W/kg = 8.10 dBW/kg



4.7 D5GHzV2

4.7.1 Dipole 5 GHz Validation Measurement for Head Tissue

Dipole 5GHz; Type: D5GHzV2; Serial: D5GHzV2-SN: 1200

Date/Time: 10/26/2015

Communication System Band: D5GHz (5000.0 - 6000.0 MHz);

Frequency: 5200 MHz,

Frequency: 5600 MHz,

Frequency: 5800 MHz;

Duty Cycle: 1:1

Medium parameters used: $f = 5200$ MHz; $\sigma = 4.78$ S/m; $\epsilon_r = 36.52$; $\rho = 1000$ kg/m³ , Medium

parameters used: $f = 5600$ MHz; $\sigma = 5.20$ S/m; $\epsilon_r = 35.06$; $\rho = 1000$ kg/m³ , Medium parameters

used: $f = 5800$ MHz; $\sigma = 5.42$ S/m; $\epsilon_r = 34.40$; $\rho = 1000$ kg/m³

Phantom section: Flat Section

Ambient Temperature:22.0 Liquid Temperature:20.3

DASY5 Configuration:

- Probe: EX3DV4 - SN7340; ConvF(5.33, 5.33, 5.33); ConvF(4.70, 4.70, 4.70); ConvF(4.68, 4.68, 4.68);
- Sensor-Surface: 1.4mm (Mechanical Surface Detection)
- Electronics: DAE4 Sn1454;
- Phantom: SAM (30deg probe tilt) with CRP v5.0 on left 1859; Type: QD000P40CD; Serial: TP:1859
- Measurement SW: DASY52, Version 52.8 (8); SEMCAD X Version 14.6.10 (7331)

Dipole validation measurement for Head Tissue/Pin= 100mW ,dist=10mm,f=5200 MHz /Zoom Scan (7x7x21)/Cube 0: Measurement grid: dx=4mm, dy=4mm, dz=1.4mm

Reference Value = 45.80 V/m; Power Drift = 0.07 dB

Peak SAR (extrapolated) = 25.9 W/kg

SAR(1 g) = 8.22 W/kg; SAR(10 g) = 2.24 W/kg

Maximum value of SAR (measured) = 9.71 W/kg

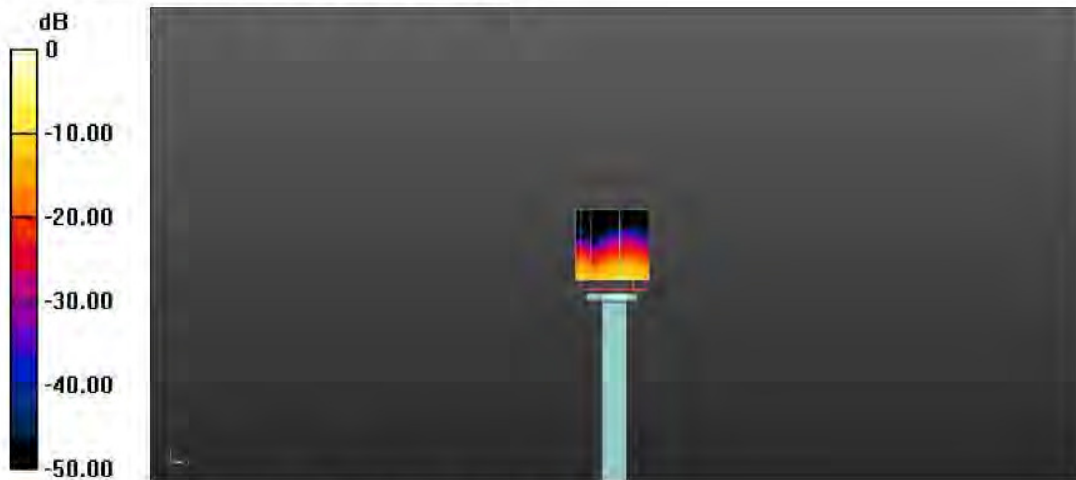

0 dB = 9.71 W/kg = 9.87 dBW/kg

**Dipole validation measurement for Head Tissue/Pin= 100mW ,dist=10mm,f=5600****MHz /Zoom Scan (7x7x21)/Cube 0:** Measurement grid: dx=4mm, dy=4mm, dz=1.4mm

Reference Value = 44.02 V/m; Power Drift = 0.17 dB

Peak SAR (extrapolated) = 28.3 W/kg

SAR(1 g) = 8.24 W/kg; SAR(10 g) = 2.29 W/kg

Maximum value of SAR (measured) = 9.45 W/kg

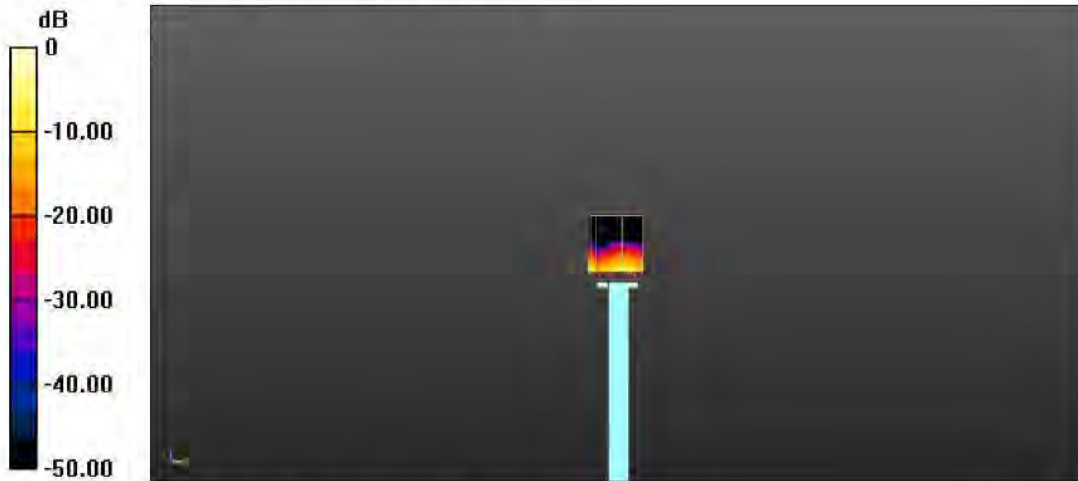

0 dB = 9.45 W/kg = 9.75 dBW/kg

Dipole Calibration for Head Tissue/Pin= 100mW ,dist=10mm,f=5800 MHz /Zoom**Scan (7x7x21)/Cube 0:** Measurement grid: dx=4mm, dy=4mm, dz=1.4mm

Reference Value = 39.70 V/m; Power Drift = 0.00 dB

Peak SAR (extrapolated) = 24.4 W/kg

SAR(1 g) = 7.28 W/kg; SAR(10 g) = 2.12 W/kg

Maximum value of SAR (measured) = 8.38 W/kg

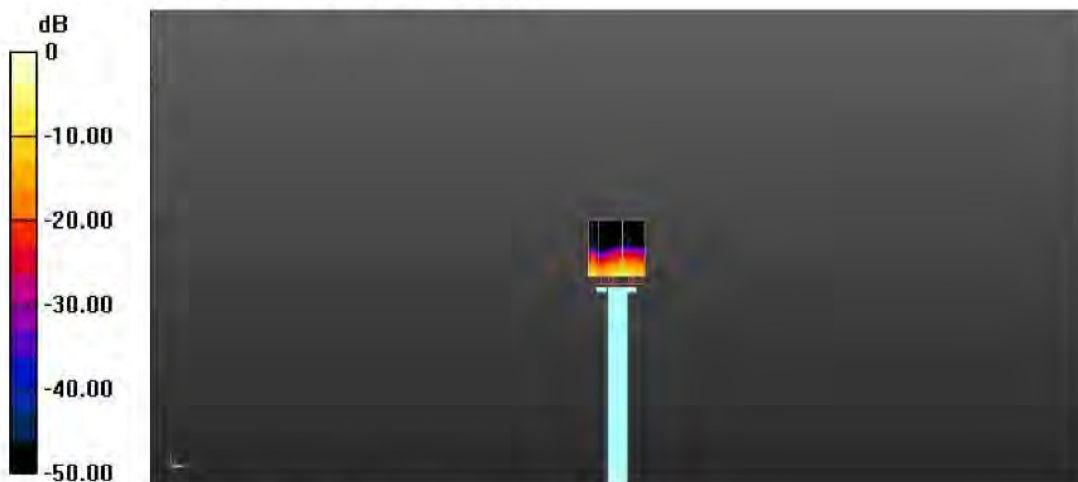

0 dB = 8.79 W/kg = 9.44 dBW/kg



4.7.2 Dipole 5 GHz Validation Measurement for Body Tissue

Dipole 5GHz; Type: D5GHzV2; Serial: D5GHzV2-SN: 1200

Date/Time: 10/26/2015

Communication System Band: D5GHz (5000.0 - 6000.0 MHz); Frequency: 5200 MHz; Frequency: 5600 MHz; Frequency: 5800 MHz; Duty Cycle: 1:1

Medium parameters used: $f = 5200$ MHz; $\sigma = 5.38$ S/m; $\epsilon_r = 48.74$; $\rho = 1000$ kg/m³, Medium parameters used: $f = 5600$ MHz; $\sigma = 5.72$ S/m; $\epsilon_r = 46.31$; $\rho = 1000$ kg/m³, Medium parameters used: $f = 5800$ MHz; $\sigma = 5.92$ S/m; $\epsilon_r = 46.06$; $\rho = 1000$ kg/m³

Phantom section: Flat Section

Ambient Temperature:22.3 Liquid Temperature:21.4

DASY5 Configuration:

- Probe: EX3DV4 - SN7340; ConvF(4.56, 4.56, 4.56);ConvF(3.98, 3.98, 3.98); ConvF(4.15, 4.15, 4.15);
- Sensor-Surface: 1.4mm (Mechanical Surface Detection)
- Electronics: DAE4 Sn1454;
- Phantom: SAM (30deg probe tilt) with CRP v5.0 on left 1859; Type: QD000P40CD; Serial: TP:1859
- Measurement SW: DASY52, Version 52.8 (8); SEMCAD X Version 14.6.10 (7331)

Dipole validation measurement for Body Tissue/Pin= 100mW ,dist=10mm,f=5200

MHz /Zoom Scan (7x7x21)/Cube 0: Measurement grid: dx=4mm, dy=4mm, dz=1.4mm

Reference Value = 45.58 V/m; Power Drift = 0.07 dB

Peak SAR (extrapolated) = 26.9 W/kg

SAR(1 g) = 8.32 W/kg; SAR(10 g) = 2.28 W/kg

Maximum value of SAR (measured) = 9.86 W/kg

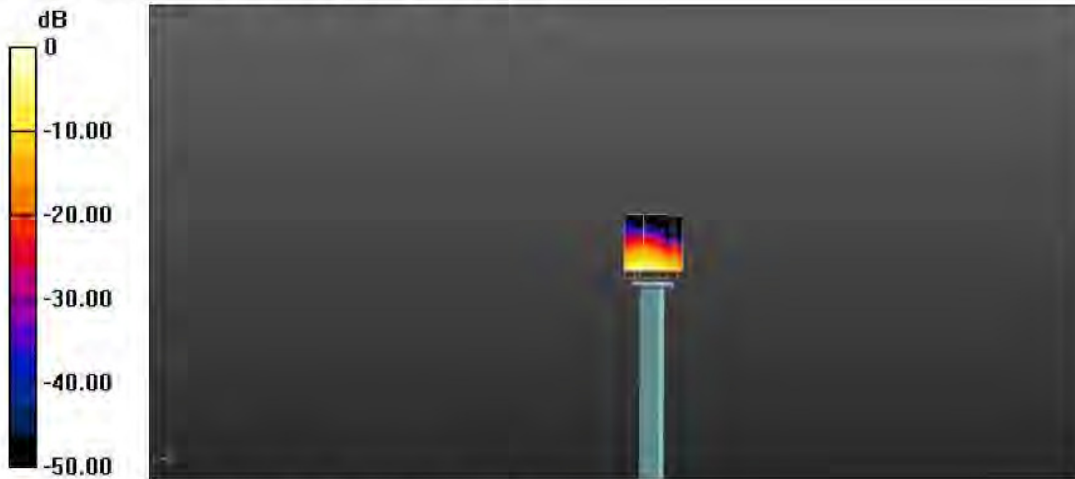

0 dB = 9.86 W/kg = 9.94 dBW/kg



Dipole validation measurement for Body Tissue/Pin= 100mW , dist=10mm,f=5600 MHz /Zoom Scan (7x7x21)/Cube 0:

Measurement grid: dx=4mm, dy=4mm, dz=1.4mm
Reference Value = 47.14 V/m; Power Drift = 0.17 dB
Peak SAR (extrapolated) = 35.1 W/kg
SAR(1 g) = 8.41 W/kg; SAR(10 g) = 2.33 W/kg
Maximum value of SAR (measured) = 10.3 W/kg



0 dB = 10.3 W/kg = 9.90 dBW/kg

Dipole validation measurement for Body Tissue/Pin= 100mW , dist=10mm,f=5800 MHz /Zoom Scan (7x7x21)/Cube 0:

Measurement grid: dx=4mm, dy=4mm, dz=1.4mm
Reference Value = 41.88 V/m; Power Drift = 0.06 dB
Peak SAR (extrapolated) = 28.9 W/kg
SAR(1 g) = 8.24 W/kg; SAR(10 g) = 2.3 W/kg
Maximum value of SAR (measured) = 9.33 W/kg



0 dB = 9.33 W/kg = 9.70 dBW/kg

--END OF REPORT--

F.5 2450MHz Dipole

**Calibration Laboratory of
Schmid & Partner
Engineering AG**
Zeughausstrasse 43, 8004 Zurich, Switzerland



S Schweizerischer Kalibrierdienst
C Service suisse d'étalonnage
S Servizio svizzero di taratura
S Swiss Calibration Service

Accredited by the Swiss Accreditation Service (SAS)
The Swiss Accreditation Service is one of the signatories to the EA
Multilateral Agreement for the recognition of calibration certificates

Accreditation No.: **SCS 108**

Client **Dgjeie (Vitec)**

Certificate No: **D2450V2-952_Nov14**

CALIBRATION CERTIFICATE																																															
Object	D2450V2 - SN: 952																																														
Calibration procedure(s)	QA CAL-05.v9 Calibration procedure for dipole validation kits above 700 MHz																																														
Calibration date:	November 27, 2014																																														
<p>This calibration certificate documents the traceability to national standards, which realize the physical units of measurements (SI). The measurements and the uncertainties with confidence probability are given on the following pages and are part of the certificate.</p> <p>All calibrations have been conducted in the closed laboratory facility: environment temperature (22 ± 3)°C and humidity < 70%.</p> <p>Calibration Equipment used (M&TE critical for calibration)</p> <table border="1"> <thead> <tr> <th>Primary Standards</th> <th>ID #</th> <th>Cal Date (Certificate No.)</th> <th>Scheduled Calibration</th> </tr> </thead> <tbody> <tr> <td>Power meter EPM-442A</td> <td>GB37480704</td> <td>07-Oct-14 (No. 217-02020)</td> <td>Oct-15</td> </tr> <tr> <td>Power sensor HP 8481A</td> <td>US37292783</td> <td>07-Oct-14 (No. 217-02020)</td> <td>Oct-15</td> </tr> <tr> <td>Power sensor HP 8481A</td> <td>MY41092317</td> <td>07-Oct-14 (No. 217-02021)</td> <td>Oct-15</td> </tr> <tr> <td>Reference 20 dB Attenuator</td> <td>SN: 5058 (20k)</td> <td>03-Apr-14 (No. 217-01918)</td> <td>Apr-15</td> </tr> <tr> <td>Type-N mismatch combination</td> <td>SN: 5047.2 / 06327</td> <td>03-Apr-14 (No. 217-01921)</td> <td>Apr-15</td> </tr> <tr> <td>Reference Probe ES3DV3</td> <td>SN: 3205</td> <td>30-Dec-13 (No. ES3-3205 Dec13)</td> <td>Dec-14</td> </tr> <tr> <td>DAE4</td> <td>SN: 601</td> <td>18-Aug-14 (No. DAE4-601_Aug14)</td> <td>Aug-15</td> </tr> </tbody> </table> <table border="1"> <thead> <tr> <th>Secondary Standards</th> <th>ID #</th> <th>Check Date (in house)</th> <th>Scheduled Check</th> </tr> </thead> <tbody> <tr> <td>RF generator R&S SMT-06</td> <td>100005</td> <td>04-Aug-99 (in house check Oct-13)</td> <td>In house check: Oct-16</td> </tr> <tr> <td>Network Analyzer HP 8753E</td> <td>US37390585 S4206</td> <td>18-Oct-01 (in house check Oct-14)</td> <td>In house check: Oct-15</td> </tr> </tbody> </table>				Primary Standards	ID #	Cal Date (Certificate No.)	Scheduled Calibration	Power meter EPM-442A	GB37480704	07-Oct-14 (No. 217-02020)	Oct-15	Power sensor HP 8481A	US37292783	07-Oct-14 (No. 217-02020)	Oct-15	Power sensor HP 8481A	MY41092317	07-Oct-14 (No. 217-02021)	Oct-15	Reference 20 dB Attenuator	SN: 5058 (20k)	03-Apr-14 (No. 217-01918)	Apr-15	Type-N mismatch combination	SN: 5047.2 / 06327	03-Apr-14 (No. 217-01921)	Apr-15	Reference Probe ES3DV3	SN: 3205	30-Dec-13 (No. ES3-3205 Dec13)	Dec-14	DAE4	SN: 601	18-Aug-14 (No. DAE4-601_Aug14)	Aug-15	Secondary Standards	ID #	Check Date (in house)	Scheduled Check	RF generator R&S SMT-06	100005	04-Aug-99 (in house check Oct-13)	In house check: Oct-16	Network Analyzer HP 8753E	US37390585 S4206	18-Oct-01 (in house check Oct-14)	In house check: Oct-15
Primary Standards	ID #	Cal Date (Certificate No.)	Scheduled Calibration																																												
Power meter EPM-442A	GB37480704	07-Oct-14 (No. 217-02020)	Oct-15																																												
Power sensor HP 8481A	US37292783	07-Oct-14 (No. 217-02020)	Oct-15																																												
Power sensor HP 8481A	MY41092317	07-Oct-14 (No. 217-02021)	Oct-15																																												
Reference 20 dB Attenuator	SN: 5058 (20k)	03-Apr-14 (No. 217-01918)	Apr-15																																												
Type-N mismatch combination	SN: 5047.2 / 06327	03-Apr-14 (No. 217-01921)	Apr-15																																												
Reference Probe ES3DV3	SN: 3205	30-Dec-13 (No. ES3-3205 Dec13)	Dec-14																																												
DAE4	SN: 601	18-Aug-14 (No. DAE4-601_Aug14)	Aug-15																																												
Secondary Standards	ID #	Check Date (in house)	Scheduled Check																																												
RF generator R&S SMT-06	100005	04-Aug-99 (in house check Oct-13)	In house check: Oct-16																																												
Network Analyzer HP 8753E	US37390585 S4206	18-Oct-01 (in house check Oct-14)	In house check: Oct-15																																												
Calibrated by:	Name Michael Weber	Function Laboratory Technician	Signature 																																												
Approved by:	Name Katja Pokovic	Function Technical Manager	Signature 																																												
			Issued: November 28, 2014																																												
This calibration certificate shall not be reproduced except in full without written approval of the laboratory.																																															

**Calibration Laboratory of
Schmid & Partner
Engineering AG**
Zeughausstrasse 43, 8004 Zurich, Switzerland



S Schweizerischer Kalibrierdienst
C Service suisse d'étalonnage
S Servizio svizzero di taratura
S Swiss Calibration Service

Accredited by the Swiss Accreditation Service (SAS)
The Swiss Accreditation Service is one of the signatories to the EA
Multilateral Agreement for the recognition of calibration certificates

Accreditation No.: **SCS 108**

Glossary:

TSL	tissue simulating liquid
ConvF	sensitivity in TSL / NORM x,y,z
N/A	not applicable or not measured

Calibration is Performed According to the Following Standards:

- IEEE Std 1528-2013, "IEEE Recommended Practice for Determining the Peak Spatial-Averaged Specific Absorption Rate (SAR) in the Human Head from Wireless Communications Devices: Measurement Techniques", June 2013
- IEC 62209-1, "Procedure to measure the Specific Absorption Rate (SAR) for hand-held devices used in close proximity to the ear (frequency range of 300 MHz to 3 GHz)", February 2005
- KDB 865664, "SAR Measurement Requirements for 100 MHz to 6 GHz"

Additional Documentation:

- DASY4/5 System Handbook

Methods Applied and Interpretation of Parameters:

- Measurement Conditions:* Further details are available from the Validation Report at the end of the certificate. All figures stated in the certificate are valid at the frequency indicated.
- Antenna Parameters with TSL:* The dipole is mounted with the spacer to position its feed point exactly below the center marking of the flat phantom section, with the arms oriented parallel to the body axis.
- Feed Point Impedance and Return Loss:* These parameters are measured with the dipole positioned under the liquid filled phantom. The impedance stated is transformed from the measurement at the SMA connector to the feed point. The Return Loss ensures low reflected power. No uncertainty required.
- Electrical Delay:* One-way delay between the SMA connector and the antenna feed point. No uncertainty required.
- SAR measured:* SAR measured at the stated antenna input power.
- SAR normalized:* SAR as measured, normalized to an input power of 1 W at the antenna connector.
- SAR for nominal TSL parameters:* The measured TSL parameters are used to calculate the nominal SAR result.

The reported uncertainty of measurement is stated as the standard uncertainty of measurement multiplied by the coverage factor $k=2$, which for a normal distribution corresponds to a coverage probability of approximately 95%.

Measurement Conditions

DASY system configuration, as far as not given on page 1.

DASY Version	DASY5	V52.8.8
Extrapolation	Advanced Extrapolation	
Phantom	Modular Flat Phantom	
Distance Dipole Center - TSL	10 mm	with Spacer
Zoom Scan Resolution	dx, dy, dz = 5 mm	
Frequency	2450 MHz ± 1 MHz	

Head TSL parameters

The following parameters and calculations were applied.

	Temperature	Permittivity	Conductivity
Nominal Head TSL parameters	22.0 °C	39.2	1.80 mho/m
Measured Head TSL parameters	(22.0 ± 0.2) °C	39.0 ± 6 %	1.86 mho/m ± 6 %
Head TSL temperature change during test	< 0.5 °C	----	----

SAR result with Head TSL

SAR averaged over 1 cm ³ (1 g) of Head TSL	Condition	
SAR measured	250 mW input power	13.3 W/kg
SAR for nominal Head TSL parameters	normalized to 1W	52.3 W/kg ± 17.0 % (k=2)

SAR averaged over 10 cm ³ (10 g) of Head TSL	condition	
SAR measured	250 mW input power	6.17 W/kg
SAR for nominal Head TSL parameters	normalized to 1W	24.5 W/kg ± 16.5 % (k=2)

Body TSL parameters

The following parameters and calculations were applied.

	Temperature	Permittivity	Conductivity
Nominal Body TSL parameters	22.0 °C	52.7	1.95 mho/m
Measured Body TSL parameters	(22.0 ± 0.2) °C	50.9 ± 6 %	2.03 mho/m ± 6 %
Body TSL temperature change during test	< 0.5 °C	----	----

SAR result with Body TSL

SAR averaged over 1 cm ³ (1 g) of Body TSL	Condition	
SAR measured	250 mW input power	13.0 W/kg
SAR for nominal Body TSL parameters	normalized to 1W	50.6 W/kg ± 17.0 % (k=2)

SAR averaged over 10 cm ³ (10 g) of Body TSL	condition	
SAR measured	250 mW input power	6.02 W/kg
SAR for nominal Body TSL parameters	normalized to 1W	23.7 W/kg ± 16.5 % (k=2)

Appendix (Additional assessments outside the scope of SCS108)**Antenna Parameters with Head TSL**

Impedance, transformed to feed point	53.4 Ω + 3.0 j Ω
Return Loss	- 27.2 dB

Antenna Parameters with Body TSL

Impedance, transformed to feed point	50.7 Ω + 5.1 j Ω
Return Loss	- 25.8 dB

General Antenna Parameters and Design

Electrical Delay (one direction)	1.161 ns
----------------------------------	----------

After long term use with 100W radiated power, only a slight warming of the dipole near the feedpoint can be measured.

The dipole is made of standard semirigid coaxial cable. The center conductor of the feeding line is directly connected to the second arm of the dipole. The antenna is therefore short-circuited for DC-signals. On some of the dipoles, small end caps are added to the dipole arms in order to improve matching when loaded according to the position as explained in the "Measurement Conditions" paragraph. The SAR data are not affected by this change. The overall dipole length is still according to the Standard.

No excessive force must be applied to the dipole arms, because they might bend or the soldered connections near the feedpoint may be damaged.

Additional EUT Data

Manufactured by	SPEAG
Manufactured on	August 05, 2014

DASY5 Validation Report for Head TSL

Date: 27.11.2014

Test Laboratory: SPEAG, Zurich, Switzerland

DUT: Dipole 2450 MHz; Type: D2450V2; Serial: D2450V2 - SN: 952

Communication System: UID 0 - CW; Frequency: 2450 MHz

Medium parameters used: $f = 2450$ MHz; $\sigma = 1.86$ S/m; $\epsilon_r = 39$; $\rho = 1000$ kg/m³

Phantom section: Flat Section

Measurement Standard: DASY5 (IEEE/IEC/ANSI C63.19-2011)

DASY52 Configuration:

- Probe: ES3DV3 - SN3205; ConvF(4.53, 4.53, 4.53); Calibrated: 30.12.2013;
- Sensor-Surface: 3mm (Mechanical Surface Detection)
- Electronics: DAE4 Sn601; Calibrated: 18.08.2014
- Phantom: Flat Phantom 5.0 (front); Type: QD000P50AA; Serial: 1001
- DASY52 52.8.8(1222); SEMCAD X 14.6.10(7331)

Dipole Calibration for Head Tissue/Pin=250 mW, d=10mm/Zoom Scan (7x7x7)/Cube 0:

Measurement grid: dx=5mm, dy=5mm, dz=5mm

Reference Value = 100.8 V/m; Power Drift = 0.00 dB

Peak SAR (extrapolated) = 27.5 W/kg

SAR(1 g) = 13.3 W/kg; SAR(10 g) = 6.17 W/kg

Maximum value of SAR (measured) = 17.5 W/kg

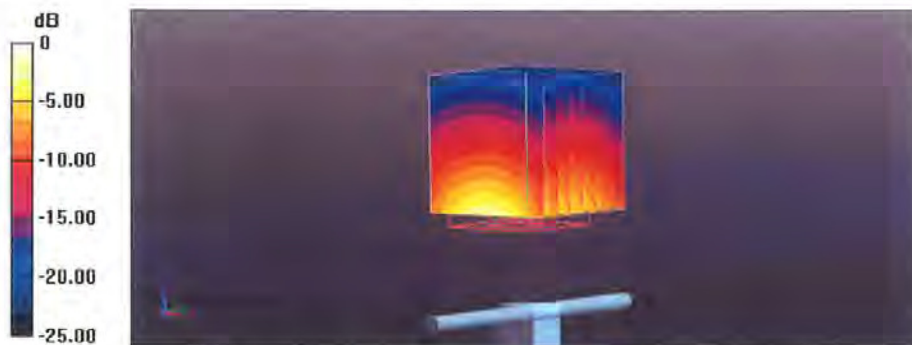

0 dB = 17.5 W/kg = 12.43 dBW/kg

Impedance Measurement Plot for Head TSL

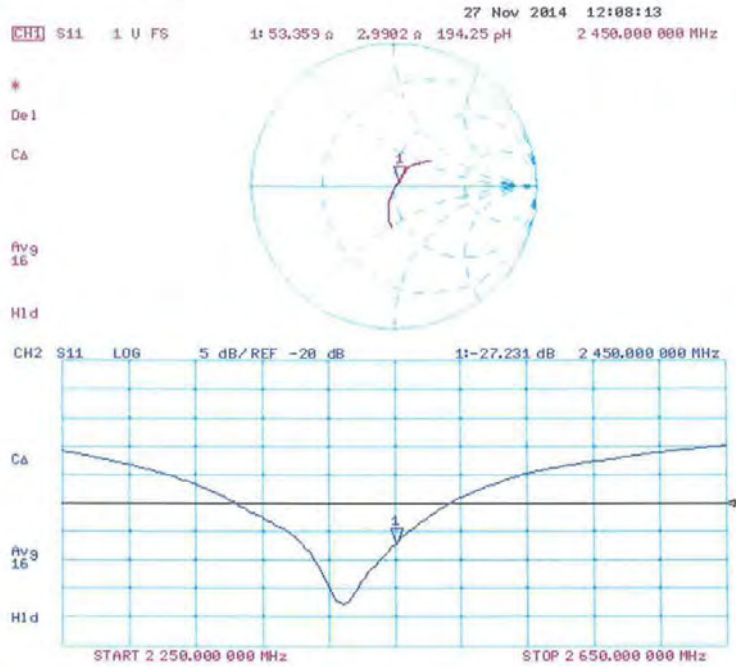

DASY5 Validation Report for Body TSL

Date: 27.11.2014

Test Laboratory: SPEAG, Zurich, Switzerland

DUT: Dipole 2450 MHz; Type: D2450V2; Serial: D2450V2 - SN: 952

Communication System: UID 0 - CW; Frequency: 2450 MHz

Medium parameters used: $f = 2450$ MHz; $\sigma = 2.03$ S/m; $\epsilon_r = 50.9$; $\rho = 1000$ kg/m³

Phantom section: Flat Section

Measurement Standard: DASY5 (IEEE/IEC/ANSI C63.19-2011)

DASY52 Configuration:

- Probe: ES3DV3 - SN3205; ConvF(4.35, 4.35, 4.35); Calibrated: 30.12.2013;
- Sensor-Surface: 3mm (Mechanical Surface Detection)
- Electronics: DAE4 Sn601; Calibrated: 18.08.2014
- Phantom: Flat Phantom 5.0 (back); Type: QD000P50AA; Serial: 1002
- DASY52 52.8.8(1222); SEMCAD X 14.6.10(7331)

Dipole Calibration for Body Tissue/Pin=250 mW, d=10mm/Zoom Scan (7x7x7)/Cube 0:

Measurement grid: dx=5mm, dy=5mm, dz=5mm

Reference Value = 95.25 V/m; Power Drift = -0.01 dB

Peak SAR (extrapolated) = 27.2 W/kg

SAR(1 g) = 13 W/kg; SAR(10 g) = 6.02 W/kg

Maximum value of SAR (measured) = 17.3 W/kg



Impedance Measurement Plot for Body TSL

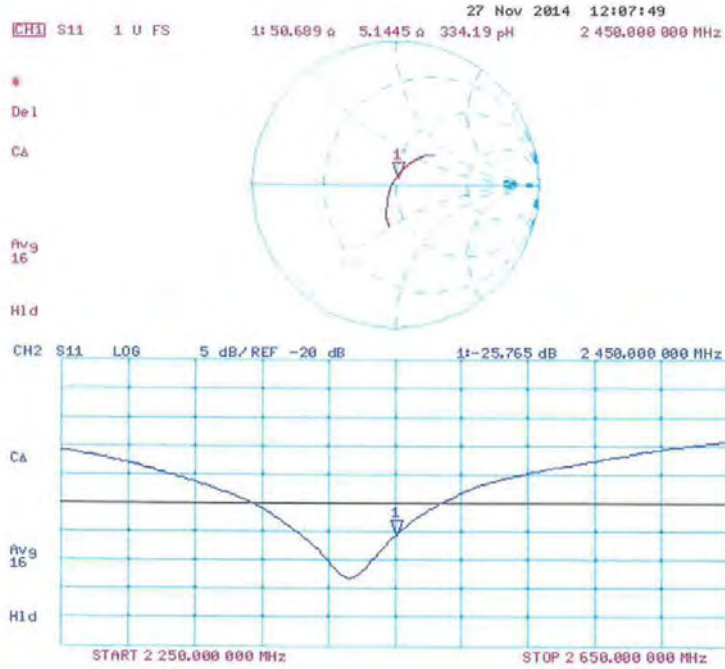

--End of Report--