

RF Test Report

Applicant : Winmate Inc.
Product Name : Rugged Tablet PC
Trade Name : Winmate
Model Number : M140TG, M140TGXXXXXXXXXXXX ("X"= A~Z,a~z,0~9,"-" Blank or Slash for marketing purpose only, no impact safety related constructions or critical components)
Applicable Standard : FCC 47 CFR PART 15 SUBPART C
 ANSI C63.10:2013
Received Date : Jul. 25, 2022
Test Period : Aug. 10 ~ Oct. 07, 2022
Issued Date : Oct. 13, 2022

Issued by

Eurofins E&E Wireless Taiwan Co., Ltd.
 No. 140-1, Changan Street, Bade District,
 Taoyuan City 334025, Taiwan (R.O.C.)
 Tel : +886-3-2710188 / Fax : +886-3-2710190



Taiwan Accreditation Foundation accreditation number: 1330
 Frequency Range: 9 kHz to 325 GHz (Bade test site)
 Frequency Range: 9 kHz to 40 GHz (Wugu test site)
 Test Firm MRA designation number: TW0010

Note:

1. The test results are valid only for samples provided by customers and under the test conditions described in this report.
2. This report shall not be reproduced except in full, without the written approval of Eurofins E&E Wireless Taiwan Co., Ltd.
3. The relevant information is provided by customers in this test report. According to the correctness, appropriateness or completeness of the information provided by the customer, if there is any doubt or error in the information which affects the validity of the test results, the laboratory does not take the responsibility.

Revision History

Rev.	Issued Date	Revisions	Revised By
00	Oct. 13, 2022	Initial Issue	Abby Huang

Verification of Compliance

Applicant : Winmate Inc.

Product Name : Rugged Tablet PC

Trade Name : Winmate

Model Number : M140TG, M140TGXXXXXXXXXXXX ("X"= A~Z,a~z,0~9,"-"
Blank or Slash for marketing purpose only, no impact safety
related constructions or critical components)

FCC ID : PX9M140TG

Applicable Standard : FCC 47 CFR PART 15 SUBPART C
ANSI C63.10:2013

Test Result : Complied

Performing Lab. : Eurofins E&E Wireless Taiwan Co., Ltd.
No. 140-1, Changan Street, Bade District,
Taoyuan City 334025, Taiwan (R.O.C.)
Tel : +886-3-2710188 / Fax : +886-3-2710190
Taiwan Accreditation Foundation accreditation number: 1330



Eurofins E&E Wireless Taiwan Co., Ltd. tested the above equipment in accordance with the requirements set forth in the above standards. All indications of Pass/Fail in this report are opinions expressed by Eurofins E&E Wireless Taiwan Co., Ltd. based on interpretations and/or observations of test results. The test results show that the equipment tested is capable of demonstrating compliance with the requirements as documented in this report.

Approved By : _____

TABLE OF CONTENTS

1	General Information	5
	1.1. Summary of Test Result.....	5
	1.2. Measurement Uncertainty.....	6
2	EUT Description	7
3	Test Methodology	8
	3.1. Mode of Operation	8
	3.2. EUT Test Step.....	8
	3.3. Configuration of Test System Details	9
	3.4. Test Instruments	11
	3.5. Test Site Environment.....	12
4	Measurement Procedure	13
	4.1. Maximum Conducted Output Power Measurement	13
	4.2. AC Power Line Conducted Emission Measurement	14
	4.3. Radiated Emission Measurement	16
	4.4. 20 dB RF Bandwidth Measurement	19
	4.5. Carrier Frequency Separation Measurement.....	20
	4.6. Number of Hopping Measurement.....	21
	4.7. Time of Occupancy (Dwell Time) Measurement	22
	4.8. Out of Band Conducted Emissions Measurement	23
	4.9. Antenna Measurement	23
5	Test Results	24
	5.1. Conducted Emission	24
	5.2. Conducted Test Results	26
	5.3. Radiated Emission Measurement.....	47

Appendix A. Test Setup Photographs

1 General Information

1.1. Summary of Test Result

Standard	Item	Result	Remark
15.207	AC Power Conducted Emission	PASS	-----
15.203	Antenna Requirement	PASS	-----
15.247(b)(1)	Max. Output Power	PASS	-----
15.247(d)	Transmitter Radiated Emissions	PASS	-----
15.247(a)(1)	20 dB RF Bandwidth	PASS	-----
15.247(a)(1)	Carrier Frequency Separation	PASS	-----
15.247(a)(1)(iii)	Number of Hopping	PASS	-----
15.247(a)(1)(iii)	Time of Occupancy (Dwell Time)	PASS	-----
15.247(d)	Out of Band Conducted Spurious Emission	PASS	-----

Decision Rule

- Uncertainty is not included.
- Uncertainty is included.

Standard	Description
CFR47, Part 15, Subpart C	Intentional Radiators
ANSI C63. 10: 2013	American National Standard of Procedures for Compliance Testing of Unlicensed Wireless Devices
DA 00-705	Filing and Measurement Guidelines for Frequency Hopping Spread Spectrum Systems

1.2. Measurement Uncertainty

Test Item	Frequency Range	Uncertainty
Conducted Emission	150 kHz ~ 30 MHz	2.7 dB
Radiated Emission	9 kHz ~ 30 MHz	2.2 dB
	30 MHz ~ 1000 MHz	5.1 dB
	1000 MHz ~ 18000 MHz	5.2 dB
	18000 MHz ~ 26500 MHz	4.6 dB
	26500 MHz ~ 40000 MHz	4.6 dB
Conducted Output Power	1.1 dB	
RF Bandwidth	4.7 %	
Power Spectral Density	1.1 dB	

2 EUT Description

Applicant	Winmate Inc. 9F, No.111-6, Shing-De Rd., San-Chung District, New Taipei City 241, Taiwan		
Product Name	Rugged Tablet PC		
Trade Name	Winmate		
Model Number	M140TG, M140TGXXXXXXXXXXXXX ("X"= A~Z,a~z,0~9,"-" Blank or Slash for marketing purpose only, no impact safety related constructions or critical components)		
Model Different Description	All models are electrically identical, different model names are for marketing purpose.		
FCC ID	PX9M140TG		
Frequency Range	2402 ~ 2480 MHz		
Modulation Type	GFSK for 1 Mbps		
	$\pi/4$ -DQPSK for 2 Mbps		
	8DPSK for 3 Mbps		
Operate Temp. Range	0 ~ +35 °C		
EUT Power Rating	DC 19 V, 3.42 A		
Antenna information	Type	Max. Gain (dBi)	
	Dipole	1.41	
Max. RF Output Power	GFSK for 1 Mbps	0.00962	W
	$\pi/4$ -DQPSK for 2 Mbps	0.00708	W
	8DPSK for 3 Mbps	0.00735	W

3 Test Methodology

3.1. Mode of Operation

In the test report use EUT model: M140TG to operate testing.

Decision of Test ATL has verified the construction and function in typical operation. All the test modes were carried out with the EUT in normal operation, which was shown in this test report and defined as:

Pre-Test Mode
Mode 1: Transmit Mode
Mode 2: BR, GFSK Continuous TX Mode
Mode 3: EDR, $\pi/4$ -DQPSK Continuous TX Mode
Mode 4: EDR, 8DPSK Continuous TX Mode

After verification, all tests were carried out with the worst case test modes.

By preliminary testing and verifying three axis (X, Y and Z) position of EUT transmitted status, it was found that "X axis" position was the worst, then the final test was executed the worst condition and test data were recorded in this report.

Final-Test Mode
Mode 1: Transmit Mode
Mode 2: BR, GFSK Continuous TX Mode
Mode 4: EDR, 8DPSK Continuous TX Mode

Description of Test Modes

Preliminary tests were performed in different modulation to find the worst case. The modulation has shown the worst-case in section 4.1. Investigation has been done on all the possible configurations for searching the worst cases.

3.2. EUT Test Step

1	Setup the EUT shown on "Configuration of Test System Details."
2	Turn on the power of all equipment.
3	Turn on TX function
4	EUT run test program.

3.3. Configuration of Test System Details

Conducted Emission

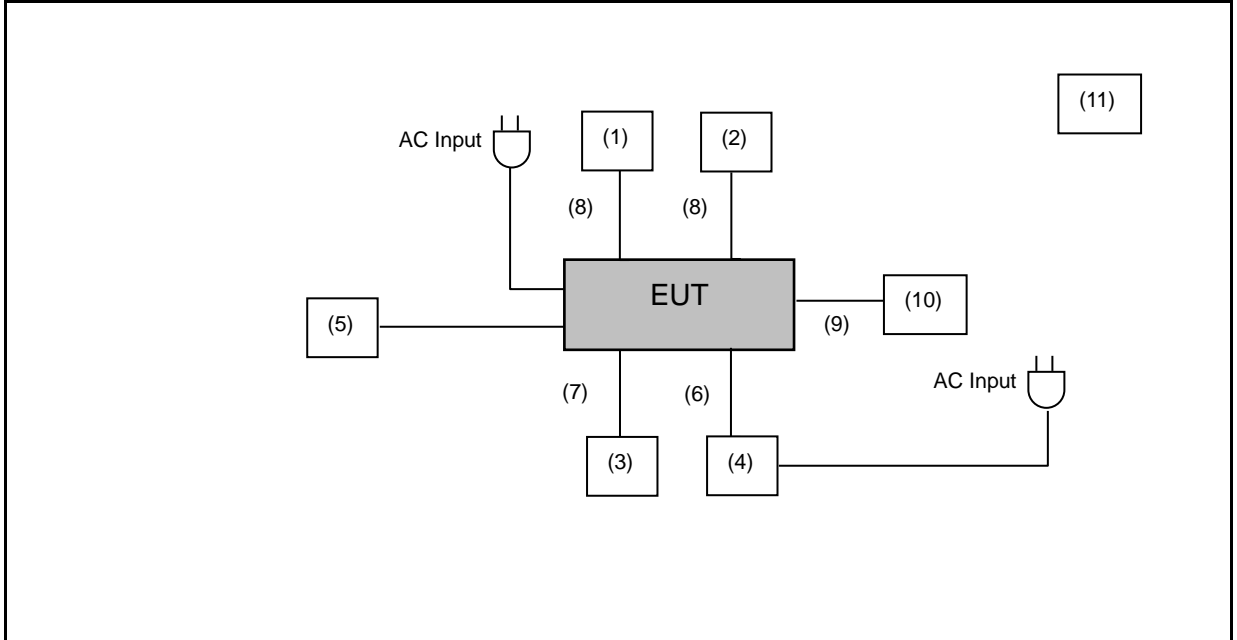

Radiated Emission (Below 1G / Above 1G)

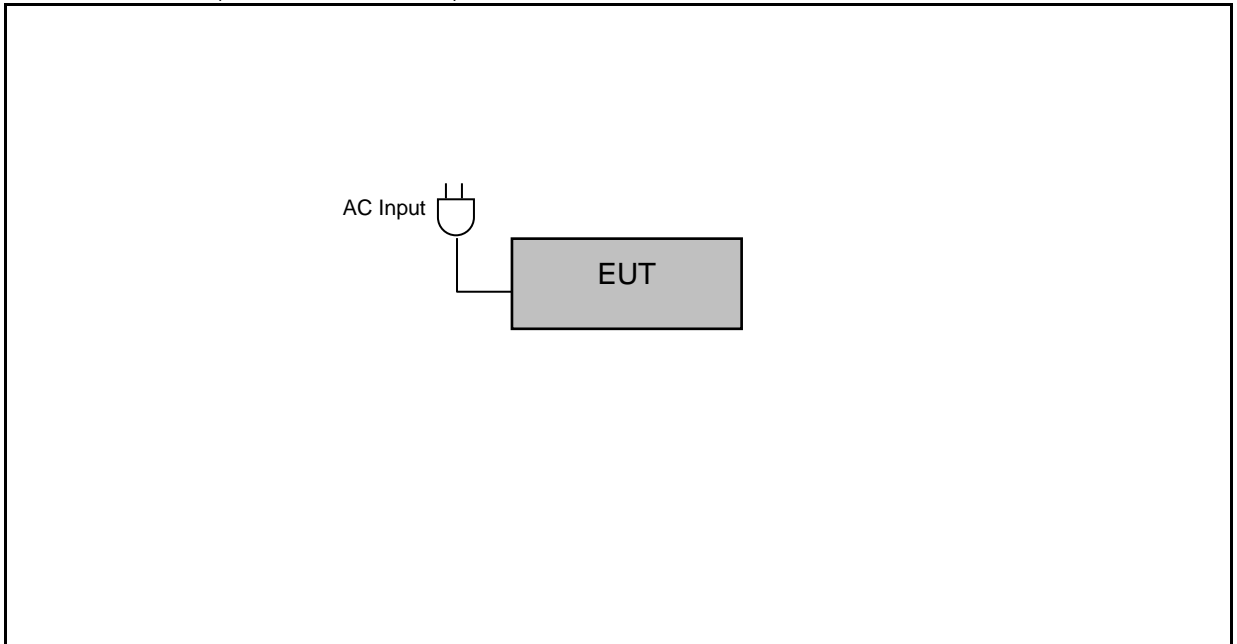

	Product	Manufacturer	Model Number	Power Cord
(1)	External Hard Drive	Transcend	TS1TSJ25A3K	---
(2)	External Hard Drive	Transcend	TS1TSJ25A3K	---
(3)	External Hard Drive	Transcend	TS1TSJ25A3K	---
(4)	LCD MONITOR	ASUS	MX27U	---
(5)	Earphone	YUJI	Y201	---
(6)	HDMI Cable	BENEVO	BHDMINI100	---
(7)	USB Cable	UGREEN	20103	---
(8)	USB Cable	Transcend	TS1TSJ25A3K	---
(9)	LAN Cable	TATUNG	CAT5E	---
(10)	Access Point	NETGEAR	R7800	---
(11)	Portable Bluetooth Speaker	Harman/kardon	HK NEO	---

3.4. Test Instruments

For Conducted Emission

Test Period: Aug. 17 ~ Oct. 07, 2022

Testing Engineer: Amber Cheng

Use	Equipment	Manufacturer	Model Number	Serial Number	Cal. Date	Cal. Period
<input checked="" type="checkbox"/>	Test Receiver	R&S	ESCI	100367	May 19, 2022	1 year
<input checked="" type="checkbox"/>	LISN	R&S	ENV216	101040	Apr. 06, 2022	1 year
<input checked="" type="checkbox"/>	LISN	R&S	ENV216	101140	Jan. 25, 2022	1 year
<input checked="" type="checkbox"/>	RF Cable	Woken	00100D1380194M	TE-02-03	May 27, 2022	1 year
<input checked="" type="checkbox"/>	Software	EZ EMC	1.1.4.3	N/A	N.C.R.	---

For Radiated Emissions

Test Period: Aug. 10 ~ Aug. 11, 2022

Testing Engineer: Eason Lee, Jayson Hsieh, Ricky Liu

Radiation test sites		Semi Anechoic Room				
Use	Equipment	Manufacturer	Model Number	Serial Number	Cal. Date	Cal. Period
<input checked="" type="checkbox"/>	Spectrum Analyzer (10 Hz~44 GHz)	Keysight	N9010A	MY52221312	Jan. 13, 2022	1 year
<input checked="" type="checkbox"/>	Amplifier (10 kHz~3 GHz)	Agilent	EMC001330	980862	Nov. 29, 2022	1 year
<input checked="" type="checkbox"/>	Pre Amplifier (1~26.5 GHz)	Agilent	8449B	3008A02455	Jul. 12, 2021 Jul. 07, 2022	1 year
<input checked="" type="checkbox"/>	Trilog Broadband Antenna (30 MHz~1 GHz)	Schwarzbeck Mess-Elektronik	VULB9168	416	Nov. 17, 2021	1 year
<input checked="" type="checkbox"/>	Broadband Horn Antenna (1 GHz~18 GHz)	Schwarzbeck Mess-Elektronik	9120D	9120D-550	Aug. 24, 2021	1 year
<input checked="" type="checkbox"/>	Broadband Horn Antenna (18 GHz~40 GHz)	Schwarzbeck Mess-Elektronik	9170	9170-320	Aug. 24, 2021	1 year
<input checked="" type="checkbox"/>	Microwave Cable	EMCI	EMC104-SM-SM-13000	170814	Feb. 18, 2022	1 year
<input checked="" type="checkbox"/>	Microwave Cable	EMCI	EMCCFD400-NM-NM-6000	210902	Feb. 18, 2022	1 year
<input checked="" type="checkbox"/>	Microwave Cable	SUHNER	suflex104	313229/4	Feb. 18, 2022	1 year
<input checked="" type="checkbox"/>	Software	EZ EMC	1.1.4.4	N/A	N.C.R.	---

Note: N.C.R. = No Calibration Request.

For Conducted

Test Period: Aug. 15, 2022

Testing Engineer: Brian Lin

Use	Equipment	Manufacturer	Model Number	Serial Number	Cal. Date	Cal. Period
<input checked="" type="checkbox"/>	Power Sensor	Agilent	N1921A	MY45241957	Dec. 06, 2021	1 year
<input checked="" type="checkbox"/>	Power Meter	Agilent	N1911A	MY45101619	Dec. 06, 2021	1 year
<input checked="" type="checkbox"/>	Spectrum Analyzer (10 Hz~26.5 GHz)	Keysight	N9010B	MY59071418	Mar. 16, 2022	1 year

Note: N.C.R. = No Calibration Request.

3.5. Test Site Environment

Items	Required (IEC 60068-1)	Actual
Temperature (°C)	15-35	20-30
Humidity (%RH)	25-75	45-75

4 Measurement Procedure

4.1. Maximum Conducted Output Power Measurement

- **Limit**

For frequency hopping systems operating in the 2400–2483.5 MHz band employing at least 75 non-overlapping hopping channels < 0.125 watt.

- **Test Setup**

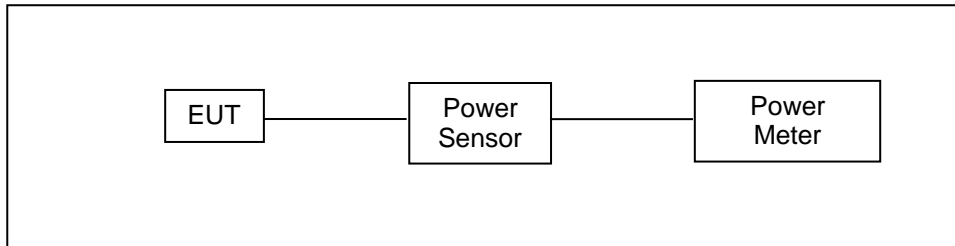

- **Test Procedure**

Testing must be done according to this procedure, FCC Public Notice DA 00-705 - Filing and Measurement Guidelines for Frequency Hopping Spread Spectrum Systems. This is the only method recognized by the FCC. The tests below are run with the EUT's transmitter set at high power in TX mode. The EUT is needed to force selection of output power level and channel number. While testing, EUT was set to transmit continuously. Remove the Subjective device's antenna and connect the RF output port to power sensor. The maximum peak output power shall not exceed 1 watt.

Use a direct connection between the antenna port of transmitter and the power sensor, for prevent the power sensor input attenuation 40-50 dB. Set the RBW Bandwidth of the emission or use a channel power meter mode. For antennas with gains of 6 dBi or less, maximum allowed transmitter output is 1 watt (+30 dBm). For antennas with gains greater than 6 dBi, transmitter output level must be decreased by an amount equal to (GAIN - 6)/3 dBm. The antenna port of the EUT was connected to the input of a power sensor. Power was read directly and cable loss correction was added to the reading to obtain power at the EUT antenna terminals.

4.2. AC Power Line Conducted Emission Measurement

■ Limit

Frequency (MHz)	Quasi-peak	Average
0.15 - 0.5	66 to 56	56 to 46
0.50 - 5.0	56	46
5.0 - 30.0	60	50

■ Test Setup

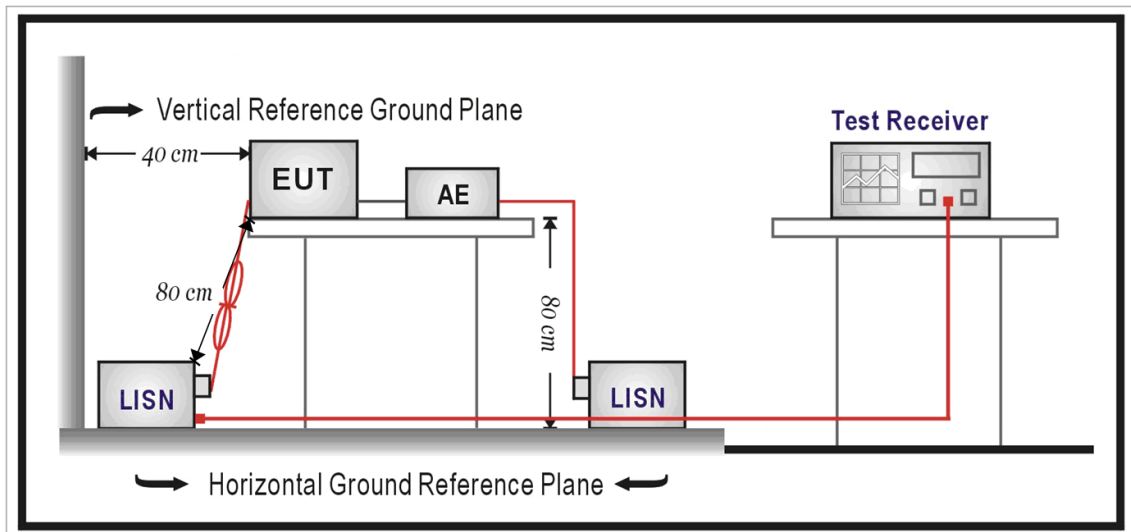

■ Test Procedure

The EUT and simulators are connected to the main power through a line impedance stabilization network (L.I.S.N.). This provides a $50 \Omega // 50 \mu\text{H}$ coupling impedance for the measuring equipment. The peripheral devices are also connected to the main power through a LISN that provides a $50 \Omega // 50 \mu\text{H}$ coupling impedance with 50 ohm termination.

Tabletop device shall be placed on a non-conducting platform, of nominal size 1 m by 1.5 m, raised 80 cm above the reference ground plane. The wall of screened room shall be located 40 cm to the rear of the EUT. Other surfaces of tabletop or floor standing EUT shall be at least 80 cm from any other ground conducting surface including one or more LISNs. For floor-standing device shall be placed under the EUT with a 12 mm insulating material.

Conducted emissions were investigated over the frequency range from 0.15 MHz to 30 MHz using a resolution bandwidth of 9 kHz. The equipment under test (EUT) shall be meet the limits in section 4.1, as applicable, including the average limit and the quasi-peak limit when using respectively, an average detector and quasi-peak detector measured in accordance with the methods described of related standard. When all of peak value were complied with quasi-peak and average limit from 150 kHz to 30 MHz then quasi-peak and average measurement was unnecessary.

The AMN shall be placed 0.8 m from the boundary of the unit under test and bonded to a ground reference plane for AMNs mounted on top of the ground reference plane. This distance is between the closest points of the AMN and the EUT. All other units of the EUT and associated equipment shall be at least 0.8 m from the AMN. If the mains power cable is longer than 1 m then the cable shall be folded back and forth at the centre of the lead to form a bundle no longer than 0.4 m. All of interconnecting cables that hang closer than 40 cm to the ground plane shall be folded back and forth in the center forming a bundle 30 cm to 40 cm long. All of EUT and AE shall be separate place more than 0.1 m. All 50Ω ports of the LISN shall be resistively terminated into 50Ω loads when not connected to the measuring instrument.

If the reading of the measuring receiver shows fluctuations close to the limit, the reading shall be observed for at least 15 s at each measurement frequency; the higher reading shall be recorded with the exception of any brief isolated high reading which shall be ignored.

4.3. Radiated Emission Measurement

■ **Limit**

According to §15.209(a), except as provided elsewhere in this subpart, the emissions from an intentional radiator shall not exceed the field strength levels specified in the following table:

Frequency (MHz)	Field Strength ($\mu\text{V}/\text{m}$ at meter)	Measurement Distance (meters)
0.009 – 0.490	2400 / F (kHz)	300
0.490 – 1.705	24000 / F (kHz)	30
1.705 – 30.0	30	30
30 - 88	100**	3
88-216	150**	3
216-960	200**	3
Above 960	500	3

** Except as provided in paragraph (g), fundamental emissions from intentional radiators operating under this Section shall not be located in the frequency bands 54-72 MHz, 76-88 MHz, 174-216 MHz or 470-806 MHz. However, operation within these frequency bands is permitted under other sections of this Part, e.g., Sections 15.231 and 15.241.

■ **Setup**

9 kHz ~ 30 MHz

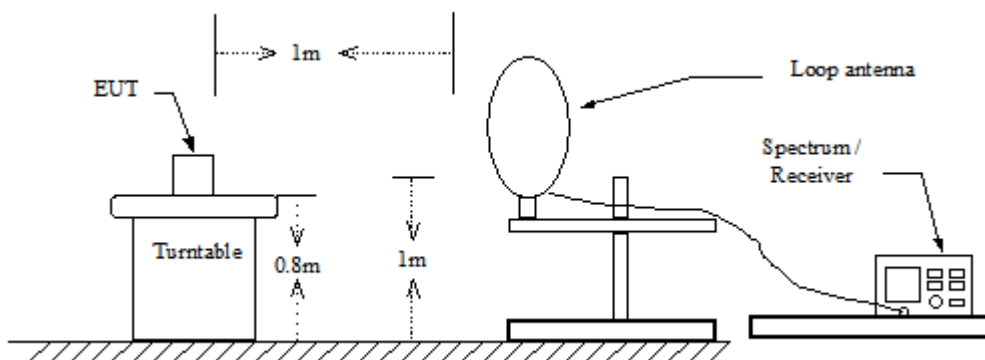

Below 1 GHz

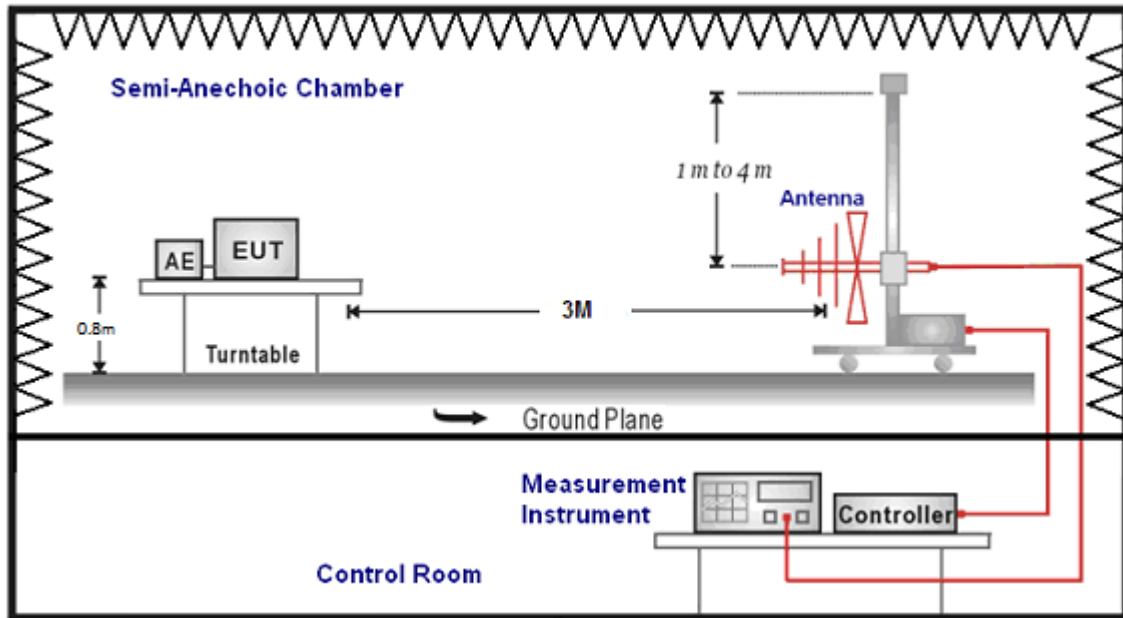

Above 1 GHz

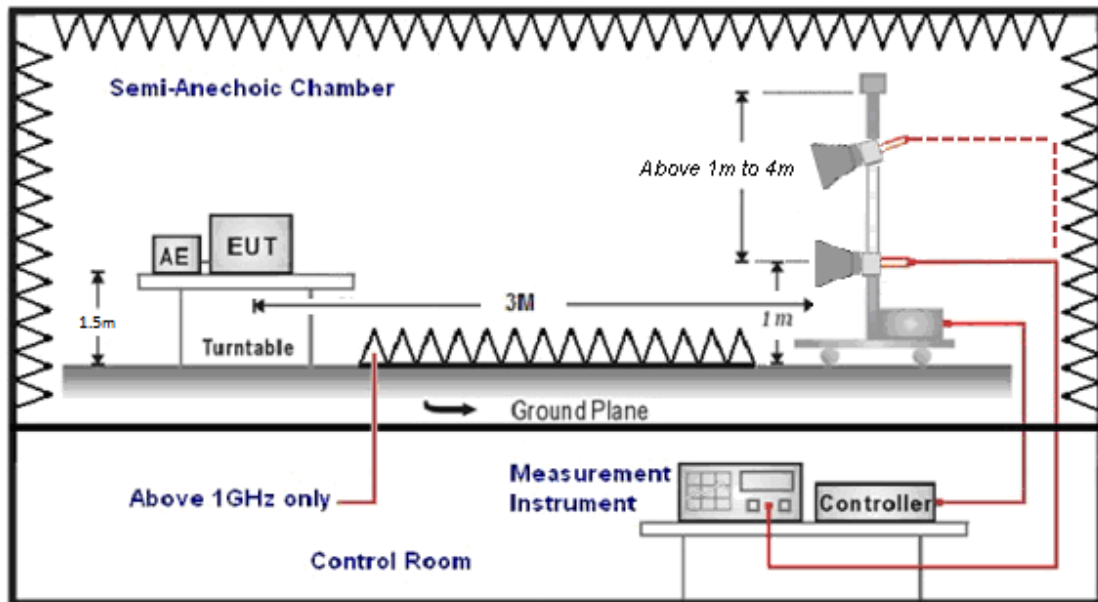

■ **Test Procedure**

Final radiation measurements were made on a three-meter, Semi Anechoic Chamber. The EUT system was placed on a nonconductive turntable which is 0.8 or 1.5 meters height, top surface 1.0 x 1.5 meter. The spectrum was examined from 250 MHz to 2.5 GHz in order to cover the whole spectrum below 10th harmonic which could generate from the EUT. During the test, EUT was set to transmit continuously & Measurements spectrum range from 9 kHz to 26.5 GHz is investigated.

For measurements below 1 GHz the resolution bandwidth is set to 100 kHz for peak detection measurements or 120 kHz for quasi-peak detection measurements. Peak detection is used unless otherwise noted as quasi-peak.

For measurements above 1 GHz the resolution bandwidth is set to 1 MHz, and then the video bandwidth is set to 3 MHz for peak measurements and 10 Hz for average measurements when Duty cycle >98 % / 1/T for average measurements when Duty cycle <98 %. A nonconductive material surrounded the EUT to supporting the EUT for standing on three orthogonal planes. At each condition, the EUT was rotated 360 degrees, and the antenna was raised and lowered from one to four meters to find the maximum emission levels. Measurements were taken using both horizontal and vertical antenna polarization.

SCHWARZBECK MESS-ELEKTRONIK Biconilog Antenna at 3 Meter and the SCHWARZBECK Double Ridged Guide Antenna was used in frequencies 1 – 26.5 GHz at a distance of 1 meter. All test results were extrapolated to equivalent signal at 3 meters utilizing an inverse linear distance extrapolation Factor (20 dB/decade).

For testing above 1 GHz, the emission level of the EUT in peak mode was 20 dB lower than average limit (that means the emission level in peak mode also complies with the limit in average mode), then testing will be stopped and peak values of EUT will be reported, otherwise, the emissions will be measured in average mode again and reported.

Appropriate preamplifiers were used for improving sensitivity and precautions were taken to avoid overloading or desensitizing the spectrum analyzer. No post – detector video filters were used in the test.

The spectrum analyzer's 6 dB bandwidth was set to 1 MHz, and the analyzer was operated in the peak detection mode, for frequencies both below and up 1 GHz. The average levels were obtained by subtracting the duty cycle correction factor from the peak readings.

The following procedures were used to convert the emission levels measured in decibels referenced to 1 microvolt (dBuV) into field intensity in micro volts per meter (uV/m).

The actual field intensity in decibels referenced to 1 microvolt in to field intensity in micro volts per meter (dBuV/m).

The actual field intensity in referenced to 1 microvolt per meter (dBuV/m) is determined by algebraically adding the measured reading in dBuV, the antenna factor (dB), and cable loss (dB) and Subtracting the gain of preamplifier (dB) is auto calculate in spectrum analyzer.

$$(1) \text{ Amplitude (dBuV/m) = FI (dBuV) + AF (dBuV) + CL (dBuV) - Gain (dB)}$$

FI= Reading of the field intensity.

AF= Antenna factor.

CL= Cable loss.

P.S Amplitude is auto calculate in spectrum analyzer.

$$(2) \text{ Actual Amplitude (dBuV/m) = Amplitude (dBuV) - Dis(dB)}$$

The FCC specified emission limits were calculated according the EUT operating frequency and by following linear interpolation equations:

(a) For fundamental frequency : Transmitter Output < +30 dBm

(b) For spurious frequency : Spurious emission limits = fundamental emission limit /10

Data of measurement within this frequency range without mark in the table above means the reading of emissions are attenuated more than 20 dB below the permissible limits or the field strength is too small to be measured.

4.4. 20 dB RF Bandwidth Measurement

■ **Limit**

N/A

■ **Test Setup**

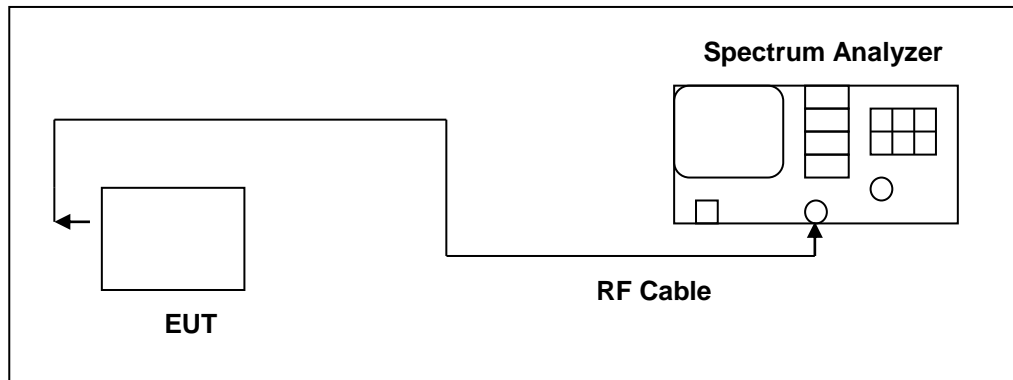

■ **Test Procedure**

Testing must be done according to this procedure, FCC Public Notice DA 00-705 - Filing and Measurement Guidelines for Frequency Hopping Spread Spectrum Systems. This is the only method recognized by the FCC. The RF output port of the Equipment-Under-Test is directly coupled to the input of the EMC analyzer through a specialized RF connector and a 10 dB passive attenuator. A fully charged battery was used for the supply voltage. The Bluetooth frequency hopping function of the EUT was enabled. The spectrum analyzer used the following settings:

1. Span = approx. 2 to 3 times the 20 dB bandwidth, centered on a hopping frequency
2. RBW \geq 1 % of the 20 dB span
3. VBW \geq RBW
4. Sweep = auto
5. Detector function = peak
6. Trace = max hold

The trace was allowed to stabilize. The EUT was transmitting at its maximum data rate. The marker-to-peak function was used to set the marker to the peak of the emission. The marker-delta function was used to measure 20 dB down one side of the emission. The marker-delta function and marker was moved to the other side of the emission until it was even with the reference marker. The marker-delta reading at this point was the 20 dB bandwidth of the emission.

4.5. Carrier Frequency Separation Measurement

■ Limit

Title 47 of the CFR, Part 15 Subpart (c) 15.247(a)(1) requires the measurement of the bandwidth of the transmission between the -20 dB points on the transmitted spectrum. The results of this test determine the limits for channel spacing. The channel spacing shall be a minimum of 25 kHz or the 20 dB bandwidth, whichever is greater. Alternatively, frequency hopping systems operating in the 2400-2483.5 MHz band may have hopping channel carrier frequencies that are separated by 25 kHz or two-thirds of the 20 dB bandwidth of the hopping channel.

■ Test Setup

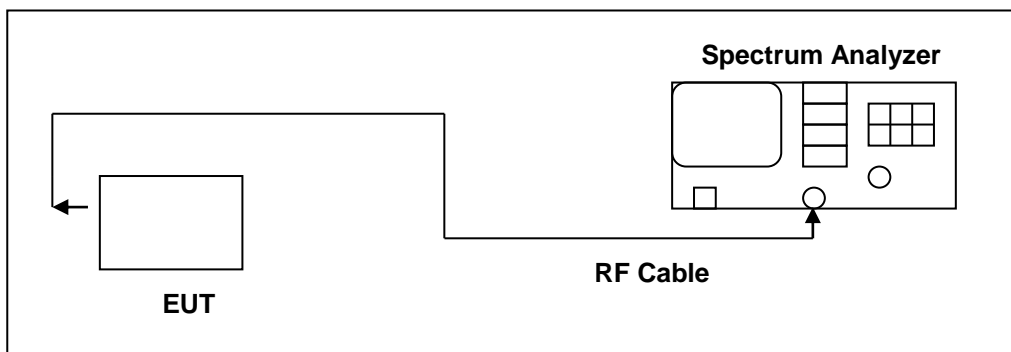

■ Test Procedure

Testing must be done according to this procedure, FCC Public Notice DA 00-705 - Filing and Measurement Guidelines for Frequency Hopping Spread Spectrum Systems. This is the only method recognized by the FCC. The RF output port of the Equipment-Under-Test is directly coupled to the input of the EMC analyzer through a specialized RF connector and a 10 dB passive attenuator. A fully charged battery was used for the supply voltage. The Bluetooth frequency hopping function of the EUT was enabled. The following spectrum analyzer settings were used:

1. Span = wide enough to capture the peaks of two adjacent channels
2. Resolution (or IF) Bandwidth (RBW) = Start with the RBW set to approximately 30% of the channel spacing;
adjust as necessary to best identify the center of each individual channel.
3. Video (or Average) Bandwidth (VBW) \geq RBW
4. Sweep = auto
5. Detector function = peak
6. Trace = max hold

The trace was allowed to stabilize. The marker-delta function was used to determine the separation between the peaks of the adjacent channels.

4.6. Number of Hopping Measurement

■ Limit

Frequency hopping systems in the 2400–2483.5 MHz band shall use at least 15 channels.

■ Test Setup

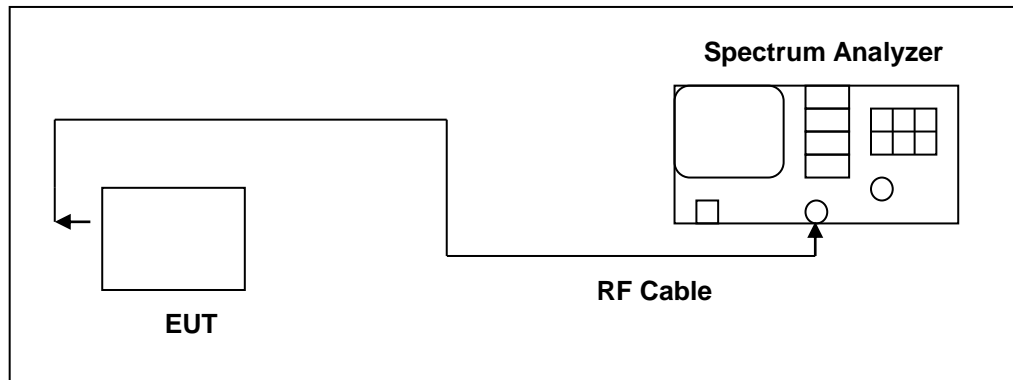

■ Test Procedure

Testing must be done according to this procedure, FCC Public Notice DA 00-705 - Filing and Measurement Guidelines for Frequency Hopping Spread Spectrum Systems. This is the only method recognized by the FCC. The RF output port of the Equipment-Under-Test is directly coupled to the input of the EMC analyzer through a specialized RF connector and a 10 dB passive attenuator. A fully charged battery was used for the supply voltage. The Bluetooth frequency hopping function of the EUT was enabled. The spectrum analyzer used the following settings:

1. Span = the frequency band of operation
2. RBW = To identify clearly the individual channels, set the RBW to less than 30% of the channel spacing or the 20 dBbandwidth, whichever is smaller.
3. VBW \geq RBW
4. Sweep = auto
5. Detector function = peak
6. Trace = max hold

The trace was allowed to stabilize.

4.7. Time of Occupancy (Dwell Time) Measurement

■ Limit

The average time of occupancy on any channel shall not be greater than 0.4 seconds within a period of 0.4 seconds multiplied by the number of hopping channels employed.

■ Test Setup

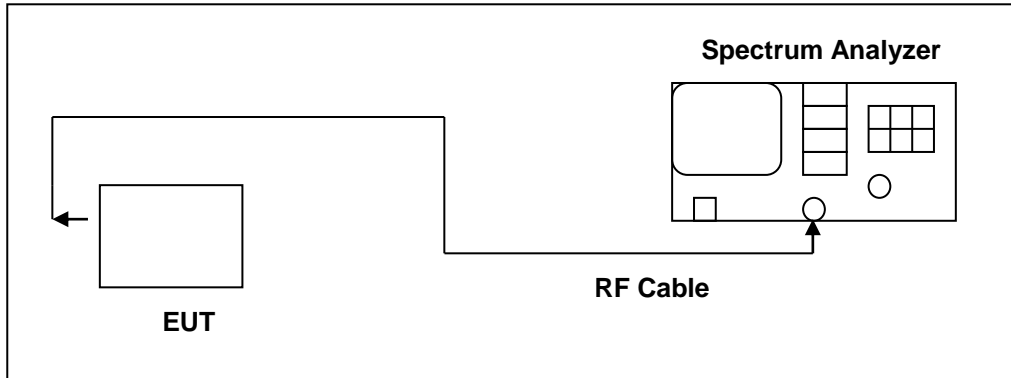

■ Test Procedure

Testing must be done according to this procedure, FCC Public Notice DA 00-705 - Filing and Measurement Guidelines for Frequency Hopping Spread Spectrum Systems. This is the only method recognized by the FCC. The RF output port of the Equipment-Under-Test is directly coupled to the input of the spectrum through a specialized RF connector and a 10 dB passive attenuator. A fully charged battery was used for the supply voltage. The Bluetooth hopping function of the EUT was enabled. The following spectrum analyzer settings were used:

1. Span = zero span, centered on a hopping channel
2. RBW = 1 MHz
3. VBW \geq RBW
4. Sweep = as necessary to capture the entire dwell time per hopping channel
5. Detector function = peak
6. Trace = max hold

The marker-delta function was used to determine the dwell time.

4.8. Out of Band Conducted Emissions Measurement

■ Limit

In any 100 kHz bandwidth outside the frequency band in which the spread spectrum or digitally modulated intentional radiator is operating, the radio frequency power that is produced by the intentional radiator shall be at least 20 dB below that in the 100 kHz bandwidth within the band that contains the highest level of the desired power

■ Test Setup

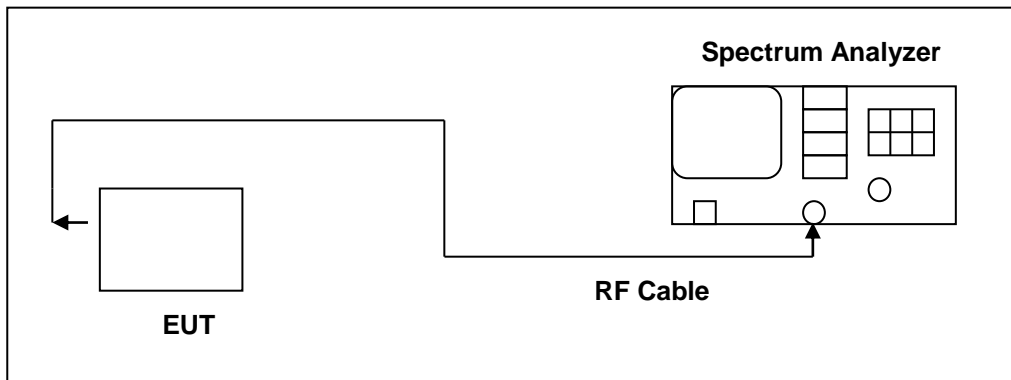

■ Test Procedure

Testing must be done according to this procedure, FCC Public Notice DA 00-705 - Filing and Measurement Guidelines for Frequency Hopping Spread Spectrum Systems. This is the only method recognized by the FCC. In any 100 kHz bandwidth outside the EUT pass band, the RF power produced by the modulation products of the spreading sequence, the information sequence, and the carrier frequency shall be at least 20 dB below that of the maximum in-band 100 kHz emission, antenna output of the EUT was coupled directly to spectrum analyzer; if an external attenuator and/or cable was used, these losses are compensated for with the analyzer OFFSET function. All other types of emissions from the EUT shall meet the general limits for radiated frequencies outside the pass band. The test was performed at 3 channels (Channel 0, 39, 78)

4.9. Antenna Measurement

■ Limit

For intentional device, according to 15.203, an intentional radiator shall be designed to ensure that no antenna other than that furnished by the responsible party shall be used with the device.

And According to 15.247 (b)(4), if transmitting antennas of directional gain greater than 6 dBi are used, the power shall be reduced by the amount in dB that the directional gain of the antenna exceeds 6 dBi.

■ Antenna Connector Construction

See section 2 – antenna information.

5 Test Results

5.1. Conducted Emission

Standard:	FCC Part 15.247	Line:	L1
Test item:	Conducted Emission	Power:	AC 120 V/60 Hz
Mode:	Mode 1	Temp.(°C)/Hum.(%RH):	26(°C)/60 %RH
Description:			

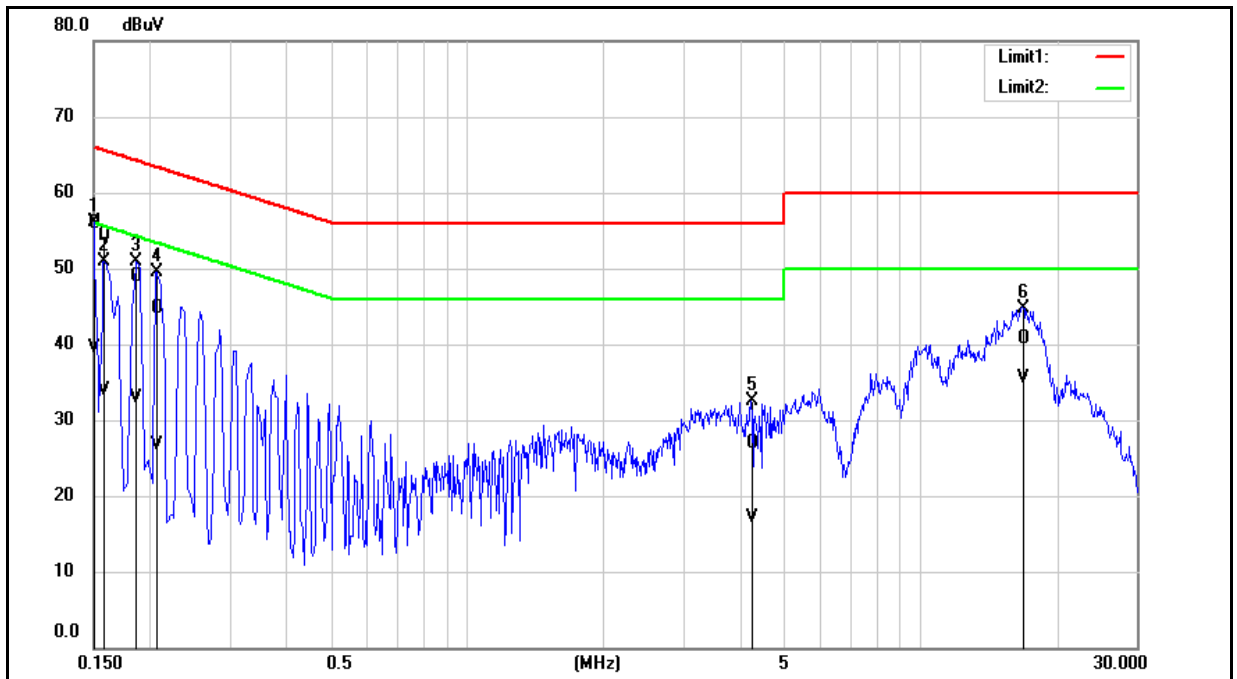

No.	Frequency (MHz)	QP reading (dBuV)	AVG reading (dBuV)	Correction factor (dB)	QP result (dBuV)	AVG result (dBuV)	QP limit (dBuV)	AVG limit (dBuV)	QP margin (dB)	AVG margin (dB)	Remark
1	0.1500	46.43	29.96	9.54	55.97	39.50	66.00	56.00	-10.03	-16.50	Pass
2	0.1580	44.76	24.29	9.54	54.30	33.83	65.57	55.57	-11.27	-21.74	Pass
3	0.1860	39.42	23.36	9.54	48.96	32.90	64.21	54.21	-15.25	-21.31	Pass
4	0.2060	35.07	17.21	9.54	44.61	26.75	63.37	53.37	-18.76	-26.62	Pass
5	4.2260	17.30	7.46	9.67	26.97	17.13	56.00	46.00	-29.03	-28.87	Pass
6	16.7540	30.89	25.62	9.84	40.73	35.46	60.00	50.00	-19.27	-14.54	Pass

Note: 1. Result (dBuV) = Correction factor (dB) + Reading(dBuV).

2. Correction factor (dB) = Cable loss (dB) + L.I.S.N. factor (dB).

Standard:	FCC Part 15.247	Line:	N
Test item:	Conducted Emission	Power:	AC 120 V/60 Hz
Mode:	Mode 1	Temp.(°C)/Hum.(%RH):	26(°C)/60 %RH
Description:			

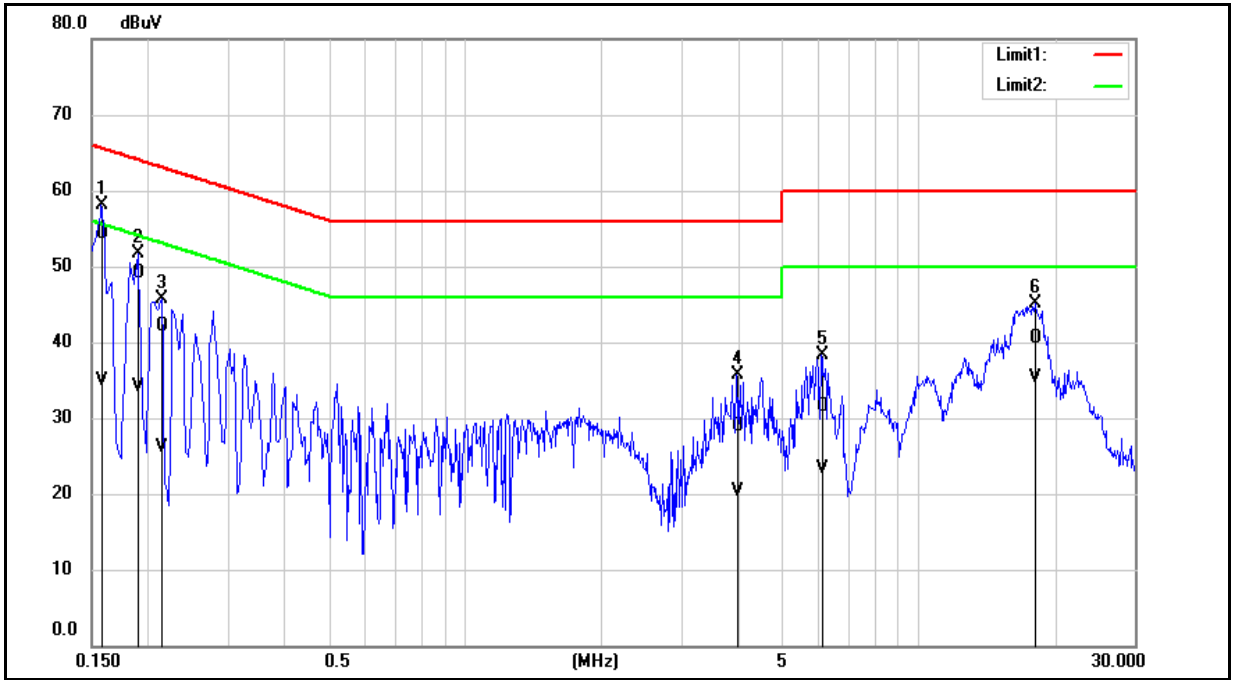

No.	Frequency (MHz)	QP reading (dBuV)	AVG reading (dBuV)	Correction factor (dB)	QP result (dBuV)	AVG result (dBuV)	QP limit (dBuV)	AVG limit (dBuV)	QP margin (dB)	AVG margin (dB)	Remark
1	0.1580	44.79	25.32	9.60	54.39	34.92	65.57	55.57	-11.18	-20.65	Pass
2	0.1900	39.60	24.49	9.60	49.20	34.09	64.04	54.04	-14.84	-19.95	Pass
3	0.2140	32.57	16.59	9.60	42.17	26.19	63.05	53.05	-20.88	-26.86	Pass
4	3.9740	19.16	10.64	9.73	28.89	20.37	56.00	46.00	-27.11	-25.63	Pass
5	6.0940	21.77	13.60	9.78	31.55	23.38	60.00	50.00	-28.45	-26.62	Pass
6	18.0820	30.51	25.27	10.00	40.51	35.27	60.00	50.00	-19.49	-14.73	Pass

Note: 1. Result (dBuV) = Correction factor (dB) + Reading(dBuV).
2. Correction factor (dB) = Cable loss (dB) + L.I.S.N. factor (dB).

5.2. Conducted Test Results

Maximum Conducted Output Power Measurement

Test Mode	Frequency (MHz)	RF Power setting in Test Software	Test Software Version
Mode 2	2402	12.00	DRTU 22.21080.0.0-OEM.DRTU.12817
	2441	12.00	
	2480	12.00	
Mode 3	2402	8.00	
	2441	8.00	
	2480	8.00	
Mode 4	2402	8.00	
	2441	8.00	
	2480	8.00	

Test Mode	Frequency (MHz)	Packet Type	Average Power		Peak Power		Limit (W)
			(dBm)	(W)	(dBm)	(W)	
Mode 2	2402	DH1	9.30	0.00851	9.55	0.00902	≤ 0.125
		DH3	9.31	0.00853	9.56	0.00904	≤ 0.125
		DH5	9.33	0.00857	9.57	0.00906	≤ 0.125
	2441	DH1	9.57	0.00906	9.80	0.00955	≤ 0.125
		DH3	9.58	0.00908	9.82	0.00959	≤ 0.125
		DH5	9.59	0.00910	9.83	0.00962	≤ 0.125
	2480	DH1	9.30	0.00851	9.56	0.00904	≤ 0.125
		DH3	9.35	0.00861	9.59	0.00910	≤ 0.125
		DH5	9.36	0.00863	9.60	0.00912	≤ 0.125
Mode 3	2402	2DH1	5.97	0.00395	8.20	0.00661	≤ 0.125
		2DH3	5.99	0.00397	8.22	0.00664	≤ 0.125
		2DH5	6.00	0.00398	8.23	0.00665	≤ 0.125
	2441	2DH1	6.15	0.00412	8.40	0.00692	≤ 0.125
		2DH3	6.28	0.00425	8.45	0.00700	≤ 0.125
		2DH5	6.30	0.00427	8.50	0.00708	≤ 0.125
	2480	2DH1	5.49	0.00354	7.88	0.00614	≤ 0.125
		2DH3	5.61	0.00364	8.01	0.00632	≤ 0.125
		2DH5	5.62	0.00365	8.05	0.00638	≤ 0.125
Mode 4	2402	3DH1	5.97	0.00395	8.31	0.00678	≤ 0.125
		3DH3	6.08	0.00406	8.41	0.00693	≤ 0.125
		3DH5	6.12	0.00409	8.47	0.00703	≤ 0.125
	2441	3DH1	6.21	0.00418	8.60	0.00724	≤ 0.125
		3DH3	6.38	0.00435	8.63	0.00729	≤ 0.125
		3DH5	6.40	0.00437	8.66	0.00735	≤ 0.125
	2480	3DH1	5.61	0.00364	8.20	0.00661	≤ 0.125
		3DH3	5.62	0.00365	8.21	0.00662	≤ 0.125
		3DH5	5.70	0.00372	8.22	0.00664	≤ 0.125

Note: The relevant measured result has the offset with cable loss already.

20 dB RF Bandwidth Measurement

Test Mode	Frequency (MHz)	Measurement Results (MHz)
Mode 2	2402	0.956
	2441	0.956
	2480	0.957
Mode 4	2402	1.480
	2441	1.474
	2480	1.478

Test Graphs

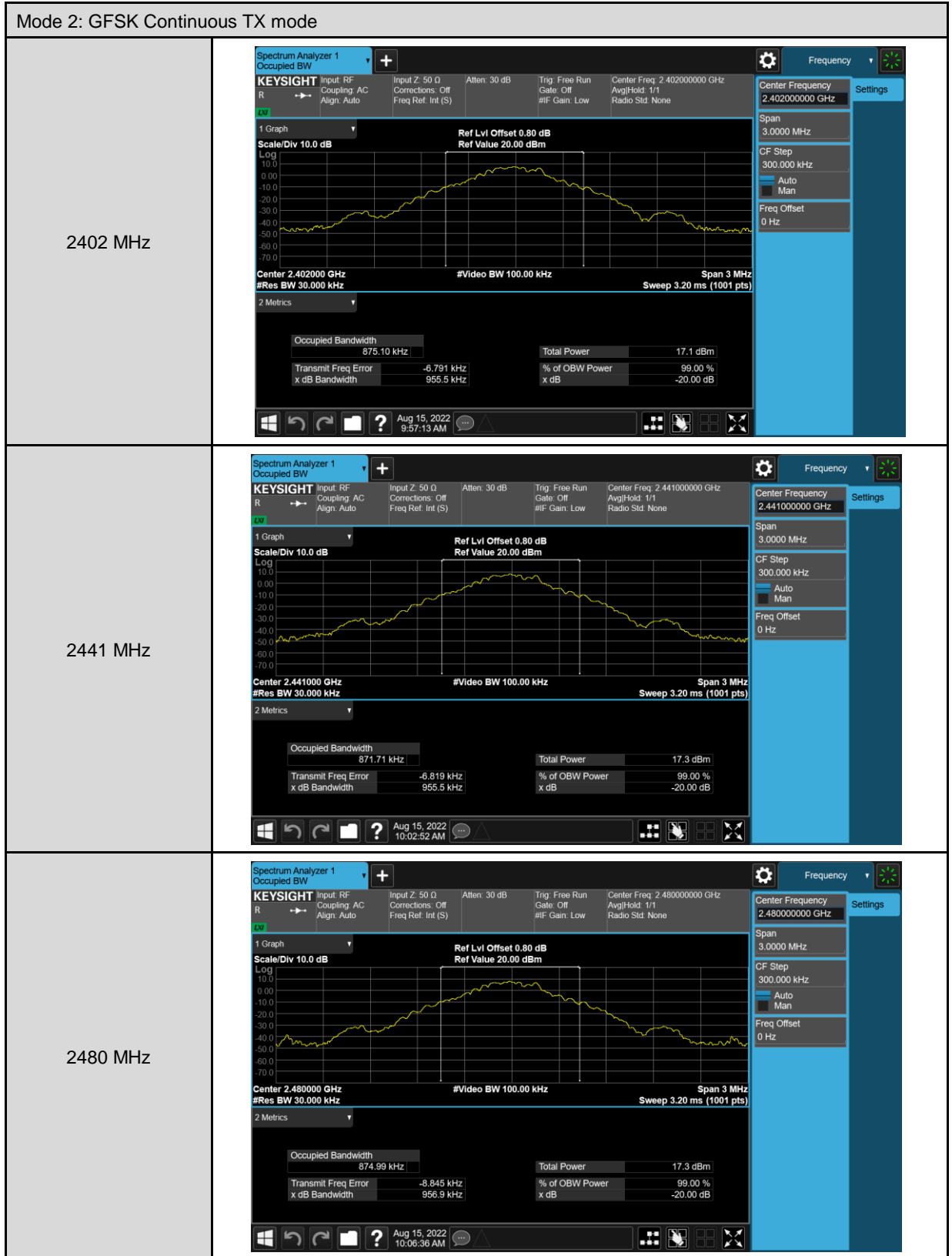

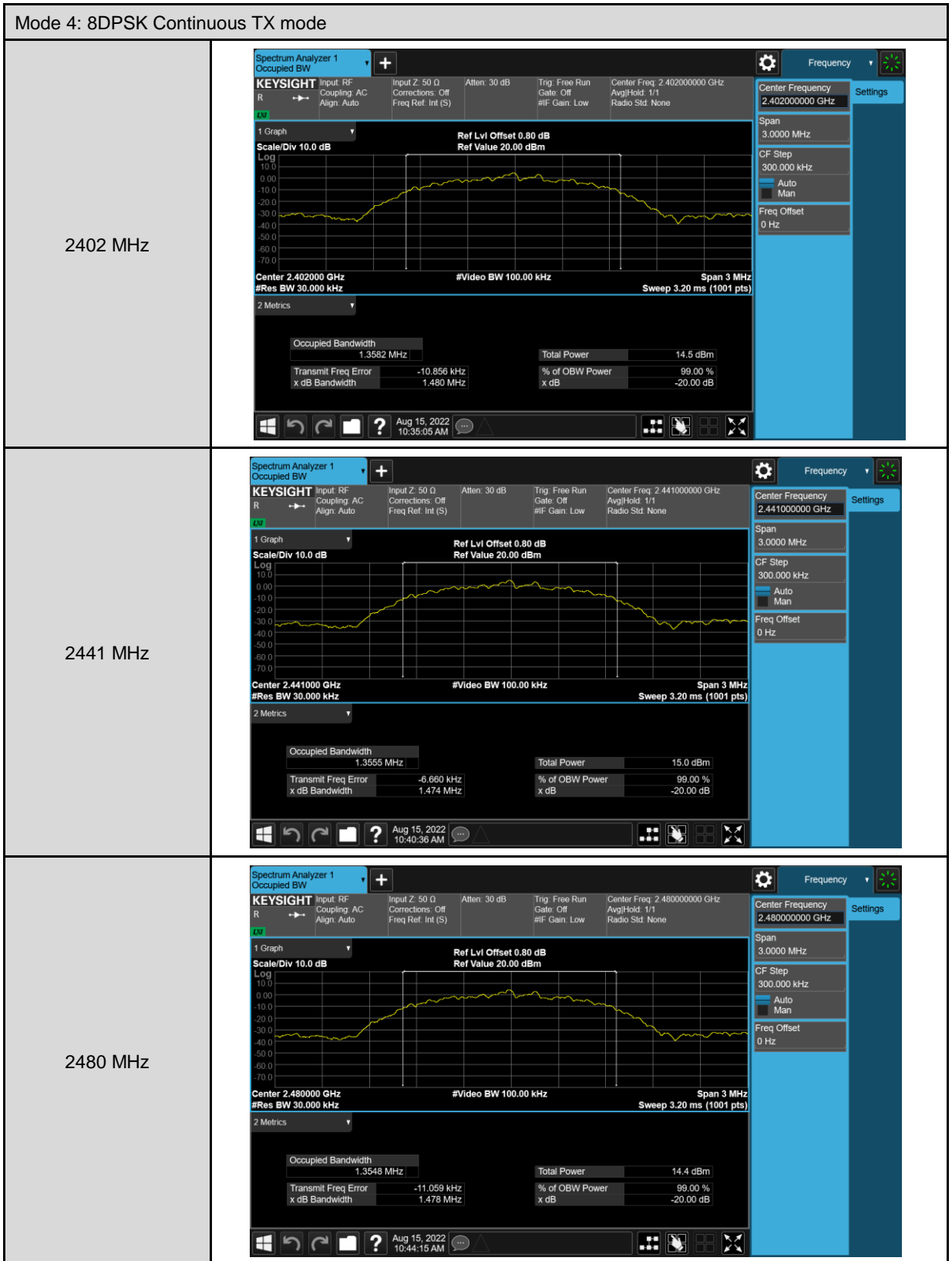

Carrier Frequency Separation Measurement

Test Mode	Frequency (MHz)	Measurement Results (MHz)	Limit (MHz)
Mode 2	2402	1.006	≥ 0.637
	2441	1.128	≥ 0.637
	2480	0.834	≥ 0.638
Mode 4	2402	0.998	≥ 0.987
	2441	0.994	≥ 0.983
	2480	1.000	≥ 0.985

Test Graphs

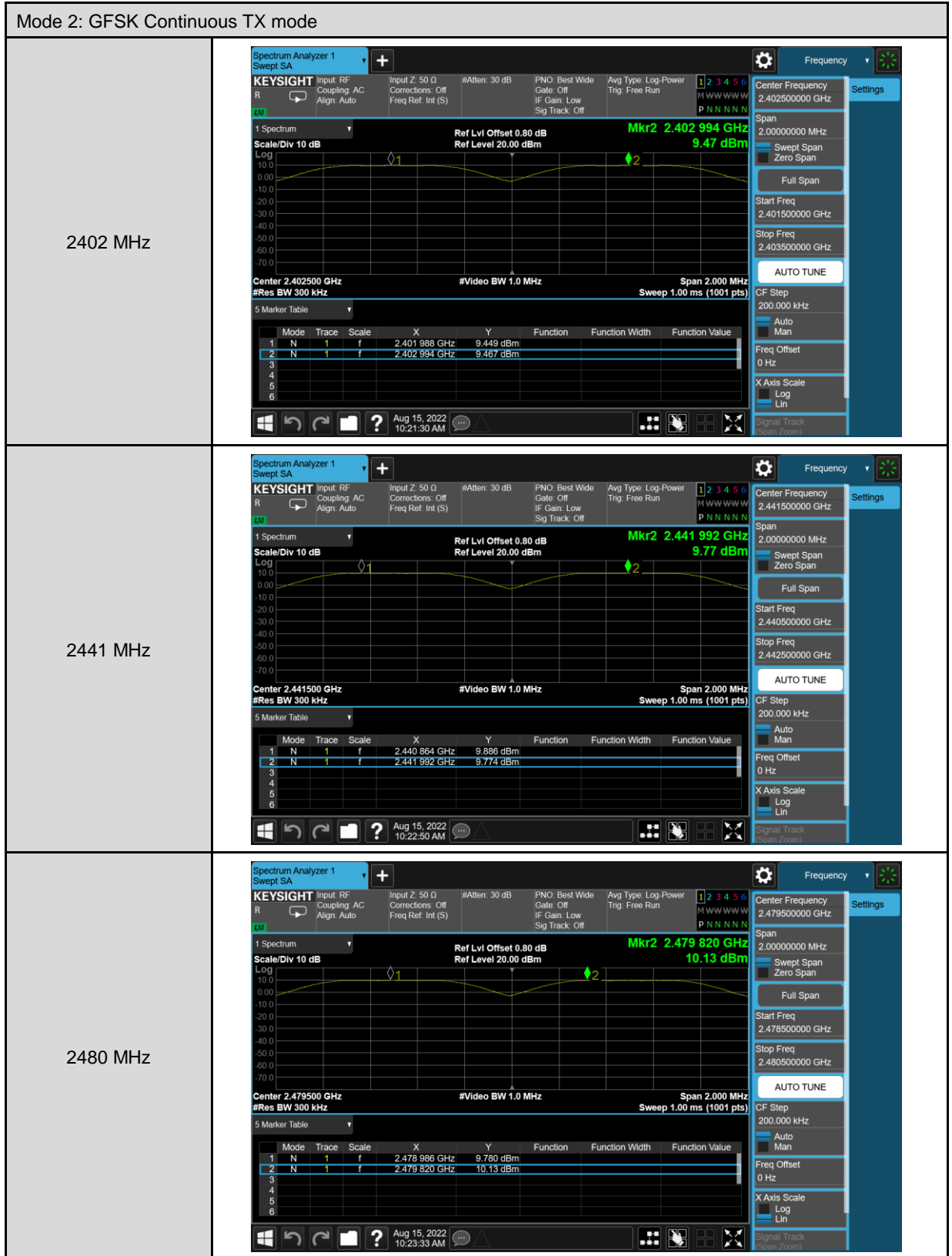

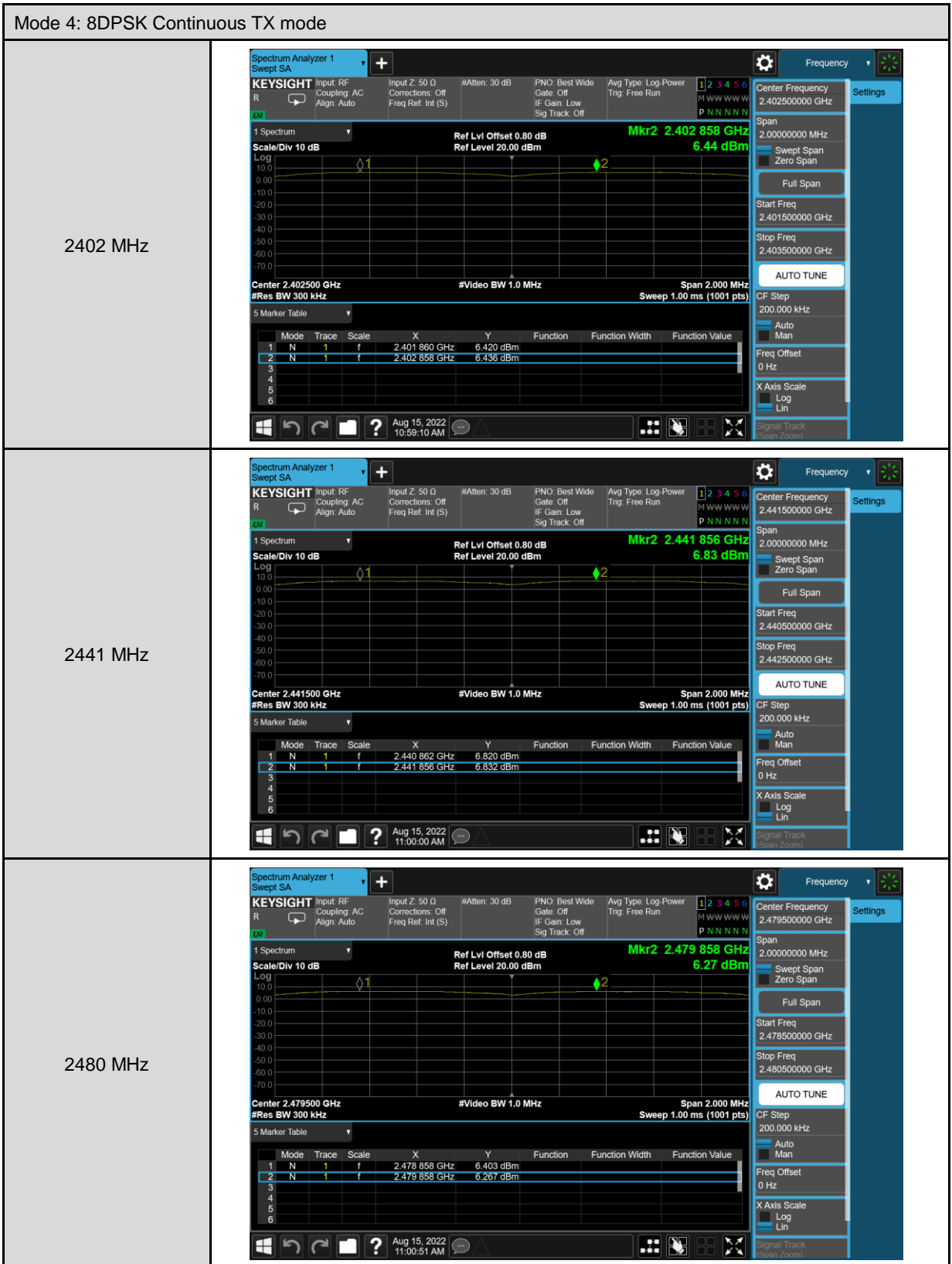

Number of Hopping Measurement

Test Mode	Frequency Range (MHz)	Measurement Results (Ch)	Limit (ch)
Mode 2	2402 - 2480	79	≥ 15
Mode 4	2402 - 2480	79	≥ 15

■ Test Graphs





Time of Occupancy (Dwell Time) Measurement

Mode 2: GFSK Continuous TX mode	
DH1	
Cycle Calculate	$79CH * 0.4 = 31.6 \text{ (sec)}$
The EUT Hopping Number per Sec	1600 times/sec
Each Channel Dwell Times per Sec	$800/79CH = 10.13(\text{times/sec})$
Each Channel Dwell Times on Cycle(1)	$31.6 * 10.13 = 320.108(\text{times})$
Each Channel Dwell Times (2)	0.470 ms (sec)
Dwell Times on Cycle (1) * (2)	150.451 ms (sec)
LIMIT(msec)	$< = 400$
DH3	
Cycle Calculate	$79CH * 0.4 = 31.6 \text{ (sec)}$
The EUT Hopping Number per Sec	1600 times/sec
Each Channel Dwell Times per Sec	$400/79CH = 5.1(\text{times/sec})$
Each Channel Dwell Times on Cycle(1)	$31.6 * 5.1 = 161.16(\text{times})$
Each Channel Dwell Times (2)	1.730 ms (sec)
Dwell Times on Cycle (1) * (2)	276.620 ms (sec)
LIMIT(msec)	$< = 400$
DH5	
Cycle Calculate	$79CH * 0.4 = 31.6 \text{ (sec)}$
The EUT Hopping Number per Sec	1600 times/sec
Each Channel Dwell Times per Sec	$266.7/79CH = 3.37(\text{times/sec})$
Each Channel Dwell Times on Cycle(1)	$31.6 * 3.37 = 106.492(\text{times})$
Each Channel Dwell Times (2)	2.985 ms (sec)
Dwell Times on Cycle (1) * (2)	318.822 ms (sec)
LIMIT(msec)	$< = 400$

Mode 4: 8DPSK Continuous TX mode	
3DH1	
Cycle Calculate	$79CH * 0.4 = 31.6 \text{ (sec)}$
The EUT Hopping Number per Sec	1600 times/sec
Each Channel Dwell Times per Sec	$800/79CH = 10.13 \text{ (times/sec)}$
Each Channel Dwell Times on Cycle(1)	$31.6 * 10.13 = 320.108 \text{ (times)}$
Each Channel Dwell Times (2)	0.480 ms (sec)
Dwell Times on Cycle (1) * (2)	153.652 ms (sec)
LIMIT(msec)	$< = 400$
3DH3	
Cycle Calculate	$79CH * 0.4 = 31.6 \text{ (sec)}$
The EUT Hopping Number per Sec	1600 times/sec
Each Channel Dwell Times per Sec	$400/79CH = 5.1 \text{ (times/sec)}$
Each Channel Dwell Times on Cycle(1)	$31.6 * 5.1 = 161.16 \text{ (times)}$
Each Channel Dwell Times (2)	1.760 ms (sec)
Dwell Times on Cycle (1) * (2)	281.417 ms (sec)
LIMIT(msec)	$< = 400$
3DH5	
Cycle Calculate	$79CH * 0.4 = 31.6 \text{ (sec)}$
The EUT Hopping Number per Sec	1600 times/sec
Each Channel Dwell Times per Sec	$266.7/79CH = 3.37 \text{ (times/sec)}$
Each Channel Dwell Times on Cycle(1)	$31.6 * 3.37 = 106.492 \text{ (times)}$
Each Channel Dwell Times (2)	2.985 ms (sec)
Dwell Times on Cycle (1) * (2)	318.822 ms (sec)
LIMIT(msec)	$< = 400$

Test Graphs

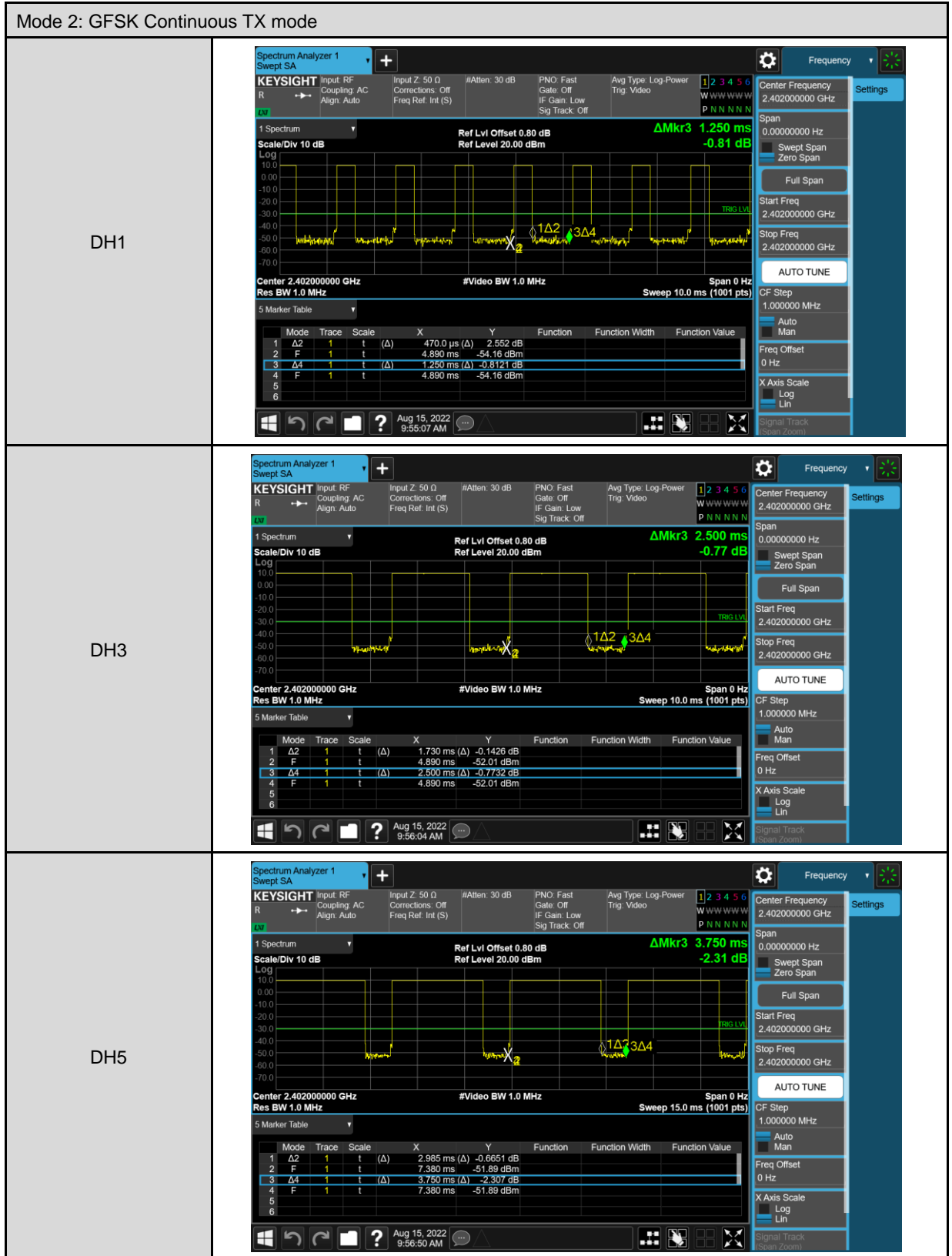

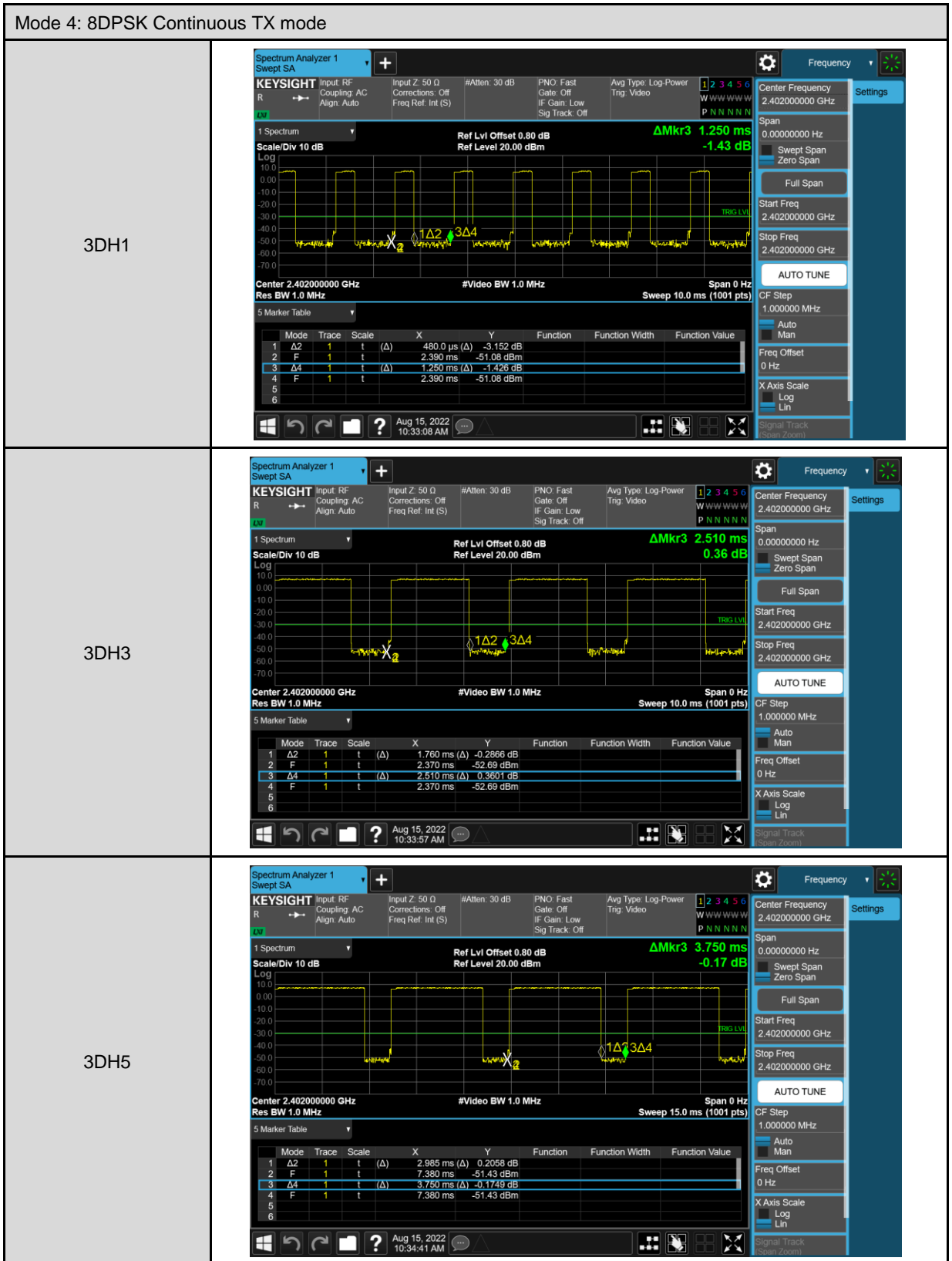

Out of Band Conducted Emissions Measurement

Test Graphs

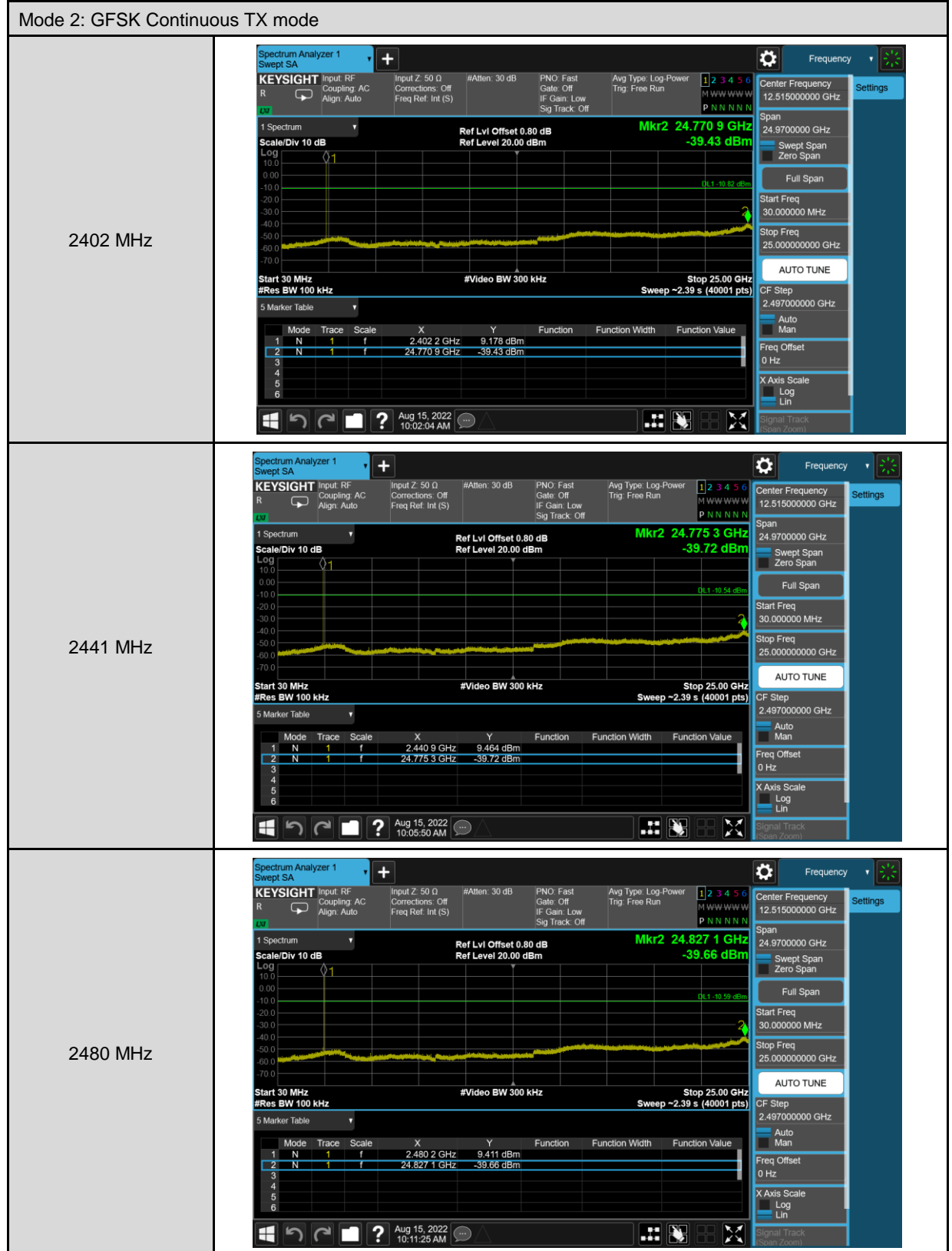

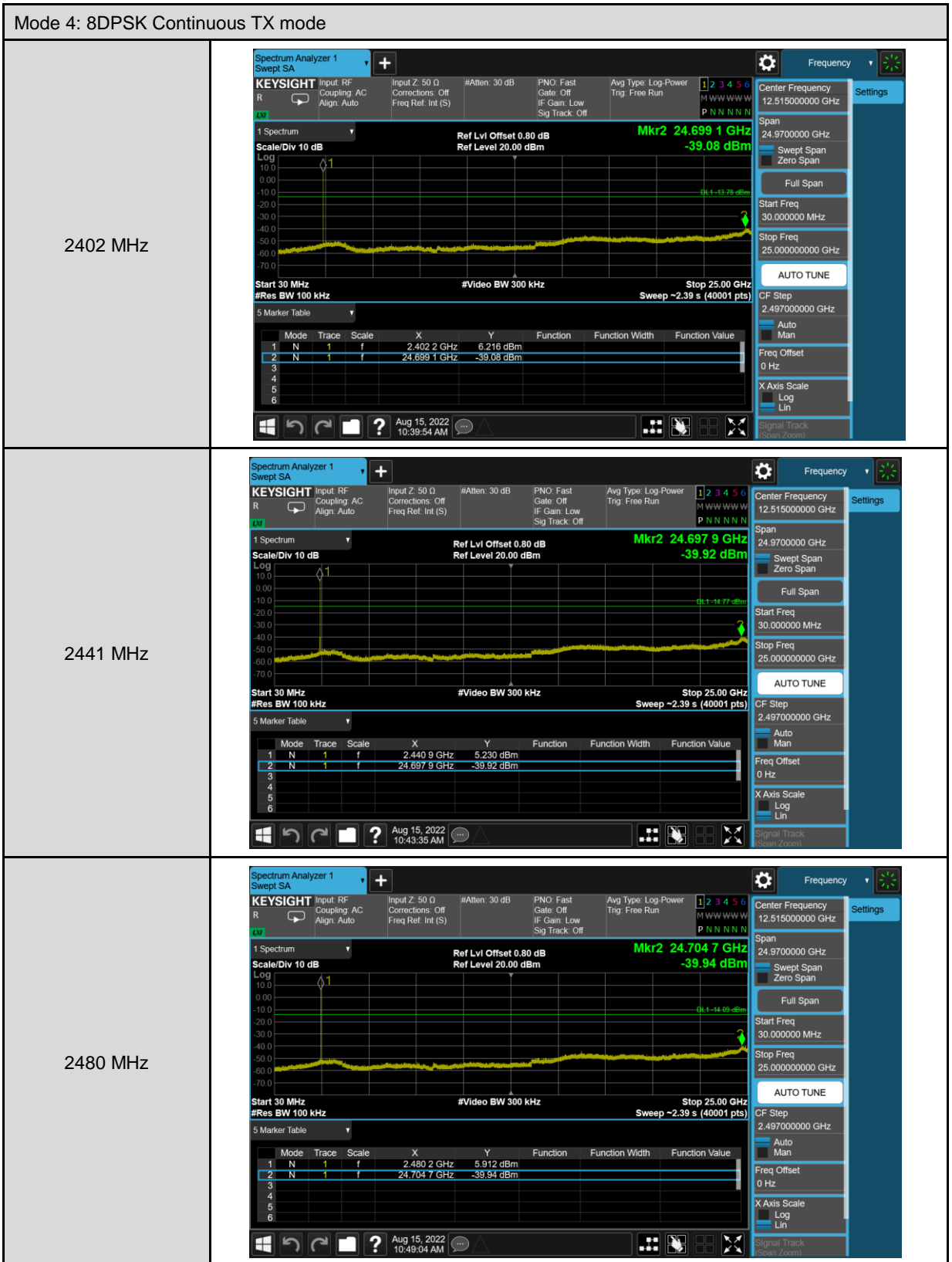

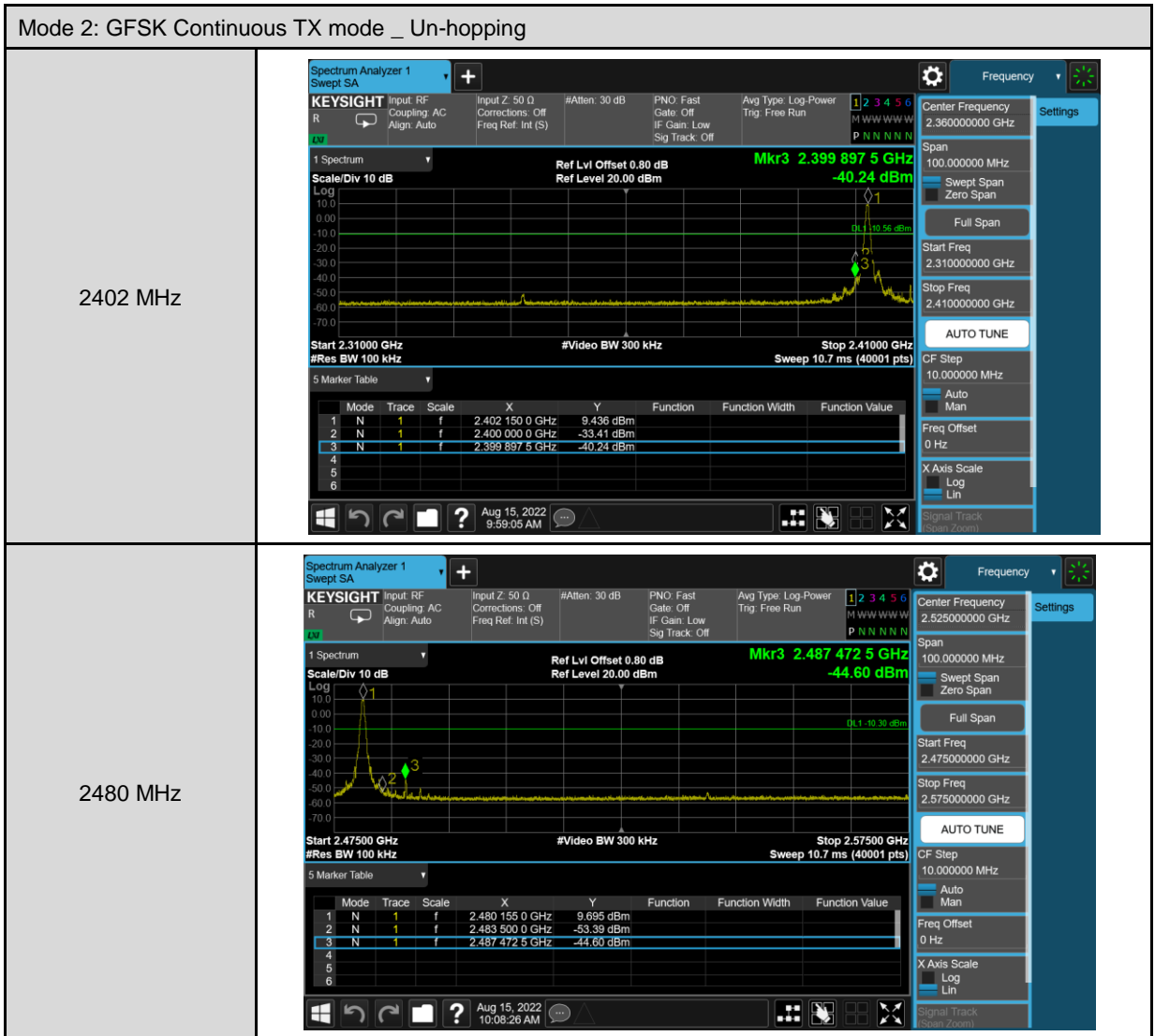

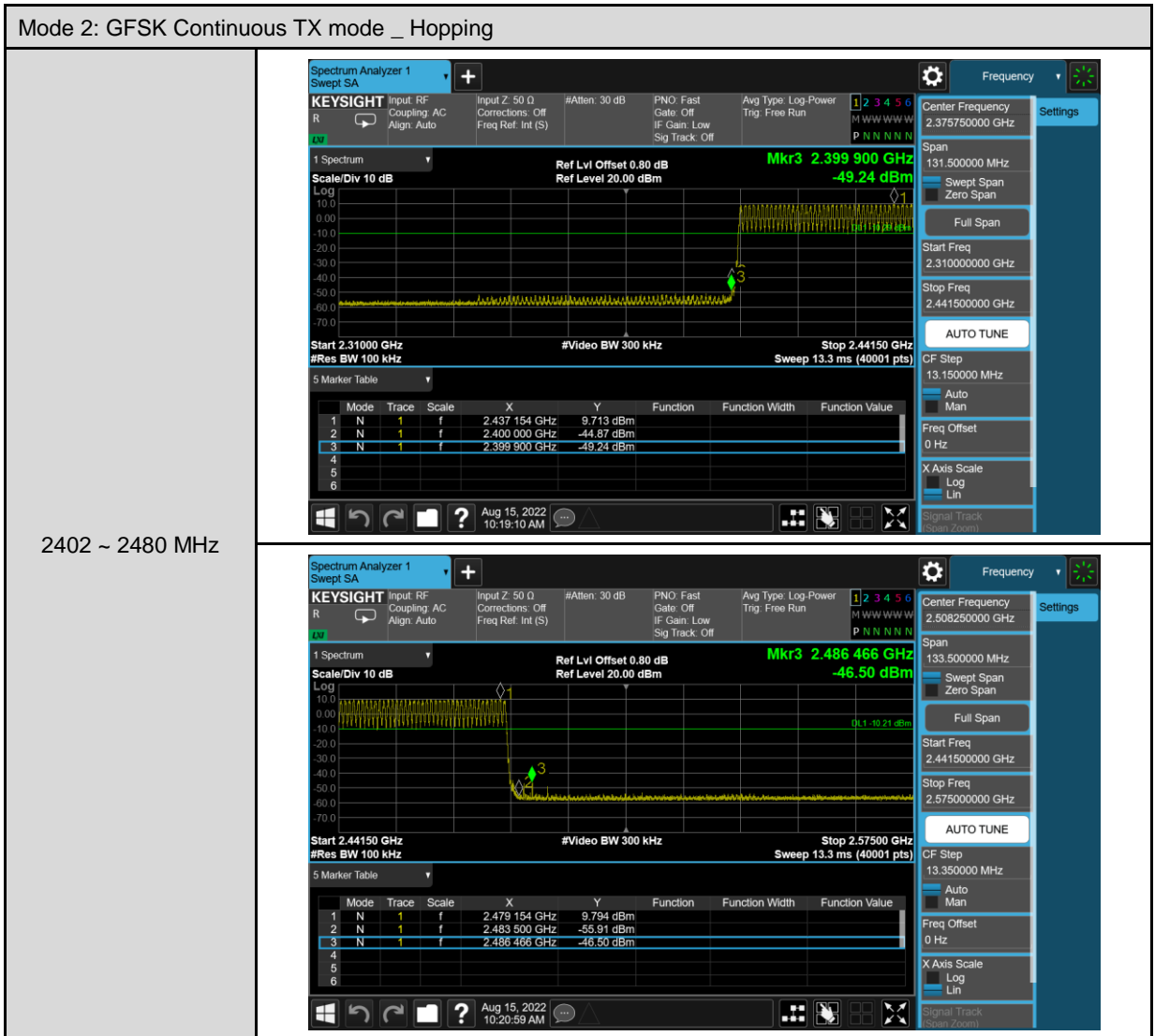

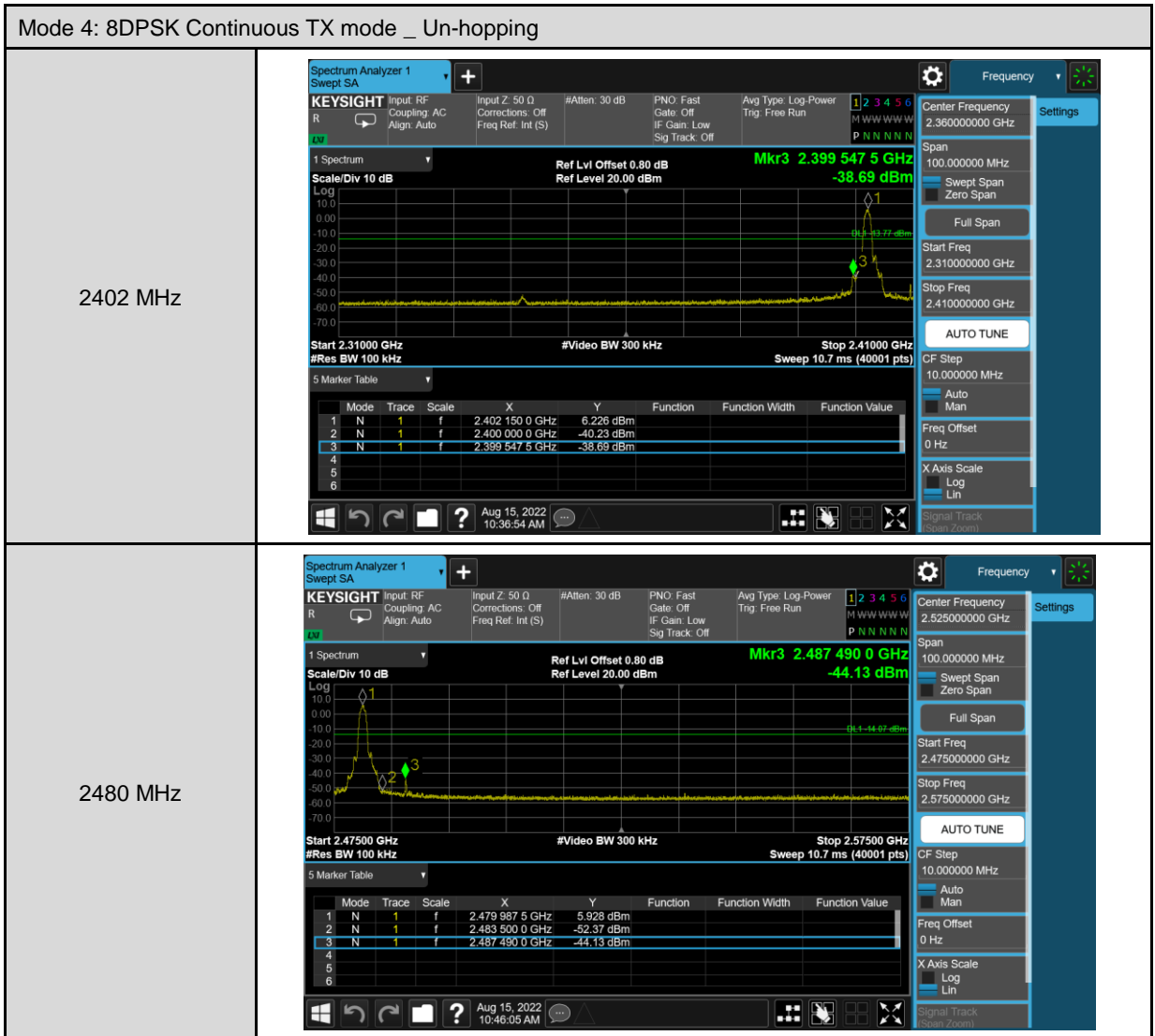

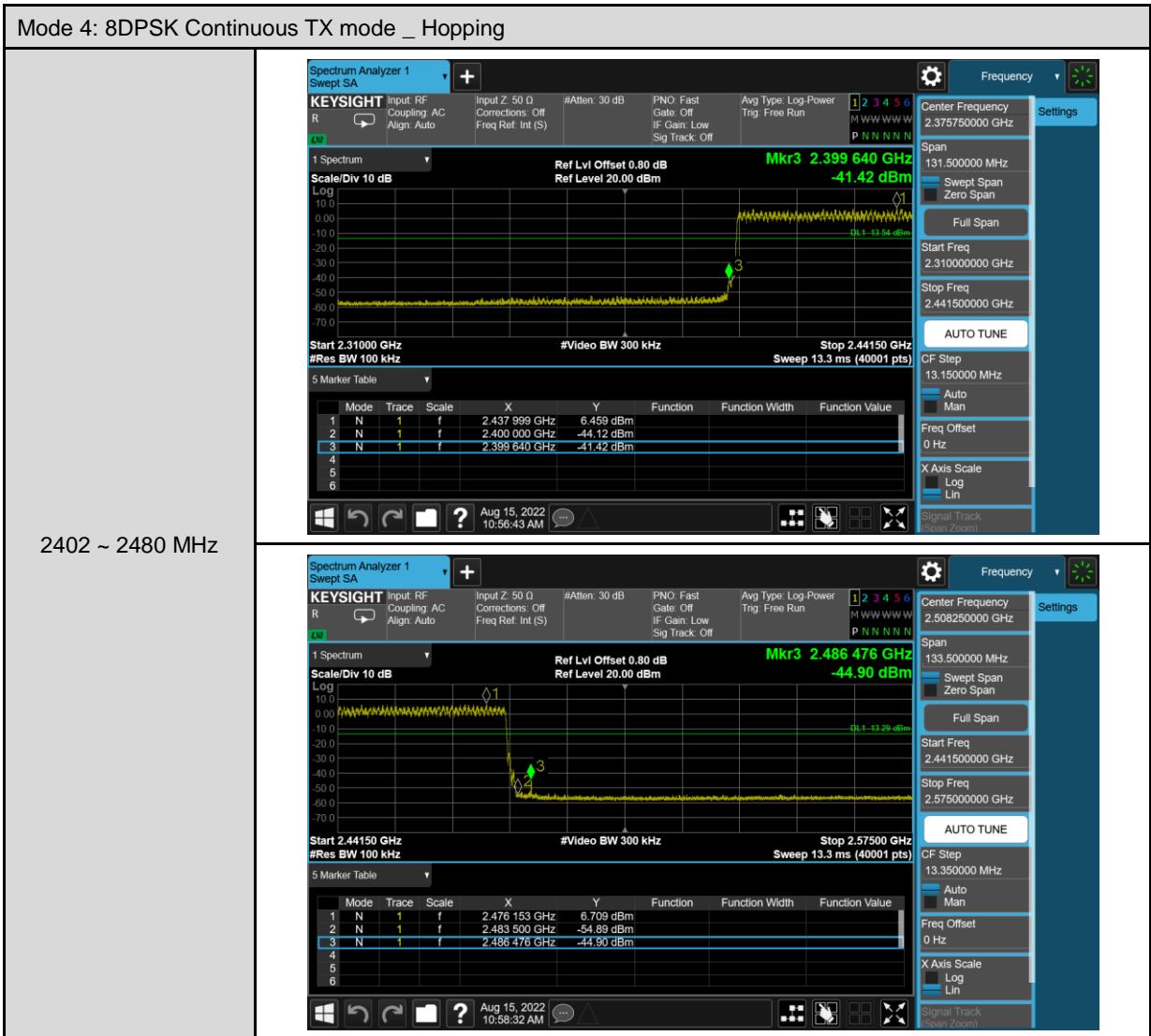

5.3. Radiated Emission Measurement

Below 1 GHz

Standard:	FCC Part 15.247	Test Distance:	3m
Mode:	Mode 1		
Ant.Polar.:	Horizontal		

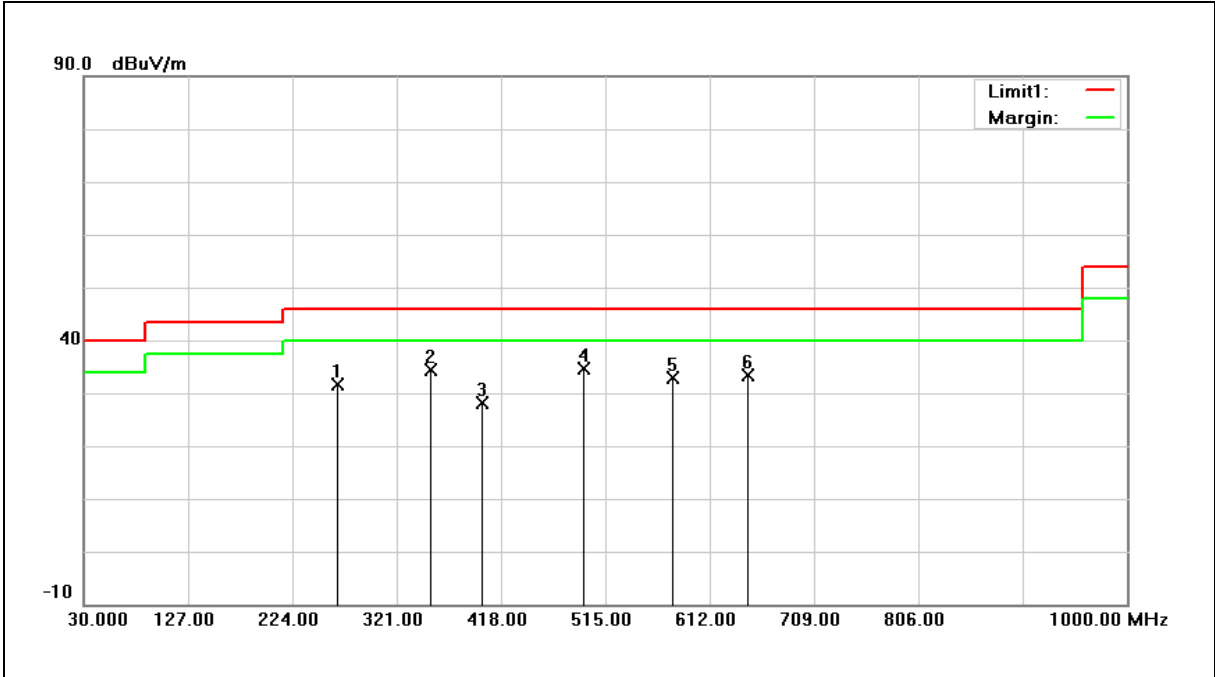

No.	Frequency (MHz)	Reading (dBuV)	Correct Factor (dB/m)	Result (dBuV/m)	Limit (dBuV/m)	Margin (dB)	Remark
1	265.7100	42.22	-10.61	31.61	46.00	-14.39	QP
2	353.0100	42.79	-8.38	34.41	46.00	-11.59	QP
3	400.5400	35.03	-6.78	28.25	46.00	-17.75	QP
4	494.6300	39.32	-4.62	34.70	46.00	-11.30	QP
5	578.0500	35.71	-2.83	32.88	46.00	-13.12	QP
6	647.8900	34.95	-1.51	33.44	46.00	-12.56	QP

Note:1.Result (dBuV/m) = Correct Factor (dB/m) + Reading(dBuV).

2.Correction factor (dB/m) = Antenna Factor (dB/m) + Cable loss (dB) – Pre-Amplifier gain (dB).

3.When the peak results are less than average limit, so not need to evaluate the average.

Standard:	FCC Part 15.247	Test Distance:	3m
Mode:	Mode 1		
Ant.Polar.:	Vertical		

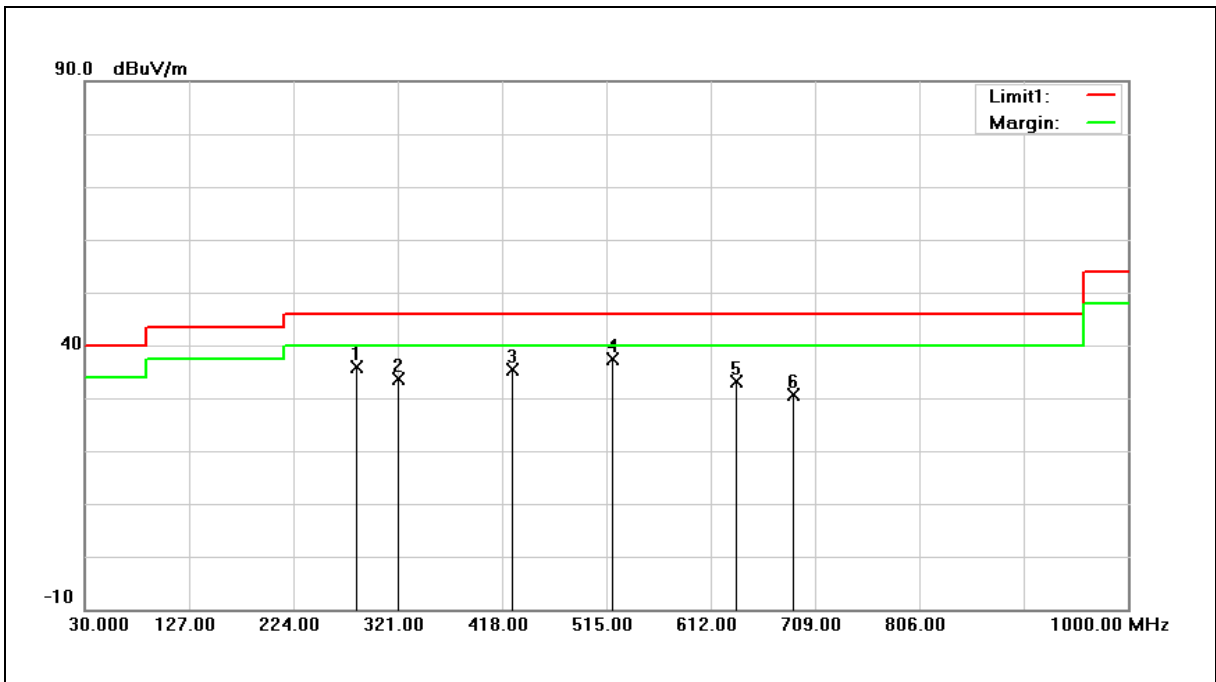

No.	Frequency (MHz)	Reading (dBuV)	Correct Factor (dB/m)	Result (dBuV/m)	Limit (dBuV/m)	Margin (dB)	Remark
1	283.1700	45.68	-9.91	35.77	46.00	-10.23	QP
2	321.9700	42.74	-9.06	33.68	46.00	-12.32	QP
3	427.7000	41.44	-5.99	35.45	46.00	-10.55	QP
4	520.8200	41.54	-4.20	37.34	46.00	-8.66	QP
5	635.2800	34.85	-1.68	33.17	46.00	-12.83	QP
6	688.6300	31.65	-1.04	30.61	46.00	-15.39	QP

Note:1.Result (dBuV/m) = Correct Factor (dB/m) + Reading(dBuV).

2.Correction factor (dB/m) = Antenna Factor (dB/m) + Cable loss (dB) – Pre-Amplifier gain (dB).

3.When the peak results are less than average limit, so not need to evaluate the average.

Harmonic

Above 1 GHz

Standard:	FCC Part 15.247	Test Distance:	3 m
Test item:	Harmonic		
Frequency:	2402 MHz		
Mode:	Mode 2		
Ant.Polar.:	Horizontal		

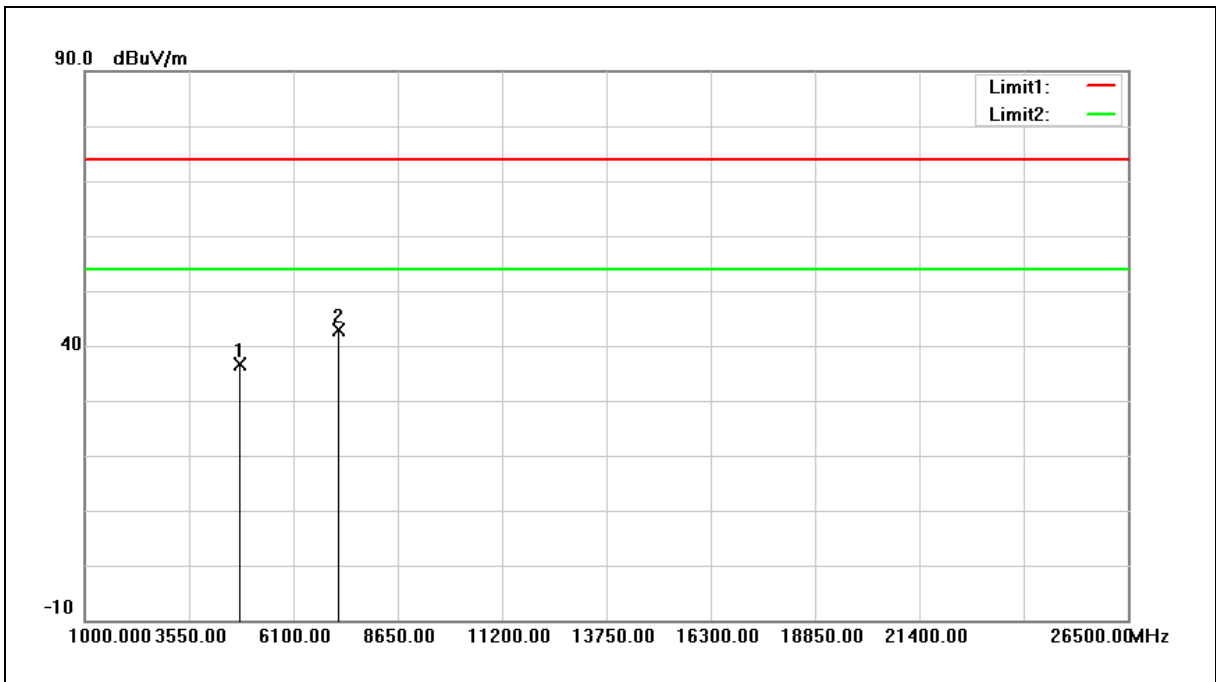

No.	Frequency (MHz)	Reading (dBuV)	Correct Factor (dB/m)	Result (dBuV/m)	Limit (dBuV/m)	Margin (dB)	Remark
1	4804.000	31.39	5.28	36.67	74.00	-37.33	peak
2	7206.000	30.33	12.56	42.89	74.00	-31.11	peak

Note:1.Result (dBuV/m) = Correct Factor (dB/m) + Reading(dBuV).

2.Correction factor (dB/m) = Antenna Factor (dB/m) + Cable loss (dB) – Pre-Amplifier gain (dB).

3.When the peak results are less than average limit, so not need to evaluate the average.

Standard:	FCC Part 15.247	Test Distance:	3 m
Test item:	Harmonic		
Frequency:	2402 MHz		
Mode:	Mode 2		
Ant.Polar.:	Vertical		

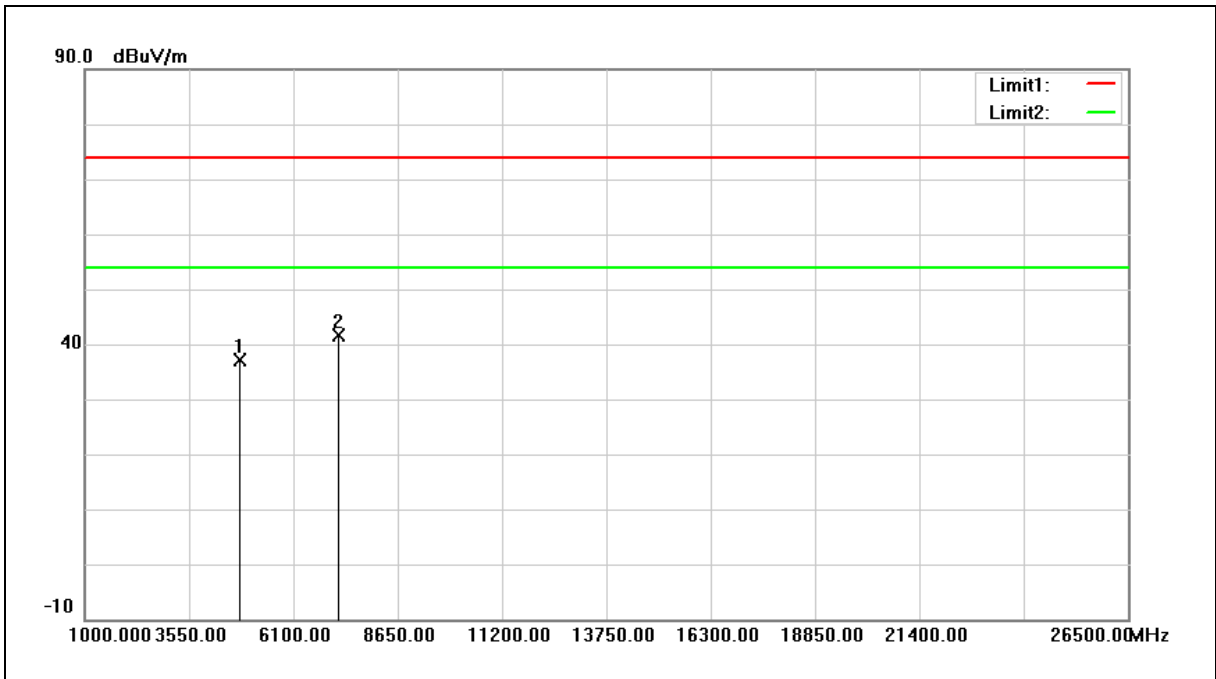

No.	Frequency (MHz)	Reading (dBuV)	Correct Factor (dB/m)	Result (dBuV/m)	Limit (dBuV/m)	Margin (dB)	Remark
1	4804.000	31.83	5.28	37.11	74.00	-36.89	peak
2	7206.000	29.13	12.56	41.69	74.00	-32.31	peak

Note: 1. Result (dBuV/m) = Correct Factor (dB/m) + Reading (dBuV).

2. Correction factor (dB/m) = Antenna Factor (dB/m) + Cable loss (dB) – Pre-Amplifier gain (dB).

3. When the peak results are less than average limit, so not need to evaluate the average.

Standard:	FCC Part 15.247	Test Distance:	3 m
Test item:	Harmonic		
Frequency:	2441 MHz		
Mode:	Mode 2		
Ant.Polar.:	Horizontal		

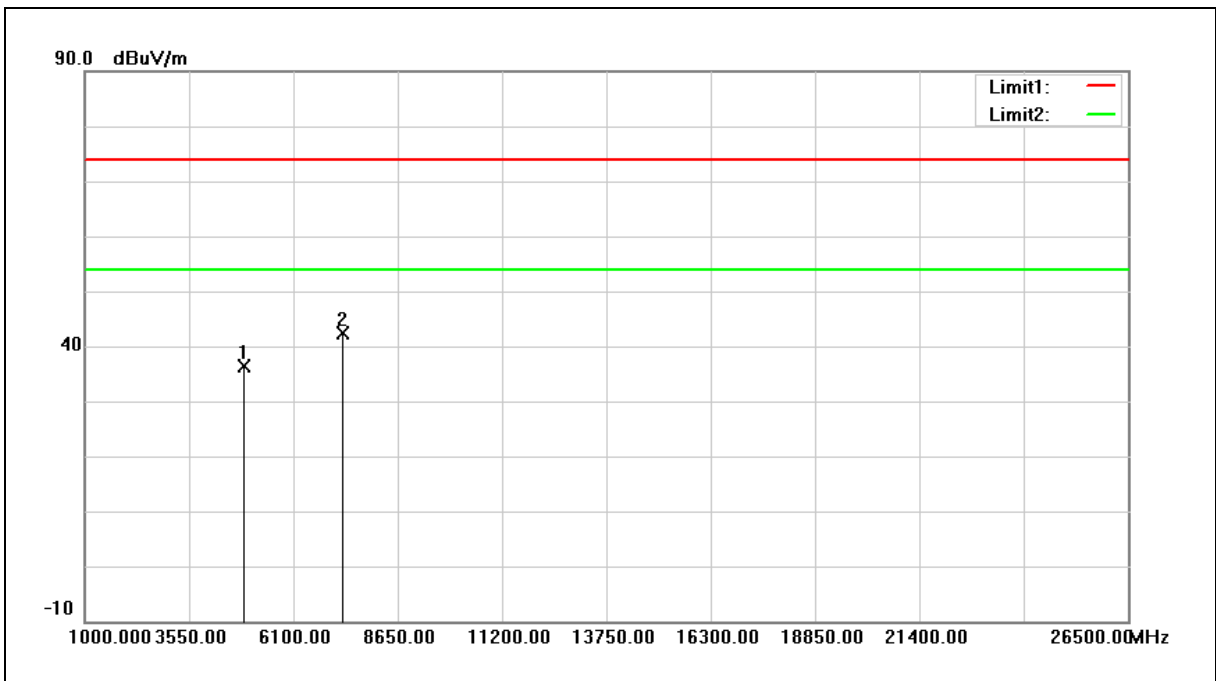

No.	Frequency (MHz)	Reading (dBuV)	Correct Factor (dB/m)	Result (dBuV/m)	Limit (dBuV/m)	Margin (dB)	Remark
1	4882.000	30.93	5.50	36.43	74.00	-37.57	peak
2	7323.000	29.55	12.83	42.38	74.00	-31.62	peak

Note: 1. Result (dBuV/m) = Correct Factor (dB/m) + Reading (dBuV).

2. Correction factor (dB/m) = Antenna Factor (dB/m) + Cable loss (dB) – Pre-Amplifier gain (dB).

3. When the peak results are less than average limit, so not need to evaluate the average.

Standard:	FCC Part 15.247	Test Distance:	3 m
Test item:	Harmonic		
Frequency:	2441 MHz		
Mode:	Mode 2		
Ant.Polar.:	Vertical		

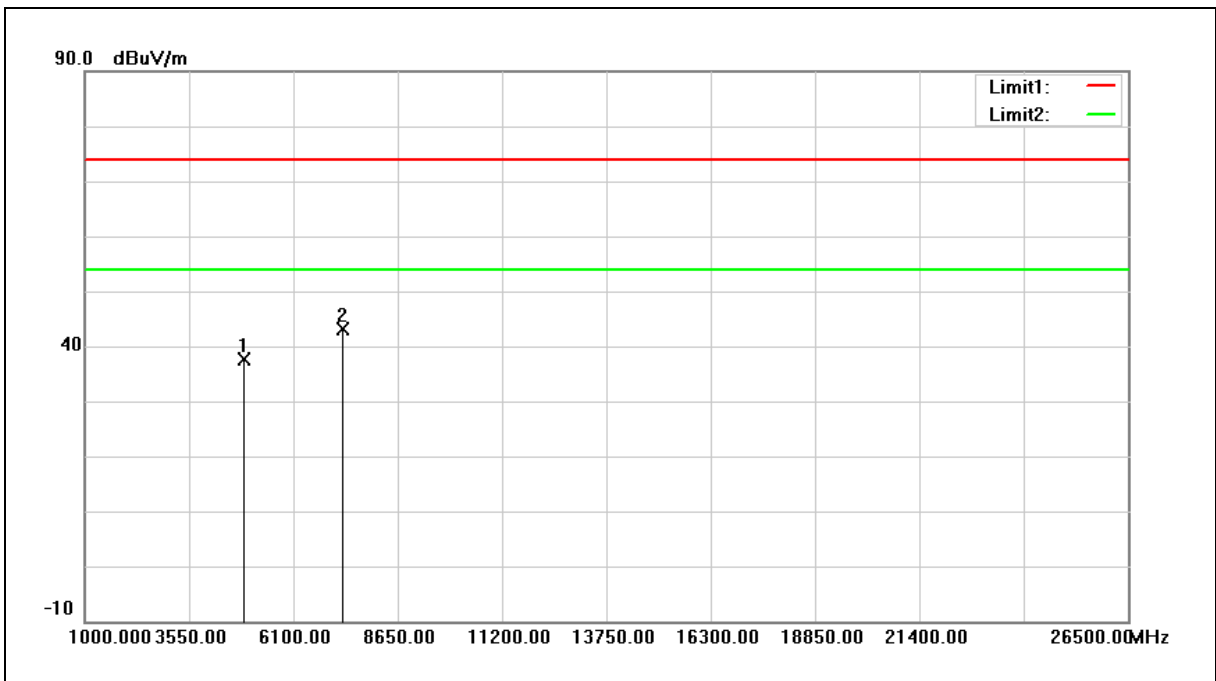

No.	Frequency (MHz)	Reading (dBuV)	Correct Factor (dB/m)	Result (dBuV/m)	Limit (dBuV/m)	Margin (dB)	Remark
1	4882.000	32.13	5.50	37.63	74.00	-36.37	peak
2	7323.000	30.33	12.83	43.16	74.00	-30.84	peak

Note: 1. Result (dBuV/m) = Correct Factor (dB/m) + Reading (dBuV).

2. Correction factor (dB/m) = Antenna Factor (dB/m) + Cable loss (dB) – Pre-Amplifier gain (dB).

3. When the peak results are less than average limit, so not need to evaluate the average.

Standard:	FCC Part 15.247	Test Distance:	3 m
Test item:	Harmonic		
Frequency:	2480 MHz		
Mode:	Mode 2		
Ant.Polar.:	Horizontal		

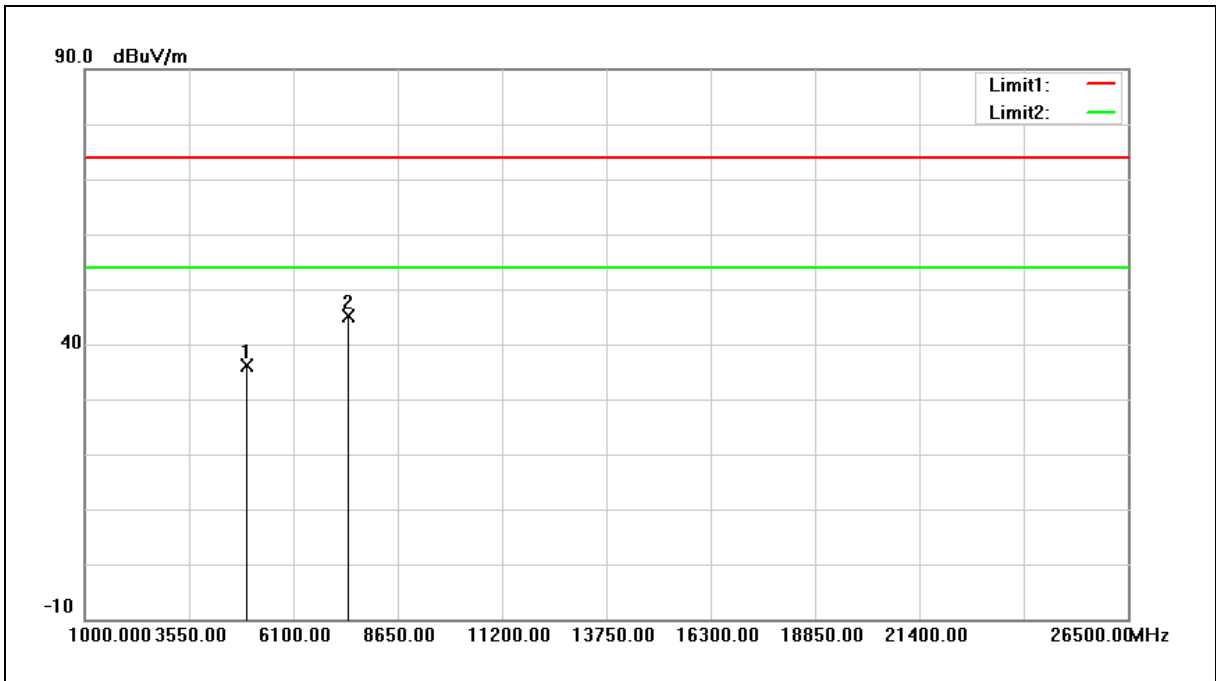

No.	Frequency (MHz)	Reading (dBuV)	Correct Factor (dB/m)	Result (dBuV/m)	Limit (dBuV/m)	Margin (dB)	Remark
1	4960.000	30.45	5.72	36.17	74.00	-37.83	peak
2	7440.000	31.93	13.10	45.03	74.00	-28.97	peak

Note: 1. Result (dBuV/m) = Correct Factor (dB/m) + Reading (dBuV).

2. Correction factor (dB/m) = Antenna Factor (dB/m) + Cable loss (dB) – Pre-Amplifier gain (dB).

3. When the peak results are less than average limit, so not need to evaluate the average.

Standard:	FCC Part 15.247	Test Distance:	3 m
Test item:	Harmonic		
Frequency:	2480 MHz		
Mode:	Mode 2		
Ant.Polar.:	Vertical		

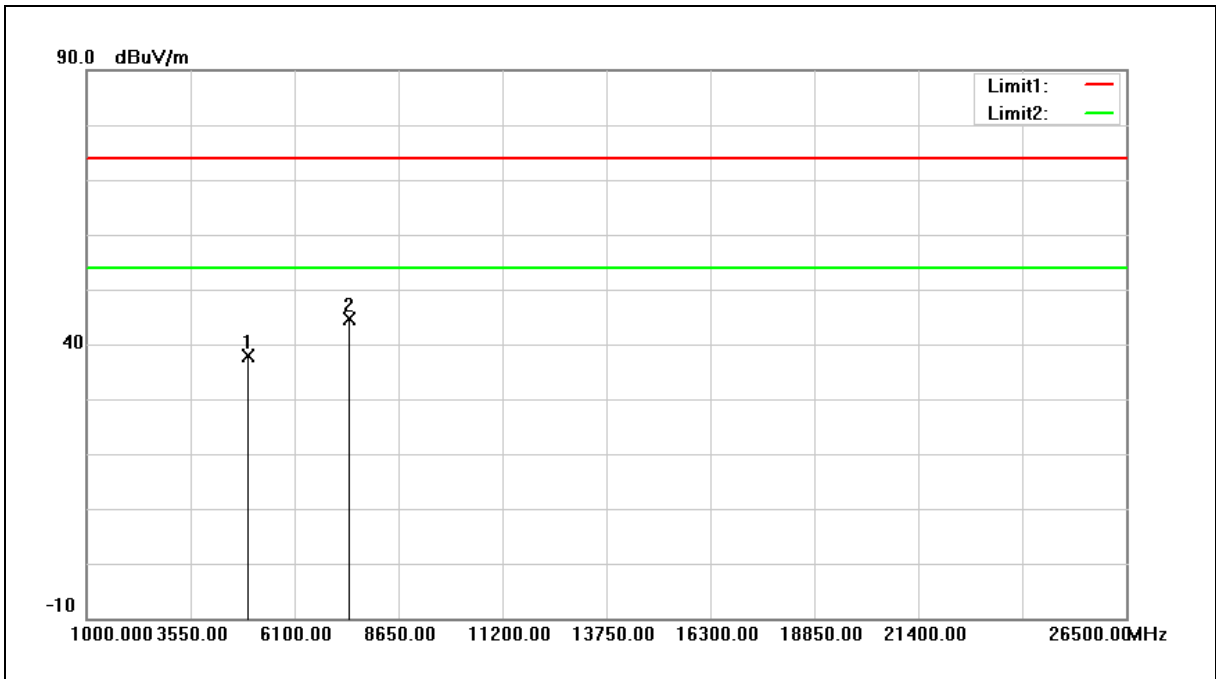

No.	Frequency (MHz)	Reading (dBuV)	Correct Factor (dB/m)	Result (dBuV/m)	Limit (dBuV/m)	Margin (dB)	Remark
1	4960.000	32.20	5.72	37.92	74.00	-36.08	peak
2	7440.000	31.45	13.10	44.55	74.00	-29.45	peak

Note: 1. Result (dBuV/m) = Correct Factor (dB/m) + Reading (dBuV).

2. Correction factor (dB/m) = Antenna Factor (dB/m) + Cable loss (dB) – Pre-Amplifier gain (dB).

3. When the peak results are less than average limit, so not need to evaluate the average.

Standard:	FCC Part 15.247	Test Distance:	3 m
Test item:	Harmonic		
Frequency:	2402 MHz		
Mode:	Mode 4		
Ant.Polar.:	Horizontal		

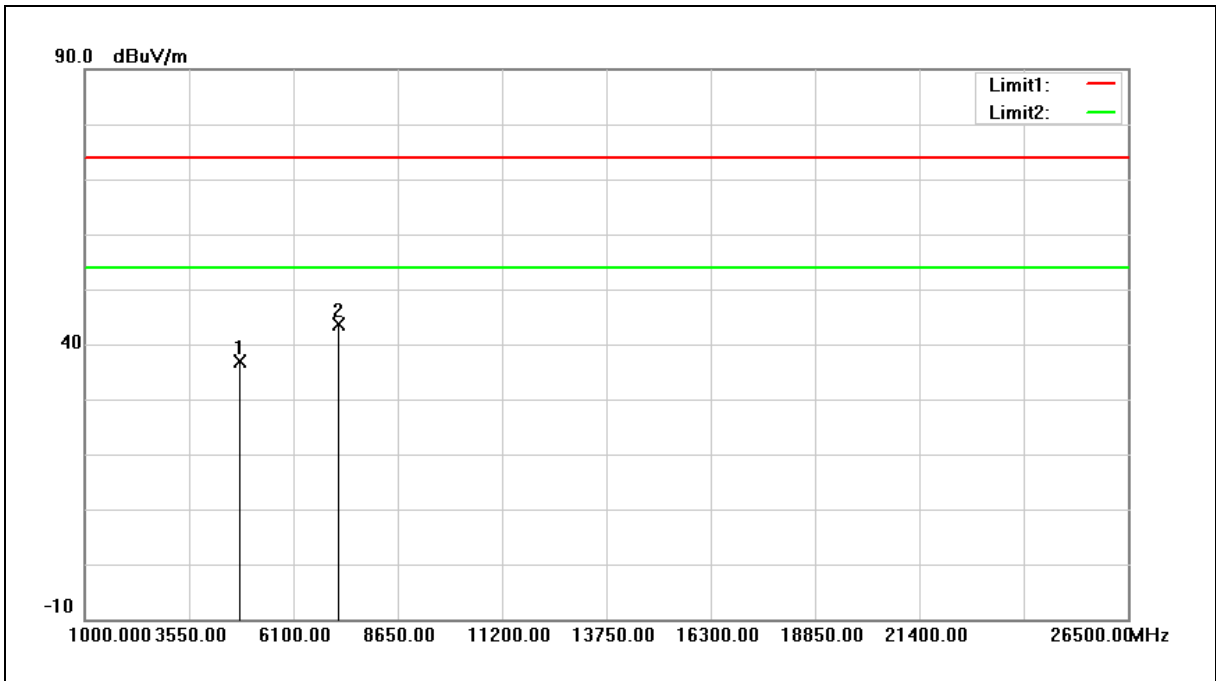

No.	Frequency (MHz)	Reading (dBuV)	Correct Factor (dB/m)	Result (dBuV/m)	Limit (dBuV/m)	Margin (dB)	Remark
1	4804.000	31.55	5.28	36.83	74.00	-37.17	peak
2	7206.000	31.17	12.56	43.73	74.00	-30.27	peak

Note: 1. Result (dBuV/m) = Correct Factor (dB/m) + Reading (dBuV).

2. Correction factor (dB/m) = Antenna Factor (dB/m) + Cable loss (dB) – Pre-Amplifier gain (dB).

3. When the peak results are less than average limit, so not need to evaluate the average.

Standard:	FCC Part 15.247	Test Distance:	3 m
Test item:	Harmonic		
Frequency:	2402 MHz		
Mode:	Mode 4		
Ant.Polar.:	Vertical		

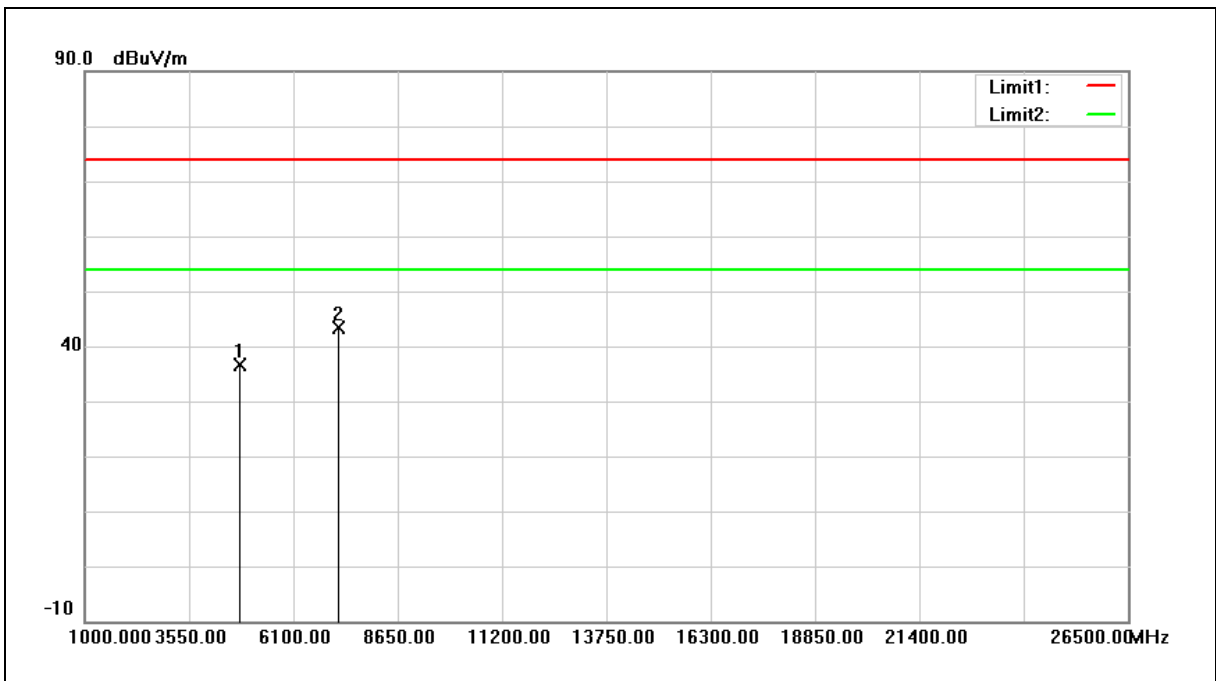

No.	Frequency (MHz)	Reading (dBuV)	Correct Factor (dB/m)	Result (dBuV/m)	Limit (dBuV/m)	Margin (dB)	Remark
1	4804.000	31.45	5.28	36.73	74.00	-37.27	peak
2	7206.000	30.85	12.56	43.41	74.00	-30.59	peak

Note: 1. Result (dBuV/m) = Correct Factor (dB/m) + Reading (dBuV).

2. Correction factor (dB/m) = Antenna Factor (dB/m) + Cable loss (dB) – Pre-Amplifier gain (dB).

3. When the peak results are less than average limit, so not need to evaluate the average.

Standard:	FCC Part 15.247	Test Distance:	3 m
Test item:	Harmonic		
Frequency:	2441 MHz		
Mode:	Mode 4		
Ant.Polar.:	Horizontal		

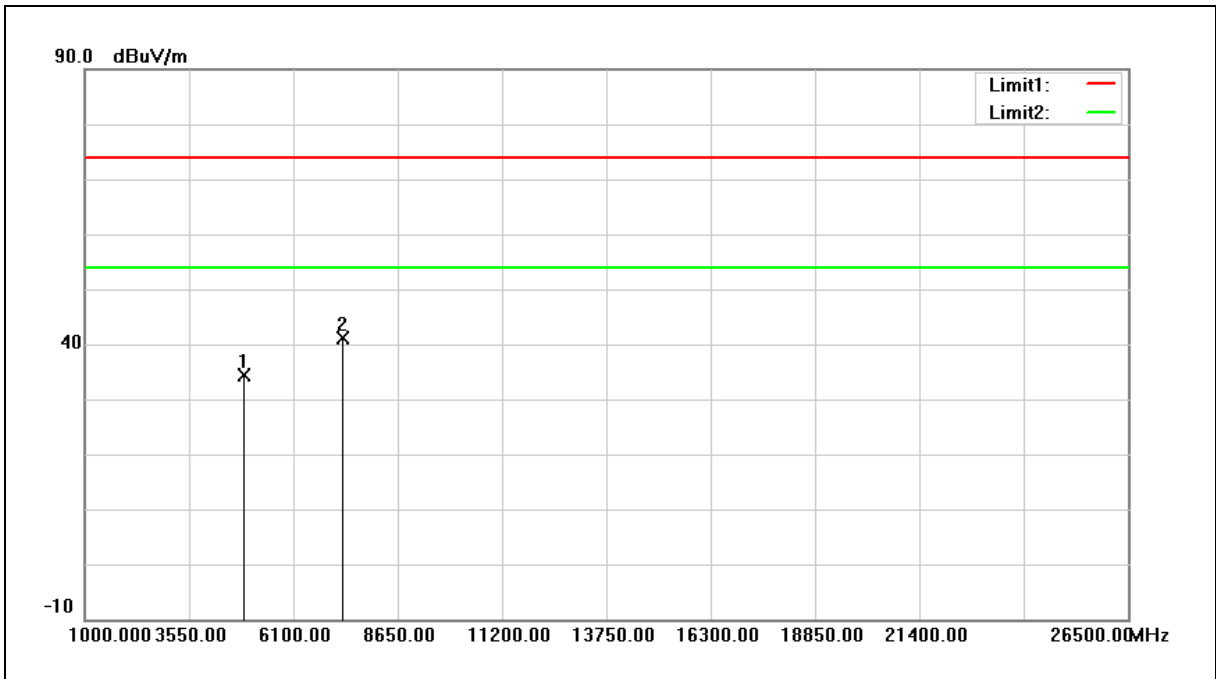

No.	Frequency (MHz)	Reading (dBuV)	Correct Factor (dB/m)	Result (dBuV/m)	Limit (dBuV/m)	Margin (dB)	Remark
1	4882.000	28.86	5.50	34.36	74.00	-39.64	peak
2	7323.000	28.32	12.83	41.15	74.00	-32.85	peak

Note: 1. Result (dBuV/m) = Correct Factor (dB/m) + Reading (dBuV).

2. Correction factor (dB/m) = Antenna Factor (dB/m) + Cable loss (dB) – Pre-Amplifier gain (dB).

3. When the peak results are less than average limit, so not need to evaluate the average.

Standard:	FCC Part 15.247	Test Distance:	3 m
Test item:	Harmonic		
Frequency:	2441 MHz		
Mode:	Mode 4		
Ant.Polar.:	Vertical		

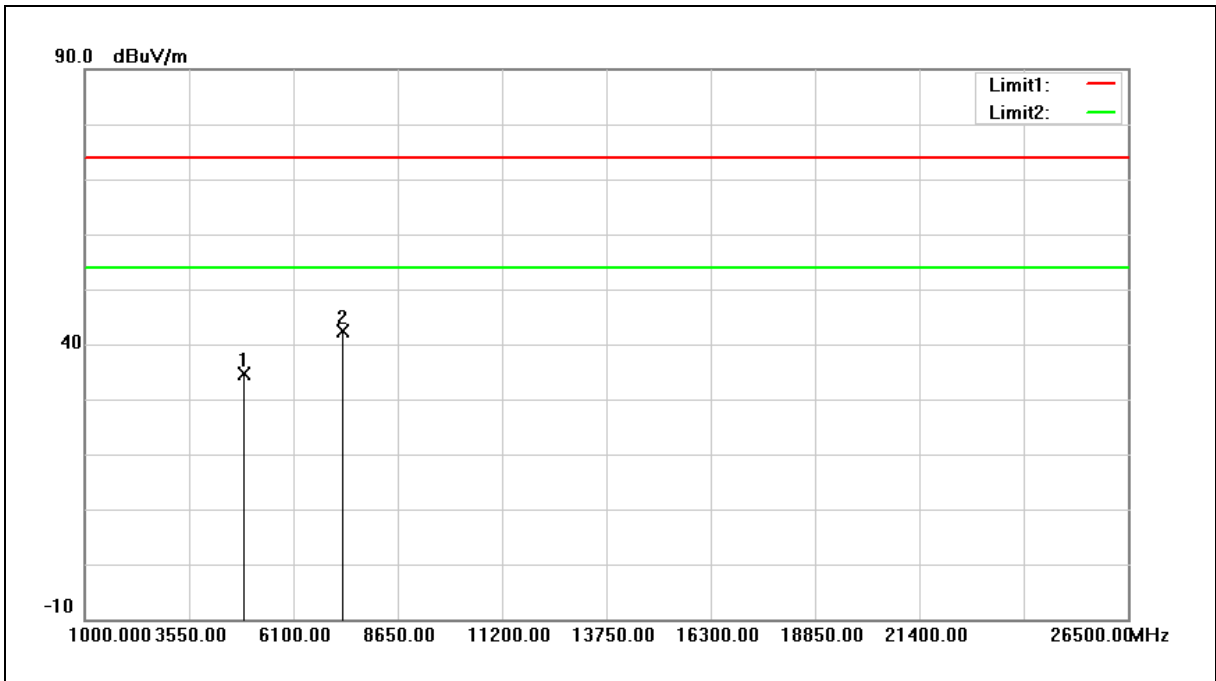

No.	Frequency (MHz)	Reading (dBuV)	Correct Factor (dB/m)	Result (dBuV/m)	Limit (dBuV/m)	Margin (dB)	Remark
1	4882.000	29.17	5.50	34.67	74.00	-39.33	peak
2	7323.000	29.58	12.83	42.41	74.00	-31.59	peak

Note: 1. Result (dBuV/m) = Correct Factor (dB/m) + Reading (dBuV).

2. Correction factor (dB/m) = Antenna Factor (dB/m) + Cable loss (dB) – Pre-Amplifier gain (dB).

3. When the peak results are less than average limit, so not need to evaluate the average.

Standard:	FCC Part 15.247	Test Distance:	3 m
Test item:	Harmonic		
Frequency:	2480 MHz		
Mode:	Mode 4		
Ant.Polar.:	Horizontal		

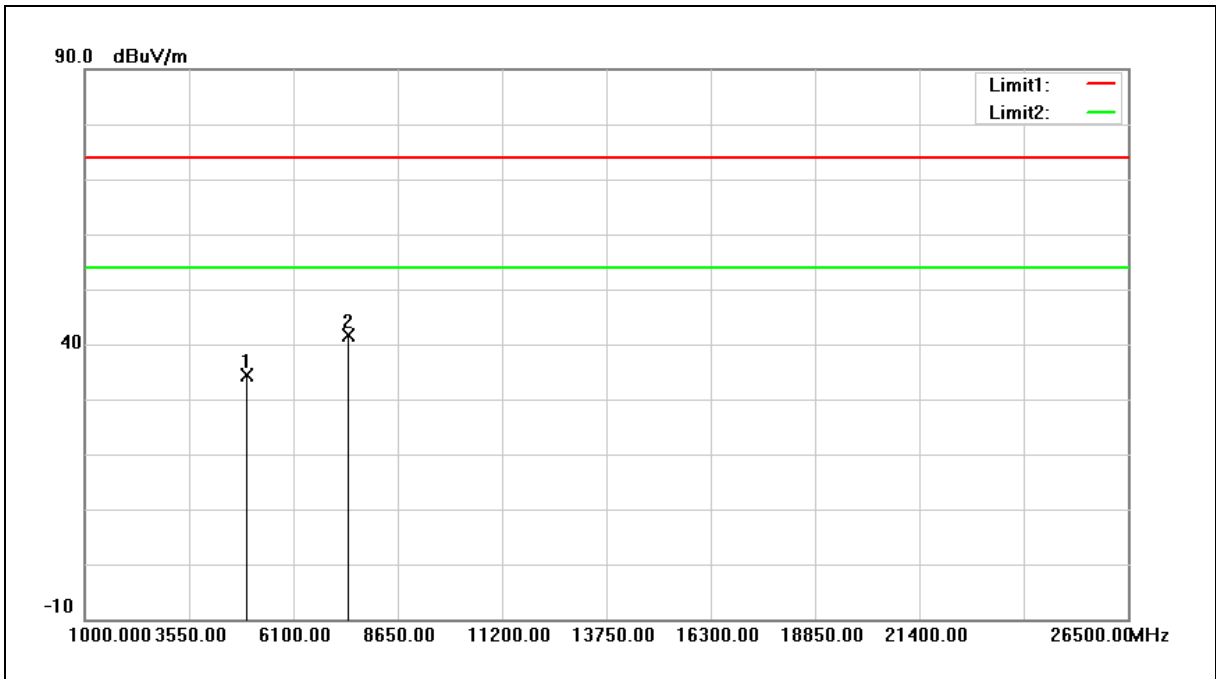

No.	Frequency (MHz)	Reading (dBuV)	Correct Factor (dB/m)	Result (dBuV/m)	Limit (dBuV/m)	Margin (dB)	Remark
1	4960.000	28.68	5.72	34.40	74.00	-39.60	peak
2	7440.000	28.49	13.10	41.59	74.00	-32.41	peak

Note: 1. Result (dBuV/m) = Correct Factor (dB/m) + Reading (dBuV).

2. Correction factor (dB/m) = Antenna Factor (dB/m) + Cable loss (dB) – Pre-Amplifier gain (dB).

3. When the peak results are less than average limit, so not need to evaluate the average.

Standard:	FCC Part 15.247	Test Distance:	3 m
Test item:	Harmonic		
Frequency:	2480 MHz		
Mode:	Mode 4		
Ant.Polar.:	Vertical		

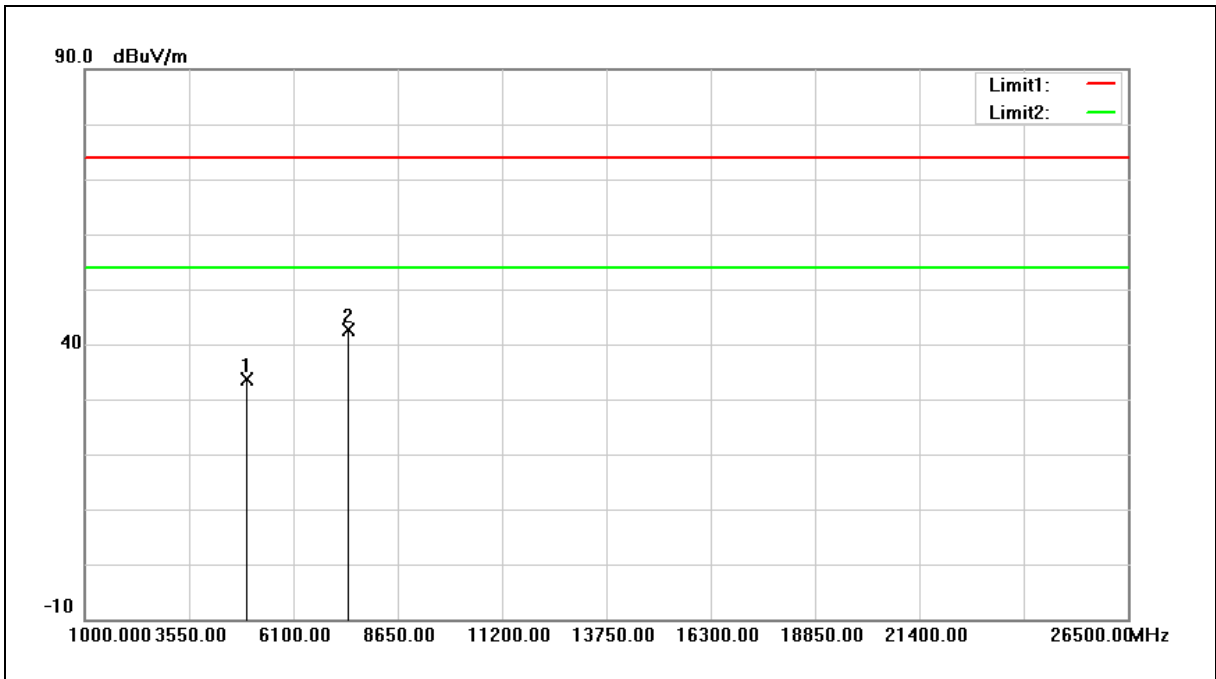

No.	Frequency (MHz)	Reading (dBuV)	Correct Factor (dB/m)	Result (dBuV/m)	Limit (dBuV/m)	Margin (dB)	Remark
1	4960.000	27.80	5.72	33.52	74.00	-40.48	peak
2	7440.000	29.56	13.10	42.66	74.00	-31.34	peak

Note: 1. Result (dBuV/m) = Correct Factor (dB/m) + Reading (dBuV).

2. Correction factor (dB/m) = Antenna Factor (dB/m) + Cable loss (dB) – Pre-Amplifier gain (dB).

3. When the peak results are less than average limit, so not need to evaluate the average.

Standard:	FCC Part 15.247	Test Distance:	3 m
Test item:	Harmonic		
Mode:	Simultaneous Transmitting (Bluetooth + WLAN 2.4 GHz)		
Ant.Polar.:	Horizontal		

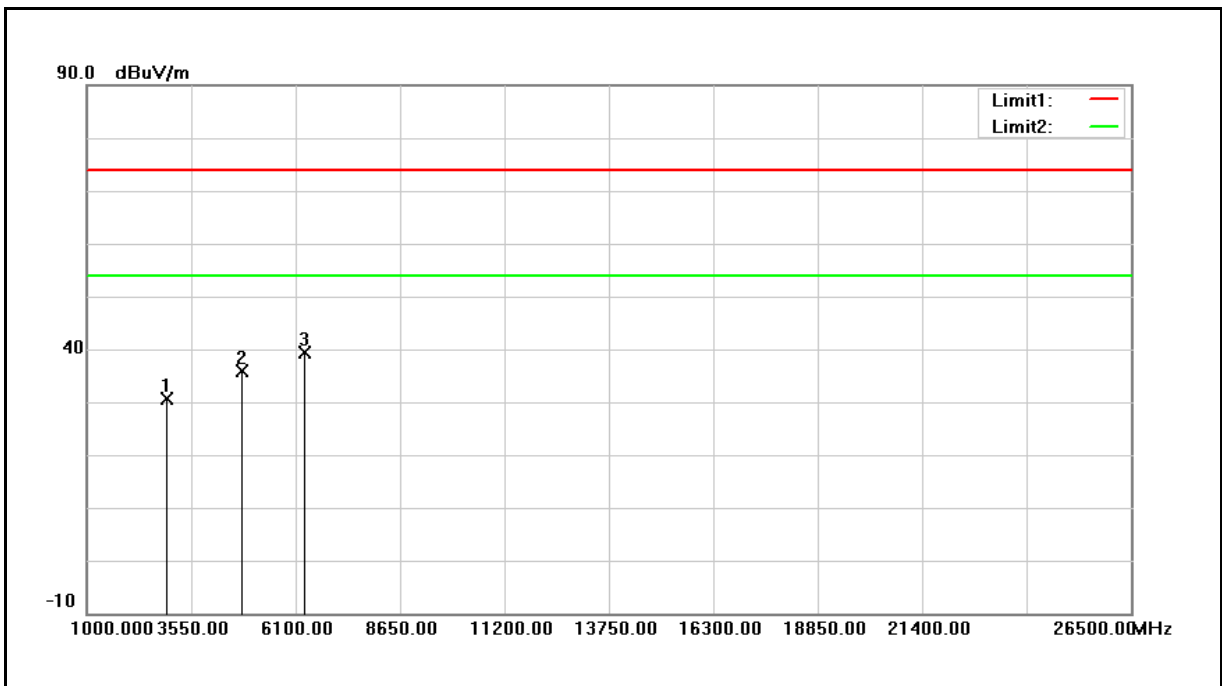

No.	Frequency (MHz)	Reading (dBuV)	Correct Factor (dB/m)	Result (dBuV/m)	Limit (dBuV/m)	Margin (dB)	Remark
1	2955.000	30.66	0.02	30.68	74.00	-43.32	peak
2	4774.000	30.79	5.19	35.98	74.00	-38.02	peak
3	6287.000	30.40	9.05	39.45	74.00	-34.55	peak

Note: 1. Result (dBuV/m) = Correct Factor (dB/m) + Reading (dBuV).

2. Correction factor (dB/m) = Antenna Factor (dB/m) + Cable loss (dB) – Pre-Amplifier gain (dB).

3. When the peak results are less than average limit, so not need to evaluate the average.

Standard:	FCC Part 15.247	Test Distance:	3 m
Test item:	Harmonic		
Mode:	Simultaneous Transmitting (Bluetooth + WLAN 2.4 GHz)		
Ant.Polar.:	Vertical		

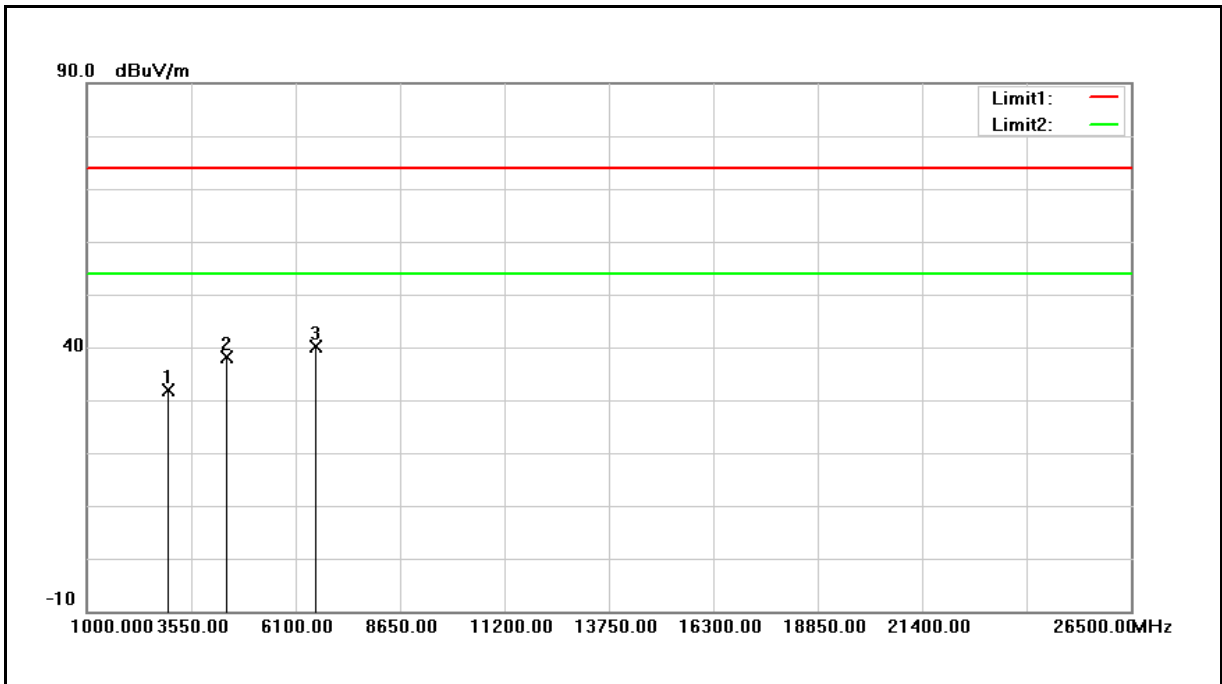

No.	Frequency (MHz)	Reading (dBuV)	Correct Factor (dB/m)	Result (dBuV/m)	Limit (dBuV/m)	Margin (dB)	Remark
1	2972.000	31.77	0.09	31.86	74.00	-42.14	peak
2	4417.000	33.91	4.27	38.18	74.00	-35.82	peak
3	6576.000	29.88	10.32	40.20	74.00	-33.80	peak

Note:1.Result (dBuV/m) = Correct Factor (dB/m) + Reading(dBuV).

2.Correction factor (dB/m) = Antenna Factor (dB/m) + Cable loss (dB) – Pre-Amplifier gain (dB).

3.When the peak results are less than average limit, so not need to evaluate the average.

Band Edge

Standard:	FCC Part 15.247	Test Distance:	3 m
Test item:	Band edge		
Frequency:	2402 MHz		
Mode:	Mode 2		
Ant.Polar.:	Horizontal		

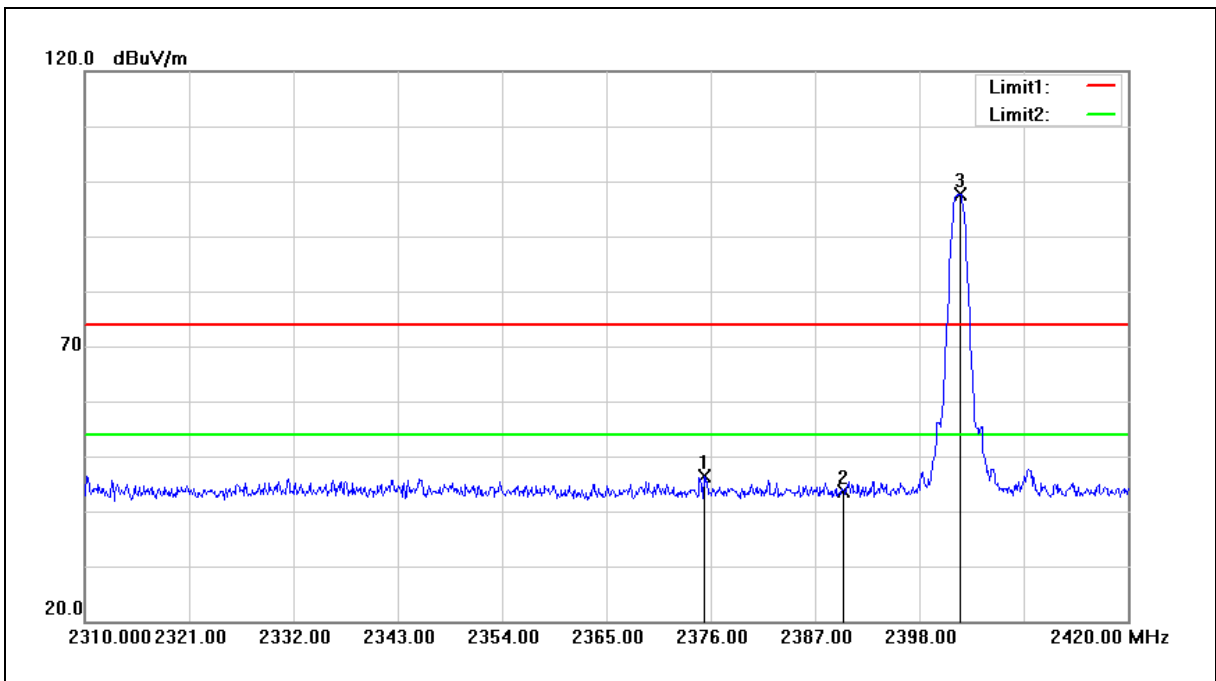

No.	Frequency (MHz)	Reading (dBuV)	Correct Factor (dB/m)	Result (dBuV/m)	Limit (dBuV/m)	Margin (dB)	Remark
1	2375.340	48.51	-2.21	46.30	74.00	-27.70	peak
2	2390.000	45.69	-2.15	43.54	74.00	-30.46	peak
3	2402.290	99.75	-2.10	97.65	74.00	23.65	peak

Note:1.Result (dBuV/m) = Correct Factor (dB/m) + Reading(dBuV).

2.Correction factor (dB/m) = Antenna Factor (dB/m) + Cable loss (dB) – Pre-Amplifier gain (dB).

3.When the peak results are less than average limit, so not need to evaluate the average.

Standard:	FCC Part 15.247	Test Distance:	3 m
Test item:	Band edge		
Frequency:	2402 MHz		
Mode:	Mode 2		
Ant.Polar.:	Vertical		

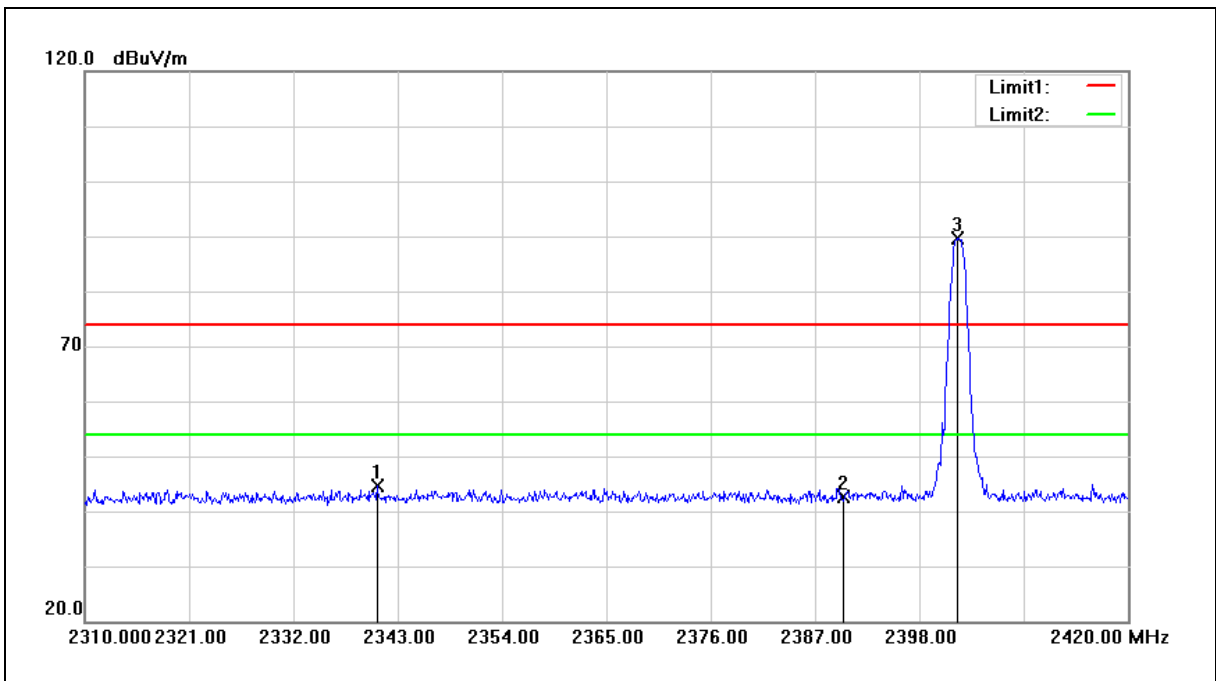

No.	Frequency (MHz)	Reading (dBuV)	Correct Factor (dB/m)	Result (dBuV/m)	Limit (dBuV/m)	Margin (dB)	Remark
1	2340.800	46.94	-2.36	44.58	74.00	-29.42	peak
2	2390.000	44.77	-2.15	42.62	74.00	-31.38	peak
3	2402.070	91.62	-2.10	89.52	74.00	15.52	peak

Note:1.Result (dBuV/m) = Correct Factor (dB/m) + Reading(dBuV).

2.Correction factor (dB/m) = Antenna Factor (dB/m) + Cable loss (dB) – Pre-Amplifier gain (dB).

3.When the peak results are less than average limit, so not need to evaluate the average.

Standard:	FCC Part 15.247	Test Distance:	3 m
Test item:	Band edge		
Frequency:	2480 MHz		
Mode:	Mode 2		
Ant.Polar.:	Horizontal		

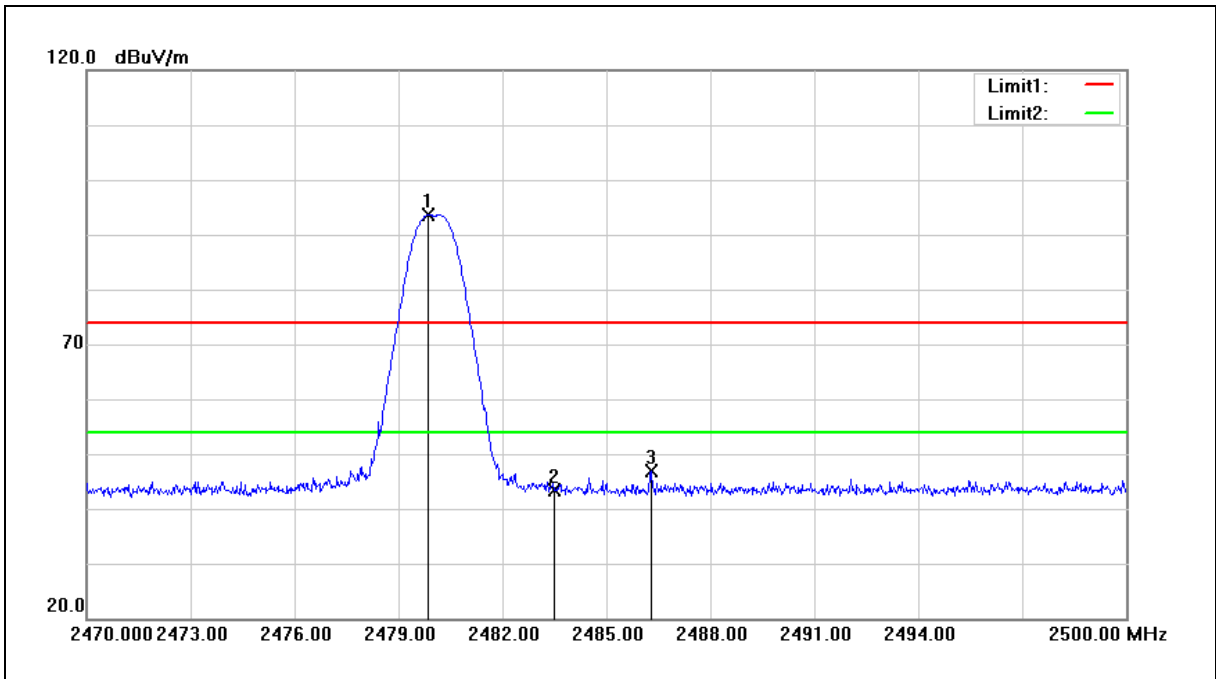

No.	Frequency (MHz)	Reading (dBuV)	Correct Factor (dB/m)	Result (dBuV/m)	Limit (dBuV/m)	Margin (dB)	Remark
1	2479.840	95.41	-1.78	93.63	74.00	19.63	peak
2	2483.500	45.24	-1.76	43.48	74.00	-30.52	peak
3	2486.290	48.66	-1.75	46.91	74.00	-27.09	peak

Note:1.Result (dBuV/m) = Correct Factor (dB/m) + Reading(dBuV).

2.Correction factor (dB/m) = Antenna Factor (dB/m) + Cable loss (dB) – Pre-Amplifier gain (dB).

3.When the peak results are less than average limit, so not need to evaluate the average.

Standard:	FCC Part 15.247	Test Distance:	3 m
Test item:	Band edge		
Frequency:	2480 MHz		
Mode:	Mode 2		
Ant.Polar.:	Vertical		

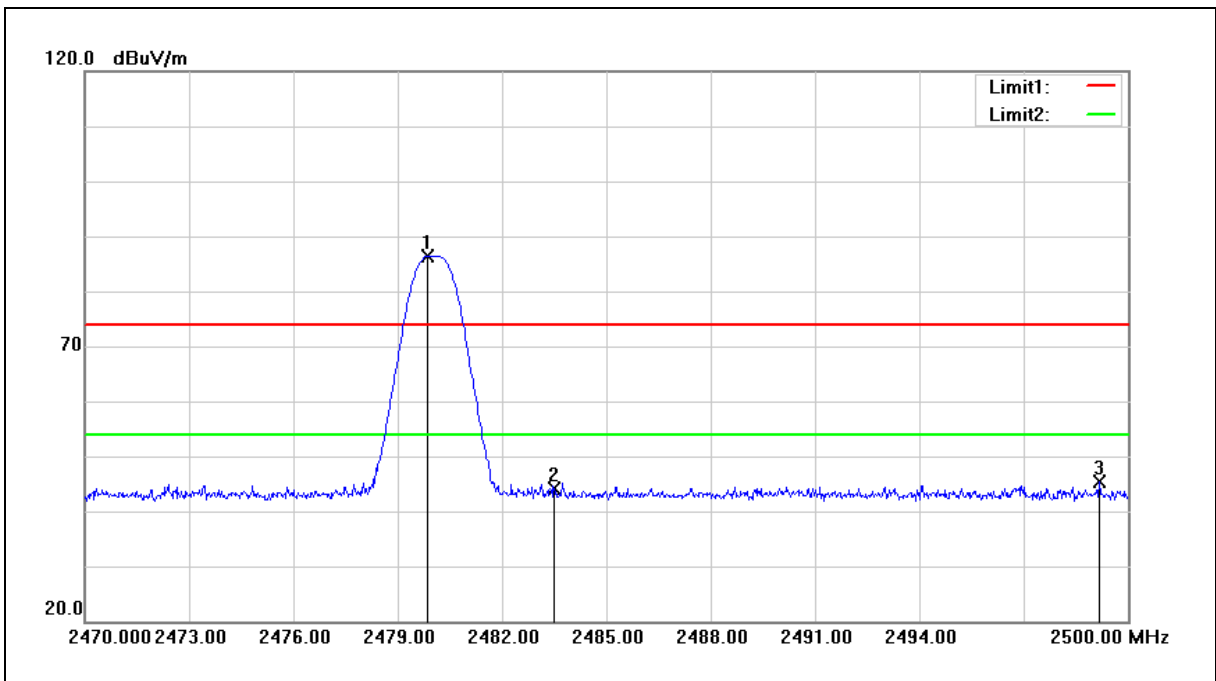

No.	Frequency (MHz)	Reading (dBuV)	Correct Factor (dB/m)	Result (dBuV/m)	Limit (dBuV/m)	Margin (dB)	Remark
1	2479.870	88.23	-1.78	86.45	74.00	12.45	peak
2	2483.500	45.98	-1.76	44.22	74.00	-29.78	peak
3	2499.190	47.01	-1.69	45.32	74.00	-28.68	peak

Note:1.Result (dBuV/m) = Correct Factor (dB/m) + Reading(dBuV).

2.Correction factor (dB/m) = Antenna Factor (dB/m) + Cable loss (dB) – Pre-Amplifier gain (dB).

3.When the peak results are less than average limit, so not need to evaluate the average.

Standard:	FCC Part 15.247	Test Distance:	3m
Test item:	Band edge		
Frequency:	hopping		
Mode:	Mode 2		
Ant.Polar.:	Horizontal		

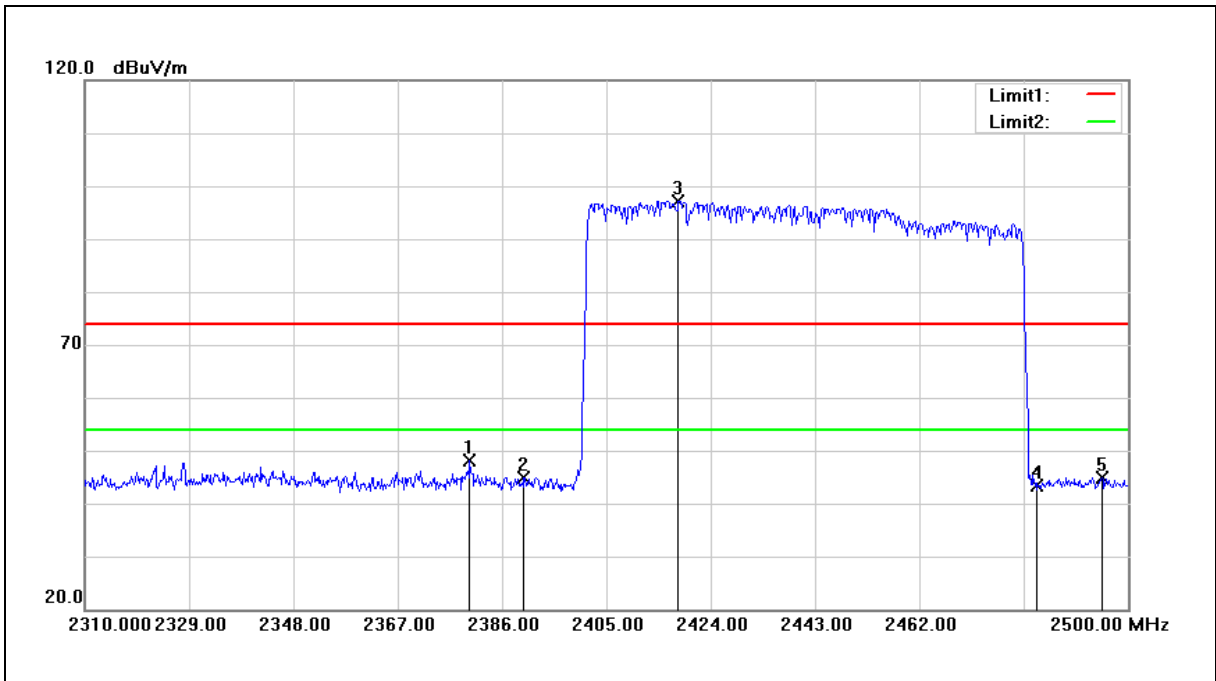

No.	Frequency (MHz)	Reading (dBuV)	Correct Factor (dB/m)	Result (dBuV/m)	Limit (dBuV/m)	Margin (dB)	Remark
1	2380.110	50.22	-2.20	48.02	74.00	-25.98	peak
2	2390.000	47.04	-2.15	44.89	74.00	-29.11	peak
3	2418.110	99.22	-2.03	97.19	74.00	23.19	peak
4	2483.500	45.11	-1.76	43.35	74.00	-30.65	peak
5	2495.250	46.64	-1.71	44.93	74.00	-29.07	peak

Note:1.Result (dBuV/m) = Correct Factor (dB/m) + Reading(dBuV).

2.Correction factor (dB/m) = Antenna Factor (dB/m) + Cable loss (dB) – Pre-Amplifier gain (dB).

3. When the peak results are less than average limit, so not need to evaluate the average.

Standard:	FCC Part 15.247	Test Distance:	3m
Test item:	Band edge		
Frequency:	hopping		
Mode:	Mode 2		
Ant.Polar.:	Vertical		

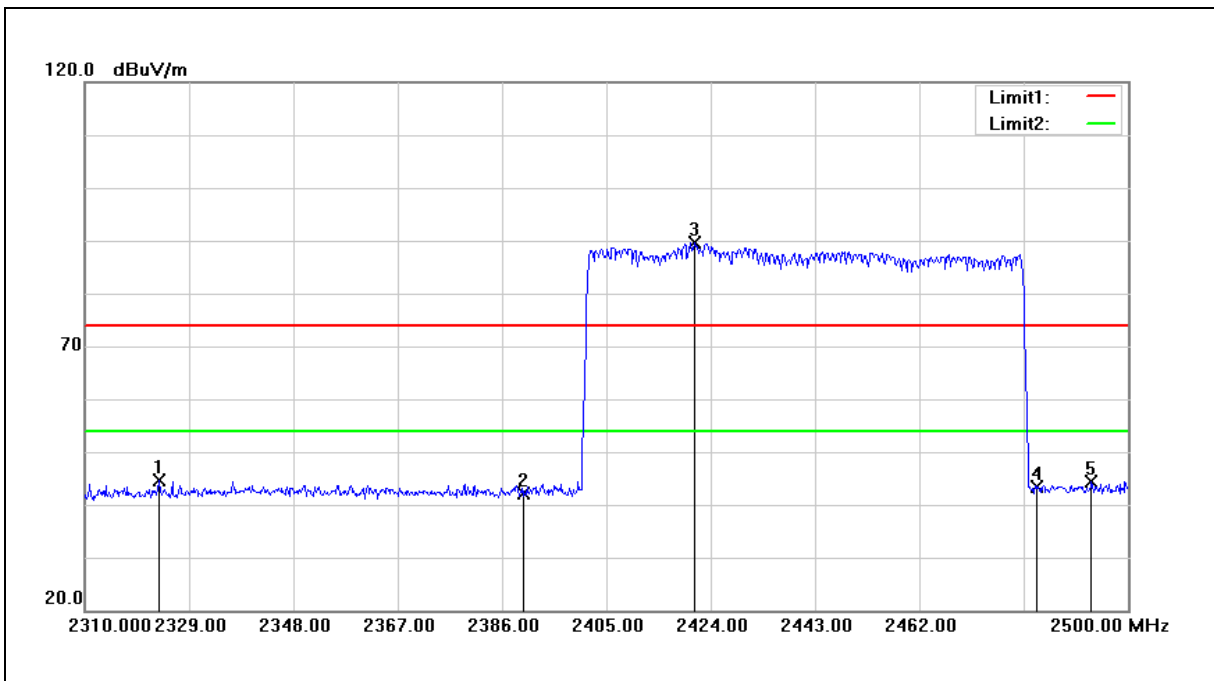

No.	Frequency (MHz)	Reading (dBuV)	Correct Factor (dB/m)	Result (dBuV/m)	Limit (dBuV/m)	Margin (dB)	Remark
1	2323.490	46.97	-2.43	44.54	74.00	-29.46	peak
2	2390.000	44.16	-2.15	42.01	74.00	-31.99	peak
3	2421.150	91.56	-2.02	89.54	74.00	15.54	peak
4	2483.500	45.10	-1.76	43.34	74.00	-30.66	peak
5	2493.350	45.99	-1.72	44.27	74.00	-29.73	peak

Note:1.Result (dBuV/m) = Correct Factor (dB/m) + Reading(dBuV).

2.Correction factor (dB/m) = Antenna Factor (dB/m) + Cable loss (dB) – Pre-Amplifier gain (dB).

3. When the peak results are less than average limit, so not need to evaluate the average.

Standard:	FCC Part 15.247	Test Distance:	3 m
Test item:	Band edge		
Frequency:	2402 MHz		
Mode:	Mode 4		
Ant.Polar.:	Horizontal		

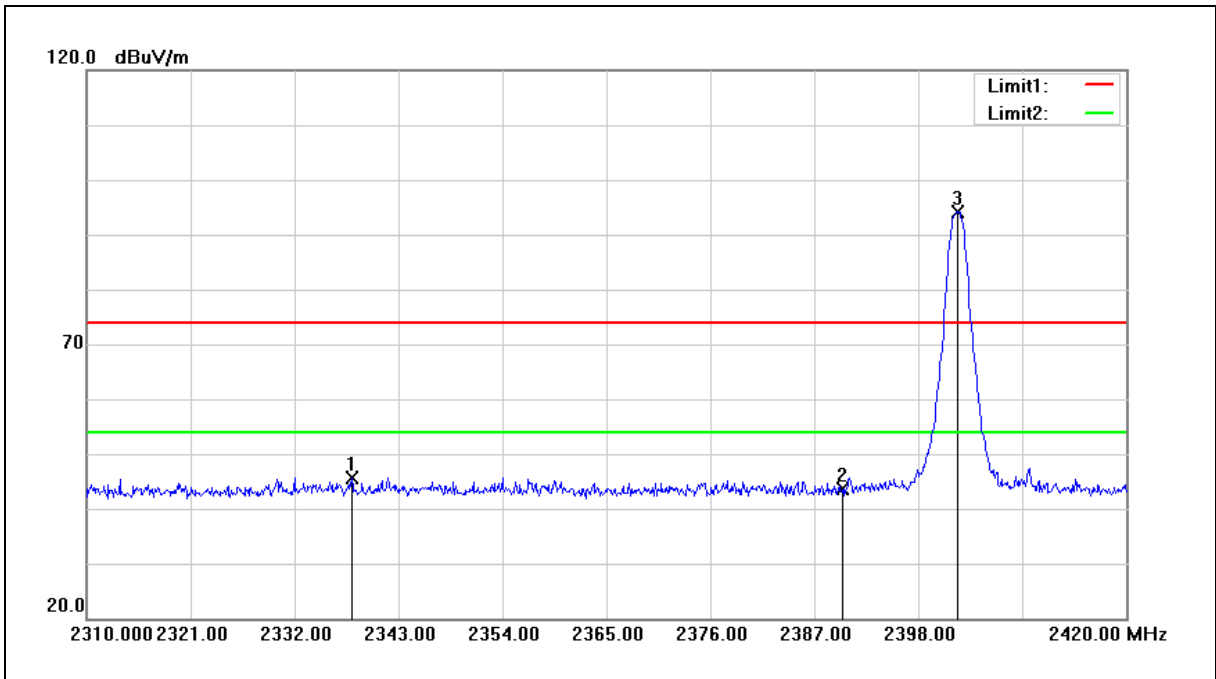

No.	Frequency (MHz)	Reading (dBuV)	Correct Factor (dB/m)	Result (dBuV/m)	Limit (dBuV/m)	Margin (dB)	Remark
1	2338.050	48.06	-2.37	45.69	74.00	-28.31	peak
2	2390.000	45.77	-2.15	43.62	74.00	-30.38	peak
3	2402.180	96.33	-2.10	94.23	74.00	20.23	peak

Note:1.Result (dBuV/m) = Correct Factor (dB/m) + Reading(dBuV).

2.Correction factor (dB/m) = Antenna Factor (dB/m) + Cable loss (dB) – Pre-Amplifier gain (dB).

3.When the peak results are less than average limit, so not need to evaluate the average.

Standard:	FCC Part 15.247	Test Distance:	3 m
Test item:	Band edge		
Frequency:	2402 MHz		
Mode:	Mode 4		
Ant.Polar.:	Vertical		

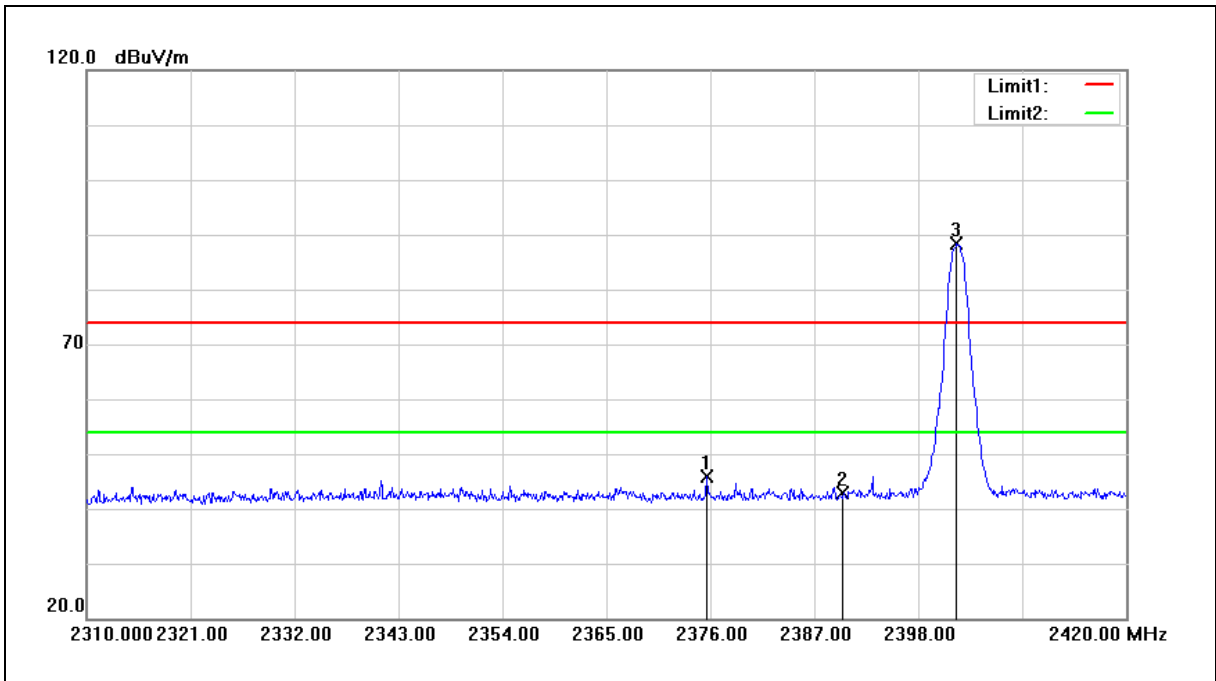

No.	Frequency (MHz)	Reading (dBuV)	Correct Factor (dB/m)	Result (dBuV/m)	Limit (dBuV/m)	Margin (dB)	Remark
1	2375.560	48.14	-2.21	45.93	74.00	-28.07	peak
2	2390.000	44.94	-2.15	42.79	74.00	-31.21	peak
3	2402.070	90.45	-2.10	88.35	74.00	14.35	peak

Note:1.Result (dBuV/m) = Correct Factor (dB/m) + Reading(dBuV).

2.Correction factor (dB/m) = Antenna Factor (dB/m) + Cable loss (dB) – Pre-Amplifier gain (dB).

3.When the peak results are less than average limit, so not need to evaluate the average.

Standard:	FCC Part 15.247	Test Distance:	3 m
Test item:	Band edge		
Frequency:	2480 MHz		
Mode:	Mode 4		
Ant.Polar.:	Horizontal		

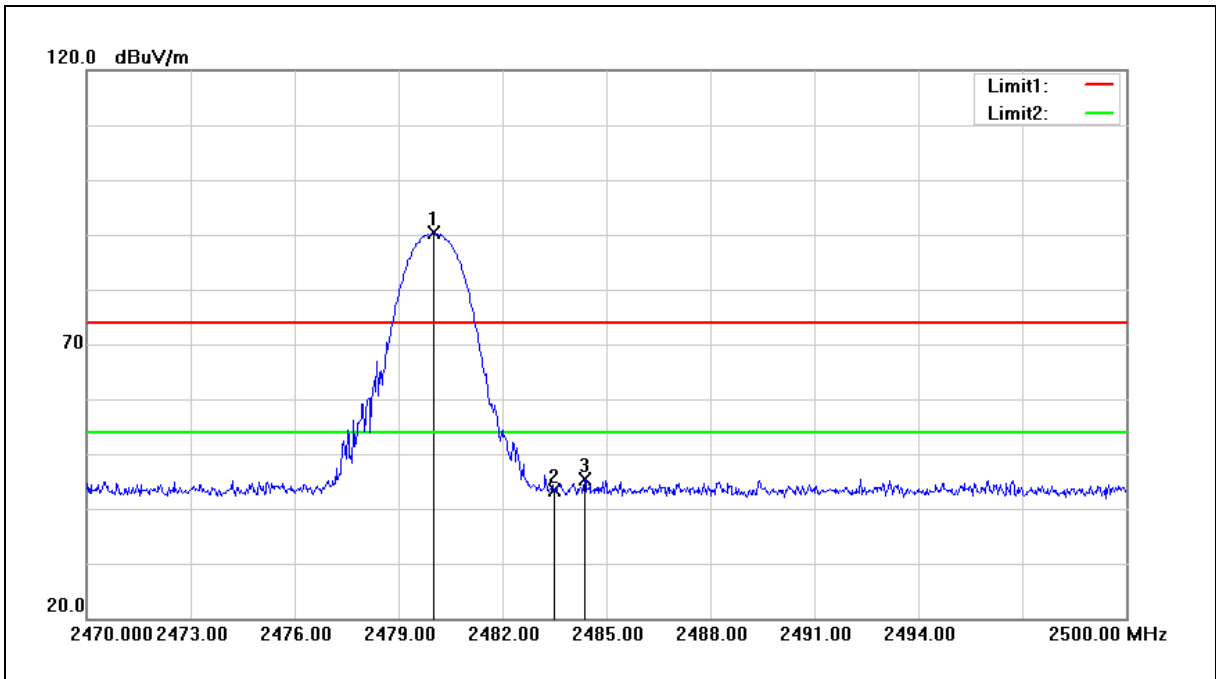

No.	Frequency (MHz)	Reading (dBuV)	Correct Factor (dB/m)	Result (dBuV/m)	Limit (dBuV/m)	Margin (dB)	Remark
1	2480.020	92.16	-1.78	90.38	74.00	16.38	peak
2	2483.500	45.23	-1.76	43.47	74.00	-30.53	peak
3	2484.370	47.21	-1.75	45.46	74.00	-28.54	peak

Note:1.Result (dBuV/m) = Correct Factor (dB/m) + Reading(dBuV).

2.Correction factor (dB/m) = Antenna Factor (dB/m) + Cable loss (dB) – Pre-Amplifier gain (dB).

3.When the peak results are less than average limit, so not need to evaluate the average.

Standard:	FCC Part 15.247	Test Distance:	3 m
Test item:	Band edge		
Frequency:	2480 MHz		
Mode:	Mode 4		
Ant.Polar.:	Vertical		

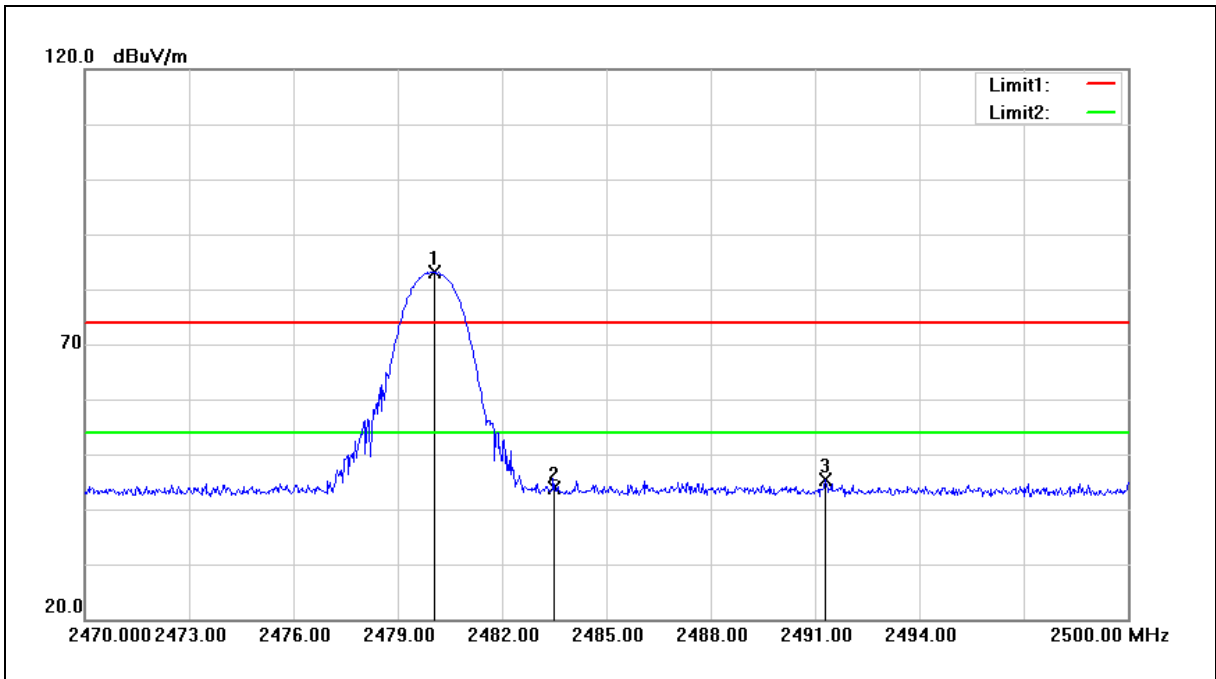

No.	Frequency (MHz)	Reading (dBuV)	Correct Factor (dB/m)	Result (dBuV/m)	Limit (dBuV/m)	Margin (dB)	Remark
1	2480.050	84.94	-1.78	83.16	74.00	9.16	peak
2	2483.500	45.53	-1.76	43.77	74.00	-30.23	peak
3	2491.300	47.14	-1.72	45.42	74.00	-28.58	peak

Note:1.Result (dBuV/m) = Correct Factor (dB/m) + Reading(dBuV).

2.Correction factor (dB/m) = Antenna Factor (dB/m) + Cable loss (dB) – Pre-Amplifier gain (dB).

3.When the peak results are less than average limit, so not need to evaluate the average.

Standard:	FCC Part 15.247	Test Distance:	3m
Test item:	Band edge		
Frequency:	hopping		
Mode:	Mode 4		
Ant.Polar.:	Horizontal		

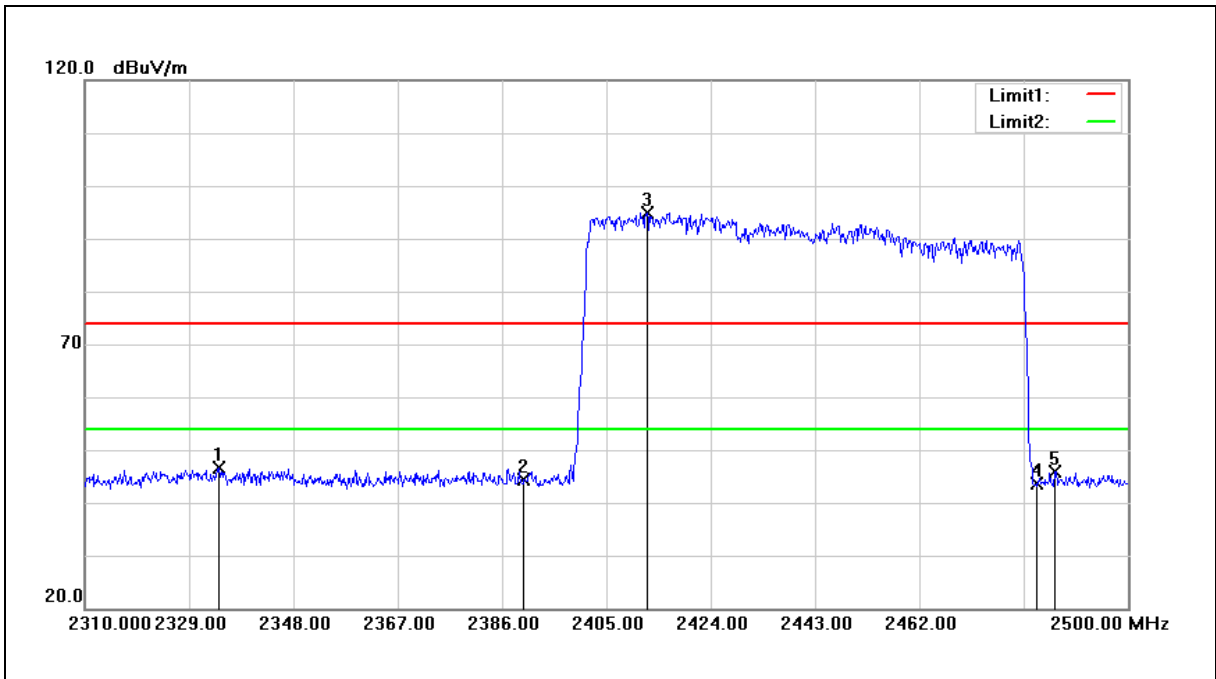

No.	Frequency (MHz)	Reading (dBuV)	Correct Factor (dB/m)	Result (dBuV/m)	Limit (dBuV/m)	Margin (dB)	Remark
1	2334.510	48.90	-2.38	46.52	74.00	-27.48	peak
2	2390.000	46.49	-2.15	44.34	74.00	-29.66	peak
3	2412.410	96.90	-2.06	94.84	74.00	20.84	peak
4	2483.500	45.50	-1.76	43.74	74.00	-30.26	peak
5	2486.700	47.66	-1.75	45.91	74.00	-28.09	peak

Note:1.Result (dBuV/m) = Correct Factor (dB/m) + Reading(dBuV).

2.Correction factor (dB/m) = Antenna Factor (dB/m) + Cable loss (dB) – Pre-Amplifier gain (dB).

3. When the peak results are less than average limit, so not need to evaluate the average.

Standard:	FCC Part 15.247	Test Distance:	3m
Test item:	Band edge		
Frequency:	hopping		
Mode:	Mode 4		
Ant.Polar.:	Vertical		

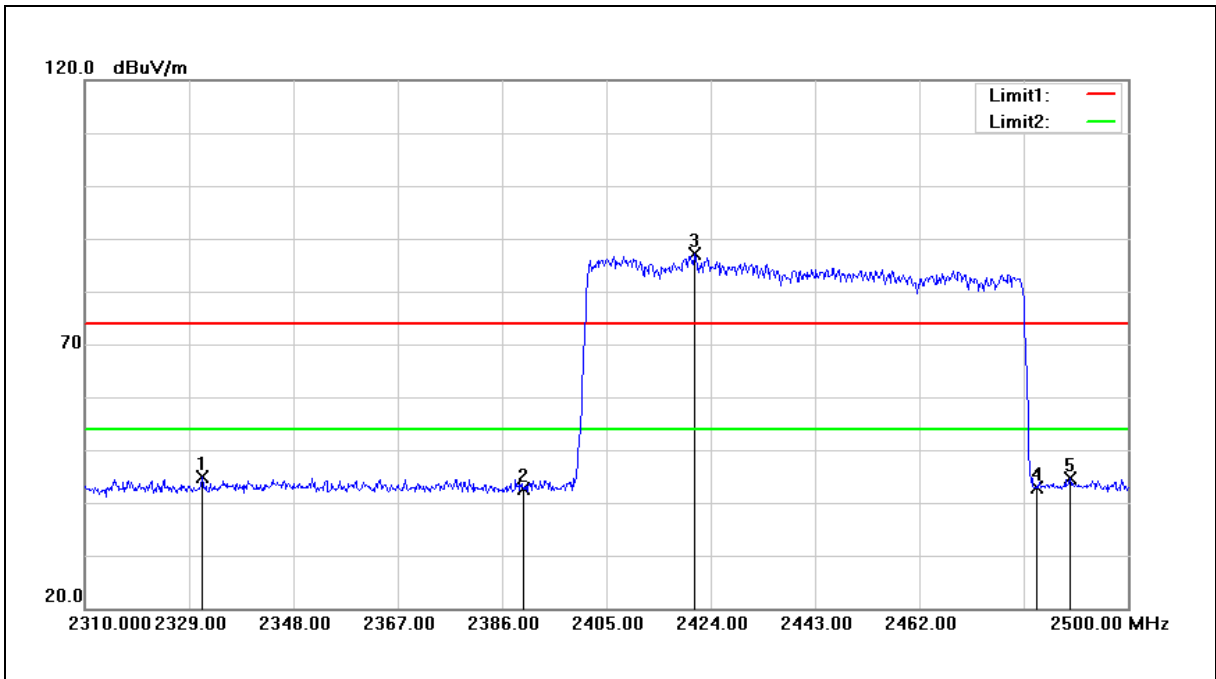

No.	Frequency (MHz)	Reading (dBuV)	Correct Factor (dB/m)	Result (dBuV/m)	Limit (dBuV/m)	Margin (dB)	Remark
1	2331.280	47.30	-2.40	44.90	74.00	-29.10	peak
2	2390.000	44.78	-2.15	42.63	74.00	-31.37	peak
3	2421.150	89.16	-2.02	87.14	74.00	13.14	peak
4	2483.500	44.74	-1.76	42.98	74.00	-31.02	peak
5	2489.550	46.43	-1.73	44.70	74.00	-29.30	peak

Note:1.Result (dBuV/m) = Correct Factor (dB/m) + Reading(dBuV).

2.Correction factor (dB/m) = Antenna Factor (dB/m) + Cable loss (dB) – Pre-Amplifier gain (dB).

3. When the peak results are less than average limit, so not need to evaluate the average.

---END---