



RADIO TEST REPORT

Report No.:STS2001235W11

Issued for

Winmate Inc.

9F, No.111-6, Shing-De Rd., San-Chung Dist., New Taipei City, 24158, Taiwan, R.O.C

Product Name:	Rugged Tablet PC
Brand Name:	Winmate
Model Name:	M101P-BH
Series Model:	RT10W-L00,M101PXXXXXXXXXXXX(Where X can be A-Z,a-z ,0-9, “-”, Blank or Slash)
FCC ID:	PX9M101PH001
Test Standard:	FCC Part 15.407

Any reproduction of this document must be done in full. No single part of this document may be reproduced without permission from STS, All Test Data Presented in this report is only applicable to presented Test sample.

Shenzhen STS Test Services Co., Ltd.
A 1/F, Building B, Zhuoke Science Park, No.190 Chongqing Road, HepingShequ, Fuyong Sub-District, Bao'an District, Shenzhen, Guang Dong, China
TEL: +86-755 3688 6288 FAX: +86-755 3688 6277 E-mail:sts@stsapp.com



STSLAB



TEST RESULT CERTIFICATION

Applicant's Name..... : Winmate Inc.
 Address : 9F, No.111-6, Shing-De Rd., San-Chung Dist., New Taipei City, 24158, Taiwan, R.O.C
Manufacture's Name..... : Winmate Inc.
 Address : 9F, No.111-6, Shing-De Rd., San-Chung Dist., New Taipei City, 24158, Taiwan, R.O.C

Product Description

Product Name..... : Rugged Tablet PC
 Brand Name : Winmate
 Model Name : M101P-BH
 Series Model..... : RT10W-L00,M101PXXXXXXXXXXXX(Where X can be A-Z,a-z ,0-9, "-", Blank or Slash)

Test Standards..... : FCC Part15.407

Test Procedure.....ANSI C63.10-2013

This device described above has been tested by STS, the test results show that the equipment under test (EUT) is in compliance with the FCC requirements. And it is applicable only to the tested sample identified in the report.

This report shall not be reproduced except in full, without the written approval of STS, this document only be altered or revised by STS, personal only, and shall be noted in the revision of the document.

Date of Test..... :
 Date of receipt of test item : 20 Jan. 2020
 Date (s) of performance of tests : 20 Jan. 2020 ~ 08 Apr. 2020
 Date of Issue..... : 08 Apr. 2020
 Test Result..... : **Pass**

Testing Engineer : 

 (Chris Chen)

Technical Manager : 

 (Sean she)

Authorized Signatory : 

 (Vita Li)





Table of Contents	Page
1 . SUMMARY OF TEST RESULTS	6
1.1 TEST FACTORY	7
1.2 MEASUREMENT UNCERTAINTY	7
2 . GENERAL INFORMATION	8
2.1 GENERAL DESCRIPTION OF THE EUT	8
2.2 DESCRIPTION OF TEST MODES	12
2.3 BLOCK DIGRAM SHOWING THE CONFIGURATION OF SYSTEM TESTED	13
2.4 DESCRIPTION OF NECESSARY ACCESSORIES AND SUPPORT UNITS	14
2.5 EQUIPMENTS LIST FOR ALL TEST ITEMS	15
3 . EMC EMISSION TEST	16
3.1 CONDUCTED EMISSION MEASUREMENT	16
3.2 RADIATED EMISSION AND (BANDEDGE) MEASUREMENT	20
4. CONDUCTED SPURIOUS EMISSIONS AND BANDEDGE	41
4.1 LIMIT	41
4.2 TEST PROCEDURE	41
4.3 DEVIATION FROM STANDARD	41
4.4 TEST SETUP	42
4.5 EUT OPERATION CONDITIONS	42
4.6 TEST RESULTS	42
5. POWER SPECTRAL DENSITY TEST	43
5.1 LIMIT	43
5.2 TEST PROCEDURE	43
5.3 DEVIATION FROM STANDARD	44
5.4 TEST SETUP	44
5.5 EUT OPERATION CONDITIONS	44
5.6 TEST RESULTS	44
6. BANDWIDTH MEASUREMENT	48
6.1 EMISSION BANDWIDTH (EBW) 26 BANDWID PROCEDURES / LIMIT	48
6.2 OCCUPIED BANDWIDTH (99%) TEST APPLIED PROCEDURES / LIMIT	51
6.3 MINIMUM EMISSION BANDWIDTH(6 DB) PROCEDURES / LIMIT	54
7. MAXIMUM CONDUCTED OUTPUT POWER	56
7.1 LIMIT	56
7.2 TEST PROCEDURE	56
7.3 DEVIATION FROM STANDARD	56



Table of Contents	Page
7.4 TEST SETUP	56
7.5 EUT OPERATION CONDITIONS	56
7.6 TEST RESULTS	57
8. AUTOMATICALLY DISCONTINUE TRANSMISSION	74
8.1 LIMIT OF AUTOMATICALLY DISCONTINUE TRANSMISSION	74
8.2 TEST RESULT OF AUTOMATICALLY DISCONTINUE TRANSMISSION	74
9. ANTENNA REQUIREMENT	75
9.1 STANDARD REQUIREMENT	75
9.2 EUT ANTENNA	75
APPENDIX - PHOTOS OF TEST SETUP	76





Revision History

Rev.	Issue Date	Report NO.	Effect Page	Contents
00	08 Apr. 2020	STS2001235W11	ALL	Initial Issue





1. SUMMARY OF TEST RESULTS

Test procedures according to the technical standards:

§ 15.407, KDB 789033 D02 General U-NII Test Procedures New Rules v02r01

FCC Part 15.407		
FCC standard	Test Item	Results
15.207	AC Conducted Emission	PASS
§ 15.407 (2) (26 dB) / § 15.407 (e) (6 dB) / § 15.407 (a) (99%)	26dB/6dB & 99% Bandwidth	PASS
15.407(a) (1).(2).(3).(4).(5)	Maximum Conducted Output Power	PASS
15.407(b) & 15.209	Radiated Emission And (bandedge Emissions) Measurement	PASS
15.407(b)7	Conducted Emission And (bandedge Emissions) Measurement	PASS
15.407(a) (1).(2).(3).(4).(5)	Power Spectral Density	PASS
15.407(c)	Automatically Discontinue Transmission	PASS
15.203/15.204	Antenna Requirement	PASS

NOTE:

- (1) 'N/A' denotes test is not applicable in this Test Report.
- (2) All tests are according to ANSI C63.10-2013.



1.1 TEST FACTORY

SHENZHEN STS TEST SERVICES CO., LTD

Add. : A 1/F, Building B, Zhuoke Science Park, No.190 Chongqing Road, HepingShequ, Fuyong Sub-District, Bao'an District, Shenzhen, Guang Dong, China

FCC test Firm Registration Number: 625569

IC test Firm Registration Number: 12108A

A2LA Certificate No.: 4338.01

1.2 MEASUREMENT UNCERTAINTY

The reported uncertainty of measurement $y \pm U$, where expanded uncertainty U is based on a standard uncertainty multiplied by a coverage factor of $k=2$, providing a level of confidence of approximately **95 %**.

No.	Item	Uncertainty
1	RF output power, conducted	$\pm 0.68\text{dB}$
2	Unwanted Emissions, conducted	$\pm 2.988\text{dB}$
3	All emissions, radiated 30-1GHz	$\pm 6.7\text{dB}$
4	All emissions, radiated 1G-6GHz	$\pm 5.5\text{dB}$
5	All emissions, radiated >6G	$\pm 5.8\text{dB}$
6	Conducted Emission (9KHz-150KHz)	$\pm 4.43\text{dB}$
7	Conducted Emission (150KHz-30MHz)	$\pm 5\text{dB}$



2. GENERAL INFORMATION

2.1 GENERAL DESCRIPTION OF THE EUT

Product Name	Rugged Tablet PC	
Trade Name	Winmate	
Model Name	M101P-BH	
Series Model	RT10W-L00, M101PXXXXXXXXXXXX(Where X can be A-Z,a-z ,0-9, “-”, Blank or Slash)	
Model Difference	Only difference for marketing purpose	
Product Description	The EUT is a Rugged Tablet PC	
	Operation Frequency:	IEEE 802.11a/ n(HT20)/ac(VHT20): 5.180GHz-5.240GHz IEEE 802.11n(HT40)/ac(VHT40): 5.190GHz-5.230GHz IEEE 802.11ac(VHT80): 5.210GHz
		IEEE 802.11a/ n(HT20)/ac(VHT20): 5.260GHz-5.320GHz IEEE 802.11 n(HT40)/ac(VHT40): 5.270GHz-5.310GHz IEEE 802.11ac(VHT80): 5.290GHz
		IEEE 802.11a/ n(HT20)/ac(VHT20): 5.500GHz-5.700GHz IEEE 802.11 n(HT40)/ac(VHT40): 5.510GHz-5.670GHz IEEE 802.11ac(VHT80): 5.530GHz-5.610GHz
		IEEE 802.11a/ n(HT20)/ac(VHT20): 5.745GHz-5.825GHz IEEE 802.11a/ n(HT40)/ac(VHT40): 5.755GHz-5.795GHz IEEE 802.11ac(VHT80): 5.775GHz
	Modulation Type:	802.11a(OFDM): BPSK,QPSK,16-QAM,64-QAM 802.11n(OFDM): BPSK,QPSK,16-QAM,64-QAM 802.11ac(OFDM): BPSK,QPSK,16-QAM,64-QAM,256-QAM
	Antenna Designation:	Please refer to the Note 3.
	Max.Output Power(Conducted):	17.93 dBm
		More details of EUT technical specification, please refer to the User Manual.
	Test Channel	Please refer to the Note 2.
Adapter	Input: AC 100-240V, 2.0A, 50-60Hz Output: DC 19 V, 3.42A	
Battery	Battery 1: Rated Voltage: 7.7V Charge Limit: 8.8V Capacity: 5900mAh Battery 2: Rated Voltage: 7.4V Charge Limit: 8.4V Capacity: 10280mAh	



Hardware version number	M101PH-100
Software version number	8.8.4773.0004
Connecting I/O Port(s)	Please refer to the Note 1.

Note

1. For a more detailed features description, please refer to the manufacturer's specifications or the User Manual.





2. Operation Frequency of channel

5.180GHz-5.240GHz		5.500GHz-5.720GHz	
Channel	Frequency	Channel	Frequency
36	5180	100	5500
38	5190	102	5510
40	5200	104	5520
42	5210	108	5540
44	5220	110	5550
46	5230	112	5560
48	5240	116	5580
		118	5590
		120	5600
5.260GHz-5.320GHz			
Channel	Frequency		
52	5260	124	5620
54	5270	126	5630
56	5280	128	5640
58	5290	132	5660
60	5300	134	5670
62	5310	136	5680
64	5320	140	5700
5.745GHz-5.825GHz			
Channel	Frequency		
149	5745		
151	5755		
153	5765		
157	5785		
159	5795		
161	5805		
165	5825		

Note:

In section 15.31(m), regards to the operating frequency range over 10 MHz, the Lowest frequency, the middle frequency, and the highest frequency of channel were selected to perform the test, and the selected channel see below:

Carrier Frequency Channel

5GHz:

For 802.11a/n(HT20)/ac(VHT20)			
Channel	Freq.(MHz)	Channel	Freq.(MHz)
36	5180	52	5260
40	5200	60	5300
48	5240	64	5320

For 802.11a/n(HT20)/ac(VHT20)			
Channel	Freq.(MHz)	Channel	Freq.(MHz)
100	5500	149	5745
116	5580	157	5785
140	5700	165	5825



For 802.11 n(HT40)/ac(VHT40)			
Channel	Freq.(MHz)	Channel	Freq.(MHz)
38	5190	54	5270
46	5230	62	5310

For 802.11 n(HT40)/ac(VHT40)			
Channel	Freq.(MHz)	Channel	Freq.(MHz)
102	5510	151	5755
110	5550	159	5795
134	5670		

For 802.11ac (VHT80)			
Channel	Freq.(MHz)	Channel	Freq.(MHz)
42	5210	58	5290

For 802.11ac (VHT80)			
Channel	Freq.(MHz)	Channel	Freq.(MHz)
106	5530	155	5775
122	5610		

3. KDB 662911 D01 Multiple Transmitter Output v02r01

2) Directional Gain Calculations for In-Band Measurements

a) Basic methodology with NANT transmit antennas, each with the same directional gain GANT dBi, being driven by NANT transmitter outputs of equal power. Directional gain is to be computed as follows:

- (i) If any transmit signals are correlated with each other,
Directional gain = GANT + 10 log(NANT) dBi
- (ii) If all transmit signals are completely uncorrelated with each other,
Directional gain = GANT

Antenna number: 2
 Antenna A gain : 2.46dBi
 Antenna B gain : 2.46dBi
 MIMO technology Directional gain=5.47dBi

GANT + 10 log(NANT) dBi
 Directional gain= 2.46 +10log2=5.47dBi

Ant	Brand	Model Name	Ant Type	Connector	Gain (dBi)	NOTE
A	Winmate	M101P-BH	PIFA Antenna	N/A	Ant A gain : 2.46dBi Ant B gain : 2.46dBi MIMO gain=5.47dBi	WLAN Ant



2.2 DESCRIPTION OF TEST MODES

To investigate the maximum EMI emission characteristics generated from EUT, the test system was pre-scanning tested based on the consideration of following EUT operation mode or test configuration mode which possibly have effect on EMI emission level. Each of these EUT operation mode(s) or test configuration mode(s) mentioned above was evaluated respectively.

Worst Mode	Description	Data Rate
Mode 1	TX IEEE 802.11a HT20 CH36&CH40&CH48	6 Mbps
Mode 2	TX IEEE 802.11a HT20 CH52&CH60&CH64	6 Mbps
Mode 3	TX IEEE 802.11a HT20 CH100&CH116&CH140	6 Mbps
Mode 4	TX IEEE 802.11a HT20 CH149&CH157&CH165	6 Mbps
Mode 5	TX IEEE 802.11n HT20 CH36&CH40&CH48	MCS 0
Mode 6	TX IEEE 802.11ac HT20 CH36&CH40&CH48	NSS1 MCS0
Mode 7	TX IEEE 802.11n HT20 CH52&CH60&CH64	MCS 0
Mode 8	TX IEEE 802.11ac HT20 CH52&CH60&CH64	NSS1 MCS0
Mode 9	TX IEEE 802.11n HT20 CH100&CH116&CH140	MCS 0
Mode 10	TX IEEE 802.11ac HT20 CH100&CH116&CH140	NSS1 MCS0
Mode 11	TX IEEE 802.11n HT20 CH149&CH157&CH165	MCS 0
Mode 12	TX IEEE 802.11ac HT20 CH149&CH157&CH165	NSS1 MCS0
Mode 13	TX IEEE 802.11n HT40 CH38&CH46	MCS 0
Mode 14	TX IEEE 802.11ac HT40 CH38&CH46	NSS1 MCS0
Mode 15	TX IEEE 802.11n HT40 CH54 &CH62	MCS 0
Mode 16	TX IEEE 802.11ac HT40 CH54 &CH62	NSS1 MCS0
Mode 17	TX IEEE 802.11n HT40 CH102&CH110&CH134	MCS 0
Mode 18	TX IEEE 802.11ac HT40 CH102&CH110&CH134	NSS1 MCS0
Mode 19	TX IEEE 802.11n HT40 CH151&CH159	MCS 0
Mode 20	TX IEEE 802.11ac HT40 CH151&CH159	NSS1 MCS0
Mode 21	TX IEEE 802.11ac HT80 CH42	NSS1 MCS0
Mode 22	TX IEEE 802.11ac HT80 CH58	NSS1 MCS0
Mode 23	TX IEEE 802.11ac HT80 CH106&122	NSS1 MCS0
Mode 24	TX IEEE 802.11ac HT80 CH155	NSS1 MCS0

- Note: (1) The measurements are performed at the highest, middle, lowest available channels.
 (2) The measurements are performed at all Bit Rate of Transmitter, the worst data was reported.
 (3) We have been tested for all available U.S. voltage and frequencies (For 120V, 50/60Hz and 240V, 50/60Hz) for which the device is capable of operation.

AC Conducted Emission

Test Case	
AC Conducted Emission	Mode 25: Keeping TX + WLAN Link

2.3 BLOCK DIGRAM SHOWING THE CONFIGURATION OF SYSTEM TESTED

Radiated Spurious Emission Test



Conducted Emission Test

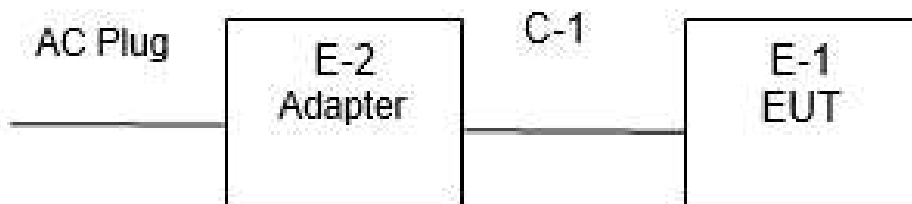



2.4 DESCRIPTION OF NECESSARY ACCESSORIES AND SUPPORT UNITS

The EUT has been tested as an independent unit together with other necessary accessories or support units. The following support units or accessories were used to form a representative test configuration during the tests.

Necessary accessories

Item	Equipment	Mfr/Brand	Model/Type No.	Serial No.	Note
E-2	Adapter	EDAC	EA10733P-190	N/A	N/A
C-1	DC Cable	N/A	110cm	N/A	N/A

Support units

Item	Equipment	Mfr/Brand	Model/Type No.	Serial No.	Note
N/A	N/A	N/A	N/A	N/A	N/A

Note:

- (1) The support equipment was authorized by Declaration of Confirmation.
- (2) For detachable type I/O cable should be specified the length in cm in 『Length』 column.



2.5 EQUIPMENTS LIST FOR ALL TEST ITEMS

Radiation Test equipment

Kind of Equipment	Manufacturer	Type No.	Serial No.	Last calibration	Calibrated until
EMI Test Receiver	R&S	ESCI	101427	2019.07.29	2020.07.28
Signal Analyzer	Agilent	N9020A	MY51110105	2020.03.05	2021.03.04
Active loop Antenna	ZHINAN	ZN30900C	16035	2018.03.11	2021.03.10
Bilog Antenna	TESEQ	CBL6111D	34678	2017.11.02	2020.11.01
Horn Antenna	SCHWARZBECK	BBHA 9120D(1201)	9120D-1343	2018.10.19	2021.10.18
Horn Antenna (18-40GHz)	A-INFO	LB-180400-KF	J211020657	2018.03.11	2021.03.10
Pre-mpifier (18G-40G)	SKET	LNPA_1840-50	SK2018101801	2019.10.22	2020.10.21
Spectrum Analyzer	R&S	FSV40-N	101823	2019.06.05	2020.06.04
Pre-Amplifier(0.1 M-3GHz)	EM	EM330	060665	2019.10.09	2020.10.08
Pre-Amplifier (1G-18GHz)	SKET	LNPA-01018G-4 5	SK2018080901	2019.10.12	2020.10.11
Temperature & Humidity	HH660	Mieo	N/A	2019.10.12	2020.10.11
Turn table	EM	SC100_1	60531	N/A	N/A
Antenna mast	EM	SC100	N/A	N/A	N/A
Test SW	BULUN	BL410-E/18.905			

Conduction Test equipment

Kind of Equipment	Manufacturer	Type No.	Serial No.	Last calibration	Calibrated until
Test Receiver	R&S	ESCI	101427	2019.07.29	2020.07.28
LISN	R&S	ENV216	101242	2019.10.09	2020.10.08
LISN	EMCO	3810/2NM	23625	2019.10.09	2020.10.08
Temperature & Humidity	HH660	Mieo	N/A	2019.10.12	2020.10.11
Test SW	FARAD	EZ-EMC(Ver.STSLAB-03A1 CE)			

RF Connected Test

Kind of Equipment	Manufacturer	Type No.	Serial No.	Last calibration	Calibrated until
USB RF power sensor	DARE	RPR3006W	15I00041SNO03	2019.10.09	2020.10.08
Signal Analyzer	Agilent	N9020A	MY49100060	2019.10.09	2020.10.08
Temperature & Humidity	HH660	Mieo	N/A	2019.10.12	2020.10.11
Test SW	FARAD	LZ-RF /LzRf-3A3			



3. EMC EMISSION TEST

3.1 CONDUCTED EMISSION MEASUREMENT

3.1.1 POWER LINE CONDUCTED EMISSION Limits (Frequency Range 150KHz-30MHz)

FREQUENCY (MHz)	Class B (dBuV)		Standard
	Quasi-peak	Average	
0.15 -0.5	66 - 56 *	56 - 46 *	CISPR
0.50 -5.0	56.00	46.00	CISPR
5.0 -30.0	60.00	50.00	CISPR

0.15 -0.5	66 - 56 *	56 - 46 *	FCC
0.50 -5.0	56.00	46.00	FCC
5.0 -30.0	60.00	50.00	FCC

Note:

- (1) The tighter limit applies at the band edges.
- (2) The limit of “ * ” marked band means the limitation decreases linearly with the logarithm of the frequency in the range.

The following table is the setting of the receiver

Receiver Parameters	Setting
Attenuation	10 dB
Start Frequency	0.15 MHz
Stop Frequency	30 MHz
IF Bandwidth	9 kHz

3.1.2 TEST PROCEDURE

- a. The EUT was placed 0.8 meters from the horizontal ground plane with EUT being connected to the power mains through a line impedance stabilization network (LISN). All other support equipments powered from additional LISN(s). The LISN provide 50 Ohm/ 50uH of coupling impedance for the measuring instrument.
- b. Interconnecting cables that hang closer than 40 cm to the ground plane shall be folded back and forth in the center forming a bundle 30 to 40 cm long.
- c. I/O cables that are not connected to a peripheral shall be bundled in the center. The end of the cable may be terminated, if required, using the correct terminating impedance. The overall length shall not exceed 1 m.
- d. LISN at least 80 cm from nearest part of EUT chassis.
- e. For the actual test configuration, please refer to the related Item –EUT Test Photos.

3.1.3 DEVIATION FROM TEST STANDARD

No deviation

3.1.4 TEST SETUP

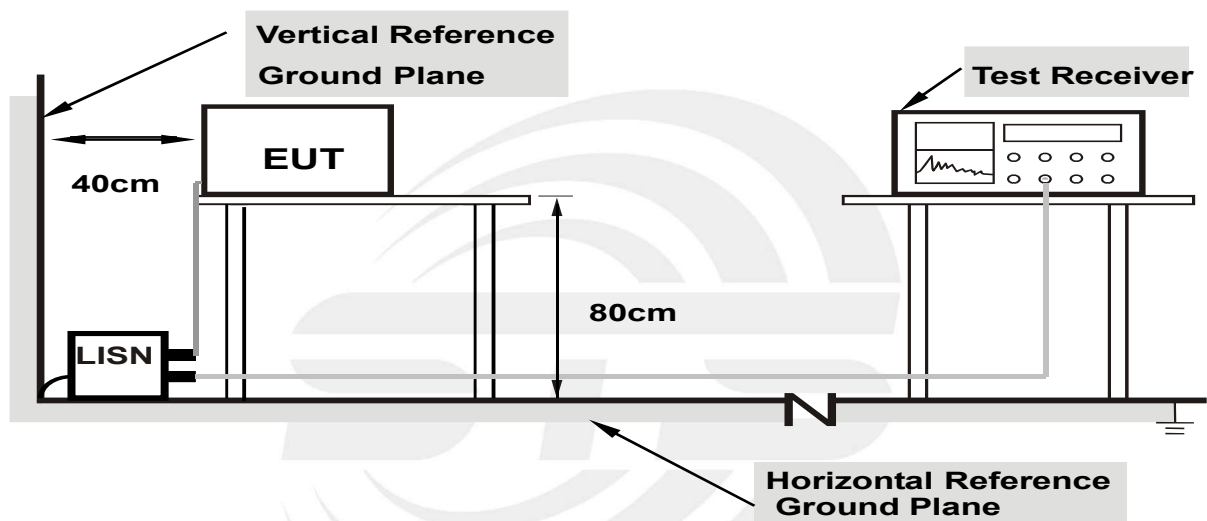

- Note:**
1. Support units were connected to second LISN.
 2. Both of LISNs (AMN) are 80 cm from EUT and at least 80 from other units and other metal planes

3.1.5 EUT OPERATING CONDITIONS

The EUT was configured for testing in a typical fashion (as a customer would normally use it). The EUT has been programmed to continuously transmit during test. This operating condition was tested and used to collect the included data.



3.1.6 TEST RESULTS

Temperature:	22.9(C)	Relative Humidity:	47%RH
Test Voltage:	AC 120V/60Hz	Phase:	L
Test Mode :	Mode 25		

No.	Frequency (MHz)	Reading (dBuV)	Correct Factor(dB)	Result (dBuV)	Limit (dBuV)	Margin (dB)	Remark
1	0.1610	30.48	19.79	50.27	65.41	-15.14	QP
2	0.1610	17.35	19.79	37.14	55.41	-18.27	AVG
3	0.4700	23.22	20.03	43.25	46.51	-3.26	AVG
4	0.4740	28.99	20.03	49.02	56.44	-7.42	QP
5	1.4015	18.98	19.79	38.77	56.00	-17.23	QP
6	1.4015	10.58	19.79	30.37	46.00	-15.63	AVG
7	2.0740	17.71	19.79	37.50	56.00	-18.50	QP
8	2.0740	8.36	19.79	28.15	46.00	-17.85	AVG
9	3.7893	18.79	19.83	38.62	56.00	-17.38	QP
10	3.7893	10.25	19.83	30.08	46.00	-15.92	AVG
11	16.8474	27.47	20.32	47.79	60.00	-12.21	QP
12	16.8474	19.90	20.32	40.22	50.00	-9.78	AVG

Remark:

1. All readings are Quasi-Peak and Average values.
2. Margin = Result (Result = Reading + Factor) - Limit

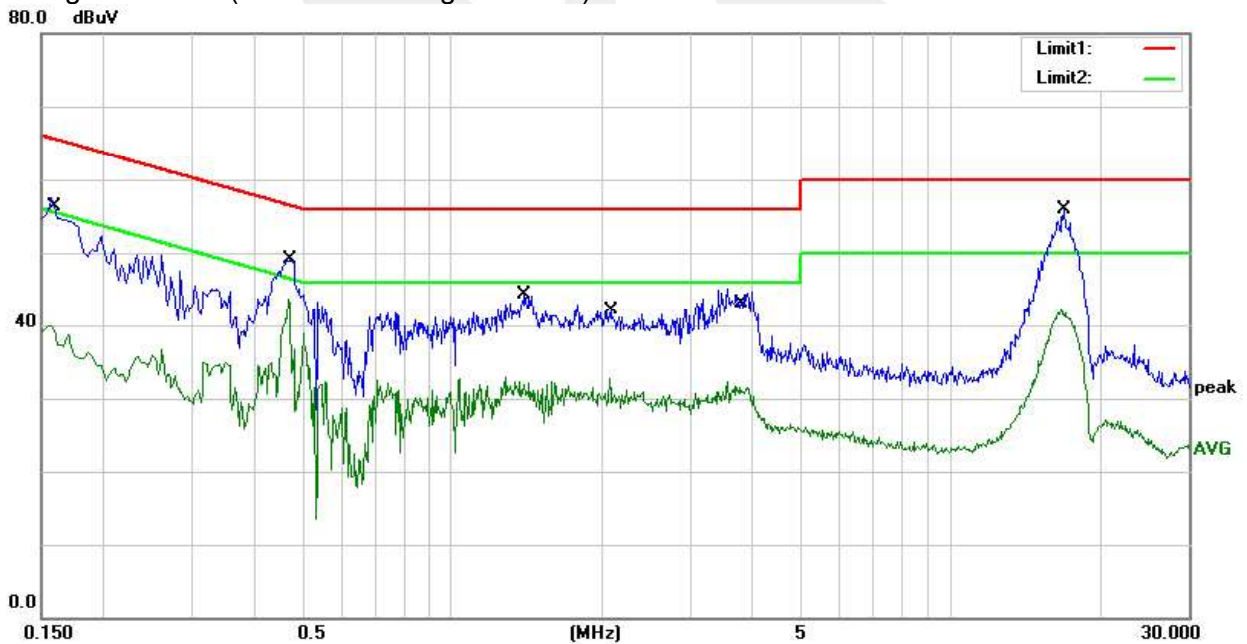



Temperature:	22.9(C)	Relative Humidity:	47%RH
Test Voltage	AC 120V/60Hz	Phase:	N
Test Mode	Mode 25		

No.	Frequency (MHz)	Reading (dBuV)	Correct Factor(dB)	Result (dBuV)	Limit (dBuV)	Margin (dB)	Remark
1	0.1512	32.56	19.75	52.31	65.93	-13.62	QP
2	0.1512	19.01	19.75	38.76	55.93	-17.17	AVG
3	0.4620	30.60	20.01	50.61	56.66	-6.05	QP
4	0.4620	23.59	20.01	43.60	46.66	-3.06	AVG
5	0.7456	18.88	19.85	38.73	56.00	-17.27	QP
6	0.7456	10.64	19.85	30.49	46.00	-15.51	AVG
7	1.4130	18.69	19.83	38.52	56.00	-17.48	QP
8	1.4130	9.88	19.83	29.71	46.00	-16.29	AVG
9	3.9145	20.15	19.94	40.09	56.00	-15.91	QP
10	3.9145	9.14	19.94	29.08	46.00	-16.92	AVG
11	17.0416	28.92	20.24	49.16	60.00	-10.84	QP
12	17.0416	20.90	20.24	41.14	50.00	-8.86	AVG

Remark:

1. All readings are Quasi-Peak and Average values.
2. Margin = Result (Result = Reading + Factor) - Limit

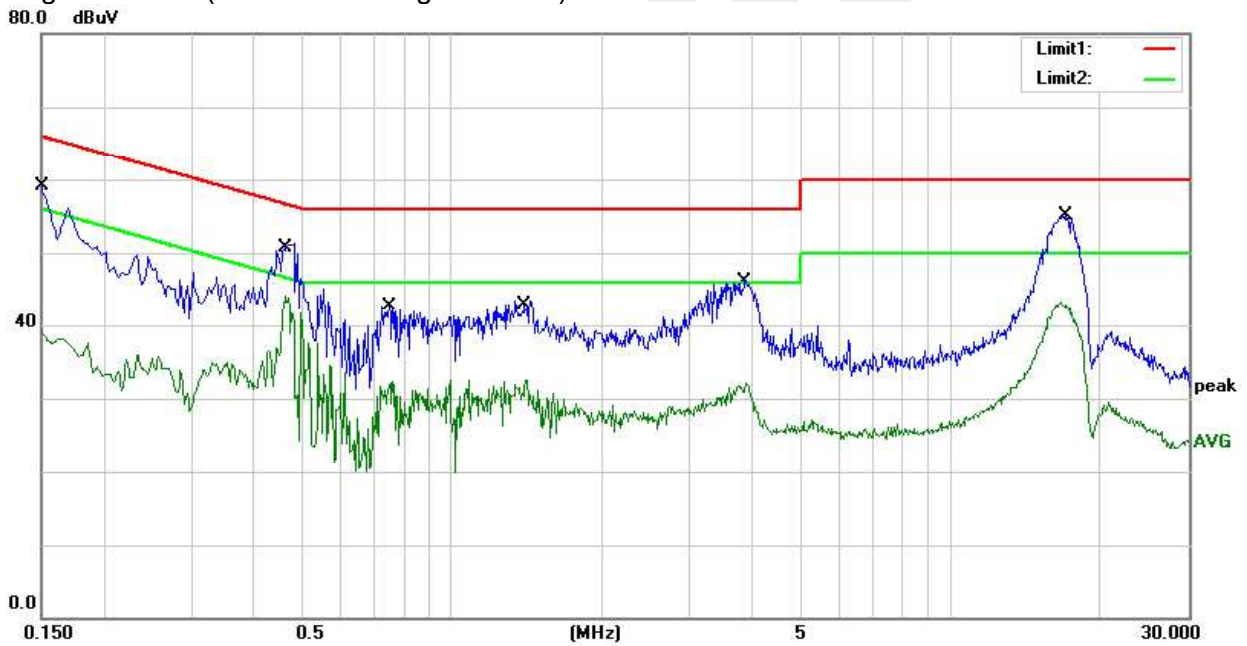

3.2 RADIATED EMISSION AND (BANDEDGE) MEASUREMENT

3.2.1 RADIATED EMISSION LIMITS (Frequency Range 9kHz-1000MHz)

In case the emission fall within the restricted band specified on 15.407(b)7& 15.205/209(a), then the (a); limit in the table below has to be followed.

Frequencies (MHz)	Field Strength (microvolts/meter)	Measurement Distance (meters)
0.009~0.490	2400/F(KHz)	300
0.490~1.705	24000/F(KHz)	30
1.705~30.0	30	30
30~88	100	3
88~216	150	3
216~960	200	3
Above 960	500	3

LIMITS OF RADIATED EMISSION MEASUREMENT (Above 1000MHz)

FREQUENCY (MHz)	Class B (dBuV/m) (at 3M)	
	PEAK	AVERAGE
Above 1000	68.2	54

Notes:

- (1) The limit for radiated test was performed according to FCC PART 15E.
- (2) The tighter limit applies at the band edges.
- (3) Emission level (dBuV/m)=20log Emission level (uV/m).

LIMITS OF RESTRICTED FREQUENCY BANDS

FREQUENCY (MHz)	FREQUENCY (MHz)	FREQUENCY (MHz)	FREQUENCY (GHz)
0.090-0.110	16.42-16.423	399.9-410	4.5-5.15
0.495-0.505	16.69475-16.69525	608-614	5.35-5.46
2.1735-2.1905	16.80425-16.80475	960-1240	7.25-7.75
4.125-4.128	25.5-25.67	1300-1427	8.025-8.5
4.17725-4.17775	37.5-38.25	1435-1626.5	9.0-9.2
4.20725-4.20775	73-74.6	1645.5-1646.5	9.3-9.5
6.215-6.218	74.8-75.2	1660-1710	10.6-12.7
6.26775-6.26825	108-121.94	1718.8-1722.2	13.25-13.4
6.31175-6.31225	123-138	2200-2300	14.47-14.5
8.291-8.294	149.9-150.05	2310-2390	15.35-16.2
8.362-8.366	156.52475-156.52525	2483.5-2500	17.7-21.4
8.37625-8.38675	156.7-156.9	2690-2900	22.01-23.12
8.41425-8.41475	162.0125-167.17	3260-3267	23.6-24.0
12.29-12.293	167.72-173.2	3332-3339	31.2-31.8
12.51975-12.52025	240-285	3345.8-3358	36.43-36.5
12.57675-12.57725	322-335.4	3600-4400	Above 38.6
13.36-13.41			



Spectrum Parameter	Setting
Attenuation	Auto
Detector	Peak
Start Frequency	1000 MHz(Peak/AV)
Stop Frequency	10th carrier harmonic (Peak/AV)
RB / VB (emission in restricted band)	1 MHz / 1 MHz, AV=1 MHz /3 MHz

For Band edge

Spectrum Parameter	Setting
Detector	Peak
RB / VB (emission in restricted band)	1 MHz / 1 MHz, AV=1 MHz /3 MHz

Receiver Parameter	Setting
Attenuation	Auto
Start ~ Stop Frequency	9kHz~90kHz / RB 200Hz for PK & AV
Start ~ Stop Frequency	90kHz~110kHz / RB 200Hz for QP
Start ~ Stop Frequency	110kHz~490kHz / RB 200Hz for PK & AV
Start ~ Stop Frequency	490kHz~30MHz / RB 9kHz for QP
Start ~ Stop Frequency	30MHz~1000MHz / RB 120kHz for QP

3.2.2 TEST PROCEDURE

- The measuring distance of at 3 m shall be used for measurements at frequency 0.009MHz up to 1GHz. For frequencies above 1GHz, any suitable measuring distance may be used.
- The EUT was placed on the top of a rotating table 0.8 meters(above 1GHz is 1.5 m) above the ground at a 3 meter anechoic chamber. The table was rotated 360 degrees to determine the position of the highest radiation.
- The height of the equipment shall be 0.8 m(above 1GHz is 1.5 m); the height of the test antenna shall vary between 1 m to 4 m. Horizontal and vertical polarizations of the antenna are set to make the measurement
- The initial step in collecting conducted emission data is a spectrum analyzer peak detector mode pre-scanning the measurement frequency range. Significant peaks are then marked and then Quasi Peak detector mode re-measured.
- If the Peak Mode measured value compliance with and lower than Quasi Peak Mode Limit, the EUT shall be deemed to meet QP Limits and then no additional QP Mode measurement performed.
- For the actual test configuration, please refer to the related Item –EUT Test Photos.

Note:

Both horizontal and vertical antenna polarities were tested and performed test to three orthogonal axis. The worst case emissions were reported

3.2.2 DEVIATION FROM TEST STANDARD

No deviation

3.2.3 TEST SETUP

(A) Radiated Emission Test-Up Frequency Below 30MHz

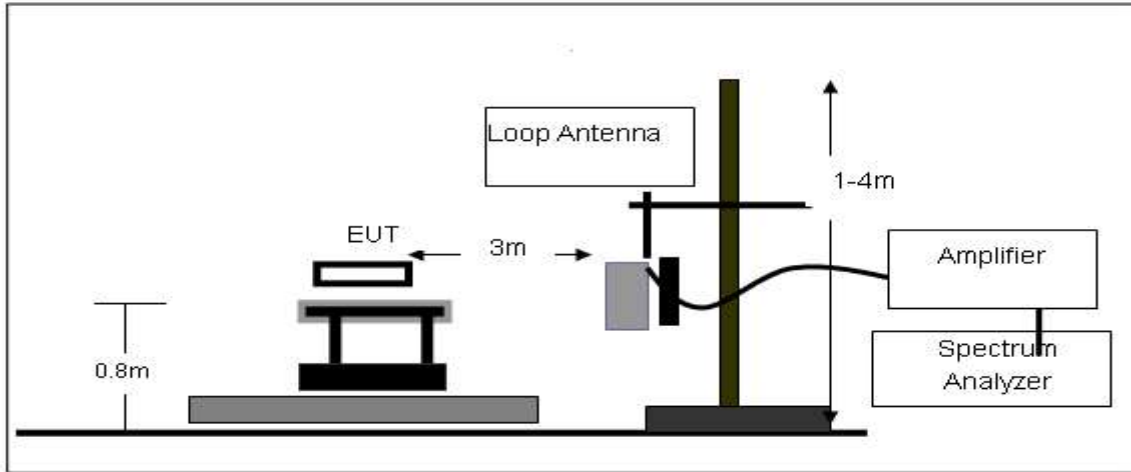

(B) Radiated Emission Test-Up Frequency 30MHz~1GHz

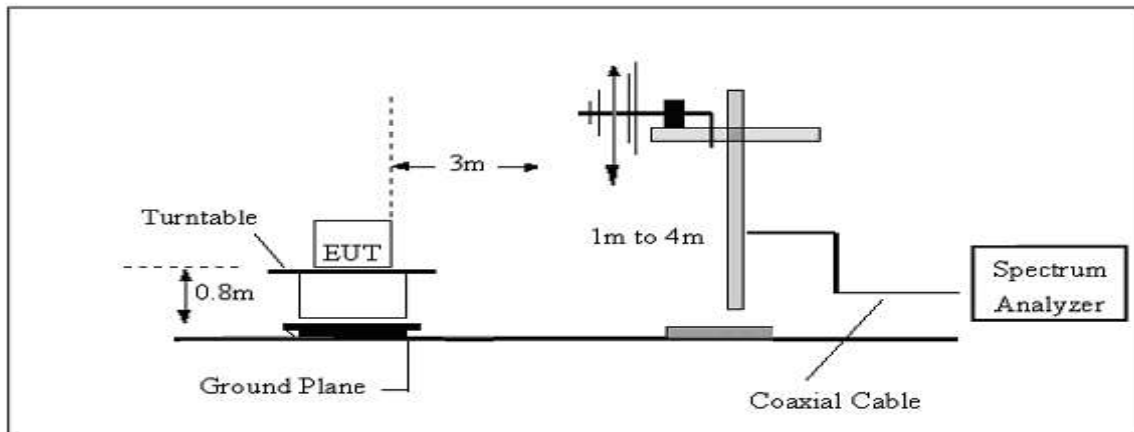

(C) Radiated Emission Test-Up Frequency Above 1GHz

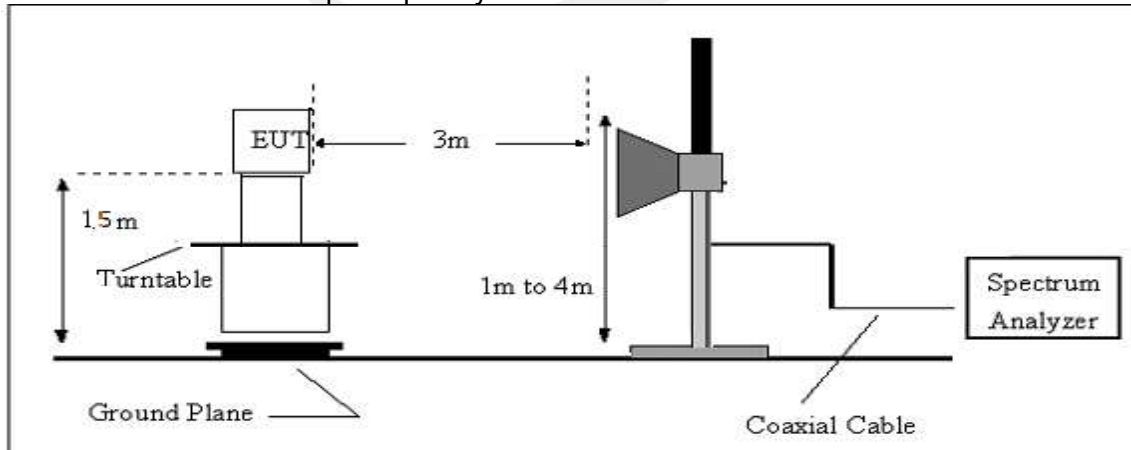



3.2.4 EUT OPERATING CONDITIONS

The EUT tested system was configured as the statements of 2.4 Unless otherwise a special operating condition is specified in the follows during the testing.

3.2.5 FIELD STRENGTH CALCULATION

The field strength is calculated by adding the Antenna Factor and Cable Factor and subtracting the Amplifier Gain and Duty Cycle Correction Factor (if any) from the measured reading. The basic equation with a sample calculation is as follows:

$$FS = RA + AF + CL - AG$$

Where

FS = Field Strength

CL = Cable Attenuation Factor (Cable Loss)

RA = Reading Amplitude

AG = Amplifier Gain

AF = Antenna Factor

For example

Frequency (MHz)	FS (dB μ V/m)	RA (dB μ V/m)	AF (dB)	CL (dB)	AG (dB)	Factor (dB)
300	40	58.1	12.2	1.6	31.9	-18.1

$$\text{Factor} = \text{AF} + \text{CL} - \text{AG}$$

**3.2.6 TEST RESULTS (Between 9KHz – 30 MHz)**

Temperature:	24.2(C)	Relative Humidity:	57%RH
Test Voltage:	DC 7.7V	Polarization :	--
Test Mode:	TX Mode		

Freq. (MHz)	Reading (dBuV/m)	Limit (dBuV/m)	Margin (dB)	State P/F
--	--	--	--	PASS
--	--	--	--	PASS

Note:

The amplitude of spurious emissions which are attenuated by more than 20dB below the permissible value has no need to be reported.

Distance extrapolation factor = $40 \log(\text{specific distance}/\text{test distance})$ (dB);

Limit line = specific limits(dBuv) + distance extrapolation factor.

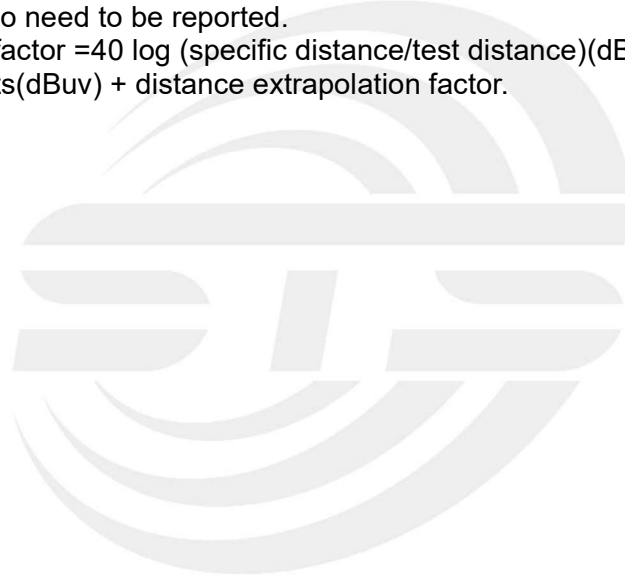



3.2.7 TEST RESULTS (Between 30MHz – 1GHz)

Temperature	24.2(C)	Relative Humidity:	57%RH
Test Voltage	DC 7.7V	Polarization:	Horizontal
Test Mode	Mode 1~24(Mode 10 worst mode)		

No.	Frequency (MHz)	Reading (dBuV)	Correct Factor(dB/m)	Result (dBuV/m)	Limit (dBuV/m)	Margin (dB)	Remark
1	159.0100	46.61	-18.77	27.84	43.50	-15.66	QP
2	237.5800	47.38	-18.35	29.03	46.00	-16.97	QP
3	474.2600	37.51	-8.85	28.66	46.00	-17.34	QP
4	576.1100	36.74	-5.70	31.04	46.00	-14.96	QP
5	672.1400	42.21	-4.52	37.69	46.00	-8.31	QP
6	983.5100	29.53	2.46	31.99	54.00	-22.01	QP

Remark:

1. Margin = Result (Result =Reading + Factor)-Limit

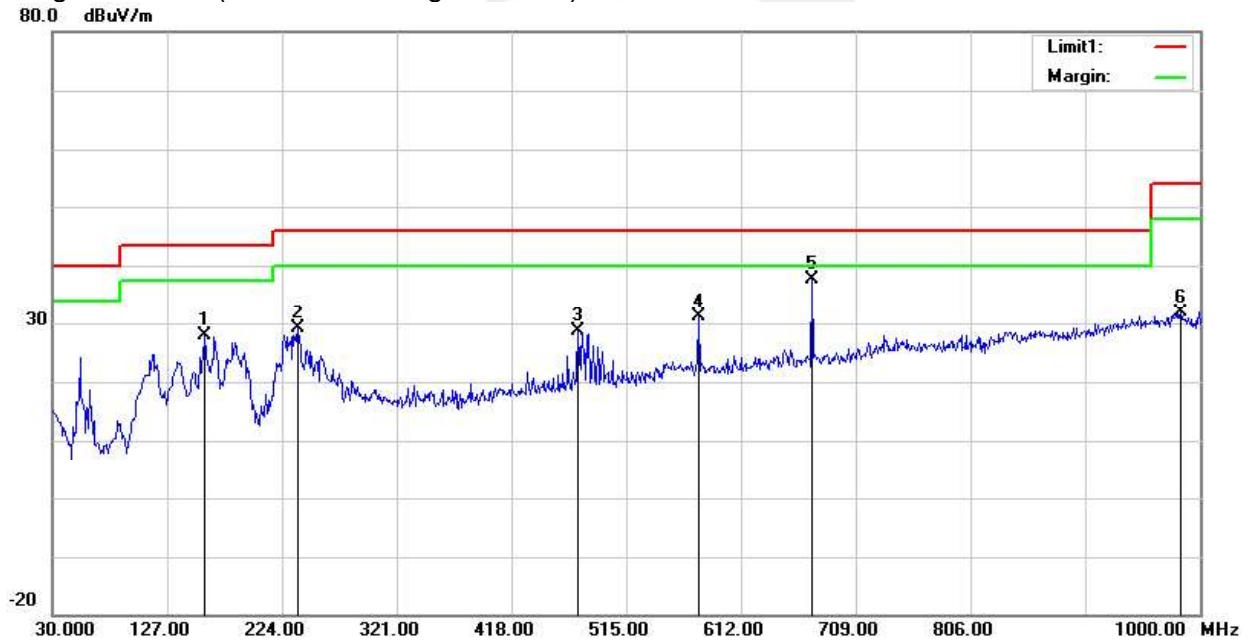



Temperature	24.2(C)	Relative Humidity:	57%RH
Test Voltage	DC 7.7V	Polarization:	Vertical
Test Mode	Mode 1~24(Mode 10 worst mode)		

No.	Frequency (MHz)	Reading (dBuV)	Correct Factor(dB/m)	Result (dBuV/m)	Limit (dBuV/m)	Margin (dB)	Remark
1	62.0100	55.14	-25.76	29.38	40.00	-10.62	QP
2	158.0400	43.51	-18.74	24.77	43.50	-18.73	QP
3	482.9900	33.88	-8.52	25.36	46.00	-20.64	QP
4	576.1100	38.38	-5.70	32.68	46.00	-13.32	QP
5	672.1400	39.27	-4.52	34.75	46.00	-11.25	QP
6	955.3800	30.92	1.68	32.60	46.00	-13.40	QP

Remark:

1. Margin = Result (Result =Reading + Factor)-Limit

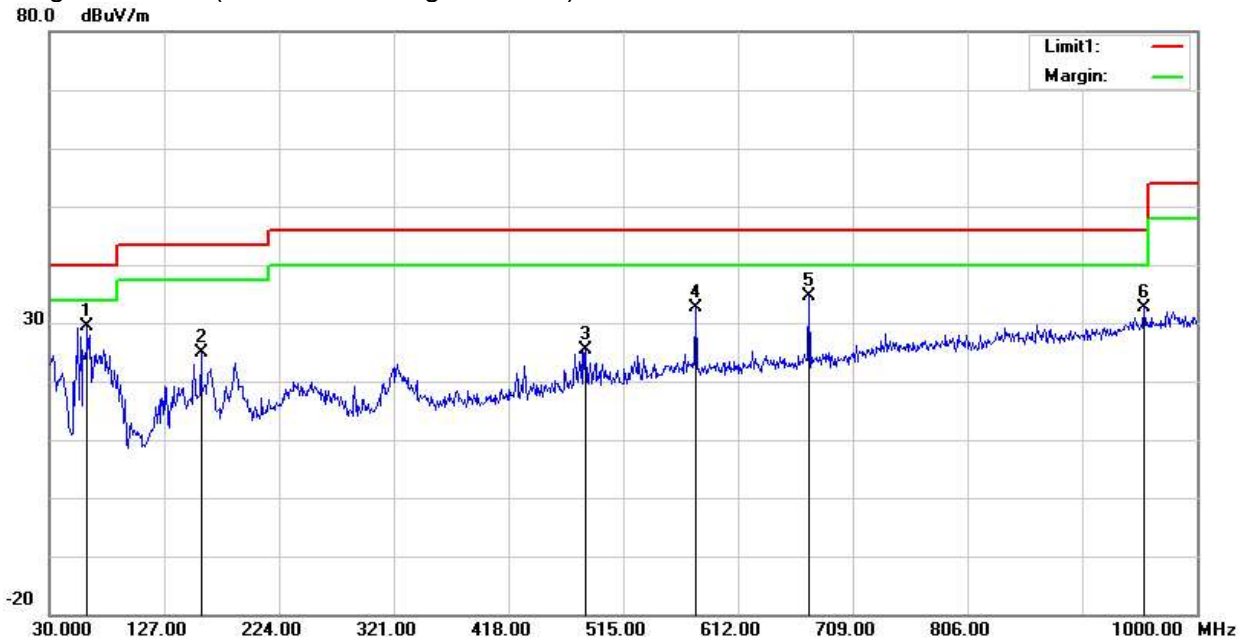



3.2.8 TEST RESULTS (Above 1000 MHz)

Band I 5150-5250MHz

Frequency (MHz)	Reading (dBuV)	Amplifier (dB)	Loss (dB)	Antenna Factor (dB/m)	Orrected Factor (dB)	Emission Level (dBuV/m)	Limit (dBuV/m)	Margin (dB)	Detector	Comment
Low Channel (802.11n(HT20)/ 5180 MHz)										
3261.54	44.20	44.70	6.70	28.20	-9.80	34.40	68.20	-33.80	Pk	Vertical
3261.54	40.85	44.70	6.70	28.20	-9.80	31.05	54.00	-22.95	AV	Vertical
3251.30	44.77	44.70	6.70	28.20	-9.80	34.97	68.20	-33.23	Pk	Horizontal
3251.30	42.14	44.70	6.70	28.20	-9.80	32.34	54.00	-21.66	AV	Horizontal
3983.90	39.46	44.20	7.90	29.70	-6.60	32.86	68.20	-35.34	Pk	Vertical
3983.90	36.24	44.20	7.90	29.70	-6.60	29.64	54.00	-24.36	AV	Vertical
3991.67	39.48	44.20	7.90	29.70	-6.60	32.88	68.20	-35.32	Pk	Horizontal
3991.67	36.76	44.20	7.90	29.70	-6.60	30.16	54.00	-23.84	AV	Horizontal
7220.02	36.45	43.50	11.40	35.50	3.40	39.85	68.20	-28.35	Pk	Vertical
7220.02	33.61	43.50	11.40	35.50	3.40	37.01	54.00	-16.99	AV	Vertical
7231.89	36.88	43.50	11.40	35.50	3.40	40.28	68.20	-27.92	Pk	Horizontal
7231.89	34.30	43.50	11.40	35.50	3.40	37.70	54.00	-16.30	AV	Horizontal
10359.95	39.62	44.50	13.80	38.80	8.10	47.72	68.20	-20.48	Pk	Vertical
10359.95	36.56	44.50	13.80	38.80	8.10	44.66	54.00	-9.34	AV	Vertical
10360.39	40.17	44.50	13.80	38.80	8.10	48.27	68.20	-19.93	Pk	Horizontal
10360.39	36.76	44.50	13.80	38.80	8.10	44.86	54.00	-9.14	AV	Horizontal
11019.53	32.86	43.60	14.30	39.50	10.20	43.06	68.20	-25.14	Pk	Vertical
11019.53	30.06	43.60	14.30	39.50	10.20	40.26	54.00	-13.74	AV	Vertical
11025.91	32.87	43.60	14.30	39.50	10.20	43.07	68.20	-25.13	Pk	Horizontal
11025.91	31.00	43.60	14.30	39.50	10.20	41.20	54.00	-12.80	AV	Horizontal
13285.61	32.62	42.60	15.90	38.90	12.20	44.82	68.20	-23.38	Pk	Vertical
13285.61	29.07	42.60	15.90	38.90	12.20	41.27	54.00	-12.73	AV	Vertical
13291.98	32.69	42.60	15.90	38.90	12.20	44.89	68.20	-23.31	Pk	Horizontal
13291.98	28.95	42.60	15.90	38.90	12.20	41.15	54.00	-12.85	AV	Horizontal
Mid Channel (802.11n(HT20)/ 5200 MHz)										
3253.70	44.27	44.70	6.70	28.20	-9.80	34.47	68.20	-33.73	Pk	Vertical
3253.70	41.28	44.70	6.70	28.20	-9.80	31.48	54.00	-22.52	AV	Vertical
3255.77	44.42	44.70	6.70	28.20	-9.80	34.62	68.20	-33.58	Pk	Horizontal
3255.77	41.93	44.70	6.70	28.20	-9.80	32.13	54.00	-21.87	AV	Horizontal
3992.57	38.68	44.20	7.90	29.70	-6.60	32.08	68.20	-36.12	Pk	Vertical
3992.57	36.30	44.20	7.90	29.70	-6.60	29.70	54.00	-24.30	AV	Vertical
3988.55	39.96	44.20	7.90	29.70	-6.60	33.36	68.20	-34.84	Pk	Horizontal
3988.55	35.64	44.20	7.90	29.70	-6.60	29.04	54.00	-24.96	AV	Horizontal
7221.93	37.73	43.50	11.40	35.50	3.40	41.13	68.20	-27.07	Pk	Vertical
7221.93	34.29	43.50	11.40	35.50	3.40	37.69	54.00	-16.31	AV	Vertical
7231.54	36.63	43.50	11.40	35.50	3.40	40.03	68.20	-28.17	Pk	Horizontal
7231.54	33.81	43.50	11.40	35.50	3.40	37.21	54.00	-16.79	AV	Horizontal
10400.19	39.35	44.50	13.80	38.80	8.10	47.45	68.20	-20.75	Pk	Vertical
10400.19	35.79	44.50	13.80	38.80	8.10	43.89	54.00	-10.11	AV	Vertical
10400.38	39.58	44.50	13.80	38.80	8.10	47.68	68.20	-20.52	Pk	Horizontal
10400.38	36.51	44.50	13.80	38.80	8.10	44.61	54.00	-9.39	AV	Horizontal
11024.64	33.09	43.60	14.30	39.50	10.20	43.29	68.20	-24.91	Pk	Vertical
11024.64	29.98	43.60	14.30	39.50	10.20	40.18	54.00	-13.82	AV	Vertical
11032.30	32.83	43.60	14.30	39.50	10.20	43.03	68.20	-25.17	Pk	Horizontal
11032.30	30.86	43.60	14.30	39.50	10.20	41.06	54.00	-12.94	AV	Horizontal
13291.60	32.33	42.60	15.90	38.90	12.20	44.53	68.20	-23.67	Pk	Vertical
13291.60	28.69	42.60	15.90	38.90	12.20	40.89	54.00	-13.11	AV	Vertical
13287.93	31.86	42.60	15.90	38.90	12.20	44.06	68.20	-24.14	Pk	Horizontal
13287.93	29.16	42.60	15.90	38.90	12.20	41.36	54.00	-12.64	AV	Horizontal



High Channel (802.11n(HT20)/ 5240 MHz)										
3255.06	44.16	44.70	6.70	28.20	-9.80	34.36	68.20	-33.84	Pk	Vertical
3255.06	42.05	44.70	6.70	28.20	-9.80	32.25	54.00	-21.75	AV	Vertical
3254.06	44.58	44.70	6.70	28.20	-9.80	34.78	68.20	-33.42	Pk	Horizontal
3254.06	40.80	44.70	6.70	28.20	-9.80	31.00	54.00	-23.00	AV	Horizontal
3992.41	39.98	44.20	7.90	29.70	-6.60	33.38	68.20	-34.82	Pk	Vertical
3992.41	35.94	44.20	7.90	29.70	-6.60	29.34	54.00	-24.66	AV	Vertical
3992.95	40.03	44.20	7.90	29.70	-6.60	33.43	68.20	-34.77	Pk	Horizontal
3992.95	36.42	44.20	7.90	29.70	-6.60	29.82	54.00	-24.18	AV	Horizontal
7228.49	37.68	43.50	11.40	35.50	3.40	41.08	68.20	-27.12	Pk	Vertical
7228.49	33.89	43.50	11.40	35.50	3.40	37.29	54.00	-16.71	AV	Vertical
7229.48	37.39	43.50	11.40	35.50	3.40	40.79	68.20	-27.41	Pk	Horizontal
7229.48	33.74	43.50	11.40	35.50	3.40	37.14	54.00	-16.86	AV	Horizontal
10480.13	40.09	44.50	13.80	38.80	8.10	48.19	68.20	-20.01	Pk	Vertical
10480.13	36.05	44.50	13.80	38.80	8.10	44.15	54.00	-9.85	AV	Vertical
10480.28	38.82	44.50	13.80	38.80	8.10	46.92	68.20	-21.28	Pk	Horizontal
10480.28	36.18	44.50	13.80	38.80	8.10	44.28	54.00	-9.72	AV	Horizontal
11022.51	33.35	43.60	14.30	39.50	10.20	43.55	68.20	-24.65	Pk	Vertical
11022.51	30.75	43.60	14.30	39.50	10.20	40.95	54.00	-13.05	AV	Vertical
11036.25	33.27	43.60	14.30	39.50	10.20	43.47	68.20	-24.73	Pk	Horizontal
11036.25	29.80	43.60	14.30	39.50	10.20	40.00	54.00	-14.00	AV	Horizontal
13295.58	32.31	42.60	15.90	38.90	12.20	44.51	68.20	-23.69	Pk	Vertical
13295.58	28.76	42.60	15.90	38.90	12.20	40.96	54.00	-13.04	AV	Vertical
13289.34	31.84	42.60	15.90	38.90	12.20	44.04	68.20	-24.16	Pk	Horizontal
13289.34	29.13	42.60	15.90	38.90	12.20	41.33	54.00	-12.67	AV	Horizontal

Remark:

- Factor = Antenna Factor + Cable Loss – Pre-amplifier.
- Scan with 802.11a,802.11n (HT-20),802.11n (HT-40), 802.11ac (VHT-20),802.11ac (VHT-40), 802.11ac (VHT-80) the worst case is 802.11n (HT-20).
- The frequency emission of peak points that did not show above the forms are at least 20dB below the limit, the frequency emission is mainly from the environment noise.
- Pre-scan both the SISO and MIMO mode, only the worst-case results were reported.



Band II 5250-5350MHz

Frequency (MHz)	Reading (dBuV)	Amplifier (dB)	Loss (dB)	Antenna Factor (dB/m)	Orrected Factor (dB)	Emission Level (dBuV/m)	Limit (dBuV/m)	Margin (dB)	Detector	Comment
Low Channel (802.11n(HT20)/ 5260 MHz)										
3248.06	44.05	44.70	6.70	28.20	-9.80	34.25	68.20	-33.95	Pk	Vertical
3248.06	40.96	44.70	6.70	28.20	-9.80	31.16	54.00	-22.84	AV	Vertical
3254.78	45.08	44.70	6.70	28.20	-9.80	35.28	68.20	-32.92	Pk	Horizontal
3254.78	41.48	44.70	6.70	28.20	-9.80	31.68	54.00	-22.32	AV	Horizontal
3996.65	39.89	44.20	7.90	29.70	-6.60	33.29	68.20	-34.91	Pk	Vertical
3996.65	35.90	44.20	7.90	29.70	-6.60	29.30	54.00	-24.70	AV	Vertical
3986.35	38.93	44.20	7.90	29.70	-6.60	32.33	68.20	-35.87	Pk	Horizontal
3986.35	36.18	44.20	7.90	29.70	-6.60	29.58	54.00	-24.42	AV	Horizontal
7227.19	36.83	43.50	11.40	35.50	3.40	40.23	68.20	-27.97	Pk	Vertical
7227.19	33.93	43.50	11.40	35.50	3.40	37.33	54.00	-16.67	AV	Vertical
7225.76	37.04	43.50	11.40	35.50	3.40	40.44	68.20	-27.76	Pk	Horizontal
7225.76	33.65	43.50	11.40	35.50	3.40	37.05	54.00	-16.95	AV	Horizontal
10360.04	38.94	44.50	13.80	38.80	8.10	47.04	68.20	-21.16	Pk	Vertical
10360.04	35.97	44.50	13.80	38.80	8.10	44.07	54.00	-9.93	AV	Vertical
10360.00	39.86	44.50	13.80	38.80	8.10	47.96	68.20	-20.24	Pk	Horizontal
10360.00	36.14	44.50	13.80	38.80	8.10	44.24	54.00	-9.76	AV	Horizontal
11032.17	33.39	43.60	14.30	39.50	10.20	43.59	68.20	-24.61	Pk	Vertical
11032.17	30.72	43.60	14.30	39.50	10.20	40.92	54.00	-13.08	AV	Vertical
11033.88	34.09	43.60	14.30	39.50	10.20	44.29	68.20	-23.91	Pk	Horizontal
11033.88	30.08	43.60	14.30	39.50	10.20	40.28	54.00	-13.72	AV	Horizontal
13280.85	32.53	42.60	15.90	38.90	12.20	44.73	68.20	-23.47	Pk	Vertical
13280.85	29.11	42.60	15.90	38.90	12.20	41.31	54.00	-12.69	AV	Vertical
13298.09	32.40	42.60	15.90	38.90	12.20	44.60	68.20	-23.60	Pk	Horizontal
13298.09	28.83	42.60	15.90	38.90	12.20	41.03	54.00	-12.97	AV	Horizontal
Mid Channel (802.11n(HT20)/ 5300 MHz)										
3248.64	43.95	44.70	6.70	28.20	-9.80	34.15	68.20	-34.05	Pk	Vertical
3248.64	41.81	44.70	6.70	28.20	-9.80	32.01	54.00	-21.99	AV	Vertical
3262.38	44.04	44.70	6.70	28.20	-9.80	34.24	68.20	-33.96	Pk	Horizontal
3262.38	40.94	44.70	6.70	28.20	-9.80	31.14	54.00	-22.86	AV	Horizontal
3989.38	40.11	44.20	7.90	29.70	-6.60	33.51	68.20	-34.69	Pk	Vertical
3989.38	36.87	44.20	7.90	29.70	-6.60	30.27	54.00	-23.73	AV	Vertical
3992.17	39.63	44.20	7.90	29.70	-6.60	33.03	68.20	-35.17	Pk	Horizontal
3992.17	36.03	44.20	7.90	29.70	-6.60	29.43	54.00	-24.57	AV	Horizontal
7232.11	36.76	43.50	11.40	35.50	3.40	40.16	68.20	-28.04	Pk	Vertical
7232.11	34.73	43.50	11.40	35.50	3.40	38.13	54.00	-15.87	AV	Vertical
7217.69	37.19	43.50	11.40	35.50	3.40	40.59	68.20	-27.61	Pk	Horizontal
7217.69	34.87	43.50	11.40	35.50	3.40	38.27	54.00	-15.73	AV	Horizontal
10400.27	38.79	44.50	13.80	38.80	8.10	46.89	68.20	-21.31	Pk	Vertical
10400.27	35.81	44.50	13.80	38.80	8.10	43.91	54.00	-10.09	AV	Vertical
10400.21	39.24	44.50	13.80	38.80	8.10	47.34	68.20	-20.86	Pk	Horizontal
10400.21	35.90	44.50	13.80	38.80	8.10	44.00	54.00	-10.00	AV	Horizontal
11036.16	32.87	43.60	14.30	39.50	10.20	43.07	68.20	-25.13	Pk	Vertical
11036.16	30.63	43.60	14.30	39.50	10.20	40.83	54.00	-13.17	AV	Vertical
11021.13	33.55	43.60	14.30	39.50	10.20	43.75	68.20	-24.45	Pk	Horizontal
11021.13	29.93	43.60	14.30	39.50	10.20	40.13	54.00	-13.87	AV	Horizontal
13288.13	32.15	42.60	15.90	38.90	12.20	44.35	68.20	-23.85	Pk	Vertical
13288.13	29.51	42.60	15.90	38.90	12.20	41.71	54.00	-12.29	AV	Vertical
13292.38	32.33	42.60	15.90	38.90	12.20	44.53	68.20	-23.67	Pk	Horizontal
13292.38	29.32	42.60	15.90	38.90	12.20	41.52	54.00	-12.48	AV	Horizontal



High Channel (802.11n(HT20)/ 5320 MHz)										
3247.90	44.20	44.70	6.70	28.20	-9.80	34.40	68.20	-33.80	Pk	Vertical
3247.90	41.84	44.70	6.70	28.20	-9.80	32.04	54.00	-21.96	AV	Vertical
3247.89	44.51	44.70	6.70	28.20	-9.80	34.71	68.20	-33.49	Pk	Horizontal
3247.89	40.94	44.70	6.70	28.20	-9.80	31.14	54.00	-22.86	AV	Horizontal
3998.14	38.93	44.20	7.90	29.70	-6.60	32.33	68.20	-35.87	Pk	Vertical
3998.14	35.76	44.20	7.90	29.70	-6.60	29.16	54.00	-24.84	AV	Vertical
3983.84	39.80	44.20	7.90	29.70	-6.60	33.20	68.20	-35.00	Pk	Horizontal
3983.84	37.00	44.20	7.90	29.70	-6.60	30.40	54.00	-23.60	AV	Horizontal
7231.31	37.28	43.50	11.40	35.50	3.40	40.68	68.20	-27.52	Pk	Vertical
7231.31	33.92	43.50	11.40	35.50	3.40	37.32	54.00	-16.68	AV	Vertical
7223.40	37.14	43.50	11.40	35.50	3.40	40.54	68.20	-27.66	Pk	Horizontal
7223.40	34.51	43.50	11.40	35.50	3.40	37.91	54.00	-16.09	AV	Horizontal
10480.18	39.68	44.50	13.80	38.80	8.10	47.78	68.20	-20.42	Pk	Vertical
10480.18	36.69	44.50	13.80	38.80	8.10	44.79	54.00	-9.21	AV	Vertical
10480.27	39.04	44.50	13.80	38.80	8.10	47.14	68.20	-21.06	Pk	Horizontal
10480.27	35.88	44.50	13.80	38.80	8.10	43.98	54.00	-10.02	AV	Horizontal
11033.15	34.00	43.60	14.30	39.50	10.20	44.20	68.20	-24.00	Pk	Vertical
11033.15	30.66	43.60	14.30	39.50	10.20	40.86	54.00	-13.14	AV	Vertical
11027.50	32.92	43.60	14.30	39.50	10.20	43.12	68.20	-25.08	Pk	Horizontal
11027.50	30.02	43.60	14.30	39.50	10.20	40.22	54.00	-13.78	AV	Horizontal
13294.05	32.64	42.60	15.90	38.90	12.20	44.84	68.20	-23.36	Pk	Vertical
13294.05	29.82	42.60	15.90	38.90	12.20	42.02	54.00	-11.98	AV	Vertical
13295.01	33.00	42.60	15.90	38.90	12.20	45.20	68.20	-23.00	Pk	Horizontal
13295.01	29.61	42.60	15.90	38.90	12.20	41.81	54.00	-12.19	AV	Horizontal

Remark:

1. Factor = Antenna Factor + Cable Loss – Pre-amplifier.
2. Scan with 802.11a,802.11n (HT-20),802.11n (HT-40), 802.11ac (VHT-20),802.11ac (VHT-40), 802.11ac (VHT-80) the worst case is 802.11n (HT-20).
3. The frequency emission of peak points that did not show above the forms are at least 20dB below the limit, the frequency emission is mainly from the environment noise.
4. Pre-scan both the SISO and MIMO mode, only the worst-case results were reported.



Band III 5470-5725MHz

Frequency (MHz)	Reading (dBuV)	Amplifier (dB)	Loss (dB)	Antenna Factor (dB/m)	Orrected Factor (dB)	Emission Level (dBuV/m)	Limit (dBuV/m)	Margin (dB)	Detector	Comment
Low Channel (802.11n(HT20)/ 5500 MHz)										
3247.73	44.25	44.70	6.70	28.20	-9.80	34.45	68.20	-33.75	Pk	Vertical
3247.73	41.11	44.70	6.70	28.20	-9.80	31.31	54.00	-22.69	AV	Vertical
3260.32	44.81	44.70	6.70	28.20	-9.80	35.01	68.20	-33.19	Pk	Horizontal
3260.32	41.82	44.70	6.70	28.20	-9.80	32.02	54.00	-21.98	AV	Horizontal
3987.49	38.76	44.20	7.90	29.70	-6.60	32.16	68.20	-36.04	Pk	Vertical
3987.49	36.33	44.20	7.90	29.70	-6.60	29.73	54.00	-24.27	AV	Vertical
3992.44	39.86	44.20	7.90	29.70	-6.60	33.26	68.20	-34.94	Pk	Horizontal
3992.44	36.07	44.20	7.90	29.70	-6.60	29.47	54.00	-24.53	AV	Horizontal
7220.13	36.64	43.50	11.40	35.50	3.40	40.04	68.20	-28.16	Pk	Vertical
7220.13	33.57	43.50	11.40	35.50	3.40	36.97	54.00	-17.03	AV	Vertical
7234.29	36.54	43.50	11.40	35.50	3.40	39.94	68.20	-28.26	Pk	Horizontal
7234.29	33.58	43.50	11.40	35.50	3.40	36.98	54.00	-17.02	AV	Horizontal
10360.07	38.95	44.50	13.80	38.80	8.10	47.05	68.20	-21.15	Pk	Vertical
10360.07	36.47	44.50	13.80	38.80	8.10	44.57	54.00	-9.43	AV	Vertical
10360.05	39.87	44.50	13.80	38.80	8.10	47.97	68.20	-20.23	Pk	Horizontal
10360.05	35.77	44.50	13.80	38.80	8.10	43.87	54.00	-10.13	AV	Horizontal
11020.03	32.89	43.60	14.30	39.50	10.20	43.09	68.20	-25.11	Pk	Vertical
11020.03	29.80	43.60	14.30	39.50	10.20	40.00	54.00	-14.00	AV	Vertical
11024.63	33.66	43.60	14.30	39.50	10.20	43.86	68.20	-24.34	Pk	Horizontal
11024.63	30.96	43.60	14.30	39.50	10.20	41.16	54.00	-12.84	AV	Horizontal
13285.24	32.98	42.60	15.90	38.90	12.20	45.18	68.20	-23.02	Pk	Vertical
13285.24	29.88	42.60	15.90	38.90	12.20	42.08	54.00	-11.92	AV	Vertical
13293.81	32.37	42.60	15.90	38.90	12.20	44.57	68.20	-23.63	Pk	Horizontal
13293.81	28.66	42.60	15.90	38.90	12.20	40.86	54.00	-13.14	AV	Horizontal
Mid Channel (802.11n(HT20)/ 5580 MHz)										
3263.67	44.06	44.70	6.70	28.20	-9.80	34.26	68.20	-33.94	Pk	Vertical
3263.67	40.80	44.70	6.70	28.20	-9.80	31.00	54.00	-23.00	AV	Vertical
3262.15	44.06	44.70	6.70	28.20	-9.80	34.26	68.20	-33.94	Pk	Horizontal
3262.15	41.10	44.70	6.70	28.20	-9.80	31.30	54.00	-22.70	AV	Horizontal
3990.04	39.40	44.20	7.90	29.70	-6.60	32.80	68.20	-35.40	Pk	Vertical
3990.04	35.93	44.20	7.90	29.70	-6.60	29.33	54.00	-24.67	AV	Vertical
3986.57	39.33	44.20	7.90	29.70	-6.60	32.73	68.20	-35.47	Pk	Horizontal
3986.57	35.66	44.20	7.90	29.70	-6.60	29.06	54.00	-24.94	AV	Horizontal
7236.26	37.91	43.50	11.40	35.50	3.40	41.31	68.20	-26.89	Pk	Vertical
7236.26	33.89	43.50	11.40	35.50	3.40	37.29	54.00	-16.71	AV	Vertical
7230.95	36.80	43.50	11.40	35.50	3.40	40.20	68.20	-28.00	Pk	Horizontal
7230.95	34.77	43.50	11.40	35.50	3.40	38.17	54.00	-15.83	AV	Horizontal
10400.14	38.77	44.50	13.80	38.80	8.10	46.87	68.20	-21.33	Pk	Vertical
10400.14	36.30	44.50	13.80	38.80	8.10	44.40	54.00	-9.60	AV	Vertical
10400.08	39.96	44.50	13.80	38.80	8.10	48.06	68.20	-20.14	Pk	Horizontal
10400.08	36.73	44.50	13.80	38.80	8.10	44.83	54.00	-9.17	AV	Horizontal
11030.78	33.34	43.60	14.30	39.50	10.20	43.54	68.20	-24.66	Pk	Vertical
11030.78	31.01	43.60	14.30	39.50	10.20	41.21	54.00	-12.79	AV	Vertical
11029.79	33.84	43.60	14.30	39.50	10.20	44.04	68.20	-24.16	Pk	Horizontal
11029.79	30.89	43.60	14.30	39.50	10.20	41.09	54.00	-12.91	AV	Horizontal
13286.70	32.98	42.60	15.90	38.90	12.20	45.18	68.20	-23.02	Pk	Vertical
13286.70	28.57	42.60	15.90	38.90	12.20	40.77	54.00	-13.23	AV	Vertical
13282.36	32.50	42.60	15.90	38.90	12.20	44.70	68.20	-23.50	Pk	Horizontal
13282.36	28.98	42.60	15.90	38.90	12.20	41.18	54.00	-12.82	AV	Horizontal



High Channel (802.11n(HT20)/ 5700 MHz)										
3254.29	44.29	44.70	6.70	28.20	-9.80	34.49	68.20	-33.71	Pk	Vertical
3254.29	41.06	44.70	6.70	28.20	-9.80	31.26	54.00	-22.74	AV	Vertical
3256.58	44.07	44.70	6.70	28.20	-9.80	34.27	68.20	-33.93	Pk	Horizontal
3256.58	41.32	44.70	6.70	28.20	-9.80	31.52	54.00	-22.48	AV	Horizontal
3983.04	39.54	44.20	7.90	29.70	-6.60	32.94	68.20	-35.26	Pk	Vertical
3983.04	36.84	44.20	7.90	29.70	-6.60	30.24	54.00	-23.76	AV	Vertical
3984.63	39.52	44.20	7.90	29.70	-6.60	32.92	68.20	-35.28	Pk	Horizontal
3984.63	36.18	44.20	7.90	29.70	-6.60	29.58	54.00	-24.42	AV	Horizontal
7227.38	36.81	43.50	11.40	35.50	3.40	40.21	68.20	-27.99	Pk	Vertical
7227.38	34.34	43.50	11.40	35.50	3.40	37.74	54.00	-16.26	AV	Vertical
7232.61	37.37	43.50	11.40	35.50	3.40	40.77	68.20	-27.43	Pk	Horizontal
7232.61	33.86	43.50	11.40	35.50	3.40	37.26	54.00	-16.74	AV	Horizontal
10480.11	39.03	44.50	13.80	38.80	8.10	47.13	68.20	-21.07	Pk	Vertical
10480.11	36.32	44.50	13.80	38.80	8.10	44.42	54.00	-9.58	AV	Vertical
10480.36	39.68	44.50	13.80	38.80	8.10	47.78	68.20	-20.42	Pk	Horizontal
10480.36	35.76	44.50	13.80	38.80	8.10	43.86	54.00	-10.14	AV	Horizontal
11027.56	33.36	43.60	14.30	39.50	10.20	43.56	68.20	-24.64	Pk	Vertical
11027.56	29.91	43.60	14.30	39.50	10.20	40.11	54.00	-13.89	AV	Vertical
11023.50	33.24	43.60	14.30	39.50	10.20	43.44	68.20	-24.76	Pk	Horizontal
11023.50	30.79	43.60	14.30	39.50	10.20	40.99	54.00	-13.01	AV	Horizontal
13280.92	31.57	42.60	15.90	38.90	12.20	43.77	68.20	-24.43	Pk	Vertical
13280.92	29.34	42.60	15.90	38.90	12.20	41.54	54.00	-12.46	AV	Vertical
13280.11	32.22	42.60	15.90	38.90	12.20	44.42	68.20	-23.78	Pk	Horizontal
13280.11	28.64	42.60	15.90	38.90	12.20	40.84	54.00	-13.16	AV	Horizontal

Remark:

1. Factor = Antenna Factor + Cable Loss – Pre-amplifier.
2. Scan with 802.11a, 802.11n (HT-20), 802.11n (HT-40), 802.11ac (VHT-20), 802.11ac (VHT-40), 802.11ac (VHT-80) the worst case is 802.11n (HT-20).
3. The frequency emission of peak points that did not show above the forms are at least 20dB below the limit, the frequency emission is mainly from the environment noise.
4. Pre-scan both the SISO and MIMO mode, only the worst-case results were reported.



Band IV(5.725-5.850) GHz

Frequency (MHz)	Reading	Amplifier	Loss	Antenna Factor	Orrected Factor	Emission Level	Limit (dBuV/m)	Margin	Detector	Comment
	(dBuV)	(dB)	(dB)	(dB/m)	(dB)	(dBuV/m)		(dB)		
Low Channel (802.11n(HT20)/ 5745 MHz)										
3248.30	44.70	44.70	6.70	28.20	-9.80	34.90	68.20	-33.30	Pk	Vertical
3248.30	40.97	44.70	6.70	28.20	-9.80	31.17	54.00	-22.83	AV	Vertical
3249.33	45.13	44.70	6.70	28.20	-9.80	35.33	68.20	-32.87	Pk	Horizontal
3249.33	41.74	44.70	6.70	28.20	-9.80	31.94	54.00	-22.06	AV	Horizontal
3998.57	38.82	44.20	7.90	29.70	-6.60	32.22	68.20	-35.98	Pk	Vertical
3998.57	36.67	44.20	7.90	29.70	-6.60	30.07	54.00	-23.93	AV	Vertical
3982.68	39.03	44.20	7.90	29.70	-6.60	32.43	68.20	-35.77	Pk	Horizontal
3982.68	35.73	44.20	7.90	29.70	-6.60	29.13	54.00	-24.87	AV	Horizontal
7230.38	36.88	43.50	11.40	35.50	3.40	40.28	68.20	-27.92	Pk	Vertical
7230.38	34.12	43.50	11.40	35.50	3.40	37.52	54.00	-16.48	AV	Vertical
7230.48	37.25	43.50	11.40	35.50	3.40	40.65	68.20	-27.55	Pk	Horizontal
7230.48	34.72	43.50	11.40	35.50	3.40	38.12	54.00	-15.88	AV	Horizontal
10360.40	39.68	44.50	13.80	38.80	8.10	47.78	68.20	-20.42	Pk	Vertical
10360.40	36.20	44.50	13.80	38.80	8.10	44.30	54.00	-9.70	AV	Vertical
10360.21	39.34	44.50	13.80	38.80	8.10	47.44	68.20	-20.76	Pk	Horizontal
10360.21	36.54	44.50	13.80	38.80	8.10	44.64	54.00	-9.36	AV	Horizontal
11026.30	32.92	43.60	14.30	39.50	10.20	43.12	68.20	-25.08	Pk	Vertical
11026.30	29.90	43.60	14.30	39.50	10.20	40.10	54.00	-13.90	AV	Vertical
11016.56	32.93	43.60	14.30	39.50	10.20	43.13	68.20	-25.07	Pk	Horizontal
11016.56	29.90	43.60	14.30	39.50	10.20	40.10	54.00	-13.90	AV	Horizontal
13293.36	32.32	42.60	15.90	38.90	12.20	44.52	68.20	-23.68	Pk	Vertical
13293.36	28.93	42.60	15.90	38.90	12.20	41.13	54.00	-12.87	AV	Vertical
13289.53	31.67	42.60	15.90	38.90	12.20	43.87	68.20	-24.33	Pk	Horizontal
13289.53	29.39	42.60	15.90	38.90	12.20	41.59	54.00	-12.41	AV	Horizontal
Mid Channel (802.11n(HT20)/ 5785MHz)										
3251.86	43.89	44.70	6.70	28.20	-9.80	34.09	68.20	-34.11	Pk	Vertical
3251.86	41.06	44.70	6.70	28.20	-9.80	31.26	54.00	-22.74	AV	Vertical
3257.43	45.24	44.70	6.70	28.20	-9.80	35.44	68.20	-32.76	Pk	Horizontal
3257.43	41.13	44.70	6.70	28.20	-9.80	31.33	54.00	-22.67	AV	Horizontal
3994.69	39.53	44.20	7.90	29.70	-6.60	32.93	68.20	-35.27	Pk	Vertical
3994.69	36.43	44.20	7.90	29.70	-6.60	29.83	54.00	-24.17	AV	Vertical
3994.61	39.06	44.20	7.90	29.70	-6.60	32.46	68.20	-35.74	Pk	Horizontal
3994.61	36.30	44.20	7.90	29.70	-6.60	29.70	54.00	-24.30	AV	Horizontal
7217.36	36.83	43.50	11.40	35.50	3.40	40.23	68.20	-27.97	Pk	Vertical
7217.36	33.61	43.50	11.40	35.50	3.40	37.01	54.00	-16.99	AV	Vertical
7235.97	36.84	43.50	11.40	35.50	3.40	40.24	68.20	-27.96	Pk	Horizontal
7235.97	34.84	43.50	11.40	35.50	3.40	38.24	54.00	-15.76	AV	Horizontal
10400.34	39.00	44.50	13.80	38.80	8.10	47.10	68.20	-21.10	Pk	Vertical
10400.34	35.80	44.50	13.80	38.80	8.10	43.90	54.00	-10.10	AV	Vertical
10400.10	39.20	44.50	13.80	38.80	8.10	47.30	68.20	-20.90	Pk	Horizontal
10400.10	36.50	44.50	13.80	38.80	8.10	44.60	54.00	-9.40	AV	Horizontal
11027.53	33.12	43.60	14.30	39.50	10.20	43.32	68.20	-24.88	Pk	Vertical
11027.53	29.72	43.60	14.30	39.50	10.20	39.92	54.00	-14.08	AV	Vertical
11021.36	33.02	43.60	14.30	39.50	10.20	43.22	68.20	-24.98	Pk	Horizontal
11021.36	30.37	43.60	14.30	39.50	10.20	40.57	54.00	-13.43	AV	Horizontal
13292.37	32.92	42.60	15.90	38.90	12.20	45.12	68.20	-23.08	Pk	Vertical
13292.37	29.23	42.60	15.90	38.90	12.20	41.43	54.00	-12.57	AV	Vertical
13296.42	32.16	42.60	15.90	38.90	12.20	44.36	68.20	-23.84	Pk	Horizontal
13296.42	28.85	42.60	15.90	38.90	12.20	41.05	54.00	-12.95	AV	Horizontal



High Channel (802.11n(HT20)/ 5825 MHz)										
3254.64	45.09	44.70	6.70	28.20	-9.80	35.29	68.20	-32.91	Pk	Vertical
3254.64	42.21	44.70	6.70	28.20	-9.80	32.41	54.00	-21.59	AV	Vertical
3262.10	45.11	44.70	6.70	28.20	-9.80	35.31	68.20	-32.89	Pk	Horizontal
3262.10	41.39	44.70	6.70	28.20	-9.80	31.59	54.00	-22.41	AV	Horizontal
3991.77	38.69	44.20	7.90	29.70	-6.60	32.09	68.20	-36.11	Pk	Vertical
3991.77	36.17	44.20	7.90	29.70	-6.60	29.57	54.00	-24.43	AV	Vertical
3988.89	39.09	44.20	7.90	29.70	-6.60	32.49	68.20	-35.71	Pk	Horizontal
3988.89	36.61	44.20	7.90	29.70	-6.60	30.01	54.00	-23.99	AV	Horizontal
7227.06	37.22	43.50	11.40	35.50	3.40	40.62	68.20	-27.58	Pk	Vertical
7227.06	34.38	43.50	11.40	35.50	3.40	37.78	54.00	-16.22	AV	Vertical
7234.40	36.81	43.50	11.40	35.50	3.40	40.21	68.20	-27.99	Pk	Horizontal
7234.40	34.38	43.50	11.40	35.50	3.40	37.78	54.00	-16.22	AV	Horizontal
10480.38	39.12	44.50	13.80	38.80	8.10	47.22	68.20	-20.98	Pk	Vertical
10480.38	36.31	44.50	13.80	38.80	8.10	44.41	54.00	-9.59	AV	Vertical
10480.38	40.12	44.50	13.80	38.80	8.10	48.22	68.20	-19.98	Pk	Horizontal
10480.38	36.57	44.50	13.80	38.80	8.10	44.67	54.00	-9.33	AV	Horizontal
11032.77	33.01	43.60	14.30	39.50	10.20	43.21	68.20	-24.99	Pk	Vertical
11032.77	30.24	43.60	14.30	39.50	10.20	40.44	54.00	-13.56	AV	Vertical
11022.25	33.14	43.60	14.30	39.50	10.20	43.34	68.20	-24.86	Pk	Horizontal
11022.25	29.99	43.60	14.30	39.50	10.20	40.19	54.00	-13.81	AV	Horizontal
13296.30	32.40	42.60	15.90	38.90	12.20	44.60	68.20	-23.60	Pk	Vertical
13296.30	29.73	42.60	15.90	38.90	12.20	41.93	54.00	-12.07	AV	Vertical
13291.41	32.96	42.60	15.90	38.90	12.20	45.16	68.20	-23.04	Pk	Horizontal
13291.41	29.08	42.60	15.90	38.90	12.20	41.28	54.00	-12.72	AV	Horizontal

Remark:

1. Factor = Antenna Factor + Cable Loss – Pre-amplifier.
2. Scan with 802.11a, 802.11n (HT-20), 802.11n (HT-40), 802.11ac (VHT-20), 802.11ac (VHT-40), 802.11ac (VHT-80) the worst case is 802.11n (HT-20).
3. The frequency emission of peak points that did not show above the forms are at least 20dB below the limit, the frequency emission is mainly from the environment noise.
4. Pre-scan both the SISO and MIMO mode, only the worst-case results were reported.



3.2.9 Band Edge

Band I 5150-5250MHz

802.11n(HT20) Low
Horizontal

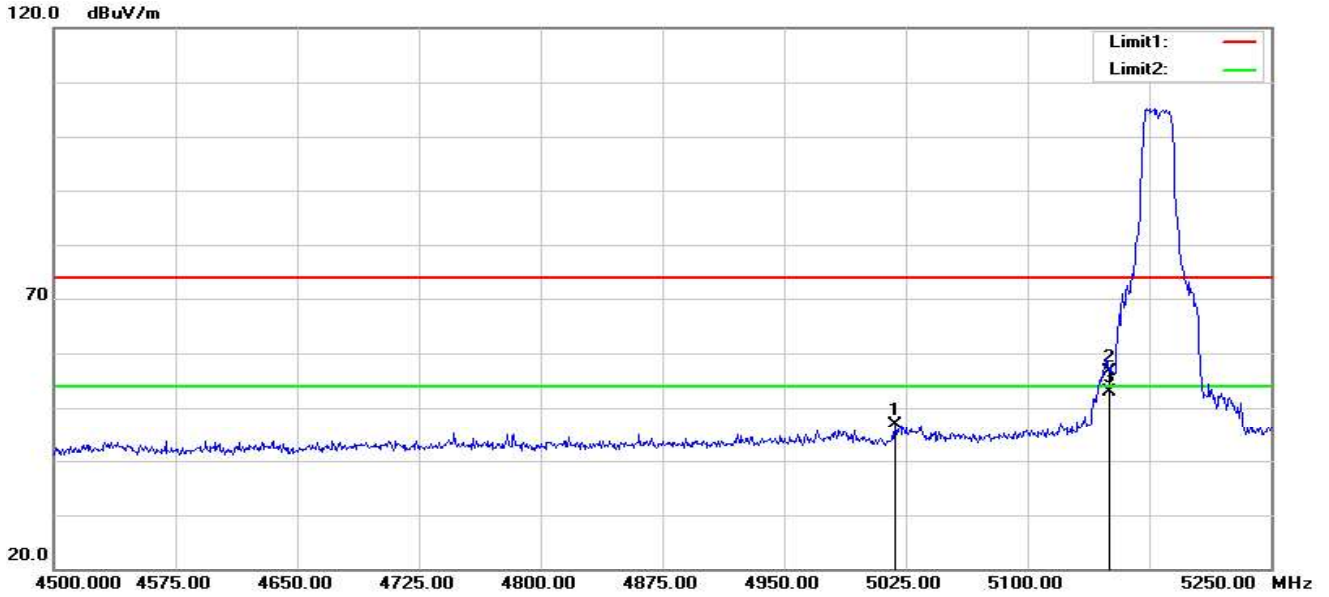

No.	Frequency (MHz)	Reading (dBuV)	Correct Factor(dB/m)	Result (dBuV/m)	Limit (dBuV/m)	Margin (dB)	Remark
1	5018.250	53.04	-6.11	46.93	74.00	-27.07	peak
2	5150.000	62.30	-5.73	56.57	74.00	-17.43	peak
3	5150.000	58.58	-5.73	52.85	54.00	-1.15	AVG

Vertical

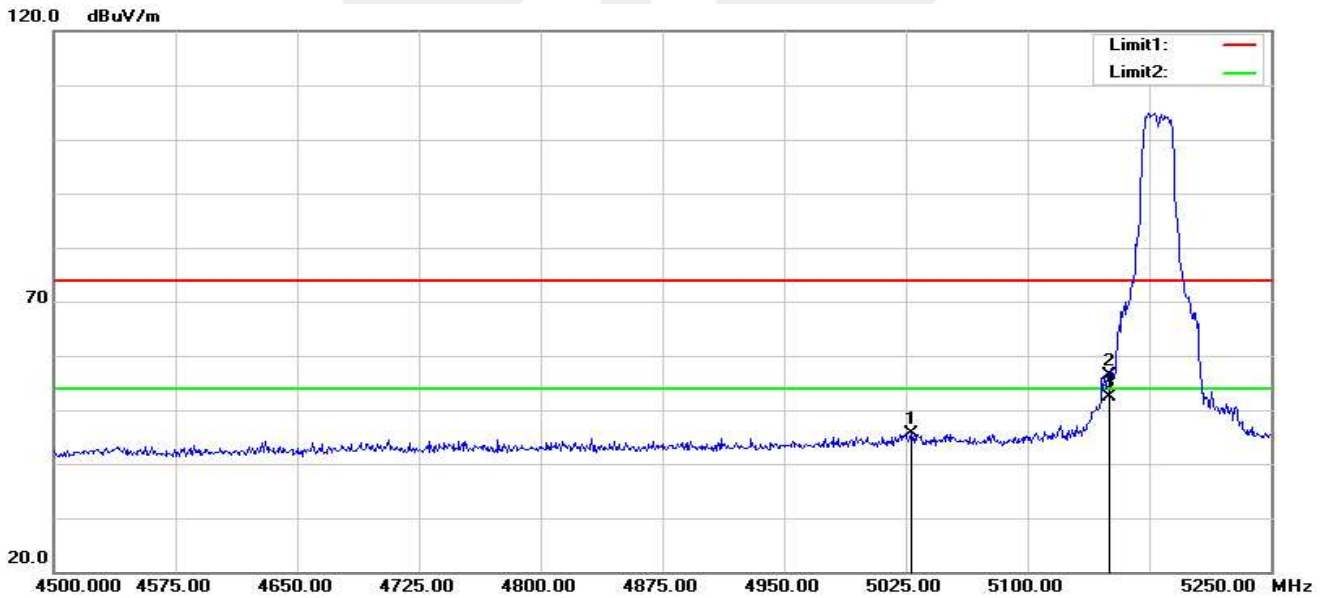

No.	Frequency (MHz)	Reading (dBuV)	Correct Factor(dB/m)	Result (dBuV/m)	Limit (dBuV/m)	Margin (dB)	Remark
1	5028.000	51.61	-6.07	45.54	74.00	-28.46	peak
2	5150.000	62.07	-5.73	56.34	74.00	-17.66	peak
3	5150.000	58.18	-5.73	52.45	54.00	-1.55	AVG



802.11n(HT20) High Horizontal

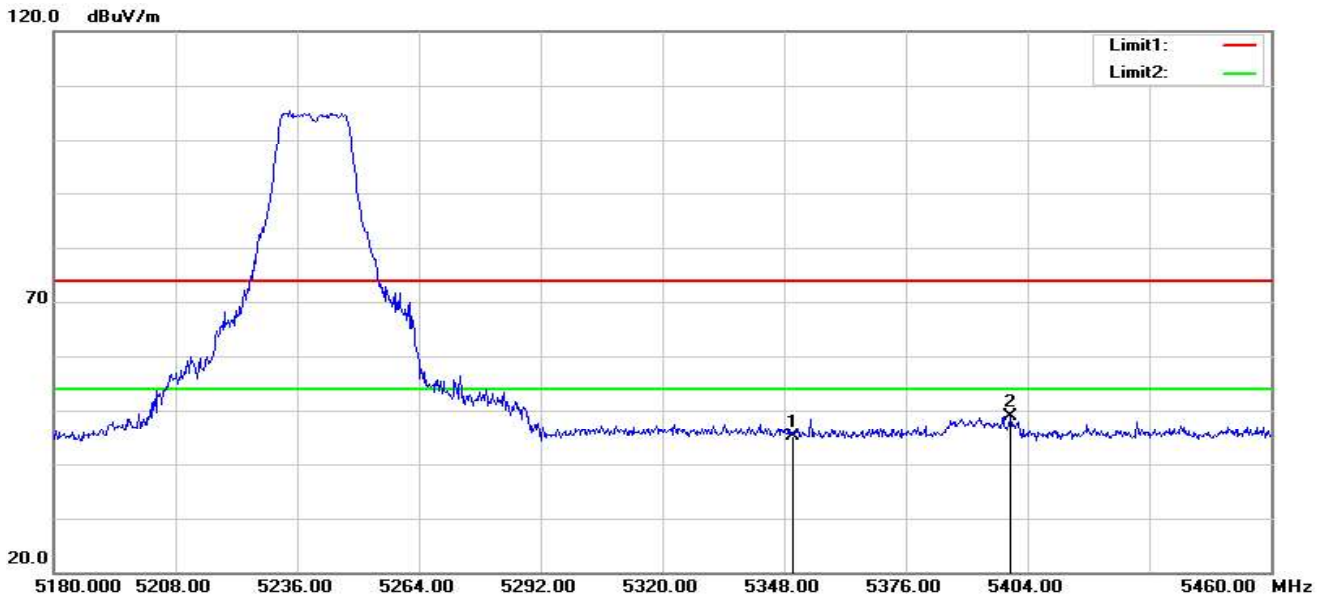

No.	Frequency (MHz)	Reading (dBuV)	Correct Factor(dB/m)	Result (dBuV/m)	Limit (dBuV/m)	Margin (dB)	Remark
1	5350.000	50.48	-5.23	45.25	74.00	-28.75	peak
2	5400.080	54.24	-5.25	48.99	74.00	-25.01	peak

Vertical

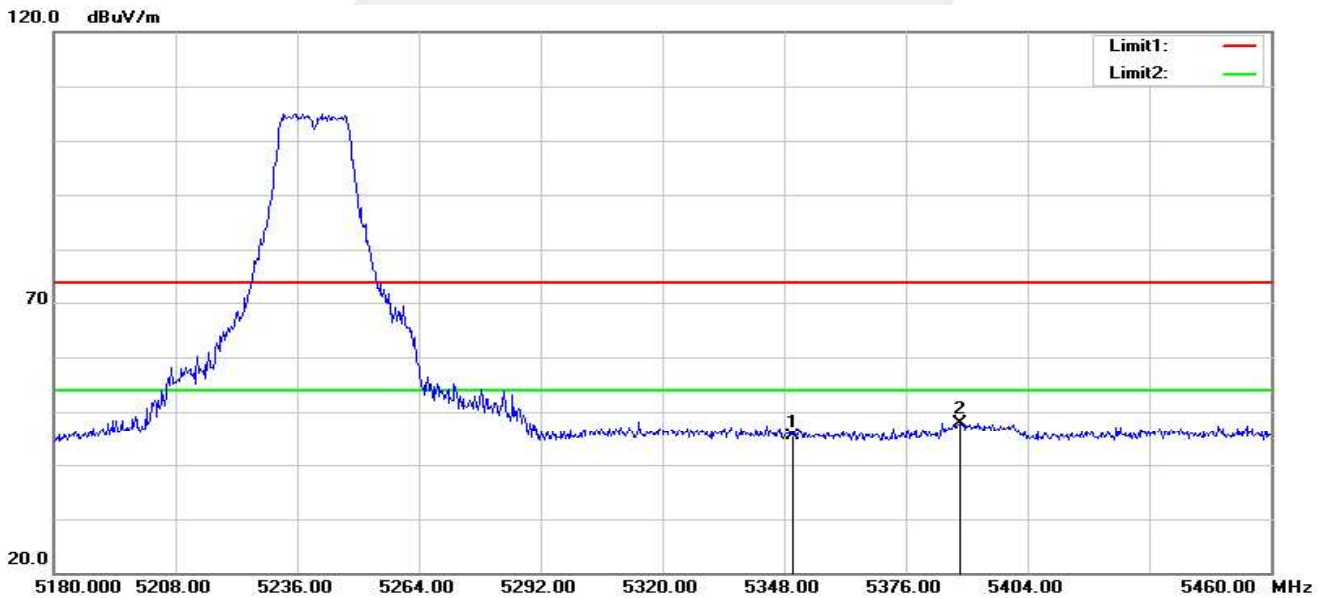

No.	Frequency (MHz)	Reading (dBuV)	Correct Factor(dB/m)	Result (dBuV/m)	Limit (dBuV/m)	Margin (dB)	Remark
1	5350.000	50.54	-5.23	45.31	74.00	-28.69	peak
2	5388.320	53.18	-5.25	47.93	74.00	-26.07	peak

Note: 1. 802.11a,802.11n (HT-20),802.11n (HT-40), 802.11ac (VHT-20),802.11ac (VHT-40), 802.11ac (VHT-80) all has been tested, the worst case is 802.11n (HT-20),only shown the worst case.

2. Pre-scan both the SISO and MIMO mode, only the worst-case results were reported.



Band II 5250-5350MHz

802.11n (HT-20) Low
Horizontal

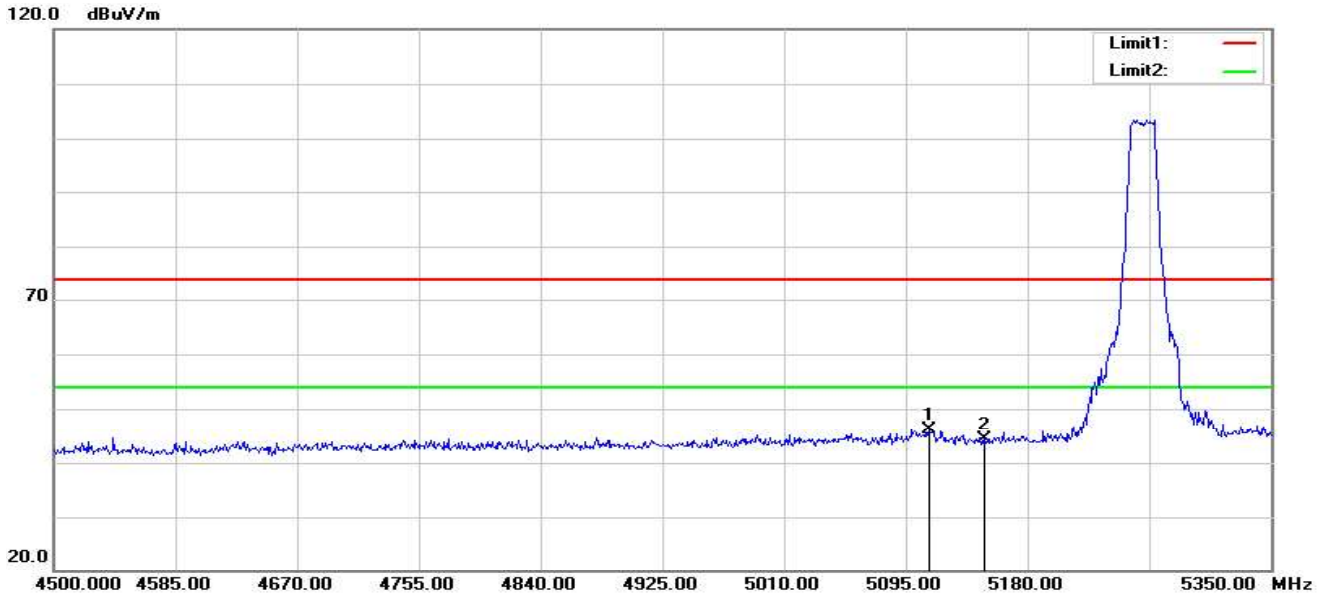

No.	Frequency (MHz)	Reading (dBuV)	Correct Factor(dB/m)	Result (dBuV/m)	Limit (dBuV/m)	Margin (dB)	Remark
1	5111.150	51.97	-5.74	46.23	74.00	-27.77	peak
2	5150.000	50.14	-5.73	44.41	74.00	-29.59	peak

Vertical

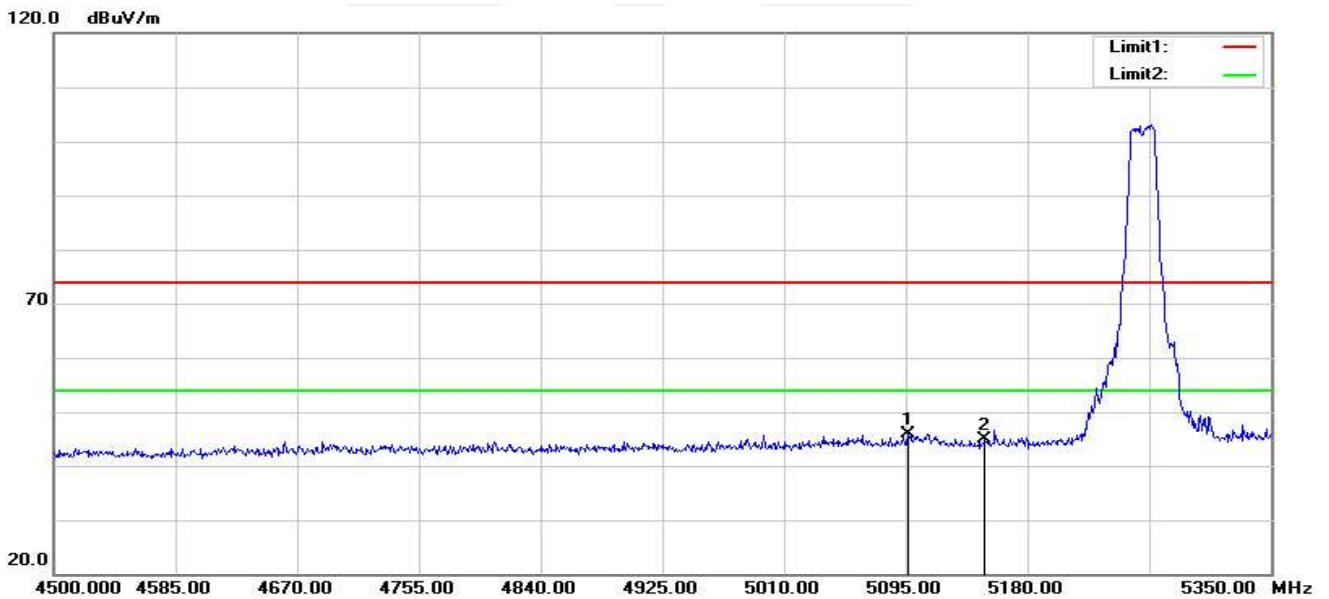

No.	Frequency (MHz)	Reading (dBuV)	Correct Factor(dB/m)	Result (dBuV/m)	Limit (dBuV/m)	Margin (dB)	Remark
1	5096.700	51.60	-5.75	45.85	74.00	-28.15	peak
2	5150.000	50.63	-5.73	44.90	74.00	-29.10	peak



802.11n (HT-20) High Horizontal

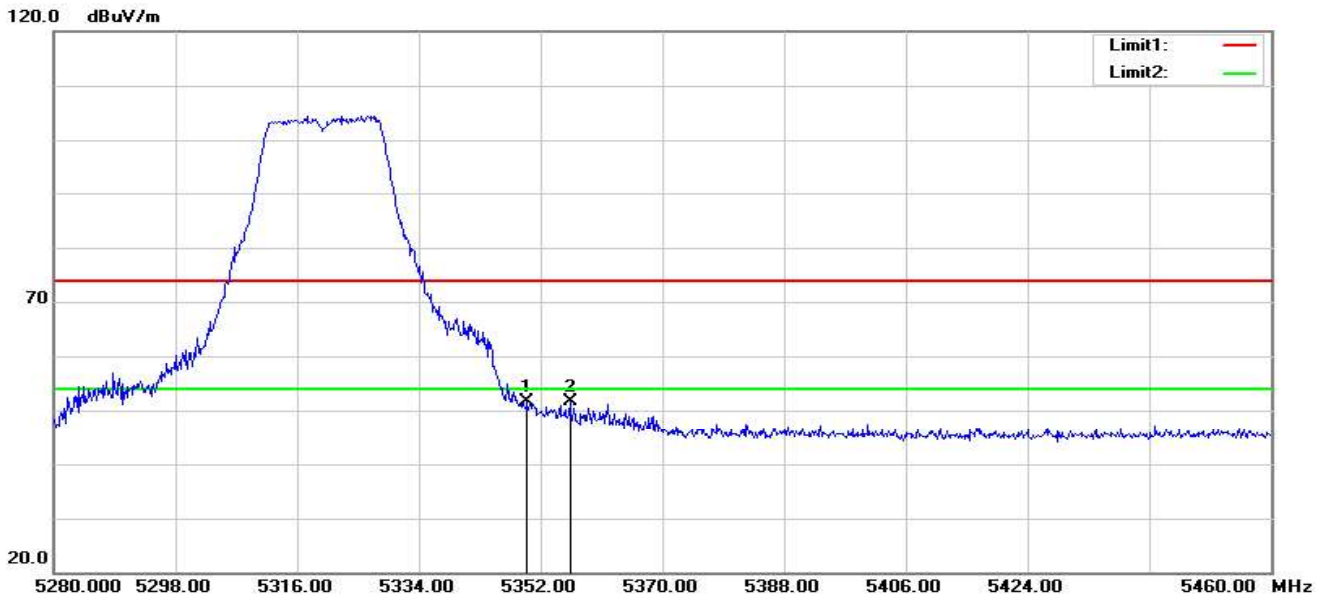

No.	Frequency (MHz)	Reading (dBuV)	Correct Factor(dB/m)	Result (dBuV/m)	Limit (dBuV/m)	Margin (dB)	Remark
1	5350.000	56.75	-5.23	51.52	74.00	-22.48	peak
2	5356.320	56.94	-5.23	51.71	74.00	-22.29	peak

Vertical

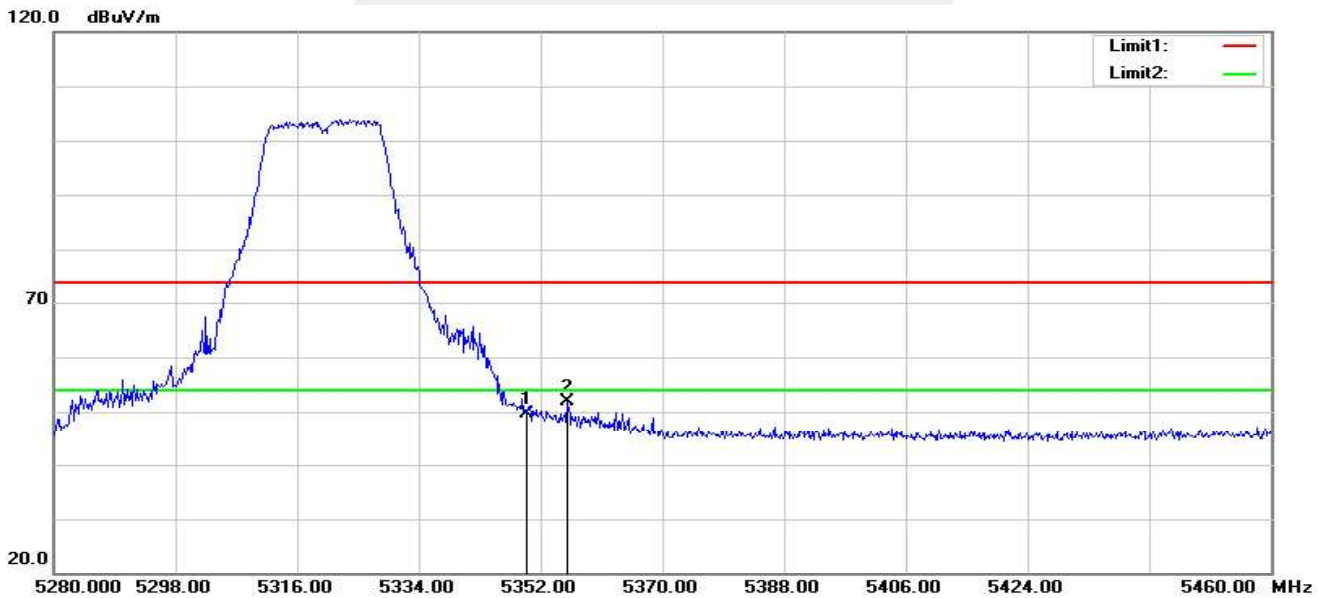

No.	Frequency (MHz)	Reading (dBuV)	Correct Factor(dB/m)	Result (dBuV/m)	Limit (dBuV/m)	Margin (dB)	Remark
1	5350.000	54.86	-5.23	49.63	74.00	-24.37	peak
2	5355.960	57.23	-5.24	51.99	74.00	-22.01	peak

Note: 1. 802.11a,802.11n (HT-20),802.11n (HT-40), 802.11ac (VHT-20),802.11ac (VHT-40), 802.11ac (VHT-80) all has been tested, the worst case is 802.11n (HT-20),only shown the worst case.

2. Pre-scan both the SISO and MIMO mode, only the worst-case results were reported.



Band III 5470-5725MHz

802.11n (HT-20) Low
Horizontal

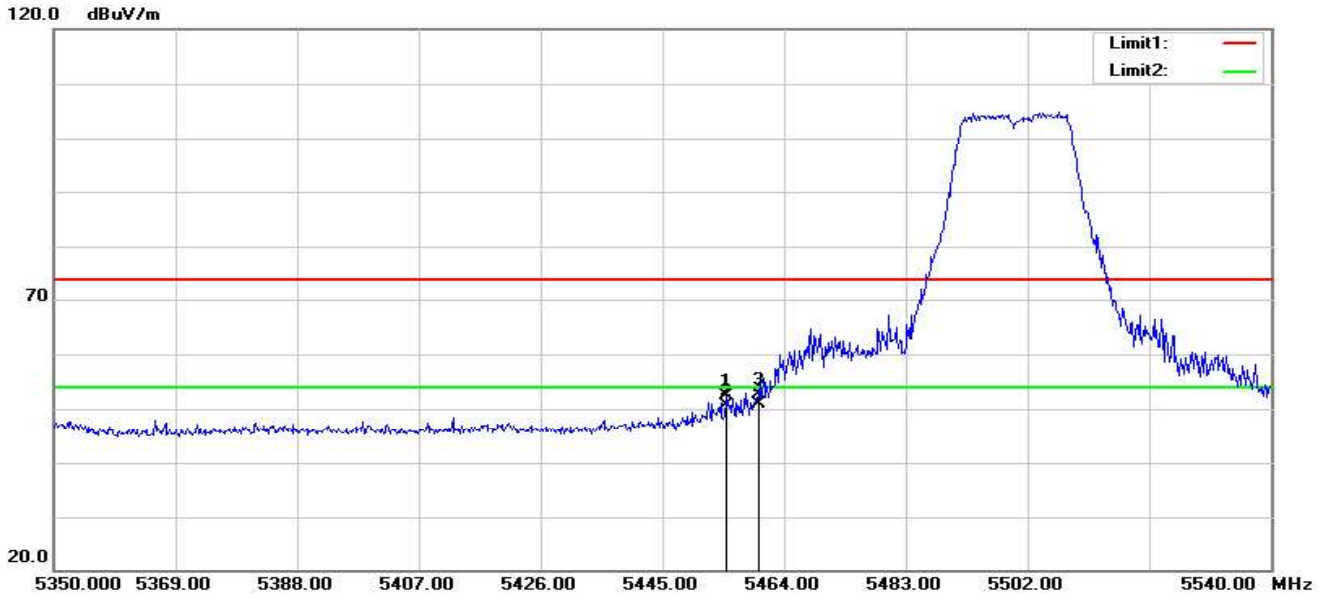

No.	Frequency (MHz)	Reading (dBuV)	Correct Factor(dB/m)	Result (dBuV/m)	Limit (dBuV/m)	Margin (dB)	Remark
1	5455.070	57.42	-5.13	52.29	74.00	-21.71	peak
2	5455.070	55.80	-5.13	50.67	54.00	-3.33	AVG
3	5460.000	57.86	-5.11	52.75	74.00	-21.25	peak
4	5460.000	56.03	-5.11	50.92	54.00	-3.08	AVG

Vertical

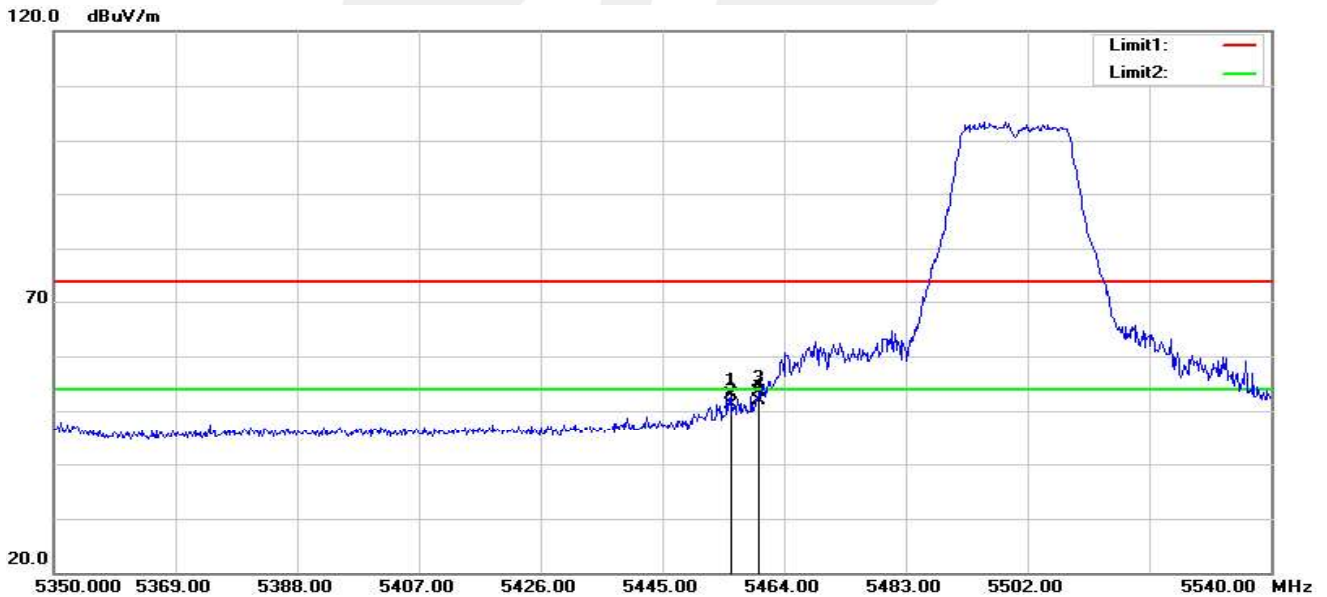

No.	Frequency (MHz)	Reading (dBuV)	Correct Factor(dB/m)	Result (dBuV/m)	Limit (dBuV/m)	Margin (dB)	Remark
1	5455.640	58.06	-5.13	52.93	74.00	-21.07	peak
2	5455.640	56.27	-5.13	51.14	54.00	-2.86	AVG
3	5460.000	58.42	-5.11	53.31	74.00	-20.69	peak
4	5460.000	56.96	-5.11	51.85	54.00	-2.15	AVG



Note: 1. 802.11a,802.11n (HT-20),802.11n (HT-40), 802.11ac (VHT-20),802.11ac (VHT-40), 802.11ac (VHT-80) all has been tested, the worst case is 802.11n (HT-20),only shown the worst case.

2. Pre-scan both the SISO and MIMO mode, only the worst-case results were reported.

3. The High channel main frequency is too far away from the restricted band and does not require testing.

Band IV(5.725-5.85 GHz)

Note: The main frequency is too far away from the restricted band and does not require testing.





4. CONDUCTED SPURIOUS EMISSIONS AND BANDEGE

4.1 LIMIT

Undesirable emission limits. Except as shown in paragraph (b)(7) of this section, the maximum emissions outside of the frequency bands of operation shall be attenuated in accordance with the following limits:

- (1) For transmitters operating in the 5.15-5.25 GHz band: All emissions outside of the 5.15-5.35 GHz band shall not exceed an e.i.r.p. of -27 dBm/MHz.
- (2) For transmitters operating in the 5.25-5.35 GHz band: All emissions outside of the 5.15-5.35 GHz band shall not exceed an e.i.r.p. of -27 dBm/MHz.
- (3) For transmitters operating in the 5.47-5.725 GHz band: All emissions outside of the 5.47-5.725 GHz band shall not exceed an e.i.r.p. of -27 dBm/MHz.
- (4) For transmitters operating in the 5.725-5.85 GHz band:
 - (i) All emissions shall be limited to a level of -27 dBm/MHz at 75 MHz or more above or below the band edge increasing linearly to 10 dBm/MHz at 25 MHz above or below the band edge, and from 25 MHz above or below the band edge increasing linearly to a level of 15.6 dBm/MHz at 5 MHz above or below the band edge, and from 5 MHz above or below the band edge increasing linearly to a level of 27 dBm/MHz at the band edge.

4.2 TEST PROCEDURE

Spectrum Parameter	Setting
Detector	Peak
Start/Stop Frequency	30 MHz to 10th carrier harmonic
RB / VB (emission in restricted band)	1000 KHz/3000 KHz
Trace-Mode:	Max hold

For Band edge

Spectrum Parameter	Setting
Detector	Peak
Start/Stop Frequency	Lower Band Edge: 5700 to 5725 MHz Upper Band Edge: 5850 to 5870 MHz
RB / VB (emission in restricted band)	1000 KHz/3000 KHz
Trace-Mode:	Max hold

4.3 DEVIATION FROM STANDARD

No deviation.

4.4 TEST SETUP

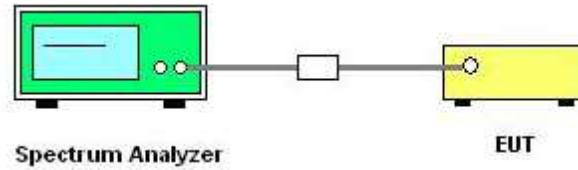

The EUT which is powered by the Battery, is coupled to the Spectrum Analyzer; the RF load attached to the EUT antenna terminal is 50Ohm; the path loss as the factor is calibrated to correct the reading.

Make the measurement with the spectrum analyzer's resolution bandwidth (RBW) = 1000 kHz. In order to make an accurate measurement, set the span greater than RBW.

4.5 EUT OPERATION CONDITIONS

The EUT tested system was configured as the statements of 2.3 Unless otherwise a special operating condition is specified in the follows during the testing.

4.6 TEST RESULTS

Data See Attachment A





5. POWER SPECTRAL DENSITY TEST

5.1 LIMIT

1. For mobile and portable client devices in the 5.15-5.25 GHz band, the maximum power spectral density shall not exceed 11 dBm in any 1 megahertz band. If transmitting antennas of directional gain greater than 6 dBi are used, both the maximum conducted output power and the maximum power spectral density shall be reduced by the amount in dB that the directional gain of the antenna exceeds 6 dBi.
2. For the 5.25-5.35 GHz and 5.47-5.725 GHz bands, the maximum power spectral density shall not exceed 11 dBm in any 1 megahertz band. If transmitting antennas of directional gain greater than 6 dBi are used, both the maximum conducted output power and the maximum power spectral density shall be reduced by the amount in dB that the directional gain of the antenna exceeds 6 dBi.
3. For the band 5.725-5.850 GHz, the peak power spectral density shall not exceed 30 dBm in any 500KHz band. If transmitting antenna directional gain is greater than 6 dBi, both the maximum conducted output power and the peak power spectral density shall be reduced by the amount in dB that the directional gain of the antenna exceeds 6 dBi.

5.2 TEST PROCEDURE

1. The setting follows Method SA-1 of FCC KDB 789033 D02 General U-NII Test Procedures New Rules v02r01.

For devices operating in the band, the rules specify a measurement bandwidth of 500 kHz.

Many spectrum analyzers do not have 500 kHz RBW, thus a narrower RBW may need to be used.

The rules permit the use of a RBWs less than 1 MHz, or 500 kHz, "provided that the measured power is integrated over the full reference bandwidth" to show the total power over the specified measurement bandwidth (*i.e.*, 1 MHz, or 500 kHz). If measurements are performed using a reduced resolution bandwidth (< 1 MHz, or < 500 kHz) and integrated over 1 MHz, or 500 KHz bandwidth, the following adjustments to the procedures apply:

- a) Set $RBW \geq 1/T$, where T is defined in section II.B.I.a).
- b) Set $VBW \geq 3 RBW$.
- c) If measurement bandwidth of Maximum PSD is specified in 500 kHz, add $10 \log (500\text{kHz}/RBW)$ to the measured result, whereas $RBW (< 500 \text{ kHz})$ is the reduced resolution bandwidth of the spectrum analyzer set during measurement.
- d) If measurement bandwidth of Maximum PSD is specified in 1 MHz, add $10 \log (1\text{MHz}/RBW)$ to the measured result, whereas $RBW (< 1 \text{ MHz})$ is the reduced resolution bandwidth of spectrum analyzer set during measurement.
- e) Care must be taken to ensure that the measurements are performed during a period of continuous transmission or are corrected upward for duty cycle.

Note: As a practical matter, it is recommended to use reduced RBW of 100 kHz for the sections 5.c) and 5.d) above, since $RBW=100 \text{ KHZ}$ is available on nearly all spectrum analyzers.



5.3 DEVIATION FROM STANDARD

No deviation.

5.4 TEST SETUP



5.5 EUT OPERATION CONDITIONS

The EUT tested system was configured as the statements of 2.1 Unless otherwise a special operating condition is specified in the follows during the testing.

5.6 TEST RESULTS

5150-5250MHz									
Frequency	Ant_A Power Density(dBm)	Ant_B Power Density(dBm)	Ant_A Duty cycle factor	Ant_B Duty cycle factor	Ant_A Power Density(dBm)	Ant_B Power Density(dBm)	Power Density Total(dBm)	Limit	Result
802.11a									
5180	2.912	0.235	0.69	0.69	3.602	0.925	--	11	PASS
5200	5.014	2.524	0.69	0.69	5.704	3.214	--	11	PASS
5240	2.351	2.362	0.69	0.69	3.041	3.052	--	11	PASS
802.11n20									
5180	4.178	1.324	0.70	0.70	4.878	2.024	6.692	11	PASS
5200	3.594	-2.311	0.70	0.70	4.294	-1.611	5.286	11	PASS
5240	0.146	1.248	0.70	0.70	0.846	1.948	4.442	11	PASS
802.11n40									
5190	-2.311	-5.152	0.70	0.70	-1.611	-4.452	0.207	11	PASS
5230	-2.572	-4.952	0.70	0.70	-1.872	-4.252	0.109	11	PASS
802.11ac20									
5180	4.135	1.827	0.70	0.70	4.835	2.527	6.843	11	PASS
5200	0.516	1.928	0.70	0.70	1.216	2.628	4.989	11	PASS
5240	3.714	1.612	0.70	0.70	4.414	2.312	6.499	11	PASS
802.11ac40									
5190	-2.009	-4.772	0.70	0.70	-1.309	-4.072	0.536	11	PASS
5230	-2.235	-5.013	0.70	0.70	-1.535	-4.313	0.305	11	PASS
802.11ac80									
5210	-4.249	-4.955	0.77	0.77	-3.479	-4.185	-0.807	11	PASS



5250-5350MHz									
Frequency	Ant_A Power Density(dBm)	Ant_B Power Density(dBm)	Ant_A Duty cycle factor	Ant_B Duty cycle factor	Ant_A Power Density(dBm)	Ant_B Power Density(dBm)	Power Density Total(dBm)	Limit	Result
802.11a									
5260	4.439	1.659	0.69	0.69	5.129	2.349	--	11	PASS
5300	3.860	1.589	0.69	0.69	4.550	2.279	--	11	PASS
5320	4.013	1.739	0.69	0.69	4.703	2.429	--	11	PASS
802.11n20									
5260	3.692	-0.969	0.70	0.70	4.392	-0.269	5.669	11	PASS
5300	3.867	-3.735	0.70	0.70	4.567	-3.035	5.263	11	PASS
5320	3.600	1.464	0.70	0.70	4.300	2.164	6.372	11	PASS
802.11n40									
5270	-0.139	-3.166	0.70	0.70	0.561	-2.466	2.316	11	PASS
5310	-0.362	-2.421	0.70	0.70	0.338	-1.721	2.440	11	PASS
802.11ac20									
5260	3.915	1.444	0.70	0.70	4.615	2.144	6.563	11	PASS
5300	3.715	0.916	0.70	0.70	4.415	1.616	6.247	11	PASS
5320	3.750	1.311	0.70	0.70	4.450	2.011	6.410	11	PASS
802.11ac40									
5270	-0.171	-2.473	0.73	0.73	0.559	-1.743	2.569	11	PASS
5310	-0.337	-2.316	0.73	0.73	0.393	-1.586	2.526	11	PASS
802.11ac80									
5290	-3.345	-5.047	0.73	0.73	-2.615	-4.317	-0.373	11	PASS



5470-5725MHz									
Frequency	Ant_A Power Density(dBm)	Ant_B Power Density(dBm)	Ant_A Duty cycle factor	Ant_B Duty cycle factor	Ant_A Power Density(dBm)	Ant_B Power Density(dBm)	Power Density Total(dBm)	Limit	Result
802.11a									
5500	7.002	3.523	0.69	0.69	7.692	4.213	--	11	PASS
5580	6.991	3.655	0.69	0.69	7.681	4.345	--	11	PASS
5700	7.815	4.001	0.69	0.69	8.505	4.691	--	11	PASS
802.11n20									
5500	4.737	1.632	0.70	0.70	5.437	2.332	7.167	11	PASS
5580	5.184	1.485	0.70	0.70	5.884	2.185	7.427	11	PASS
5700	3.322	1.861	0.70	0.70	4.022	2.561	6.363	11	PASS
802.11n40									
5510	0.932	-3.490	0.71	0.71	1.642	-2.780	2.981	11	PASS
5550	0.970	-2.908	0.71	0.71	1.680	-2.198	3.170	11	PASS
5670	1.337	-3.200	0.71	0.71	2.047	-2.490	3.356	11	PASS
802.11ac20									
5500	4.768	1.508	0.70	0.70	5.468	2.208	7.147	11	PASS
5580	5.080	1.524	0.70	0.70	5.780	2.224	7.367	11	PASS
5700	4.021	1.826	0.70	0.70	4.721	2.526	6.771	11	PASS
802.11ac40									
5510	0.760	-4.684	0.72	0.72	1.480	-3.964	2.571	11	PASS
5550	1.189	-2.687	0.72	0.72	1.909	-1.967	3.400	11	PASS
5670	1.681	-2.590	0.72	0.72	2.401	-1.870	3.781	11	PASS
802.11ac80									
5530	-3.651	-7.314	0.77	0.77	-2.881	-6.544	-1.327	11	PASS
5610	-3.650	-7.258	0.77	0.77	-2.880	-6.488	-1.309	11	PASS



5725-5850MHz											
Frequency	Use RBW 510KHz direct measurement Ant_A Power Density (dBm)	Use RBW 510KHz direct measurement Ant_B Power Density (dBm)	Convert to RBW 500KHz direct measurement Ant_A Power Density (dBm)	Convert to RBW 500KHz direct measurement Ant_B Power Density (dBm)	Ant_A Duty cycle factor (dB)	Ant_B Duty cycle factor (dB)	Final Ant_A Power Density (dBm)	Final Ant_B Power Density (dBm)	Power Density Total (dBm)	Limit (dBm)	Result
802.11a											
5745	5.099	1.558	5.013	1.472	0.700	0.700	5.713	2.172	--	30	PASS
5785	5.623	1.386	5.537	1.300	0.700	0.700	6.237	2.000	--	30	PASS
5825	5.009	2.175	4.923	2.089	0.700	0.700	5.623	2.789	--	30	PASS
802.11n20											
5745	1.818	-1.974	1.732	-2.060	0.700	0.700	2.432	-1.360	3.948	30	PASS
5785	1.912	-2.305	1.826	-2.391	0.700	0.700	2.526	-1.691	3.921	30	PASS
5825	1.732	-1.589	1.646	-1.675	0.700	0.700	2.346	-0.975	4.006	30	PASS
802.11n40											
5755	-1.084	-5.373	-1.170	-5.459	0.700	0.700	-0.470	-4.759	0.905	30	PASS
5795	-0.865	-5.159	-0.951	-5.245	0.700	0.700	-0.251	-4.545	1.123	30	PASS
802.11ac20											
5745	1.998	-2.157	1.912	-2.243	0.700	0.700	2.612	-1.543	4.024	30	PASS
5785	1.676	-2.249	1.590	-2.335	0.700	0.700	2.290	-1.635	3.767	30	PASS
5825	1.892	-1.868	1.806	-1.954	0.700	0.700	2.506	-1.254	4.031	30	PASS
802.11ac40											
5755	-1.101	-4.973	-1.187	-5.059	0.720	0.720	-0.467	-4.339	1.025	30	PASS
5795	-0.917	-5.193	-1.003	-5.279	0.720	0.720	-0.283	-4.559	1.096	30	PASS
802.11ac80											
5775	-3.642	-7.531	-3.728	-7.617	0.760	0.760	-2.968	-6.857	-1.481	30	PASS

Note: 1. RB Conversion formula= $10 \cdot \text{LOG}(500\text{KHz}/\text{RBW})$
 2. Data see Attachment B

6. BANDWIDTH MEASUREMENT

6.1 EMISSION BANDWIDTH (EBW) 26 BANDWID PROCEDURES / LIMIT

The following procedure shall be used for measuring 26 bandwidth.

6.1.1 TEST PROCEDURE

1. The testing follows FCC KDB 789033 D02 General UNII Test Procedures New Rules v02r01.
2. Set RBW = approximately 1% of the emission bandwidth.
3. Set the VBW \geq RBW.
4. Detector = Peak.
5. Trace mode = max hold.
6. Measure the maximum width of the emission that is 26 dB down from the peak of the emission. Compare this with the RBW setting of the analyzer. Readjust RBW and repeat measurement as needed until the RBW/EBW ratio is approximately 1%.

6.1.2 DEVIATION FROM STANDARD

No deviation.

6.1.3 TEST SETUP



6.1.4 EUT OPERATION CONDITIONS

The EUT tested system was configured as the statements of 2.4 Unless otherwise a special operating condition is specified in the follows during the testing.



6.1.5 TEST RESULTS

Frequency (MHz)	26dB Bandwidth (MHz)	Pass/Fail
802.11a		
5180	22.82	Pass
5200	23.07	Pass
5240	22.83	Pass
802.11n(HT20)		
5180	23.59	Pass
5200	23.62	Pass
5240	24.08	Pass
802.11n(HT40)		
5190	43.96	Pass
5230	42.73	Pass
802.11ac(VHT20)		
5180	23.54	Pass
5200	23.11	Pass
5240	23.84	Pass
802.11ac(VHT40)		
5190	43.93	Pass
5230	42.89	Pass
802.11ac(VHT80)		
5210	84.18	Pass

Frequency (MHz)	26dB Bandwidth (MHz)	Pass/Fail
802.11a		
5260	23.07	Pass
5300	23.52	Pass
5320	23.70	Pass
802.11n(HT20)		
5260	23.76	Pass
5300	23.63	Pass
5320	23.94	Pass
802.11n(HT40)		
5270	43.00	Pass
5310	42.69	Pass
802.11ac(VHT20)		
5260	23.61	Pass
5300	23.63	Pass
5320	24.02	Pass
802.11ac(VHT40)		
5270	43.19	Pass
5310	42.74	Pass
802.11ac(VHT80)		
5290	87.08	Pass



Frequency (MHz)	26dB Bandwidth (MHz)	Pass/Fail
802.11a		
5500	23.52	Pass
5580	23.55	Pass
5700	23.14	Pass
802.11n(HT20)		
5500	23.94	Pass
5580	22.75	Pass
5700	24.06	Pass
802.11n(HT40)		
5510	44.25	Pass
5550	42.68	Pass
5670	43.61	Pass
802.11ac(VHT20)		
5500	23.16	Pass
5580	23.46	Pass
5700	23.25	Pass
802.11ac(VHT40)		
5510	44.10	Pass
5550	42.66	Pass
5670	44.17	Pass
802.11ac(VHT80)		
5530	85.29	Pass
5610	86.52	Pass

Frequency (MHz)	26dB Bandwidth (MHz)	Pass/Fail
802.11a		
5745	23.15	Pass
5785	23.86	Pass
5825	23.12	Pass
802.11n(HT20)		
5745	23.44	Pass
5785	23.51	Pass
5825	23.30	Pass
802.11n(HT40)		
5755	42.58	Pass
5795	42.78	Pass
802.11ac(VHT20)		
5745	23.61	Pass
5785	23.43	Pass
5825	24.54	Pass
802.11ac(VHT40)		
5755	43.09	Pass
5795	42.71	Pass
802.11ac(VHT80)		
5775	86.43	Pass

Test plot see Attachment C

6.2 OCCUPIED BANDWIDTH (99%) TEST APPLIED PROCEDURES / LIMIT

The following procedure shall be used for measuring (99 %) power bandwidth.

6.2.1 TEST PROCEDURE

1. The testing follows FCC KDB 789033 D02 General UNII Test Procedures v02r01.

The following procedure shall be used for measuring (99 %) power bandwidth:

1. Set center frequency to the nominal EUT channel center frequency.
2. Set span = 1.5 times to 5.0 times the OBW.
3. Set RBW = 1 % to 5 % of the OBW
4. Set VBW $\geq 3 \cdot$ RBW
5. Video averaging is not permitted. Where practical, a sample detection and single sweep mode shall be used. Otherwise, peak detection and max hold mode (until the trace stabilizes) shall be used.
6. Use the 99 % power bandwidth function of the instrument (if available).
7. If the instrument does not have a 99 % power bandwidth function, the trace data points are recovered and directly summed in power units. The recovered amplitude data points, beginning at the lowest frequency, are placed in a running sum until 0.5 % of the total is reached; that frequency is recorded as the lower frequency. The process is repeated until 99.5 % of the total is reached; that frequency is recorded as the upper frequency. The 99% occupied bandwidth is the difference between these two frequencies.

6.2.2 DEVIATION FROM STANDARD

No deviation.

6.2.3 TEST SETUP



6.2.4 EUT OPERATION CONDITIONS

The EUT tested system was configured as the statements of 2.4 Unless otherwise a special operating condition is specified in the follows during the testing.

**6.2.5 TEST RESULTS**

Frequency (MHz)	99% Bandwidth (MHz)	Pass/Fail
802.11a		
5180	16.691	Pass
5200	16.676	Pass
5240	16.678	Pass
802.11n(HT20)		
5180	17.843	Pass
5200	17.837	Pass
5240	17.842	Pass
802.11n(HT40)		
5190	36.393	Pass
5230	36.350	Pass
802.11ac(VHT20)		
5180	17.847	Pass
5200	17.829	Pass
5240	17.818	Pass
802.11ac(VHT40)		
5190	36.366	Pass
5230	36.343	Pass
802.11ac(VHT80)		
5210	75.170	Pass

Frequency (MHz)	99% Bandwidth (MHz)	Pass/Fail
802.11a		
5260	16.962	Pass
5300	16.685	Pass
5320	16.701	Pass
802.11n(HT20)		
5260	17.860	Pass
5300	17.848	Pass
5320	17.836	Pass
802.11n(HT40)		
5270	36.359	Pass
5310	36.324	Pass
802.11ac(VHT20)		
5260	17.851	Pass
5300	17.842	Pass
5320	17.829	Pass
802.11ac(VHT40)		
5270	36.342	Pass
5310	36.328	Pass
802.11ac(VHT80)		
5290	75.221	Pass



Frequency (MHz)	99% Bandwidth (MHz)	Pass/Fail
802.11a		
5500	16.709	Pass
5580	16.673	Pass
5700	16.711	Pass
802.11n(HT20)		
5500	17.810	Pass
5580	17.810	Pass
5700	17.834	Pass
802.11n(HT40)		
5510	36.381	Pass
5550	36.353	Pass
5670	36.379	Pass
802.11ac(VHT20)		
5500	17.849	Pass
5580	17.868	Pass
5700	17.832	Pass
802.11ac(VHT40)		
5510	36.382	Pass
5550	36.339	Pass
5670	36.368	Pass
802.11ac(VHT80)		
5530	75.113	Pass
5610	75.122	Pass

Frequency (MHz)	99% Bandwidth (MHz)	Pass/Fail
802.11a		
5745	16.708	Pass
5785	16.729	Pass
5825	16.723	Pass
802.11n(HT20)		
5745	17.837	Pass
5785	17.848	Pass
5825	17.855	Pass
802.11n(HT40)		
5755	36.336	Pass
5795	36.330	Pass
802.11ac(VHT20)		
5745	17.843	Pass
5785	17.826	Pass
5825	17.877	Pass
802.11ac(VHT40)		
5755	36.360	Pass
5795	36.339	Pass
802.11ac(VHT80)		
5775	75.239	Pass

Test plot See Attachment C

6.3 MINIMUM EMISSION BANDWIDTH(6 DB) PROCEDURES / LIMIT

Section 15.407(e) specifies the minimum 6 dB emission bandwidth of at least 500 KHz for the band 5.725-5.85 GHz. The following procedure shall be used for measuring this bandwidth.

6.3.1 TEST PROCEDURE

1. The testing follows FCC KDB 789033 D02 General UNII Test Procedures v02r01.
 - a) Set RBW = 100 kHz.
 - b) Set the video bandwidth (VBW) $\geq 3 \times$ RBW.
 - c) Detector = Peak.
 - d) Trace mode = max hold.
 - e) Sweep = auto couple.
 - f) Allow the trace to stabilize.
 - g) Measure the maximum width of the emission that is constrained by the frequencies associated with the two outermost amplitude points (upper and lower frequencies) that are attenuated by 6 dB relative to the maximum level measured in the fundamental emission.

6.3.2 DEVIATION FROM STANDARD

No deviation.

6.3.3 TEST SETUP



6.3.4 EUT OPERATION CONDITIONS

The EUT tested system was configured as the statements of 2.4 Unless otherwise a special operating condition is specified in the follows during the testing.

**6.3.5 TEST RESULTS**

Frequency (MHz)	6dB Bandwidth (MHz)	Pass/Fail
802.11a		
5745	16.33	Pass
5785	16.35	Pass
5825	16.36	Pass
802.11n(HT20)		
5745	17.58	Pass
5785	17.58	Pass
5825	17.59	Pass
802.11n(HT40)		
5755	36.37	Pass
5795	36.35	Pass
802.11ac(VHT20)		
5745	17.57	Pass
5785	17.58	Pass
5825	17.58	Pass
802.11ac(VHT40)		
5755	36.35	Pass
5795	36.35	Pass
802.11ac(VHT80)		
5775	75.09	Pass

Test plots see Attachment D

7. MAXIMUM CONDUCTED OUTPUT POWER

7.1 LIMIT

For mobile and portable client devices in the 5.15-5.25 GHz band, the maximum conducted output power over the frequency band of operation shall not exceed 250 mW provided the maximum antenna gain does not exceed 6 dBi. If transmitting antennas of directional gain greater than 6 dBi are used, both the maximum conducted output power and the maximum power spectral density shall be reduced by the amount in dB that the directional gain of the antenna exceeds 6 dBi.

For the 5.25-5.35 GHz and 5.47-5.725 GHz bands, the maximum conducted output power over the frequency bands of operation shall not exceed the lesser of 250 mW or 11 dBm + 10 log B, where B is the 26 dB emission bandwidth in megahertz, If transmitting antennas of directional gain greater than 6 dBi are used.

For the band 5.725-5.85 GHz, the maximum conducted output power over the frequency band of operation shall not exceed 1 W. If transmitting antennas of directional gain greater than 6 dBi are used.

FCC Part15 (15.407) , Subpart E				
Section	Test Item	Limit	Frequency Range (MHz)	Result
15.407(a) (1) (iv)	Peak Output Power	0.25 watt	5150-5250	PASS
		The lesser of 250 mW or 11 dBm + 10 log (26 dB emission bandwidth)	5250-5350 5470-5725	
15.407(a) (3)		1 watt	5725-5825	

7.2 TEST PROCEDURE

The EUT was directly connected to the Power Sensor&PC

7.3 DEVIATION FROM STANDARD

No deviation.

7.4 TEST SETUP

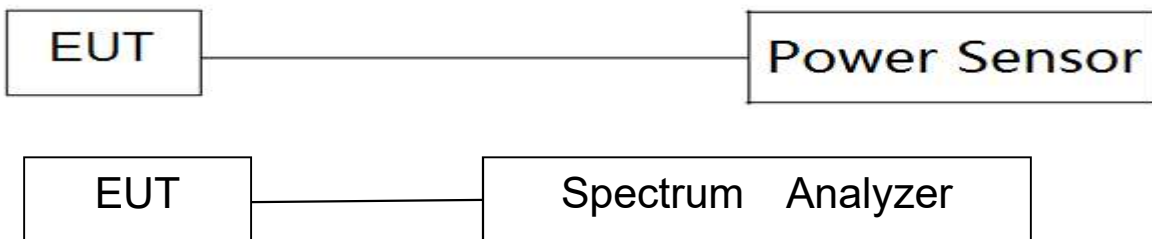

7.5 EUT OPERATION CONDITIONS

The EUT tested system was configured as the statements of 5 Unless otherwise a special operating condition is specified in the follows during the testing.



7.6 TEST RESULTS

Note:

1. For mobile and portable client devices in the 5.15-5.25 GHz band, the maximum conducted output power over the frequency band of operation shall not exceed the lesser of 0.25 W.
2. For mobile and portable client devices in the 5.25-5.35 GHz band, the maximum conducted output power over the frequency band of operation shall not exceed the lesser of 0.25 W.
3. For mobile and portable client devices in the 5.47-5.725 GHz band, the maximum conducted output power over the frequency band of operation shall not exceed the lesser of 0.25 W.
4. For the band 5.745-5.850 GHz, the maximum conducted output power over the frequency band of operation shall not exceed the lesser of 1 W.

Band I (5.15-5.25GHz)												
Test Channel	Frequency (MHz)	Ant_A AV Power (dBm)	Ant_B AV Power (dBm)	Ant_A Duty cycle factor(dB)	Ant_B Duty cycle factor(dB)	Ant_A PK Power (dBm)	Ant_B PK Power (dBm)	Ant_A AV Power (dBm)	Ant_B AV Power (dBm)	AV Power Total(dBm)	PK Power Total(dBm)	LIMIT (dBm)
802.11a												
36	5180	15.46	14.58	0.69	0.69	20.72	19.97	16.15	15.27	--	--	23.98
40	5200	14.98	14.35	0.69	0.69	20.34	19.8	15.67	15.04	--	--	23.98
48	5240	14.75	14.16	0.69	0.69	20.15	19.64	15.44	14.85	--	--	23.98
802.11n(HT20)												
36	5180	14.59	13.58	0.70	0.70	20.12	19.2	15.29	14.28	17.82	22.69	23.98
40	5200	14.16	13.37	0.70	0.70	19.76	18.98	14.86	14.07	17.49	22.40	23.98
48	5240	13.89	13.22	0.70	0.70	19.49	18.76	14.59	13.92	17.28	22.15	23.98
802.11n(HT40)												
38	5190	11.46	10.48	0.70	0.70	16.65	15.65	12.16	11.18	14.71	19.19	23.98
46	5230	11.05	10.09	0.70	0.70	16.72	15.77	11.75	10.79	14.31	19.28	23.98
802.11ac(VHT20)												
36	5180	14.57	13.57	0.70	0.70	20.07	19.08	15.27	14.27	17.81	22.61	23.98
40	5200	14.19	13.32	0.70	0.70	19.79	18.94	14.89	14.02	17.49	22.40	23.98
48	5240	13.88	13.12	0.70	0.70	19.47	18.59	14.58	13.82	17.23	22.06	23.98
802.11ac(VHT40)												
38	5190	11.51	10.44	0.70	0.70	16.6	15.45	12.21	11.14	14.72	19.07	23.98
46	5230	11.1	10.03	0.70	0.70	16.63	15.75	11.80	10.73	14.31	19.22	23.98
802.11ac(VHT80)												
42	5210	8.74	7.33	0.77	0.77	17.78	16.64	9.51	8.10	11.87	20.26	23.98



Band II(5.25-5.35GHz)												
Test Channel	Frequency (MHz)	Ant_A AV Power (dBm)	Ant_B_AV Power (dBm)	Ant_A Duty cycle factor(dB)	Ant_B Duty cycle factor(dB)	Ant_A PK Power (dBm)	Ant_B_PK Power (dBm)	AV Power (dBm)	AV Power B(dBm)	AV Power Total(dBm)	PK Power Total(dBm)	LIMIT (dBm)
802.11a												
52	5260	13.96	13.21	0.69	0.69	19.34	18.83	14.65	13.90	--	--	23.98
60	5300	13.63	13.00	0.69	0.69	19.08	18.51	14.32	13.69	--	--	23.98
64	5320	13.47	12.91	0.69	0.69	19.16	18.47	14.16	13.60	--	--	23.98
802.11n(HT20)												
52	5260	13.88	13.15	0.70	0.70	19.47	18.63	14.58	13.85	17.24	22.08	23.98
60	5300	13.57	12.96	0.70	0.70	19.02	18.5	14.27	13.66	16.98	21.78	23.98
64	5320	13.41	12.91	0.70	0.70	19.01	18.43	14.11	13.61	16.88	21.74	23.98
802.11n(HT40)												
54	5270	12.73	12.08	0.70	0.70	18.64	17.96	13.43	12.78	16.13	21.32	23.98
62	5310	12.45	11.92	0.70	0.70	18.57	17.66	13.15	12.62	15.90	21.15	23.98
802.11ac(VHT20)												
52	5260	13.83	13.18	0.70	0.70	19.33	18.78	14.53	13.88	17.23	22.07	23.98
60	5300	13.62	12.96	0.70	0.70	19.12	18.54	14.32	13.66	17.01	21.85	23.98
64	5320	13.41	12.91	0.70	0.70	19.13	18.54	14.11	13.61	16.88	21.86	23.98
802.11ac(VHT40)												
54	5270	12.72	12.09	0.73	0.73	18.64	17.85	13.45	12.82	16.16	21.27	23.98
62	5310	12.32	11.91	0.73	0.73	18.51	17.82	13.05	12.64	15.86	21.19	23.98
802.11ac(VHT80)												
58	5290	7.59	7.55	0.73	0.73	17.15	16.65	8.32	8.28	11.31	19.92	23.98



Band III(5.47-5.725GHz)												
Test Channel	Frequency (MHz)	Ant_A AV Power (dBm)	Ant_B_AV Power (dBm)	Ant_A Duty cycle factor(dB)	Ant_B Duty cycle factor(dB)	Ant_A PK Power (dBm)	Ant_B_PK Power (dBm)	AV Power (dBm)	AV Power B(dBm)	AV Power Total(dBm)	PK Power Total(dBm)	LIMIT (dBm)
802.11a												
100	5500	16.75	15.91	0.69	0.69	22.01	21.27	17.44	16.60	--	--	23.98
116	5580	17.30	16.17	0.69	0.69	22.56	21.44	17.99	16.86	--	--	23.98
140	5700	16.83	15.56	0.69	0.69	22.01	20.63	17.52	16.25	--	--	23.98
802.11n(HT20)												
100	5500	14.50	13.78	0.70	0.70	19.01	19.26	15.20	14.48	17.86	22.15	23.98
116	5580	15.17	13.99	0.70	0.70	20.04	19.57	15.87	14.69	18.33	22.82	23.98
140	5700	14.89	13.28	0.70	0.70	20.33	18.72	15.59	13.98	17.87	22.61	23.98
802.11n(HT40)												
102	5510	13.66	12.70	0.71	0.71	18.86	17.92	14.37	13.41	16.93	21.43	23.98
110	5550	13.85	12.81	0.71	0.71	19.73	18.75	14.56	13.52	17.08	22.28	23.98
134	5670	13.81	12.27	0.71	0.71	19.13	17.34	14.52	12.98	16.83	21.34	23.98
802.11ac(VHT20)												
100	5500	14.68	13.70	0.70	0.70	20.19	19.14	15.38	14.40	17.93	22.71	23.98
116	5580	15.31	13.94	0.70	0.70	20.82	19.53	16.01	14.64	18.39	23.23	23.98
140	5700	14.88	13.30	0.70	0.70	20.21	18.71	15.58	14.00	17.87	22.53	23.98
802.11ac(VHT40)												
102	5510	13.59	12.71	0.72	0.72	18.86	17.7	14.31	13.43	16.90	21.33	23.98
110	5550	13.85	12.83	0.72	0.72	19.69	18.89	14.57	13.55	17.10	22.32	23.98
134	5670	13.90	12.26	0.72	0.72	19	17.54	14.62	12.98	16.88	21.34	23.98
802.11ac(VHT80)												
106	5530	8.00	7.88	0.77	0.77	17.41	17.03	8.77	8.65	11.72	20.23	23.98
122	5610	7.70	7.66	0.77	0.77	17.19	16.7	8.47	8.43	11.46	19.96	23.98



Band IV (5.725-5.85GHz)												
Test Channel	Frequency (MHz)	Ant_A AV Power (dBm)	Ant_B_AV Power (dBm)	Ant_A Duty cycle factor(dB)	Ant_B Duty cycle factor(dB)	Ant_A PK Power (dBm)	Ant_B_PK Power (dBm)	AV Power (dBm)	AV Power B(dBm)	AV Power Total(dBm)	PK Power Total(dBm)	LIMIT (dBm)
802.11a												
149	5745	14.51	13.13	0.70	0.70	19.71	18.33	15.21	13.83	--	--	30
157	5785	14.41	13.58	0.70	0.70	19.6	18.84	15.11	14.28	--	--	30
165	5825	14.23	13.50	0.70	0.70	19.33	18.77	14.93	14.20	--	--	30
802.11n(HT20)												
149	5745	11.48	9.90	0.70	0.70	16.85	15.37	12.18	10.60	14.470	19.18	30
157	5785	11.32	10.33	0.70	0.70	16.85	15.8	12.02	11.03	14.562	19.37	30
165	5825	11.00	10.26	0.70	0.70	16.59	15.71	11.70	10.96	14.354	19.18	30
802.11n(HT40)												
151	5755	11.32	10.00	0.70	0.70	17.17	15.78	12.02	10.70	14.419	19.54	30
159	5795	11.09	10.27	0.70	0.70	17.1	16.2	11.79	10.97	14.409	19.68	30
802.11ac(VHT20)												
149	5745	11.45	9.89	0.70	0.70	16.89	15.32	12.15	10.59	14.451	19.19	30
157	5785	11.34	10.10	0.70	0.70	16.71	15.77	12.04	10.80	14.476	19.28	30
165	5825	11.11	10.25	0.70	0.70	16.52	15.67	11.81	10.95	14.413	19.13	30
802.11ac(VHT40)												
151	5755	11.29	9.96	0.72	0.72	17.19	16.03	12.01	10.68	14.405	19.66	30
159	5795	11.22	10.33	0.72	0.72	17.07	16.09	11.94	11.05	14.527	19.62	30
802.11ac(VHT80)												
155	5775	6.53	6.51	0.76	0.76	16.07	15.69	7.29	7.27	10.294	18.89	30

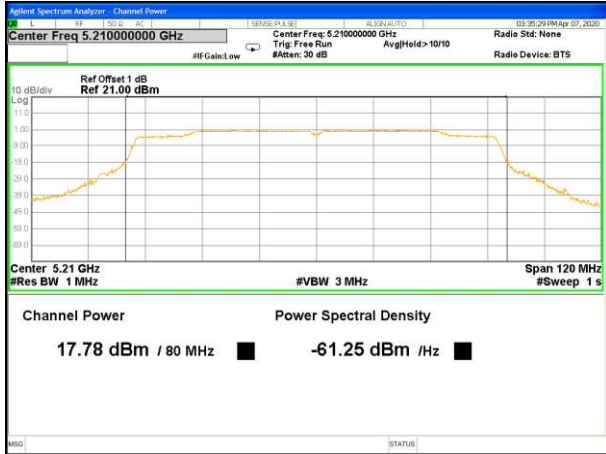

5210MHz PK Ant A

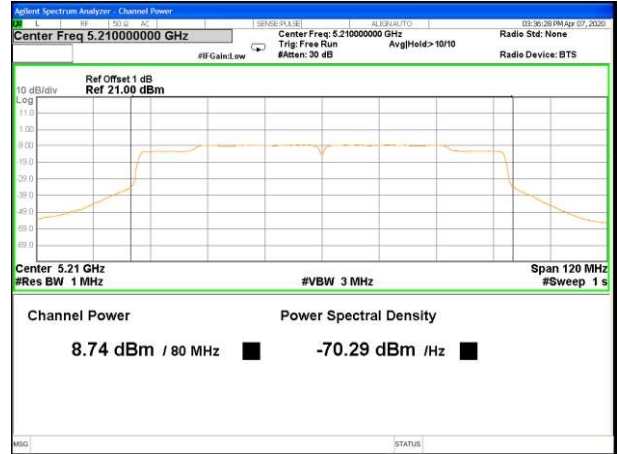

5210MHz AV Ant A

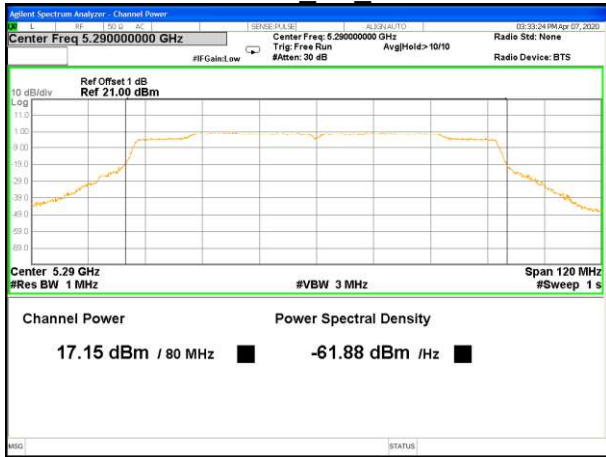

5290MHz PK Ant A

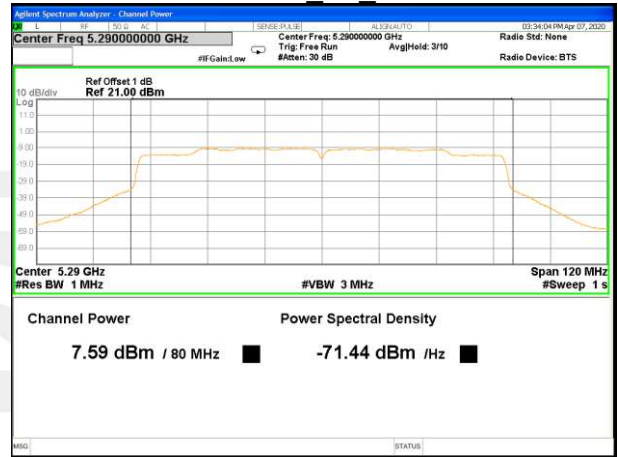

5290MHz AV Ant A

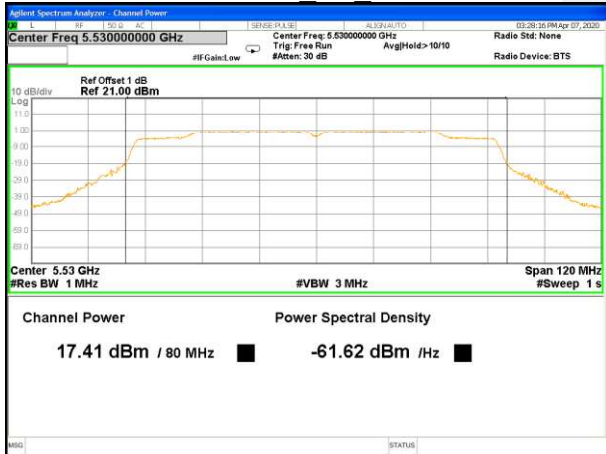

5530MHz_PK_Ant A

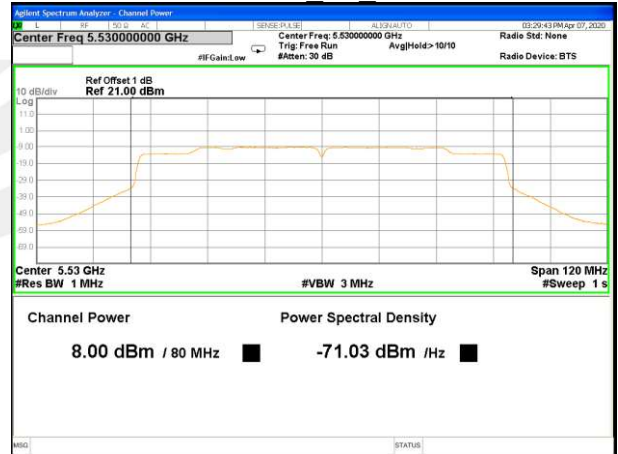

5530MHz_AV_Ant A

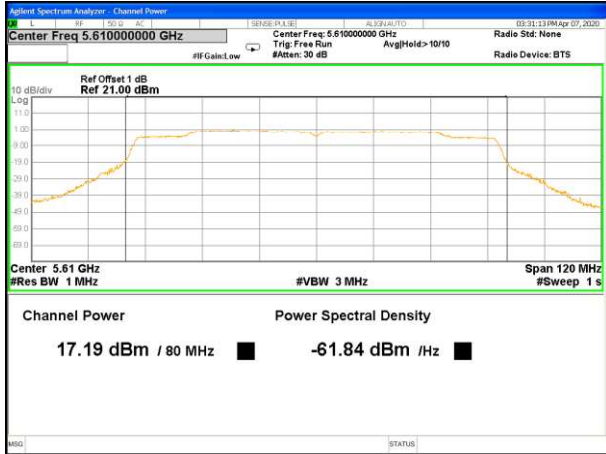

5610MHz PK Ant A

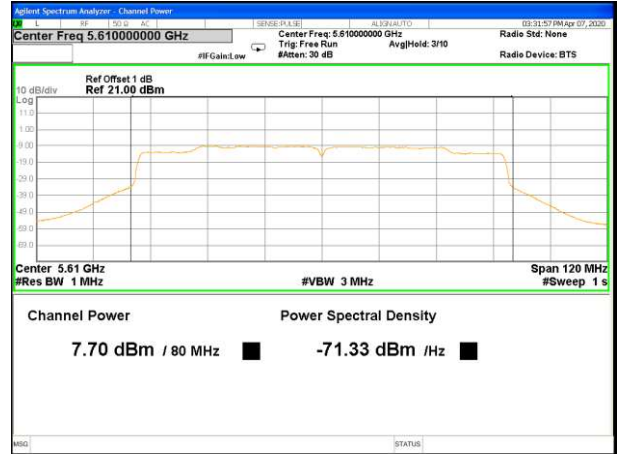

5610MHz AV Ant A

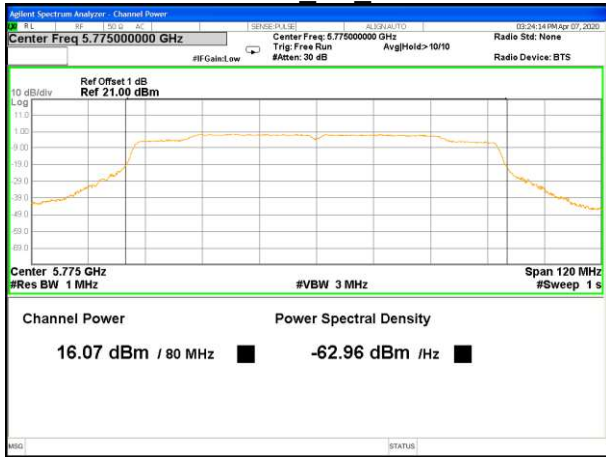

5775MHz PK Ant A

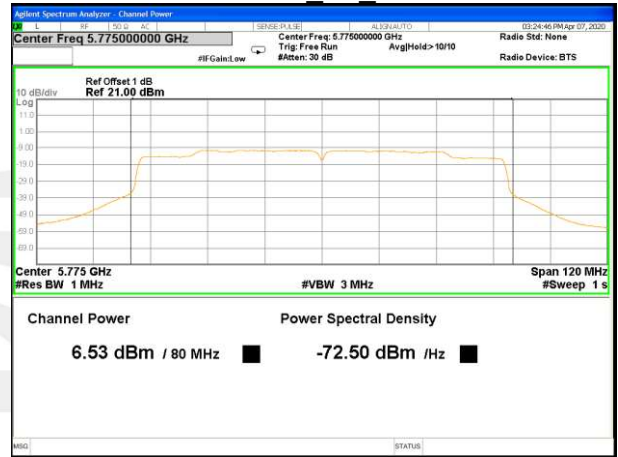

5775MHz AV Ant A

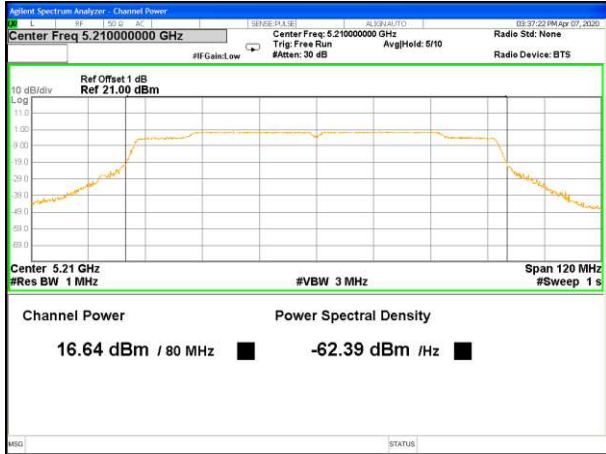

5210MHz PK Ant B

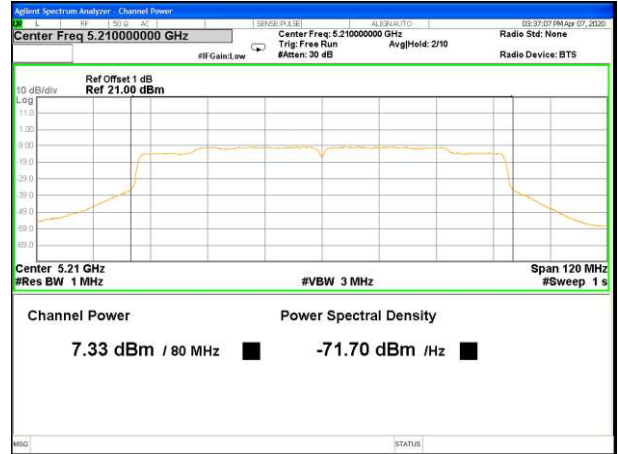

5210MHz AV Ant B

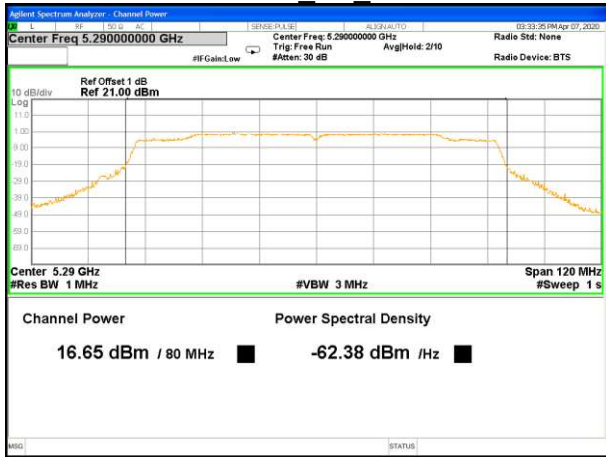

5290MHz PK Ant B

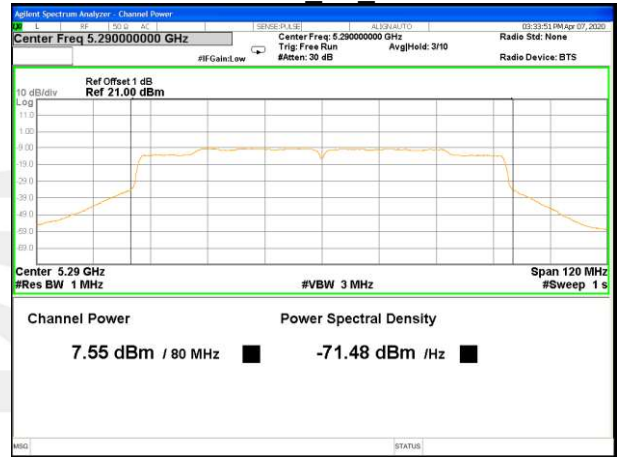

5290MHz AV Ant B

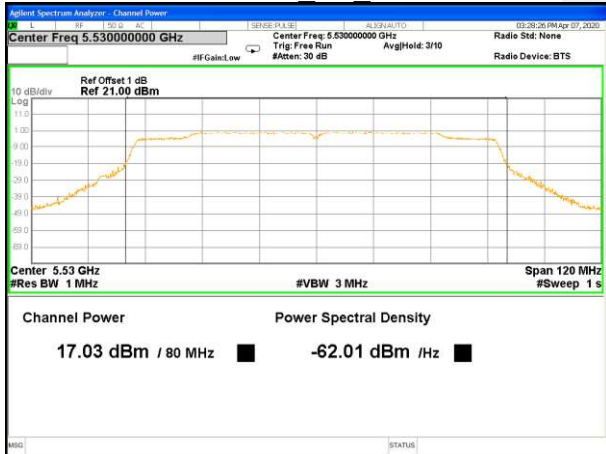

5530MHz PK Ant B

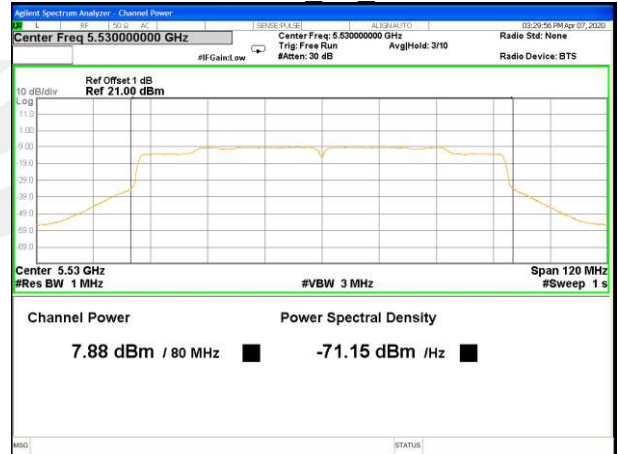

5530MHz AV Ant B

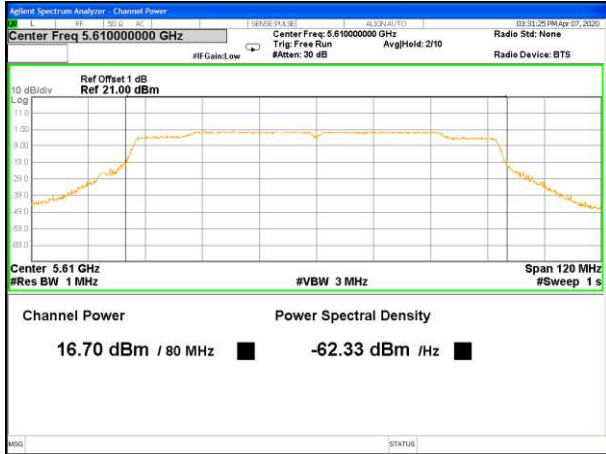

5610MHz_PK_Ant B

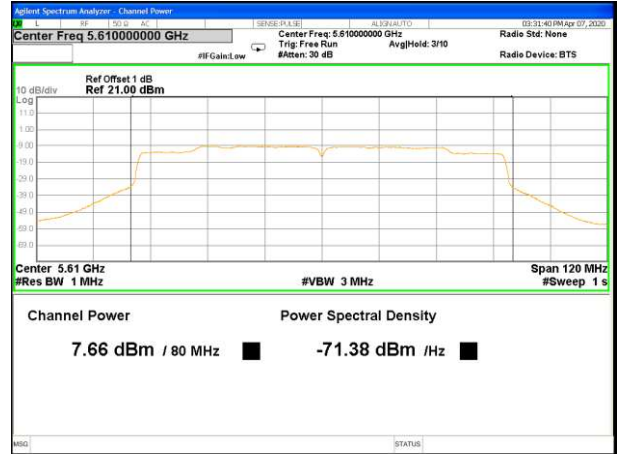

5610MHz_AV_Ant B

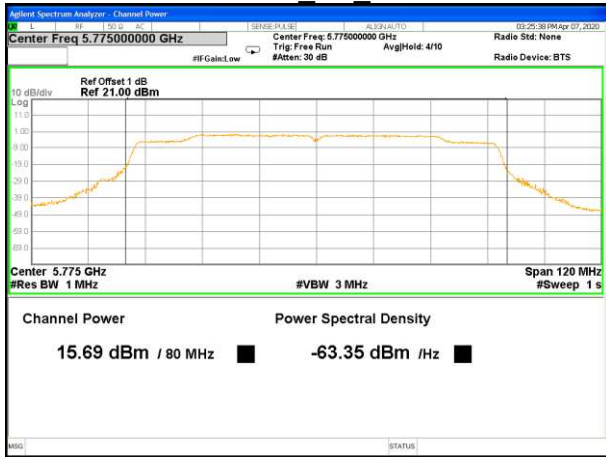

5775MHz_PK_Ant B

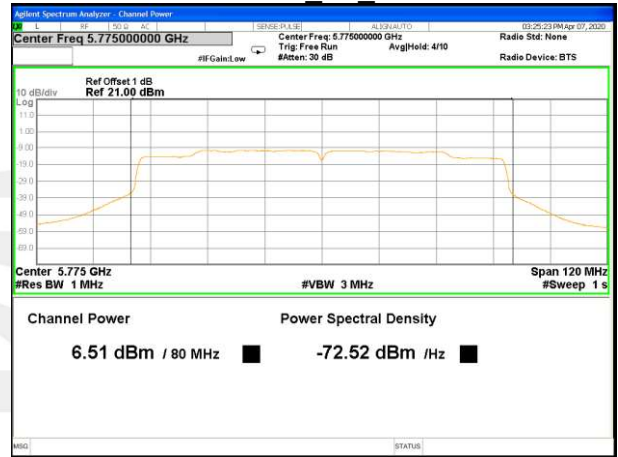

5775MHz_AV_Ant B



Duty cycle

Band 1				
Mode	Ton(ms)	Tp(ms)	Duty cycle(%)	Duty factor(dB)
a	2.060	2.415	85.30%	0.69
n20	1.920	2.255	85.14%	0.70
n40	0.945	1.110	85.14%	0.70
ac20	0.993	1.167	85.09%	0.70
ac40	0.504	0.592	85.14%	0.70
ac80	0.259	0.309	83.82%	0.77
Band 2				
Mode	Ton(ms)	Tp(ms)	Duty cycle(%)	Duty factor(dB)
a	2.060	2.415	85.30%	0.69
n20	1.920	2.255	85.14%	0.70
n40	0.945	1.110	85.14%	0.70
ac20	0.993	1.167	85.09%	0.70
ac40	0.500	0.592	84.46%	0.73
ac80	0.262	0.310	84.52%	0.73
Band 3				
Mode	Ton(ms)	Tp(ms)	Duty cycle(%)	Duty factor(dB)
a	2.060	2.415	85.30%	0.69
n20	1.920	2.255	85.14%	0.70
n40	0.942	1.110	84.86%	0.71
ac20	0.993	1.167	85.09%	0.70
ac40	0.502	0.592	84.80%	0.72
ac80	0.259	0.309	83.82%	0.77
Band 4				
Mode	Ton(ms)	Tp(ms)	Duty cycle(%)	Duty factor(dB)
a	2.060	2.420	85.12%	0.70
n20	1.920	2.255	85.14%	0.70
n40	0.945	1.110	85.14%	0.70
ac20	0.993	1.167	85.09%	0.70
ac40	0.500	0.590	84.75%	0.72
ac80	0.260	0.310	83.87%	0.76

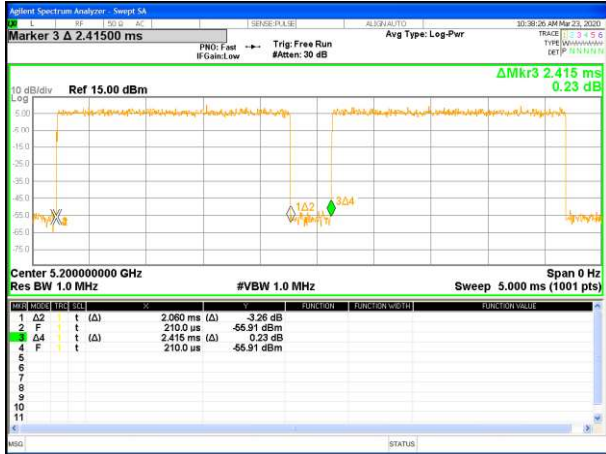

Band 1-a20-Ant A

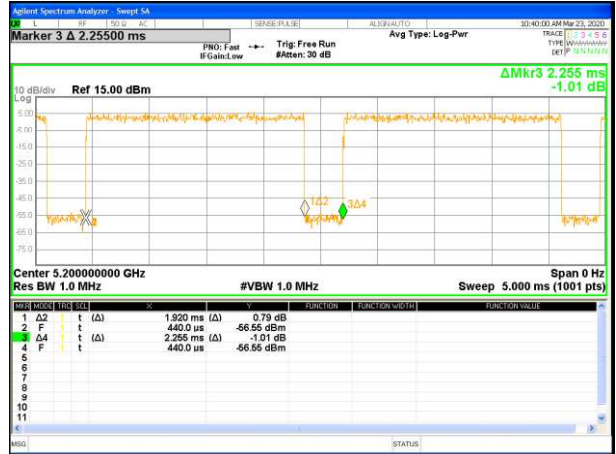

Band 1-n20-Ant A

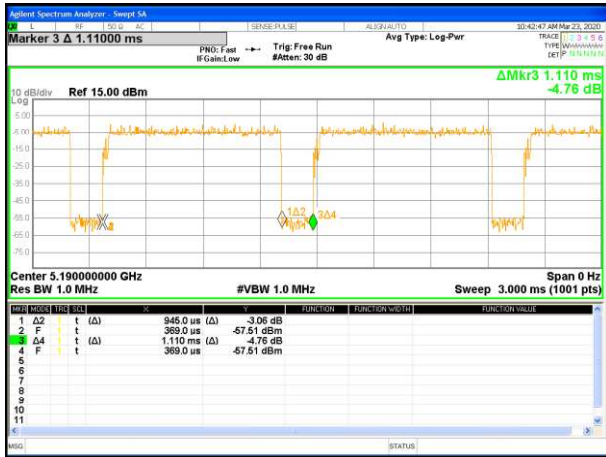

Band 1-n40-Ant A



Band 1-ac20-Ant A



Band 1-ac40-Ant A



Band 1-ac80-Ant A



Band 2-a20-Ant A



Band 2-n20-Ant A



Band 2-n40-Ant A



Band 2-ac20-Ant A



Band 2-ac40-Ant A



Band 2-ac80-Ant A



Band 3-a20-Ant A

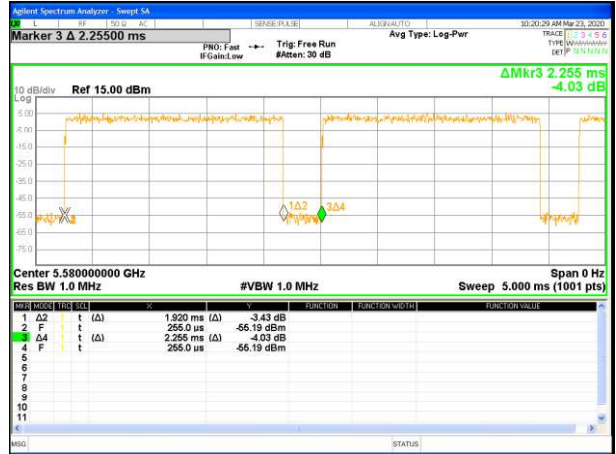

Band 3-n20-Ant A



Band 3-n40-Ant A



Band 3-ac20-Ant A



Band 3-ac40-Ant A



Band 3-ac80-Ant A

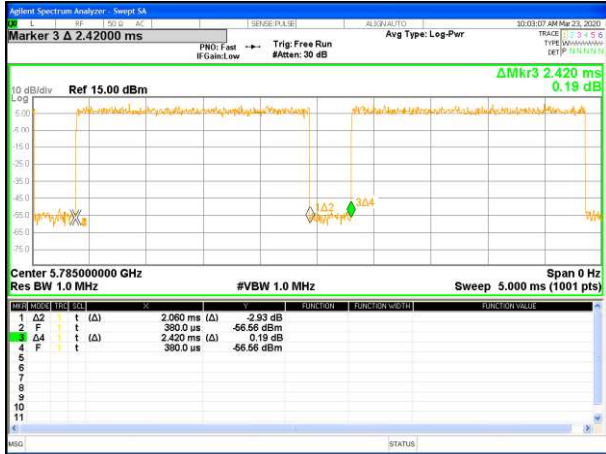

Band 4-a20-Ant A



Band 4-n20-Ant A



Band 4-n40-Ant A



Band 1-a20-Ant B



Band 4-ac20-Ant A



Band 1-n20-Ant B



Band 4-ac40-Ant A



Band 1-n40-Ant B



Band 4-ac80-Ant A



Band 1-ac20-Ant B



Band 1-ac40-Ant B



Band 1-ac80-Ant B



Band 2-a20-Ant B



Band 2-n20-Ant B



Band 2-n40-Ant B



Band 2-ac20-Ant B



Band 2-ac40-Ant B



Band 2-ac80-Ant B



Band 3-a20-Ant B



Band 3-n20-Ant B



Band 3-n40-Ant B



Band 3-ac20-Ant B



Band 3-ac40-Ant B



Band 3-ac80-Ant B



Band 4-a20-Ant B



Band 4-n20-Ant B

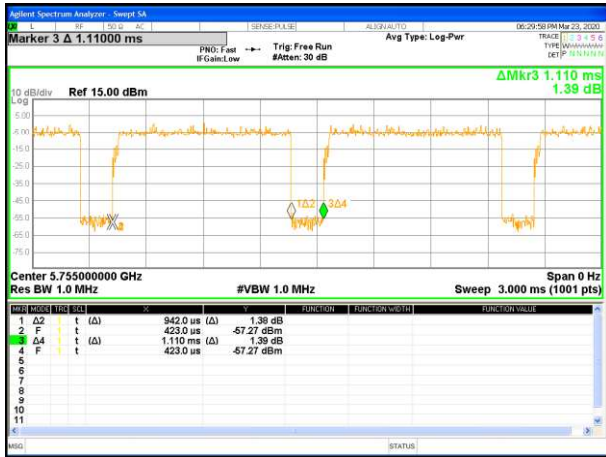

Band 4-n40-Ant B



Band 4-ac20-Ant B



Band 4-ac40-Ant B



Band 4-ac80-Ant B



8. AUTOMATICALLY DISCONTINUE TRANSMISSION

8.1 LIMIT OF AUTOMATICALLY DISCONTINUE TRANSMISSION

The device shall automatically discontinue transmission in case of either absence of information to transmit or operational failure. These provisions are not intended to preclude the transmission of control or signaling information or the use of repetitive codes used by certain digital technologies to complete frame or burst intervals. Applicants shall include in their application for equipment authorization to describe how this requirement is met.

8.2 TEST RESULT OF AUTOMATICALLY DISCONTINUE TRANSMISSION

During no any information transmission, the EUT can automatically discontinue transmission and become standby mode for power saving. The EUT can detect the controlling signal of ACK message transmitting from remote device and verify whether it shall resend or discontinue transmission





9. ANTENNA REQUIREMENT

9.1 STANDARD REQUIREMENT

15.203 requirement: For intentional device, according to 15.203: an intentional radiator shall be designed to ensure that no antenna other than that furnished by the responsible party shall be used with the device.

9.2 EUT ANTENNA

The EUT antenna is PIFA Antenna Antenna. It comply with the standard requirement.





APPENDIX - PHOTOS OF TEST SETUP

Note: See test photos in setup photo document for the actual connections between Product and support equipment.

※※※※END OF THE REPORT※※※※

