



RADIO TEST REPORT

Report No.: STS2201219W04

Issued for

Winmate Inc.

9F, No.111-6 , Shing-De Rd., San-Chung Dist., New Taipei
City 24158, Taiwan, R.O.C

Product Name:	Rugged Laptop
Brand Name:	Winmate
Model Name:	L140TG
Series Model:	L140XXXXXXXXXXXX("XXXXXXXXXXXX X"= A~Z,a~z,0~9,"-" Blank or Slash)
FCC ID:	PX9L140TG
Test Standard:	FCC Part 15.247

Any reproduction of this document must be done in full. No single part of this document may be reproduced without permission from STS, all test data presented in this report is only applicable to presented test sample.





TEST RESULT CERTIFICATION

Applicant's Name: Winmate Inc.
Address: 9F, No.111-6 , Shing-De Rd., San-Chung Dist., New Taipei City
24158, Taiwan, R.O.C

Manufacturer's Name.....: Winmate Inc.
Address: 9F, No.111-6 , Shing-De Rd., San-Chung Dist., New Taipei City
24158, Taiwan, R.O.C

Product Description

Product Name: Rugged Laptop
Brand Name.....: Winmate
Model Name: L140TG
Series Model.....: L140XXXXXXXXXXXX ("XXXXXXXXXXXX"= A~Z,a~z,0~9,"-" Blank
or Slash)

Test Standards: FCC Part 15.247

Test Procedure.....: ANSI C63.10-2013

This device described above has been tested by STS, the test results show that the equipment under test (EUT) is in compliance with the FCC requirements. And it is applicable only to the tested sample identified in the report.

This report shall not be reproduced except in full, without the written approval of STS, this document only be altered or revised by STS, personal only, and shall be noted in the revision of the document.

Date of Test

Date of receipt of test item.....: 26 Feb. 2022
Date (s) of performance of tests: 26 Feb. 2022 ~ 04 Mar. 2022
Date of Issue: 04 Mar. 2022
Test Result.....: **Pass**

Testing Engineer : *Chris Chen*

(Chris Chen)

Technical Manager : *Sean She*

(Sean she)

Authorized Signatory : *Vita Li*

(Vita Li)



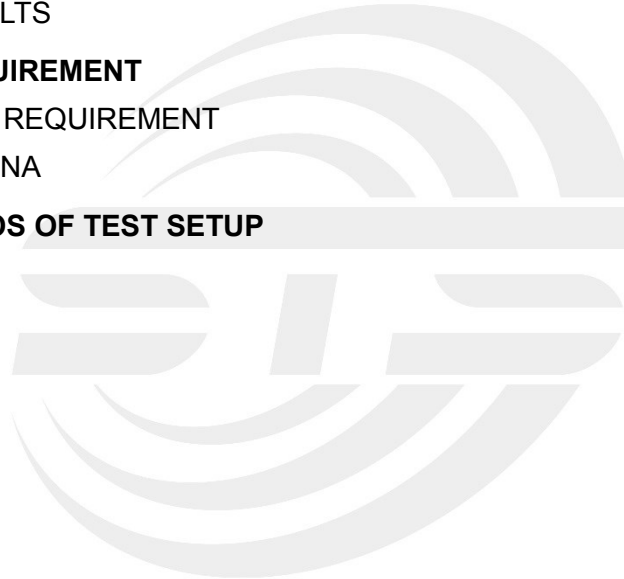

Table of Contents

	Page
1. SUMMARY OF TEST RESULTS	6
1.1 TEST FACTORY	7
1.2 MEASUREMENT UNCERTAINTY	7
2. GENERAL INFORMATION	8
2.1 GENERAL DESCRIPTION OF THE EUT	8
2.2 DESCRIPTION OF THE TEST MODES	10
2.3 TEST SOFTWARE AND POWER LEVEL	11
2.4 BLOCK DIAGRAM SHOWING THE CONFIGURATION OF SYSTEM TESTED	11
2.5 DESCRIPTION OF NECESSARY ACCESSORIES AND SUPPORT UNITS	12
2.6 EQUIPMENTS LIST FOR ALL TEST ITEMS	13
3. EMC EMISSION TEST	15
3.1 CONDUCTED EMISSION MEASUREMENT	15
3.2 RADIATED EMISSION MEASUREMENT	19
4. CONDUCTED SPURIOUS & BAND EDGE EMISSION	33
4.1 LIMIT	33
4.2 TEST PROCEDURE	33
4.3 DEVIATION FROM STANDARD	33
4.4 TEST SETUP	33
4.5 EUT OPERATION CONDITIONS	33
4.6 TEST RESULTS	34
5. POWER SPECTRAL DENSITY TEST	50
5.1 LIMIT	50
5.2 TEST PROCEDURE	50
5.3 DEVIATION FROM STANDARD	50
5.4 TEST SETUP	50
5.5 EUT OPERATION CONDITIONS	50
5.6 TEST RESULTS	51
6. BANDWIDTH TEST	64
6.1 LIMIT	64
FCC PART15.247,SUBPART C	64
6.2 TEST PROCEDURE	64
6.3 DEVIATION FROM STANDARD	64
6.4 TEST SETUP	64

**Table of Contents**

	Page
6.5 EUT OPERATION CONDITIONS	64
6.6 TEST RESULTS	65
7. PEAK OUTPUT POWER TEST	72
7.1 LIMIT	72
FCC PART15.247,SUBPART C	72
7.2 TEST PROCEDURE	72
7.3 DEVIATION FROM STANDARD	72
7.4 TEST SETUP	72
7.5 EUT OPERATION CONDITIONS	72
7.6 TEST RESULTS	73
8. ANTENNA REQUIREMENT	77
8.1 STANDARD REQUIREMENT	77
8.2 EUT ANTENNA	77
APPENDIX-PHOTOS OF TEST SETUP	78





Revision History

Rev.	Issue Date	Report No.	Effect Page	Contents
00	04 Mar. 2022	STS2201219W04	ALL	Initial Issue





1. SUMMARY OF TEST RESULTS

Test procedures according to the technical standards:
KDB 558074 D01 15.247 Meas Guidance v05r02.

FCC Part 15.247, Subpart C			
Standard Section	Test Item	Judgment	Remark
15.207	Conducted Emission	PASS	--
15.247 (a)(2)	6dB Bandwidth	PASS	--
15.247 (b)(3)	Output Power	PASS	--
15.209	Radiated Spurious Emission	PASS	--
15.247 (d)	Conducted Spurious & Band Edge Emission	PASS	--
15.247 (e)	Power Spectral Density	PASS	--
15.205	Restricted Band Edge Emission	PASS	--
Part 15.247(d)/ part 15.209(a)	Band Edge Emission	PASS	--
15.203	Antenna Requirement	PASS	--

NOTE:

- (1) 'N/A' denotes test is not applicable in this Test Report.
- (2) All tests are according to ANSI C63.10-2013.



1.1 TEST FACTORY

SHENZHEN STS TEST SERVICES CO., LTD

Add. : A 1/F, Building B, Zhuoke Science Park, No.190 Chongqing Road, HepingShequ, Fuyong Sub-District, Bao'an District, Shenzhen, Guang Dong, China

FCC test Firm Registration Number: 625569

IC test Firm Registration Number: 12108A

A2LA Certificate No.: 4338.01

1.2 MEASUREMENT UNCERTAINTY

The reported uncertainty of measurement $y \pm U$, where expanded uncertainty U is based on a standard uncertainty multiplied by a coverage factor of $k=2$, providing a level of confidence of approximately 95 %.

No.	Item	Uncertainty
1	RF output power, conducted	$\pm 0.87\text{dB}$
2	Unwanted Emissions, conducted	$\pm 2.895\text{dB}$
3	All emissions, radiated 9K-30MHz	$\pm 3.80\text{dB}$
4	All emissions, radiated 30M-1GHz	$\pm 4.09\text{dB}$
5	All emissions, radiated 1G-6GHz	$\pm 4.92\text{dB}$
6	All emissions, radiated >6G	$\pm 5.49\text{dB}$
7	Conducted Emission (9KHz-30MHz)	$\pm 2.73\text{dB}$



2. GENERAL INFORMATION

2.1 GENERAL DESCRIPTION OF THE EUT

Product Name	Rugged Laptop	
Trade Name	Winmate	
Model Name	L140TG	
Series Model	L140XXXXXXXXXXXX ("XXXXXXXXXXXX"= A~Z,a~z,0~9,"-" Blank or Slash)	
Model Difference	The circuit principle is the same and does not affect electromagnetic compatibility and safety-related structures or key components, and the model difference is only for marketing purposes	
Product Description	The EUT is a Rugged Laptop	
	Operation Frequency:	802.11b/g/n 20: 2412~2462 MHz 802.11n(40MHz):2422~2452MHz
	Modulation Type:	802.11b(DSSS):CCK,DQPSK,DBPSK 802.11g(OFDM):BPSK,QPSK,16-QAM,64-QAM 802.11n(OFDM):BPSK,QPSK,16-QAM,64-QAM
	Number of Channel:	802.11b/g/n20: 11CH 802.11n 40: 7CH
	Antenna Designation:	PIFA
	Antenna Gain(dBi):	Antenna number: 2Antenna A gain : 0.8dBiAntenna B gain : 0.8dBiMIMO technology Directional gain=3.81dBi Please refer to the Note 3.
Channel List	Please refer to the Note 2.	
Adapter	Input: 100-240V~1.7A 50-60Hz Output: 19V 3.42A 65W	
Battery	Rated Voltage: DC 10.8V Charge Limit Voltage:12.6V Capacity: 2400mAh	
Hardware version number	L133TG	
Software versionnumber	N/A	
Connecting I/O Port(s)	Please refer to the Note 1.	

802.11b/g : SISO mode only, 802.11n H20 /H40: MIMO mode only.

Note:

1. For a more detailed features description, please refer to the manufacturer's specifications or the User Manual.



2.

Operation Frequency of channel			
802.11b/g/n(20MHz)		Channel List for 802.11n(40MHz)	
Channel	Frequency	Channel	Frequency
01	2412	03	2422
02	2417	04	2427
03	2422	05	2432
04	2427	06	2437
05	2432	07	2442
06	2437	08	2447
07	2442	09	2452
08	2447		
09	2452		
10	2457		
11	2462		

Note:

In section 15.31(m), regards to the operating frequency range over 10 MHz, the Lowest frequency, the middle frequency, and the highest frequency of channel were selected to perform the test, and the selected channel see below:

Carrier Frequency Channel

2.4GHz Test Frequency:

For 802.11b/g/n (HT20)		For 802.11n (HT40)	
Channel	Freq.(MHz)	Channel	Freq.(MHz)
01	2412	03	2422
06	2437	06	2437
11	2462	09	2452

3. KDB 662911 D01 Multiple Transmitter Output v02r01

2) Directional Gain Calculations for In-Band Measurements

a) Basic methodology with NANT transmit antennas, each with the same directional gain GANT dBi, being driven by NANT transmitter outputs of equal power. Directional gain is to be computed as follows:

(i) If any transmit signals are correlated with each other,

$$\text{Directional gain} = GANT + 10 \log(NANT) \text{ dBi}$$

(ii) If all transmit signals are completely uncorrelated with each other,

$$\text{Directional gain} = GANT$$

Antenna number: 2 Antenna A gain : 0.8dBi Antenna B gain : 0.8dBi MIMO technology

Directional gain=3.81dBi

$$GANT + 10 \log(NANT) \text{ dBi}$$

{ Directional gain}dBi

Note: The antenna information refer the manufacturer provide report, applicable only to the tested sample identified in the report.



2.2 DESCRIPTION OF THE TEST MODES

Each of these EUT operation mode(s) or test configuration mode(s) mentioned above was evaluated respectively.

Worst Mode	Description	Data Rate
Mode 1	TX IEEE 802.11b CH1	1 Mbps
Mode 2	TX IEEE 802.11b CH6	1 Mbps
Mode 3	TX IEEE 802.11 b CH11	1 Mbps
Mode 4	SISO mode	1 Mbps
Mode 5	TX IEEE 802.11g CH1	6 Mbps
Mode 6	TX IEEE 802.11g CH6	6 Mbps
Mode 7	TX IEEE 802.11g CH11	6 Mbps
Mode 8	SISO mode	6 Mbps
Mode 9	TX IEEE 802.11n HT20 CH1	MCS 0
Mode 10	TX IEEE 802.11n HT20 CH6	MCS 0
Mode 11	TX IEEE 802.11n HT20 CH11	MCS 0
Mode 12	keeping MIMO TX mode	MCS 0
Mode 13	TX IEEE 802.11n HT40 CH3	MCS 0
Mode 14	TX IEEE 802.11n HT40 CH6	MCS 0
Mode 15	TX IEEE 802.11n HT40 CH9	MCS 0
Mode 16	keeping MIMO TX mode	MCS 0

Note:

- (1) The measurements are performed at all Bit Rate of Transmitter, the worst data was reported.
- (2) We have be tested for all avaiable U.S. voltage and frequencies(For 120V,50/60Hz and 240V, 50/60Hz) for which the device is capable of operation, and the worst case of 120V /60Hz is shown in the report.
- (3) The battery is fully-charged during the radited and RF conducted test.

AC Conducted Emission

Test Case	
AC Conducted Emission	Mode17: Keeping TX + WLAN Link

2.3 TEST SOFTWARE AND POWER LEVEL

During testing channel & power controlling software provided by the customer was used to control the operating channel as well as the output power level.

RF Function	Type	Mode Or Modulation type	ANT Gain(dBi)	ANT_A Power Class	ANT_B Power Class	Software For Testing
WIFI(2.4G)	2.4G WIFI	802.11b	ANT A: 0.8 ANT B: 0.8 MIMO A+B: 3.81	10	10	DRTU
		802.11g		10	10	
		802.11n(HT20)		10	10	
		802.11n(HT40)		10	10	

2.4 BLOCK DIAGRAM SHOWING THE CONFIGURATION OF SYSTEM TESTED

Radiation Test Set



Conduction Test Set

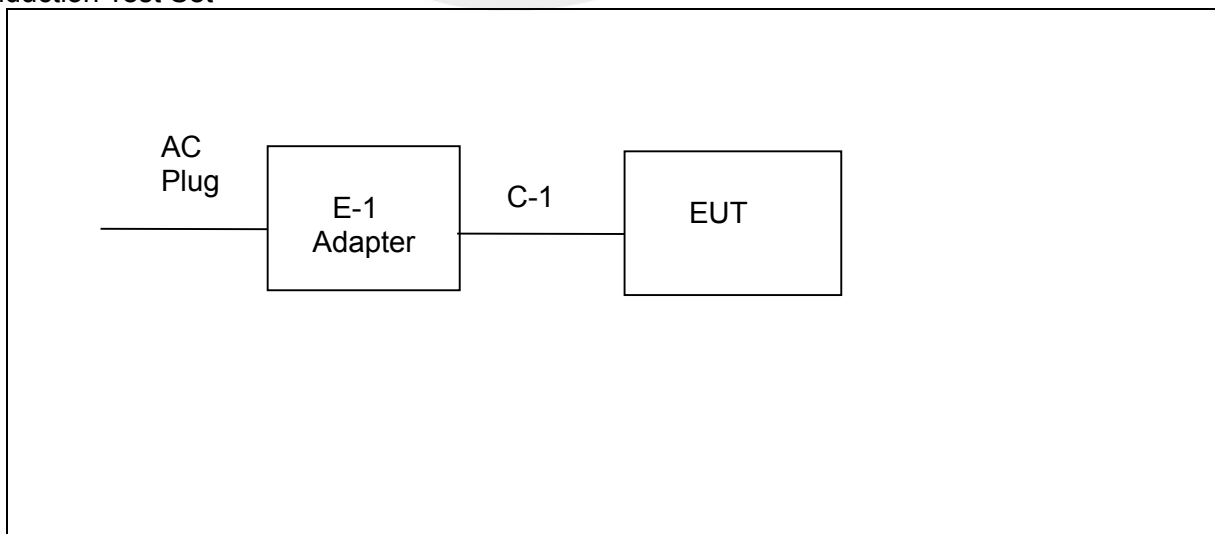



2.5 DESCRIPTION OF NECESSARY ACCESSORIES AND SUPPORT UNITS

The EUT has been tested as an independent unit together with other necessary accessories or support units. The following support units or accessories were used to form a representative test configuration during the tests.

Necessary accessories

Item	Equipment	Mfr/Brand	Model/Type No.	Length	Note
E-1	Adapter	Chiicony	A18-065N3A	N/A	N/A
C-1	DC Cbale	N/A	N/A	175cm	YES

Support units

Item	Equipment	Mfr/Brand	Model/Type No.	Length	Note
N/A	N/A	N/A	N/A	N/A	N/A

Note:

- (1) For detachable type I/O cable should be specified the length in cm in 『Length』 column.
- (2) “YES” is means “with core”; “NO” is means “without core”.



2.6 EQUIPMENTS LIST FOR ALL TEST ITEMS

Radiation Test equipment

Kind of Equipment	Manufacturer	Type No.	Serial No.	Last calibration	Calibrated until
Test Receiver	R&S	ESCI	101427	2021.09.30	2022.09.29
Signal Analyzer	R&S	FSV 40-N	101823	2021.09.30	2022.09.29
Active loop Antenna	ZHINAN	ZN30900C	16035	2021.04.11	2023.04.10
Bilog Antenna	TESEQ	CBL6111D	34678	2020.10.12	2022.10.11
Horn Antenna	SCHWARZBECK	BBHA 9120D	02014	2021.10.11	2023.10.10
SHF-EHF Horn Antenna (18G-40GHz)	A-INFO	LB-180400-KF	J211020657	2020.10.12	2022.10.11
Pre-Amplifier (0.1M-3GHz)	EM	EM330	060665	2021.10.08	2022.10.07
Pre-Amplifier (1G-18GHz)	SKET	LNPA-01018G-45	SK2018080901	2021.09.30	2022.09.29
Pre-Amplifier (18G-40GHz)	SKET	LNPA-1840-50	SK2018101801	2021.09.28	2022.09.27
Temperature & Humidity	HH660	Mieo	N/A	2021.10.09	2022.10.08
Turn table	EM	SC100_1	60531	N/A	N/A
Antenna mast	EM	SC100	N/A	N/A	N/A
Test SW	FARAD	EZ-EMC(Ver.STSLAB-03A1 RE)			

Conduction Test equipment

Kind of Equipment	Manufacturer	Type No.	Serial No.	Last calibration	Calibrated until
Test Receiver	R&S	ESCI	101427	2021.09.30	2022.09.29
LISN	R&S	ENV216	101242	2021.09.30	2022.09.29
LISN	EMCO	3810/2NM	23625	2021.09.30	2022.09.29
Temperature & Humidity	HH660	Mieo	N/A	2021.10.09	2022.10.08
Test SW	FARAD	EZ-EMC(Ver.STSLAB-03A1 CE)			



RF Connected Test

Kind of Equipment	Manufacturer	Type No.	Serial No.	Last calibration	Calibrated until
Power Sensor	Keysight	U2021XA	MY55520005	2021.09.30	2022.09.29
			MY55520006	2021.09.30	2022.09.29
			MY56120038	2021.09.30	2022.09.29
			MY56280002	2021.09.30	2022.09.29
Signal Analyzer	Agilent	N9020A	MY51110105	2022.03.01	2023.02.28
Temperature & Humidity	HH660	Mieo	N/A	2021.10.09	2022.10.08
Test SW	FARAD	EZ-EMC(Ver.STSLAB-03A1 RE)			





3. EMC EMISSION TEST

3.1 CONDUCTED EMISSION MEASUREMENT

3.1.1 POWER LINE CONDUCTED EMISSION LIMITS

The radio frequency voltage that is conducted back onto the AC power line on any frequency or frequencies, within the band 150 kHz to 30 MHz, shall not exceed the limits in the following table.

FREQUENCY (MHz)	Conducted Emission limit (dBuV)	
	Quasi-peak	Average
0.15 -0.5	66 - 56 *	56 - 46 *
0.50 -5.0	56.00	46.00
5.0 -30.0	60.00	50.00

Note:

- (1) The tighter limit applies at the band edges.
- (2) The limit of “ * ” marked band means the limitation decreases linearly with the logarithm of the frequency in the range.

The following table is the setting of the receiver

Receiver Parameters	Setting
Attenuation	10 dB
Start Frequency	0.15 MHz
Stop Frequency	30 MHz
IF Bandwidth	9 kHz

3.1.2 TEST PROCEDURE

- a. The EUT is 0.8 m from the horizontal ground plane and 0.4 m from the vertical ground plane with EUT being connected to the power mains through a line impedance stabilization network (LISN). All other support equipments are powered from additional LISN(s). The LISN provides 50 Ohm/ 50uH of coupling impedance for the measuring instrument.
- b. Interconnecting cables that hang closer than 40 cm to the ground plane shall be folded back and forth in the center forming a bundle 30 to 40 cm long.
- c. I/O cables that are not connected to a peripheral shall be bundled in the center. The end of the cable may be terminated, if required, using the correct terminating impedance. The overall length shall not exceed 1 m.
- d. LISN is at least 80 cm from the nearest part of EUT chassis.
- e. For the actual test configuration, please refer to the related Item –EUT Test Photos.

3.1.3 TEST SETUP

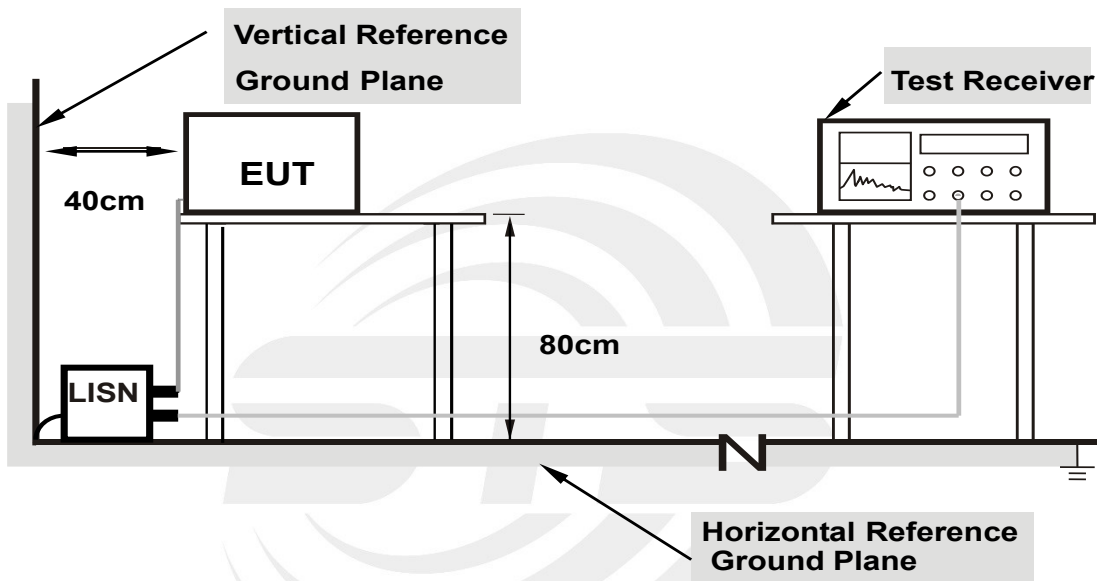

- Note: 1. Support units were connected to second LISN.**
- 2. Both of LISNs (AMN) are 80 cm from EUT and at least 80 cm from other units and other metal planes support units.**

3.1.4 EUT OPERATING CONDITIONS

The EUT was configured for testing in a typical fashion (as a customer would normally use it). The EUT has been programmed to continuously transmit during test. This operating condition was tested and used to collect the included data.



3.1.5 TEST RESULT

Temperature:	24.6(C)	Relative Humidity:	48%RH
Test Voltage:	AC 120V/60Hz	Phase:	L
Test Mode:	Mode 17		

No.	Frequency (MHz)	Reading (dBuV)	Correct Factor(dB)	Result (dBuV)	Limit (dBuV)	Margin (dB)	Remark
1	0.1500	45.28	10.33	55.61	66.00	-10.39	QP
2	0.1500	27.87	10.33	38.20	56.00	-17.80	AVG
3	1.9340	21.40	10.30	31.70	56.00	-24.30	QP
4	1.9340	13.78	10.30	24.08	46.00	-21.92	AVG
5	3.8420	25.86	10.40	36.26	56.00	-19.74	QP
6	3.8420	15.25	10.40	25.65	46.00	-20.35	AVG
7	5.7140	25.15	10.51	35.66	60.00	-24.34	QP
8	5.7140	15.68	10.51	26.19	50.00	-23.81	AVG
9	10.3340	32.70	11.24	43.94	60.00	-16.06	QP
10	10.3340	21.63	11.24	32.87	50.00	-17.13	AVG
11	15.8180	33.67	11.92	45.59	60.00	-14.41	QP
12	15.8180	24.49	11.92	36.41	50.00	-13.59	AVG

Remark:

1. All readings are Quasi-Peak and Average values
2. Margin = Result (Result = Reading + Factor) – Limit
3. Factor = LISN factor + Cable loss + Limiter (10dB)

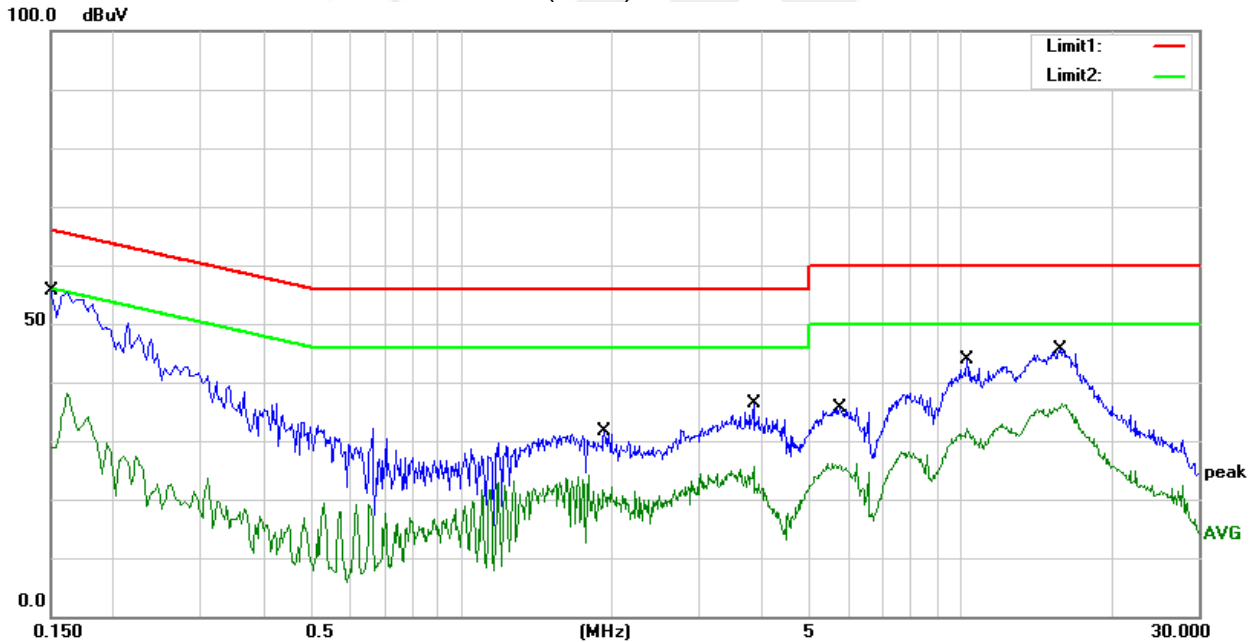



Temperature:	24.6(C)	Relative Humidity:	48%RH
Test Voltage:	AC 120V/60Hz	Phase:	N
Test Mode:	Mode 17		

No.	Frequency (MHz)	Reading (dBuV)	Correct Factor(dB)	Result (dBuV)	Limit (dBuV)	Margin (dB)	Remark
1	0.1500	46.02	10.33	56.35	66.00	-9.65	QP
2	0.1500	26.72	10.33	37.05	56.00	-18.95	AVG
3	1.8420	23.46	10.30	33.76	56.00	-22.24	QP
4	1.8420	15.72	10.30	26.02	46.00	-19.98	AVG
5	3.9380	28.39	10.40	38.79	56.00	-17.21	QP
6	3.9380	13.57	10.40	23.97	46.00	-22.03	AVG
7	6.0900	26.89	10.52	37.41	60.00	-22.59	QP
8	6.0900	16.27	10.52	26.79	50.00	-23.21	AVG
9	8.1220	26.47	10.82	37.29	60.00	-22.71	QP
10	8.1220	16.97	10.82	27.79	50.00	-22.21	AVG
11	14.4580	31.65	11.67	43.32	60.00	-16.68	QP
12	14.4580	21.17	11.67	32.84	50.00	-17.16	AVG

Remark:

1. All readings are Quasi-Peak and Average values
2. Margin = Result (Result =Reading + Factor)–Limit
3. Factor=LISN factor+Cable loss+Limiter (10dB)

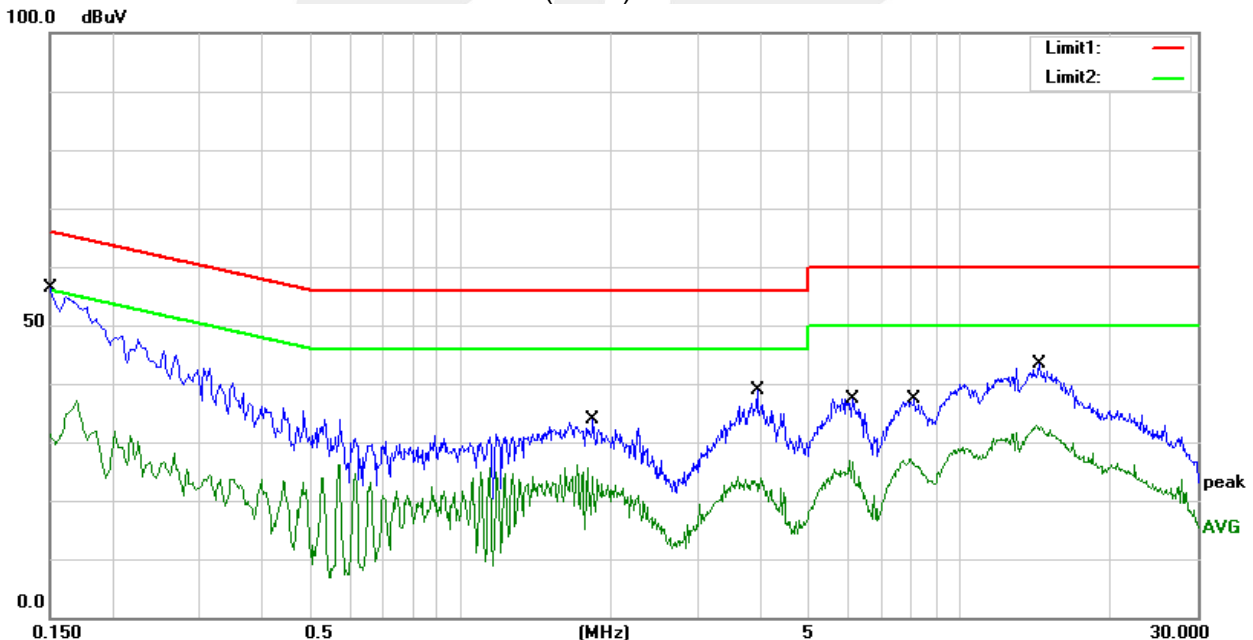



3.2 RADIATED EMISSION MEASUREMENT

3.2.1 RADIATED EMISSION LIMITS

In any 100 kHz bandwidth outside the operating frequency band. In case the emission fall within the Restricted band specified on Part15.205(a)&209(a) limit in the table and according to ANSI C63.10-2013 below has to be followed.

LIMITS OF RADIATED EMISSION MEASUREMENT (0.009MHz - 1000MHz)

Frequencies (MHz)	Field Strength (micovolts/meter)	Measurement Distance (meters)
0.009~0.490	2400/F(KHz)	300
0.490~1.705	24000/F(KHz)	30
1.705~30.0	30	30
30~88	100	3
88~216	150	3
216~960	200	3
Above 960	500	3

LIMITS OF RADIATED EMISSION MEASUREMENT (1000MHz-25GHz)

FREQUENCY (MHz)	(dBuV/m) (at 3M)	
	PEAK	AVERAGE
Above 1000	74	54

Notes:

- (1) The limit for radiated test was performed according to FCC PART 15C.
- (2) The tighter limit applies at the band edges.
- (3) Emission level (dBuV/m)=20log Emission level (uV/m).

LIMITS OF RESTRICTED FREQUENCY BANDS

FREQUENCY (MHz)	FREQUENCY (MHz)	FREQUENCY (MHz)	FREQUENCY (GHz)
0.090-0.110	16.42-16.423	399.9-410	4.5-5.15
0.495-0.505	16.69475-16.69525	608-614	5.35-5.46
2.1735-2.1905	16.80425-16.80475	960-1240	7.25-7.75
4.125-4.128	25.5-25.67	1300-1427	8.025-8.5
4.17725-4.17775	37.5-38.25	1435-1626.5	9.0-9.2
4.20725-4.20775	73-74.6	1645.5-1646.5	9.3-9.5
6.215-6.218	74.8-75.2	1660-1710	10.6-12.7
6.26775-6.26825	108-121.94	1718.8-1722.2	13.25-13.4
6.31175-6.31225	123-138	2200-2300	14.47-14.5
8.291-8.294	149.9-150.05	2310-2390	15.35-16.2
8.362-8.366	156.52475-156.52525	2483.5-2500	17.7-21.4
8.37625-8.38675	156.7-156.9	2690-2900	22.01-23.12
8.41425-8.41475	162.0125-167.17	3260-3267	23.6-24.0
12.29-12.293	167.72-173.2	3332-3339	31.2-31.8
12.51975-12.52025	240-285	3345.8-3358	36.43-36.5
12.57675-12.57725	322-335.4	3600-4400	Above 38.6
13.36-13.41			



For Radiated Emission

Spectrum Parameter	Setting
Attenuation	Auto
Detector	Peak/QP/AV
Start Frequency	9 KHz/150KHz(Peak/QP/AV)
Stop Frequency	150KHz/30MHz(Peak/QP/AV)
RB / VB (emission in restricted band)	200Hz (From 9kHz to 0.15MHz)/ 9KHz (From 0.15MHz to 30MHz); 200Hz (From 9kHz to 0.15MHz)/ 9KHz (From 0.15MHz to 30MHz)

Spectrum Parameter	Setting
Attenuation	Auto
Detector	Peak/QP
Start Frequency	30 MHz(Peak/QP)
Stop Frequency	1000 MHz (Peak/QP)
RB / VB (emission in restricted band)	120 KHz / 300 KHz

Spectrum Parameter	Setting
Attenuation	Auto
Detector	Peak/AV
Start Frequency	1000 MHz(Peak/AV)
Stop Frequency	10th carrier hamonic(Peak/AV)
RB / VB (emission in restricted band)	1 MHz / 3 MHz(Peak) 1 MHz/1/T MHz(AVG)

For Restricted band

Spectrum Parameter	Setting
Detector	Peak/AV
Start/Stop Frequency	Lower Band Edge: 2310 to 2430 MHz Upper Band Edge: 2445 to 2500 MHz
RB / VB	1 MHz / 3 MHz(Peak) 1 MHz/1/T MHz(AVG)



Receiver Parameter	Setting
Start ~ Stop Frequency	9kHz~90kHz / RB 200Hz for PK & AV
Start ~ Stop Frequency	90kHz~110kHz / RB 200Hz for QP
Start ~ Stop Frequency	110kHz~490kHz / RB 200Hz for PK & AV
Start ~ Stop Frequency	490kHz~30MHz / RB 9kHz for QP
Start ~ Stop Frequency	30MHz~1000MHz / RB 120kHz for QP

3.2.2 TEST PROCEDURE

- a. The measuring distance at 3 m shall be used for measurements at frequency 0.009MHz up to 1GHz, and above 1GHz.
- b. The EUT was placed on the top of a rotating table 0.8 m (above 1GHz is 1.5 m) above the ground at a 3 m anechoic chamber test site. The table was rotated 360 degree to determine the position of the highest radiation.
- c. The height of the equipment shall be 0.8 m (above 1GHz is 1.5 m); the height of the test antenna shall vary between 1 m to 4 m. Horizontal and vertical polarization of the antenna are set to make the measurement.
- d. The initial step in collecting conducted emission data is a spectrum analyzer peak detector mode pre-scanning the measurement frequency range. Significant peaks are then marked and QuasiPeak detector mode will be re-measured.
- e. If the Peak Mode measured value is compliance with and lower than Quasi Peak Mode Limit, the EUT shall be deemed to meet QP Limits and no additional QP Mode measurement was performed.
- f. For the actual test configuration, please refer to the related Item –EUT Test Photos.

Note:

Both horizontal and vertical antenna polarities were tested and performed pretest to three orthogonal axis. The worst case emissions were reported.

3.2.3 TEST SETUP

(A) Radiated Emission Test-Up Frequency Below 30MHz

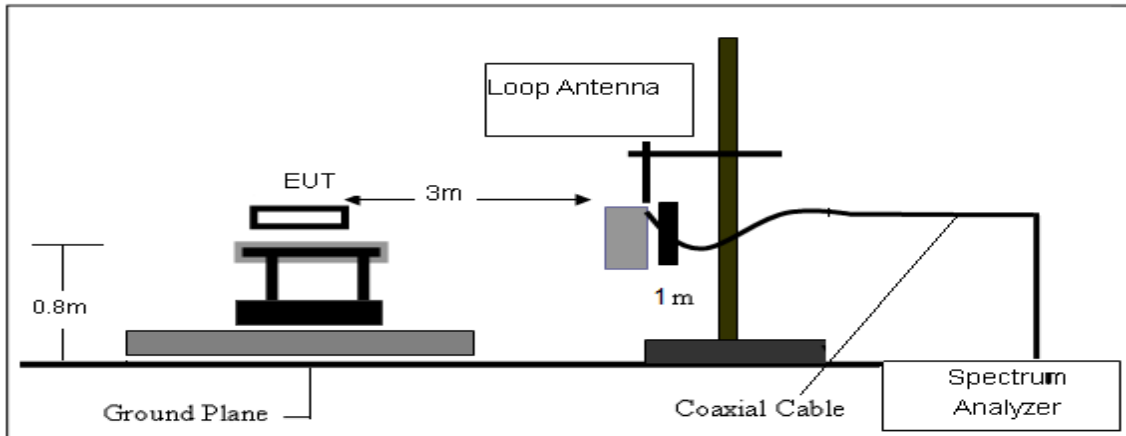

(B) Radiated Emission Test-Up Frequency 30MHz~1GHz

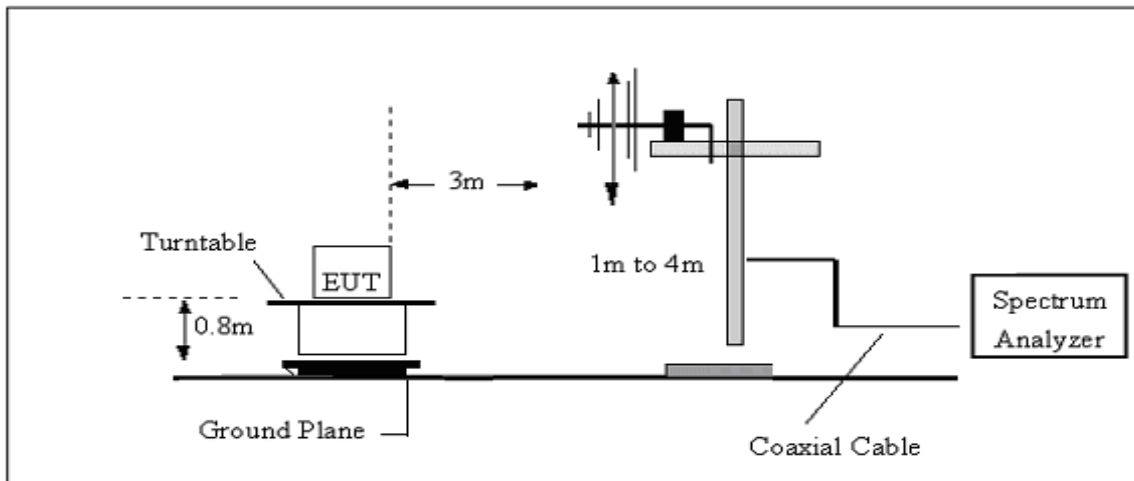

(C) Radiated Emission Test-Up Frequency Above 1GHz

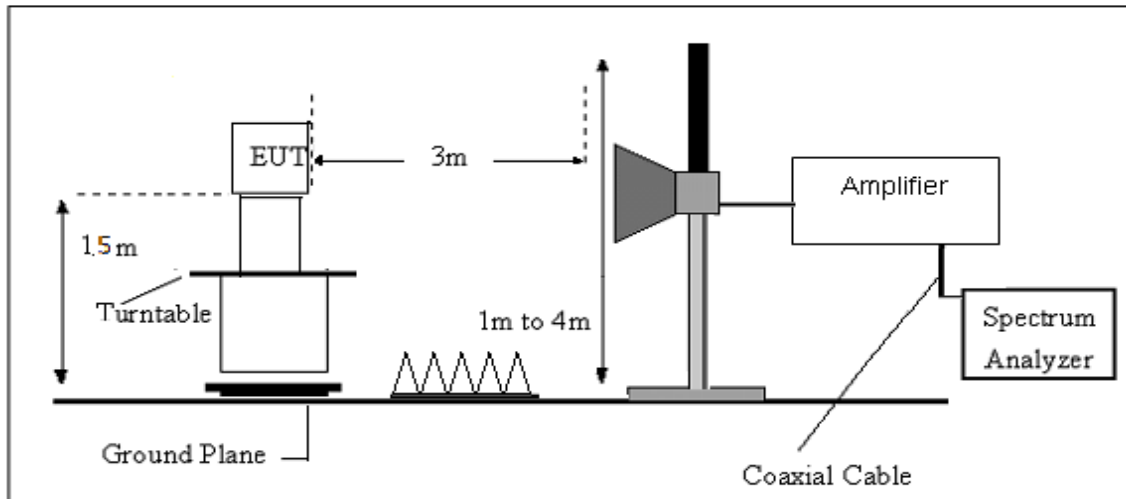

3.2.4 EUT OPERATING CONDITIONS

Please refer to section 3.1.4 of this report.



3.2.5 FIELD STRENGTH CALCULATION

The field strength is calculated by adding the Antenna Factor and Cable Factor and subtracting the Amplifier Gain and Duty Cycle Correction Factor (if any) from the measured reading. The basic equation with a sample calculation is as follows:

$$FS = RA + AF + CL - AG$$

Where

FS = Field Strength

CL = Cable Attenuation Factor (Cable Loss)

RA = Reading Amplitude

AG = Amplifier Gain

AF = Antenna Factor

For example

Frequency (MHz)	FS (dB μ V/m)	RA (dB μ V/m)	AF (dB)	CL (dB)	AG (dB)	Factor (dB)
300	40	58.1	12.2	1.6	31.9	-18.1

$$\text{Factor} = \text{AF} + \text{CL} - \text{AG}$$





3.2.6 TEST RESULT

9KHz-30MHz

Temperature:	23.1(C)	Relative Humidity:	60%RH
Test Voltage:	DC 10.8V	Polarization:	--
Test Mode:	TX Mode		

Freq. (MHz)	Reading (dBuV/m)	Limit (dBuV/m)	Margin (dB)	State P/F	Test Result
--	--	--	--	--	PASS
--	--	--	--	--	PASS

Note:

The amplitude of spurious emissions which are attenuated by more than 20dB below the permissible value has no need to be reported.

Distance extrapolation factor = $40 \log(\text{specific distance}/\text{test distance})$ (dB);

Limit line = specific limits(dBuv) + distance extrapolation factor.

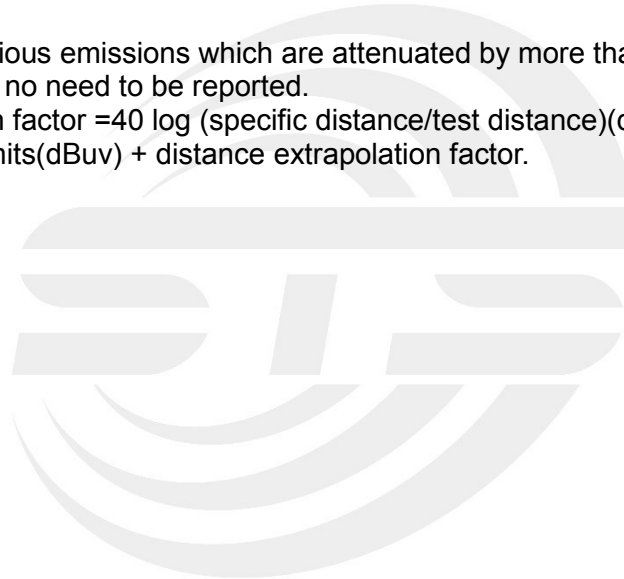



(30MHz - 1000MHz)

Temperature:	23.1(C)	Relative Humidity:	60%RH
Test Voltage:	DC 10.8V	Phase:	Horizontal
Test Mode:	Mode 1/2/3/4/5/6/7/8/9/10/11/12/13/14/15/16/17 (Mode 14 worst mode)		

No.	Frequency (MHz)	Reading (dBuV)	Correct Factor(dB/m)	Result (dBuV/m)	Limit (dBuV/m)	Margin (dB)	Remark
1	33.8800	35.59	-14.80	20.79	40.00	-19.21	QP
2	80.4400	41.68	-22.93	18.75	40.00	-21.25	QP
3	161.9200	43.34	-19.01	24.33	43.50	-19.17	QP
4	324.8800	42.55	-13.85	28.70	46.00	-17.30	QP
5	441.2800	39.27	-10.04	29.23	46.00	-16.77	QP
6	989.3300	31.11	2.09	33.20	54.00	-20.80	QP

Remark:

- Margin = Result (Result = Reading + Factor) – Limit
- Factor = Antenna factor + Cable attenuation factor (cable loss) - Amplifier gain

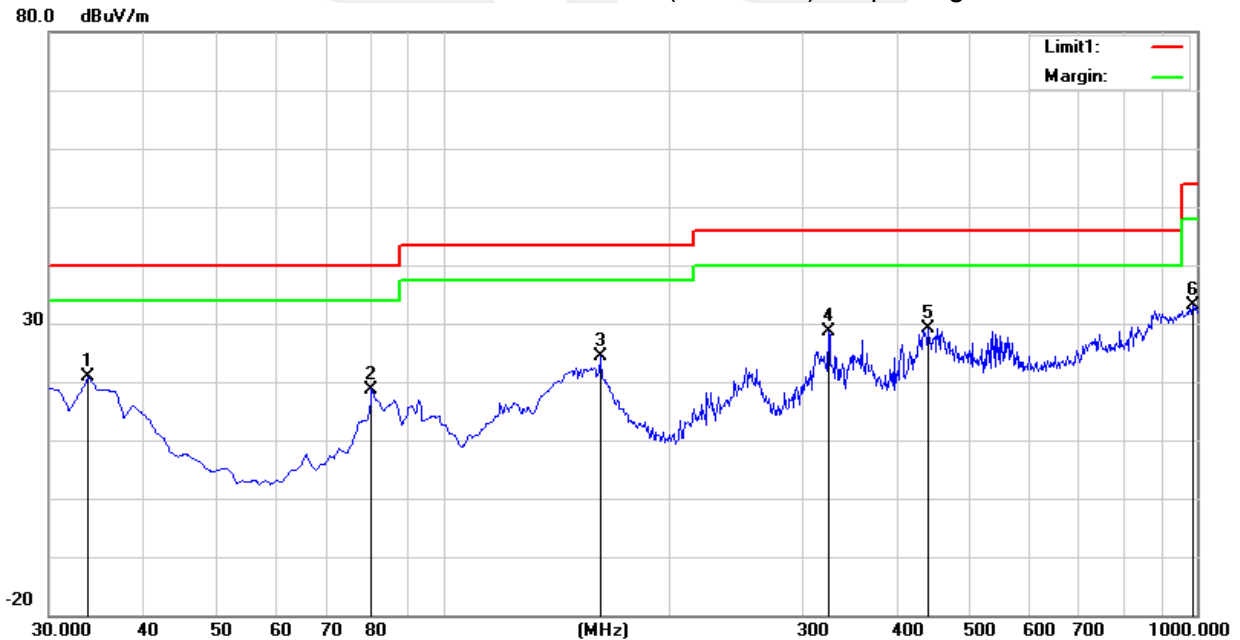



Temperature:	23.1(C)	Relative Humidity:	60%RH
Test Voltage:	DC 10.8V	Phase:	Vertical
Test Mode:	Mode 1/2/3/4/5/6/7/8/9/10/11/12/13/14/15/16/17 (Mode 14 worst mode)		

No.	Frequency (MHz)	Reading (dBUV)	Correct Factor(dB/m)	Result (dBUV/m)	Limit (dBUV/m)	Margin (dB)	Remark
1	33.8800	49.52	-14.80	34.72	40.00	-5.28	QP
2	80.4400	49.23	-22.93	26.30	40.00	-13.70	QP
3	125.0600	38.35	-18.22	20.13	43.50	-23.37	QP
4	223.0300	44.61	-19.42	25.19	46.00	-20.81	QP
5	447.1000	42.66	-9.79	32.87	46.00	-13.13	QP
6	969.9300	28.30	2.00	30.30	54.00	-23.70	QP

Remark:.

- Margin = Result (Result = Reading + Factor) – Limit
- Factor = Antenna factor + Cable attenuation factor (cable loss) - Amplifier gain

80.0 dBUV/m

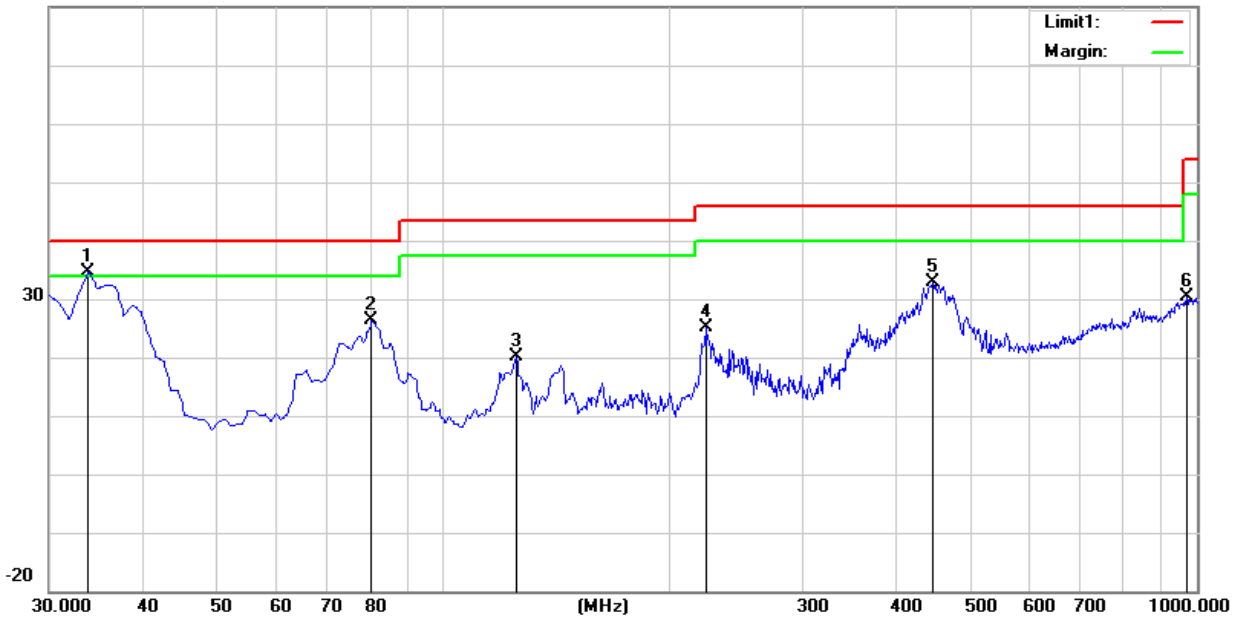



(1000MHz-25GHz) Restricted band and Spurious emission Requirements

802.11 n(HT40)

Frequency (MHz)	Meter Reading (dBμV)	Amplifier (dB)	Loss (dB)	Antenna Factor (dB/m)	Corrected Factor (dB)	Emission Level (dBμV/m)	Limits (dBμV/m)	Margin (dB)	Detector Type	Comment
Low Channel (802.11n40/2422 MHz)										
3264.68	60.94	44.70	6.70	28.20	-9.80	51.14	74.00	-22.86	PK	Vertical
3264.68	50.32	44.70	6.70	28.20	-9.80	40.52	54.00	-13.48	AV	Vertical
3264.71	60.98	44.70	6.70	28.20	-9.80	51.18	74.00	-22.82	PK	Horizontal
3264.71	50.01	44.70	6.70	28.20	-9.80	40.21	54.00	-13.79	AV	Horizontal
4824.52	59.04	44.20	9.04	31.60	-3.56	55.48	74.00	-18.52	PK	Vertical
4824.52	50.12	44.20	9.04	31.60	-3.56	46.56	54.00	-7.44	AV	Vertical
4824.50	59.07	44.20	9.04	31.60	-3.56	55.51	74.00	-18.49	PK	Horizontal
4824.50	49.46	44.20	9.04	31.60	-3.56	45.90	54.00	-8.10	AV	Horizontal
5359.79	48.59	44.20	9.86	32.00	-2.34	46.25	74.00	-27.75	PK	Vertical
5359.79	39.97	44.20	9.86	32.00	-2.34	37.63	54.00	-16.37	AV	Vertical
5359.70	47.59	44.20	9.86	32.00	-2.34	45.25	74.00	-28.75	PK	Horizontal
5359.70	38.83	44.20	9.86	32.00	-2.34	36.49	54.00	-17.51	AV	Horizontal
7235.74	54.94	43.50	11.40	35.50	3.40	58.34	74.00	-15.66	PK	Vertical
7235.74	44.55	43.50	11.40	35.50	3.40	47.95	54.00	-6.05	AV	Vertical
7235.81	54.91	43.50	11.40	35.50	3.40	58.31	74.00	-15.69	PK	Horizontal
7235.81	43.51	43.50	11.40	35.50	3.40	46.91	54.00	-7.09	AV	Horizontal
Middle Channel (802.11n40/2437 MHz)										
3264.77	61.66	44.70	6.70	28.20	-9.80	51.86	74.00	-22.14	PK	Vertical
3264.77	51.48	44.70	6.70	28.20	-9.80	41.68	54.00	-12.32	AV	Vertical
3264.71	61.79	44.70	6.70	28.20	-9.80	51.99	74.00	-22.01	PK	Horizontal
3264.71	50.77	44.70	6.70	28.20	-9.80	40.97	54.00	-13.03	AV	Horizontal
4874.32	59.13	44.20	9.04	31.60	-3.56	55.57	74.00	-18.43	PK	Vertical
4874.32	49.36	44.20	9.04	31.60	-3.56	45.80	54.00	-8.20	AV	Vertical
4874.53	58.84	44.20	9.04	31.60	-3.56	55.28	74.00	-18.72	PK	Horizontal
4874.53	49.71	44.20	9.04	31.60	-3.56	46.15	54.00	-7.85	AV	Horizontal
5359.83	49.06	44.20	9.86	32.00	-2.34	46.71	74.00	-27.29	PK	Vertical
5359.83	39.03	44.20	9.86	32.00	-2.34	36.68	54.00	-17.32	AV	Vertical
5359.81	47.14	44.20	9.86	32.00	-2.34	44.79	74.00	-29.21	PK	Horizontal
5359.81	38.43	44.20	9.86	32.00	-2.34	36.08	54.00	-17.92	AV	Horizontal
7310.86	53.58	43.50	11.40	35.50	3.40	56.98	74.00	-17.02	PK	Vertical
7310.86	43.66	43.50	11.40	35.50	3.40	47.06	54.00	-6.94	AV	Vertical
7310.86	53.67	43.50	11.40	35.50	3.40	57.07	74.00	-16.93	PK	Horizontal
7310.86	44.62	43.50	11.40	35.50	3.40	48.02	54.00	-5.98	AV	Horizontal



High Channel (802.11n40/2452 MHz)										
3264.78	61.65	44.70	6.70	28.20	-9.80	51.85	74.00	-22.15	PK	Vertical
3264.78	51.81	44.70	6.70	28.20	-9.80	42.01	54.00	-11.99	AV	Vertical
3264.83	61.36	44.70	6.70	28.20	-9.80	51.56	74.00	-22.44	PK	Horizontal
3264.83	50.51	44.70	6.70	28.20	-9.80	40.71	54.00	-13.29	AV	Horizontal
4924.48	58.60	44.20	9.04	31.60	-3.56	55.04	74.00	-18.96	PK	Vertical
4924.48	49.16	44.20	9.04	31.60	-3.56	45.60	54.00	-8.40	AV	Vertical
4924.39	58.68	44.20	9.04	31.60	-3.56	55.12	74.00	-18.88	PK	Horizontal
4924.39	50.38	44.20	9.04	31.60	-3.56	46.82	54.00	-7.18	AV	Horizontal
5359.71	48.48	44.20	9.86	32.00	-2.34	46.14	74.00	-27.86	PK	Vertical
5359.71	39.11	44.20	9.86	32.00	-2.34	36.77	54.00	-17.23	AV	Vertical
5359.78	48.09	44.20	9.86	32.00	-2.34	45.74	74.00	-28.26	PK	Horizontal
5359.78	38.19	44.20	9.86	32.00	-2.34	35.85	54.00	-18.15	AV	Horizontal
7385.88	54.66	43.50	11.40	35.50	3.40	58.06	74.00	-15.94	PK	Vertical
7385.88	44.67	43.50	11.40	35.50	3.40	48.07	54.00	-5.93	AV	Vertical
7385.95	54.01	43.50	11.40	35.50	3.40	57.41	74.00	-16.59	PK	Horizontal
7385.95	43.86	43.50	11.40	35.50	3.40	47.26	54.00	-6.74	AV	Horizontal

Remark:

- Factor = Antenna Factor + Cable Loss – Pre-amplifier.
- Scan with 802.11b, 802.11g, 802.11n (HT-20), 802.11n (HT-40) all have been tested the antenna A, antenna B and antenna A+B, the worst case is 802.11n (HT-40) of the antenna A+B.
Emission Level = Reading + Factor
Margin = Limit - Emission Level
- The frequency emission of peak points that did not show above the forms are at least 20dB below the limit, the frequency emission is mainly from the environment noise.

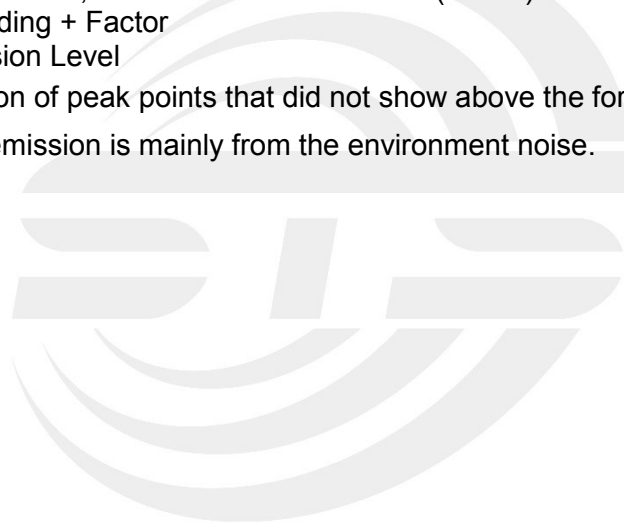



3.2.6 TEST RESULTS(Restricted band Requirements)

802.11 n(HT40)-Low

Horizontal

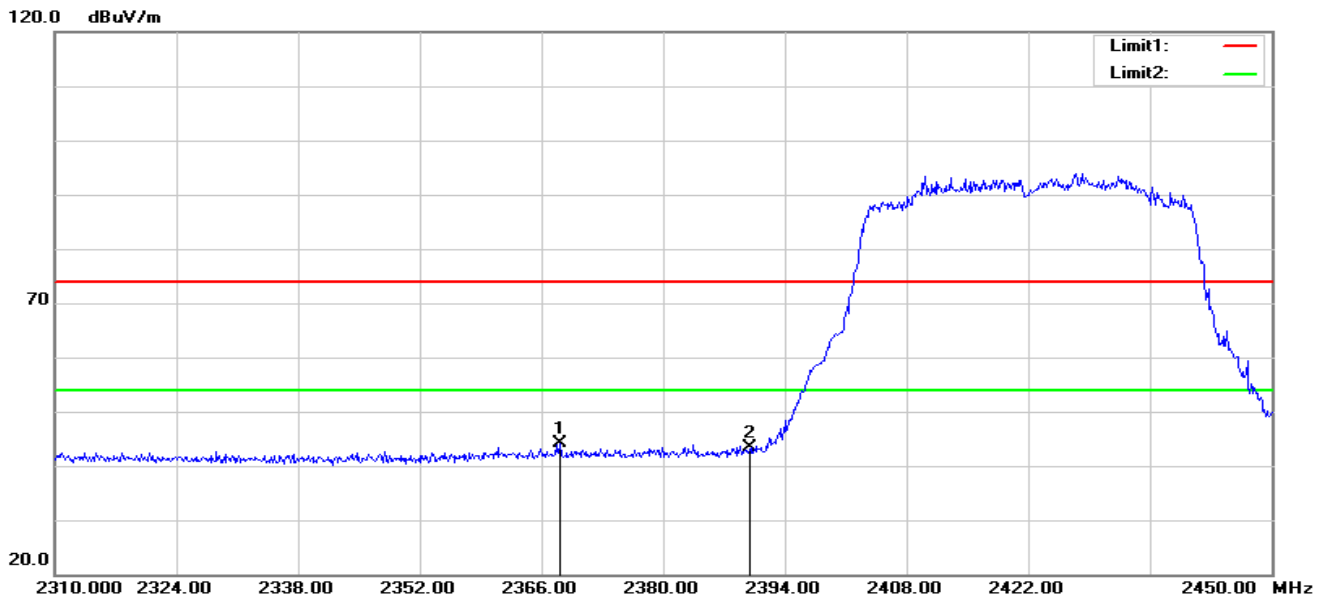

No.	Frequency (MHz)	Reading (dBuV)	Correct Factor(dB/m)	Result (dBuV/m)	Limit (dBuV/m)	Margin (dB)	Remark
1	2368.100	40.03	4.01	44.04	74.00	-29.96	peak
2	2390.000	39.14	4.34	43.48	74.00	-30.52	peak



Vertical

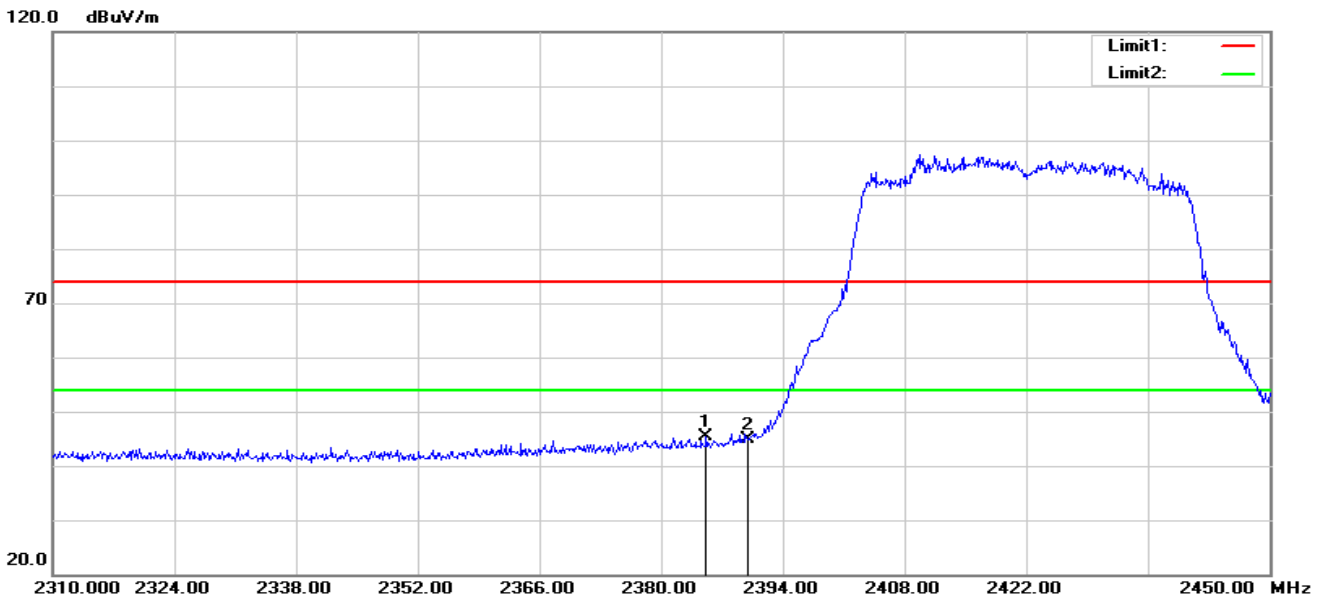

No.	Frequency (MHz)	Reading (dBuV)	Correct Factor(dB/m)	Result (dBuV/m)	Limit (dBuV/m)	Margin (dB)	Remark
1	2385.180	41.12	4.27	45.39	74.00	-28.61	peak
2	2390.000	40.64	4.34	44.98	74.00	-29.02	peak



802.11 n(HT40)-High
Horizontal

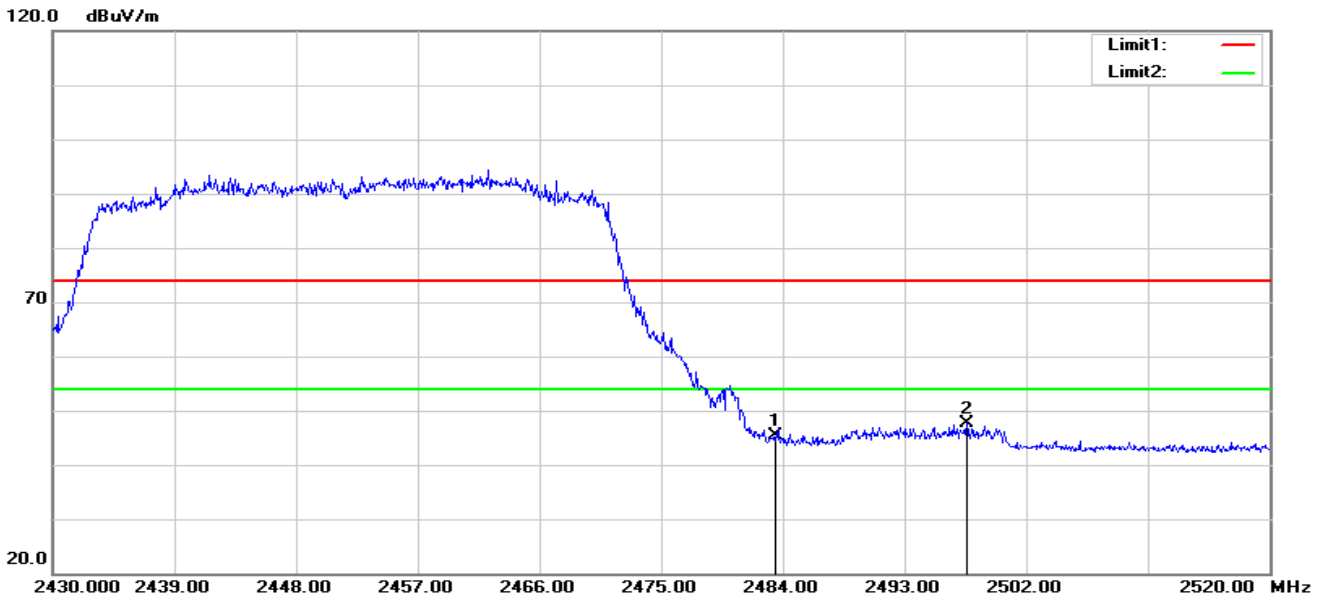

No.	Frequency (MHz)	Reading (dBuV)	Correct Factor(dB/m)	Result (dBuV/m)	Limit (dBuV/m)	Margin (dB)	Remark
1	2483.500	40.88	4.60	45.48	74.00	-28.52	peak
2	2497.590	42.89	4.64	47.53	74.00	-26.47	peak



Vertical

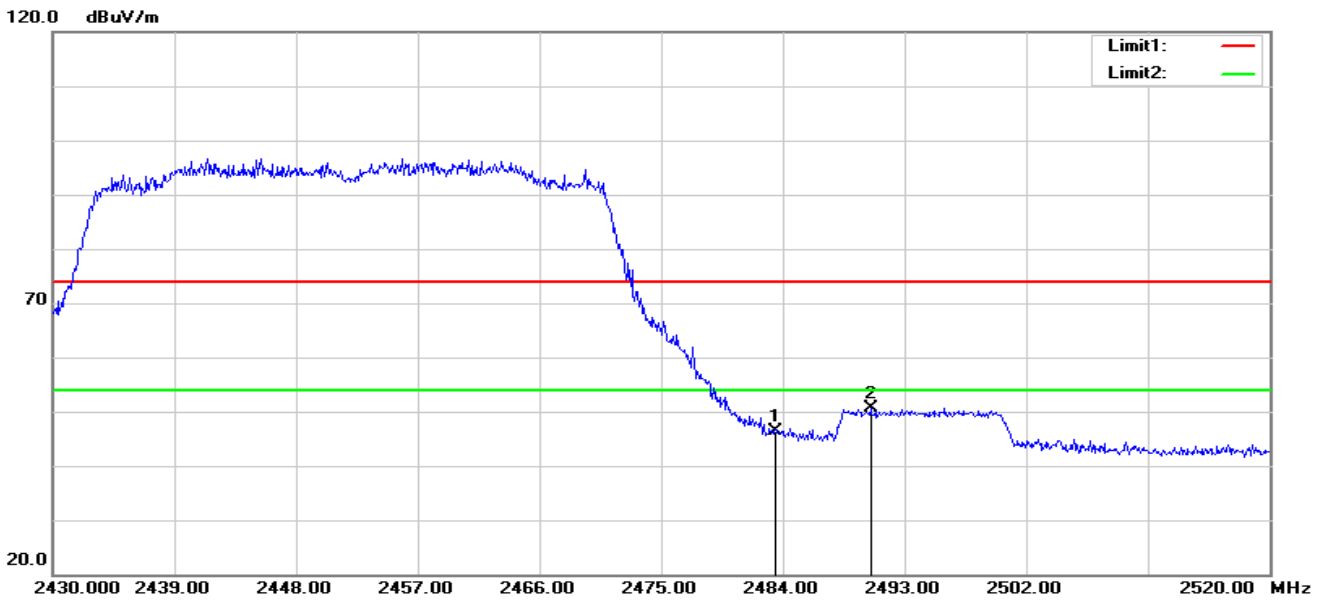

No.	Frequency (MHz)	Reading (dBuV)	Correct Factor(dB/m)	Result (dBuV/m)	Limit (dBuV/m)	Margin (dB)	Remark
1	2483.500	41.89	4.60	46.49	74.00	-27.51	peak
2	2490.480	46.04	4.63	50.67	74.00	-23.33	peak

Note: 802.11b, 802.11g, 802.11n (HT-20), 802.11n (HT-40), all have been tested the antenna A, antenna B and antenna A+B, the worst case is 802.11 n(HT40) of the antenna A+B.

4. CONDUCTED SPURIOUS & BAND EDGE EMISSION

4.1 LIMIT

According to FCC section 15.247(d), in any 100kHz bandwidth outside the frequency band in which the spread spectrum or digitally modulated intentional radiator is operating, the radio frequency power that is produced by the intentional radiator shall be at least 20dB below that in the 100kHz bandwidth within the band that contains the highest level of the desired power, based on either an RF conducted or a radiated measurement.

4.2 TEST PROCEDURE

Spectrum Parameter	Setting
Detector	Peak
Start/Stop Frequency	30 MHz to 10th carrier harmonic
RB / VB (emission in restricted band)	100 KHz/300 KHz
Trace-Mode:	Max hold

For Band edge

Spectrum Parameter	Setting
Detector	Peak
Start/Stop Frequency	Lower Band Edge: 2300 to 2432 MHz Upper Band Edge: 2442 to 2500 MHz
RB / VB (emission in restricted band)	100 KHz/300 KHz
Trace-Mode:	Max hold

4.3 DEVIATION FROM STANDARD

No deviation.

4.4 TEST SETUP



The EUT which is powered by the DC, is connected to the Spectrum Analyzer; the RF load attached to the EUT antenna terminal is 50Ohm; the path loss as the factor is calibrated to correct the reading.

Make the measurement with the spectrum analyzer's resolution bandwidth (RBW) = 100 kHz. In order to make an accurate measurement, set the span greater than RBW.

4.5 EUT OPERATION CONDITIONS

Please refer to section 3.1.4 of this report.



4.6 TEST RESULTS

Note: Antenna A Power > Antenna B Power, Both antenna A and B have been test, Only show the worst data of Antenna A

Temperature:	25°C	Relative Humidity:	60%
Test Voltage:	DC 10.8V	Test Mode:	TX b Mode /CH01, CH06, CH11

Antenna A
CH 01

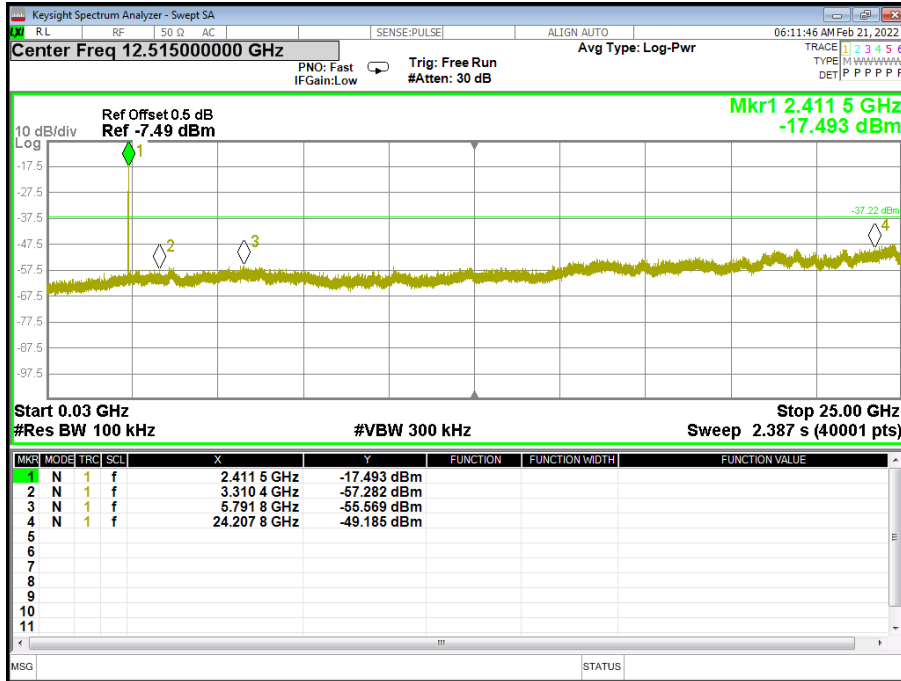

CH 06

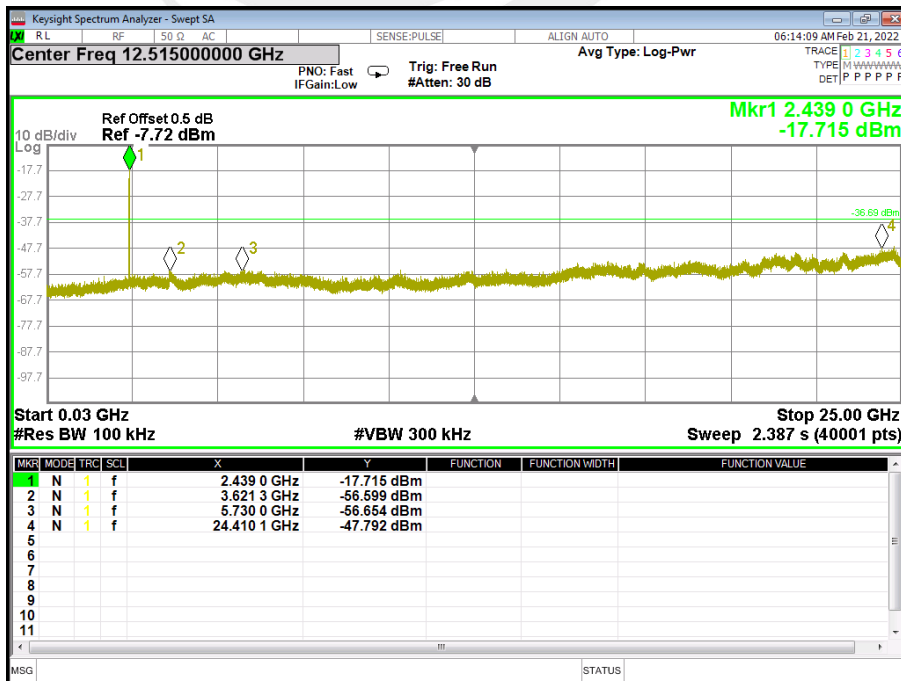



CH 11

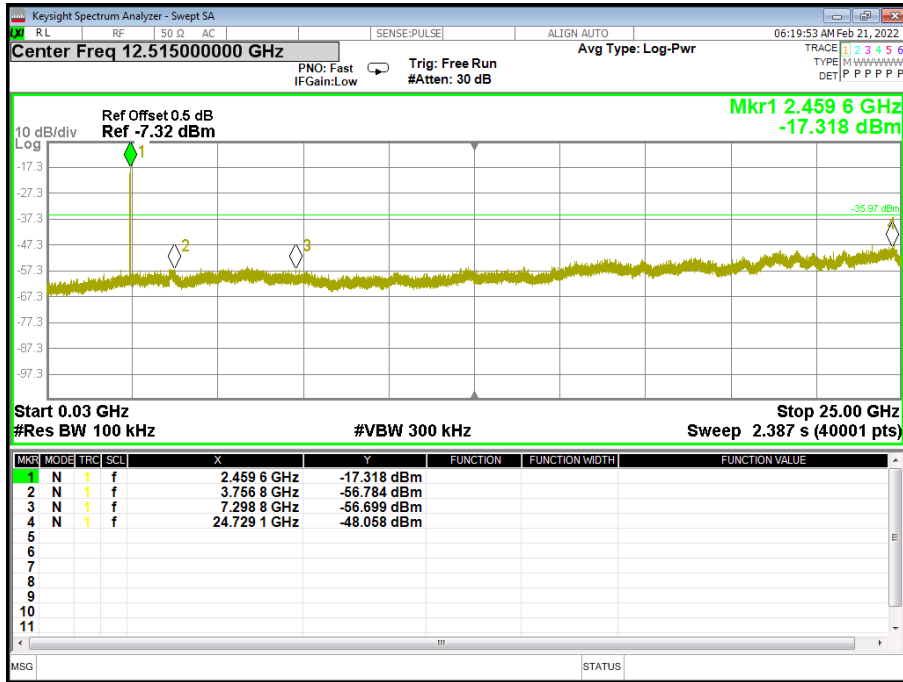



Band edge(it's also the reference level for conducted spurious emission)

CH 01

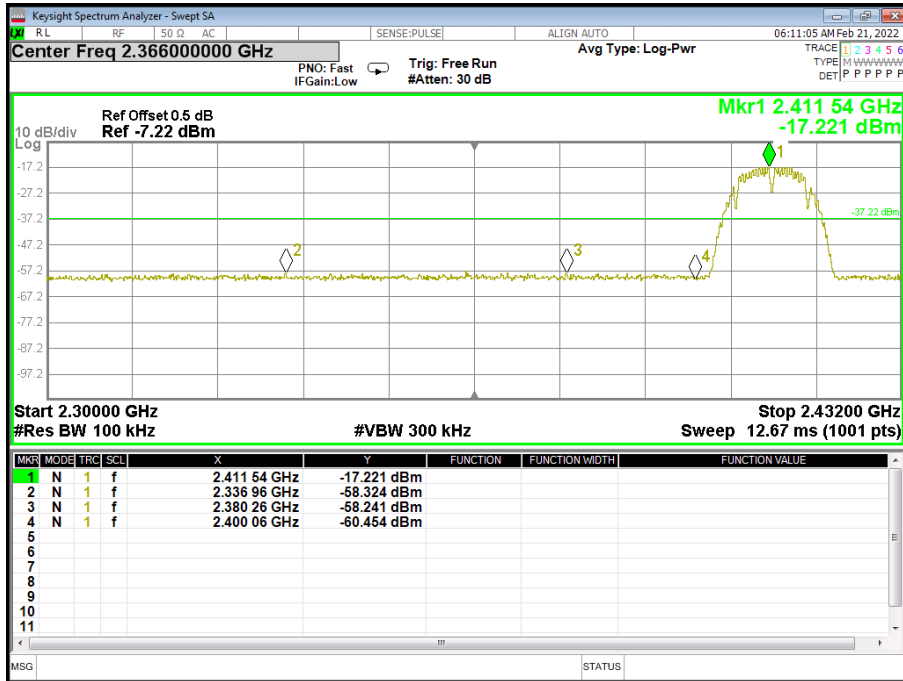

CH 06

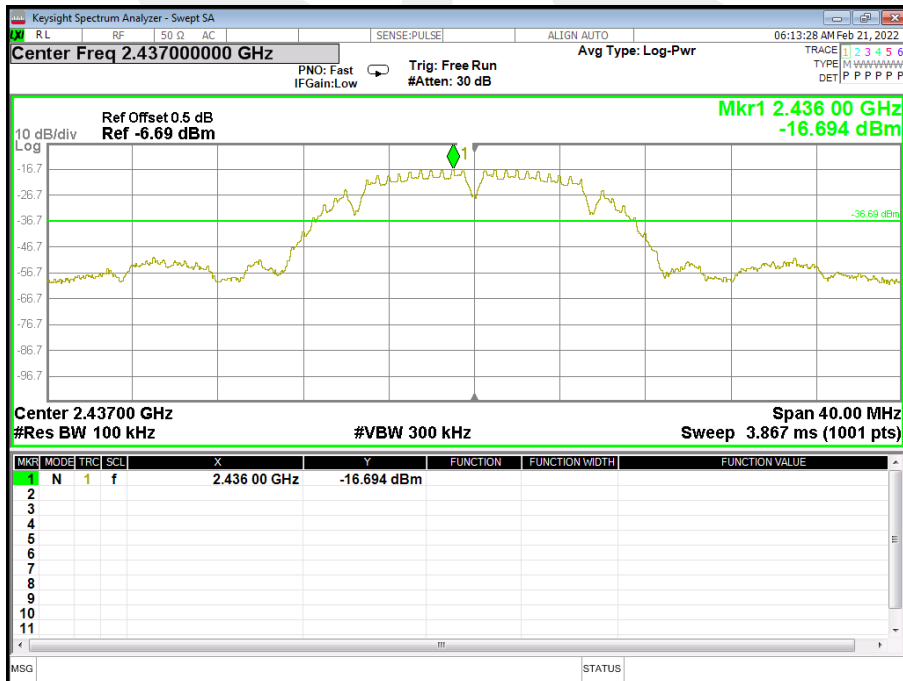



CH 11

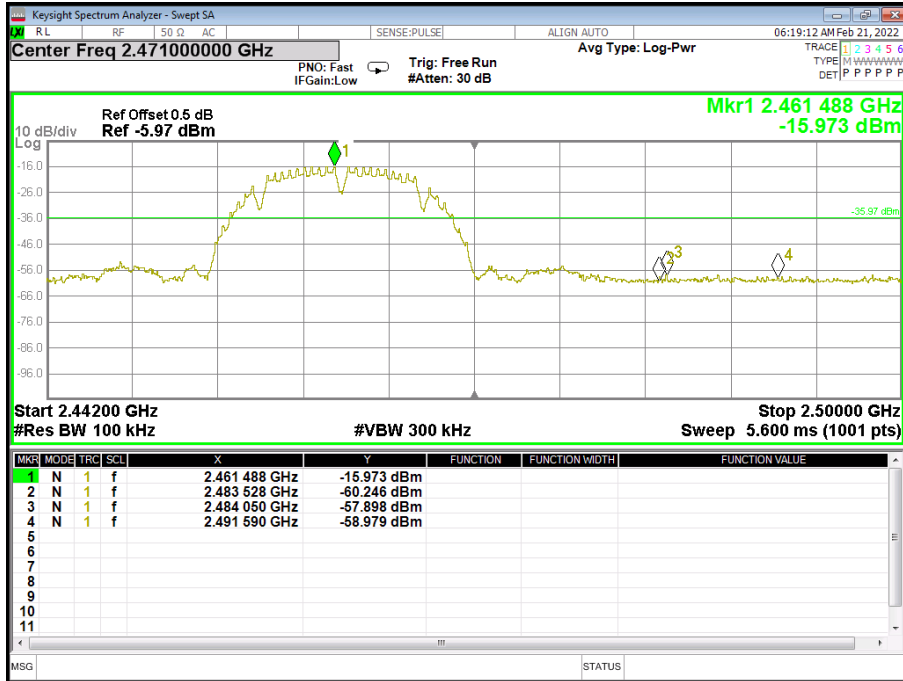



Temperature:	25°C	Relative Humidity:	60%
Test Voltage:	DC 10.8V	Test Mode:	TX g Mode /CH01, CH06, CH11

Antenna A
CH 01

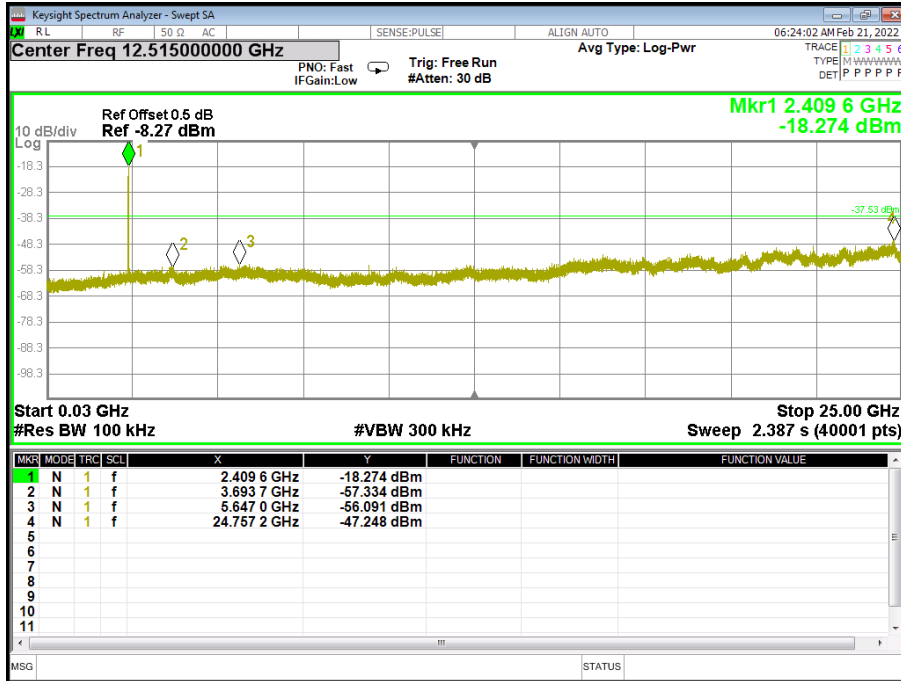

CH06

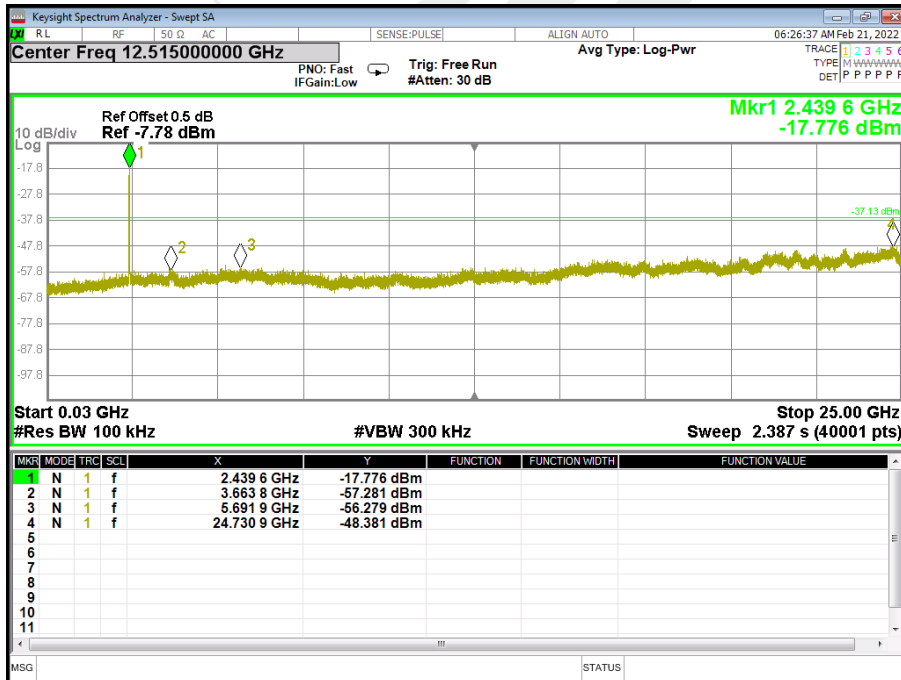



CH 11

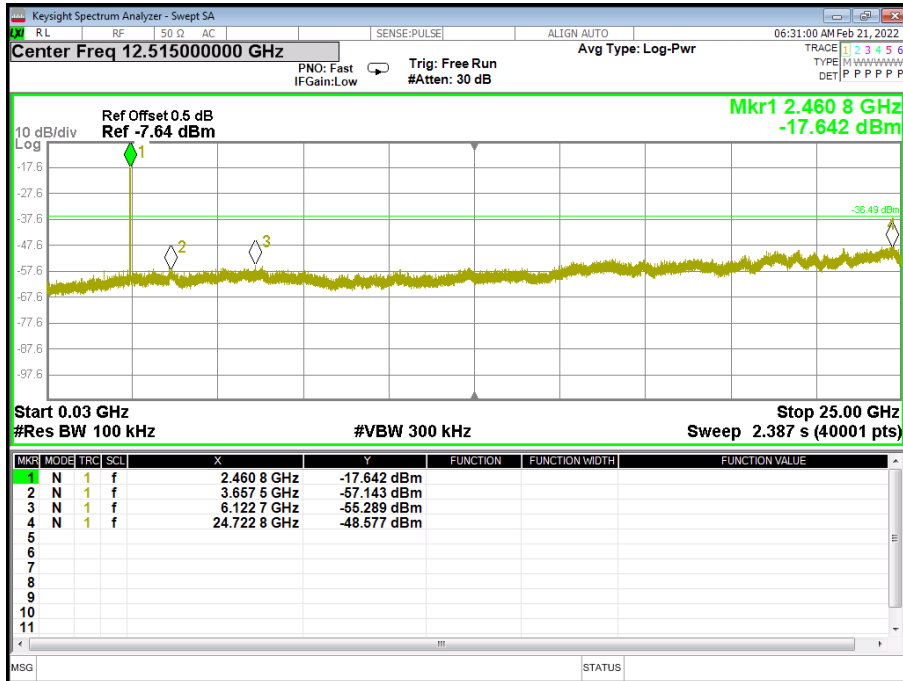



Band edge(it's also the reference level for conducted spurious emission)

CH 01

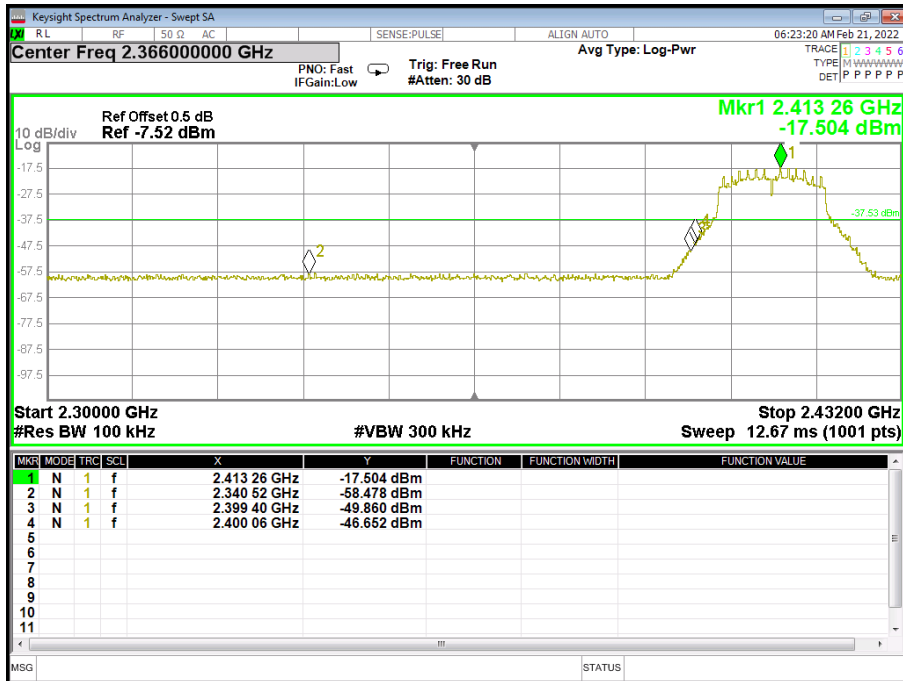

CH06





CH11

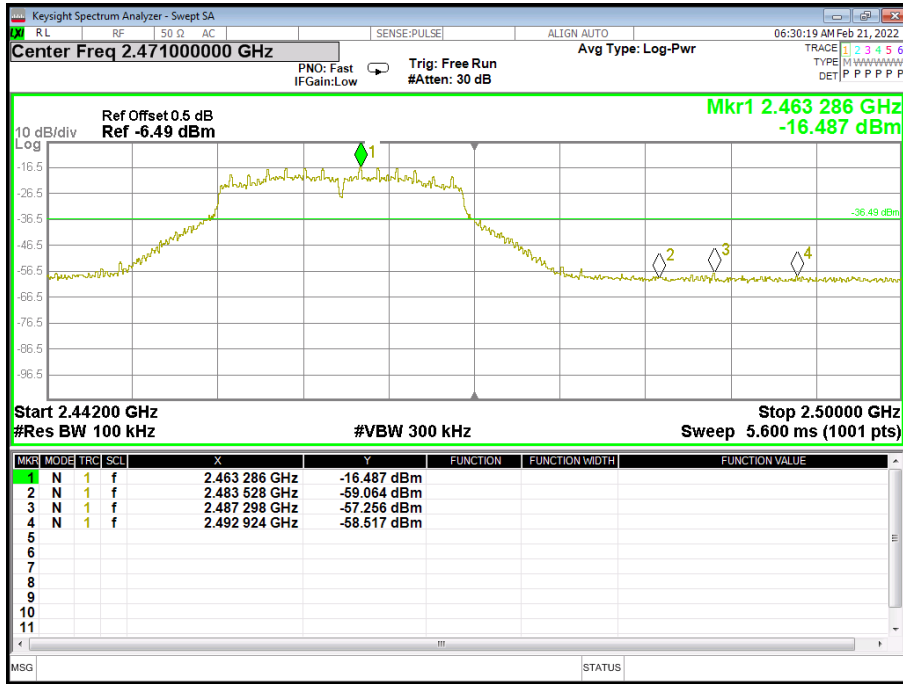



Temperature:	25°C	Relative Humidity:	60%
Test Voltage:	DC 10.8V	Test Mode:	TX n Mode(20M) /CH01, CH06, CH11

Antenna A

CH 01

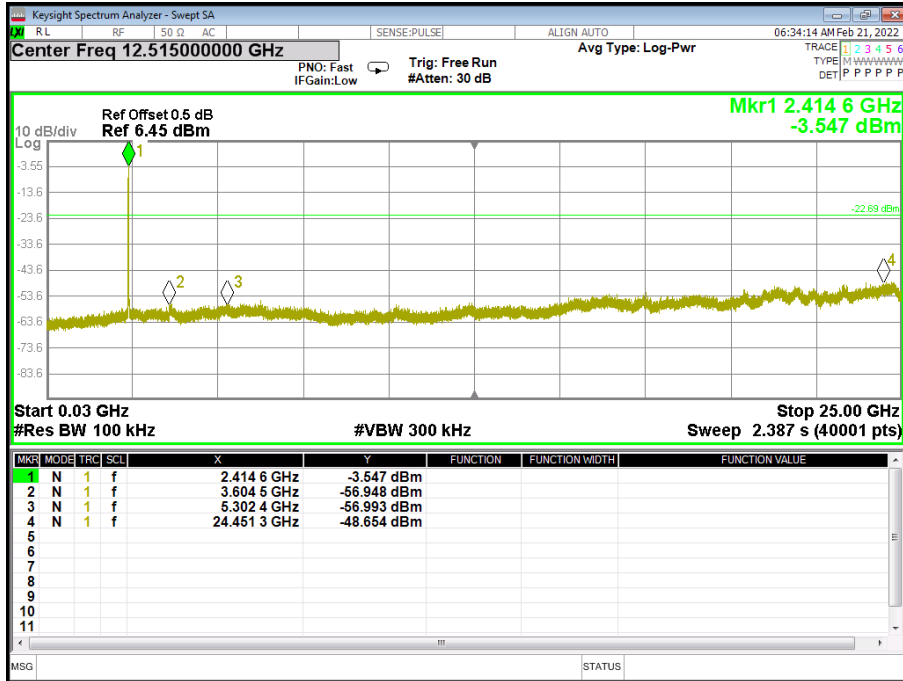

CH 06

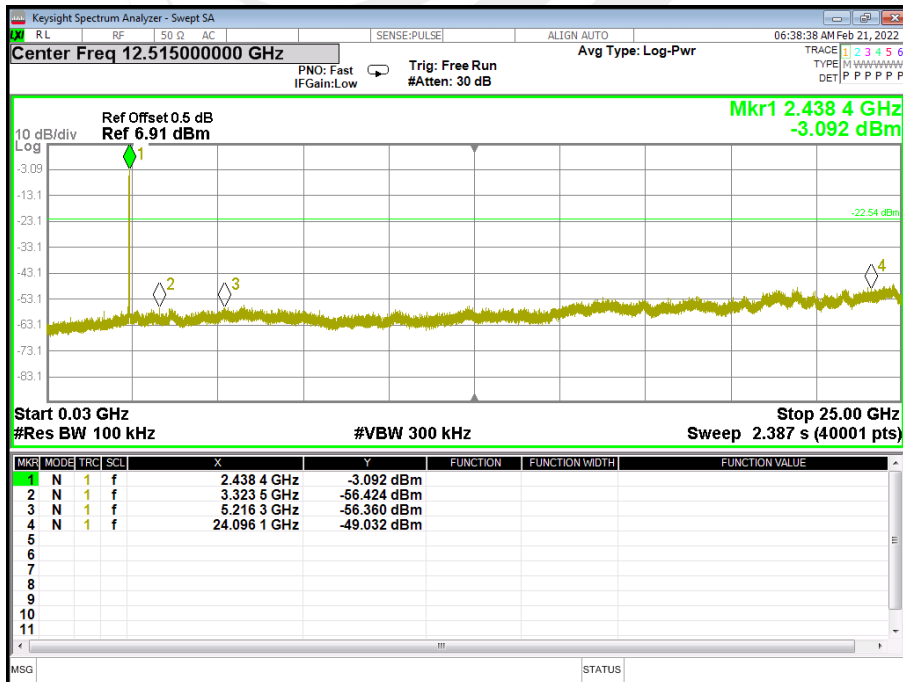



CH 11

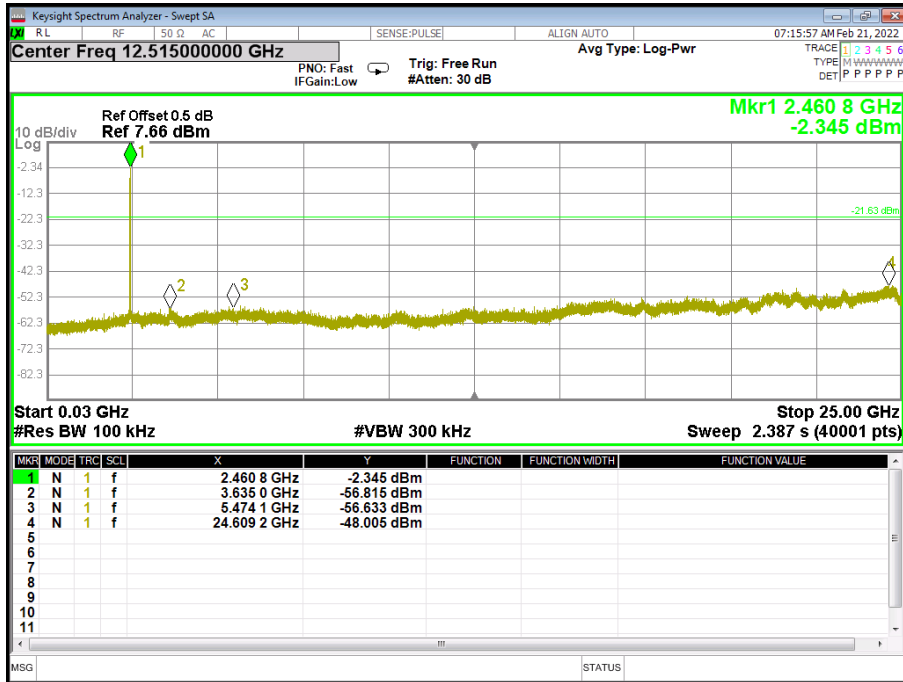



Band edge(it's also the reference level for conducted spurious emission)

CH 01

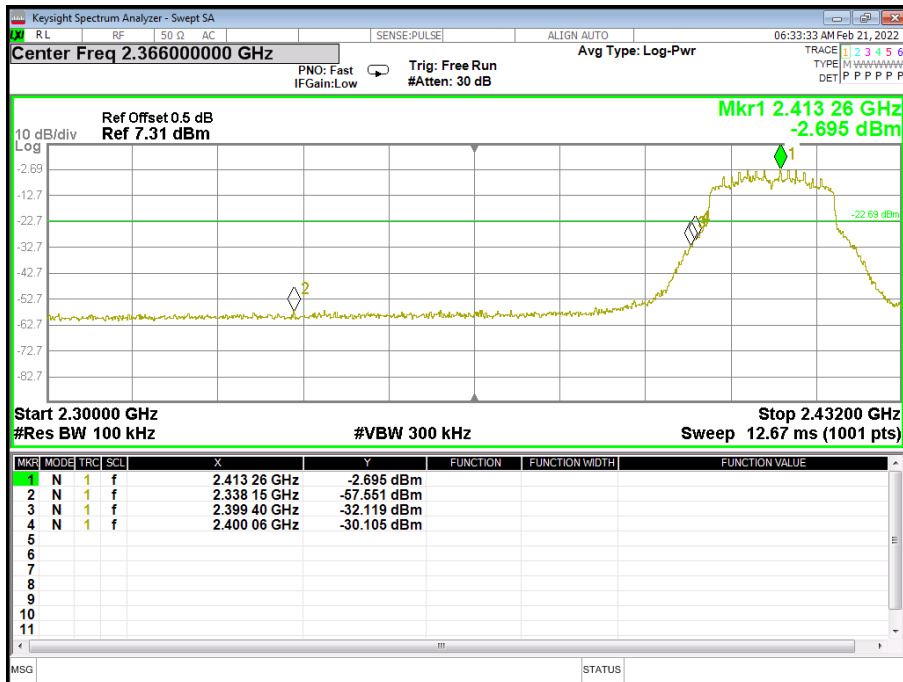

CH 06

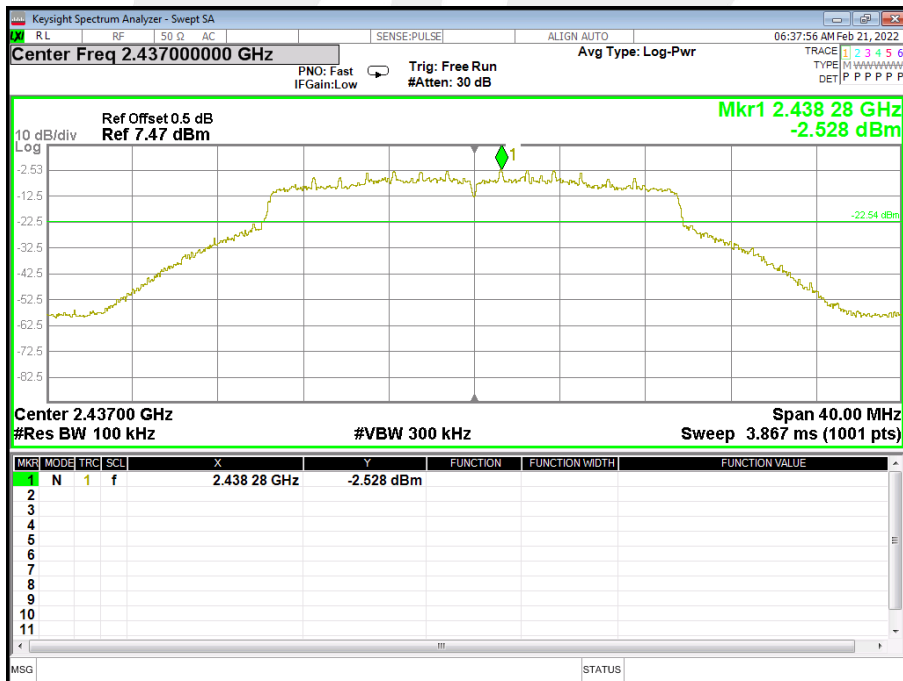



CH 11

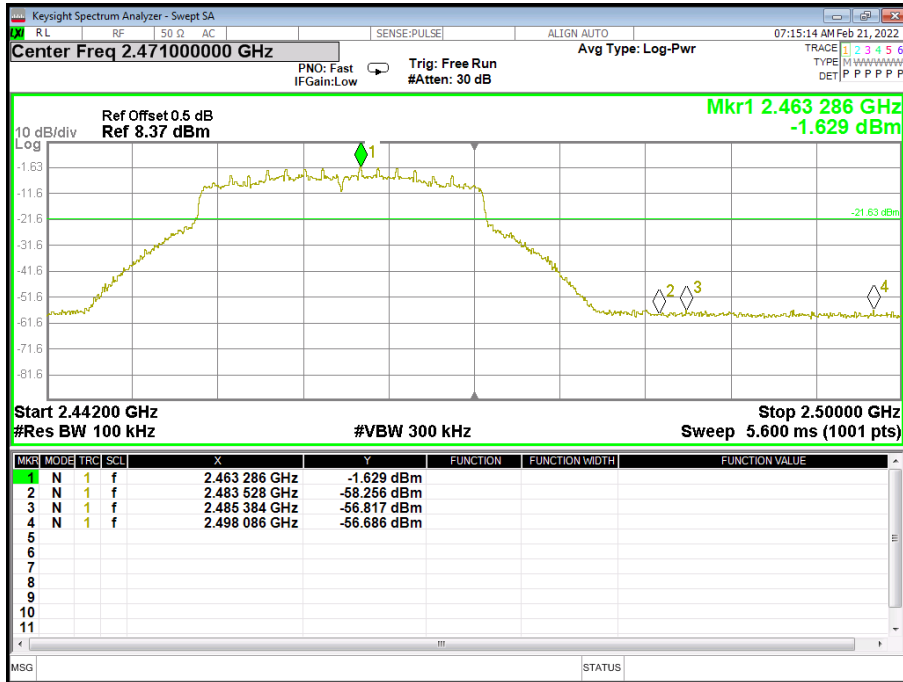



Temperature:	25°C	Relative Humidity:	60%
Test Voltage:	DC 10.8V	Test Mode:	TX n Mode(40M) /CH03, CH06, CH09

Antenna A

CH 03

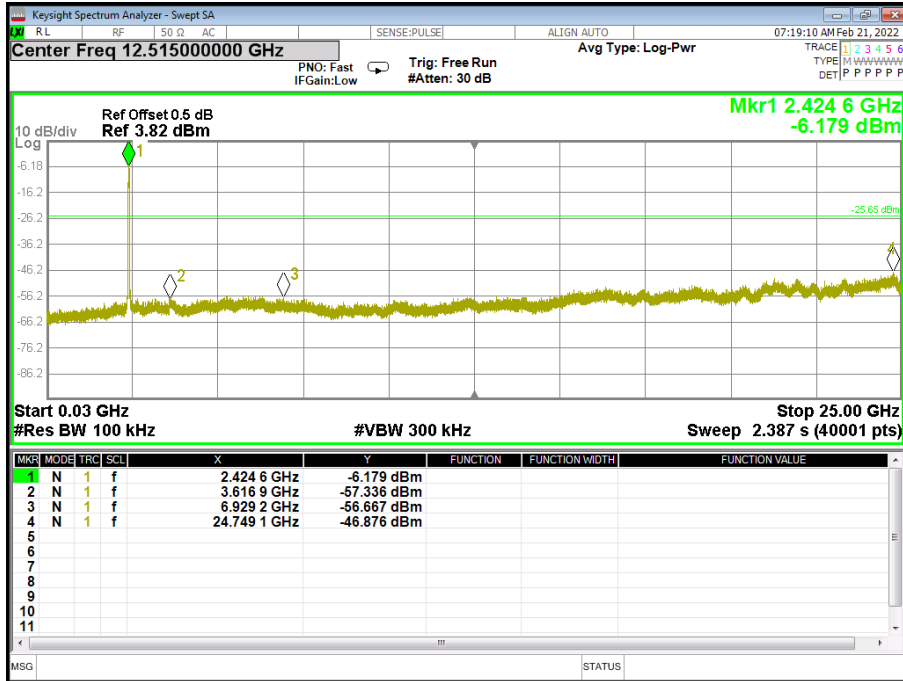



CH06

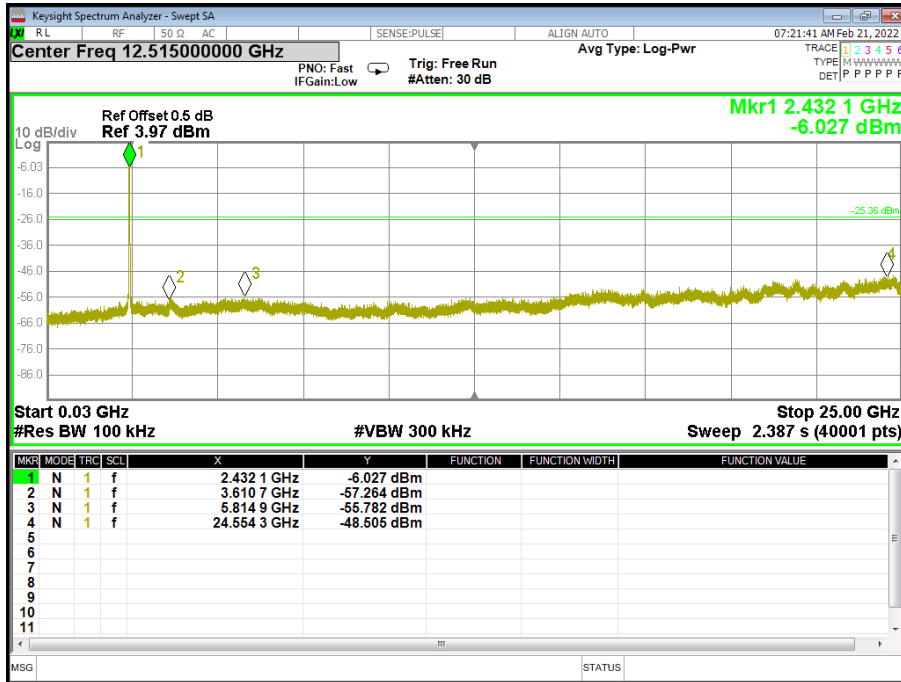

CH09

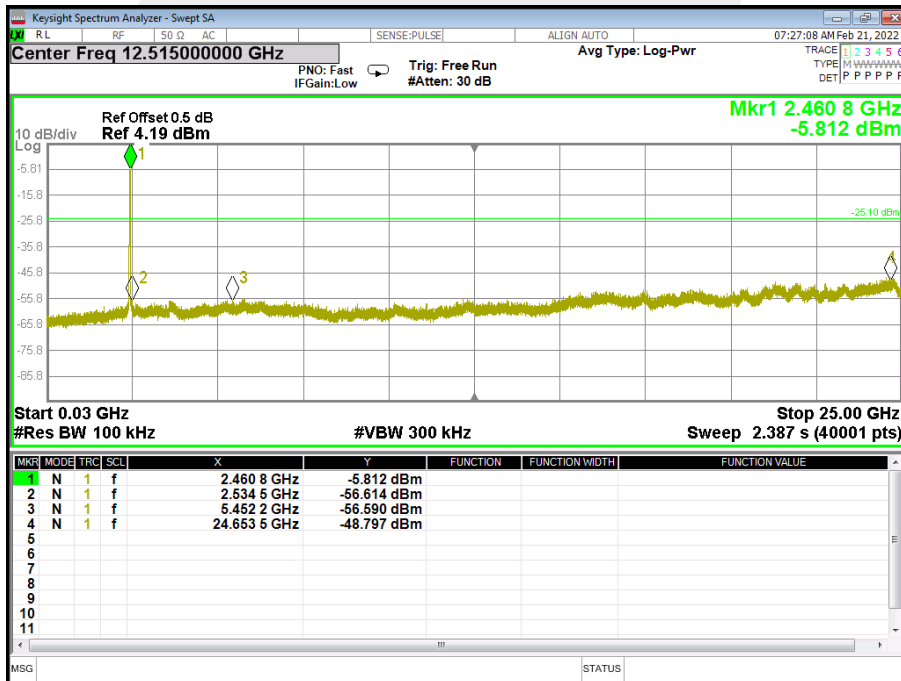



Band edge(it's also the reference level for conducted spurious emission)

CH03

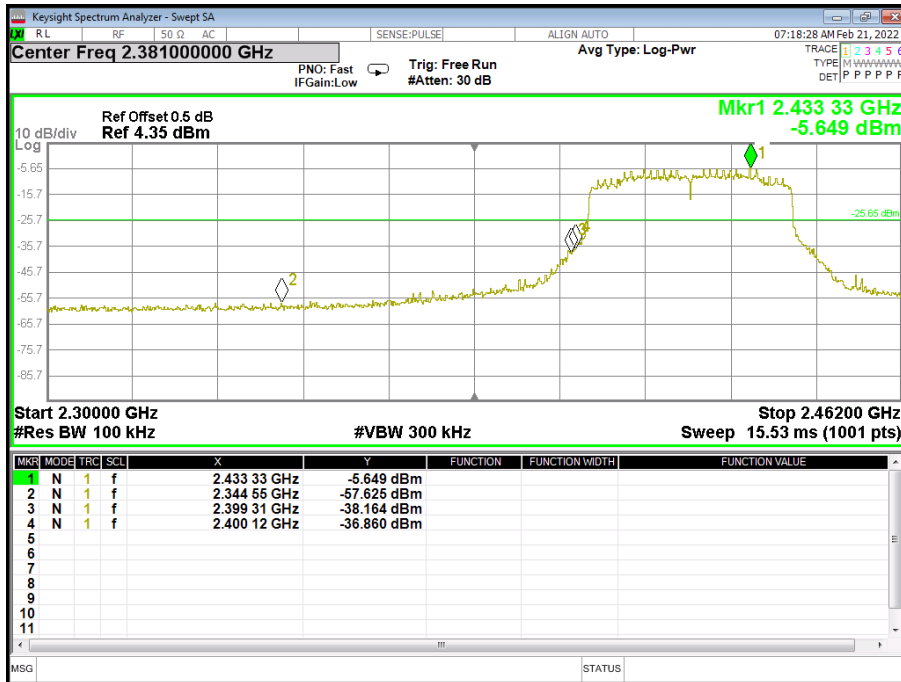

CH 06

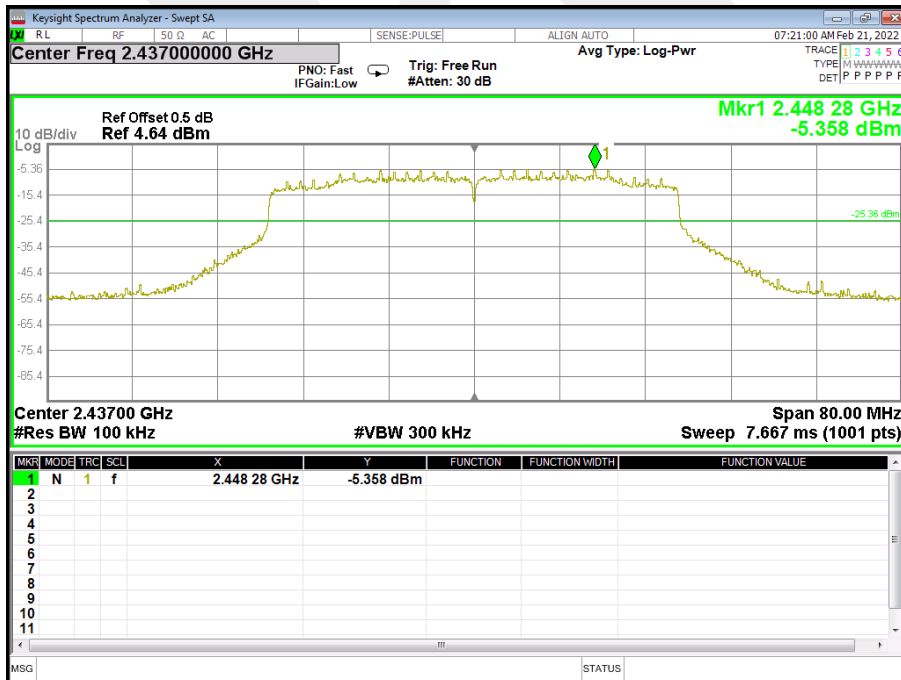



CH 09

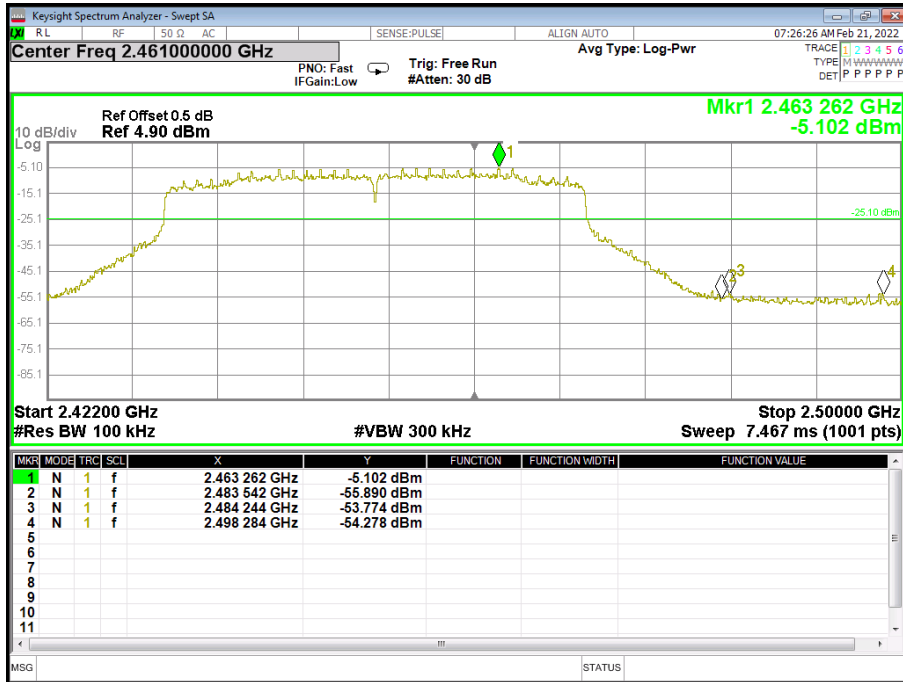

5. POWER SPECTRAL DENSITY TEST

5.1 LIMIT

FCC Part15.247 , Subpart C				
Section	Test Item	Limit	Frequency Range (MHz)	Result
15.247(e)	Power Spectral Density	≤8 dBm (RBW ≥3KHz)	2400-2483.5	PASS

5.2 TEST PROCEDURE

1. Set analyzer center frequency to DTS channel center frequency.
2. Set the span to 1.5 times the DTS channel bandwidth.
3. Set the 100 kHz ≥ RBW ≥ 3 kHz.
4. Set the VBW ≥ 3 x RBW.
5. Detector = peak.
6. Sweep time = auto couple.
7. Trace mode = max hold.
8. Allow trace to fully stabilize.
9. Use the peak marker function to determine the maximum amplitude level.
10. If measured value exceeds limit, reduce RBW (no less than 3 kHz) and repeat.

5.3 DEVIATION FROM STANDARD

No deviation.

5.4 TEST SETUP



5.5 EUT OPERATION CONDITIONS

Please refer to section 3.1.4 of this report.



5.6 TEST RESULTS

Temperature:	25°C	Relative Humidity:	60%
Test Voltage:	DC 10.8V	Test Mode:	TX b/g/n20/n40 Mode

Modulation	Frequency (MHz)	Power Density (dBm/3KHz)			Limit (dBm/3KHz)	Result
		Ant_A	Ant_B	Ant A+B		
802.11b	2412	-30.41	-14.85	N/A	8	PASS
	2437	-30.90	-14.99	N/A	8	PASS
	2462	-29.42	-14.96	N/A	8	PASS
802.11g	2412	-32.59	-17.11	N/A	8	PASS
	2437	-33.28	-16.85	N/A	8	PASS
	2462	-32.10	-16.75	N/A	8	PASS
802.11n(HT20)	2412	-19.66	-17.87	-15.66	8	PASS
	2437	-19.11	-17.72	-15.35	8	PASS
	2462	-16.84	-17.22	-14.01	8	PASS
802.11n(HT40)	2422	-21.45	-21.20	-18.31	8	PASS
	2437	-21.66	-20.63	-18.10	8	PASS
	2452	-21.91	-20.54	-18.16	8	PASS



Test plots for Ant A 802.11b TX CH01

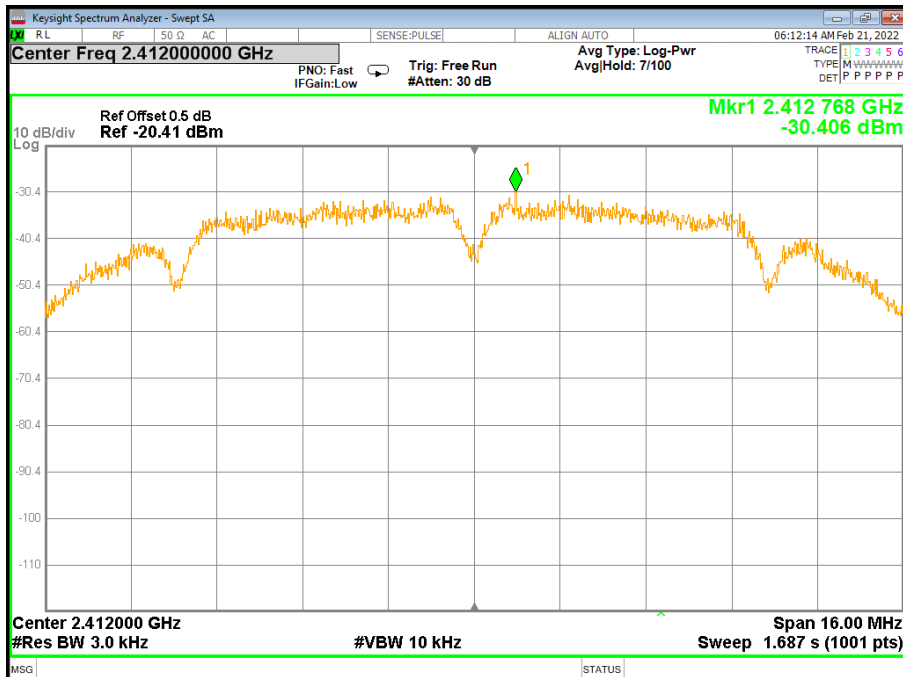

802.11b TX CH06

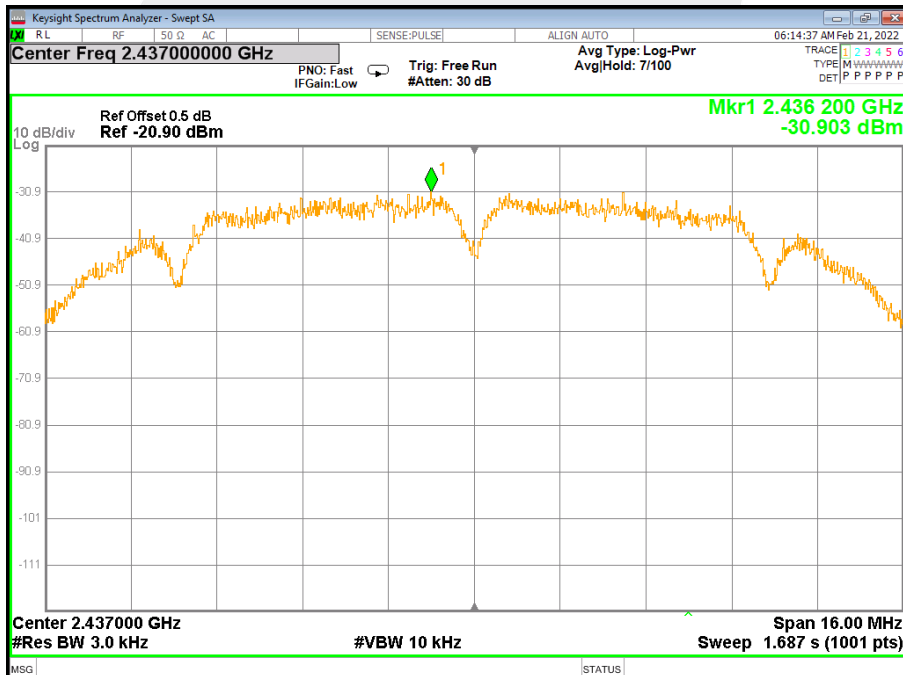



802.11b TX CH11

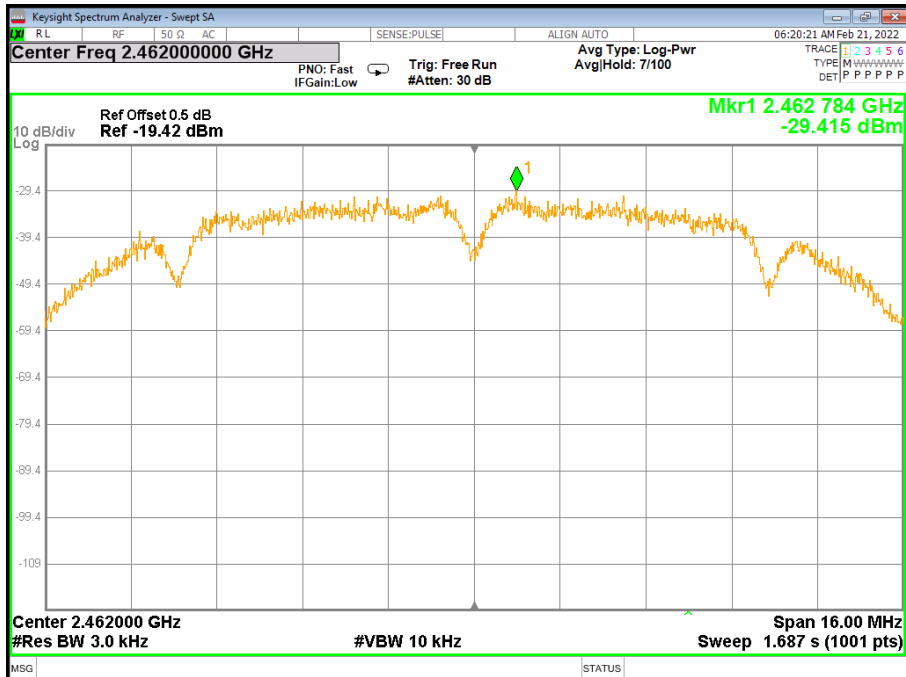

802.11g TX CH01

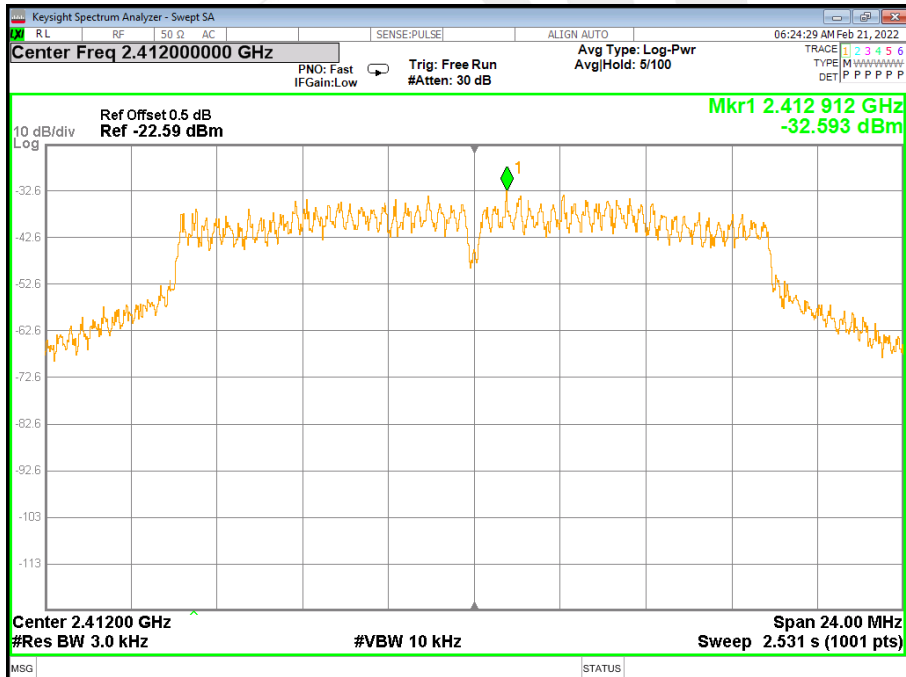



802.11g TX CH06

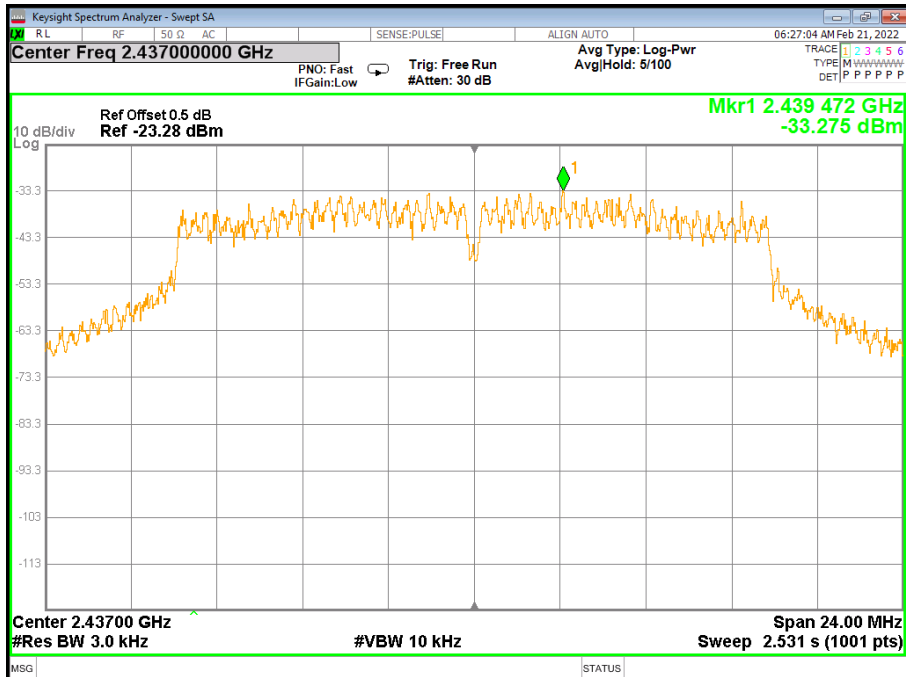

802.11g TX CH11

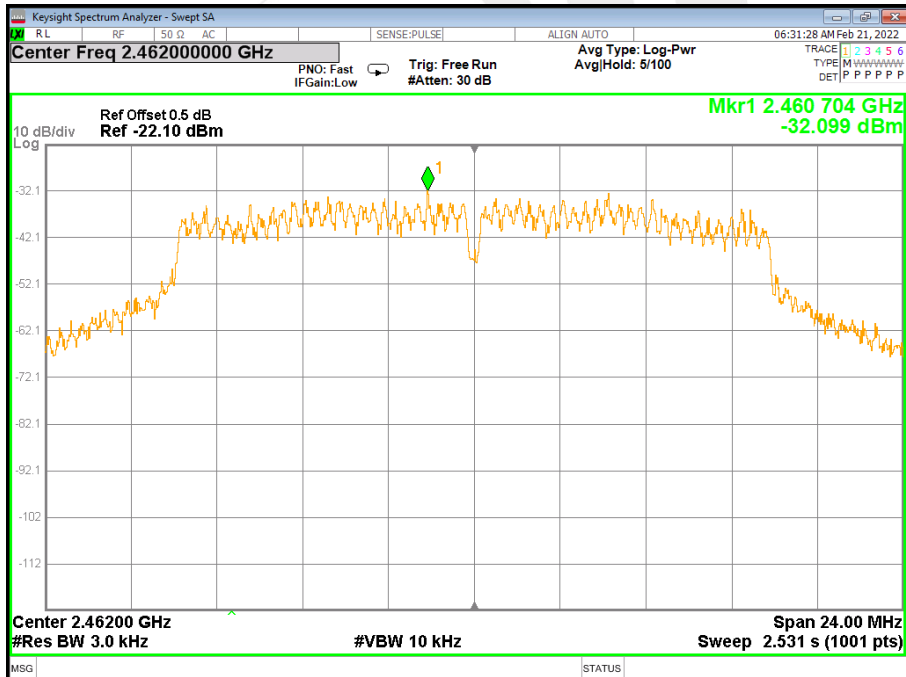



802.11n(HT20) TX CH01

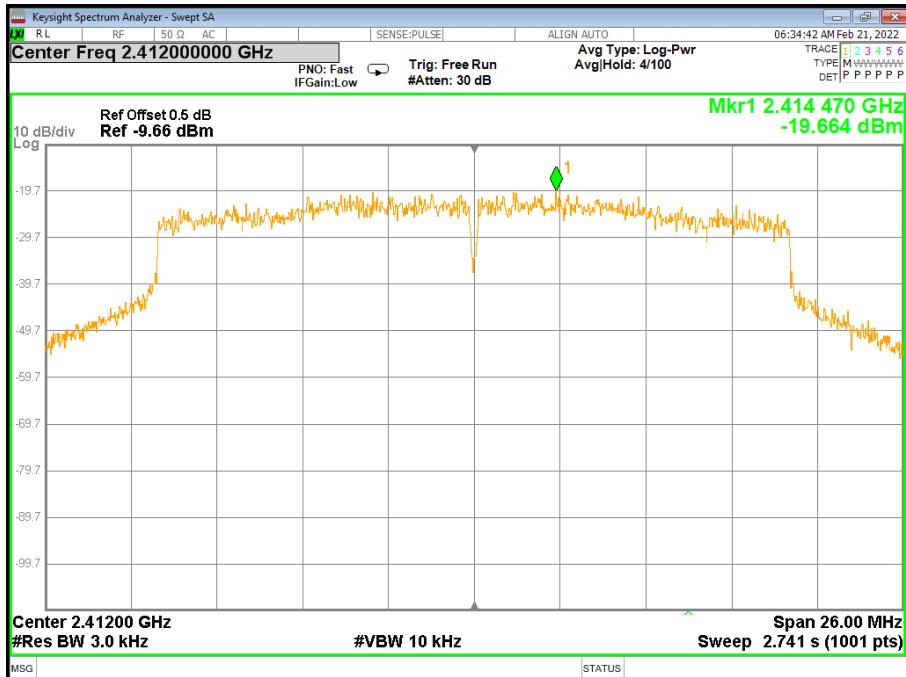

802.11n(HT20) TX CH06

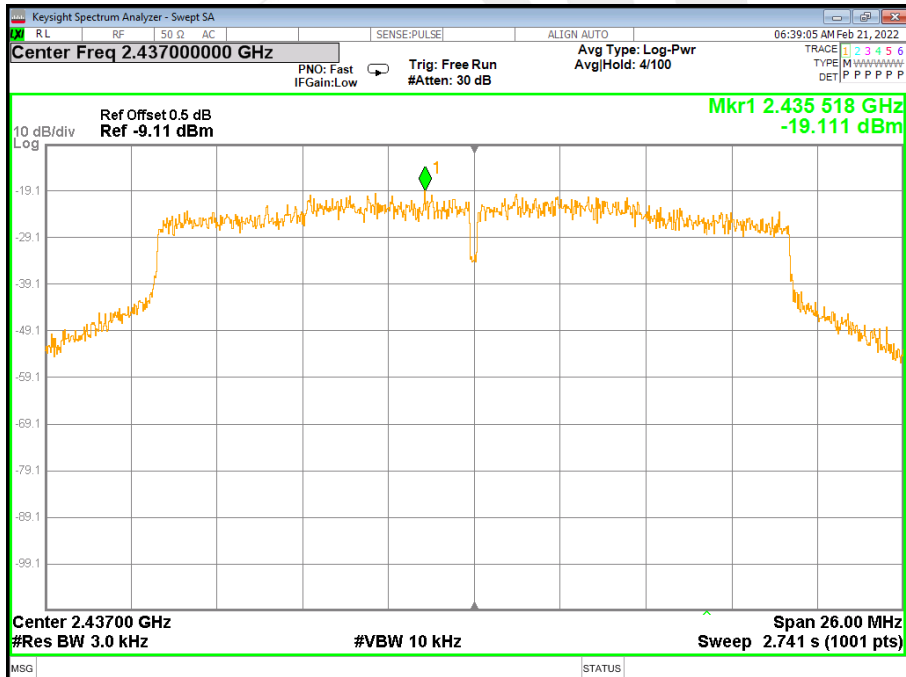



802.11n(HT20) TX CH11

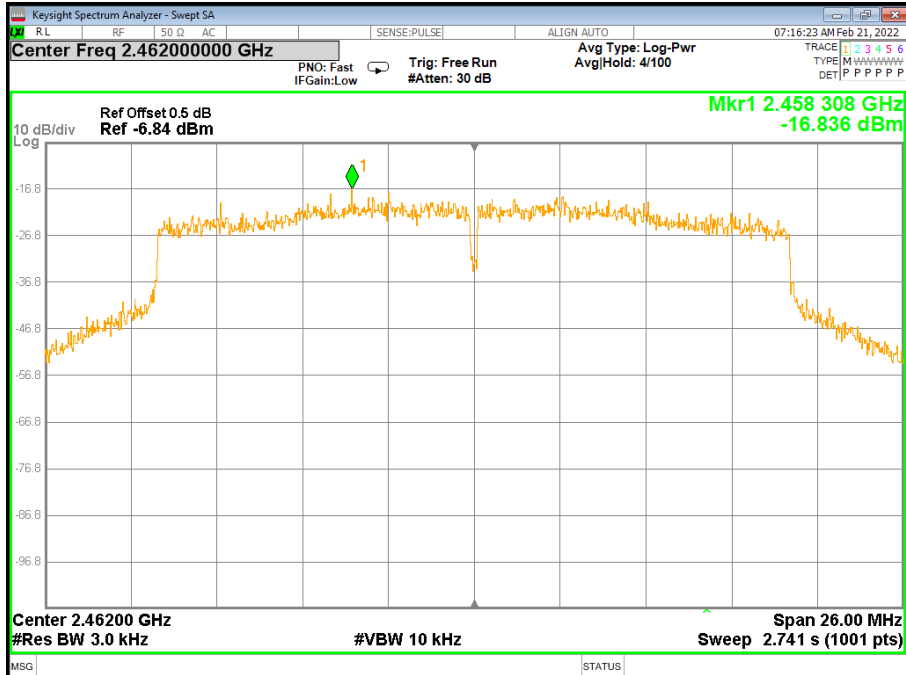

802.11n(HT40) TX CH03

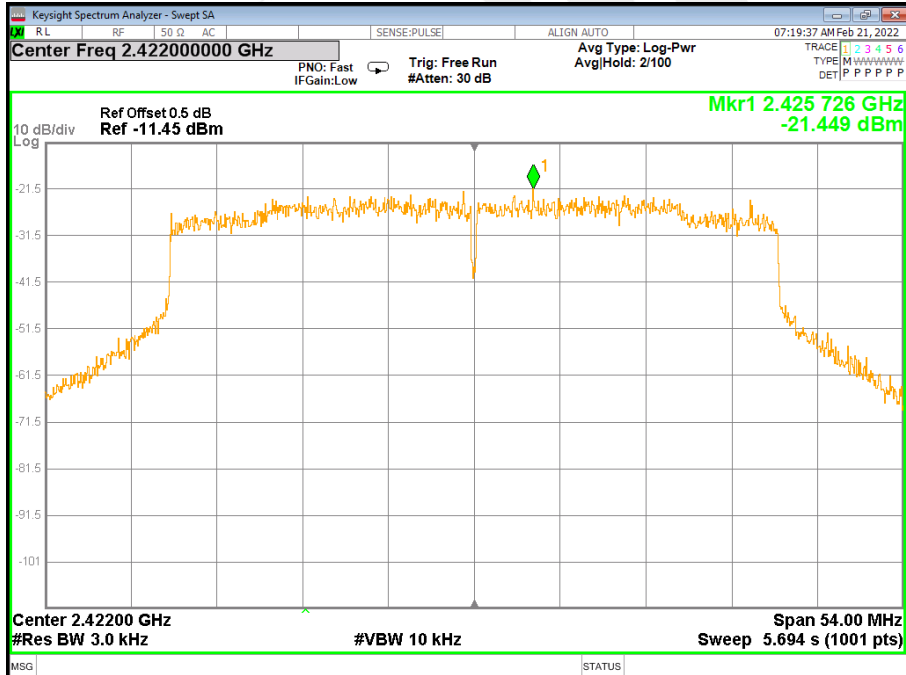



802.11n(HT40) TX CH06

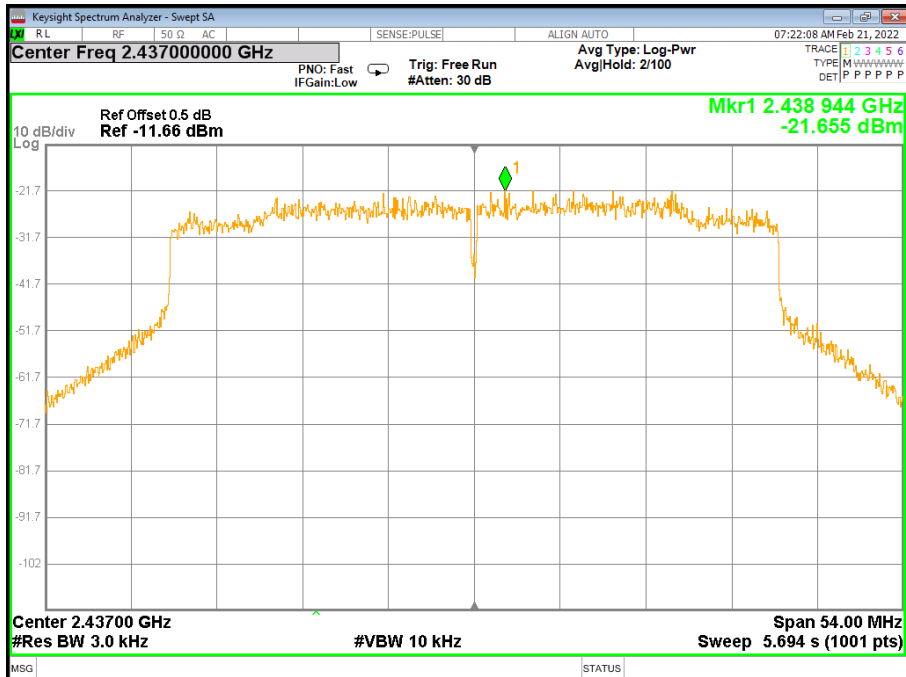

802.11n(HT40) TX CH09

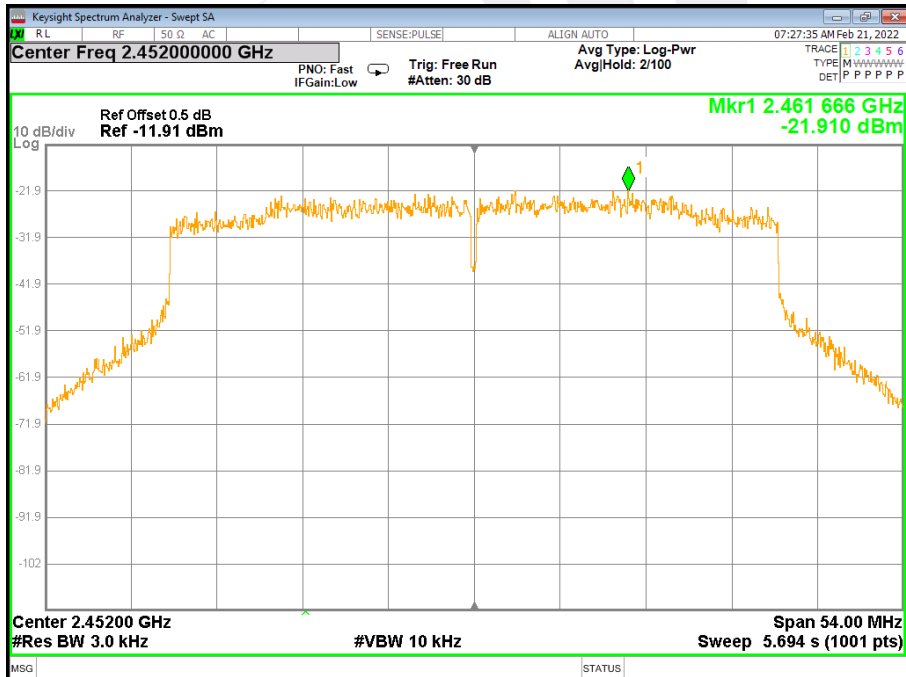



Test plots for Ant B 802.11b TX CH01

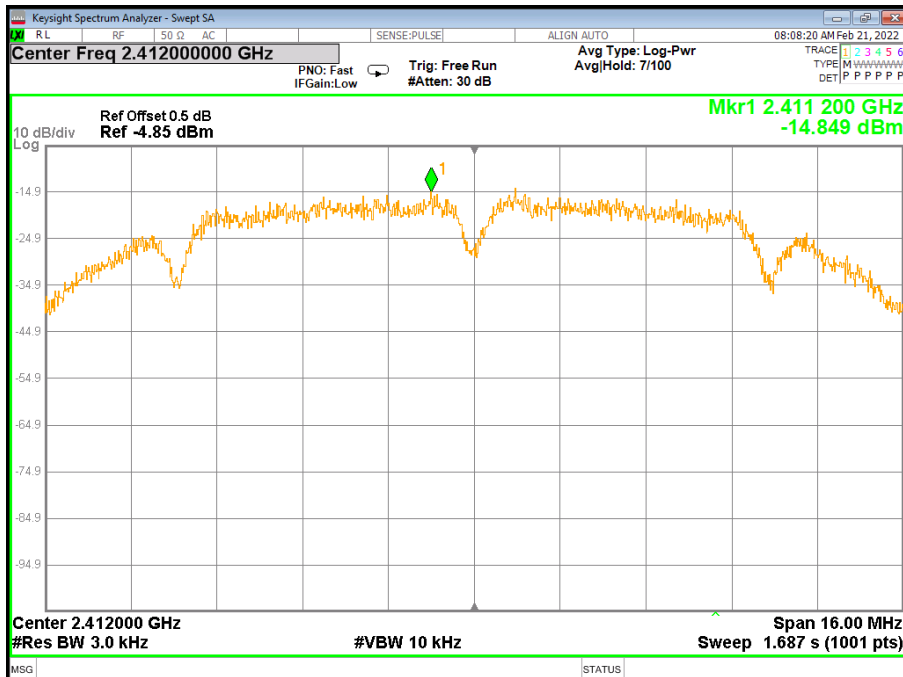

802.11b TX CH06

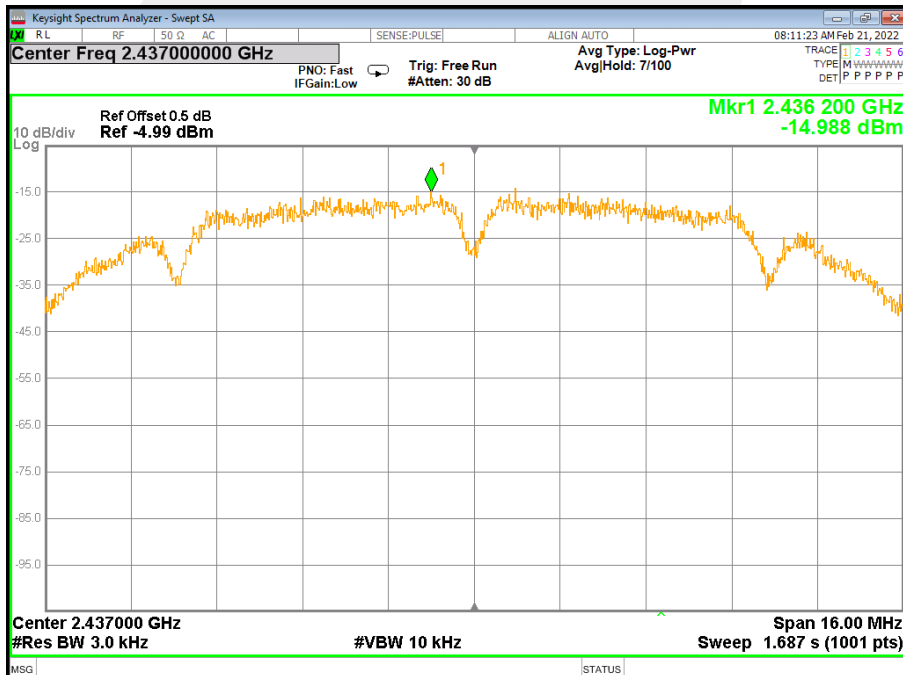



802.11b TX CH11

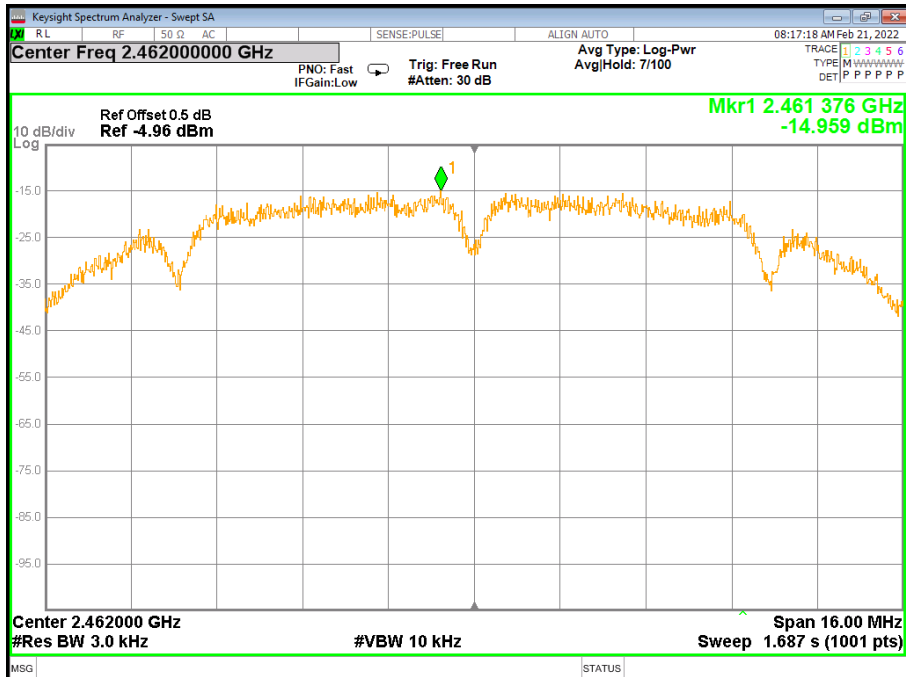

802.11g TX CH01

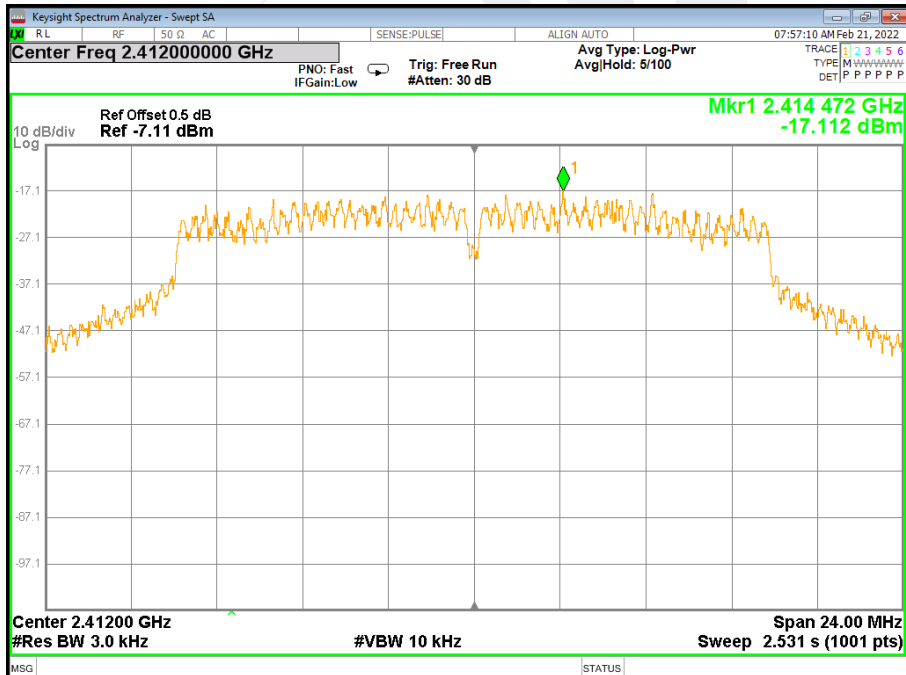



802.11g TX CH06

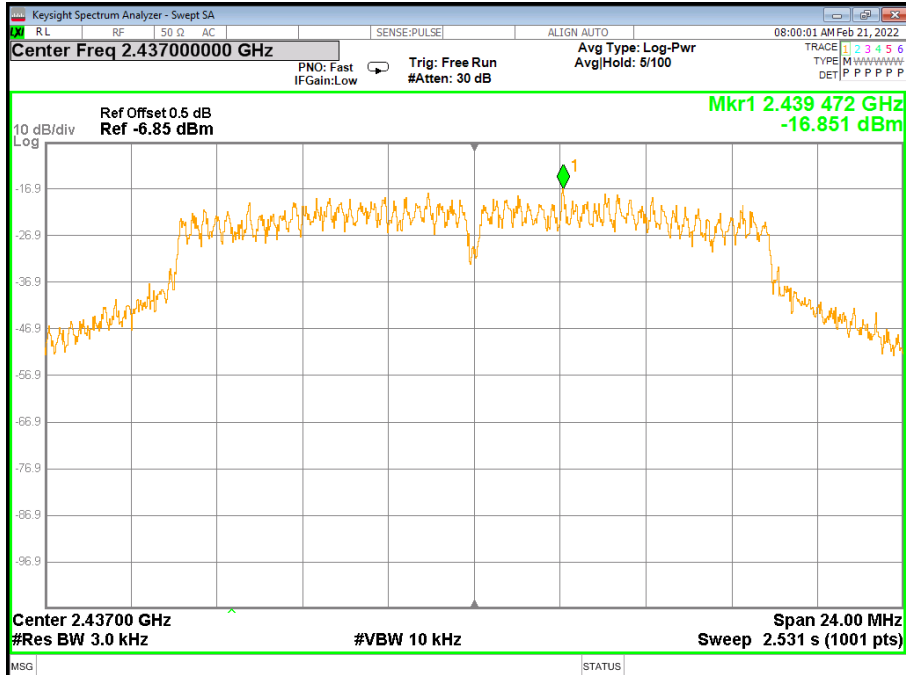

802.11g TX CH11

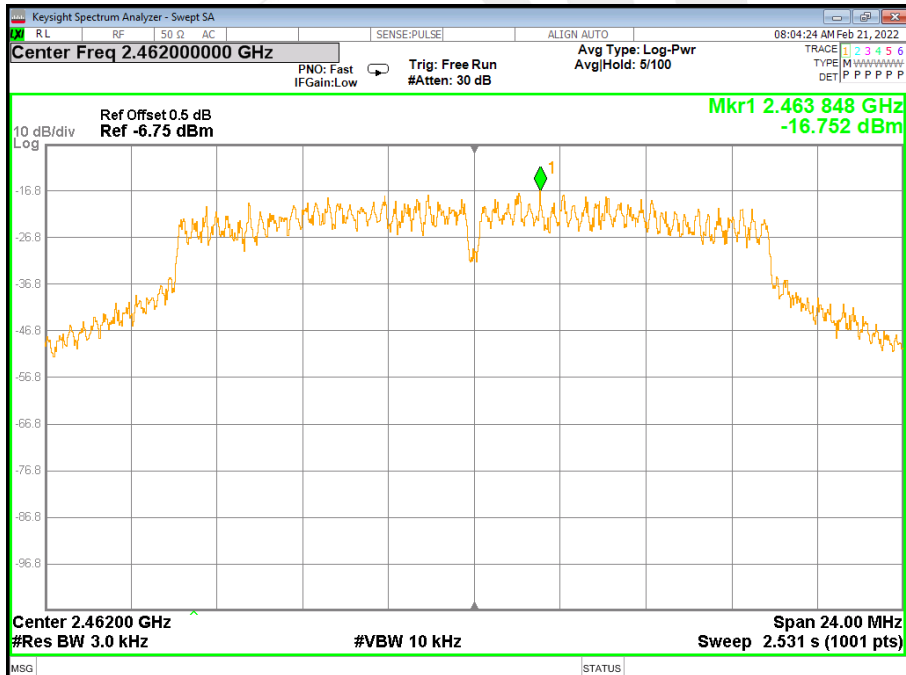



802.11n(HT20) TX CH01

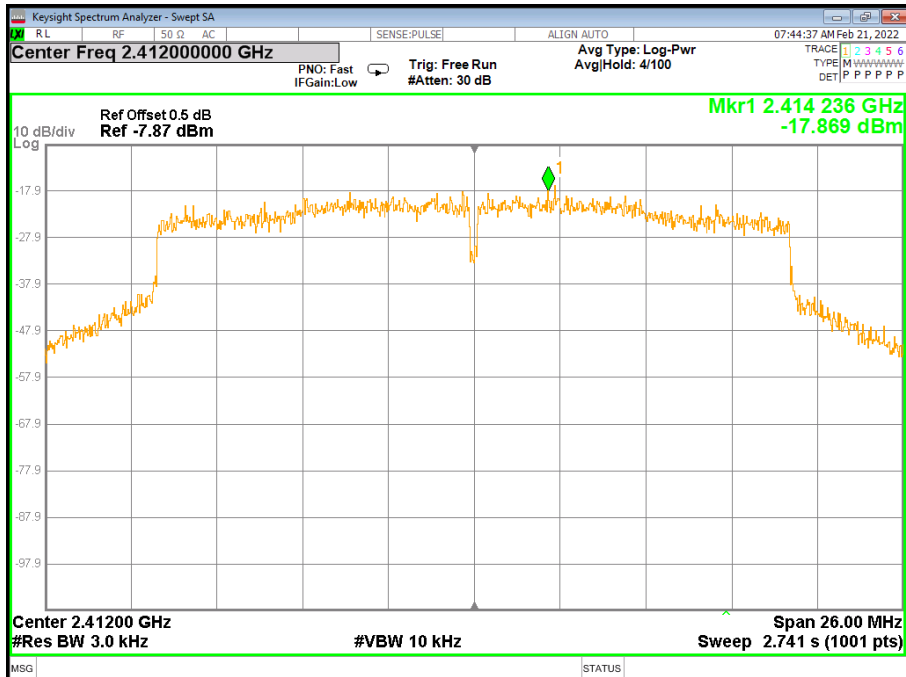

802.11n(HT20) TX CH06

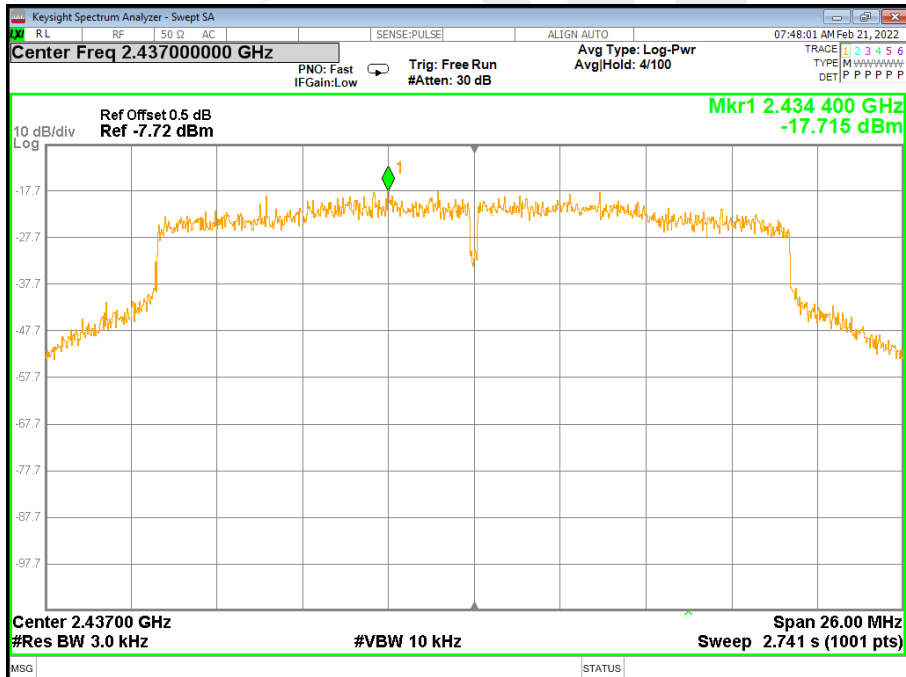



802.11n(HT20) TX CH11

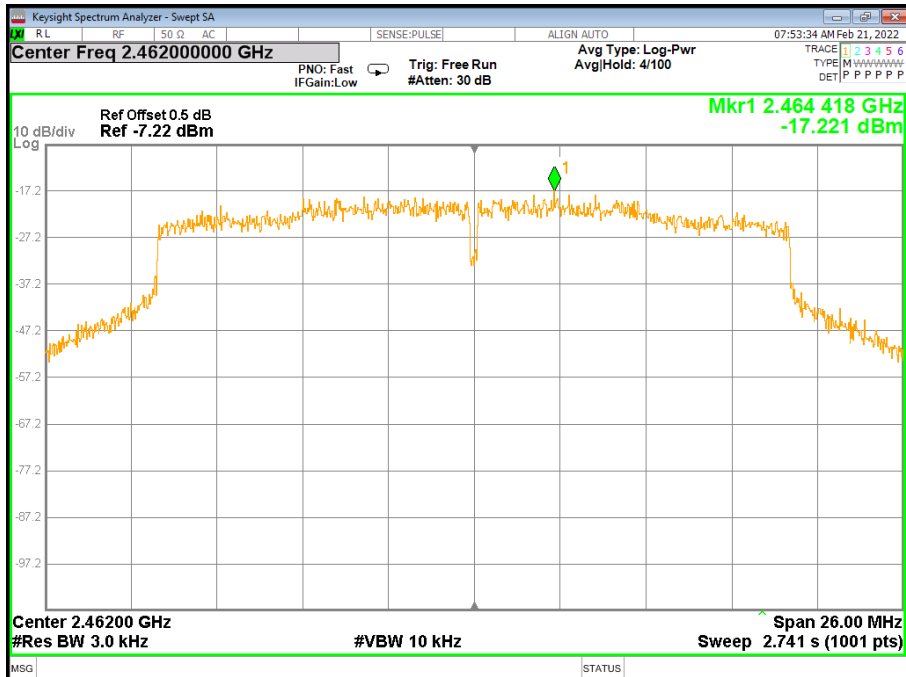

802.11n(HT40) TX CH03

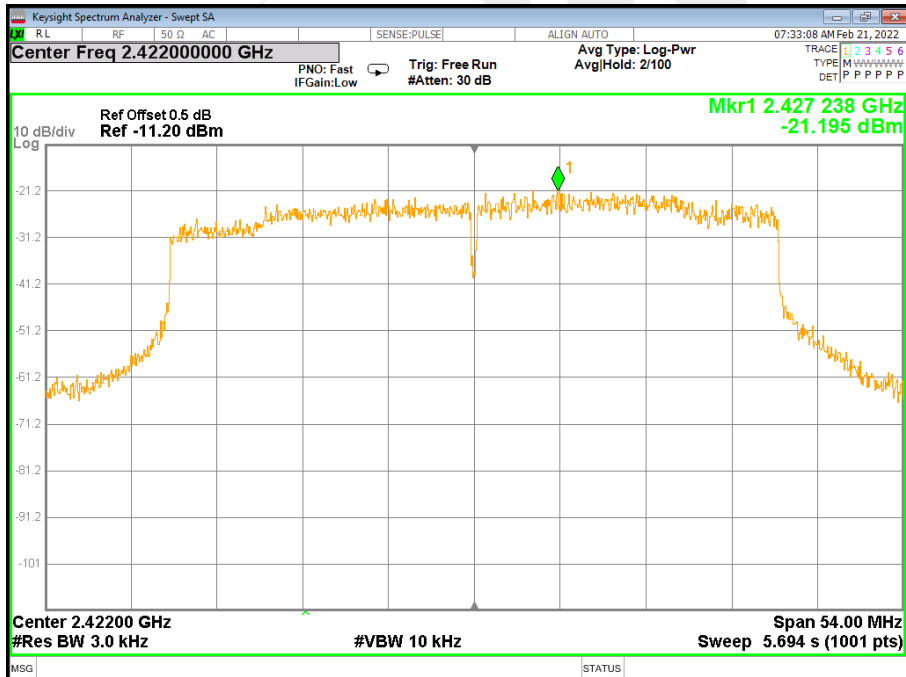



802.11n(HT40) TX CH06

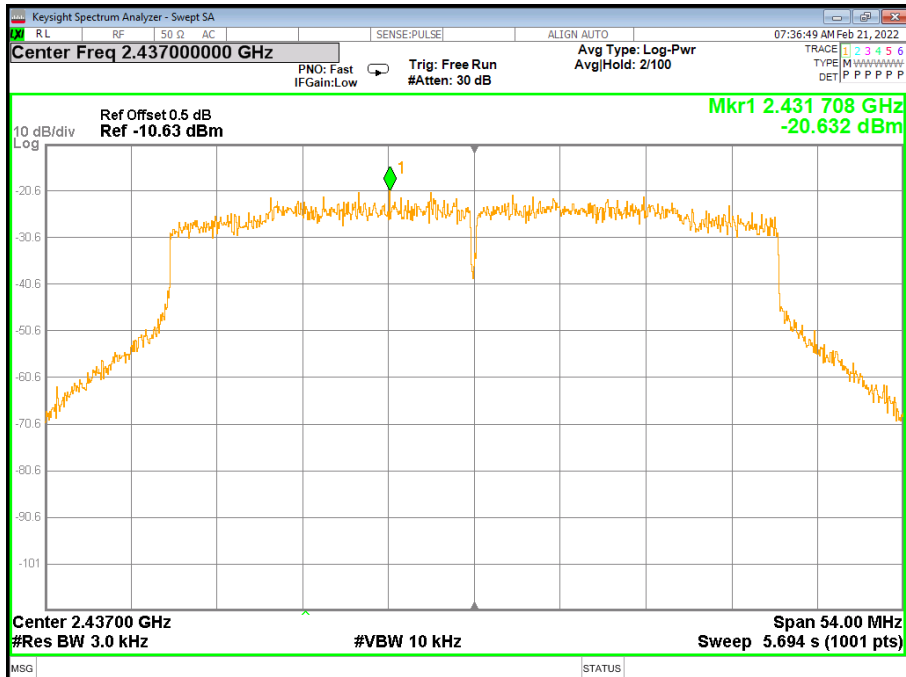

802.11n(HT40) TX CH09

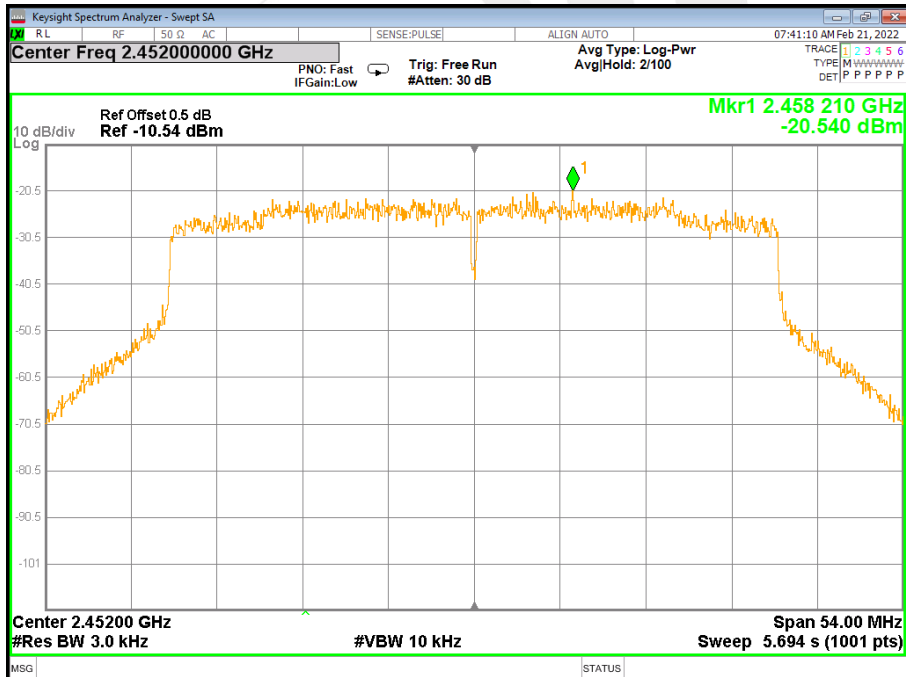

6. BANDWIDTH TEST

6.1 LIMIT

FCC PART15.247,SUBPART C				
Section	Test Item	Limit	Frequency Range (MHz)	Result
15.247(a)(2)	Bandwidth	≥500KHz (6dB bandwidth)	2400-2483.5	PASS

6.2 TEST PROCEDURE

The automatic bandwidth measurement capability of an instrument may be employed using the X dB bandwidth mode with X set to 6 dB, if the functionality described above (i.e., RBW = 100 kHz, VBW≥3RBW, peak detector with maximum hold) is implemented by the instrumentation function. When using this capability, care shall be taken so that the bandwidth measurement is not influenced by any intermediate power nulls in the fundamental emission that might be ≥6 dB.

6.3 DEVIATION FROM STANDARD

No deviation.

6.4 TEST SETUP



6.5 EUT OPERATION CONDITIONS

Please refer to section 3.1.4 of this report.



6.6 TEST RESULTS

Note: Antenna A Power > Antenna B Power, Both antenna A and B have been test, Only show the worst data of Antenna A

Temperature:	25°C	Relative Humidity:	60%
Test Voltage:	DC 10.8V	Test Mode:	TX b/g/n20/n40 Mode

Remark: PEAK DETECTOR IS USED

Modulation	Frequency (MHz)	-6 dB Bandwidth (MHz)	Limit (KHz)	Result
802.11b	2412	10.100	500	PASS
	2437	10.100	500	PASS
	2462	10.100	500	PASS
802.11g	2412	15.13	500	PASS
	2437	15.12	500	PASS
	2462	15.13	500	PASS
802.11n(HT20)	2412	15.13	500	PASS
	2437	15.93	500	PASS
	2462	15.13	500	PASS
802.11n(HT40)	2422	35.11	500	PASS
	2437	35.11	500	PASS
	2452	35.09	500	PASS



Antenna A

6 dB Bandwidth TX CH 01

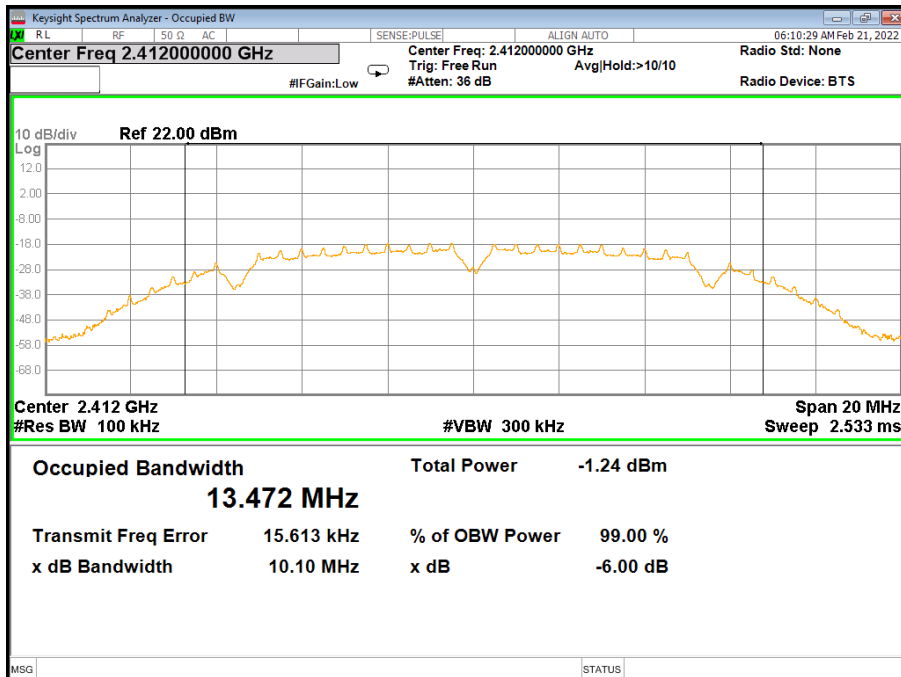

6 dB Bandwidth TX CH 06

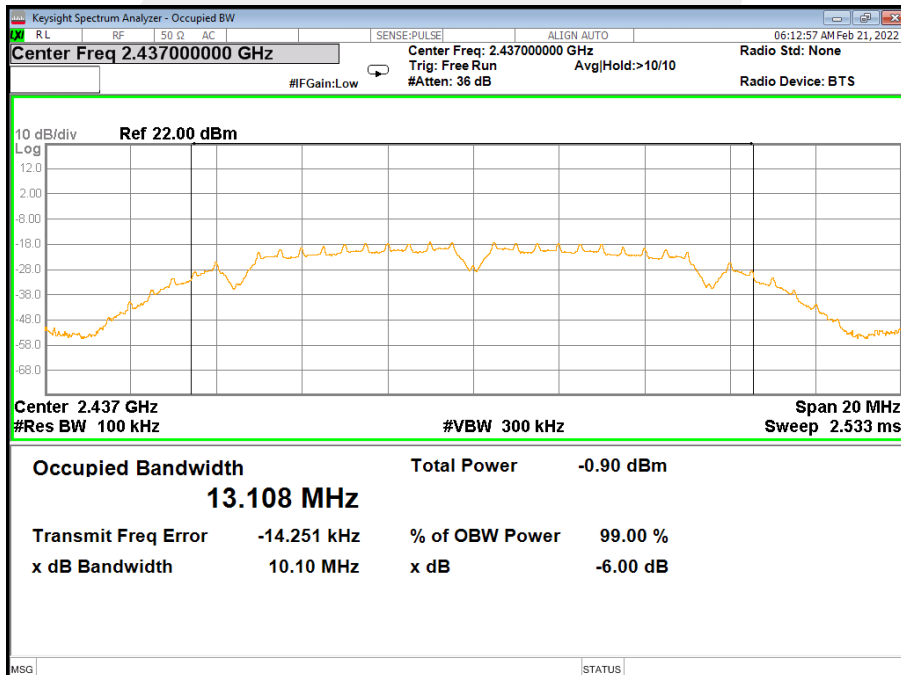



6 dB Bandwidth TX CH 11

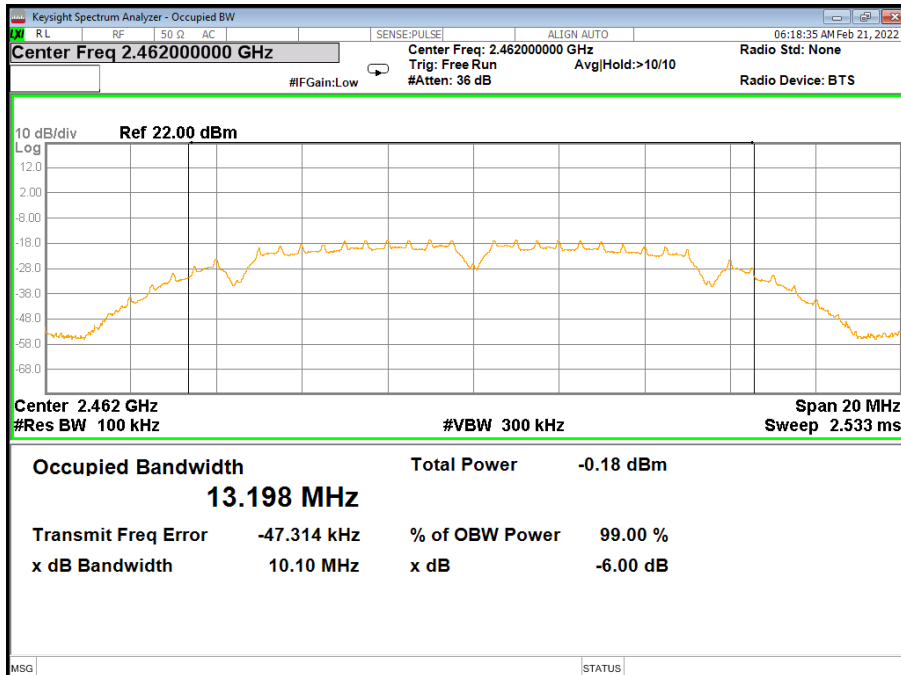

6 dB Bandwidth TX CH 01

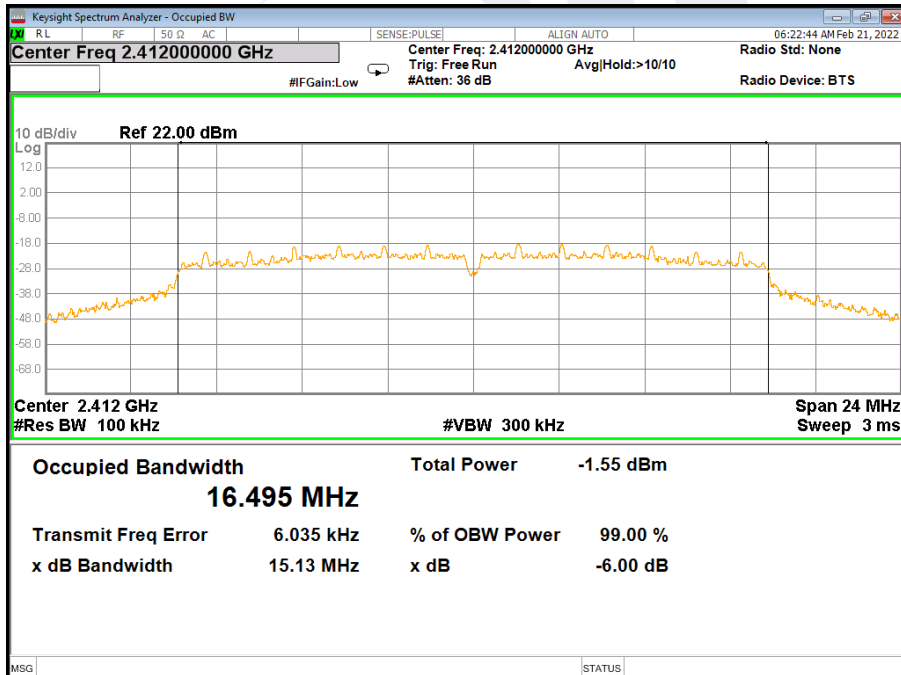



6 dB Bandwidth TX CH 06

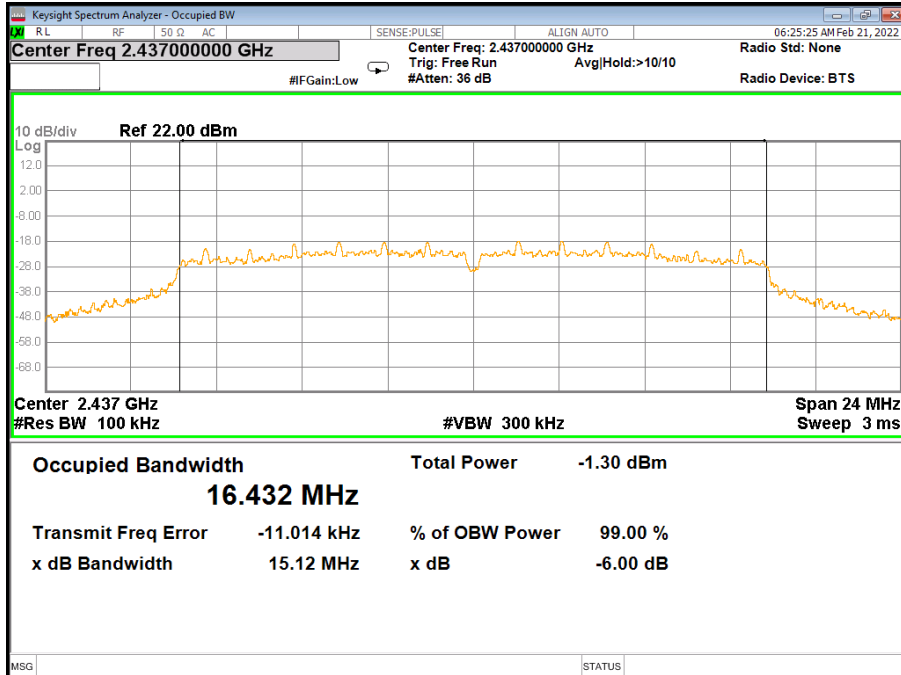

6 dB Bandwidth TX CH 11

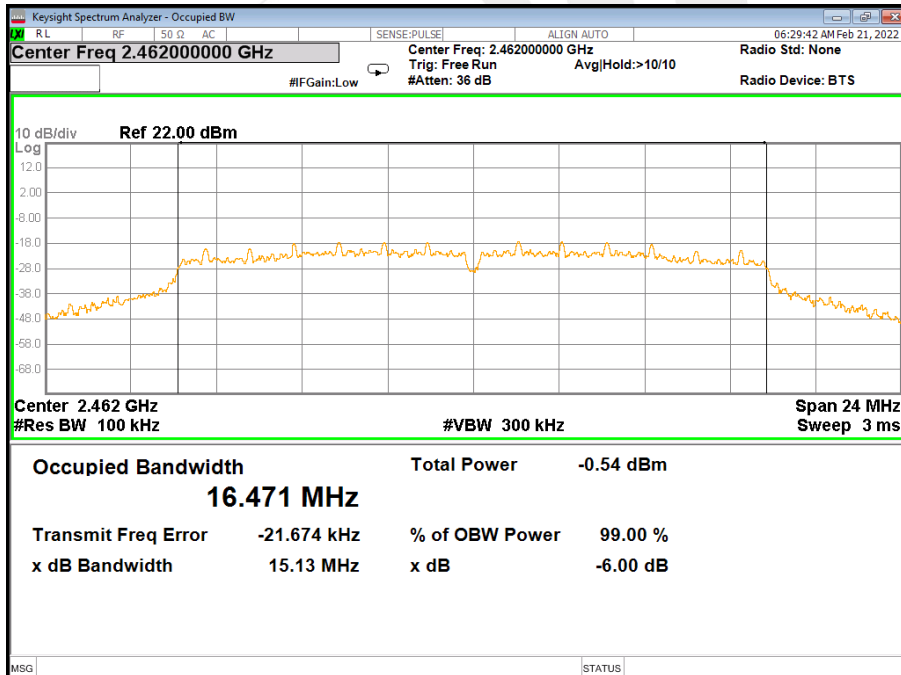



6 dB Bandwidth TX CH 01

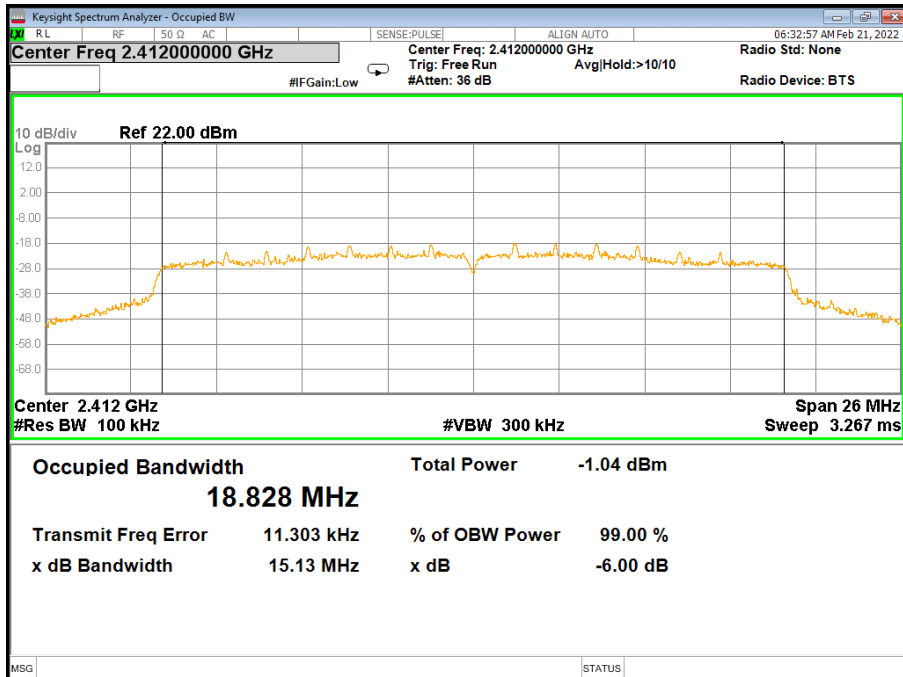

6 dB Bandwidth TX CH 06

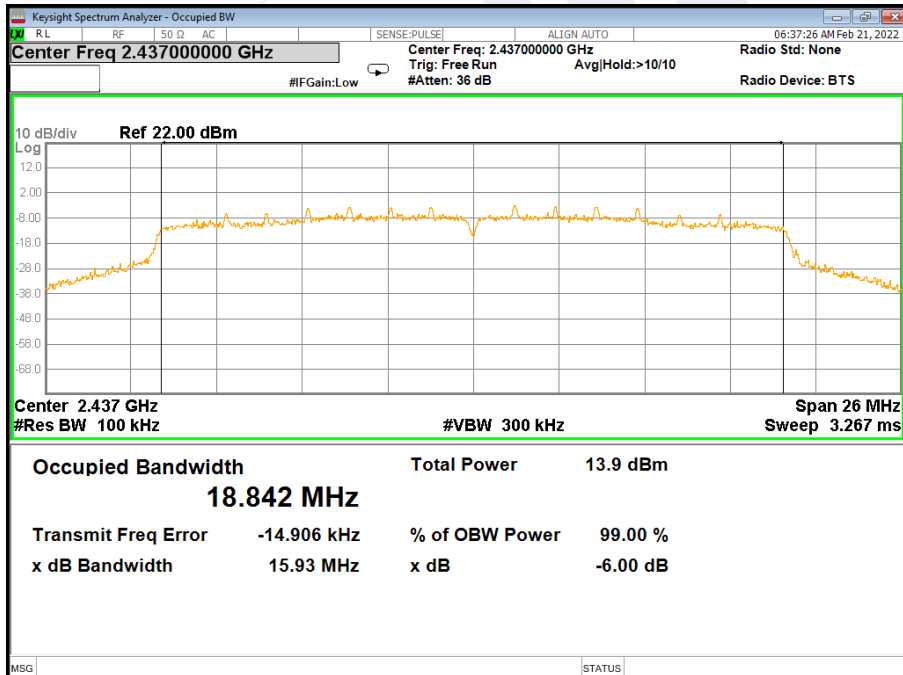



6 dB Bandwidth TX CH 11

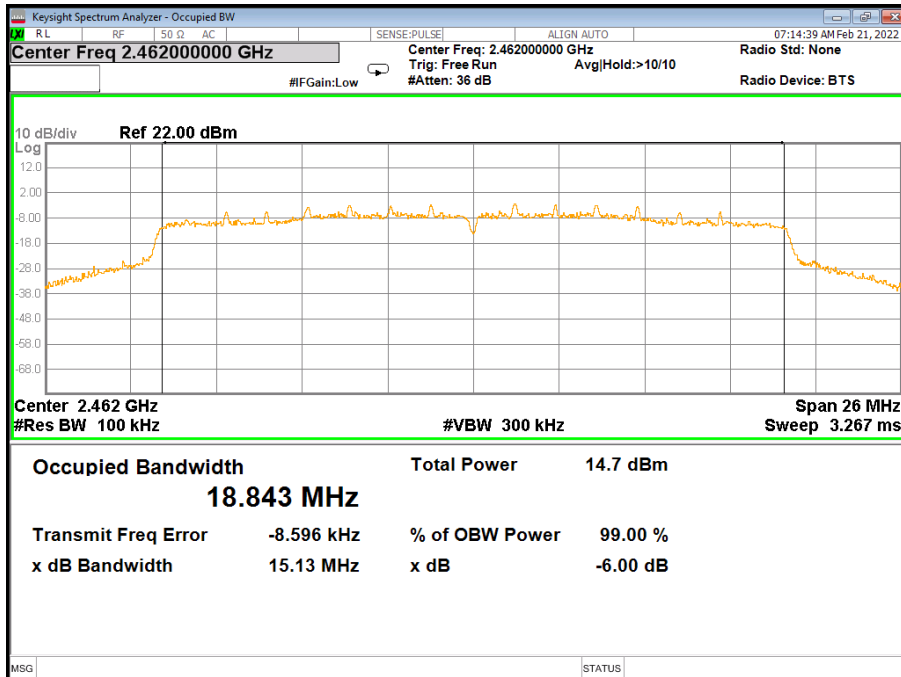

6 dB Bandwidth TX CH 03

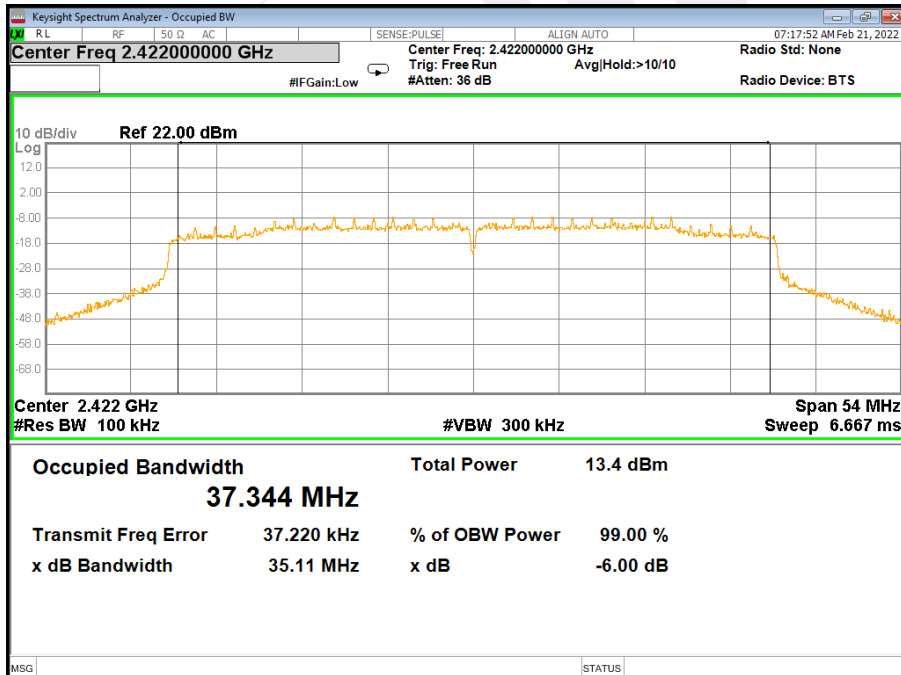



6 dB Bandwidth TX CH 06

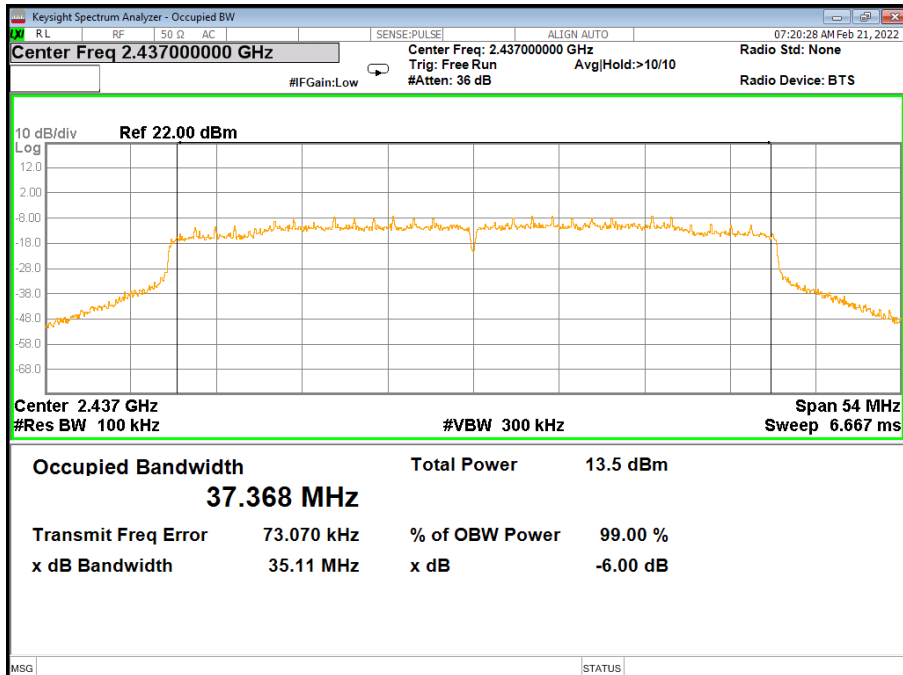

6 dB Bandwidth TX CH 09

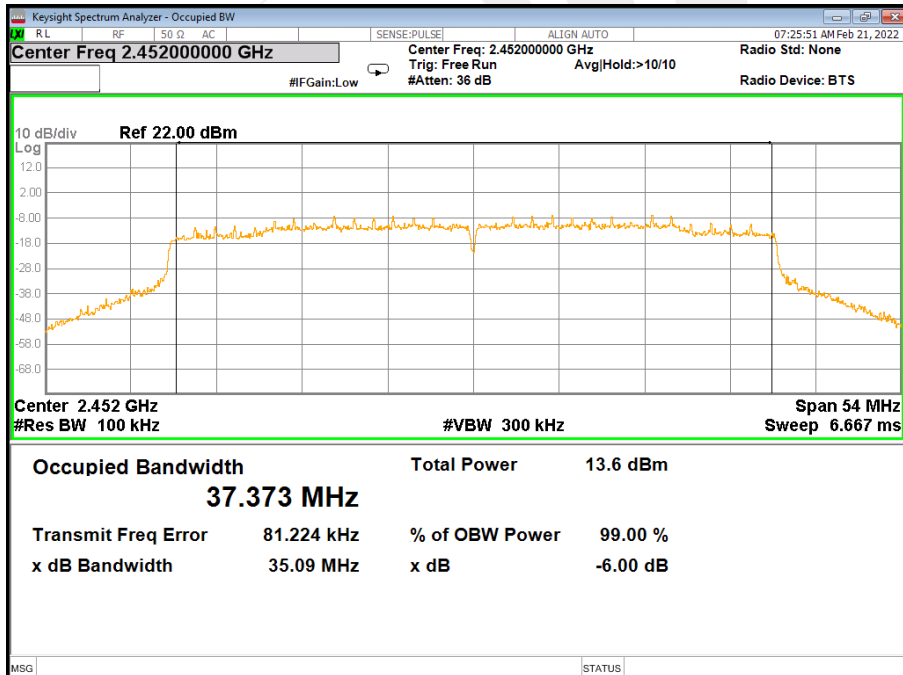



7. PEAK OUTPUT POWER TEST

7.1 LIMIT

FCC PART15.247,SUBPART C				
Section	Test Item	Limit	Frequency Range (MHz)	Result
15.247(b)(3)	Output Power	1 watt or 30dBm	2400-2483.5	PASS

7.2 TEST PROCEDURE

One of the following procedures may be used to determine the maximum peak conducted output power of a DTS EUT.

RBW ≥ DTS bandwidth

The following procedure shall be used when an instrument with a resolution bandwidth that is greater than the DTS bandwidth is available to perform the measurement:

- a) Set the RBW ≥ DTS bandwidth.
- b) Set VBW ≥ [3 × RBW].
- c) Set span ≥ [3 × RBW].
- d) Sweep time = auto couple.
- e) Detector = peak.
- f) Trace mode = max hold.
- g) Allow trace to fully stabilize.
- h) Use peak marker function to determine the peak amplitude level.

Integrated band power method:

The following procedure can be used when the maximum available RBW of the instrument is less than the

DTS bandwidth:

- a) Set the RBW = 1 MHz.
- b) Set the VBW ≥ [3 × RBW].
- c) Set the span ≥ [1.5 × DTS bandwidth].
- d) Detector = peak.
- e) Sweep time = auto couple.
- f) Trace mode = max hold.
- g) Allow trace to fully stabilize.
- h) Use the instrument's band/channel power measurement function with the band limits set equal to the DTS bandwidth edges (for some instruments, this may require a manual override to select the peak detector). If the instrument does not have a band power function, then sum the spectrum levels (in linear power units) at intervals equal to the RBW extending across the DTS channel bandwidth.

PKPM1 Peak power meter method:

The maximum peak conducted output power may be measured using a broadband peak RF power meter. The power meter shall have a video bandwidth that is greater than or equal to the DTS bandwidth and shall use a fast-responding diode detector.

7.3 DEVIATION FROM STANDARD

No deviation.

7.4 TEST SETUP

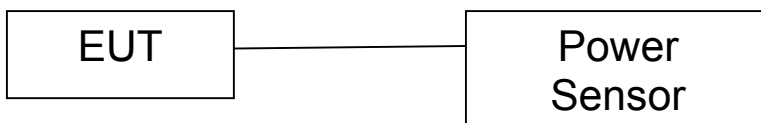

7.5 EUT OPERATION CONDITIONS

Please refer to section 3.1.4 of this report.



7.6 TEST RESULTS

Temperature:	25°C	Relative Humidity:	60%
Test Voltage:	DC 10.8V		

Modulation	Frequency (MHz)	Ant_A Peak Output Power (dBm)	Ant_B Peak Output Power (dBm)	ANT A+B Peak Output Power (dBm)	Ant_A Average Reading Power (dBm)	Ant_B Average Reading Power (dBm)	Duty Cycle Factor (dB)	Ant_A Final Average Output Power (dBm)	Ant_B Final Average Output Power (dBm)	Ant_A+B Final Average Output Power (dBm)	Limit (dBm)	Result
802.11b	2412	12.57	12.14	N/A	9.67	10.07	0.00	9.67	10.07	N/A	30	Pass
	2437	12.26	12.69	N/A	9.74	10.17	0.00	9.74	10.17	N/A	30	Pass
	2462	12.32	12.66	N/A	9.71	10.20	0.00	9.71	10.20	N/A	30	Pass
802.11g	2412	13.94	14.27	N/A	7.99	8.34	1.11	9.10	9.45	N/A	30	Pass
	2437	14.87	14.25	N/A	8.03	8.48	1.11	9.14	9.59	N/A	30	Pass
	2462	14.95	14.16	N/A	8.05	8.40	1.11	9.16	9.51	N/A	30	Pass
802.11n(HT20)	2412	14.41	14.31	17.37	8.42	8.69	0.30	8.72	8.99	11.87	30	Pass
	2437	14.30	14.28	17.30	8.40	8.80	0.30	8.70	9.10	11.92	30	Pass
	2462	14.29	14.20	17.26	8.39	8.69	0.30	8.69	8.99	11.85	30	Pass
802.11n(HT40)	2422	14.59	14.64	17.63	8.05	8.28	0.60	8.65	8.88	11.78	30	Pass
	2437	15.58	14.71	18.18	8.06	8.23	0.60	8.66	8.83	11.76	30	Pass
	2452	15.51	14.78	18.17	7.99	8.27	0.60	8.59	8.87	11.74	30	Pass



Duty cycle

Modulation	Frequency (MHz)	TOn (ms)	TP (ms)	Duty cycle (%)	Duty Cycle Factor (dB)
802.11b	2437	8.4000	8.4050	99.94%	0.00
802.11g	2437	0.1515	0.1955	77.49%	1.11
802.11n(HT20)	2437	0.4872	0.5222	93.30%	0.30
802.11n(HT40)	2437	0.2893	0.3323	87.06%	0.60

802.11b

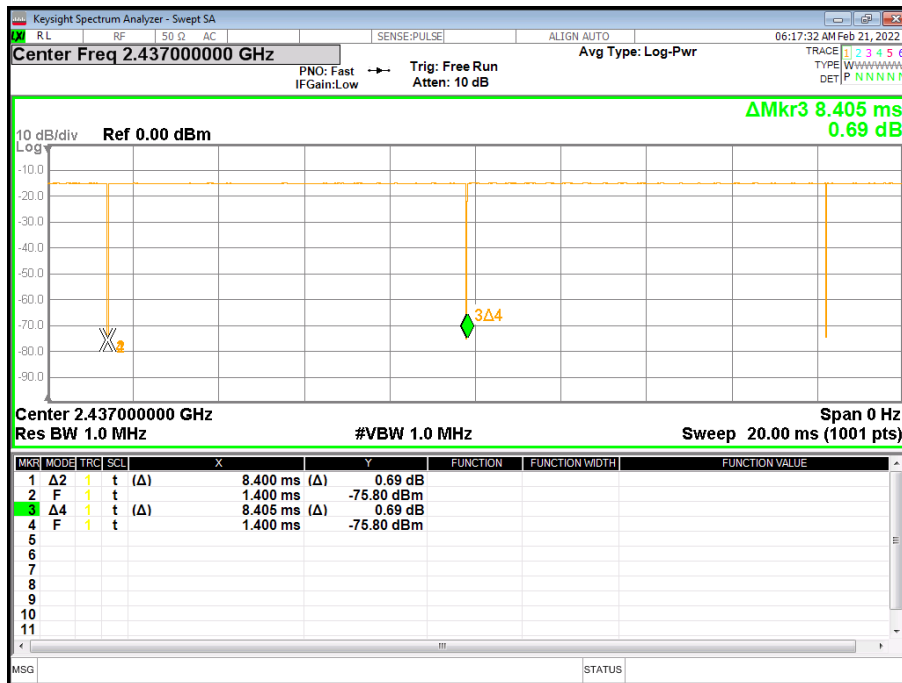



802.11g

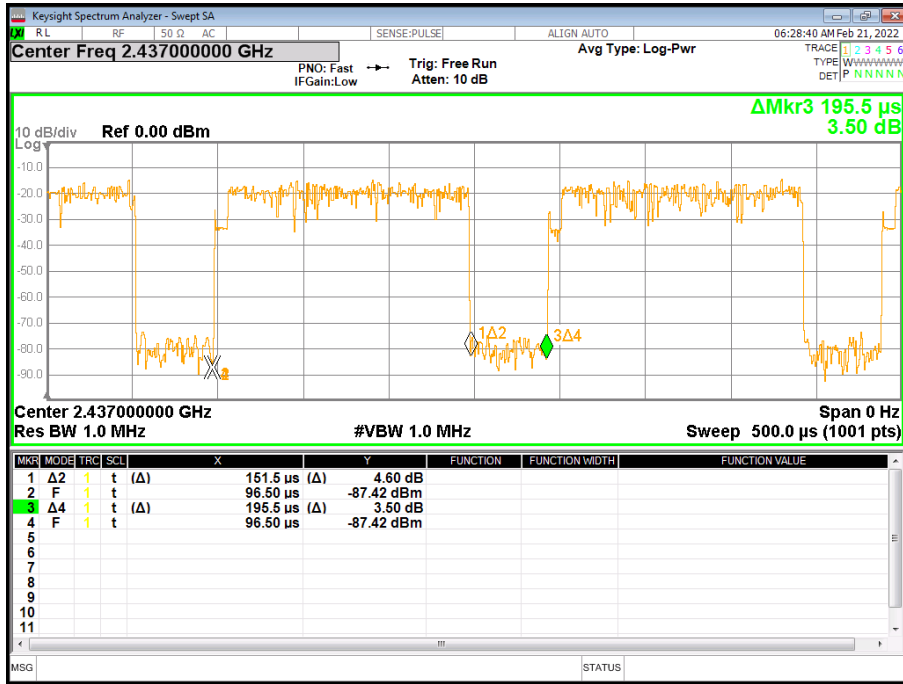

802.11n(HT20)

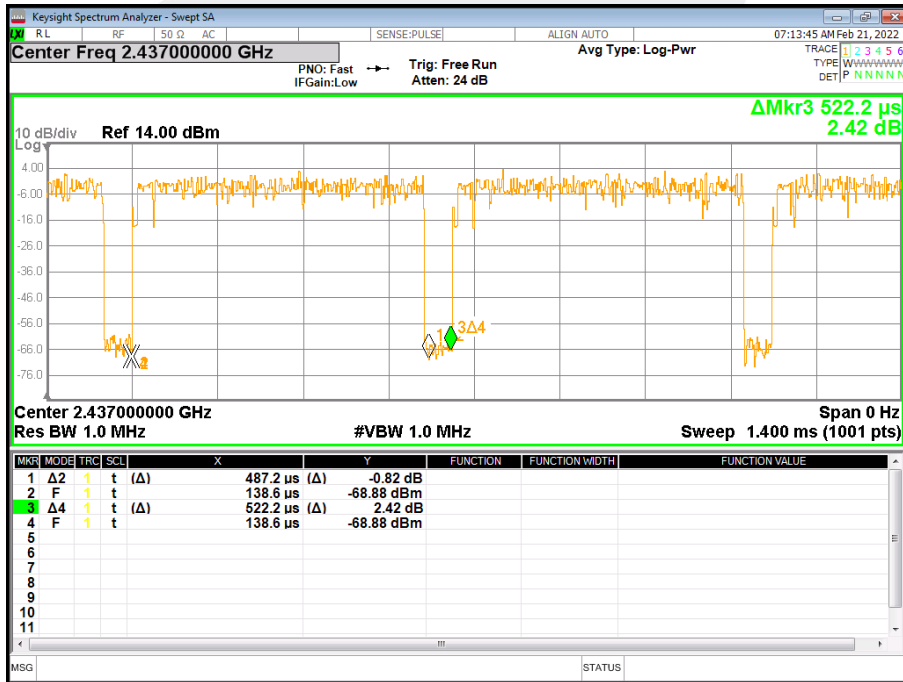



802.11n(HT40)

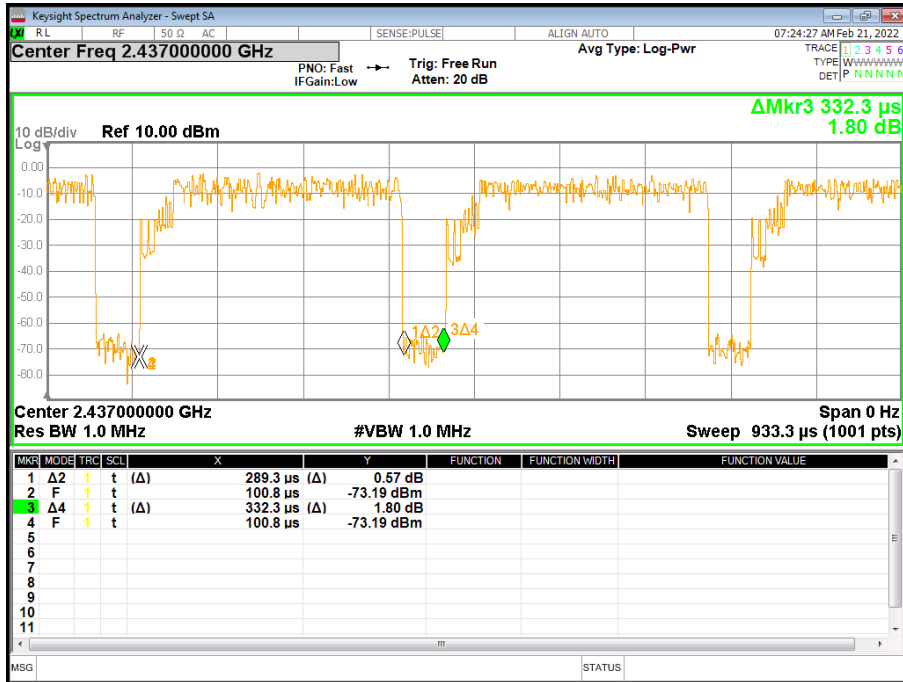



8. ANTENNA REQUIREMENT

8.1 STANDARD REQUIREMENT

15.203 requirement: For intentional device, according to 15.203: an intentional radiator shall be designed to ensure that no antenna other than that furnished by the responsible party shall be used with the device.

8.2 EUT ANTENNA

The EUT antenna is PIFA Antenna. It comply with the standard requirement.





APPENDIX-PHOTOS OF TEST SETUP

Note: See test photos in setup photo document for the actual connections between Product and support equipment.

*****END OF THE REPORT*****

