

FCC

SAR

TEST REPORT

ISSUED BY  
Shenzhen BALUN Technology Co., Ltd.



FOR  
**Rugged PDA**

ISSUED TO  
Winmate Inc.

9F, No. 111-6, Shing-De Road, San-Chung District, New Taipei City  
24158, Taiwan



Tested by *Zong Liyao*  
Zong Liyao  
(Engineer)

Date *Mar 14, 2017*

Approved by *Wei Yanquan*  
Wei Yanquan  
(Chief Engineer)

Date *Mar. 14, 2017*



|                  |                         |
|------------------|-------------------------|
| Report No.:      | BL- SZ16B0008-701       |
| EUT Name:        | Rugged PDA              |
| Model Name:      | E500RM8, E500XXXXXXXXXX |
| Brand Name:      | Winmate                 |
| FCC ID:          | PX9500                  |
| Test Standard:   | FCC 47 CFR Part 2.1093  |
|                  | ANSI C95.1: 1999        |
|                  | IEEE 1528: 2013         |
| Maximum SAR:     | Body (1 g): 0.305 W/kg  |
| Test Conclusion: | Pass                    |
| Test Date:       | Nov. 23, 2016           |
| Date of Issue:   | Mar. 14, 2017           |

*NOTE: This test report can be duplicated completely for the legal use with the approval of the applicant; it shall not be reproduced except in full, without the written approval of Shenzhen BALUN Technology Co., Ltd. BALUN Laboratory. Any objections should be raised within thirty days from the date of issue. To validate the report, please visit BALUN website.*

### Revision History

| Version        | Issue Date           | Revisions Content   |
|----------------|----------------------|---|
| <u>Rev. 01</u> | <u>Jan. 19, 2017</u> | <u>Initial Issue</u>  |
| <u>Rev. 02</u> | <u>Mar. 14, 2017</u> | <u>Updated test exclusion consideration section 9.1 in page 33</u><br><u>Updated Simultaneous transmission statement and section 12.1 in page 37</u><br><u>Updated test equipment list in page 38</u> |

## TABLE OF CONTENTS

|     |  |    |
|-----|--|----|
| 1   | GENERAL INFORMATION.....                                 | 4  |
| 1.1 | Identification of the Testing Laboratory .....           | 4  |
| 1.2 | Identification of the Responsible Testing Location ..... | 4  |
| 1.3 | Test Environment Condition .....                         | 4  |
| 1.4 | Announce .....   | 5  |
| 2   | PRODUCT INFORMATION .....                                | 6  |
| 2.1 | Applicant Information.....                               | 6  |
| 2.2 | Manufacturer Information.....                            | 6  |
| 2.3 | Factory Information.....                                 | 6  |
| 2.4 | General Description for Equipment under Test (EUT).....  | 6  |
| 2.5 | Ancillary Equipment.....                                 | 7  |
| 2.6 | Technical Information .....                              | 8  |
| 3   | SUMMARY OF TEST RESULTS .....                            | 9  |
| 3.1 | Test Standards .....                                     | 9  |
| 3.2 | Device Category and SAR Limit .....                      | 9  |
| 3.3 | Test Result Summary .....                                | 11 |
| 3.4 | Test Uncertainty .....                                   | 12 |
| 4   | SAR MEASUREMENT SYSTEM.....                              | 14 |
| 4.1 | Definition of Specific Absorption Rate (SAR) .....       | 14 |
| 4.2 | SATIMO SAR System .....                                  | 14 |
| 5   | SYSTEM VERIFICATION.....                                 | 23 |
| 5.1 | Antenna Port Test Requirement .....                      | 23 |
| 5.2 | Purpose of System Check .....                            | 23 |

|         |   |    |
|---------|---|----|
| 5.3     | System Check Setup .....                        | 23 |
| 6       | EUT TEST POSITION CONFIGURATIONS.....           | 24 |
| 6.1     | Head Exposure Conditions .....                  | 24 |
| 6.2     | Body-worn Position Conditions .....             | 25 |
| 6.3     | Hotspot Mode Exposure Position Conditions ..... | 26 |
| 7       | SAR MEASUREMENT PROCEDURES.....                 | 27 |
| 7.1     | SAR Measurement Process Diagram .....           | 27 |
| 7.2     | SAR Scan General Requirements .....             | 28 |
| 7.3     | SAR Measurement Procedure .....                 | 29 |
| 7.4     | Area & Zoom Scan Procedures .....               | 29 |
| 8       | CONDUCTED RF OUTPUT POWER .....                 | 30 |
| 8.1     | WIFI.....                                       | 30 |
| 8.2     | Bluetooth .....                                 | 30 |
| 8.3     | Rated RF Power Output .....                     | 31 |
| 9       | EUT ANTENNA LOCATION SKETCH .....               | 32 |
| 9.1     | SAR Test Exclusion Consider Table.....          | 33 |
| 10      | TEST RESULTS.....                               | 35 |
| 10.1    | WIFI 2.4GHz.....                                | 35 |
| 11      | SAR Measurement Variability .....               | 36 |
| 12      | SIMULTANEOUS TRANSMISSION.....                  | 37 |
| 12.1    | Estimated SAR Calculation.....                  | 37 |
| 13      | TEST EQUIPMENTS LIST .....                      | 38 |
| ANNEX A | SIMULATING LIQUID VERIFICATION RESULT .....     | 39 |
| ANNEX B | SYSTEM CHECK RESULT .....                       | 40 |
| ANNEX C | TEST DATA.....                                  | 43 |
| ANNEX D | EUT EXTERNAL PHOTOS .....                       | 53 |
| ANNEX E | SAR TEST SETUP PHOTOS .....                     | 53 |
| ANNEX F | CALIBRATION REPORT.....                         | 54 |
| F.1     | E-Field Probe .....                             | 54 |
| F.2     | 2450MHz Dipole .....                            | 64 |

# 1 GENERAL INFORMATION

## 1.1 Identification of the Testing Laboratory

|              |   |
|--------------|---|
| Company Name | Shenzhen BALUN Technology Co., Ltd.   |
| Address      | Block B, 1st FL, Baisha Science and Technology Park, Shahe Xi Road, Nanshan District, Shenzhen, Guangdong Province, P. R. China |
| Phone Number | +86 755 6685 0100   |
| Fax Number   | +86 755 6182 4271   |

## 1.2 Identification of the Responsible Testing Location

|                           |   |
|---------------------------|---|
| Test Location             | Shenzhen BALUN Technology Co., Ltd.   |
| Address                   | Block B, 1st FL, Baisha Science and Technology Park, Shahe Xi Road, Nanshan District, Shenzhen, Guangdong Province, P. R. China   |
| Accreditation Certificate | <p>The laboratory has been listed by Industry Canada to perform electromagnetic emission measurements. The recognition numbers of test site are 11524A-1.</p> <p>The laboratory has been listed by US Federal Communications Commission to perform electromagnetic emission measurements. The recognition numbers of test site are 832625.</p> <p>The laboratory is a testing organization accredited by China National Accreditation Service for Conformity Assessment (CNAS) according to ISO/IEC 17025. The accreditation certificate number is L6791.</p> |
| Description               | All measurement facilities used to collect the measurement data are located at Block B, FL 1, Baisha Science and Technology Park, Shahe Xi Road, Nanshan District, Shenzhen, Guangdong Province, P. R. China 518055   |

## 1.3 Test Environment Condition

|                           |               |
|---------------------------|---------------|
| Ambient Temperature       | 21 to 23°C    |
| Ambient Relative Humidity | 37 to 48%     |
| Ambient Pressure          | 100 to 102KPa |

## 1.4 Announce

- (1) The test report reference to the report template version v2.2.
- (2) The test report is invalid if not marked with the signatures of the persons responsible for preparing and approving the test report.
- (3) The test report is invalid if there is any evidence and/or falsification.
- (4) The results documented in this report apply only to the tested sample, under the conditions and modes of operation as described herein.
- (5) This document may not be altered or revised in any way unless done so by BALUN and all revisions are duly noted in the revisions section.
- (6) Content of the test report, in part or in full, cannot be used for publicity and/or promotional purposes without prior written approval from the laboratory.

## 2 PRODUCT INFORMATION

### 2.1 Applicant Information

|           |  |
|-----------|--|
| Applicant | Winmate Inc.   |
| Address   | 9F, No. 111-6, Shing-De Road, San-Chung District, New Taipei City<br>24158, Taiwan |

### 2.2 Manufacturer Information

|              |  |
|--------------|--|
| Manufacturer | Winmate Inc.   |
| Address      | 9F, No. 111-6, Shing-De Road, San-Chung District, New Taipei City<br>24158, Taiwan |

### 2.3 Factory Information

|         |  |
|---------|--|
| Factory | Winmate Inc.   |
| Address | 9F, No. 111-6, Shing-De Road, San-Chung District, New Taipei City<br>24158, Taiwan |

### 2.4 General Description for Equipment under Test (EUT)

|   |  |
|---|--|
| EUT Name                                  | Rugged PDA   |
| Model Name Under Test                     | E500RM8  |
| Series Model Name                         | E500RM8, E500XXXXXXXXXX  |
| Description of Model Name Differentiation | The Circuit, PCB Layout, Electrical Parts and Outlook of E500XXXXXXXXXX are identical to E500RM8.<br>E500XXXXXXXXXX(X=A-Z, 0-9, a-z, "-", "/", "\" or blank for marketing purpose only, and no impact safety related constructions or critical components such as PCB, circuit and so on). |
| Hardware Version                          | N/A  |
| Software Version                          | N/A  |
| Dimensions (Approx.)                      | Please refer to the report of BL-SZ16B0008-AW.   |
| Weight (Approx.)                          | N/A  |
| Network and Wireless connectivity         | Bluetooth 3.0, Bluetooth 4.0 Low Energy (BLE),<br>WIFI,802.11b, 802.11g and 802.11n (HT20/40), GPS   |

## 2.5 Ancillary Equipment

|                       |                      |                                    |
|-----------------------|----------------------|------------------------------------|
| Ancillary Equipment 1 | Battery              |                                    |
|                       | Brand Name           | Winmate Inc.                       |
|                       | Model No.            | E430                               |
|                       | Serial No.           | N/A                                |
|                       | Capacitance          | 3900 mAh                           |
|                       | Rated Voltage        | 3.7 V                              |
|                       | Limit Charge Voltage | 4.2 V                              |
| Ancillary Equipment 2 | Charger              |                                    |
|                       | Brand Name           | ENG                                |
|                       | Model Name           | 6A-181WP05                         |
|                       | Rated Input          | 100-240 V $\sim$ , 50/60 Hz, 0.6 A |
| Rated Output          | 5 V $\equiv$ , 3.0 A |                                    |

## 2.6 Technical Information

The requirement for the following technical information of the EUT was tested in this report:

|                   |   |  |
|-------------------|---|--|
| Operating Mode    | 2.4G WLAN   |  |
| Frequency Range   | 802.11b/g<br>/n(HT20/HT40)                          | 2400~2483.5 MHz                              |
|                   | Bluetooth   | 2400~2483.5 MHz                              |
| Antenna Type      | PIFA Antenna  |  |
| Hotspot Function  | N/A   |  |
| Power Reduction   | Not Support   |  |
| Exposure Category | General Population/Uncontrolled exposure            |  |
| EUT Stage         | Portable Device                                     |  |
| Product           | Type  |  |
|                   | <input checked="" type="checkbox"/> Production unit | <input type="checkbox"/> Identical prototype |



### 3 SUMMARY OF TEST RESULTS

#### 3.1 Test Standards

| No. | Identity                  | Document Title  |
|-----|---------------------------|---|
| 1   | 47 CFR Part 2             | Frequency Allocations and Radio Treaty Matters; General Rules and Regulations   |
| 2   | ANSI/IEEE Std. C95.1-1999 | IEEE Standard for Safety Levels with Respect to Human Exposure to Radio Frequency Electromagnetic Fields, 3 kHz to 300 GHz  |
| 3   | IEEE Std. 1528-2013       | Recommended Practice for Determining the Peak Spatial-Average Specific Absorption Rate (SAR) in the Human Head from Wireless Communications Devices: Measurement Techniques |
| 4   | FCC KDB 447498 D01 v06    | Mobile and Portable Device RF Exposure Procedures and Equipment Authorization Policies  |
| 5   | FCC KDB 865664 D01 v01r04 | SAR Measurement 100 MHz to 6 GHz  |
| 6   | FCC KDB 865664 D02 v01r02 | RF Exposure Reporting   |
| 7   | FCC KDB 616217 D02 v01r02 | RF Evaluation Considerations for Laptop, Notebook, Netbook and Tablet Computer  |
| 8   | FCC KDB 248227 D01 v02r02 | SAR Guidance For IEEE 802.11 (Wi-Fi) Transmitters   |

#### 3.2 Device Category and SAR Limit

This device belongs to portable device category because its radiating structure is allowed to be used within 20 centimeters of the body of the user. Limit for General Population/Uncontrolled exposure should be applied for this device, it is 1.6 W/kg as averaged over any 1 gram of tissue.

Table of Exposure Limits:

| Body Position  | SAR Value (W/Kg)                             |                                      |
|--|--|--------------------------------------|
|  | General Population/<br>Uncontrolled Exposure | Occupational/<br>Controlled Exposure |
| Whole-Body SAR<br>(averaged over the entire body)                                | 0.08   | 0.4                                  |
| Partial-Body SAR<br>(averaged over any 1 gram of tissue)                         | 1.60   | 8.0                                  |
| SAR for hands, wrists, feet and ankles<br>(averaged over any 10 grams of tissue) | 4.0  | 20.0                                 |

## NOTE:

**General Population/Uncontrolled:** Locations where there is the exposure of individuals who have no knowledge or control of their exposure. General population/uncontrolled exposure limits are applicable to situations in which the general public may be exposed or in which persons who are exposed as a consequence of their employment may not be made fully aware of the potential for exposure or cannot exercise control over their exposure. Members of the general public would come under this category when exposure is not employment-related; for example, in the case of a wireless transmitter that exposes persons in its vicinity.

**Occupational/Controlled:** Locations where there is exposure that may be incurred by persons who are aware of the potential for exposure. In general, occupational/controlled exposure limits are applicable to situations in which persons are exposed as a consequence of their employment, who have been made fully aware of the potential for exposure and can exercise control over their exposure. This exposure category is also applicable when the exposure is of a transient nature due to incidental passage through a location where the exposure levels may be higher than the general population/uncontrolled limits, but the exposed person is fully aware of the potential for exposure and can exercise control over his or her exposure by leaving the area or by some other appropriate means.

### 3.3 Test Result Summary

#### 3.3.1 Highest SAR (1 g Value)

| Band      | Maximum Scaled SAR<br>(W/kg) | Maximum Report SAR<br>(W/kg) | Limit<br>(W/kg) |
|-----------|------------------------------|------------------------------|-----------------|
|           | Body                         | Body                         |                 |
| 2.4G WLAN | 0.305                        | 0.305                        | 1.6             |
| Verdict   | Pass                         |                              |                 |

#### 3.3.2 Highest Simultaneous SAR

The simultaneous transmission evaluation is not required in this report.

### 3.4 Test Uncertainty

#### 3.4.1 Measurement uncertainty evaluation for SAR test

The following measurement uncertainty levels have been estimated for tests performed on the EUT as specified in IEEE 1528 This uncertainty represents an expanded uncertainty expressed at approximately the 95% confidence level using a coverage factor of k=2.

| Uncertainty Component   | Tol<br>(+-%) | Prob.<br>Dist. | Div.       | Ci<br>(1g) | Ci<br>(10g) | 1g Ui<br>(+-%) | 10g Ui<br>(+-%) | V <sub>i</sub> |
|---|--------------|----------------|------------|------------|-------------|----------------|-----------------|----------------|
| <b>Measurement System</b>   |              |                |            |            |             |                |                 |                |
| Probe calibration   | 5.8          | N              | 1          | 1          | 1           | 5.80           | 5.80            | ∞              |
| Axial Isotropy  | 3.5          | R              | $\sqrt{3}$ | 0.7        | 0.7         | 1.41           | 1.41            | ∞              |
| Hemispherical Isotropy  | 5.9          | R              | $\sqrt{3}$ | 0.7        | 0.7         | 2.38           | 2.38            | ∞              |
| Boundary effect   | 1.0          | R              | $\sqrt{3}$ | 1          | 1           | 0.58           | 0.58            | ∞              |
| Linearity   | 4.7          | R              | $\sqrt{3}$ | 1          | 1           | 2.71           | 2.71            | ∞              |
| System detection limits   | 1.0          | R              | $\sqrt{3}$ | 1          | 1           | 0.58           | 0.58            | ∞              |
| Readout Electronics   | 0.5          | N              | 1          | 1          | 1           | 0.50           | 0.50            | ∞              |
| Response Time   | 0.0          | R              | $\sqrt{3}$ | 1          | 1           | 0.00           | 0.00            | ∞              |
| Integration Time  | 1.4          | R              | $\sqrt{3}$ | 1          | 1           | 0.81           | 0.81            | ∞              |
| RF ambient Conditions - Noise   | 3.0          | R              | $\sqrt{3}$ | 1          | 1           | 1.73           | 1.73            | ∞              |
| RF ambient Conditions - Reflections   | 3.0          | R              | $\sqrt{3}$ | 1          | 1           | 1.73           | 1.73            | ∞              |
| Probe positioner Mechanical Tolerance   | 1.4          | R              | $\sqrt{3}$ | 1          | 1           | 0.81           | 0.81            | ∞              |
| Probe positioning with respect to Phantom Shell                                 | 1.4          | R              | $\sqrt{3}$ | 1          | 1           | 0.81           | 0.81            | ∞              |
| Extrapolation, interpolation and integration Algorithms for Max. SAR Evaluation | 2.3          | R              | $\sqrt{3}$ | 1          | 1           | 1.33           | 1.33            | ∞              |
| <b>Test Sample Related</b>  |              |                |            |            |             |                |                 |                |
| Test sample positioning   | 2.6          | N              | 1          | 1          | 1           | 2.60           | 2.60            | N-1            |
| Device Holder Uncertainty   | 1.0          | N              | 1          | 1          | 1           | 1.00           | 1.00            | N-1            |
| Output power Variation - SAR drift measurement                                  | 5.0          | R              | $\sqrt{3}$ | 1          | 1           | 2.89           | 2.89            | ∞              |
| SAR scaling   | 2.00         | R              | $\sqrt{3}$ | 1          | 1           | 1.15           | 1.15            | ∞              |
| <b>Phantom and Tissue Parameters</b>  |              |                |            |            |             |                |                 |                |
| Phantom Uncertainty (Shape and thickness tolerances)                            | 4.0          | R              | $\sqrt{3}$ | 1          | 1           | 2.31           | 2.31            | ∞              |
| Liquid conductivity ( deviation from target values)                             | 2.5          | N              | $\sqrt{3}$ | 0.64       | 0.43        | 0.92           | 0.62            | ∞              |
| Liquid conductivity - measurement uncertainty                                   | 5.0          | N              | 1          | 0.64       | 0.43        | 3.20           | 2.15            | M              |
| Liquid permittivity (deviation from target values)                              | 2.5          | N              | $\sqrt{3}$ | 0.60       | 0.49        | 0.87           | 0.71            | ∞              |
| Liquid permittivity - measurement uncertainty                                   | 5.0          | N              | 1          | 0.60       | 0.49        | 3.00           | 2.45            | M              |
| <b>Combined Standard Uncertainty</b>  |              | RSS            |            |            |             | 10.14          | 9.67            |                |
| <b>Expanded Uncertainty</b><br>(95% Confidence interval)                        |              | k              |            |            |             | 20.29          | 19.35           |                |

### 3.4.2 Measurement uncertainty evaluation for system check

This measurement uncertainty budget is suggested by IEEE 1528. The break down of the individual uncertainties is as follows:

| Uncertainty Component   | Tol<br>(+-%) | Prob.<br>Dist. | Div.       | Ci<br>(1g) | Ci<br>(10g) | 1g Ui<br>(+-%) | 10g Ui<br>(+-%) | Vi       |
|---|--------------|----------------|------------|------------|-------------|----------------|-----------------|----------|
| <b>Measurement System</b>   |              |                |            |            |             |                |                 |          |
| Probe calibration   | 5.8          | N              | 1          | 1          | 1           | 5.80           | 5.80            | $\infty$ |
| Axial Isotropy  | 3.5          | R              | $\sqrt{3}$ | 0.7        | 0.7         | 1.41           | 1.41            | $\infty$ |
| Hemispherical Isotropy  | 5.9          | R              | $\sqrt{3}$ | 0.7        | 0.7         | 2.38           | 2.38            | $\infty$ |
| Boundary effect   | 1.0          | R              | $\sqrt{3}$ | 1          | 1           | 0.58           | 0.58            | $\infty$ |
| Probe Linearity   | 4.7          | R              | $\sqrt{3}$ | 1          | 1           | 2.71           | 2.71            | $\infty$ |
| System detection limits   | 1.0          | R              | $\sqrt{3}$ | 1          | 1           | 0.58           | 0.58            | $\infty$ |
| Readout Electronics   | 0.5          | N              | 1          | 1          | 1           | 0.50           | 0.50            | $\infty$ |
| Reponse Time  | 0.0          | R              | $\sqrt{3}$ | 1          | 1           | 0.00           | 0.00            | $\infty$ |
| Integration Time  | 1.4          | R              | $\sqrt{3}$ | 1          | 1           | 0.81           | 0.81            | $\infty$ |
| RF ambient Conditions - Noise   | 3.0          | R              | $\sqrt{3}$ | 1          | 1           | 1.73           | 1.73            | $\infty$ |
| RF ambient Conditions - Reflections   | 3.0          | R              | $\sqrt{3}$ | 1          | 1           | 1.73           | 1.73            | $\infty$ |
| Probe positioner Mechanical Tolerance   | 1.4          | R              | $\sqrt{3}$ | 1          | 1           | 0.81           | 0.81            | $\infty$ |
| Probe positioning with respect to Phantom Shell                                 | 1.4          | R              | $\sqrt{3}$ | 1          | 1           | 0.81           | 0.81            | $\infty$ |
| Extrapolation, interpolation and integration Algorithms for Max. SAR Evaluation | 2.3          | R              | $\sqrt{3}$ | 1          | 1           | 1.33           | 1.33            | $\infty$ |
| <b>Dipole</b>   |              |                |            |            |             |                |                 |          |
| Deviation of experimental dipole  | 5.5          | R              | $\sqrt{3}$ | 1          | 1           | 3.20           | 3.20            | $\infty$ |
| Dipole axis to liquid distance  | 2.0          | R              | 1          | 1          | 1           | 1.20           | 1.20            | $\infty$ |
| Power drift   | 4.7          | R              | $\sqrt{3}$ | 1          | 1           | 2.70           | 2.70            | $\infty$ |
| <b>Phantom and Tissue Parameters</b>  |              |                |            |            |             |                |                 |          |
| Phantom Uncertainty (Shape and thickness tolerances)                            | 4.0          | R              | $\sqrt{3}$ | 1          | 1           | 2.31           | 2.31            | $\infty$ |
| Liquid conductivity ( deviation from target values)                             | 2.5          | N              | $\sqrt{3}$ | 0.64       | 0.43        | 0.92           | 0.62            | $\infty$ |
| Liquid conductivity - measurement uncertainty                                   | 5.0          | N              | 1          | 0.64       | 0.43        | 3.20           | 2.15            | M        |
| Liquid permittivity (deviation from target values)                              | 2.5          | N              | $\sqrt{3}$ | 0.60       | 0.49        | 0.87           | 0.71            | $\infty$ |
| Liquid permittivity - measurement uncertainty                                   | 5.0          | N              | 1          | 0.60       | 0.49        | 3.00           | 2.45            | M        |
| <b>Combined Standard Uncertainty</b>  |              | RSS            |            |            |             | 10.22          | 9.75            |          |
| <b>Expanded Uncertainty</b><br>(95% Confidence interval)                        |              | k              |            |            |             | 20.44          | 19.50           |          |

## 4 SAR MEASUREMENT SYSTEM

### 4.1 Definition of Specific Absorption Rate (SAR)

SAR is related to the rate at which energy is absorbed per unit mass in an object exposed to a radio field. The SAR distribution in a biological body is complicated and is usually carried out by experimental techniques or numerical modeling. The standard recommends limits for two tiers of groups, occupational/controlled and general population/uncontrolled, based on a person's awareness and ability to exercise control over his or her exposure. In general, occupational / controlled exposure limits are higher than the limits for general population /uncontrolled.

The SAR definition is the time derivative (rate) of the incremental energy (dW) absorbed by (dissipated in) an incremental mass (dm) contained in a volume element (dv) of a given density ( $\rho$ ). The equation description is as below:

$$\text{SAR} = \frac{d}{dt} \left( \frac{dW}{dm} \right) = \frac{d}{dt} \left( \frac{dW}{\rho dv} \right)$$

SAR is expressed in units of Watts per kilogram (W/kg) SAR measurement can be related to the electrical field in the tissue by

$$\text{SAR} = \frac{\sigma E^2}{\rho}$$

Where:  $\sigma$  is the conductivity of the tissue,

$\rho$  is the mass density of the tissue and E is the RMS electrical field strength.

### 4.2 SATIMO SAR System

#### 4.2.1 SATIMO SAR System Diagram

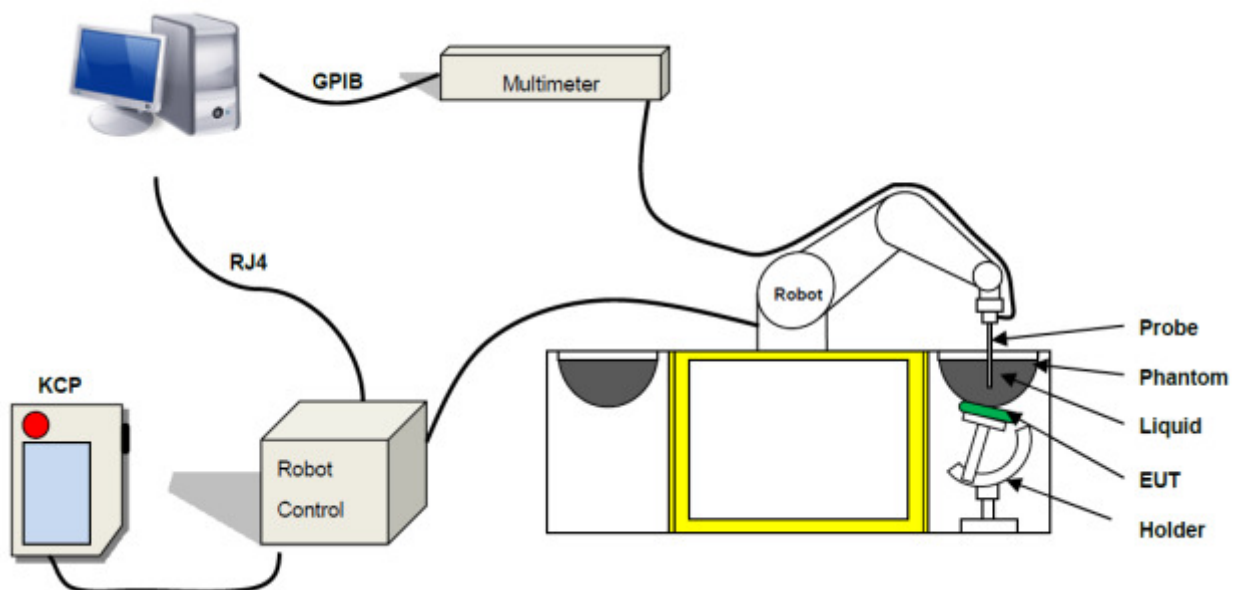

These measurements were performed with the automated near-field scanning system OPENSAR from SATIMO.

The system is based on a high precision robot (working range: 850 mm), which positions the probes with a positional repeatability of better than  $\pm 0.02$  mm. Special E- and H-field probes have been developed for measurements close to material discontinuity, the sensors of which are directly loaded with a Schottky diode and connected via highly resistive lines to the data acquisition unit.

The SAR measurements were conducted with dosimetric probe (manufactured by SATIMO), designed in the classical triangular configuration and optimized for dosimetric evaluation. The probe has been calibrated according to the procedure described in SAR standard with accuracy of better than  $\pm 10\%$ . The spherical isotropy was evaluated with the procedure described in SAR standard and found to be better than  $\pm 0.25$  dB. The phantom used was the SAM Phantom as described in FCC supplement C, IEEE P1528.

#### 4.2.2 Robot

The SATIMO SAR system uses the high precision robots from KUKA. For the 6-axis controller system, the robot controller version (KUKA) from KUKA is used. The KUKA robot series have many features that are important for our application:



- High precision (repeatability  $\pm 0.035$  mm)
- High reliability (industrial design)
- Jerk-free straight movements
- Low ELF interference (the closed metallic construction shields against motor control fields)

#### 4.2.3 E-Field Probe

For the measurements the Specific Dosimetric E-Field Probe SN 34/15 EPGO 265 with following specifications is used

- Dynamic range: 0.01-100 W/kg
- Tip Diameter : 2.5 mm
- Lower detection limit : 7 mW/kg  
(repeatability better than  $\pm 1$ mm)
- Probe linearity:  $\pm 0.07$  dB
- Calibration range: 450 MHz to 5800 MHz for head & body simulating liquid.

Angle between probe axis (evaluation axis) and surface normal line: less than 30°



### E-Field Probe Calibration Process

Probe calibration is realized, in compliance with CENELEC EN 62209-1/-2 and IEEE 1528 std, with CALISAR, Antenna proprietary calibration system. The calibration is performed with the IEC62209-1/2 annexe technique using reference guide at the five frequencies.

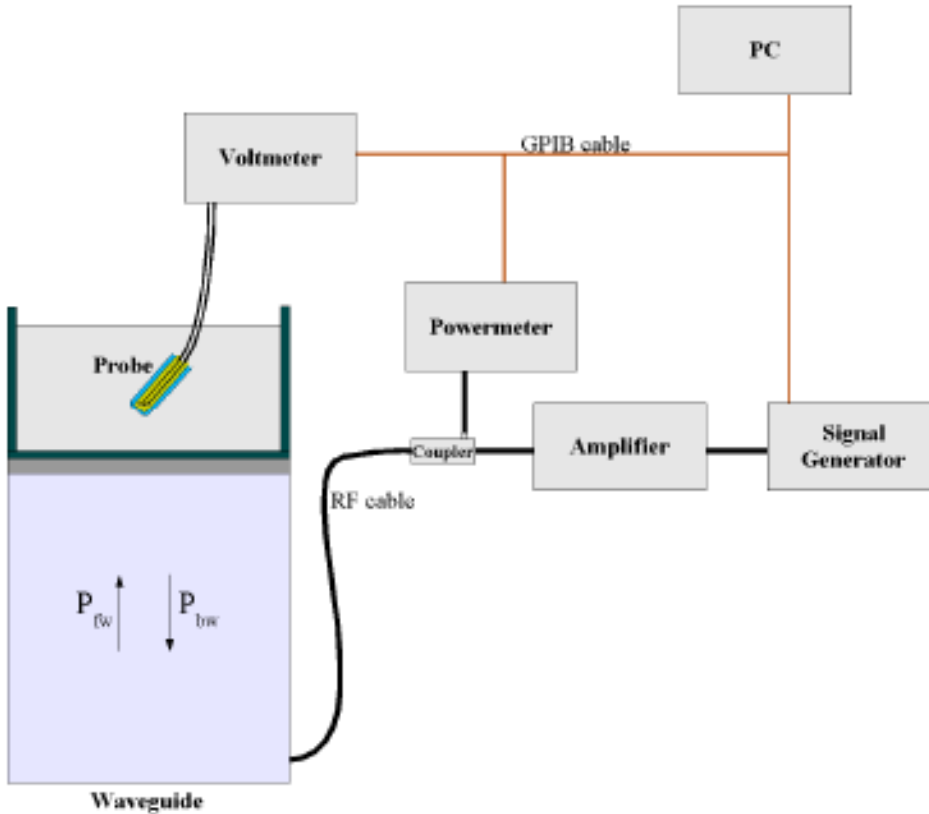

$$SAR = \frac{4(P_{fw} - P_{bw})}{ab\sigma} \cos^2 \left( \pi \frac{y}{a} \right) c^{(2\pi/\sigma)}$$

Where :

- P<sub>fw</sub> = Forward Power
- P<sub>bw</sub> = Backward Power
- a and b = Waveguide Dimensions
- l = Skin Depth

### Keithley configuration

Rate = Medium; Filter = ON; RDGS = 10; FILTER TYPE = MOVING AVERAGE; RANGE AUTO After each calibration, a SAR measurement is performed on a validation dipole and compared with a NPL calibrated probe, to verify it.

The calibration factors, CF(N), for the 3 sensors corresponding to dipole 1, dipole 2 and dipole 3 are:



$$CF(N)=SAR(N)/V_{lin}(N) \quad (N=1,2,3)$$

The linearised output voltage  $V_{lin}(N)$  is obtained from the displayed output voltage  $V(N)$  using

$$V_{lin}(N)=V(N)*(1+V(N)/DCP(N)) \quad (N=1,2,3)$$

Where the DCP is the diode compression point in mV.

#### 4.2.4 Phantoms

For the measurements the Specific Anthropomorphic Mannequin (SAM) defined by the IEEE SCC-34/SC2 group is used. The phantom is a polyurethane shell integrated in a wooden table. The thickness of the phantom amounts to 2mm +/- 0.2mm. It enables the dosimetric evaluation of left and right phone usage and includes an additional flat phantom part for the simplified performance check. The phantom set-up includes a cover, which prevents the evaporation of the liquid.

Photo of Phantom SN 30/13 SAM103



Photo of Phantom SN 30/13 SAM104



| Serial Number   | Positionner Material    | Permittivity | Loss Tangent |
|-----------------|-------------------------|--------------|--------------|
| SN 30/13 SAM103 | Gelcoat with fiberglass | 3.4          | 0.02         |
| SN 30/13 SAM104 | Gelcoat with fiberglass | 3.4          | 0.02         |

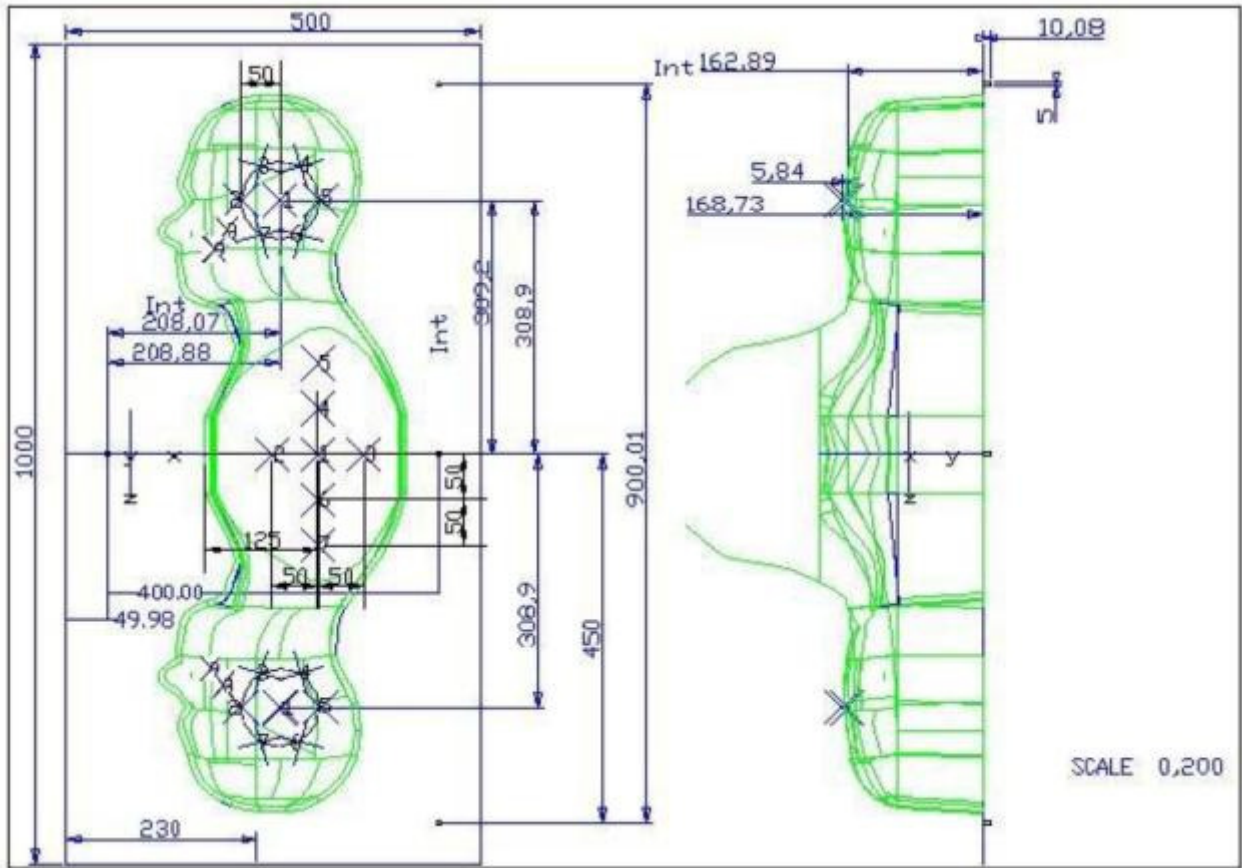

| Serial Number   | Left Head       |      | Right Head |      | Flat Part |      |
|-----------------|-----------------|------|------------|------|-----------|------|
| SN 30/13 SAM103 | 2               | 2.00 | 2          | 2.03 | 1         | 2.09 |
|                 | 3               | 2.02 | 3          | 2.05 | 2         | 2.10 |
|                 | 4               | 2.04 | 4          | 2.04 | 3         | 2.09 |
|                 | 5               | 2.04 | 5          | 2.07 | 4         | 2.11 |
|                 | 6               | 2.02 | 6          | 2.07 | 5         | 2.11 |
|                 | 7               | 2.01 | 7          | 2.09 | 6         | 2.09 |
|                 | 8               | 2.04 | 8          | 2.10 | 7         | 2.11 |
|                 | 9               | 2.02 | 9          | 2.09 | -         | -    |
|                 | SN 30/13 SAM104 | 2    | 2.05       | 2    | 2.06      | 1    |
| 3               |                 | 2.08 | 3          | 2.03 | 2         | 2.03 |
| 4               |                 | 2.05 | 4          | 2.03 | 3         | 2.01 |
| 5               |                 | 2.06 | 5          | 2.02 | 4         | 2.03 |
| 6               |                 | 2.08 | 6          | 2.02 | 5         | 2.03 |
| 7               |                 | 2.06 | 7          | 2.04 | 6         | 2.00 |
| 8               |                 | 2.07 | 8          | 2.04 | 7         | 1.98 |
| 9               |                 | 2.07 | 9          | 2.05 | -         | -    |

#### 4.2.5 Device Holder

The SAR in the phantom is approximately inversely proportional to the square of the distance between the source and the liquid surface. For a source at 5 mm distance, a positioning uncertainty of  $\pm 0.5$  mm would produce a SAR uncertainty of  $\pm 20$  %. Accurate device positioning is therefore crucial for accurate and repeatable measurements. The positions in which the devices must be measured are defined by the standards.



| Serial Number  | Holder Material | Permittivity | Loss Tangent |
|----------------|-----------------|--------------|--------------|
| SN 25/13 MSH87 | Deirin          | 3.7          | 0.005        |
| SN 25/13 MSH88 | Deirin          | 3.7          | 0.005        |

The positioning system allows obtaining cheek and tilting position with a very good accuracy. In compliance with CENELEC, the tilt angle uncertainty is lower than 1°.

#### 4.2.6 Simulating Liquid

For SAR measurement of the field distribution inside the phantom, the phantom must be filled with homogeneous tissue simulating liquid to a depth of at least 15 cm. For head SAR testing, the liquid height from the ear reference point (ERP) of the phantom to the liquid top surface is larger than 15 cm. For body SAR testing, the liquid height from the center of the flat phantom to the liquid top surface is larger than 15 cm. The nominal dielectric values of the tissue simulating liquids in the phantom and the tolerance of 5%.

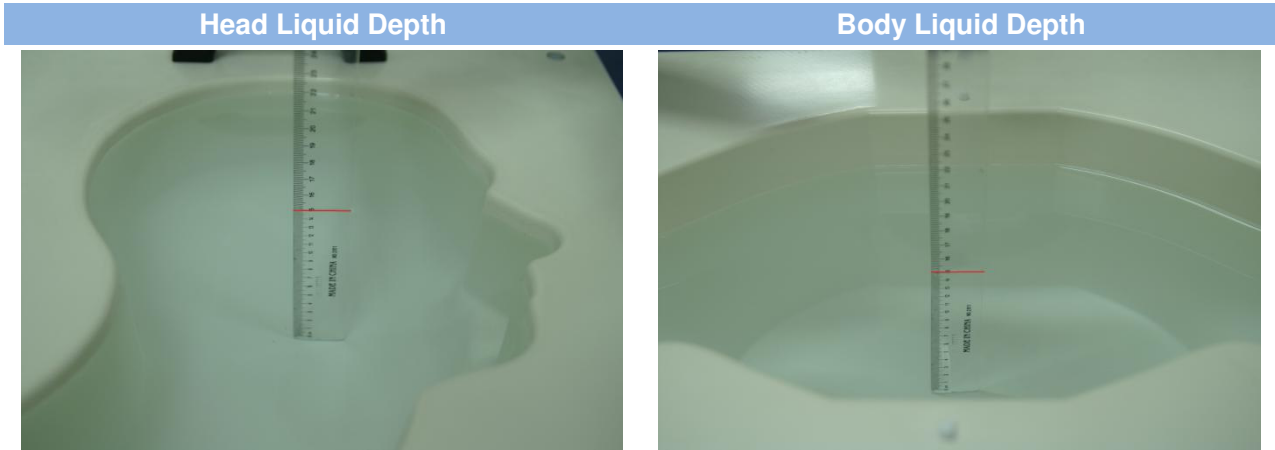

The following table gives the recipes for tissue simulating liquid and the theoretical Conductivity/Permittivity.

| Head (Reference IEEE1528)           |           |                    |               |          |                  |          |                             |                         |
|-------------------------------------|-----------|--------------------|---------------|----------|------------------|----------|-----------------------------|-------------------------|
| Frequency (MHz)                     | Water (%) | Sugar (%)          | Cellulose (%) | Salt (%) | Preventol (%)    | DGBE (%) | Conductivity $\sigma$ (S/m) | Permittivity $\epsilon$ |
| 750                                 | 41.1      | 57.0               | 0.2           | 1.4      | 0.2              | 0        | 0.89                        | 41.9                    |
| 835                                 | 40.3      | 57.9               | 0.2           | 1.4      | 0.2              | 0        | 0.90                        | 41.5                    |
| 900                                 | 40.3      | 57.9               | 0.2           | 1.4      | 0.2              | 0        | 0.97                        | 41.5                    |
| 1800, 1900, 2000                    | 55.2      | 0                  | 0             | 0.3      | 0                | 44.5     | 1.4                         | 40.0                    |
| 2450                                | 55.0      | 0                  | 0             | 0.1      | 0                | 44.9     | 1.80                        | 39.2                    |
| 2600                                | 54.9      | 0                  | 0             | 0.1      | 0                | 45.0     | 1.96                        | 39.0                    |
| Frequency(MHz)                      | Water (%) | Hexyl Carbitol (%) |               |          | Triton X-100 (%) |          | Conductivity $\sigma$ (S/m) | Permittivity $\epsilon$ |
| 5200                                | 62.52     | 17.24              |               |          | 17.24            |          | 4.66                        | 36.0                    |
| 5800                                | 62.52     | 17.24              |               |          | 17.24            |          | 5.27                        | 35.3                    |
| Body (From instrument manufacturer) |           |                    |               |          |                  |          |                             |                         |
| Frequency (MHz)                     | Water (%) | Sugar (%)          | Cellulose (%) | Salt (%) | Preventol (%)    | DGBE (%) | Conductivity $\sigma$ (S/m) | Permittivity $\epsilon$ |
| 750                                 | 51.7      | 47.2               | 0             | 0.9      | 0.1              | 0        | 0.96                        | 55.5                    |
| 835                                 | 50.8      | 48.2               | 0             | 0.9      | 0.1              | 0        | 0.97                        | 55.2                    |
| 900                                 | 50.8      | 48.2               | 0             | 0.9      | 0.1              | 0        | 1.05                        | 55.0                    |
| 1800, 1900, 2000                    | 70.2      | 0                  | 0             | 0.4      | 0                | 29.4     | 1.52                        | 53.3                    |
| 2450                                | 68.6      | 0                  | 0             | 0.1      | 0                | 31.3     | 1.95                        | 52.7                    |
| 2600                                | 68.2      | 0                  | 0             | 0.1      | 0                | 31.7     | 2.16                        | 52.5                    |

| Frequency(MHz) | Water | DGBE (%) | Salt (%) | Conductivity $\sigma$ (S/m) | Permittivity $\epsilon$ |
|----------------|-------|----------|----------|-----------------------------|-------------------------|
| 5200           | 78.60 | 21.40    | /        | 5.54                        | 47.86                   |
| 5800           | 78.50 | 21.40    | 0.1      | 6.0                         | 48.20                   |

## 5 SYSTEM VERIFICATION

### 5.1 Antenna Port Test Requirement

The SATIMO SAR system is equipped with one or more system validation kits. These units together with the predefined measurement procedures within the SATIMO software enable the user to conduct the system performance check and system validation. System validation kit includes a dipole, tripod holder to fix it underneath the flat phantom and a corresponding distance holder.

### 5.2 Purpose of System Check

The system performance check verifies that the system operates within its specifications. System and operator errors can be detected and corrected. It is recommended that the system performance check be performed prior to any usage of the system in order to guarantee reproducible results. The system performance check uses normal SAR measurements in a simplified setup with a well characterized source. This setup was selected to give a high sensitivity to all parameters that might fail or vary over time. The system check does not intend to replace the calibration of the components, but indicates situations where the system uncertainty is exceeded due to drift or failure.

### 5.3 System Check Setup

In the simplified setup for system evaluation, the EUT is replaced by a calibrated dipole and the power source is replaced by a continuous wave that comes from a signal generator. The calibrated dipole must be placed beneath the flat phantom section of the SAM twin phantom with the correct distance holder. The distance holder should touch the phantom surface with a light pressure at the reference marking and be oriented parallel to the long side of the phantom. The equipment setup is shown below:

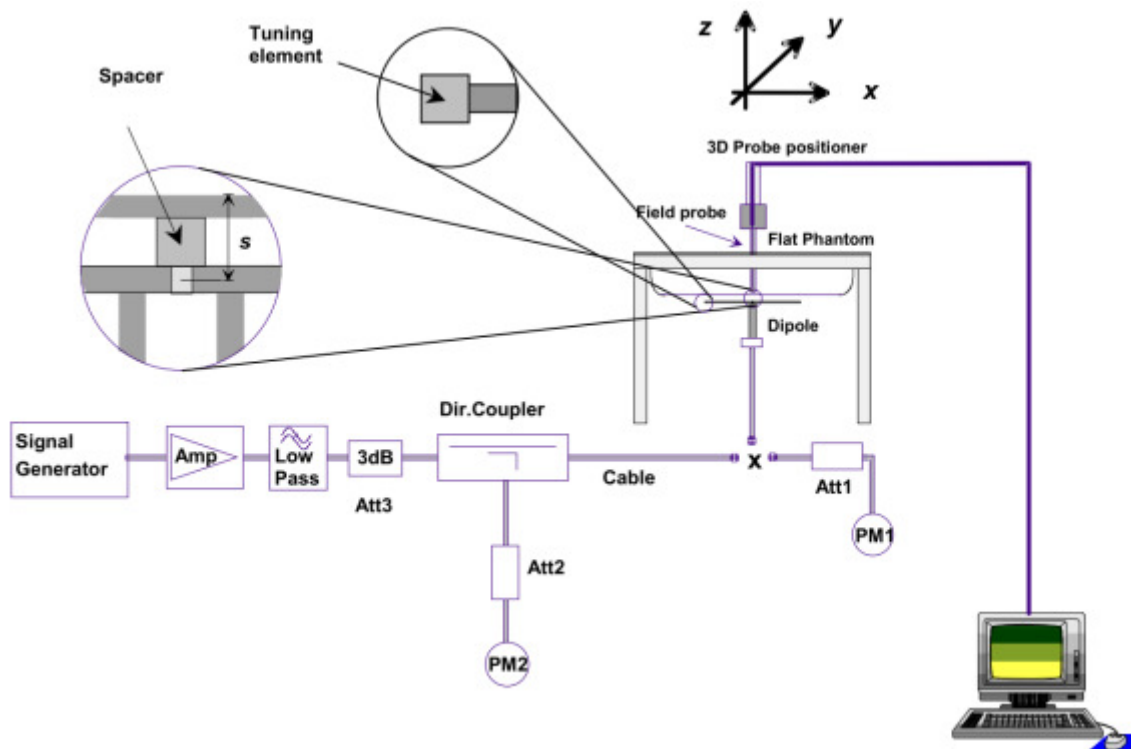

## 6 EUT TEST POSITION CONFIGURATIONS

According to KDB 648474 D04 Handset, handsets are tested for SAR compliance in head, body-worn accessory and other use configurations described in the following subsections.

### 6.1 Head Exposure Conditions

Head exposure is limited to next to the ear voice mode operations. Head SAR compliance is tested according to the test positions defined in IEEE Std 1528-2013 using the SAM phantom illustrated as below.

#### 6.1.1 Define two imaginary lines on the handset

- The vertical center line passes through two points on the front side of the handset - the midpoint of the width  $w_t$  of the handset at the level of the acoustic output, and the midpoint of the width  $w_b$  of the bottom of the handset.
- The horizontal line is perpendicular to the vertical centerline and passes through the center of the acoustic output. The horizontal line is also tangential to the face of the handset at point A.
- The two lines intersect at point A. Note that for many handsets, point A coincides with the center of the acoustic output; however, the acoustic output may be located elsewhere on the horizontal line. Also note that the vertical centerline is not necessarily parallel to the front face of the handset, especially for clamshell handsets, handsets with flip covers, and other irregularly shaped handsets.

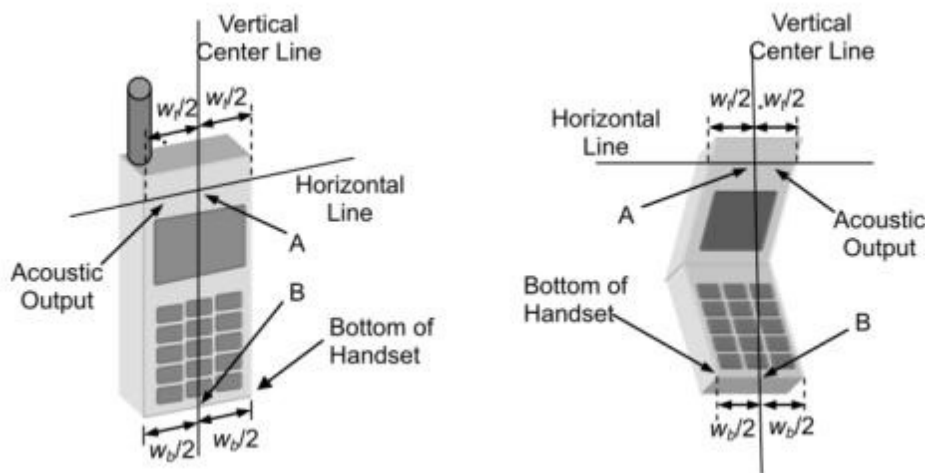

#### 6.1.2 Cheek Position

- To position the device with the vertical center line of the body of the device and the horizontal line crossing the center piece in a plane parallel to the sagittal plane of the phantom. While maintaining the device in this plane, align the vertical center line with the reference plane containing the three ear and mouth reference point (M: Mouth, RE: Right Ear, and LE: Left Ear) and align the center of the ear piece with the line RE-LE.
- To move the device towards the phantom with the ear piece aligned with the line LE-RE until the phone touched the ear. While maintaining the device in the reference plane and maintaining the phone contact with the ear, move the bottom of the phone until any point on the front side is in contact with the cheek of the phantom or until contact with the ear is lost.





### 6.1.3 Tilted Position

- (a) To position the device in the “cheek” position described above.
- (b) While maintaining the device the reference plane described above and pivoting against the ear, moves it outward away from the mouth by an angle of 15 degrees or until contact with the ear is lost.



## 6.2 Body-worn Position Conditions

Body-worn accessory exposure is typically related to voice mode operations when handsets are carried in body-worn accessories. The body-worn accessory procedures in KDB 447498 are used to test for body-worn accessory SAR compliance, without a headset connected to it. This enables the test results for such configuration to be compatible with that required for hotspot mode when the body-worn accessory test separation distance is greater than or equal to that required for hotspot mode. When the reported SAR for a body-worn accessory, measured without a headset connected to the handset, is  $> 1.2 \text{ W/kg}$ , the highest reported SAR configuration for that wireless mode and frequency band should be repeated for that body-worn accessory with a headset attached to the handset.

Body-worn accessories that do not contain metallic or conductive components may be tested according to worst-case exposure configurations, typically according to the smallest test separation distance required for the group of body-worn accessories with similar operating and exposure characteristics. All body-worn accessories containing metallic components are tested in conjunction with the host device.

Body-worn accessory SAR compliance is based on a single minimum test separation distance for all wireless and operating modes applicable to each body-worn accessory used by the host, and according to the relevant voice and/or data mode transmissions and operations. If a body-worn accessory supports voice only operations in its normal and expected use conditions, testing of data mode for body-worn compliance is not required. A conservative minimum test separation distance for supporting off-the-shelf body-worn accessories that may be acquired by

users of consumer handsets is used to test for body-worn accessory SAR compliance. This distance is determined by the handset manufacturer, according to the requirements of Supplement C 01-01. Devices that are designed to operate on the body of users using lanyards and straps, or without requiring additional body-worn accessories, will be tested using a conservative minimum test separation distance  $\leq 5$  mm to support compliance.

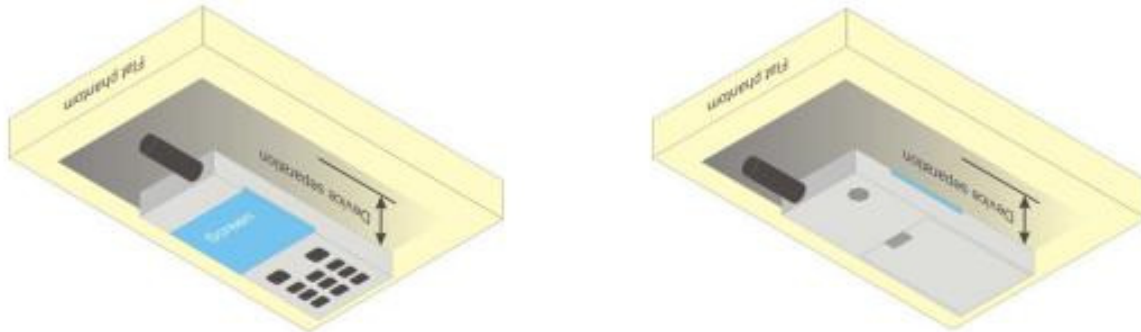

### 6.3 Hotspot Mode Exposure Position Conditions

For handsets that support hotspot mode operations, with wireless router capabilities and various web browsing functions, the relevant hand and body exposure conditions are tested according to the hotspot SAR procedures in KDB 941225. A test separation distance of 10 mm is required between the phantom and all surfaces and edges with a transmitting antenna located within 25 mm from that surface or edge. When the form factor of a handset is smaller than 9 cm x 5 cm, a test separation distance of 5 mm (instead of 10 mm) is required for testing hotspot mode. When the separation distance required for body-worn accessory testing is larger than or equal to that tested for hotspot mode, in the same wireless mode and for the same surface of the phone, the hotspot mode SAR data may be used to support body-worn accessory SAR compliance for that particular configuration (surface).

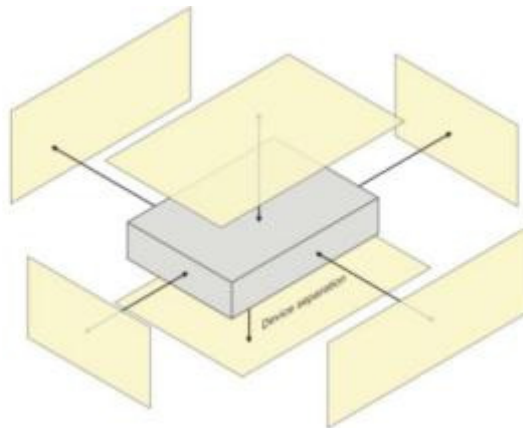

## 7 SAR MEASUREMENT PROCEDURES

### 7.1 SAR Measurement Process Diagram

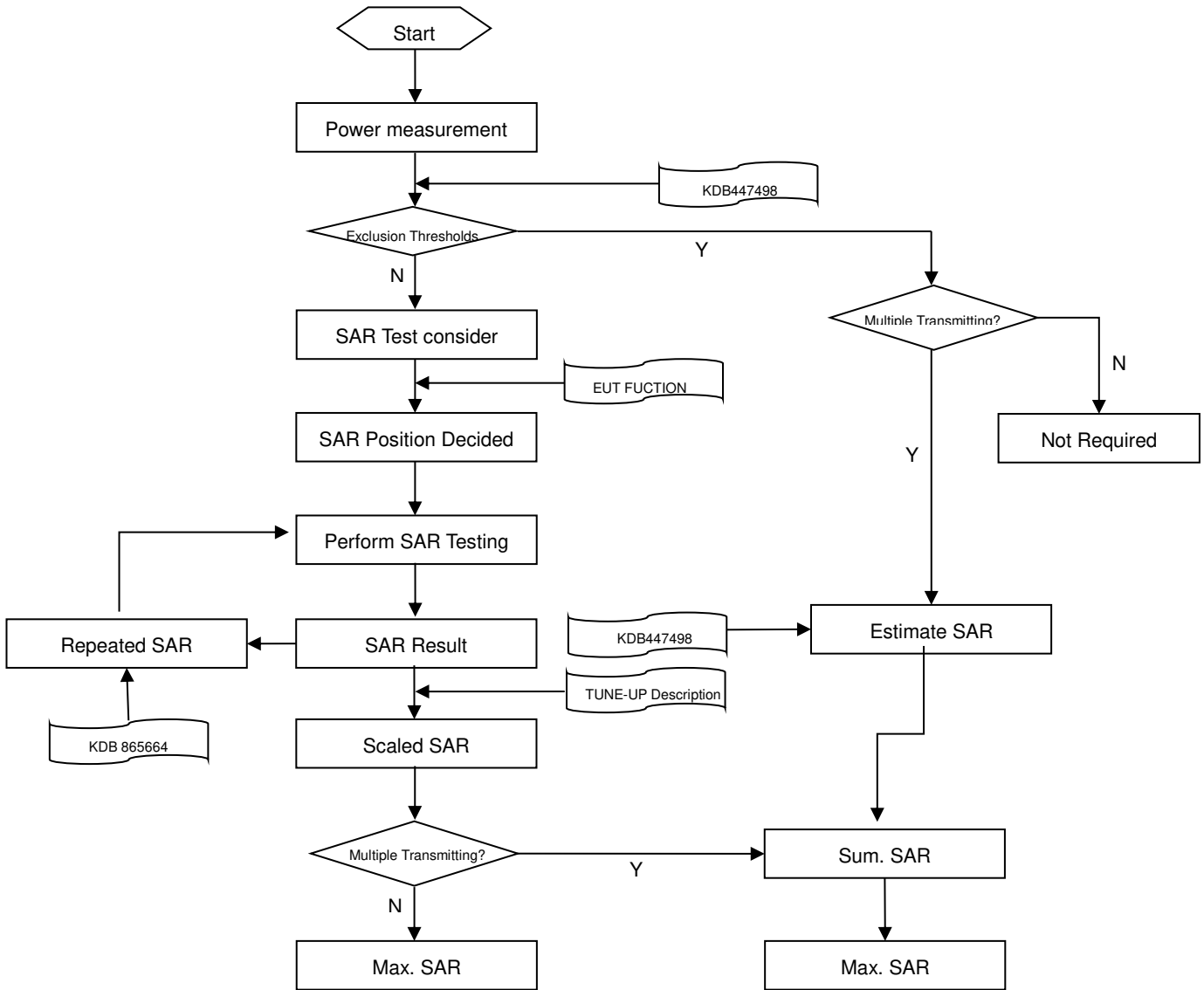

## 7.2 SAR Scan General Requirements

Probe boundary effect error compensation is required for measurements with the probe tip closer than half a probe tip diameter to the phantom surface. Both the probe tip diameter and sensor offset distance must satisfy measurement protocols; to ensure probe boundary effect errors are minimized and the higher fields closest to the phantom surface can be correctly measured and extrapolated to the phantom surface for computing 1-g SAR. Tolerances of the post-processing algorithms must be verified by the test laboratory for the scan resolutions used in the SAR measurements, according to the reference distribution functions specified in IEEE Std 1528-2013.

|  |                                   | ≤3GHz   | >3GHz  |
|--|-----------------------------------|---|--|
| Maximum distance from closest measurement point (geometric center of probe sensors) to phantom surface |                                   | 5±1 mm  | $\frac{1}{2} \cdot \delta \cdot \ln(2) \pm 0.5$ mm |
| Maximum probe angle from probe axis to phantom surface normal at the measurement location              |                                   | 30°±1°  | 20°±1°   |
| Maximum area scan spatial resolution: $\Delta x$ Area , $\Delta y$ Area                                |                                   | ≤ 2 GHz: ≤ 15 mm<br>2 – 3 GHz: ≤ 12 mm  | 3–4 GHz: ≤ 12 mm<br>4 – 6 GHz: ≤ 10 mm             |
|  |                                   | When the x or y dimension of the test device, in the measurement plane orientation, is smaller than the above, the measurement resolution must be ≤ the corresponding x or y dimension of the test device with at least one measurement point on the test device. |  |
| Maximum zoom scan spatial resolution: $\Delta x$ Zoom , $\Delta y$ Zoom                                |                                   | ≤ 2 GHz: ≤ 8 mm<br>2 – 3 GHz: ≤ 5 mm*   | 3–4 GHz: ≤ 5 mm*<br>4 – 6 GHz: ≤ 4 mm*             |
| Maximum zoom scan spatial resolution, normal to phantom surface  | uniform grid: $\Delta z$ Zoom (n) | ≤ 5 mm  | 3–4 GHz: ≤ 4 mm                                    |
|  |                                   |   | 4–5 GHz: ≤ 3 mm                                    |
|  |                                   |   | 5–6 GHz: ≤ 2 mm                                    |
|  | graded grid                       | $\Delta z$ Zoom (1):<br>between 1st two points closest to phantom surface<br><br>$\Delta z$ Zoom (n>1):<br>between subsequent points  | ≤ 4 mm   |
| 4–5 GHz: ≤ 2.5 mm  |                                   |   |  |
|  |                                   | ≤ 1.5· $\Delta z$ Zoom (n-1)  |  |
| Minimum zoom scan volume   | x, y, z                           | ≥30 mm  | 3–4 GHz: ≥ 28 mm                                   |
|  |                                   |   | 4–5 GHz: ≥ 25 mm                                   |
|  |                                   |   | 5–6 GHz: ≥ 22 mm                                   |

**Note:**

- $\delta$  is the penetration depth of a plane-wave at normal incidence to the tissue medium; see draft standard IEEE P1528-2011 for details.
- \* When zoom scan is required and the reported SAR from the area scan based 1-g SAR estimation procedures of KDB 447498 is ≤ 1.4 W/kg, ≤ 8 mm, ≤ 7 mm and ≤ 5 mm zoom scan resolution may be applied, respectively, for 2 GHz to 3GHz, 3 GHz to 4 GHz and 4 GHz to 6 GHz.

### 7.3 SAR Measurement Procedure

The following steps are used for each test position

- Establish a call with the maximum output power with a base station simulator. The connection between the mobile and the base station simulator is established via air interface
- Measurement of the local E-field value at a fixed location. This value serves as a reference value for calculating a possible power drift.
- Measurement of the SAR distribution with a grid of 8 to 16mm \* 8 to 16 mm and a constant distance to the inner surface of the phantom. Since the sensors cannot directly measure at the inner phantom surface, the values between the sensors and the inner phantom surface are extrapolated. With these values the area of the maximum SAR is calculated by an interpolation scheme.
- Around this point, a cube of 30 \* 30 \* 30 mm or 32 \* 32 \* 32 mm is assessed by measuring 5 or 8 \* 5 or 8\*4 or 5 mm. With these data, the peak spatial-average SAR value can be calculated.

### 7.4 Area & Zoom Scan Procedures

First Area Scan is used to locate the approximate location(s) of the local peak SAR value(s). The measurement grid within an Area Scan is defined by the grid extent, grid step size and grid offset. Next, in order to determine the EM field distribution in a three-dimensional spatial extension, Zoom Scan is required. The Zoom Scan is performed around the highest E-field value to determine the averaged SAR-distribution over 10 g. Area scan and zoom scan resolution setting follows KDB 865664 D01 quoted below.

When the 1-g SAR of the highest peak is within 2 dB of the SAR limit, additional zoom scans are required for other peaks within 2 dB of the highest peak that have not been included in any zoom scan to ensure there is no increase in SAR.

## 8 CONDUCTED RF OUTPUT POWER

### 8.1 WIFI

#### 8.1.1 2.4GWIFI

| Band (GHz)          | Mode          | Channel | Freq. (MHz) | Peak Power (dBm) | SAR Test Require. |
|---------------------|---------------|---------|-------------|------------------|-------------------|
| 2.4<br>(2.4~2.4835) | 802.11b       | 1       | 2412        | 15.92            | No                |
|                     |               | 6       | 2437        | <b>16.84</b>     | Yes               |
|                     |               | 11      | 2462        | 15.60            | No                |
|                     | 802.11g       | 1       | 2412        | 18.25            | No                |
|                     |               | 6       | 2437        | 21.84            | No                |
|                     |               | 11      | 2462        | 17.64            | No                |
|                     | 802.11n(HT20) | 1       | 2412        | 18.29            | No                |
|                     |               | 6       | 2437        | 21.75            | No                |
|                     |               | 11      | 2462        | 17.52            | No                |
|                     | 802.11n(HT40) | 3       | 2422        | 17.26            | No                |
|                     |               | 6       | 2437        | <b>22.21</b>     | Yes               |
|                     |               | 9       | 2452        | 16.59            | No                |

### 8.2 Bluetooth

| Mode             | GFSK   |             |       | $\pi/4$ -DQPSK |       |       |
|------------------|--------|-------------|-------|----------------|-------|-------|
| Channel          | 0      | 39          | 78    | 0              | 39    | 78    |
| Frequency (MHz)  | 2402   | 2441        | 2480  | 2402           | 2441  | 2480  |
| Peak Power (dBm) | 0.68   | 0.90        | -0.99 | 0.35           | 0.40  | -0.90 |
| Mode             | 8-DPSK |             |       | BLE            |       |       |
| Channel          | 0      | 39          | 78    | 0              | 19    | 39    |
| Frequency (MHz)  | 2402   | 2441        | 2480  | 2402           | 2440  | 2480  |
| Peak Power (dBm) | 0.46   | <b>0.51</b> | -0.83 | -5.64          | -3.76 | -7.84 |

### 8.3 Rated RF Power Output

| Band (GHz)          | Mode          | Range(dBm)  |
|---------------------|---------------|-------------|
| 2.4<br>(2.4~2.4835) | 802.11b       | 15.50-16.95 |
|                     | 802.11g       | 17.55-21.95 |
|                     | 802.11n(HT20) | 17.40-21.85 |
|                     | 802.11n(HT40) | 16.50-22.30 |

| Band (GHz) | Mode   | Range(dBm)      |
|------------|--------|-----------------|
| Bluetooth  | BR/EDR | (-1.10)-(-1.00) |
|            | BLE    | (-7.95)-(-3.65) |

### 9 EUT ANTENNA LOCATION SKETCH

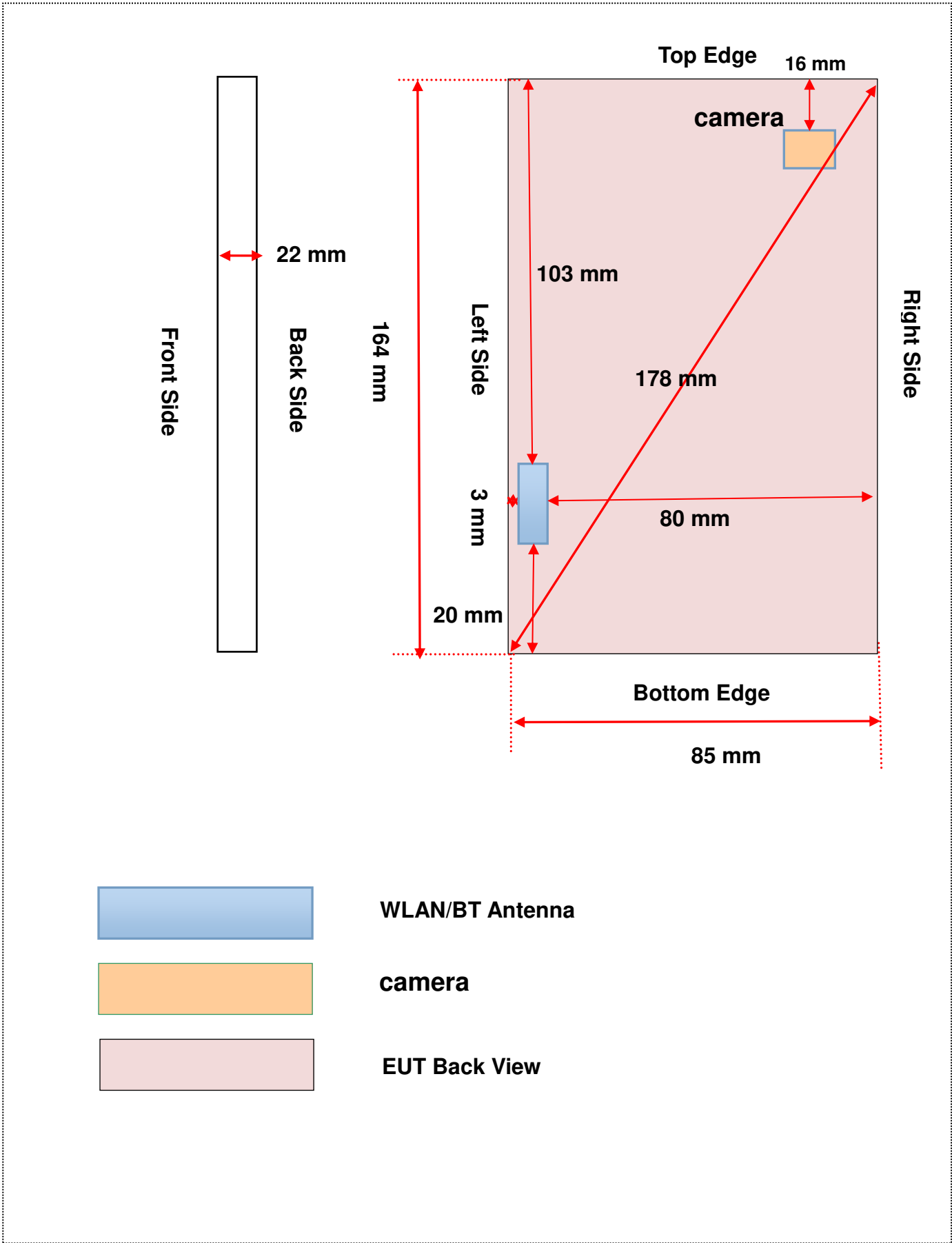



## 9.1 SAR Test Exclusion Consider Table

According with FCC KDB 447498 D01, Appendix A, <SAR Test Exclusion Thresholds for 100 MHz - 6 GHz and ≤ 50 mm> Table, this Device SAR test configurations consider as following :

| Band          | Mode                               | Max. Peak Power |        | Test Position Configurations |      |           |            |          |             |
|---------------|------------------------------------|-----------------|--------|------------------------------|------|-----------|------------|----------|-------------|
|               |                                    | dBm             | mW     | Front                        | Back | Left Edge | Right Edge | Top Edge | Bottom Edge |
| WLAN<br>2.4 G | Distance to User                   |                 |        | <5mm                         | <5mm | <5mm      | 80mm       | 103mm    | 20 mm       |
|               | SAR exclusion threshold power (mW) |                 |        | 10                           | 10   | 10        | 396        | 626      | 38          |
|               | 802.11b                            | 16.95           | 49.55  | Yes                          | Yes  | Yes       | No         | No       | Yes         |
|               | 802.11g                            | 21.95           | 156.68 | Yes                          | Yes  | Yes       | No         | No       | Yes         |
|               | 802.11n(HT20)                      | 21.85           | 153.11 | Yes                          | Yes  | Yes       | No         | No       | Yes         |
|               | 802.11n(HT40)                      | 22.30           | 169.82 | Yes                          | Yes  | Yes       | No         | No       | Yes         |
| Bluetooth     | Distance to User                   |                 |        | <5mm                         | <5mm | <5mm      | 80mm       | 103mm    | 20 mm       |
|               | SAR exclusion threshold power (mW) |                 |        | 10                           | 10   | 10        | 396        | 626      | 38          |
|               | Bluetooth BR/EDR                   | 1.00            | 1.26   | No                           | No   | No        | No         | No       | No          |
|               | Bluetooth BLE                      | -3.65           | 0.43   | No                           | No   | No        | No         | No       | No          |

Note:

- Maximum power is the source-based time-average power and represents the maximum RF output power among production units.
- Per KDB 447498 D01, for larger devices, the test separation distance of adjacent edge configuration is determined by the closest separation between the antenna and the user.
- Per KDB 447498 D01, standalone SAR test exclusion threshold is applied; If the distance of the antenna to the user is < 5mm, 5mm is used to determine SAR exclusion threshold
- Per KDB 447498 D01, the 1-g and 10-g SAR test exclusion thresholds for 100 MHz to 6 GHz at test separation distances ≤ 50 mm are determined by:
 
$$[(\text{max. power of channel, including tune-up tolerance, mW}) / (\text{min. test separation distance, mm})] \cdot [\sqrt{f(\text{GHz})}] \leq 3.0 \text{ for 1-g SAR and } \leq 7.5 \text{ for 10-g extremity SAR}$$
  - f(GHz) is the RF channel transmit frequency in GHz
  - Power and distance are rounded to the nearest mW and mm before calculation
  - The result is rounded to one decimal place for comparison
  - For < 50 mm distance, we just calculate mW of the exclusion threshold value (3.0) to do compare.
 This formula is  $[3.0] / [\sqrt{f(\text{GHz})}] \cdot [(\text{min. test separation distance, mm})] = \text{exclusion threshold of mW}$ .
- Per KDB 447498 D01, at 100 MHz to 6 GHz and for test separation distances > 50 mm, the SAR test exclusion threshold is determined according to the following:
  - [Threshold at 50 mm in step 1) + (test separation distance - 50 mm) · (f(MHz)/150)] mW, at 100 MHz to 1500 MHz
  - [Threshold at 50 mm in step 1) + (test separation distance - 50 mm) · 10] mW at > 1500 MHz and ≤ 6 GHz
- Per KDB 248227 D01, choose the highest output power channel to test SAR and determine further SAR exclusion.8. For each frequency band, testing at higher data rates and higher order modulations is not required when the maximum average output power for each of these configurations is less than 1/4dB higher than those measured at the lowest data rate
- Per KDB 248227 D01 SAR is not required for the following 2.4 GHz OFDM conditions.
  - When KDB Publication 447498 D01 SAR test exclusion applies to the OFDM configuration.

b. When the highest reported SAR for DSSS is adjusted by the ratio of OFDM to DSSS specified maximum output power and the adjusted SAR is  $\leq 1.2$  W/kg.

# 10 TEST RESULTS

## 10.1 WIFI 2.4GHZ

| Mode             | Position    | Dist. (mm) | Ch. | Freq. (MHz) | Power Drift (%) | 1 g Meas. SAR (W/Kg) | Meas. Power (dBm) | Max. tune-up Power(dBm) | Scaling Factor | 1 g Scaled SAR (W/Kg) | Meas. No. |
|------------------|-------------|------------|-----|-------------|-----------------|----------------------|-------------------|-------------------------|----------------|-----------------------|-----------|
| <b>Body</b>      |             |            |     |             |                 |                      |                   |                         |                |                       |           |
| 802.11 b         | Front Side  | 0          | 6   | 2437        | -3.74           | 0.080                | 16.84             | 16.95                   | 1.03           | 0.082                 | 1#        |
|                  | Back Side   | 0          | 6   | 2437        | -2.30           | 0.090                | 16.84             | 16.95                   | 1.03           | 0.092                 | 2#        |
|                  | Left Edge   | 0          | 6   | 2437        | -2.45           | 0.297                | 16.84             | 16.95                   | 1.03           | <b>0.305</b>          | 3#        |
|                  | Right Edge  | 0          | 6   | 2437        | -4.03           | 0.043                | 16.84             | 16.95                   | 1.03           | 0.044                 | 4#        |
|                  | Bottom Edge | 0          | 6   | 2437        | -4.24           | 0.033                | 16.84             | 16.95                   | 1.03           | 0.034                 | 5#        |
| 802.11 n (HT-40) | Front Side  | 0          | 6   | 2437        | 4.32            | 0.064                | 22.21             | 22.30                   | 1.02           | 0.065                 | 6#        |
|                  | Back Side   | 0          | 6   | 2437        | -3.99           | 0.075                | 22.21             | 22.30                   | 1.02           | 0.077                 | 7#        |
|                  | Left Edge   | 0          | 6   | 2437        | -1.29           | 0.236                | 22.21             | 22.30                   | 1.02           | 0.241                 | 8#        |
|                  | Right Edge  | 0          | 6   | 2437        | 1.15            | 0.043                | 22.21             | 22.30                   | 1.02           | 0.044                 | 9#        |
|                  | Bottom Edge | 0          | 6   | 2437        | -3.45           | 0.034                | 22.21             | 22.30                   | 1.02           | 0.035                 | 10#       |

## 11 SAR Measurement Variability

According to KDB 865664 D01, SAR measurement variability was assessed for each frequency band, which is determined by the SAR probe calibration point and tissue-equivalent medium used for the device measurements. When both head and body tissue-equivalent media are required for SAR measurements in a frequency band, the variability measurement procedures should be applied to the tissue medium with the highest measured SAR, using the highest measured SAR configuration for that tissue-equivalent medium. Alternatively, if the highest measured SAR for both head and body tissue-equivalent media are  $\leq 1.45$  W/kg and the ratio of these highest SAR values, i.e., largest divided by smallest value, is  $\leq 1.10$ , the highest SAR configuration for either head or body tissue-equivalent medium may be used to perform the repeated measurement. These additional measurements are repeated after the completion of all measurements requiring the same head or body tissue-equivalent medium in a frequency band. The test device should be returned to ambient conditions (normal room temperature) with the battery fully charged before it is re-mounted on the device holder for the repeated measurement(s) to minimize any unexpected variations in the repeated results.

SAR repeated measurement procedure:

1. When the highest measured SAR is  $< 0.80$  W/kg, repeated measurement is not required.
2. When the highest measured SAR is  $\geq 0.80$  W/kg, repeat that measurement once.
3. If the ratio of largest to smallest SAR for the original and first repeated measurements is  $> 1.20$ , or when the original or repeated measurement is  $\geq 1.45$  W/kg, perform a second repeated measurement.
4. If the ratio of largest to smallest SAR for the original, first and second repeated measurements is  $> 1.20$ , and the original, first or second repeated measurement is  $\geq 1.5$  W/kg, perform a third repeated measurement.

The highest measured SAR is 0.305 less than 0.80 W/kg, so repeated measurement is not required.

## 12 SIMULTANEOUS TRANSMISSION

The Bluetooth and WLAN share the same antenna, can't transmitting together, simultaneous multi-band transmission evaluation is not required in this report.

### 12.1 Estimated SAR Calculation

According to KDB 447498 D01 when standalone SAR test exclusion applies to an antenna that transmits simultaneously with other antennas, the standalone SAR was estimated according to following formula to result in substantially conservative SAR values of  $\leq 0.4$  W/kg to determine simultaneous transmission SAR test exclusion.

$$\text{Estimated SAR} = \frac{\text{Max. Tune Up Power (mw)}}{\text{Min Test Separation Distance}} * \frac{\sqrt{f_{\text{GHz}}}}{x} \quad (\text{where } x = 7.5 \text{ for 1-g SAR})$$

If the minimum test separation distance is  $< 5$  mm, a distance of 5 mm is used for estimated SAR calculation. When the test separation distance is  $> 50$  mm, the 0.4 W/kg is used for SAR-1g.

| Band      | Mode | Position    | Antenna To user (mm) | SAR Testing | Max. Tune-up Power (dBm) | Max. Tune-up Power (mW) | Frequency (GHz) | Calculation Distance/Gap (mm) | Estimated SAR (W/kg) |
|-----------|------|-------------|----------------------|-------------|--------------------------|-------------------------|-----------------|-------------------------------|----------------------|
| Bluetooth | GFSK | Front side  | <5                   | NO          | 1.00                     | 1.26                    | 2.441           | 5                             | 0.052                |
|           |      | Back Side   | <5                   | NO          | 1.00                     | 1.26                    | 2.441           | 5                             | 0.052                |
|           |      | Left Edge   | <5                   | NO          | 1.00                     | 1.26                    | 2.441           | 5                             | 0.052                |
|           |      | Right Edge  | 80                   | NO          | 1.00                     | 1.26                    | 2.441           | 80                            | 0.003                |
|           |      | Bottom Edge | 20                   | NO          | 1.00                     | 1.26                    | 2.441           | 20                            | 0.013                |
|           |      | Top Edge    | 108                  | NO          | 1.00                     | 1.26                    | 2.441           | 108                           | 0.002                |

## 13 TEST EQUIPMENTS LIST

| Description                        | Manufacturer | Model              | Serial No.              | Cal. Date  | Cal. Due   |
|------------------------------------|--------------|--------------------|-------------------------|------------|------------|
| PC                                 | Dell         | N/A                | N/A                     | N/A        | N/A        |
| 2450MHz Dipole                     | SATIMO       | SID 2450           | S/N 25/13 DIP 2G450-251 | 2015/03/16 | 2018/03/15 |
| E-Field Probe                      | MVG          | SSE2               | S/N 34/15 EPGO 265      | 2016/09/15 | 2017/09/14 |
| Antenna                            | SATIMO       | ANTA3              | SN 17/13 ZNTA45         | N/A        | N/A        |
| Phantom1                           | SATIMO       | SAM                | SN 30/13 SAM103         | N/A        | N/A        |
| Phantom2                           | SATIMO       | SAM                | SN 30/13 SAM104         | N/A        | N/A        |
| Dielectric Probe Kit               | SATIMO       | SCLMP              | SN 25/13 OCPG56         | 2016/07/13 | 2017/07/12 |
| MultiMeter                         | Keithley     | MultiMeter<br>2000 | 4024022                 | 2016/07/13 | 2017/07/12 |
| Signal Generator                   | R&S          | SMF100A            | 1167.0000k02/104260     | 2016/07/13 | 2017/07/12 |
| Power Meter                        | Agilent      | E4419B             | GB40201833              | 2016/07/13 | 2017/07/12 |
| Power Sensor                       | R&S          | NRP-Z21            | 103971                  | 2016/07/13 | 2017/07/12 |
| Power Amplifier                    | SATIMO       | 6552B              | 22374                   | N/A        | N/A        |
| Wireless Communication<br>Test Set | R&S          | CMW 500            | 138884                  | 2016/07/13 | 2017/07/12 |
| Network Analyzer                   | R&S          | ZVL-6              | 101380                  | 2016/07/13 | 2017/07/12 |
| Attenuator                         | COM-MW       | ZA-S1-31           | 1305003187              | N/A        | N/A        |
| Directional coupler                | AA-MCS       | AAMCS-UDC          | 000272                  | N/A        | N/A        |
| Thermometer                        | Elitech      | RC-4HC             | N/A                     | 2016/03/02 | 2017/03/01 |

Note: Per KDB 865664 Dipole SAR Validation Verification, BALUN LAB has adopted 3 years calibration intervals. On annual basis, every measurement dipole has been evaluated and is in compliance with the following criteria:

1. There is no physical damage on the dipole;
2. System validation with specific dipole is within 10% of calibrated value;
3. Return-loss in within 20% of calibrated measurement.

## ANNEX A SIMULATING LIQUID VERIFICATION RESULT

The dielectric parameters of the liquids were verified prior to the SAR evaluation using an SCLMP Dielectric Probe Kit.

| Date       | Liquid Type | Fre. (MHz) | Temp. (°C) | Meas. Conductivity ( $\sigma$ ) (S/m) | Meas. Permittivity ( $\epsilon$ ) | Target Conductivity ( $\sigma$ ) (S/m) | Target Permittivity ( $\epsilon$ ) | Conductivity Tolerance (%) | Permittivity Tolerance (%) |
|------------|-------------|------------|------------|---------------------------------------|-----------------------------------|--|------------------------------------|----------------------------|----------------------------|
| 2016.11.23 | Body        | 2450       | 21.1       | 2.02                                  | 51.96                             | 1.95                                   | 52.70                              | 3.59                       | -1.40                      |

Note: The tolerance limit of Conductivity and Permittivity is  $\pm 5\%$ .

## ANNEX B SYSTEM CHECK RESULT

Comparing to the original SAR value provided by SATIMO, the validation data should be within its specification of 10%(for 1 g).

| Date       | Liquid Type | Freq. (MHz) | Power (mW) | Measured SAR (W/kg) | Normalized SAR (W/kg) | Dipole SAR (W/kg) | Tolerance (%) | Targeted SAR(W/kg) | Tolerance (%) |
|------------|-------------|-------------|------------|---------------------|-----------------------|-------------------|---------------|--------------------|---------------|
| 2016.11.23 | Body        | 2450        | 100        | 5.463               | 54.63                 | 54.70             | -0.13         | 52.40              | 4.26          |

Note: The tolerance limit of System validation  $\pm 10\%$ .



# System Performance Check Data(2450 MHz Body)

Type: Phone measurement (Complete)  
 E-Field Probe: SN 34/15 SSE2 EPGO265  
 Area scan resolution: dx=8mm,dy=8mm  
 Zoom scan resolution: dx=5mm, dy=5mm, dz=5mm  
 Date of measurement: 2016.11.23  
 Measurement duration: 19 minutes 56 seconds

## Experimental conditions.

|  |                   |
|--|-------------------|
| <b>Phantom File</b>                      | surf_sam_plan.txt |
| <b>Phantom</b>                           | Validation plane  |
| <b>Band</b>                              | 2450MHz           |
| <b>Signal</b>                            | CW                |
| <b>Frequency (MHz)</b>                   | 2450.000000       |
| <b>Relative permittivity (real part)</b> | 51.959317         |
| <b>Conductivity (S/m)</b>                | 2.023719          |
| <b>Power drift (%)</b>                   | 0.190000          |
| <b>Ambient Temperature:</b>              | 22.3°C            |
| <b>Liquid Temperature:</b>               | 21.1°C            |
| <b>ConvF:</b>                            | 2.55              |
| <b>Crest factor:</b>                     | 1:1               |

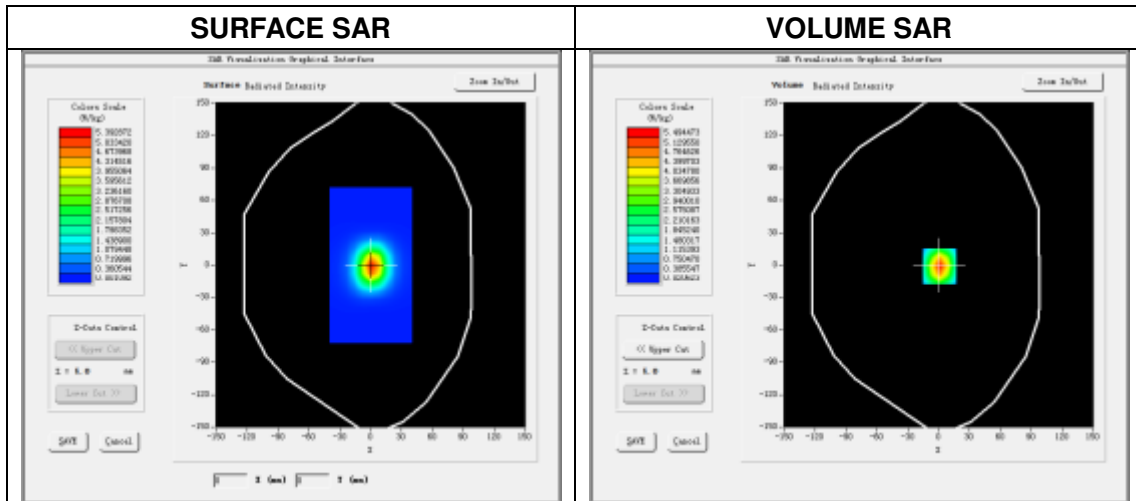

Maximum location: X=1.00, Y=-1.00  
 SAR Peak: 9.68W/kg

|                |          |
|----------------|----------|
| SAR 10g (W/Kg) | 2.302133 |
| SAR 1g (W/Kg)  | 5.462953 |

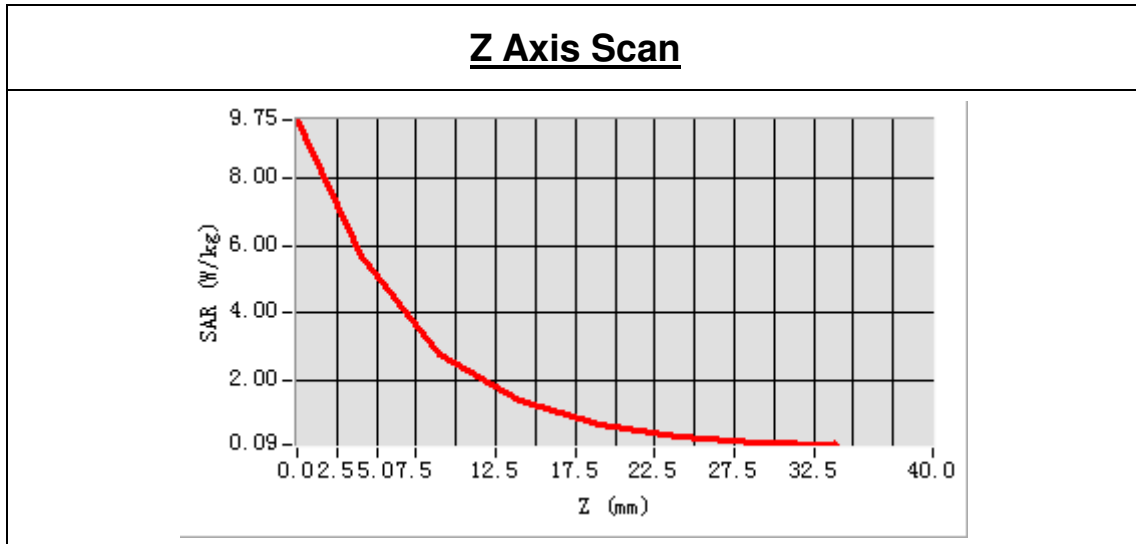

| 3D screen shot | Hot spot position |
|----------------|-------------------|
|                |                   |

## ANNEX C TEST DATA

### MEAS. 1 Body Plane with Front Side on Middle Channel in IEEE 802.b mode

**Test Date:** 23/11/2016  
**Measurement duration:** 17 minutes 39 seconds  
**Signal:** WLAN, f=2437.0 MHz, Duty Cycle: 1:1.0  
**Liquid Parameters:** Permittivity: 52.06; Conductivity: 2.00 S/m  
**Test condition:** Ambient Temperature: 22.3°C, Liquid Temperature: 21.1°C  
**Probe:** SN 34/15 SSE2 EPGO265, ConvF: 2.55  
**Area Scan:** sam\_direct\_droit2\_surf12mm.txt, h= 5.00 mm  
**Zoom Scan:** 7x7x7,dx=5mm, dy=5mm, dz=5mm,Complete  
**Maximum location:** X=8.000000, Y=0.000000  
**SAR 10g (W/Kg):** 0.045707  
**SAR 1g (W/Kg):** 0.080321  
**Power drift (%):** -3.74  
**3D screen shot**

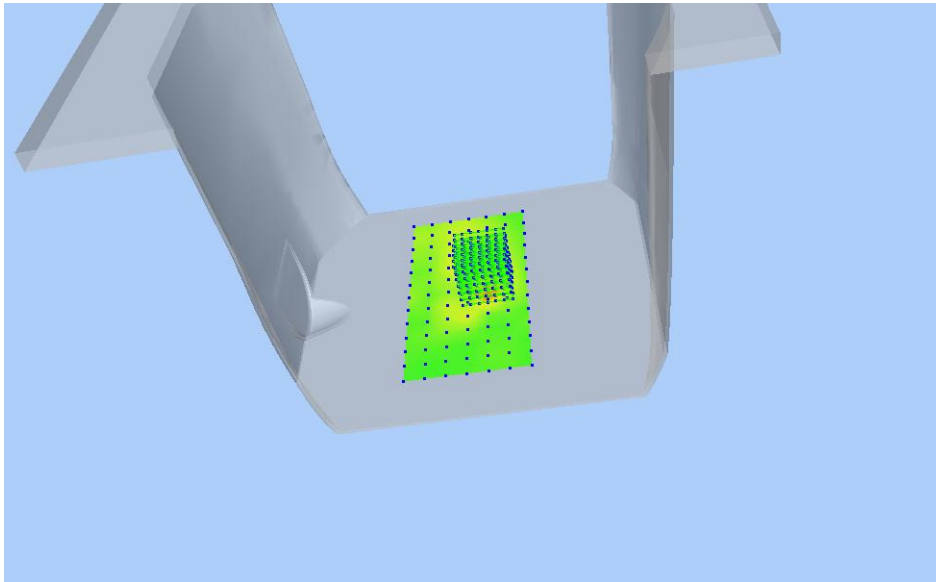

#### Z Axis Scan

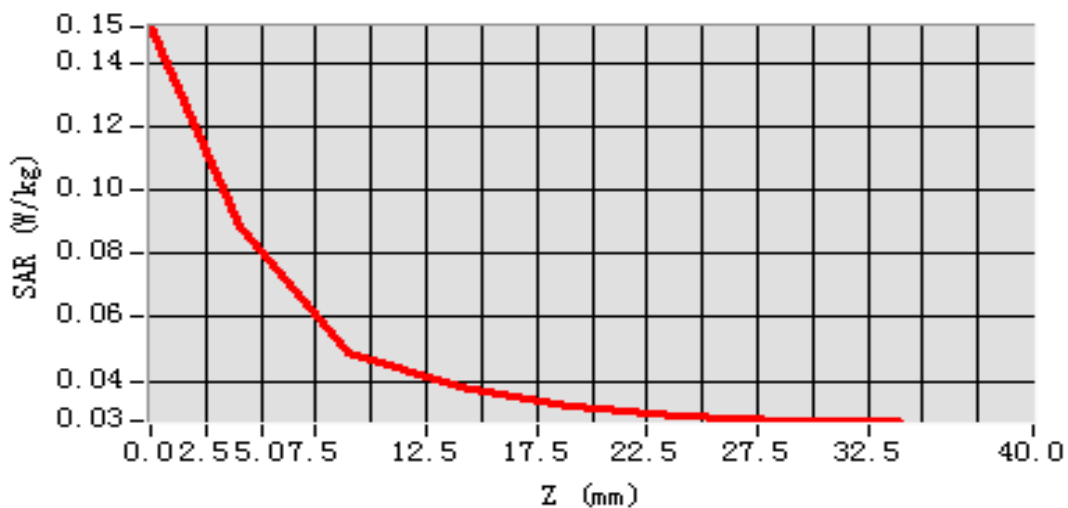

## MEAS. 2 Body Plane with Back Side on Middle Channel in IEEE 802.b mode

**Test Date:** 23/11/2016  
**Measurement duration:** 12 minutes 18 seconds  
**Signal:** WLAN, f=2437.0 MHz, Duty Cycle: 1:1.0  
**Liquid Parameters:** Permittivity: 52.06; Conductivity: 2.00 S/m  
**Test condition:** Ambient Temperature: 22.3°C, Liquid Temperature: 21.1°C  
**Probe:** SN 34/15 SSE2 EPGO265, ConvF: 2.55  
**Area Scan:** sam\_direct\_droit2\_surf12mm.txt, h= 5.00 mm  
**Zoom Scan:** 7x7x7,dx=5mm, dy=5mm, dz=5mm,Complete  
**Maximum location:** X=-16.000000, Y=12.000000  
**SAR 10g (W/Kg):** 0.058450  
**SAR 1g (W/Kg):** 0.090412  
**Power drift (%):** -2.30  
**3D screen shot**

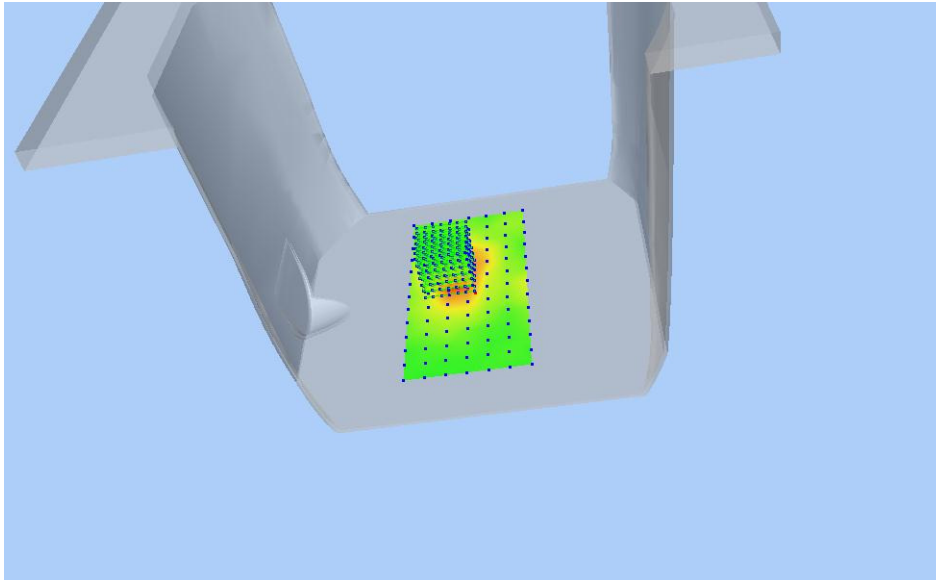

### Z Axis Scan

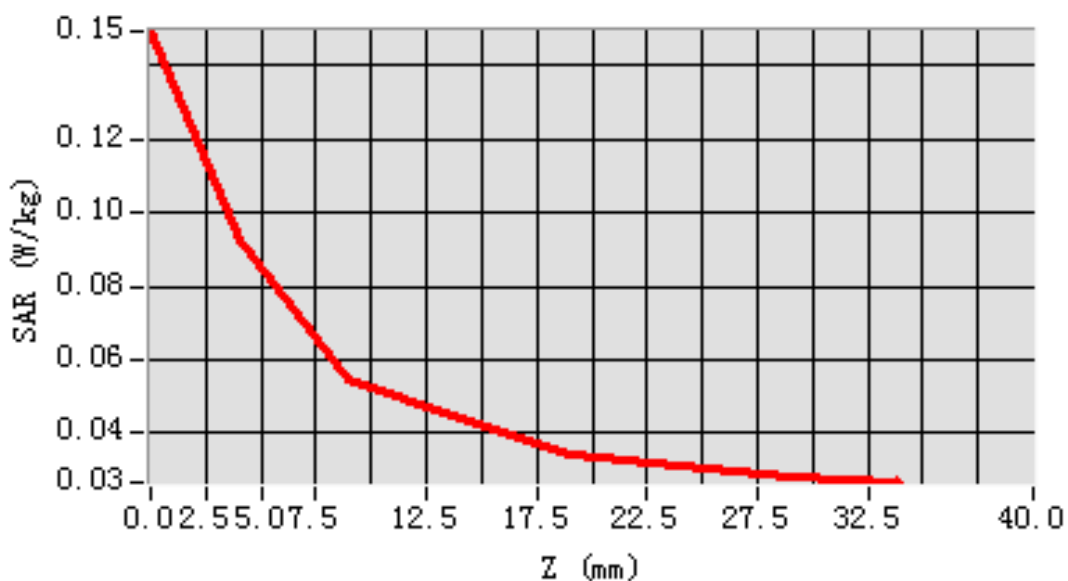

### MEAS. 3 Body Plane with Left Side on Middle Channel in IEEE 802.b mode

**Test Date:** 23/11/2016  
**Measurement duration:** 15 minutes 32 seconds  
**Signal:** WLAN, f=2437.0 MHz, Duty Cycle: 1:1.0  
**Liquid Parameters:** Permittivity: 52.06; Conductivity: 2.00 S/m  
**Test condition:** Ambient Temperature: 22.3°C, Liquid Temperature: 21.1°C  
**Probe:** SN 34/15 SSE2 EPGO265, ConvF: 2.55  
**Area Scan:** sam\_direct\_droit2\_surf12mm.txt, h= 5.00 mm  
**Zoom Scan:** 7x7x7,dx=5mm, dy=5mm, dz=5mm,Complete  
**Maximum location:** X=-4.000000, Y=0.000000  
**SAR 10g (W/Kg):** 0.136793  
**SAR 1g (W/Kg):** 0.297220  
**Power drift (%):** -2.45  
**3D screen shot**

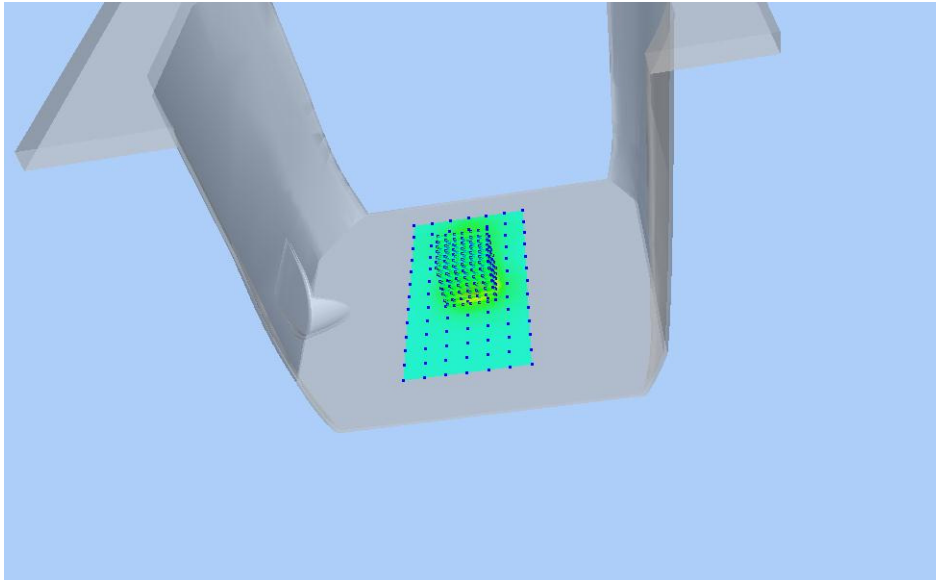

#### Z Axis Scan

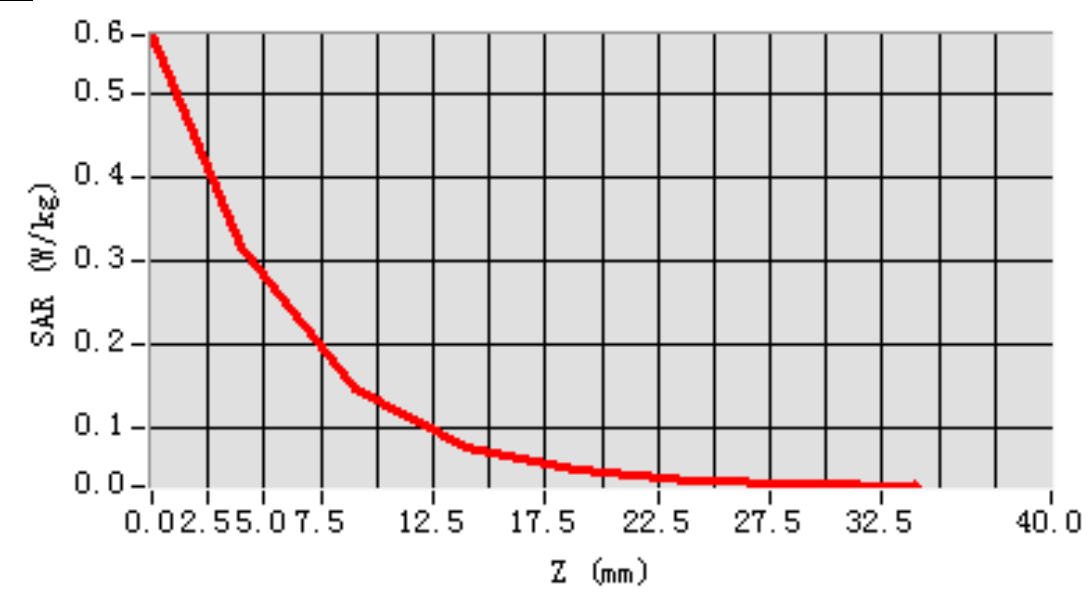

## MEAS. 4 Body Plane with Right Side on Middle Channel in IEEE 802.b mode

**Test Date:** 23/11/2016  
**Measurement duration:** 17 minutes 14 seconds  
**Signal:** WLAN, f=2437.0 MHz, Duty Cycle: 1:1.0  
**Liquid Parameters:** Permittivity: 52.06; Conductivity: 2.00 S/m  
**Test condition:** Ambient Temperature: 22.3°C, Liquid Temperature: 21.1°C  
**Probe:** SN 34/15 SSE2 EPGO265, ConvF: 2.55  
**Area Scan:** sam\_direct\_droit2\_surf12mm.txt, h= 5.00 mm  
**Zoom Scan:** 7x7x7,dx=5mm, dy=5mm, dz=5mm,Complete  
**Maximum location:** X=8.000000, Y=-12.000000  
**SAR 10g (W/Kg):** 0.035736  
**SAR 1g (W/Kg):** 0.043176  
**Power drift (%):** -4.03  
**3D screen shot**

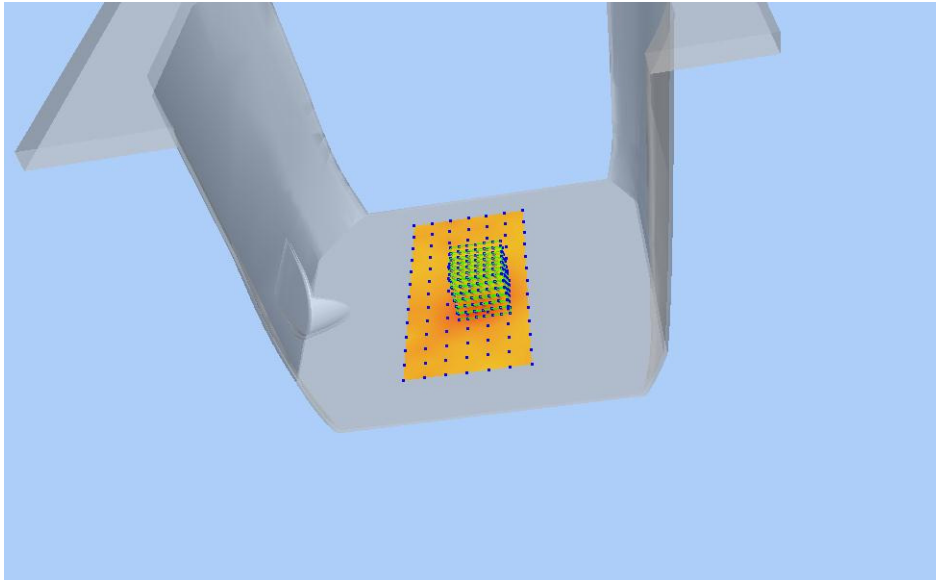

### Z Axis Scan

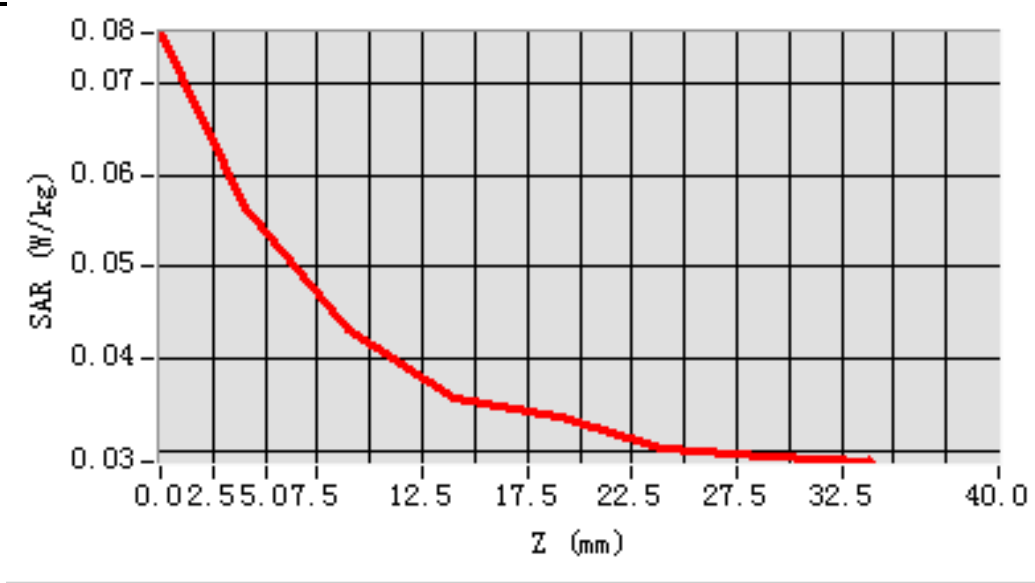

## MEAS. 5 Body Plane with Bottom Side on Middle Channel in IEEE 802.b mode

**Test Date:** 23/11/2016  
**Measurement duration:** 12 minutes 8 seconds  
**Signal:** WLAN, f=2437.0 MHz, Duty Cycle: 1:1.0  
**Liquid Parameters:** Permittivity: 52.06; Conductivity: 2.00 S/m  
**Test condition:** Ambient Temperature: 22.3°C, Liquid Temperature: 21.1°C  
**Probe:** SN 34/15 SSE2 EPGO265, ConvF: 2.55  
**Area Scan:** sam\_direct\_droit2\_surf12mm.txt, h= 5.00 mm  
**Zoom Scan:** 7x7x7,dx=5mm, dy=5mm, dz=5mm,Complete  
**Maximum location:** X=-16.000000, Y=12.000000  
**SAR 10g (W/Kg):** 0.029742  
**SAR 1g (W/Kg):** 0.032964  
**Power drift (%):** -4.24  
**3D screen shot**

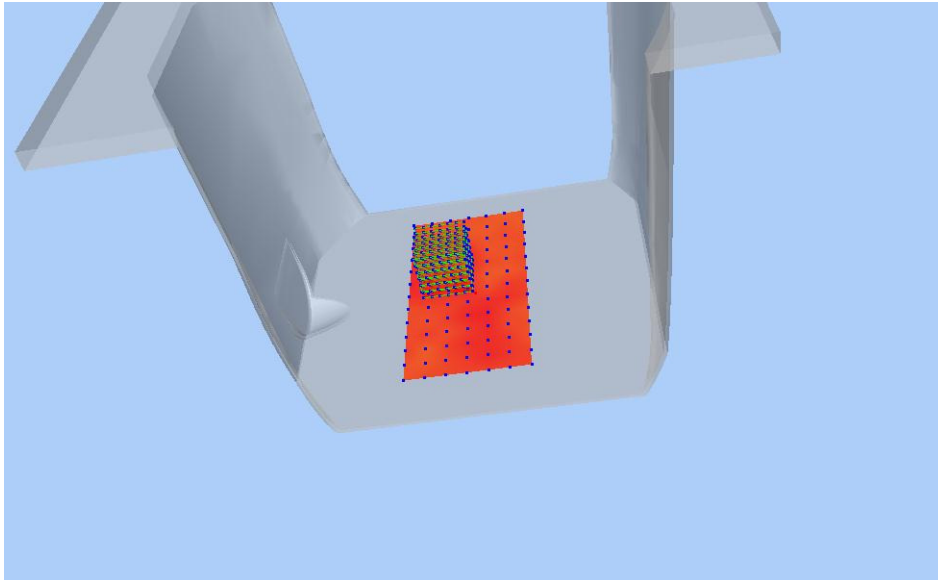

### Z Axis Scan

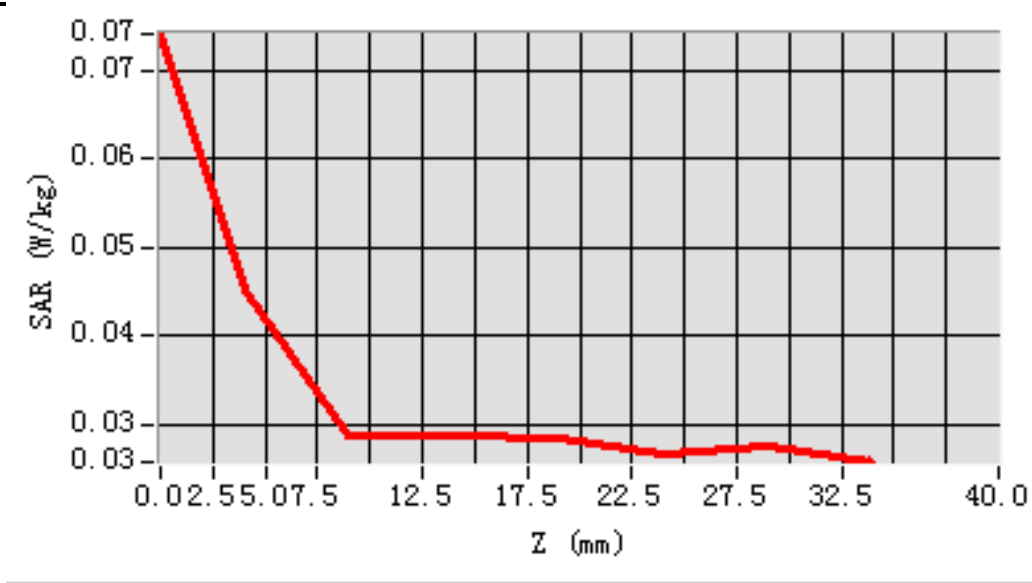

## MEAS. 6 Body Plane with Front Side on Middle Channel in IEEE 802.n(HT-40)

### mode

**Test Date:** 23/11/2016  
**Measurement duration:** 17 minutes 37 seconds  
**Signal:** WLAN, f=2437.0 MHz, Duty Cycle: 1:1.0  
**Liquid Parameters:** Permittivity: 52.06; Conductivity: 2.00 S/m  
**Test condition:** Ambient Temperature: 22.3°C, Liquid Temperature: 21.1°C  
**Probe:** SN 34/15 SSE2 EPGO265, ConvF: 2.55  
**Area Scan:** sam\_direct\_droit2\_surf12mm.txt, h= 5.00 mm  
**Zoom Scan:** 7x7x7,dx=5mm, dy=5mm, dz=5mm,Complete  
**Maximum location:** X=8.000000, Y=12.000000  
**SAR 10g (W/Kg):** 0.041218  
**SAR 1g (W/Kg):** 0.063568  
**Power drift (%):** 4.32  
**3D screen shot**

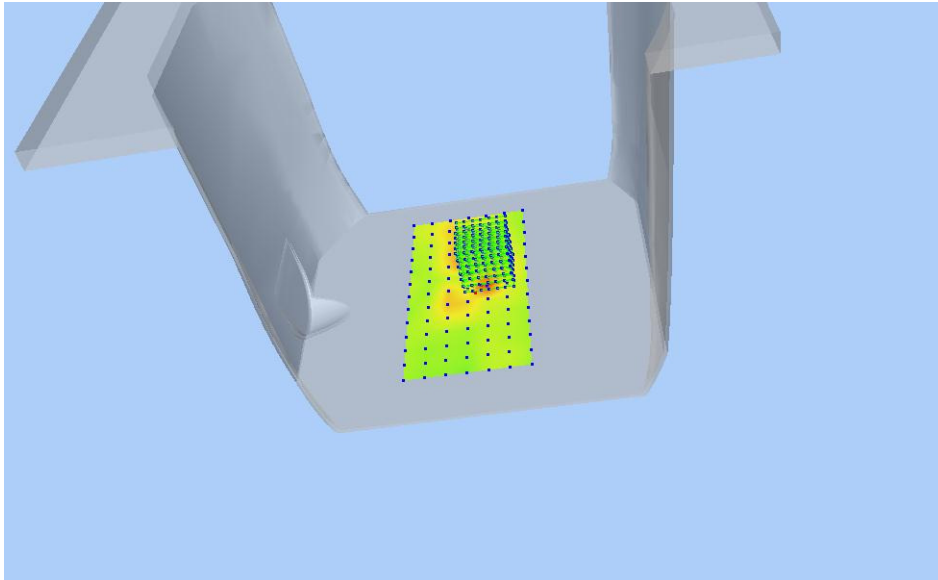

### Z Axis Scan

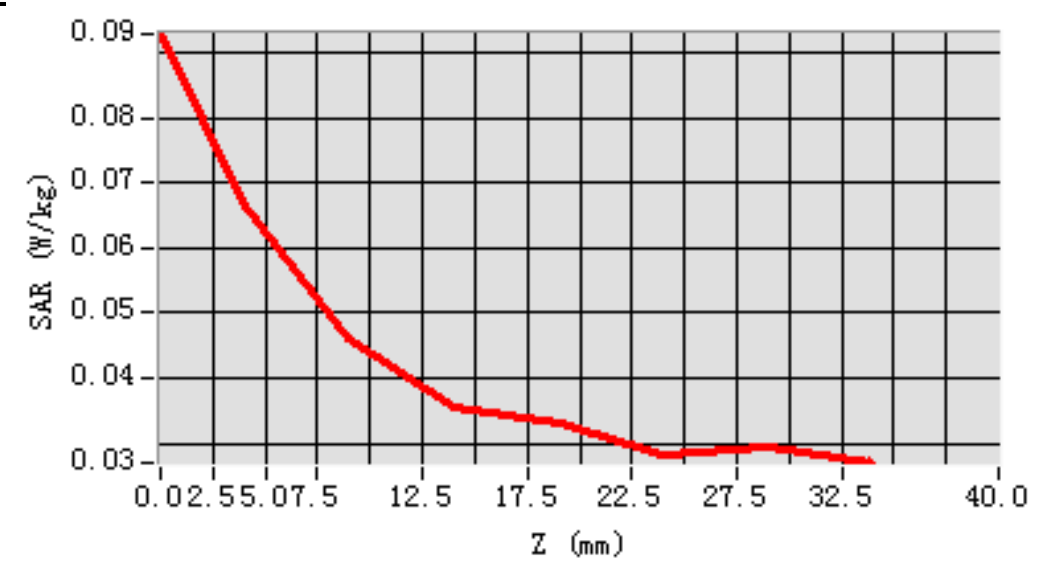



## MEAS. 7 Body Plane with Back Side on Middle Channel in IEEE 802.n(HT-40)

### mode

**Test Date:** 23/11/2016  
**Measurement duration:** 17 minutes 48 seconds  
**Signal:** WLAN, f=2437.0 MHz, Duty Cycle: 1:1.0  
**Liquid Parameters:** Permittivity: 52.06; Conductivity: 2.00 S/m  
**Test condition:** Ambient Temperature: 22.3°C, Liquid Temperature: 21.1°C  
**Probe:** SN 34/15 SSE2 EPGO265, ConvF: 2.55  
**Area Scan:** sam\_direct\_droit2\_surf12mm.txt, h= 5.00 mm  
**Zoom Scan:** 7x7x7,dx=5mm, dy=5mm, dz=5mm,Complete  
**Maximum location:** X=8.000000, Y=12.000000  
**SAR 10g (W/Kg):** 0.050859  
**SAR 1g (W/Kg):** 0.075498  
**Power drift (%):** -3.99  
**3D screen shot**

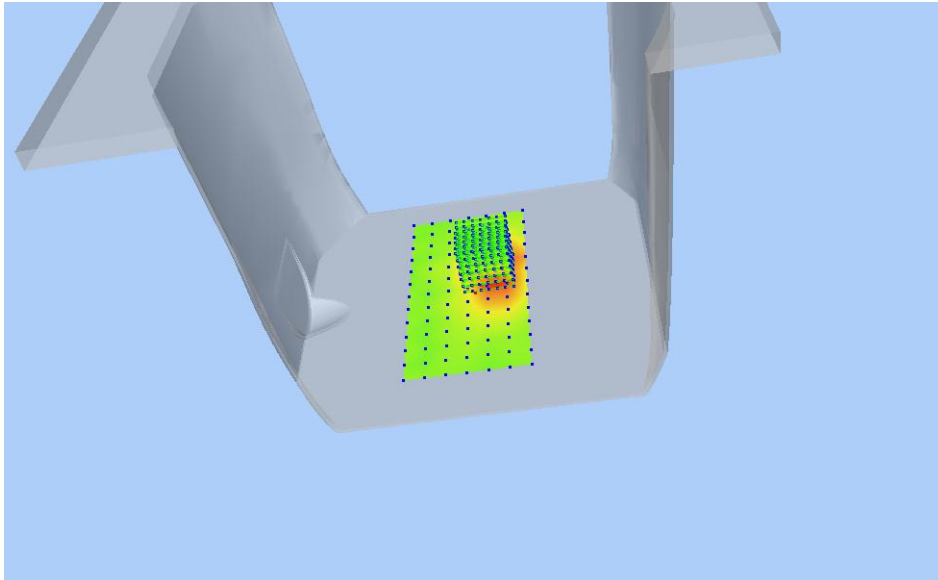

### Z Axis Scan

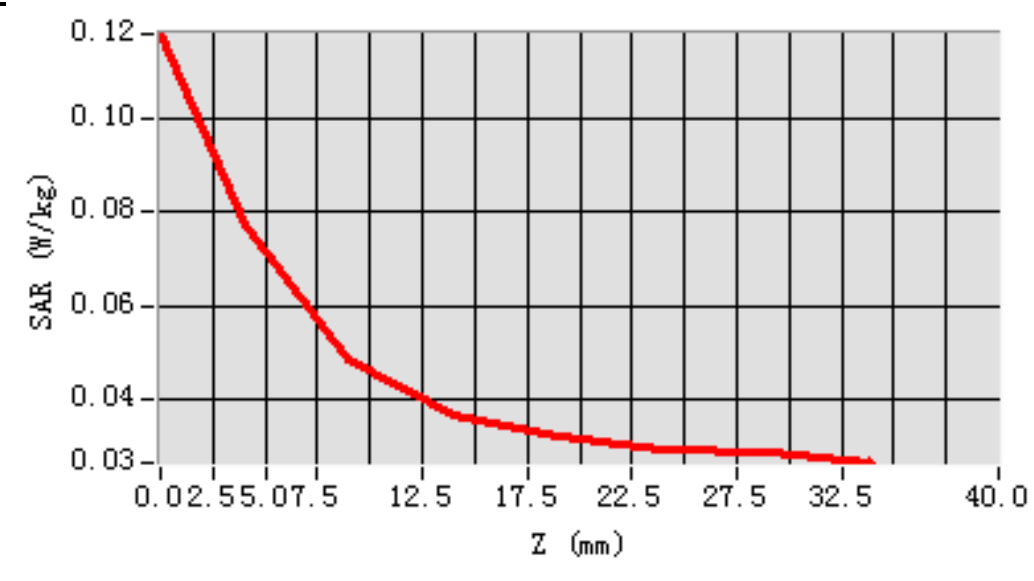

## MEAS. 8 Body Plane with Left Side on Middle Channel in IEEE 802.n(HT-40)

### mode

**Test Date:** 23/11/2016  
**Measurement duration:** 16 minutes 50 seconds  
**Signal:** WLAN, f=2437.0 MHz, Duty Cycle: 1:1.0  
**Liquid Parameters:** Permittivity: 52.06; Conductivity: 2.00 S/m  
**Test condition:** Ambient Temperature: 22.3°C, Liquid Temperature: 21.1°C  
**Probe:** SN 34/15 SSE2 EPGO265, ConvF: 2.55  
**Area Scan:** sam\_direct\_droit2\_surf12mm.txt, h= 5.00 mm  
**Zoom Scan:** 7x7x7,dx=5mm, dy=5mm, dz=5mm,Complete  
**Maximum location:** X=8.000000, Y=-12.000000  
**SAR 10g (W/Kg):** 0.110216  
**SAR 1g (W/Kg):** 0.236195  
**Power drift (%):** -1.29  
**3D screen shot**

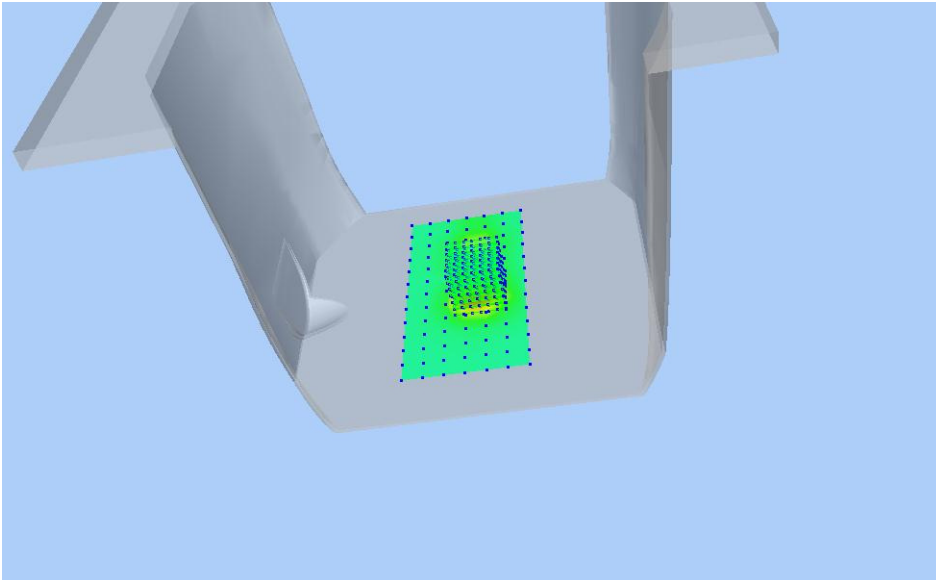

### Z Axis Scan

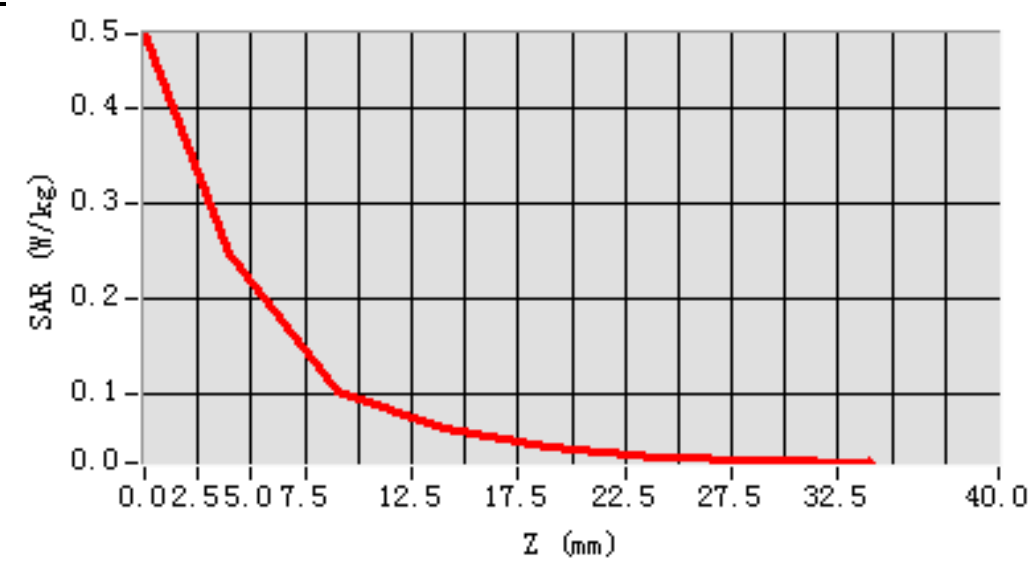

## MEAS. 9 Body Plane with Right Side on Middle Channel in IEEE 802.n(HT-40)

### mode

**Test Date:** 23/11/2016  
**Measurement duration:** 17 minutes 30 seconds  
**Signal:** WLAN, f=2437.0 MHz, Duty Cycle: 1:1.0  
**Liquid Parameters:** Permittivity: 52.06; Conductivity: 2.00 S/m  
**Test condition:** Ambient Temperature: 22.3°C, Liquid Temperature: 21.1°C  
**Probe:** SN 34/15 SSE2 EPGO265, ConvF: 2.55  
**Area Scan:** sam\_direct\_droit2\_surf12mm.txt, h= 5.00 mm  
**Zoom Scan:** 7x7x7,dx=5mm, dy=5mm, dz=5mm,Complete  
**Maximum location:** X=8.000000, Y=-12.000000  
**SAR 10g (W/Kg):** 0.034569  
**SAR 1g (W/Kg):** 0.042931  
**Power drift (%):** 1.15  
**3D screen shot**

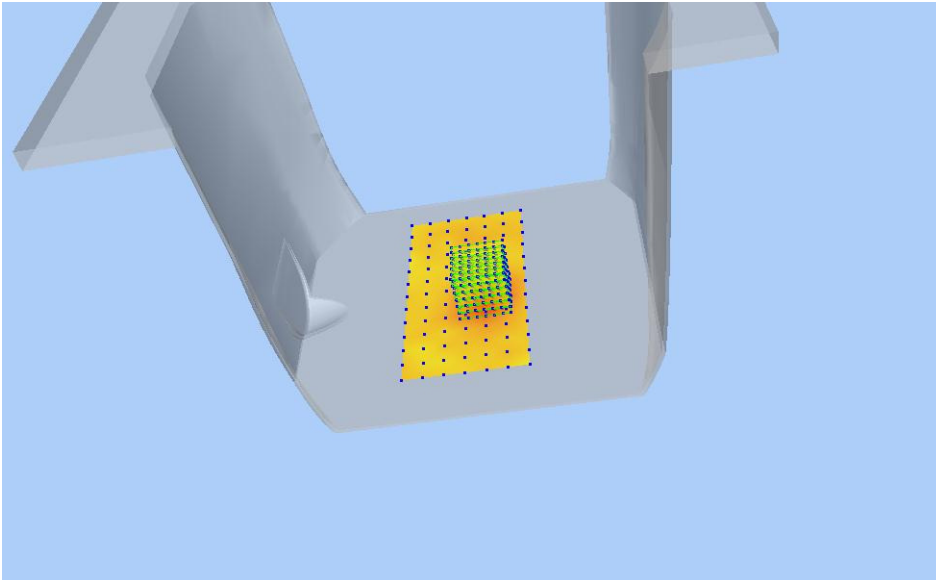

### Z Axis Scan

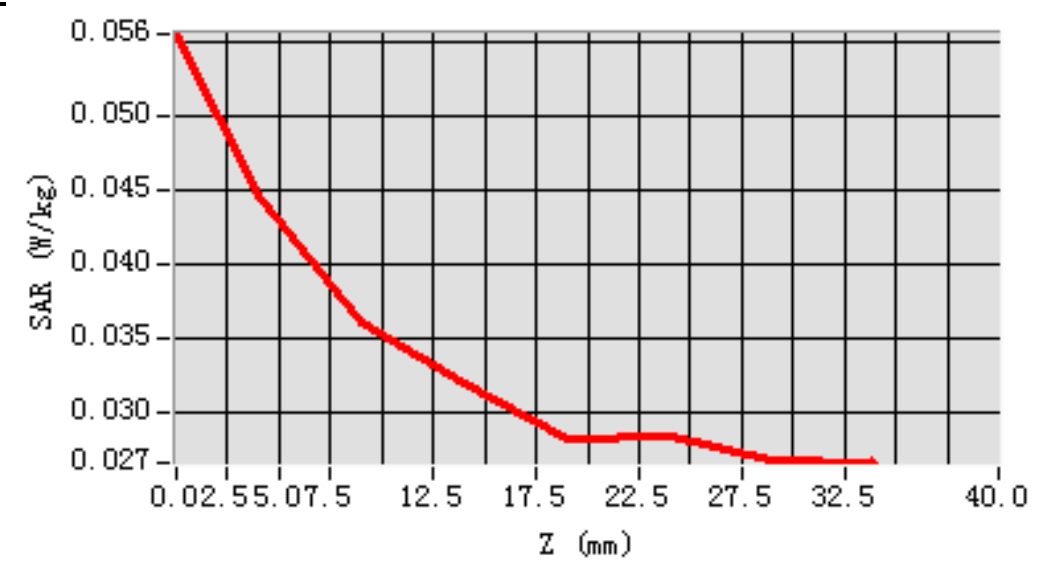

## MEAS. 10 Body Plane with Bottom Side on Middle Channel in IEEE 802.n(HT-40) mode

**Test Date:** 23/11/2016  
**Measurement duration:** 14 minutes 19 seconds  
**Signal:** WLAN, f=2437.0 MHz, Duty Cycle: 1:1.0  
**Liquid Parameters:** Permittivity: 52.06; Conductivity: 2.00 S/m  
**Test condition:** Ambient Temperature: 22.3°C, Liquid Temperature: 21.1°C  
**Probe:** SN 34/15 SSE2 EPGO265, ConvF: 2.55  
**Area Scan:** sam\_direct\_droit2\_surf12mm.txt, h= 5.00 mm  
**Zoom Scan:** 7x7x7,dx=5mm, dy=5mm, dz=5mm,Complete  
**Maximum location:** X=-4.000000, Y=-24.000000  
**SAR 10g (W/Kg):** 0.029138  
**SAR 1g (W/Kg):** 0.033831  
**Power drift (%):** -3.45  
**3D screen shot**

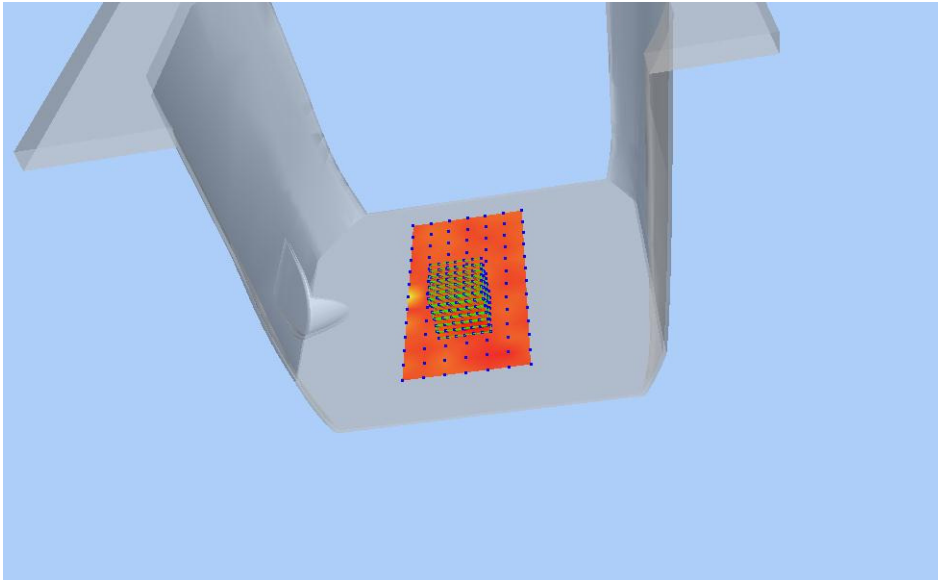

### Z Axis Scan

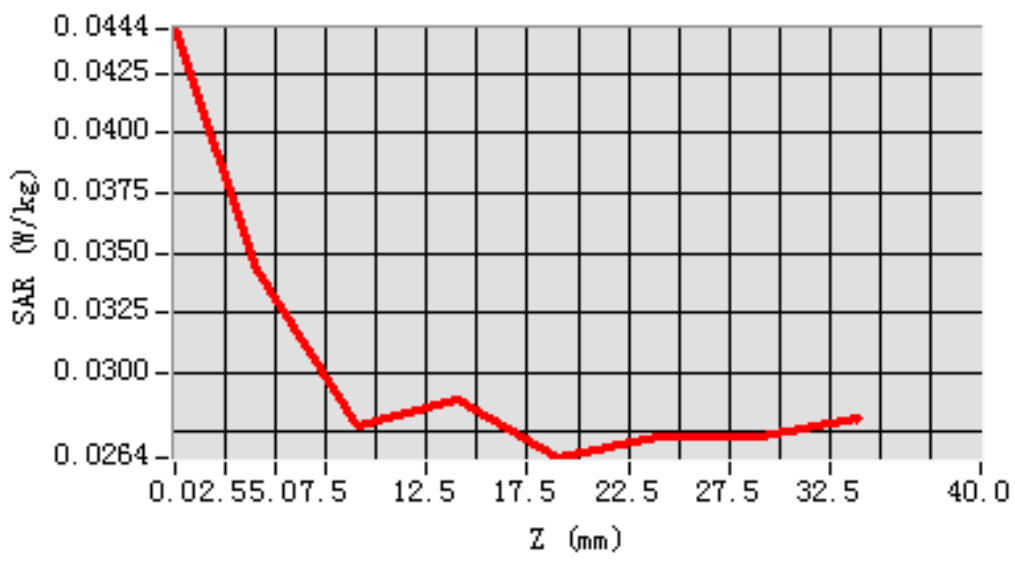

## **ANNEX D EUT EXTERNAL PHOTOS**

Please refer the document “BL-SZ16B0008-AW.pdf”.

## **ANNEX E SAR TEST SETUP PHOTOS**

Please refer the document “BL-SZ16B0008-AS.pdf”.

# ANNEX F CALIBRATION REPORT

## F.1 E-Field Probe



### COMOSAR E-Field Probe Calibration Report

Ref : ACR.294.1.16.SATU.A

**SHENZHEN BALUN TECHNOLOGY CO.,LTD.  
BLOCK B, FL 1, BAISHA SCIENCE AND TECHNOLOGY  
PARK, SHAHE XI ROAD,  
NANSHAN DISTRICT, SHENZHEN, GUANGDONG  
PROVINCE, P.R. CHINA 518055  
MVG COMOSAR DOSIMETRIC E-FIELD PROBE  
SERIAL NO.: SN 34/15 EPGO265**

Calibrated at MVG US  
2105 Barrett Park Dr. - Kennesaw, GA 30144



Calibration Date: 09/15/2016

*Summary:*

This document presents the method and results from an accredited COMOSAR Dosimetric E-Field Probe calibration performed in MVG USA using the CALISAR / CALIBAIR test bench, for use with a COMOSAR system only. All calibration results are traceable to national metrology institutions.



COMOSAR E-FIELD PROBE CALIBRATION REPORT

Ref: ACR.294.1.16.SATU.A

|                      | <i>Name</i>   | <i>Function</i> | <i>Date</i> | <i>Signature</i>     |
|----------------------|---------------|-----------------|-------------|----------------------|
| <i>Prepared by :</i> | Jérôme LUC    | Product Manager | 9/24/2016   | <i>JS</i>            |
| <i>Checked by :</i>  | Jérôme LUC    | Product Manager | 9/24/2016   | <i>JS</i>            |
| <i>Approved by :</i> | Kim RUTKOWSKI | Quality Manager | 9/24/2016   | <i>Kim Rutkowski</i> |

|                       | <i>Customer Name</i>                        |
|-----------------------|---|
| <i>Distribution :</i> | SHENZHEN<br>BALUN<br>TECHNOLOGY<br>Co.,Ltd. |

| <i>Issue</i> | <i>Date</i> | <i>Modifications</i> |
|--------------|-------------|----------------------|
| A            | 9/24/2016   | Initial release      |
|              |             |                      |
|              |             |                      |

## TABLE OF CONTENTS

|     |                                       |    |
|-----|---------------------------------------|----|
| 1   | Device Under Test .....               | 4  |
| 2   | Product Description .....             | 4  |
| 2.1 | General Information .....             | 4  |
| 3   | Measurement Method .....              | 4  |
| 3.1 | Linearity .....                       | 4  |
| 3.2 | Sensitivity .....                     | 5  |
| 3.3 | Lower Detection Limit .....           | 5  |
| 3.4 | Isotropy .....                        | 5  |
| 3.5 | Boundary Effect .....                 | 5  |
| 4   | Measurement Uncertainty .....         | 5  |
| 5   | Calibration Measurement Results ..... | 6  |
| 5.1 | Sensitivity in air .....              | 6  |
| 5.2 | Linearity .....                       | 7  |
| 5.3 | Sensitivity in liquid .....           | 7  |
| 5.4 | Isotropy .....                        | 8  |
| 6   | List of Equipment .....               | 10 |

Page: 3/10

*This document shall not be reproduced, except in full or in part, without the written approval of MVG.  
The information contained herein is to be used only for the purpose for which it is submitted and is not to  
be released in whole or part without written approval of MVG.*





**1 DEVICE UNDER TEST**

| Device Under Test                        |   |
|--|---|
| Device Type                              | COMOSAR DOSIMETRIC E FIELD PROBE  |
| Manufacturer                             | MVG   |
| Model                                    | SSE2  |
| Serial Number                            | SN 34/15 EPGO265  |
| Product Condition (new / used)           | New   |
| Frequency Range of Probe                 | 0.45 GHz-6GHz   |
| Resistance of Three Dipoles at Connector | Dipole 1: R1=0.192 MΩ<br>Dipole 2: R2=0.230 MΩ<br>Dipole 3: R3=0.205 MΩ |

A yearly calibration interval is recommended.

**2 PRODUCT DESCRIPTION**

**2.1 GENERAL INFORMATION**

MVG's COMOSAR E field Probes are built in accordance to the IEEE 1528, OET 65 Bulletin C and CEI/IEC 62209 standards.



**Figure 1 – MVG COMOSAR Dosimetric E field Dipole**

|  |        |
|--|--------|
| Probe Length                               | 330 mm |
| Length of Individual Dipoles               | 2 mm   |
| Maximum external diameter                  | 8 mm   |
| Probe Tip External Diameter                | 2.5 mm |
| Distance between dipoles / probe extremity | 1 mm   |

**3 MEASUREMENT METHOD**

The IEEE 1528, OET 65 Bulletin C, CENELEC EN50361 and CEI/IEC 62209 standards provide recommended practices for the probe calibrations, including the performance characteristics of interest and methods by which to assess their affect. All calibrations / measurements performed meet the fore mentioned standards.

**3.1 LINEARITY**

The evaluation of the linearity was done in free space using the waveguide, performing a power sweep to cover the SAR range 0.01W/kg to 100W/kg.



3.2 SENSITIVITY

The sensitivity factors of the three dipoles were determined using a two step calibration method (air and tissue simulating liquid) using waveguides as outlined in the standards.

3.3 LOWER DETECTION LIMIT

The lower detection limit was assessed using the same measurement set up as used for the linearity measurement. The required lower detection limit is 10 mW/kg.

3.4 ISOTROPY

The axial isotropy was evaluated by exposing the probe to a reference wave from a standard dipole with the dipole mounted under the flat phantom in the test configuration suggested for system validations and checks. The probe was rotated along its main axis from 0 - 360 degrees in 15 degree steps. The hemispherical isotropy is determined by inserting the probe in a thin plastic box filled with tissue-equivalent liquid, with the plastic box illuminated with the fields from a half wave dipole. The dipole is rotated about its axis (0°–180°) in 15° increments. At each step the probe is rotated about its axis (0°–360°).

3.5 BOUNDARY EFFECT

The boundary effect is defined as the deviation between the SAR measured data and the expected exponential decay in the liquid when the probe is oriented normal to the interface. To evaluate this effect, the liquid filled flat phantom is exposed to fields from either a reference dipole or waveguide. With the probe normal to the phantom surface, the peak spatial average SAR is measured and compared to the analytical value at the surface.

4 MEASUREMENT UNCERTAINTY

The guidelines outlined in the IEEE 1528, OET 65 Bulletin C, CENELEC EN50361 and CEI/IEC 62209 standards were followed to generate the measurement uncertainty associated with an E-field probe calibration using the waveguide technique. All uncertainties listed below represent an expanded uncertainty expressed at approximately the 95% confidence level using a coverage factor of k=2, traceable to the Internationally Accepted Guides to Measurement Uncertainty.

| Uncertainty analysis of the probe calibration in waveguide |                       |                          |            |    |                          |
|--|-----------------------|--------------------------|------------|----|--------------------------|
| ERROR SOURCES  | Uncertainty value (%) | Probability Distribution | Divisor    | ci | Standard Uncertainty (%) |
| Incident or forward power                                  | 3.00%                 | Rectangular              | $\sqrt{3}$ | 1  | 1.732%                   |
| Reflected power  | 3.00%                 | Rectangular              | $\sqrt{3}$ | 1  | 1.732%                   |
| Liquid conductivity  | 5.00%                 | Rectangular              | $\sqrt{3}$ | 1  | 2.887%                   |
| Liquid permittivity  | 4.00%                 | Rectangular              | $\sqrt{3}$ | 1  | 2.309%                   |
| Field homogeneity  | 3.00%                 | Rectangular              | $\sqrt{3}$ | 1  | 1.732%                   |
| Field probe positioning                                    | 5.00%                 | Rectangular              | $\sqrt{3}$ | 1  | 2.887%                   |



|  |       |             |            |   |        |
|--|-------|-------------|------------|---|--------|
| Field probe linearity                                      | 3.00% | Rectangular | $\sqrt{3}$ | 1 | 1.732% |
| <b>Combined standard uncertainty</b>                       |       |             |            |   | 5.831% |
| <b>Expanded uncertainty</b><br>95 % confidence level k = 2 |       |             |            |   | 12.0%  |

5 CALIBRATION MEASUREMENT RESULTS

| Calibration Parameters |       |
|------------------------|-------|
| Liquid Temperature     | 21 °C |
| Lab Temperature        | 21 °C |
| Lab Humidity           | 45 %  |

5.1 SENSITIVITY IN AIR

| Normx dipole 1 ( $\mu\text{V}/(\text{V}/\text{m})^2$ ) | Normy dipole 2 ( $\mu\text{V}/(\text{V}/\text{m})^2$ ) | Normz dipole 3 ( $\mu\text{V}/(\text{V}/\text{m})^2$ ) |
|--|--|--|
| 0.72   | 0.81   | 0.85   |

| DCP dipole 1 (mV) | DCP dipole 2 (mV) | DCP dipole 3 (mV) |
|-------------------|-------------------|-------------------|
| 92                | 90                | 95                |

Calibration curves  $e_i=f(V)$  ( $i=1,2,3$ ) allow to obtain E-field value using the formula:

$$E = \sqrt{E_1^2 + E_2^2 + E_3^2}$$

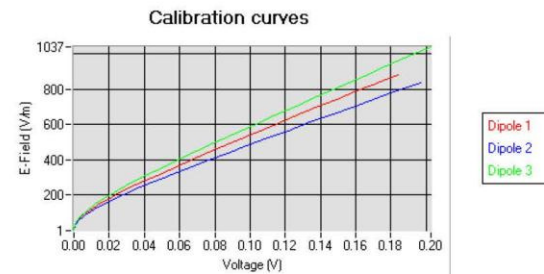



COMOSAR E-FIELD PROBE CALIBRATION REPORT

Ref: ACR.294.1.16.SATU.A

5.2 LINEARITY

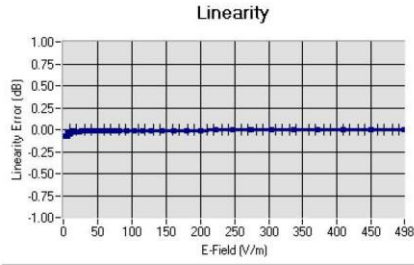

Linearity:  $\pm 1.61\%$  ( $\pm 0.07\text{dB}$ )

5.3 SENSITIVITY IN LIQUID

| Liquid | Frequency (MHz +/- 100MHz) | Permittivity | Epsilon (S/m) | ConvF |
|--------|----------------------------|--------------|---------------|-------|
| HL450  | 450                        | 44.12        | 0.88          | 1.85  |
| BL450  | 450                        | 58.92        | 1.00          | 1.90  |
| HL750  | 750                        | 42.24        | 0.90          | 1.81  |
| BL750  | 750                        | 56.85        | 0.99          | 1.88  |
| HL850  | 835                        | 43.02        | 0.90          | 2.04  |
| BL850  | 835                        | 53.72        | 0.98          | 2.12  |
| HL900  | 900                        | 42.47        | 0.99          | 1.86  |
| BL900  | 900                        | 56.97        | 1.09          | 1.92  |
| HL1800 | 1800                       | 42.24        | 1.40          | 2.04  |
| BL1800 | 1800                       | 53.53        | 1.53          | 2.08  |
| HL1900 | 1900                       | 40.79        | 1.42          | 2.35  |
| BL1900 | 1900                       | 54.47        | 1.57          | 2.42  |
| HL2000 | 2000                       | 40.52        | 1.44          | 2.23  |
| BL2000 | 2000                       | 54.18        | 1.56          | 2.32  |
| HL2450 | 2450                       | 38.73        | 1.81          | 2.47  |
| BL2450 | 2450                       | 53.23        | 1.96          | 2.55  |
| HL2600 | 2600                       | 38.54        | 1.95          | 2.36  |
| BL2600 | 2600                       | 52.07        | 2.23          | 2.43  |
| HL5200 | 5200                       | 36.80        | 4.84          | 1.81  |
| BL5200 | 5200                       | 51.21        | 5.16          | 1.85  |
| HL5400 | 5400                       | 36.35        | 4.96          | 2.04  |
| BL5400 | 5400                       | 50.51        | 5.70          | 2.11  |
| HL5600 | 5600                       | 35.57        | 5.23          | 2.08  |
| BL5600 | 5600                       | 49.83        | 5.91          | 2.15  |
| HL5800 | 5800                       | 35.30        | 5.47          | 1.88  |
| BL5800 | 5800                       | 49.03        | 6.28          | 1.93  |

LOWER DETECTION LIMIT: 7mW/kg

Page: 7/10

*This document shall not be reproduced, except in full or in part, without the written approval of MVG. The information contained herein is to be used only for the purpose for which it is submitted and is not to be released in whole or part without written approval of MVG.*



5.4 ISOTROPY

**HL900 MHz**

- Axial isotropy: 0.04 dB
- Hemispherical isotropy: 0.06 dB

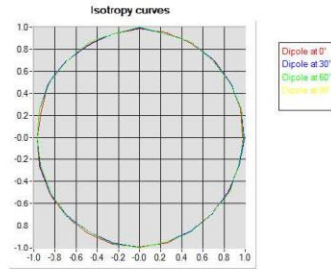

**HL1800 MHz**

- Axial isotropy: 0.04 dB
- Hemispherical isotropy: 0.06 dB

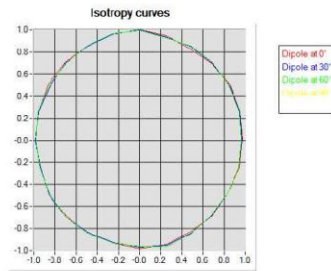



**HL5600 MHz**

- Axial isotropy: 0.06 dB
- Hemispherical isotropy: 0.09 dB

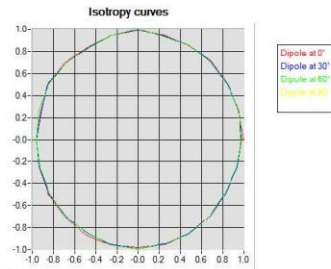



6 LIST OF EQUIPMENT

| Equipment Summary Sheet |                      |                    |   |   |
|-------------------------|----------------------|--------------------|---|---|
| Equipment Description   | Manufacturer / Model | Identification No. | Current Calibration Date                      | Next Calibration Date                         |
| Flat Phantom            | MVG                  | SN-20/09-SAM71     | Validated. No cal required.                   | Validated. No cal required.                   |
| COMOSAR Test Bench      | Version 3            | NA                 | Validated. No cal required.                   | Validated. No cal required.                   |
| Network Analyzer        | Rhode & Schwarz ZVA  | SN100132           | 10/2013                                       | 10/2016                                       |
| Reference Probe         | MVG                  | EP 94 SN 37/08     | 12/2015                                       | 12/2016                                       |
| Multimeter              | Keithley 2000        | 1188656            | 12/2013                                       | 12/2016                                       |
| Signal Generator        | Agilent E4438C       | MY49070581         | 12/2013                                       | 12/2016                                       |
| Amplifier               | Aethercomm           | SN 046             | Characterized prior to test. No cal required. | Characterized prior to test. No cal required. |
| Power Meter             | HP E4418A            | US38261498         | 12/2013                                       | 12/2016                                       |
| Power Sensor            | HP ECP-E26A          | US37181460         | 12/2013                                       | 12/2016                                       |
| Directional Coupler     | Narda 4216-20        | 01386              | Characterized prior to test. No cal required. | Characterized prior to test. No cal required. |
| Waveguide               | Mega Industries      | 069Y7-158-13-712   | Validated. No cal required.                   | Validated. No cal required.                   |
| Waveguide Transition    | Mega Industries      | 069Y7-158-13-701   | Validated. No cal required.                   | Validated. No cal required.                   |
| Waveguide Termination   | Mega Industries      | 069Y7-158-13-701   | Validated. No cal required.                   | Validated. No cal required.                   |



## SAR Reference Dipole Calibration Report

Ref: ACR.75.13.15.SATU.A

**SHENZHEN BALUN TECHNOLOGY CO.,LTD.**  
**BLOCK B, FL 1, BAISHA SCIENCE AND TECHNOLOGY**  
**PARK, SHAHE XI ROAD,**  
**NANSHAN DISTRICT, SHENZHEN, GUANGDONG**  
**PROVINCE, P.R. CHINA 518055**  
**MVG COMOSAR REFERENCE DIPOLE**  
**FREQUENCY: 2450 MHZ**  
**SERIAL NO.: SN 25/13 DIP 2G450-251**

Calibrated at MVG US  
2105 Barrett Park Dr. - Kennesaw, GA 30144



03/16/2015

### Summary:

This document presents the method and results from an accredited SAR reference dipole calibration performed in MVG USA using the COMOSAR test bench. All calibration results are traceable to national metrology institutions.





## SAR REFERENCE DIPOLE CALIBRATION REPORT

Ref: ACR.75.13.15.SATU.A

|                      | <i>Name</i>   | <i>Function</i> | <i>Date</i> | <i>Signature</i>     |
|----------------------|---------------|-----------------|-------------|----------------------|
| <i>Prepared by :</i> | Jérôme LUC    | Product Manager | 3/16/2015   | <i>JS</i>            |
| <i>Checked by :</i>  | Jérôme LUC    | Product Manager | 3/16/2015   | <i>JS</i>            |
| <i>Approved by :</i> | Kim RUTKOWSKI | Quality Manager | 3/16/2015   | <i>Kim Rutkowski</i> |

|                       | <i>Customer Name</i>                        |
|-----------------------|---|
| <i>Distribution :</i> | SHENZHEN<br>BALUN<br>TECHNOLOGY<br>Co.,Ltd. |

| <i>Issue</i> | <i>Date</i> | <i>Modifications</i> |
|--------------|-------------|----------------------|
| A            | 3/16/2015   | Initial release      |
|              |             |                      |
|              |             |                      |
|              |             |                      |

Page: 2/11

*This document shall not be reproduced, except in full or in part, without the written approval of MVG.  
The information contained herein is to be used only for the purpose for which it is submitted and is not to  
be released in whole or part without written approval of MVG.*

## TABLE OF CONTENTS

|     |   |    |
|-----|---|----|
| 1   | Introduction.....                             | 4  |
| 2   | Device Under Test.....                        | 4  |
| 3   | Product Description.....                      | 4  |
| 3.1 | General Information.....                      | 4  |
| 4   | Measurement Method.....                       | 5  |
| 4.1 | Return Loss Requirements.....                 | 5  |
| 4.2 | Mechanical Requirements.....                  | 5  |
| 5   | Measurement Uncertainty.....                  | 5  |
| 5.1 | Return Loss.....                              | 5  |
| 5.2 | Dimension Measurement.....                    | 5  |
| 5.3 | Validation Measurement.....                   | 5  |
| 6   | Calibration Measurement Results.....          | 6  |
| 6.1 | Return Loss and Impedance In Head Liquid..... | 6  |
| 6.2 | Return Loss and Impedance In Body Liquid..... | 6  |
| 6.3 | Mechanical Dimensions.....                    | 6  |
| 7   | Validation measurement.....                   | 7  |
| 7.1 | Head Liquid Measurement.....                  | 7  |
| 7.2 | SAR Measurement Result With Head Liquid.....  | 8  |
| 7.3 | Body Liquid Measurement.....                  | 9  |
| 7.4 | SAR Measurement Result With Body Liquid.....  | 10 |
| 8   | List of Equipment.....                        | 11 |

Page: 3/11

*This document shall not be reproduced, except in full or in part, without the written approval of MVG.  
The information contained herein is to be used only for the purpose for which it is submitted and is not to  
be released in whole or part without written approval of MVG.*



**1 INTRODUCTION**

This document contains a summary of the requirements set forth by the IEEE 1528, FCC KDBs and CEI/IEC 62209 standards for reference dipoles used for SAR measurement system validations and the measurements that were performed to verify that the product complies with the fore mentioned standards.

**2 DEVICE UNDER TEST**

| Device Under Test              |                                   |
|--------------------------------|-----------------------------------|
| Device Type                    | COMOSAR 2450 MHz REFERENCE DIPOLE |
| Manufacturer                   | MVG                               |
| Model                          | SID2450                           |
| Serial Number                  | SN 25/13 DIP 2G450-251            |
| Product Condition (new / used) | Used                              |

A yearly calibration interval is recommended.

**3 PRODUCT DESCRIPTION**

**3.1 GENERAL INFORMATION**

MVG's COMOSAR Validation Dipoles are built in accordance to the IEEE 1528, FCC KDBs and CEI/IEC 62209 standards. The product is designed for use with the COMOSAR test bench only.



**Figure 1 – MVG COMOSAR Validation Dipole**



#### 4 MEASUREMENT METHOD

The IEEE 1528, FCC KDBs and CEI/IEC 62209 standards provide requirements for reference dipoles used for system validation measurements. The following measurements were performed to verify that the product complies with the fore mentioned standards.

##### 4.1 RETURN LOSS REQUIREMENTS

The dipole used for SAR system validation measurements and checks must have a return loss of -20 dB or better. The return loss measurement shall be performed against a liquid filled flat phantom, with the phantom constructed as outlined in the fore mentioned standards.

##### 4.2 MECHANICAL REQUIREMENTS

The IEEE Std. 1528 and CEI/IEC 62209 standards specify the mechanical components and dimensions of the validation dipoles, with the dimensions frequency and phantom shell thickness dependent. The COMOSAR test bench employs a 2 mm phantom shell thickness therefore the dipoles sold for use with the COMOSAR test bench comply with the requirements set forth for a 2 mm phantom shell thickness.

#### 5 MEASUREMENT UNCERTAINTY

All uncertainties listed below represent an expanded uncertainty expressed at approximately the 95% confidence level using a coverage factor of k=2, traceable to the Internationally Accepted Guides to Measurement Uncertainty.

##### 5.1 RETURN LOSS

The following uncertainties apply to the return loss measurement:

| Frequency band | Expanded Uncertainty on Return Loss |
|----------------|-------------------------------------|
| 400-6000MHz    | 0.1 dB                              |

##### 5.2 DIMENSION MEASUREMENT

The following uncertainties apply to the dimension measurements:

| Length (mm) | Expanded Uncertainty on Length |
|-------------|--------------------------------|
| 3 - 300     | 0.05 mm                        |

##### 5.3 VALIDATION MEASUREMENT

The guidelines outlined in the IEEE 1528, FCC KDBs, CENELEC EN50361 and CEI/IEC 62209 standards were followed to generate the measurement uncertainty for validation measurements.

| Scan Volume | Expanded Uncertainty |
|-------------|----------------------|
| 1 g         | 20.3 %               |

Page: 5/11

*This document shall not be reproduced, except in full or in part, without the written approval of MVG.  
The information contained herein is to be used only for the purpose for which it is submitted and is not to be released in whole or part without written approval of MVG.*



|      |        |
|------|--------|
| 10 g | 20.1 % |
|------|--------|

**6 CALIBRATION MEASUREMENT RESULTS**

**6.1 RETURN LOSS AND IMPEDANCE IN HEAD LIQUID**

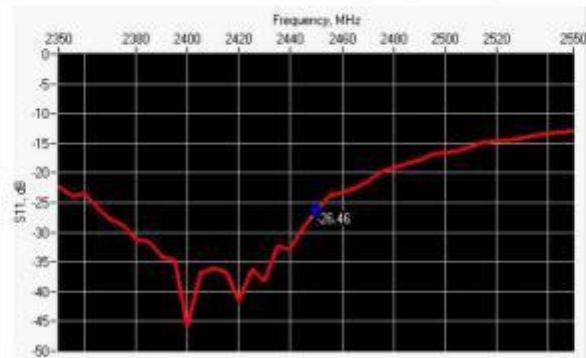

| Frequency (MHz) | Return Loss (dB) | Requirement (dB) | Impedance       |
|-----------------|------------------|------------------|-----------------|
| 2450            | -26.46           | -20              | 49.3 Ω - 4.7 jΩ |

**6.2 RETURN LOSS AND IMPEDANCE IN BODY LIQUID**

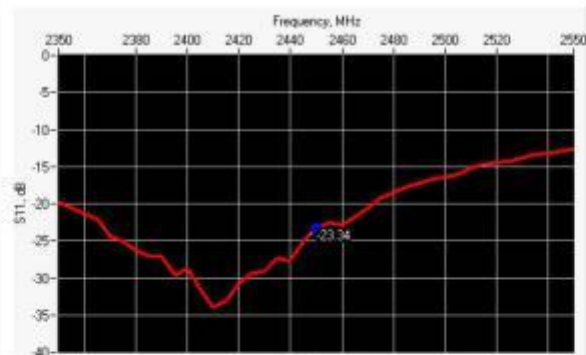

| Frequency (MHz) | Return Loss (dB) | Requirement (dB) | Impedance       |
|-----------------|------------------|------------------|-----------------|
| 2450            | -23.34           | -20              | 53.4 Ω - 6.2 jΩ |

**6.3 MECHANICAL DIMENSIONS**

| Frequency MHz | L mm       |          | h mm       |          | d mm      |          |
|---------------|------------|----------|------------|----------|-----------|----------|
|               | required   | measured | required   | measured | required  | measured |
| 300           | 420.0 ±1 % |          | 250.0 ±1 % |          | 6.35 ±1 % |          |



SAR REFERENCE DIPOLE CALIBRATION REPORT

Ref: ACR.75.13.15.SATU.A

|      |            |      |            |      |           |      |
|------|------------|------|------------|------|-----------|------|
| 450  | 290.0 ±1 % |      | 166.7 ±1 % |      | 6.35 ±1 % |      |
| 750  | 176.0 ±1 % |      | 100.0 ±1 % |      | 6.35 ±1 % |      |
| 835  | 161.0 ±1 % |      | 89.8 ±1 %  |      | 3.6 ±1 %  |      |
| 900  | 149.0 ±1 % |      | 83.3 ±1 %  |      | 3.6 ±1 %  |      |
| 1450 | 89.1 ±1 %  |      | 51.7 ±1 %  |      | 3.6 ±1 %  |      |
| 1500 | 80.5 ±1 %  |      | 50.0 ±1 %  |      | 3.6 ±1 %  |      |
| 1640 | 79.0 ±1 %  |      | 45.7 ±1 %  |      | 3.6 ±1 %  |      |
| 1750 | 75.2 ±1 %  |      | 42.9 ±1 %  |      | 3.6 ±1 %  |      |
| 1800 | 72.0 ±1 %  |      | 41.7 ±1 %  |      | 3.6 ±1 %  |      |
| 1900 | 68.0 ±1 %  |      | 39.5 ±1 %  |      | 3.6 ±1 %  |      |
| 1950 | 66.3 ±1 %  |      | 38.5 ±1 %  |      | 3.6 ±1 %  |      |
| 2000 | 64.5 ±1 %  |      | 37.5 ±1 %  |      | 3.6 ±1 %  |      |
| 2100 | 61.0 ±1 %  |      | 35.7 ±1 %  |      | 3.6 ±1 %  |      |
| 2300 | 55.5 ±1 %  |      | 32.6 ±1 %  |      | 3.6 ±1 %  |      |
| 2450 | 51.5 ±1 %  | PASS | 30.4 ±1 %  | PASS | 3.6 ±1 %  | PASS |
| 2600 | 48.5 ±1 %  |      | 28.8 ±1 %  |      | 3.6 ±1 %  |      |
| 3000 | 41.5 ±1 %  |      | 25.0 ±1 %  |      | 3.6 ±1 %  |      |
| 3500 | 37.0 ±1 %  |      | 26.4 ±1 %  |      | 3.6 ±1 %  |      |
| 3700 | 34.7 ±1 %  |      | 26.4 ±1 %  |      | 3.6 ±1 %  |      |

7 VALIDATION MEASUREMENT

The IEEE Std. 1528, FCC KDBs and CEI/IEC 62209 standards state that the system validation measurements must be performed using a reference dipole meeting the fore mentioned return loss and mechanical dimension requirements. The validation measurement must be performed against a liquid filled flat phantom, with the phantom constructed as outlined in the fore mentioned standards. Per the standards, the dipole shall be positioned below the bottom of the phantom, with the dipole length centered and parallel to the longest dimension of the flat phantom, with the top surface of the dipole at the described distance from the bottom surface of the phantom.

7.1 HEAD LIQUID MEASUREMENT

| Frequency MHz | Relative permittivity (ε <sub>r</sub> ) |          | Conductivity (σ) S/m |          |
|---------------|---|----------|----------------------|----------|
|               | required                                | measured | required             | measured |
| 300           | 45.3 ±5 %                               |          | 0.87 ±5 %            |          |
| 450           | 43.5 ±5 %                               |          | 0.87 ±5 %            |          |
| 750           | 41.9 ±5 %                               |          | 0.89 ±5 %            |          |
| 835           | 41.5 ±5 %                               |          | 0.90 ±5 %            |          |
| 900           | 41.5 ±5 %                               |          | 0.97 ±5 %            |          |
| 1450          | 40.5 ±5 %                               |          | 1.20 ±5 %            |          |
| 1500          | 40.4 ±5 %                               |          | 1.23 ±5 %            |          |
| 1640          | 40.2 ±5 %                               |          | 1.31 ±5 %            |          |
| 1750          | 40.1 ±5 %                               |          | 1.37 ±5 %            |          |

Page: 7/11

*This document shall not be reproduced, except in full or in part, without the written approval of MVG. The information contained herein is to be used only for the purpose for which it is submitted and is not to be released in whole or part without written approval of MVG.*



SAR REFERENCE DIPOLE CALIBRATION REPORT

Ref: ACR.75.13.15.SATU.A

|      |           |      |           |      |
|------|-----------|------|-----------|------|
| 1800 | 40.0 ±5 % |      | 1.40 ±5 % |      |
| 1900 | 40.0 ±5 % |      | 1.40 ±5 % |      |
| 1950 | 40.0 ±5 % |      | 1.40 ±5 % |      |
| 2000 | 40.0 ±5 % |      | 1.40 ±5 % |      |
| 2100 | 39.8 ±5 % |      | 1.49 ±5 % |      |
| 2300 | 39.5 ±5 % |      | 1.67 ±5 % |      |
| 2450 | 39.2 ±5 % | PASS | 1.80 ±5 % | PASS |
| 2600 | 39.0 ±5 % |      | 1.96 ±5 % |      |
| 3000 | 38.5 ±5 % |      | 2.40 ±5 % |      |
| 3500 | 37.9 ±5 % |      | 2.91 ±5 % |      |

7.2 SAR MEASUREMENT RESULT WITH HEAD LIQUID

The IEEE Std. 1528 and CEI/IEC 62209 standards state that the system validation measurements should produce the SAR values shown below (for phantom thickness of 2 mm), within the uncertainty for the system validation. All SAR values are normalized to 1 W forward power. In bracket, the measured SAR is given with the used input power.

|   |   |
|---|---|
| Software                                  | OPENSAR V4  |
| Phantom                                   | SN 20/09 SAM71  |
| Probe                                     | SN 18/11 EPG122   |
| Liquid                                    | Head Liquid Values: $\epsilon_p$ : 38.9 $\sigma_p$ : 1.79 |
| Distance between dipole center and liquid | 10.0 mm   |
| Area scan resolution                      | dx=8mm/dy=8mm   |
| Zoon Scan Resolution                      | dx=5mm/dy=5m/dz=5mm                                       |
| Frequency                                 | 2450 MHz  |
| Input power                               | 20 dBm  |
| Liquid Temperature                        | 21 °C   |
| Lab Temperature                           | 21 °C   |
| Lab Humidity                              | 45 %  |

| Frequency MHz | 1 g SAR (W/kg/W) |          | 10 g SAR (W/kg/W) |          |
|---------------|------------------|----------|-------------------|----------|
|               | required         | measured | required          | measured |
| 300           | 2.85             |          | 1.94              |          |
| 450           | 4.58             |          | 3.06              |          |
| 750           | 8.49             |          | 5.55              |          |
| 835           | 9.56             |          | 6.22              |          |
| 900           | 10.9             |          | 6.99              |          |
| 1450          | 29               |          | 16                |          |
| 1500          | 30.5             |          | 16.8              |          |
| 1640          | 34.2             |          | 18.4              |          |
| 1750          | 36.4             |          | 19.3              |          |
| 1800          | 38.4             |          | 20.1              |          |

Page: 8/11

*This document shall not be reproduced, except in full or in part, without the written approval of MVG. The information contained herein is to be used only for the purpose for which it is submitted and is not to be released in whole or part without written approval of MVG.*



SAR REFERENCE DIPOLE CALIBRATION REPORT

Ref: ACR.75.13.15.SATU.A

|      |      |              |      |              |
|------|------|--------------|------|--------------|
| 1900 | 39.7 |              | 20.5 |              |
| 1950 | 40.5 |              | 20.9 |              |
| 2000 | 41.1 |              | 21.1 |              |
| 2100 | 43.6 |              | 21.9 |              |
| 2300 | 48.7 |              | 23.3 |              |
| 2450 | 52.4 | 54.29 (5.43) | 24   | 24.20 (2.42) |
| 2600 | 55.3 |              | 24.6 |              |
| 3000 | 63.8 |              | 25.7 |              |
| 3500 | 67.1 |              | 25   |              |

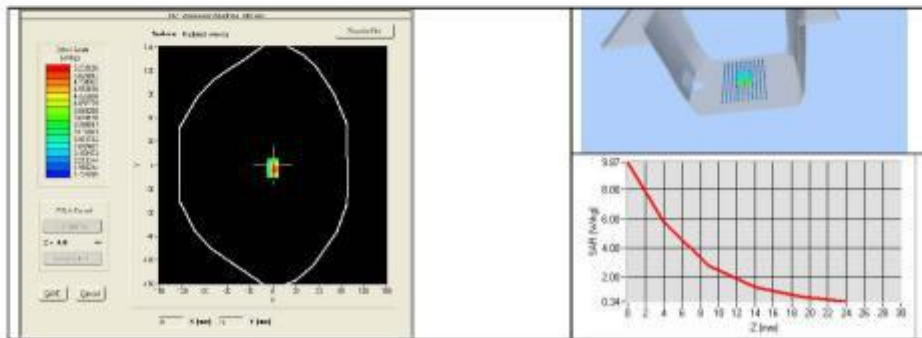

7.3 BODY LIQUID MEASUREMENT

| Frequency MHz | Relative permittivity ( $\epsilon_r$ ) |          | Conductivity ( $\sigma$ ) S/m |          |
|---------------|--|----------|-------------------------------|----------|
|               | required                               | measured | required                      | measured |
| 150           | 61.9 ±5 %                              |          | 0.80 ±5 %                     |          |
| 300           | 58.2 ±5 %                              |          | 0.92 ±5 %                     |          |
| 450           | 56.7 ±5 %                              |          | 0.94 ±5 %                     |          |
| 750           | 55.5 ±5 %                              |          | 0.96 ±5 %                     |          |
| 835           | 55.2 ±5 %                              |          | 0.97 ±5 %                     |          |
| 900           | 55.0 ±5 %                              |          | 1.05 ±5 %                     |          |
| 915           | 55.0 ±5 %                              |          | 1.06 ±5 %                     |          |
| 1450          | 54.0 ±5 %                              |          | 1.30 ±5 %                     |          |
| 1610          | 53.8 ±5 %                              |          | 1.40 ±5 %                     |          |
| 1800          | 53.3 ±5 %                              |          | 1.52 ±5 %                     |          |
| 1900          | 53.3 ±5 %                              |          | 1.52 ±5 %                     |          |
| 2000          | 53.3 ±5 %                              |          | 1.52 ±5 %                     |          |
| 2100          | 53.2 ±5 %                              |          | 1.62 ±5 %                     |          |
| 2450          | 52.7 ±5 %                              | PASS     | 1.95 ±5 %                     | PASS     |

Page: 9/11

*This document shall not be reproduced, except in full or in part, without the written approval of MVG. The information contained herein is to be used only for the purpose for which it is submitted and is not to be released in whole or part without written approval of MVG.*





SAR REFERENCE DIPOLE CALIBRATION REPORT

Ref: ACR.75.13.15.SATU.A

|      |            |  |            |  |
|------|------------|--|------------|--|
| 2600 | 52.5 ±5 %  |  | 2.16 ±5 %  |  |
| 3000 | 52.0 ±5 %  |  | 2.73 ±5 %  |  |
| 3500 | 51.3 ±5 %  |  | 3.31 ±5 %  |  |
| 5200 | 49.0 ±10 % |  | 5.30 ±10 % |  |
| 5300 | 48.9 ±10 % |  | 5.42 ±10 % |  |
| 5400 | 48.7 ±10 % |  | 5.53 ±10 % |  |
| 5500 | 48.6 ±10 % |  | 5.65 ±10 % |  |
| 5600 | 48.5 ±10 % |  | 5.77 ±10 % |  |
| 5800 | 48.2 ±10 % |  | 6.00 ±10 % |  |

7.4 SAR MEASUREMENT RESULT WITH BODY LIQUID

|   |  |
|---|--|
| Software                                  | OPENSAR V4                                   |
| Phantom                                   | SN 20/09 SAM71                               |
| Probe                                     | SN 18/11 EPG122                              |
| Liquid                                    | Body Liquid Values: eps' : 52.7 sigma : 1.94 |
| Distance between dipole center and liquid | 10.0 mm                                      |
| Area scan resolution                      | dx=8mm/dy=8mm                                |
| Zoon Scan Resolution                      | dx=5mm/dy=5m/dz=5mm                          |
| Frequency                                 | 2450 MHz                                     |
| Input power                               | 20 dBm                                       |
| Liquid Temperature                        | 21 °C  |
| Lab Temperature                           | 21 °C  |
| Lab Humidity                              | 45 %   |

| Frequency MHz | 1 g SAR (W/kg/W) | 10 g SAR (W/kg/W) |
|---------------|------------------|-------------------|
|               | measured         | measured          |
| 2450          | 54.70 (5.47)     | 24.86 (2.49)      |

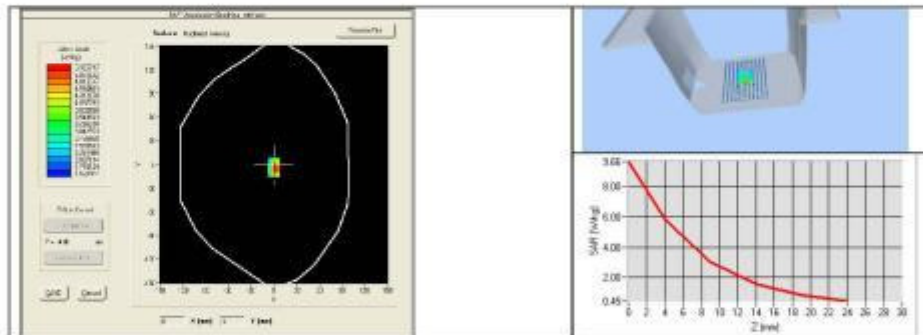

Page: 10/11

*This document shall not be reproduced, except in full or in part, without the written approval of MVG. The information contained herein is to be used only for the purpose for which it is submitted and is not to be released in whole or part without written approval of MVG.*



**8 LIST OF EQUIPMENT**

| Equipment Summary Sheet         |                      |                    |   |   |
|---------------------------------|----------------------|--------------------|---|---|
| Equipment Description           | Manufacturer / Model | Identification No. | Current Calibration Date                      | Next Calibration Date                         |
| SAM Phantom                     | MVG                  | SN-20/09-SAM71     | Validated. No cal required.                   | Validated. No cal required.                   |
| COMOSAR Test Bench              | Version 3            | NA                 | Validated. No cal required.                   | Validated. No cal required.                   |
| Network Analyzer                | Rhode & Schwarz ZVA  | SN100132           | 02/2013                                       | 02/2016                                       |
| Calipers                        | Carrera              | CALIPER-01         | 12/2013                                       | 12/2016                                       |
| Reference Probe                 | MVG                  | EPG122 SN 18/11    | 10/2014                                       | 10/2015                                       |
| Multimeter                      | Keithley 2000        | 1188656            | 12/2013                                       | 12/2016                                       |
| Signal Generator                | Agilent E4438C       | MY49070581         | 12/2013                                       | 12/2016                                       |
| Amplifier                       | Aethercomm           | SN 046             | Characterized prior to test. No cal required. | Characterized prior to test. No cal required. |
| Power Meter                     | HP E4418A            | US38261498         | 12/2013                                       | 12/2016                                       |
| Power Sensor                    | HP ECP-E26A          | US37181460         | 12/2013                                       | 12/2016                                       |
| Directional Coupler             | Narda 4216-20        | 01386              | Characterized prior to test. No cal required. | Characterized prior to test. No cal required. |
| Temperature and Humidity Sensor | Control Company      | 11-661-9           | 8/2012  | 8/2015  |