



Chunghwa Telecom CO., Ltd
Telecommunication Laboratories
Testing & Certification Center

TEL : +886 3 4244445
FAX : +886 3 4202444
ADDR. : No. 99, Dianyuan Rd., Yang-Mei city, Taoyuan,
Taiwan , R.O.C.
E-mail:mhko@cht.com.tw <http://www.chttl.com.tw>

Report No : TSC-101-11-AP-25-1 (SAR)

Date of Issue : Dec. 07, 2012

SAR Test Report

Device Under Test : Rugged PDA

Model No. : C350T-3GB2 , C350XXXXXXXXX

(X=a~z,A~Z,0~9, ’ ’ - ’ ’ ,blank or Slash)

Applicant : WINMATE Communication INC.

This Test report applied to the tested sample only.

This report shall not be reproduced in part without prior written permission of Telecommunication Laboratories Testing & Certification Center, Chunghwa Telecom Co., Ltd.





Report No : TSC-101-11-AP-25-1 (SAR)

Applicant : WINMATE Communication INC.

TEL. : 886-2-66355758

Addr. : 9F, No.111-6, Shing-De Rd., San-Chung District, New Taipei City, Taiwan

Device Under Test : Rugged PDA

Trade name : WINMATE

Model No. : C350T-3GB2 , C350XXXXXXXX (X=a~z,A~Z,0~9,"'-",blank or Slash)

Manufacturer : WINMATE Communication INC.

Applied Date : Nov. 20, 2012

Date of Sample Arrived : Nov. 20, 2012

Date of Finished : Nov. 30, 2012

Applied standard : IEEE 1528 2003, 47 CFR §2.1093, OET 65 Supplement C 01-01



Cited Document : KDB 447498, 450824, 616217, 248227 FCC DA02-1438

Test Equipment : Refer to page 22

Test Environment : 22°C, 50 % R.H.

Test results : IEEE 1528 2003 Complied

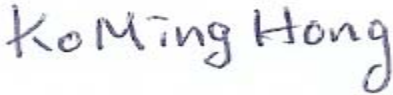
SAR 1g = **0.713** W/kg (Maximum), Refer to page 21

Approved by	Reviewed by	Test Engineer
 Ko Ming-Hong	 Chia-cheng Chang	 Shin-yen Du

Report No : TSC-101-11-AP-25-1 (SAR)

TABLE OF CONTENTS

1. GENERAL INFORMATION	3
1.1 EUT DESCRIPTION	3
1.2 TEST ENVIRONMENT	3
2. SAR MEASUREMENT SYSTEM	4
2.1 ALSAS-10U SYSTEM DESCRIPTION	4
2.2 ISOTROPIC E-FIELD PROBE	5
2.3 BOUNDARY DETECTION UNIT AND PROBE MOUNTING DEVICE	7
2.4 DAQ-PAQ (ANALOG TO DIGITAL ELECTRONICS)	7
2.5 AXIS ARTICULATED ROBOT	7
2.6 ALSAS UNIVERSAL WORKSTATION	8
2.7 PHANTOM TYPES	8
3. TISSUE SIMULATING LIQUID.....	9
3.1 THE COMPOSITION OF THE TISSUE SIMULATING LIQUID	9
3.2 TISSUE CALIBRATION RESULT	9
3.3 TISSUE DIELECTRIC PARAMETERS FOR HEAD AND BODY PHANTOMS.....	10
4. SAR MEASUREMENT PROCEDURE	11
4.1 SAR SYSTEM VALIDATION	11
4.2 ARRANGEMENT ASSESSMENT SETUP	17
4.3 SAR MEASUREMENT PROCEDURE	17
5. SAR EXPOSURE LIMITS	18
6. TEST EQUIPMENT LIST.....	19
7. MEASUREMENT UNCERTAINTY	20
8 SAR TEST RESULTS	21
9. EUT PHOTOGRAPHS	23
A. TEST CONFIGURATIONS AND TEST DATA	28
A.1 TEST CONFIGURATION.....	28
A.2 LIQUID LEVEL PHOTO.....	31
A.3 TISSUE LIQUIDS DIELECTRIC PARAMETER.....	32
A.3.1 2450 MHz TISSUE LIQUIDS DIELECTRIC MEASUREMENT DATA	32
A.4. TEST DATA	33
A.4.1 802.11B MODE	33
A.4.2 DIPOLE CALIBRATION DATA	48
A.4.3 PROBE CALIBRATION DATA	56

Report No : TSC-101-11-AP-25-1 (SAR)

1. General Information

1.1 EUT Description

Product Name	Rugged PDA
Trade Name	Winmate
Model No.	C350T-3GB2 , C350XXXXXXXXX (X=a~z,A~Z,0~9,''-'' ,blank or Slash)
Operation Frequency	WiFi and Bluetooth 2402-2483MHz
FCC ID	PX93500WBW
Antenna Type	INTERNAL
Device Category	Portable
Battery	Jhieh Hong Tech. J1042-1, 3.7V, 2600mAh
WLAN/Bluetooth Module	Jorjin WG7310-00
RF Exposure Environment	Uncontrolled
Output Power (Conducted)	Please refer to P.21

1.2 Test Environment

Ambient conditions in the laboratory:

Items	Required	Actual
Temperature (°C)	24	See first page
Humidity (%RH)	55	See first page

Report No : TSC-101-11-AP-25-1 (SAR)

2. SAR Measurement System

2.1 ALSAS-10U System Description

ALSAS-10-U is fully compliant with the technical and scientific requirements of IEEE 1528, IEC 62209, EN50361, CENELEC, ARIB, ACA, and the Federal Communications Commission. The system comprises of a six axes articulated robot which utilizes a dedicated controller. ALSAS-10U uses the latest methodologies and FDTD modeling to provide a platform which is repeatable with minimum uncertainty.

2.1.1 Applications

Predefined measurement procedures compliant with the guidelines of CENELEC, IEEE, IEC, FCC, etc are utilized during the assessment for the device. Automatic detection for all SAR maximum are embedded within the core architecture for the system, ensuring that peak locations used for centering the zoom scan are within a 1mm resolution and a 0.05mm repeatable position. System operation range currently available up-to 6 GHz in simulated tissue.

2.1.2 Area Scans

Area scans are defined prior to the measurement process being executed with a user defined variable spacing between each measurement point (integral) allowing low uncertainty measurements to be conducted. Scans defined for FCC applications utilize a 10mm² step integral, with 1mm interpolation used to locate the peak SAR area used for zoom scan assessments.

Where the system identifies multiple SAR peaks (which are within 25% of peak value) the system will provide the user with the option of assessing each peak location individually for zoom scan averaging.

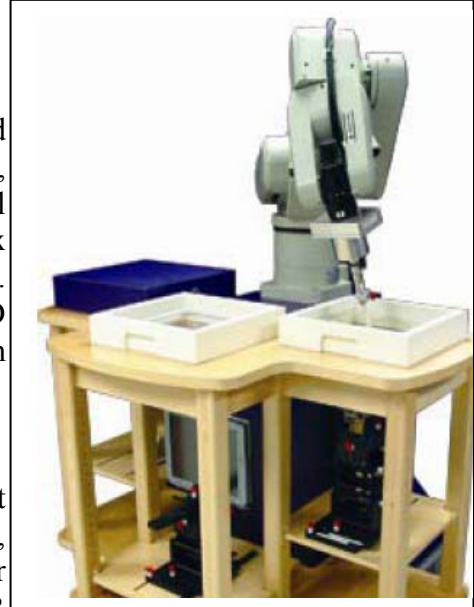

Report No : TSC-101-11-AP-25-1 (SAR)

2.1.3 Zoom Scan (Cube Scan Averaging)

The averaging zoom scan volume utilized in the ALSAS-10U software is in the shape of a cube and the side dimension of a 1 g or 10 g mass is dependent on the density of the liquid representing the simulated tissue. A density of 1000 kg/m³ is used to represent the head and body tissue density and not the phantom liquid density, in order to be consistent with the definition of the liquid dielectric properties, i.e. the side length of the 1 g cube is 10mm, with the side length of the 10 g cube 21,5mm.

When the cube intersects with the surface of the phantom, it is oriented so that 3 vertices touch the surface of the shell or the center of a face is tangent to the surface. The face of the cube closest to the surface is modified in order to conform to the tangent surface.

The zoom scan integer steps can be user defined so as to reduce uncertainty, but normal practice for typical test applications (including FCC) utilize a physical step of 7x7x7 (5mmx5mmx5mm) providing a volume of 30mm in the X & Y axis, and 30mm in the Z axis.

2.1.4 ALSAS-10U Interpolation and Extrapolation Uncertainty

The overall uncertainty for the methodology and algorithms the used during the SAR calculation was evaluated using the data from IEEE 1528 based on the example f3 algorithm:

$$f_3(x, y, z) = A \frac{a^2}{\frac{a^2}{4} + x'^2 + y'^2} \cdot \left(e^{-\frac{2z}{a}} + \frac{a^2}{2(a + 2z)^2} \right)$$

2.2 Isotropic E-Field Probe

The isotropic E-Field probe has been fully calibrated and assessed for isotropicity, and boundary effect within a controlled environment. Depending on the frequency for which the probe is calibrated the method utilized for calibration will change. A number of methods is used for calibrating probes, and these are outlined in the table below:

Calibration Frequency	Air Calibration	Tissue Calibration
2450MHz	TEM Cell	Temperature

The E-Field probe utilizes a triangular sensor arrangement as detailed in the diagram below:

Report No : TSC-101-11-AP-25-1 (SAR)

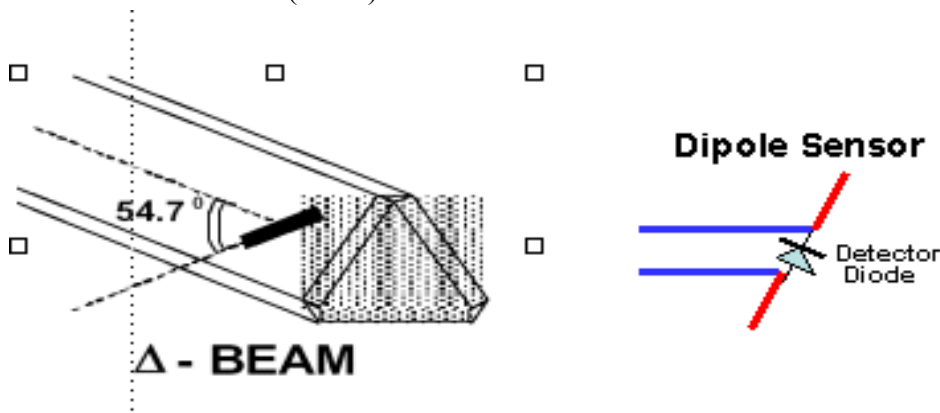

SAR is assessed with a calibrated probe which moves at a default height of 5mm from the center of the diode, which is mounted to the sensor, to the phantom surface (in the Z Axis). The 5mm offset height has been selected so as to minimize any resultant boundary effect due to the probe being in close proximity to the phantom surface.

The following algorithm is an example of the function used by the system for linearization of the output from the probe when measuring complex modulation schemes.

$$V_i = U_i + U_i^2 \cdot \frac{cf}{dcp_i}$$

2.2.1 Isotropic E-Field Probe Specification

Calibration in Air	Frequency Dependent Below 2GHz Calibration in air performed in a TEM Cell Above 2GHz Calibration in air performed in waveguide
Sensitivity	0.70 $\mu\text{V}/(\text{V}/\text{m})^2$ to 0.85 $\mu\text{V}/(\text{V}/\text{m})^2$
Dynamic Range	0.0005 W/kg to 100W/kg
Isotropic Response	Better than 0.2dB
Diode Compression point (DCP)	Calibration for Specific Frequency
Probe Tip Radius	< 5mm
Sensor Offset	1.56 (+/- 0.02mm)
Probe Length	290mm
Video Bandwidth	@ 500 Hz: 1dB @1.02 KHz: 3dB
Boundary Effect	Less than 2% for distance greater than 2.4mm
Spatial Resolution	Diameter less than 5mm Compliant with Standards

Report No : TSC-101-11-AP-25-1 (SAR)

2.3 Boundary Detection Unit and Probe Mounting Device

ALSAS-10U incorporates a boundary detection unit with a sensitivity of 0.05mm for detecting all types of surfaces. The robust design allows for detection during probe tilt (probe normalize) exercises, and utilizes a second stage emergency stop. The signal electronics are fed directly into the robot controller for high accuracy surface detection in lateral and axial detection modes (X, Y, & Z).

The probe is mounted directly onto the Boundary Detection unit for accurate tooling and displacement calculations controlled by the robot kinematics. The probe is connect to an isolated probe interconnect where the output stage of the probe is fed directly into the amplifier stage of the Daq-Paq

2.4 Daq-Paq (Analog to Digital Electronics)

ALSAS-10U incorporates a fully calibrated Daq-Paq (analog to digital conversion system) which has a 4 channel input stage, sent via a 2 stage auto-set amplifier module. The input signal is amplified accordingly so as to offer a dynamic range from 5µV to 800mV. Integration of the fields measured is carried out at board level utilizing a Co-Processor which then sends the measured fields down into the main computational module in digitized form via an RS232 communications port. Probe linearity and duty cycle compensation is carried out within the main Daq-Paq module.

ADC	12 Bit
Amplifier Range	20mV to 200mV and 150mV to 800mV
Field Integration	Local Co-Processor utilizing proprietary integration algorithms
Number of Input Channels	4 in total 3 dedicated and 1 spare
Communication	Packet data via RS232

2.5 Axis Articulated Robot



ALSAS-10U utilizes a six axis articulated robot, which is controlled using a Pentium based real-time movement controller. The movement kinematics engine utilizes proprietary (Thermo CRS) interpolation and extrapolation algorithms, which allow full freedom of movement for each of the six joints within the working envelope. Utilization of joint 6 allows for full probe rotation with a tolerance better than 0.05mm around the central axis.

Robot/Controller Manufacturer	Thermo CRS
Number of Axis	Six independently controlled axis
Positioning Repeatability	0.05mm
Controller Type	Single phase Pentium based C500C
Robot Reach	710mm
Communication	RS232 and LAN compatible

Report No : TSC-101-11-AP-25-1 (SAR)

2.6 ALSAS Universal Workstation

ALSAS Universal workstation allows for repeatability and fast adaptability. It allows users to do calibration, testing and measurements using different types of phantoms with one set up, which significantly speeds up the measurement process.

2.7 Phantom Types

The ALSAS-10U allows the integration of multiple phantom types. SAM Phantoms fully compliant with IEEE 1528, EN50361 Universal Phantom, and Universal Flat.

2.7.1 APREL Laboratories Universal Phantom

The Universal Phantom is used on the ALSAS-10U as a system validation phantom. The Universal Phantom has been fully validated both experimentally from 800MHz to 6GHz and numerically using XFDTD numerical software. The shell thickness is 2mm overall, with a 4mm spacer located at the NF/MB intersection providing an overall thickness of 6mm in line with the requirements of IEEE-1528.

The design allows for fast and accurate measurements, of handsets, by allowing the conservative SAR to be evaluated at on frequency for both left and right head experiments in one measurement.



Report No : TSC-101-11-AP-25-1 (SAR)

3. Tissue Simulating Liquid

3.1 The composition of the tissue simulating liquid

INGREDIENT (% Weight)	900MHz Head	850MHz Body	1900MHz Head	1900MHz Body	2450MHz Head	2450MHz Body
Water	40.92%	53.92%	52.64%	68.64%	73.2	70.2
Salt	1.48%	0.98%	0.36%	0.36%	0.04	0.1
Sugar	56.5%	44.5%	0%	0%	0%	0%
HEC	0.40%	1%	0%	0%	0%	0%
Preventol	0.10%	0.10%	0%	0%	0%	0%
DGBE	0%	0%	47.0%	31.0%	26.7%	29.7%

3.2 Tissue Calibration Result

The dielectric parameters of the liquids were verified prior to the SAR evaluation using APREL Dielectric Probe Kit and Anritsu MS4623B Vector Network Analyzer

Head Tissue Simulant Measurement				Nov. 29 2012	
Frequency [MHz]	Description	Dielectric Parameters		Tissue Temp.	
		ϵ_r	σ [s/m]	[°C]	
		38.1	1.79	22.0	
2450 MHz	Reference result ± 5% window	39.2± 5%	1.80 ± 5%	N/A	
		38.1	1.79	22.0	
Body Tissue Simulant Measurement				Nov. 29 2012	
Frequency [MHz]	Description	Dielectric Parameters		Tissue Temp.	
		ϵ_r	σ [s/m]	[°C]	
		54.9	1.98	22.0	
2450 MHz	Reference result ± 5% window	52.7± 5%	1.95 ± 5%	N/A	
		54.9	1.98	22.0	

Report No : TSC-101-11-AP-25-1 (SAR)

3.3 Tissue Dielectric Parameters for Head and Body Phantoms

The head tissue dielectric parameters recommended by the IEEE SCC-34/SC-2 in P1528 have been incorporated in the following table. These head parameters are derived from planar layer models simulating the highest expected SAR for the dielectric properties and tissue thickness variations in a human head. Other head and body tissue parameters that have not been specified in P1528 are derived from the tissue dielectric parameters computed from the 4-Cole-Cole equations described in Reference [12] and extrapolated according to the head parameters specified in P1528.

Target Frequency (MHz)	Head		Body	
	ϵ_r	σ (S/m)	ϵ_r	σ (S/m)
150	52.3	0.76	61.9	0.80
300	45.3	0.87	58.2	0.92
450	43.5	0.87	56.7	0.94
835	41.5	0.90	55.2	0.97
900	41.5	0.97	55.0	1.05
915	41.5	0.98	55.0	1.06
1450	40.5	1.20	54.0	1.30
1610	40.3	1.29	53.8	1.40
1800 – 2000	40.0	1.40	53.3	1.52
2450	39.2	1.80	52.7	1.95
3000	38.5	2.40	52.0	2.73
5800	35.3	5.27	48.2	6.00

(ϵ_r = relative permittivity, σ = conductivity and $\rho = 1000 \text{ kg/m}^3$)

Report No : TSC-101-11-AP-25-1 (SAR)

4. SAR Measurement Procedure

4.1 SAR System Validation

4.1.1 Validation Dipoles

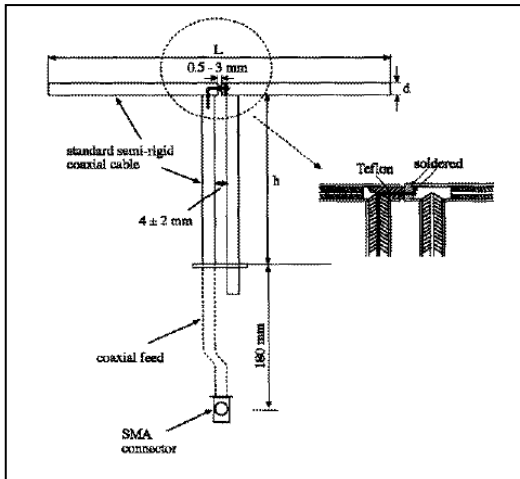

The dipoles used is based on the IEEE-1528 standard, and is complied with mechanical and electrical specifications in line with the requirements of both IEEE and FCC Supplement C. the table below provides details for the mechanical and electrical specifications for the dipoles.

Frequency	L (mm)	h (mm)
900 MHz	149	83.9
1900 MHz	68	39.5
2450MHz	51.5	30.4

4.1.2 Validation Result

Frequency (MHz)	Power	SAR _{1g} (mw/g)	Power Drift (%)	Date
2450	1 W	50.754	-	Nov. 14 2012 cal.
	250mW	26.015	-4.395	Nov. 29 2012
	Normalize to 1 W	51.70		

Report No : TSC-101-11-AP-25-1 (SAR)

2450MHz System validation

SAR Test Report

Report Date : 29-Nov-2012
By Operator : 123
Measurement Date : 29-Nov-2012
Starting Time : 29-Nov-2012 10:26:07 AM
End Time : 29-Nov-2012 10:43:16 AM
Scanning Time : 1029 secs

Product Data
Device Name : validation
Serial No. : 123
Type : Other
Model : 2450
Frequency : 2450.00 MHz
Max. Transmit Pwr : 0.25 W
Drift Time : 0 min(s)
Length : 45 mm
Width : 3 mm
Depth : 2 mm
Antenna Type : Internal
Orientation : Rotated Left 90°
Power Drift-Start : 15.076 W/kg
Power Drift-Finish: 14.414 W/kg
Power Drift (%) : -4.395
Picture :

Phantom Data
Name : APREL-Uni
Type : Uni-Phantom
Size (mm) : 280 x 280 x 200
Serial No. : User Define
Location : Center
Description : Uni_Phantom

Tissue Data
Type : HEAD
Serial No. : 2450
Frequency : 2450.00 MHz
Last Calib. Date : 29-Nov-2012
Temperature : 22.00 °C
Ambient Temp. : 22.00 °C
Humidity : 55.00 RH%
Epsilon : 38.10 F/m
Sigma : 1.79 S/m
Density : 1000.00 kg/cu. m

Report No : TSC-101-11-AP-25-1 (SAR)

Probe Data

Name : Probe 257 - CHTL
Model : E020
Type : E-Field Triangle
Serial No. : 257
Last Calib. Date : 14-Nov-2012
Frequency : 2450.00 MHz
Duty Cycle Factor: 1
Conversion Factor: 5
Probe Sensitivity: 1.20 1.20 1.20 $\mu\text{V}/(\text{V}/\text{m})^2$
Compression Point: 95.00 mV
Offset : 1.56 mm

Measurement Data

Crest Factor : 1
Scan Type : Complete
Tissue Temp. : 22.00 °C
Ambient Temp. : 22.00 °C
Set-up Date : 29-Nov-2012
Set-up Time : 10:25:51 AM
Area Scan : 5x5x1 : Measurement x=15mm, y=15mm, z=4mm
Zoom Scan : 5x5x8 : Measurement x=8mm, y=8mm, z=4mm

Other Data

DUT Position : Rotated Left 90°
Separation : 0
Channel : Mid

Report No : TSC-101-11-AP-25-1 (SAR)

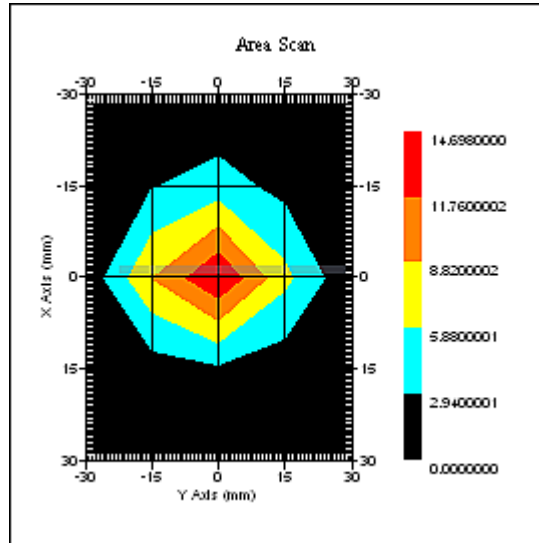

1 gram SAR value : 12.926 W/kg
Area Scan Peak SAR : 14.698 W/kg
Zoom Scan Peak SAR : 29.524 W/kg

Report No : TSC-101-11-AP-25-1 (SAR)

Exposure Assessment Measurement Uncertainty

Source of Uncertainty	Tolerance Value	Probability Distribution	Divisor	c_i^{-1} (1-g)	Standard Uncertainty (1-g) %
Measurement System					
Probe Calibration	3.5	normal	1	1	3.5
Axial Isotropy	3.7	rectangular	$\sqrt{3}$	$(1-cp)^{1/2}$	1.5
Hemispherical Isotropy	10.9	rectangular	$\sqrt{3}$	\sqrt{cp}	4.4
Boundary Effect	1.0	rectangular	$\sqrt{3}$	1	0.6
Linearity	4.7	rectangular	$\sqrt{3}$	1	2.7
Detection Limit	1.0	rectangular	$\sqrt{3}$	1	0.6
Readout Electronics	1.0	normal	1	1	1.0
Response Time	0.8	rectangular	$\sqrt{3}$	1	0.5
Integration Time	1.7	rectangular	$\sqrt{3}$	1	1.0
RF Ambient Condition	3.0	rectangular	$\sqrt{3}$	1	1.7
Probe Positioner Mech.	0.4	rectangular	$\sqrt{3}$	1	0.2
Restriction					
Probe Positioning with respect to Phantom Shell	2.9	rectangular	$\sqrt{3}$	1	1.7
Extrapolation and Integration	3.7	rectangular	$\sqrt{3}$	1	2.1
Test Sample Positioning	4.0	normal	1	1	4.0
Device Holder Uncertainty	2.0	normal	1	1	2.0
Drift of Output Power	4.4	rectangular	$\sqrt{3}$	1	2.5
Phantom and Setup					
Phantom Uncertainty(shape & thickness tolerance)	3.4	rectangular	$\sqrt{3}$	1	2.0
Liquid Conductivity(target)	5.0	rectangular	$\sqrt{3}$	0.7	2.0
Liquid Conductivity(meas.)	0.6	normal	1	0.7	0.4
Liquid Permittivity(target)	5.0	rectangular	$\sqrt{3}$	0.6	1.7
Liquid Permittivity(meas.)	2.8	normal	1	0.6	1.7
Combined Uncertainty		RSS			9.7
Combined Uncertainty (coverage factor=2)		Normal(k=2)			19.4

Report No : TSC-101-11-AP-25-1 (SAR)

SAR-Z Axis
at Hotspot x:0.07 y:-0.22

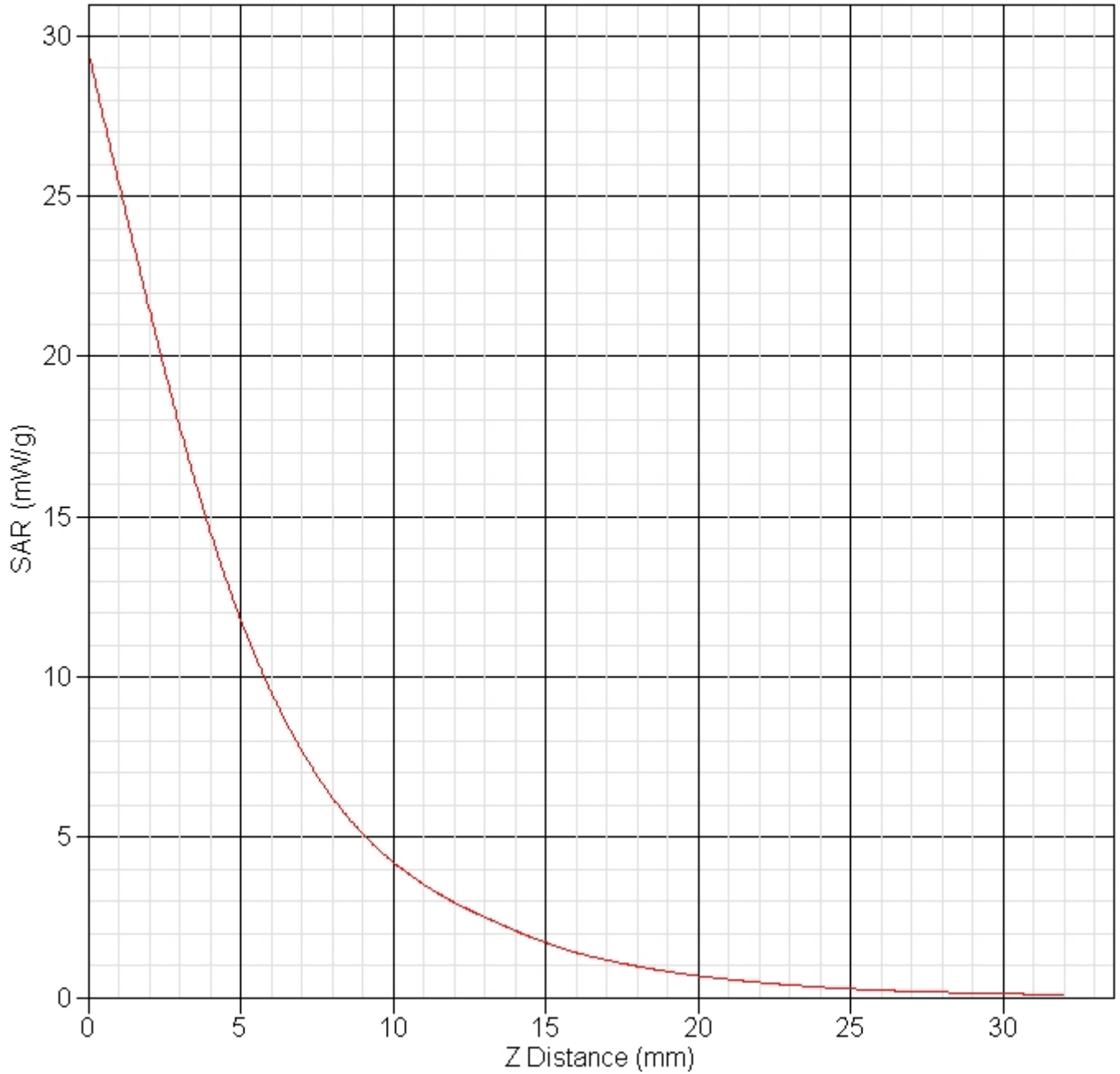

Report No : TSC-101-11-AP-25-1 (SAR)

4.2 Arrangement Assessment Setup

4.2.1 Test Positions for body-worn

Body-worn operating configurations should be tested with the belt-clips and holsters attached to the device and positioned against a flat phantom in normal use configurations. A separation distance of 1.5 cm between the back of the device and a flat phantom is recommended for testing body-worn SAR compliance under such circumstances. Other separation distance may be use, but not exceed 2.5 cm.

4.3 SAR Measurement Procedure

The ALSAS-10U calculates SAR using the following equation,

$$SAR = \frac{\sigma |E|^2}{\rho}$$

σ : represents the simulated tissue conductivity

ρ : represents the tissue density

The EUT is set to transmit at the required power in line with product specification, at each frequency relating to the LOW, MID, and HIGH channel settings.

Pre-scans are made on the device to establish the location for the transmitting antenna, using a large area scan in either air or tissue simulation fluid.

The EUT is placed against the Universal Phantom where the maximum area scan dimensions are larger than the physical size of the resonating antenna. When the scan size is not large enough to cover the peak SAR distribution, it is modified by either extending the area scan size in both the X and Y directions, or the device is shifted within the predefined area.

The area scan is then run to establish the peak SAR location (interpolated resolution set at 1mm²) which is then used to orient the center of the zoom scan. The zoom scan is then executed and the 1g and 10g averages are derived from the zoom scan volume (interpolated resolution set at 1mm³).

Report No : TSC-101-11-AP-25-1 (SAR)

5. SAR Exposure Limits

SAR assessments have been made in line with the requirements of IEEE-1528, FCC Supplement C, and comply with ANSI/IEEE C95.1-1992 "Uncontrolled Environments" limits. These limits apply to a location which is deemed as "Uncontrolled Environment" which can be described as a situation where the general public may be exposed to an RF source with no prior knowledge or control over their exposure.

Limits for General Population/Uncontrolled Exposure (W/kg)

Type Exposure	Uncontrolled Environment Limit
Spatial Peak SAR (1g cube tissue for brain or body)	1.60 W/kg
Spatial Average SAR (whole body)	0.08 W/kg
Spatial Peak SAR (10g for hands, feet, ankles and wrist)	4.00 W/kg

Report No : TSC-101-11-AP-25-1 (SAR)

6. Test Equipment List

Instrument	Manufacturer	Model No.	Calibration Due	Calibration Cycle(year)
Data Acquisition Package	Aprel	ALS-DAQ-PAQ-2	NCR	NCR
Aprel Laboratories Probe	Aprel	ALS-E020(257)	14-Nov-2013	1
Aprel Laboratories Probe	Aprel	ALS-E020(SGL1)	10-Feb-2013	1
*Aprel Laboratories Dipole	Aprel	ALS-D-900-S-2	18-Oct-2013	3
*Aprel Laboratories Dipole	Aprel	ALS-D-1900-S-2	18-Oct-2013	3
*Aprel Laboratories Dipole	Aprel	ALS-D-2450-S-2	14-Nov-2015	3
Boundary Detection Sensor System	Aprel	ALS-PMDPS-2	NCR	NCR
Dielectric Probe Kit	Aprel	ALS-PR-DIEL	NCR	NCR
Universal Work Station	Aprel	ALS-UWS	NCR	NCR
Device Holder 2.0	Aprel	ALS-H-E-SET-2	NCR	NCR
Left Ear SAM Phantom	Aprel	ALS-P-SAM-L	NCR	NCR
Right Ear SAM Phantom	Aprel	ALS-P-SAM-R	NCR	NCR
Flat Phantom	Aprel	ALS-P-UP-1	NCR	NCR
Aprel Dipole Spacer	Aprel	ALS-DS-U	NCR	NCR
SAR Software	Aprel	ALSAS-10	NCR	NCR
CRS C500C Controller	Thermo	ALS-C500	NCR	NCR
CRF F3 Robot	Thermo	ALS-F3	NCR	NCR
Power Amplifier	Mini-Circuit	ZHL-42	NCR	NCR
Directional Coupler	Agilent	778D-012	NCR	NCR
Power meter	HP	437B	May 11 2013	1
Vector S/G	R&S	SMU200A	May 11 2013	1
Wireless Communications Test Set	Agilent	8960	May 11 2013	1
Vector Network	Anritsu	MS4623B	May 15 2013	1

*The ALS-D-2450-S-2 dipole meet KDB 450824 requirements for the extended 3-year calibration interval. Please refer to P.52 and P.55 (return loss -25.451dB vs -27.84dB; impedance 46.2Ω vs 47.51Ω)

Report No : TSC-101-11-AP-25-1 (SAR)

7. Measurement Uncertainty

Source of Uncertainty	Tolerance Value	Probability Distribution	Divisor	c_i^{-1} (1-g)	Standard Uncertainty (1-g) %
Measurement System					
Probe Calibration	3.5	normal	1	1	3.5
Axial Isotropy	3.7	rectangular	$\sqrt{3}$	$(1-cp)^{1/2}$	1.5
Hemispherical Isotropy	10.9	rectangular	$\sqrt{3}$	\sqrt{cp}	4.4
Boundary Effect	1.0	rectangular	$\sqrt{3}$	1	0.6
Linearity	4.7	rectangular	$\sqrt{3}$	1	2.7
Detection Limit	1.0	rectangular	$\sqrt{3}$	1	0.6
Readout Electronics	1.0	normal	1	1	1.0
Response Time	0.8	rectangular	$\sqrt{3}$	1	0.5
Integration Time	1.7	rectangular	$\sqrt{3}$	1	1.0
RF Ambient Condition	3.0	rectangular	$\sqrt{3}$	1	1.7
Probe Positioner Mech.	0.4	rectangular	$\sqrt{3}$	1	0.2
Restriction					
Probe Positioning with respect to Phantom Shell	2.9	rectangular	$\sqrt{3}$	1	1.7
Extrapolation and Integration	3.7	rectangular	$\sqrt{3}$	1	2.1
Test Sample Positioning	4.0	normal	1	1	4.0
Device Holder Uncertainty	2.0	normal	1	1	2.0
Drift of Output Power	4.4	rectangular	$\sqrt{3}$	1	2.6
Phantom and Setup					
Phantom Uncertainty(shape & thickness tolerance)	3.4	rectangular	$\sqrt{3}$	1	2.0
Liquid Conductivity(target)	5.0	rectangular	$\sqrt{3}$	0.7	2.0
Liquid Conductivity(meas.)	0.0	normal	1	0.7	0.0
Liquid Permittivity(target)	5.0	rectangular	$\sqrt{3}$	0.6	1.7
Liquid Permittivity(meas.)	0.5	normal	1	0.6	0.3
Combined Uncertainty		RSS			9.6
Combined Uncertainty (coverage factor=2)		Normal(k=2)			19.2

Report No : TSC-101-11-AP-25-1 (SAR)

8 SAR Test Results

Conducted power measured(WiFi and Bluetooth)

Mode	Channel (Freq. MHz)	Output Power	
		PK(dBm)	AV(dBm)
802.11b	1(2412)	18.8	16.3
	6(2437)	19.6	17.2
	11(2462)	18.8	16.2
802.11g	1(2412)	14.2	11.5
	6(2437)	14.1	11.5
	11(2462)	14.4	11.8
802.11n(HT20)	1(2412)	11.7	9.2
	6(2437)	10.9	8.7
	11(2462)	11.0	8.7
Bluetooth	3.5dBm \geq Output power \geq 1dBm		

SAR Measured(WiFi)

Test Position Body	Antenna Type	Frequency		Conducted Power (dBm)		SAR 1g (W/kg)	Power Drift %	Limit (W/kg)
		Channel	MHz	Max	Av			
802.11b_Front	INTERNAL	6	2437	19.6	17.2	0.292	-6.943	1.6
802.11b_Rear	INTERNAL	6	2437	19.6	17.2	0.081	-4.90	1.6
802.11b_Side	INTERNAL	6	2437	19.6	17.2	0.713	4.293	1.6
802.11b_Side	INTERNAL	1	2412	18.8	16.3	0.651	4.816	1.6
802.11b_Side	INTERNAL	11	2462	18.8	16.2	0.633	4.094	1.6

Note:

1. The test signals (Tx power, Continuous mode and Channel) were Controlled by “RF test utility” which provides by Manufacturer during WiFi SAR testing.
2. According to KDB 248227, SAR is not required for 802.11g channels when the maximum average output power is less than 1/4 dB higher than that measured on the corresponding 802.11b channels.
3. Bluetooth Conducted Maximum Output power \leq 3.5dBm. The MPE is 7.72×10^{-4} mW/cm² which is compliant with the MPE limits of 1.1310.

Report No : TSC-101-11-AP-25-1 (SAR)

1.1310 MPE Limits

TABLE 1—LIMITS FOR MAXIMUM PERMISSIBLE EXPOSURE (MPE)

Frequency range (MHz)	Electric field strength (V/m)	Magnetic field strength (A/m)	Power density (mW/cm ²)	Averaging time (minutes)
(A) Limits for Occupational/Controlled Exposures				
0.3–3.0	614	1.63	*(100)	6
3.0–30	1842/f	4.89/f	*(900/f ²)	6
30–300	61.4	0.163	1.0	6
300–1500	f/300	6
1500–100,000	5	6
(B) Limits for General Population/Uncontrolled Exposure				
0.3–1.34	614	1.63	*(100)	30
1.34–30	824/f	2.19/f	*(180/f ²)	30
30–300	27.5	0.073	0.2	30
300–1500	f/1500	30
1500–100,000	1.0	30

f = frequency in MHz

* = Plane-wave equivalent power density

NOTE 1 TO TABLE 1: Occupational/controlled limits apply in situations in which persons are exposed as a consequence of their employment provided those persons are fully aware of the potential for exposure and can exercise control over their exposure. Limits for occupational/controlled exposure also apply in situations when an individual is transient through a location where occupational/controlled limits apply provided he or she is made aware of the potential for exposure.

NOTE 2 TO TABLE 1: General population/uncontrolled exposures apply in situations in which the general public may be exposed, or in which persons that are exposed as a consequence of their employment may not be fully aware of the potential for exposure or can not exercise control over their exposure.

Report No : TSC-101-11-AP-25-1 (SAR)

9. EUT Photographs



Front View of EUT

Report No : TSC-101-11-AP-25-1 (SAR)



Rear View of EUT

Report No : TSC-101-11-AP-25-1 (SAR)

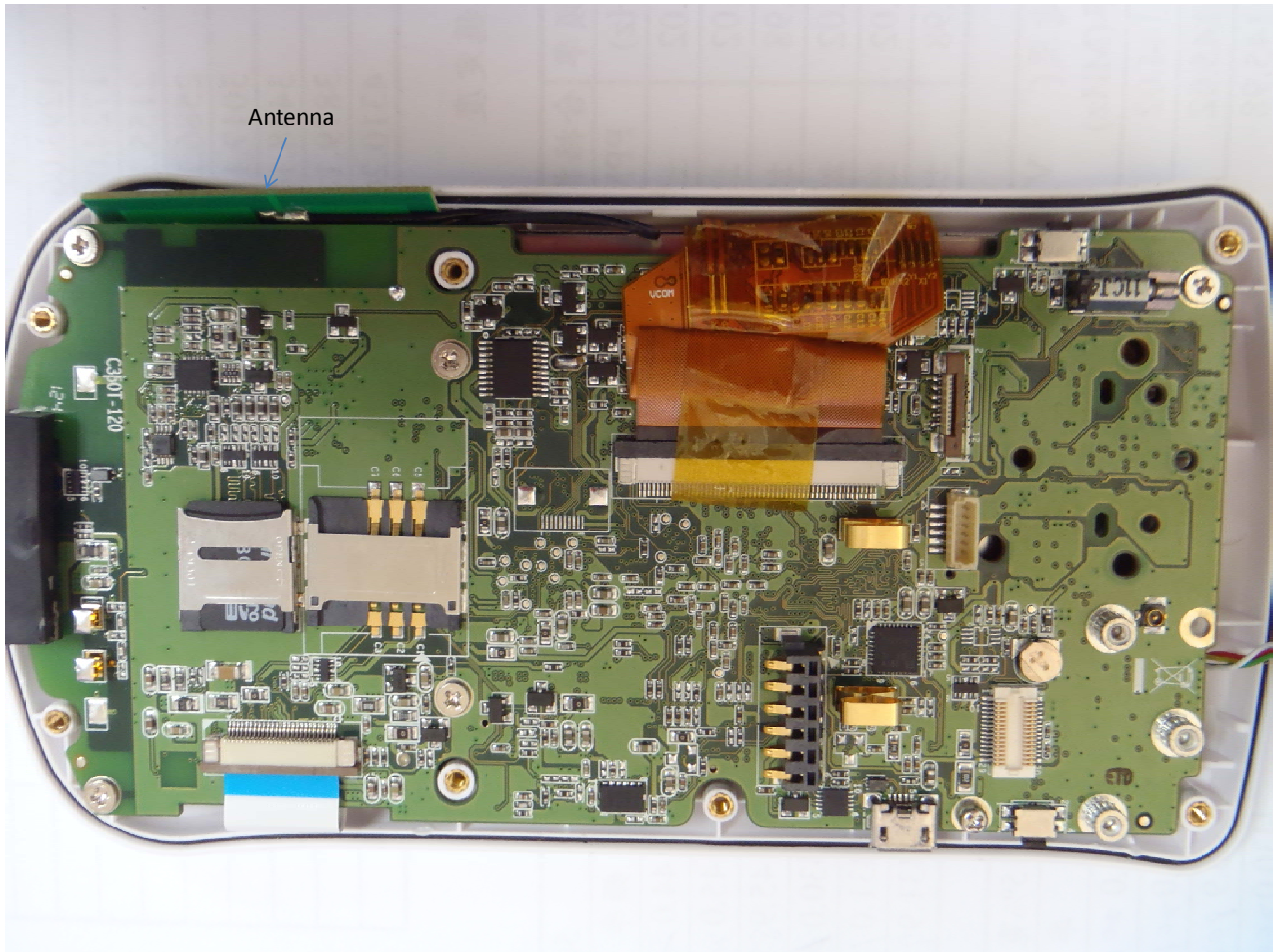

EUT inside Rear View and Transmit Antenna Location

Report No : TSC-101-11-AP-25-1 (SAR)

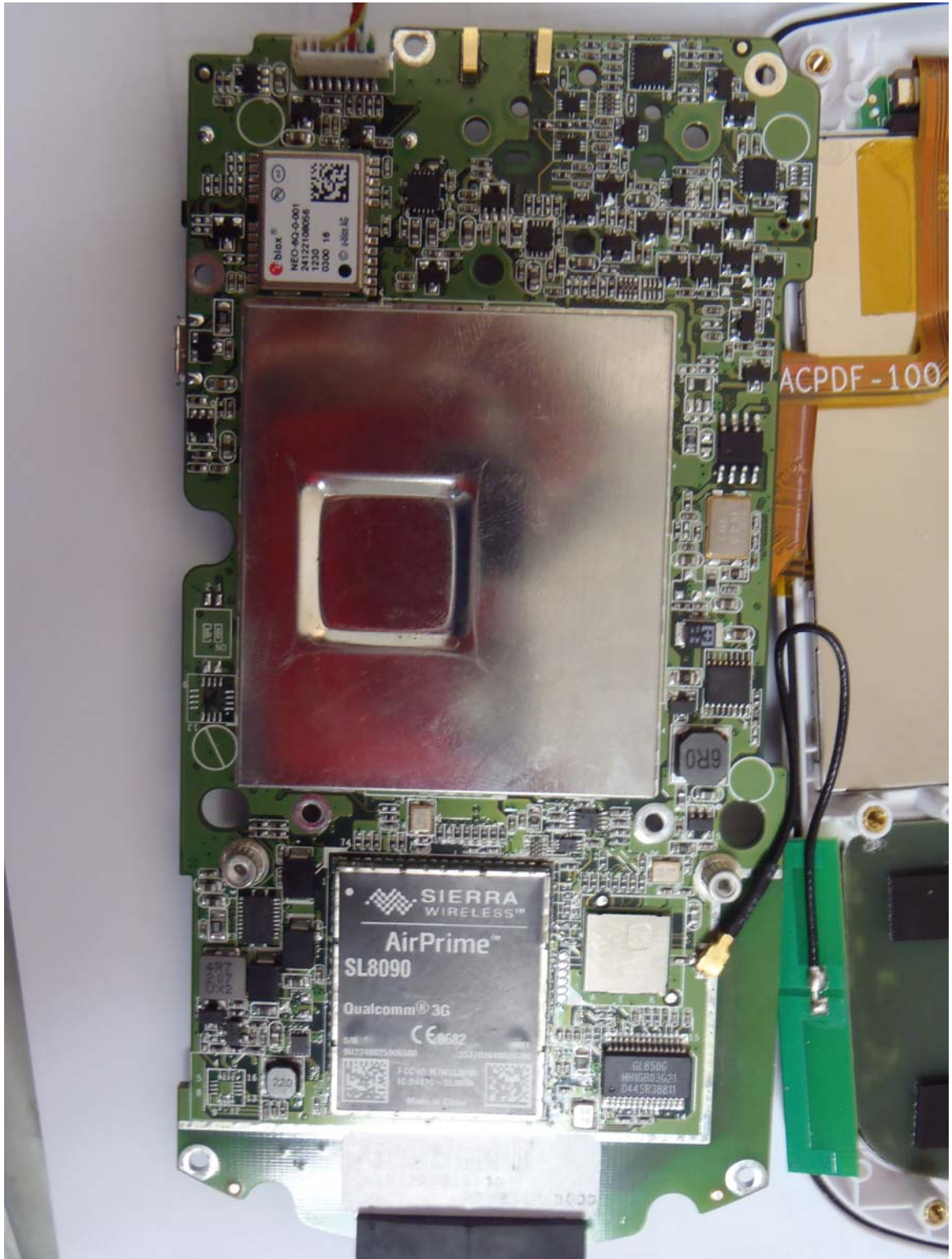

EUT inside Front View

Report No : TSC-101-11-AP-25-1 (SAR)



Front View of WLAN/Bluetooth Antenna



Rear View of the WLAN/Bluetooth Antenna

Report No : TSC-101-11-AP-25-1 (SAR)

A. TEST CONFIGURATIONS AND TEST DATA

A.1 TEST CONFIGURATION

WiFi Front Touch



Report No : TSC-101-11-AP-25-1 (SAR)

WiFi Side Touch



Report No : TSC-101-11-AP-25-1 (SAR)

WiFi RearTouch

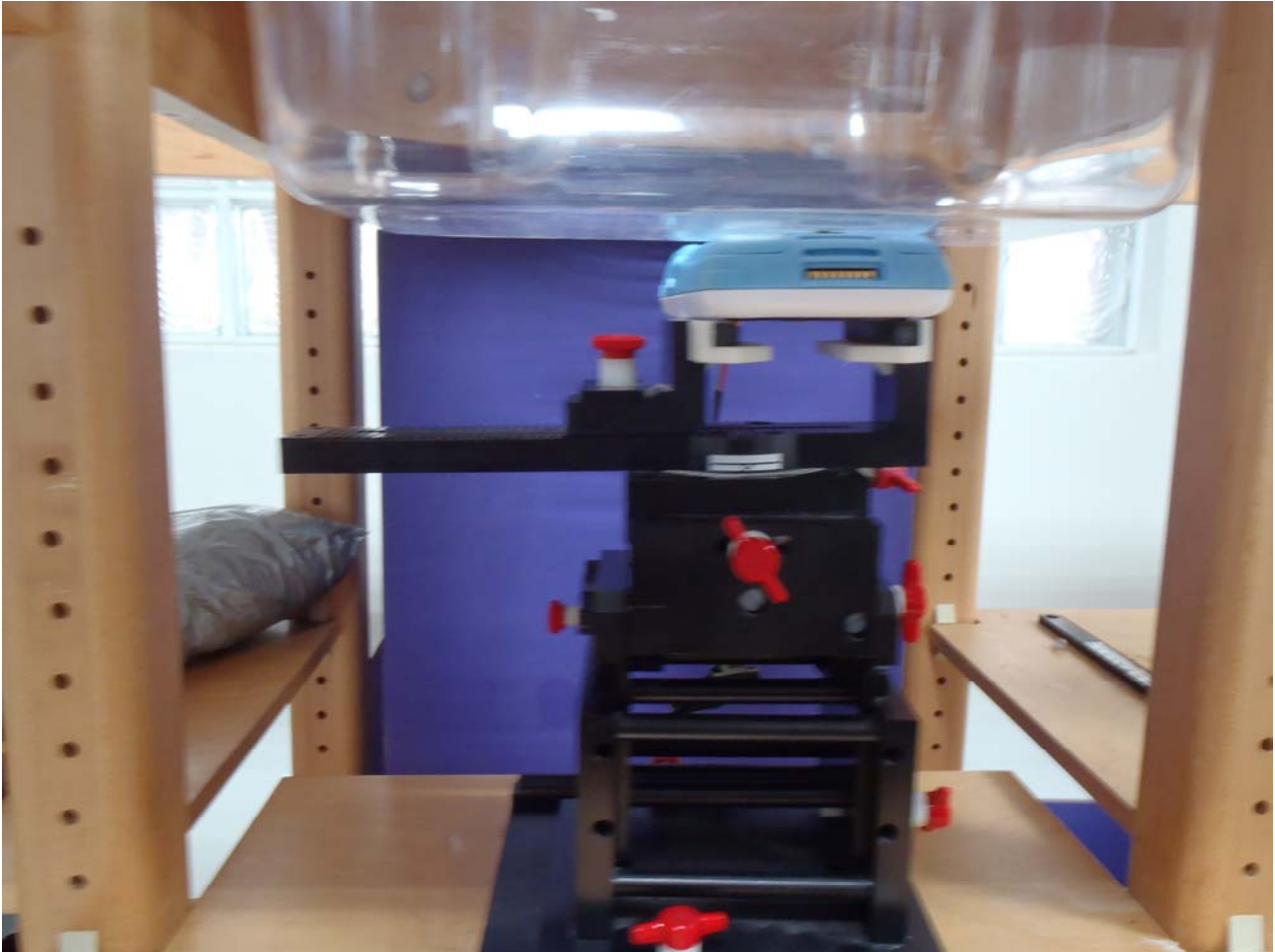

Report No : TSC-101-11-AP-25-1 (SAR)

A.2 LIQUID LEVEL PHOTO

Liquid Level in Flat Phantom > 15cm

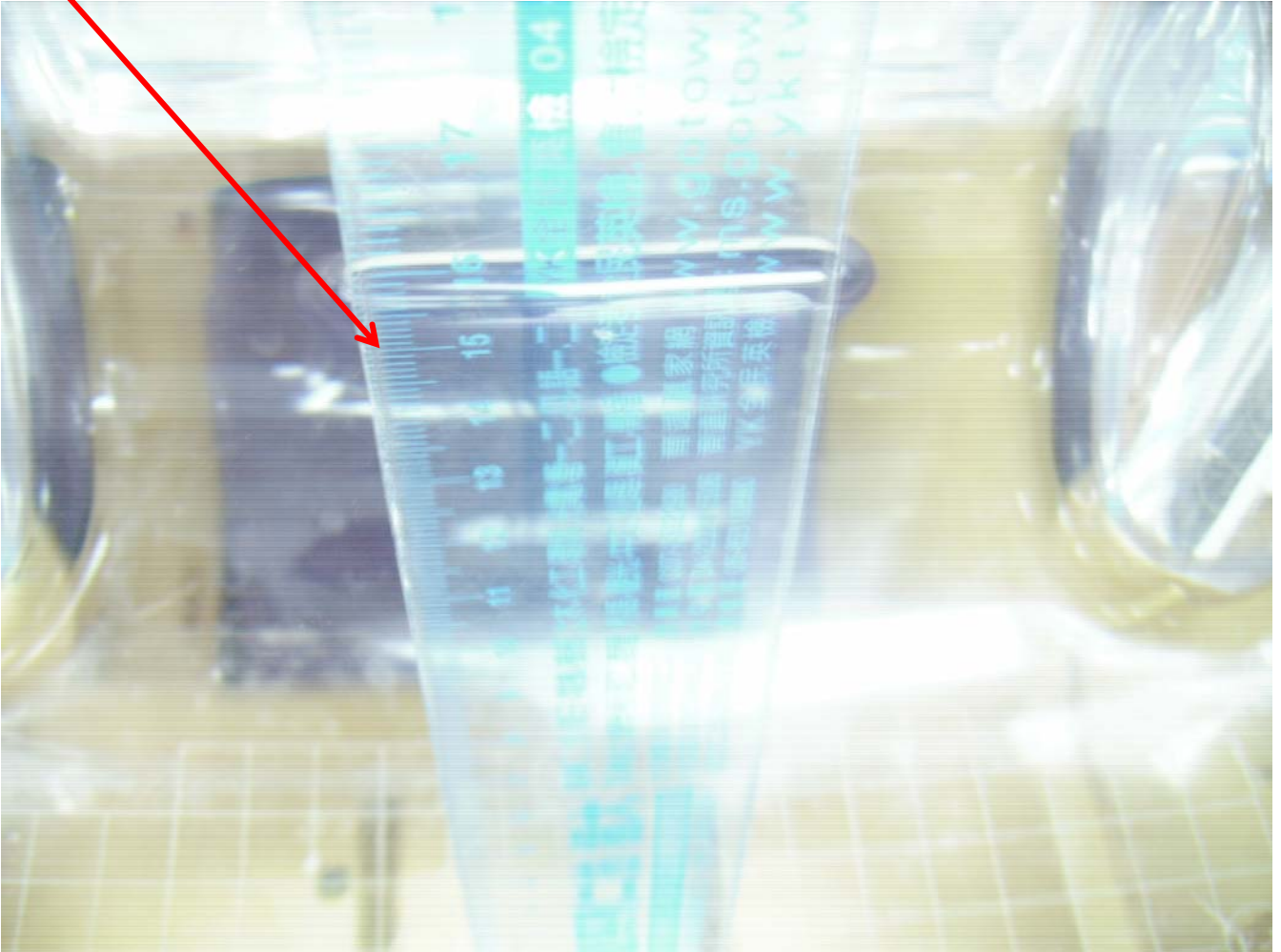

Report No : TSC-101-11-AP-25-1 (SAR)

A.3 TISSUE LIQUIDS Dielectric Parameter

A.3.1 2450 MHz TISSUE LIQUIDS Dielectric measurement data

Head Tissue

Tissue Data

Epsilon : 39.5 F/m

Sigma : 1.82 S/m

Density : 1000.00 kg/cu. M

Body Tissue

Tissue Data

Epsilon : 52.5 F/m

Sigma : 1.99 S/m

Density : 1000.00 kg/cu. M

Report No : TSC-101-11-AP-25-1 (SAR)

A.4. TEST DATA

A.4.1 802.11b Mode

Low Channel Side Touch

SAR Test Report

Report Date : 29-Nov-2012
By Operator : 123
Measurement Date : 29-Nov-2012
Starting Time : 29-Nov-2012 11:24:04 AM
End Time : 29-Nov-2012 11:42:28 AM
Scanning Time : 1104 secs

Product Data
Device Name : Winmate
Serial No. : 123
Type : PDA
Model : 2450
Frequency : 2450.00 MHz
Max. Transmit Pwr : 0.25 W
Drift Time : 0 min(s)
Length : 154 mm
Width : 80 mm
Depth : 27 mm
Antenna Type : Internal
Orientation : Rotated Left 90°
Power Drift-Start : 0.232 W/kg
Power Drift-Finish: 0.254 W/kg
Power Drift (%) : 4.816
Picture :

Phantom Data
Name : APREL-Uni
Type : Uni-Phantom
Size (mm) : 280 x 280 x 200
Serial No. : User Define
Location : Center
Description : Uni_Phantom

Tissue Data
Type : BODY
Serial No. : 2450
Frequency : 2450.00 MHz
Last Calib. Date : 29-Nov-2012
Temperature : 22.00 °C
Ambient Temp. : 22.00 °C
Humidity : 55.00 RH%
Epsilon : 54.90 F/m
Sigma : 1.98 S/m

Report No : TSC-101-11-AP-25-1 (SAR)

Density : 1000.00 kg/cu. m
Probe Data
Name : Probe 257 - CHTL
Model : E020
Type : E-Field Triangle
Serial No. : 257
Last Calib. Date : 14-Nov-2012
Frequency : 2450.00 MHz
Duty Cycle Factor: 1
Conversion Factor: 4.5
Probe Sensitivity: 1.20 1.20 1.20 $\mu\text{V}/(\text{V}/\text{m})^2$
Compression Point: 95.00 mV
Offset : 1.56 mm

Measurement Data

Crest Factor : 1
Scan Type : Complete
Tissue Temp. : 22.00 °C
Ambient Temp. : 22.00 °C
Set-up Date : 29-Nov-2012
Set-up Time : 10:48:26 AM
Area Scan : 6x5x1 : Measurement x=15mm, y=15mm, z=4mm
Zoom Scan : 5x5x8 : Measurement x=8mm, y=8mm, z=4mm

Other Data

DUT Position : Rotated Left 90°
Separation : 0
Channel : Low

Report No : TSC-101-11-AP-25-1 (SAR)

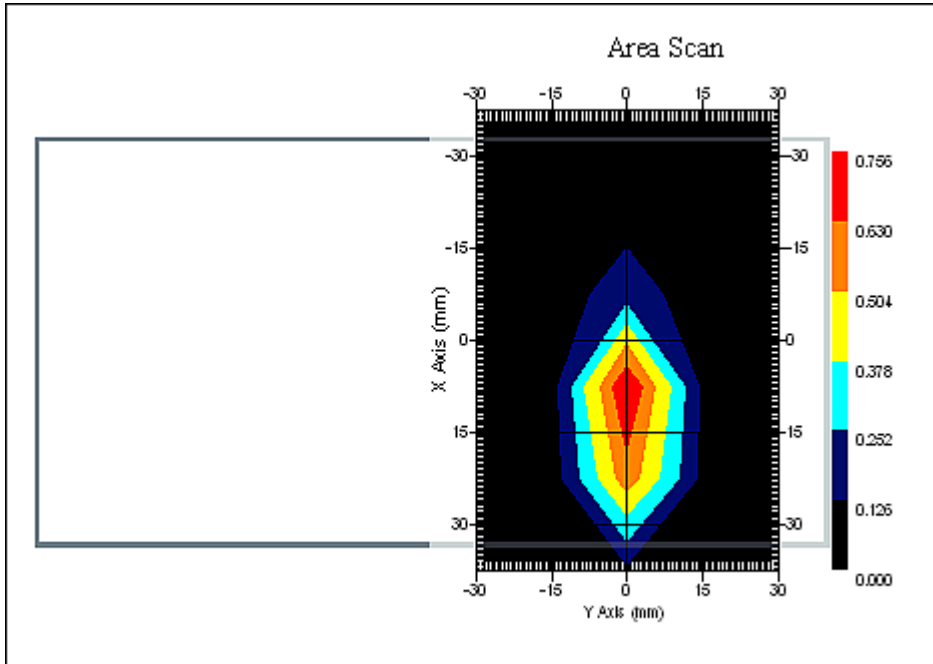

1 gram SAR value : 0.651 W/kg
Area Scan Peak SAR : 0.755 W/kg
Zoom Scan Peak SAR : 1.561 W/kg

Report No : TSC-101-11-AP-25-1 (SAR)

Exposure Assessment Measurement Uncertainty

Source of Uncertainty	Tolerance Value	Probability Distribution	Divisor	c_i^{-1} (1-g)	Standard Uncertainty (1-g) %
Measurement System					
Probe Calibration	3.5	normal	1	1	3.5
Axial Isotropy	3.7	rectangular	$\sqrt{3}$	$(1-cp)^{1/2}$	1.5
Hemispherical Isotropy	10.9	rectangular	$\sqrt{3}$	\sqrt{cp}	4.4
Boundary Effect	1.0	rectangular	$\sqrt{3}$	1	0.6
Linearity	4.7	rectangular	$\sqrt{3}$	1	2.7
Detection Limit	1.0	rectangular	$\sqrt{3}$	1	0.6
Readout Electronics	1.0	normal	1	1	1.0
Response Time	0.8	rectangular	$\sqrt{3}$	1	0.5
Integration Time	1.7	rectangular	$\sqrt{3}$	1	1.0
RF Ambient Condition	3.0	rectangular	$\sqrt{3}$	1	1.7
Probe Positioner Mech.	0.4	rectangular	$\sqrt{3}$	1	0.2
Restriction					
Probe Positioning with respect to Phantom Shell	2.9	rectangular	$\sqrt{3}$	1	1.7
Extrapolation and Integration	3.7	rectangular	$\sqrt{3}$	1	2.1
Test Sample Positioning	4.0	normal	1	1	4.0
Device Holder Uncertainty	2.0	normal	1	1	2.0
Drift of Output Power	4.8	rectangular	$\sqrt{3}$	1	2.8
Phantom and Setup					
Phantom Uncertainty(shape & thickness tolerance)	3.4	rectangular	$\sqrt{3}$	1	2.0
Liquid Conductivity(target)	5.0	rectangular	$\sqrt{3}$	0.7	2.0
Liquid Conductivity(meas.)	1.5	normal	1	0.7	1.1
Liquid Permittivity(target)	5.0	rectangular	$\sqrt{3}$	0.6	1.7
Liquid Permittivity(meas.)	4.2	normal	1	0.6	2.5
Combined Uncertainty		RSS			10.8
Combined Uncertainty (coverage factor=2)		Normal(k=2)			21.6

Report No : TSC-101-11-AP-25-1 (SAR)

SAR-Z Axis
at Hotspot x:23.09 y:-0.24

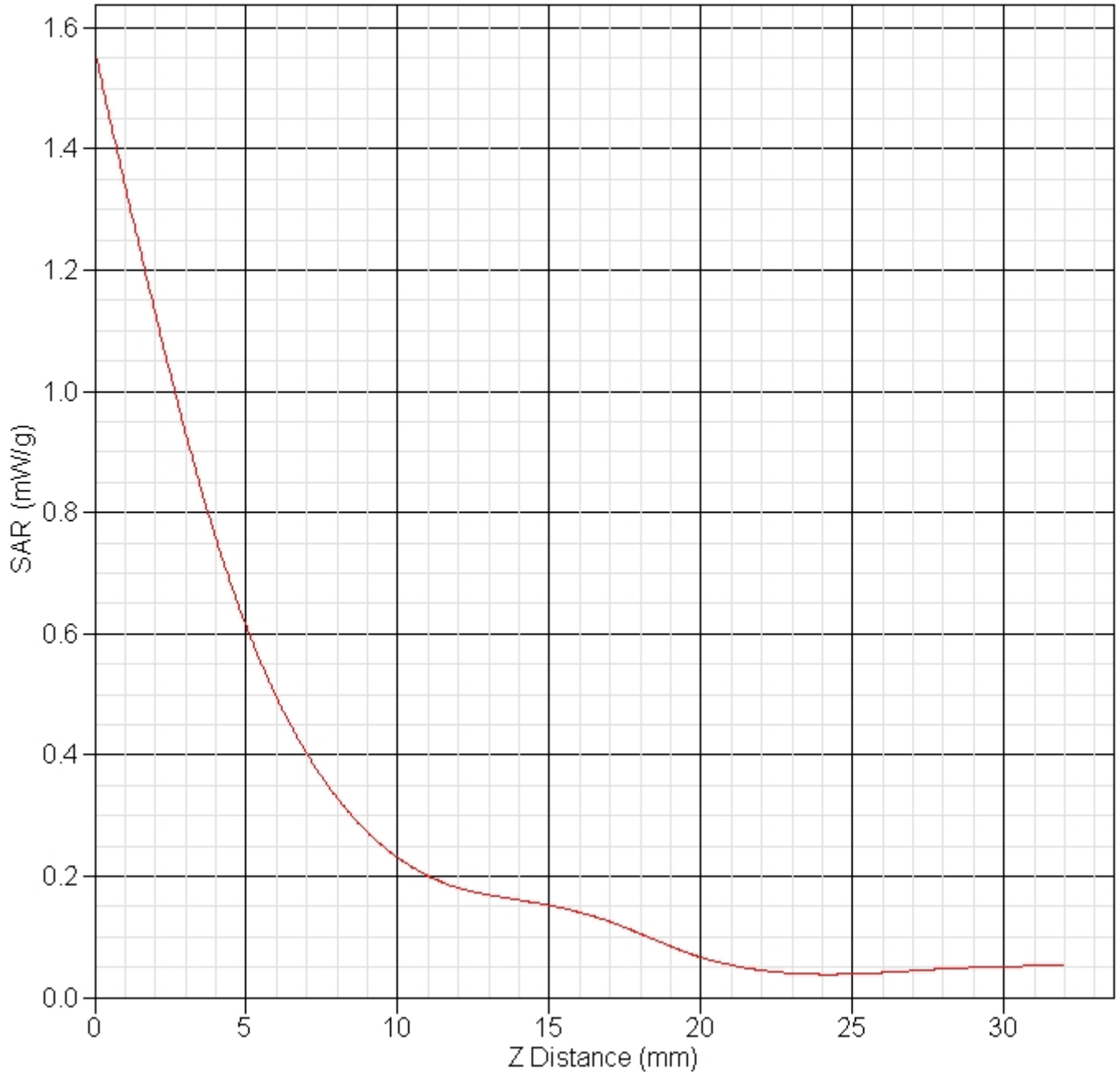

Report No : TSC-101-11-AP-25-1 (SAR)

Mid Channel Rear Touch

SAR Test Report

Report Date : 29-Nov-2012
By Operator : 123
Measurement Date : 29-Nov-2012
Starting Time : 29-Nov-2012 10:57:55 AM
End Time : 29-Nov-2012 11:20:07 AM
Scanning Time : 1332 secs

Product Data

Device Name : Winmate
Serial No. : 123
Type : PDA
Model : 2450
Frequency : 2450.00 MHz
Max. Transmit Pwr : 0.25 W
Drift Time : 0 min(s)
Length : 154 mm
Width : 80 mm
Depth : 27 mm
Antenna Type : Internal
Orientation : Rotated Left 90°
Power Drift-Start : 0.344 W/kg
Power Drift-Finish : 0.385 W/kg
Power Drift (%) : 4.923
Picture :

Phantom Data

Name : APREL-Uni
Type : Uni-Phantom
Size (mm) : 280 x 280 x 200
Serial No. : User Define
Location : Center
Description : Uni_Phantom

Tissue Data

Type : BODY
Serial No. : 2450
Frequency : 2450.00 MHz
Last Calib. Date : 29-Nov-2012
Temperature : 22.00 °C
Ambient Temp. : 22.00 °C
Humidity : 55.00 RH%
Epsilon : 54.90 F/m
Sigma : 1.98 S/m
Density : 1000.00 kg/cu. m

Probe Data

Name : Probe 257 - CHTL
Model : E020
Type : E-Field Triangle

Report No : TSC-101-11-AP-25-1 (SAR)

Serial No. : 257
Last Calib. Date : 14-Nov-2012
Frequency : 2450.00 MHz
Duty Cycle Factor: 1
Conversion Factor: 4.5
Probe Sensitivity: 1.20 1.20 1.20 $\mu\text{V}/(\text{V}/\text{m})^2$
Compression Point: 95.00 mV
Offset : 1.56 mm

Measurement Data

Crest Factor : 1
Scan Type : Complete
Tissue Temp. : 22.00 °C
Ambient Temp. : 22.00 °C
Set-up Date : 29-Nov-2012
Set-up Time : 10:48:26 AM
Area Scan : 8x6x1 : Measurement x=15mm, y=15mm, z=4mm
Zoom Scan : 5x5x8 : Measurement x=8mm, y=8mm, z=4mm

Other Data

DUT Position : Rotated Left 90°
Separation : 0
Channel : Mid

Report No : TSC-101-11-AP-25-1 (SAR)

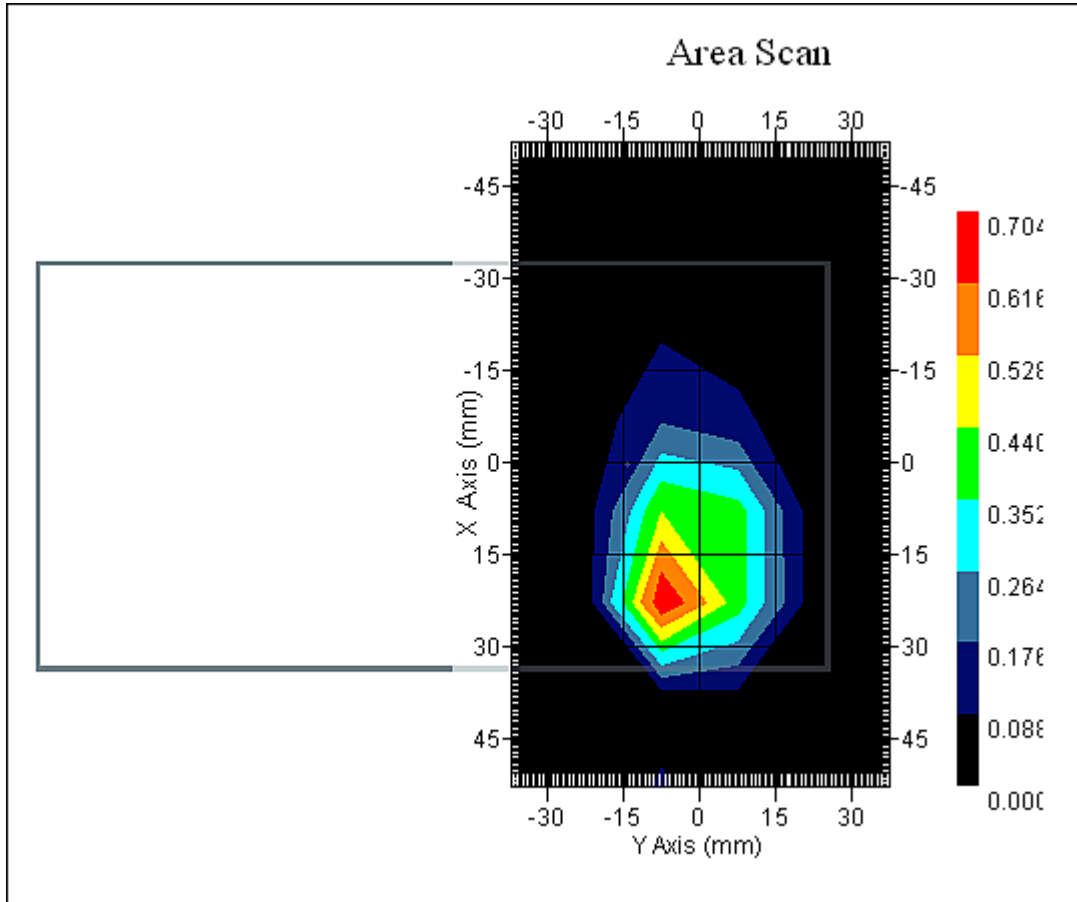

1 gram SAR value : 0.713 W/kg
Area Scan Peak SAR : 0.703 W/kg
Zoom Scan Peak SAR : 1.781 W/kg

Report No : TSC-101-11-AP-25-1 (SAR)

Exposure Assessment Measurement Uncertainty

Source of Uncertainty	Tolerance Value	Probability Distribution	Divisor	c_i^{-1} (1-g)	Standard Uncertainty (1-g) %
Measurement System					
Probe Calibration	3.5	normal	1	1	3.5
Axial Isotropy	3.7	rectangular	$\sqrt{3}$	$(1-cp)^{1/2}$	1.5
Hemispherical Isotropy	10.9	rectangular	$\sqrt{3}$	\sqrt{cp}	4.4
Boundary Effect	1.0	rectangular	$\sqrt{3}$	1	0.6
Linearity	4.7	rectangular	$\sqrt{3}$	1	2.7
Detection Limit	1.0	rectangular	$\sqrt{3}$	1	0.6
Readout Electronics	1.0	normal	1	1	1.0
Response Time	0.8	rectangular	$\sqrt{3}$	1	0.5
Integration Time	1.7	rectangular	$\sqrt{3}$	1	1.0
RF Ambient Condition	3.0	rectangular	$\sqrt{3}$	1	1.7
Probe Positioner Mech.	0.4	rectangular	$\sqrt{3}$	1	0.2
Restriction					
Probe Positioning with respect to Phantom Shell	2.9	rectangular	$\sqrt{3}$	1	1.7
Extrapolation and Integration	3.7	rectangular	$\sqrt{3}$	1	2.1
Test Sample Positioning	4.0	normal	1	1	4.0
Device Holder Uncertainty	2.0	normal	1	1	2.0
Drift of Output Power	4.9	rectangular	$\sqrt{3}$	1	2.8
Phantom and Setup					
Phantom Uncertainty(shape & thickness tolerance)	3.4	rectangular	$\sqrt{3}$	1	2.0
Liquid Conductivity(target)	5.0	rectangular	$\sqrt{3}$	0.7	2.0
Liquid Conductivity(meas.)	1.5	normal	1	0.7	1.1
Liquid Permittivity(target)	5.0	rectangular	$\sqrt{3}$	0.6	1.7
Liquid Permittivity(meas.)	4.2	normal	1	0.6	2.5
Combined Uncertainty		RSS			10.0
Combined Uncertainty (coverage factor=2)		Normal(k=2)			20.1

Report No : TSC-101-11-AP-25-1 (SAR)

SAR-Z Axis
at Hotspot x:37.10 y:0.75

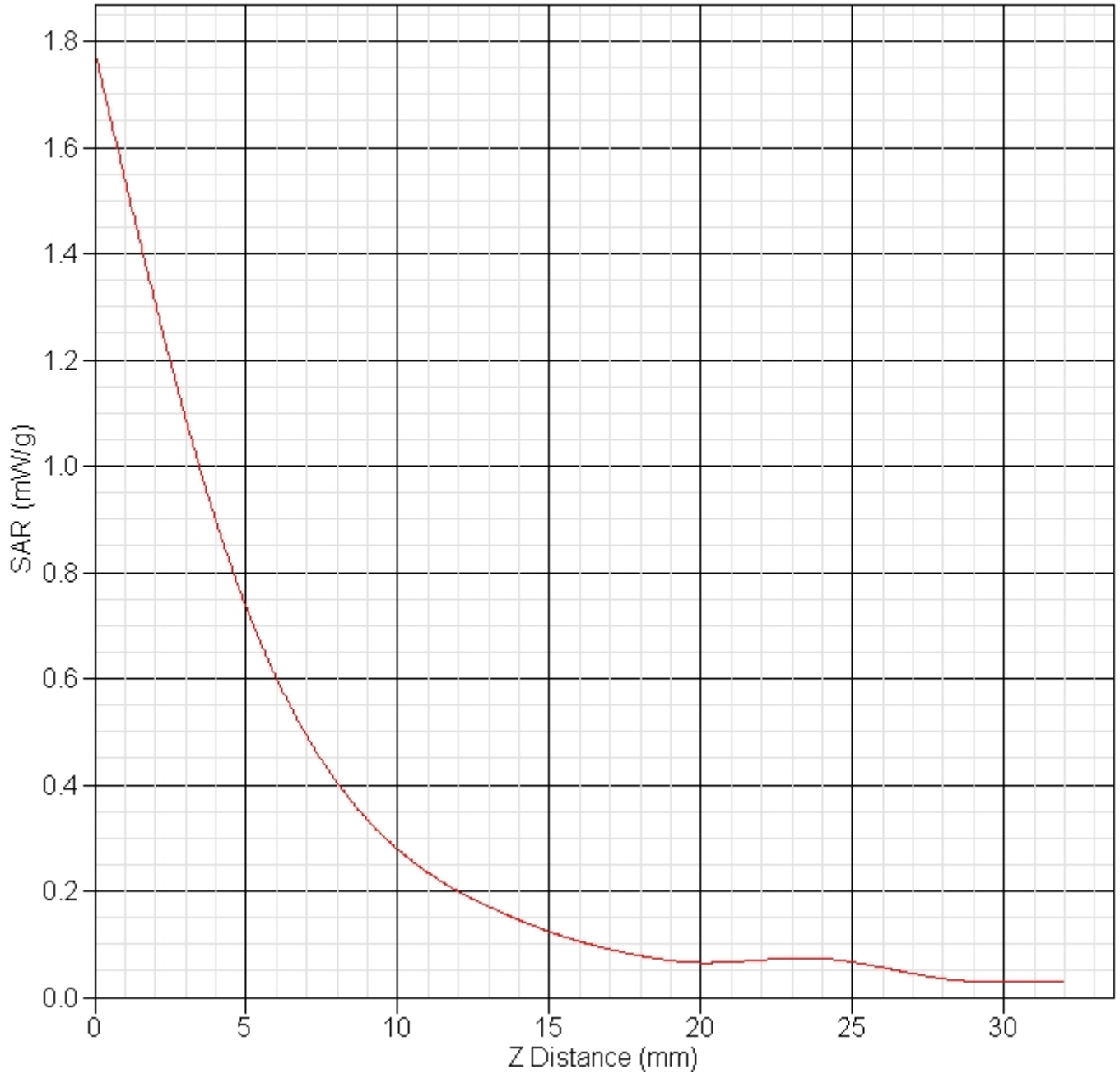

Report No : TSC-101-11-AP-25-1 (SAR)

High Channel Rear Touch

SAR Test Report

Report Date : 29-Nov-2012
By Operator : 123
Measurement Date : 29-Nov-2012
Starting Time : 29-Nov-2012 11:43:36 AM
End Time : 29-Nov-2012 12:02:05 PM
Scanning Time : 1109 secs

Product Data

Device Name : Winmate
Serial No. : 123
Type : PDA
Model : 2450
Frequency : 2450.00 MHz
Max. Transmit Pwr : 0.25 W
Drift Time : 0 min(s)
Length : 154 mm
Width : 80 mm
Depth : 27 mm
Antenna Type : Internal
Orientation : Rotated Left 90°
Power Drift-Start : 0.460 W/kg
Power Drift-Finish: 0.488 W/kg
Power Drift (%) : 4.094
Picture :

Phantom Data

Name : APREL-Uni
Type : Uni-Phantom
Size (mm) : 280 x 280 x 200
Serial No. : User Define
Location : Center
Description : Uni_Phantom

Tissue Data

Type : BODY
Serial No. : 2450
Frequency : 2450.00 MHz
Last Calib. Date : 29-Nov-2012
Temperature : 22.00 °C
Ambient Temp. : 22.00 °C
Humidity : 55.00 RH%
Epsilon : 54.90 F/m
Sigma : 1.98 S/m
Density : 1000.00 kg/cu. m

Report No : TSC-101-11-AP-25-1 (SAR)

Probe Data

Name : Probe 257 - CHTL
Model : E020
Type : E-Field Triangle
Serial No. : 257
Last Calib. Date : 14-Nov-2012
Frequency : 2450.00 MHz
Duty Cycle Factor: 1
Conversion Factor: 4.5
Probe Sensitivity: 1.20 1.20 1.20 $\mu\text{V}/(\text{V}/\text{m})^2$
Compression Point: 95.00 mV
Offset : 1.56 mm

Measurement Data

Crest Factor : 1
Scan Type : Complete
Tissue Temp. : 22.00 °C
Ambient Temp. : 22.00 °C
Set-up Date : 29-Nov-2012
Set-up Time : 10:48:26 AM
Area Scan : 6x5x1 : Measurement x=15mm, y=15mm, z=4mm
Zoom Scan : 5x5x8 : Measurement x=8mm, y=8mm, z=4mm

Other Data

DUT Position : Rotated Left 90°
Separation : 0
Channel : High

Report No : TSC-101-11-AP-25-1 (SAR)

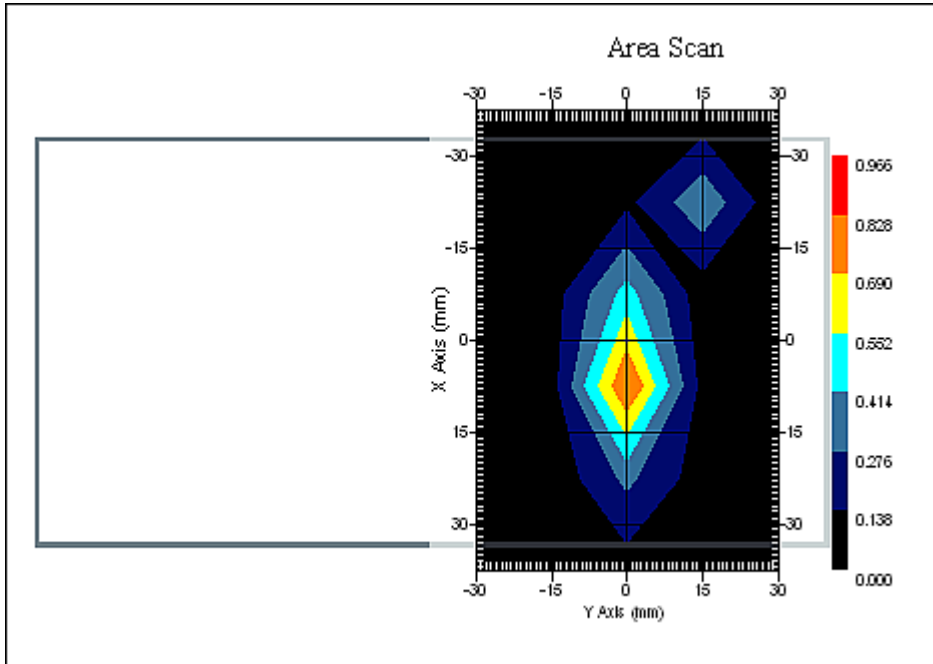

1 gram SAR value : 0.633 W/kg
Area Scan Peak SAR : 0.831 W/kg
Zoom Scan Peak SAR : 1.621 W/kg

Report No : TSC-101-11-AP-25-1 (SAR)

Exposure Assessment Measurement Uncertainty

Source of Uncertainty	Tolerance Value	Probability Distribution	Divisor	c_i^{-1} (1-g)	Standard Uncertainty (1-g) %
Measurement System					
Probe Calibration	3.5	normal	1	1	3.5
Axial Isotropy	3.7	rectangular	$\sqrt{3}$	$(1-cp)^{1/2}$	1.5
Hemispherical Isotropy	10.9	rectangular	$\sqrt{3}$	\sqrt{cp}	4.4
Boundary Effect	1.0	rectangular	$\sqrt{3}$	1	0.6
Linearity	4.7	rectangular	$\sqrt{3}$	1	2.7
Detection Limit	1.0	rectangular	$\sqrt{3}$	1	0.6
Readout Electronics	1.0	normal	1	1	1.0
Response Time	0.8	rectangular	$\sqrt{3}$	1	0.5
Integration Time	1.7	rectangular	$\sqrt{3}$	1	1.0
RF Ambient Condition	3.0	rectangular	$\sqrt{3}$	1	1.7
Probe Positioner Mech.	0.4	rectangular	$\sqrt{3}$	1	0.2
Restriction					
Probe Positioning with respect to Phantom Shell	2.9	rectangular	$\sqrt{3}$	1	1.7
Extrapolation and Integration	3.7	rectangular	$\sqrt{3}$	1	2.1
Test Sample Positioning	4.0	normal	1	1	4.0
Device Holder Uncertainty	2.0	normal	1	1	2.0
Drift of Output Power	4.1	rectangular	$\sqrt{3}$	1	2.4
Phantom and Setup					
Phantom Uncertainty(shape & thickness tolerance)	3.4	rectangular	$\sqrt{3}$	1	2.0
Liquid Conductivity(target)	5.0	rectangular	$\sqrt{3}$	0.7	2.0
Liquid Conductivity(meas.)	1.5	normal	1	0.7	1.1
Liquid Permittivity(target)	5.0	rectangular	$\sqrt{3}$	0.6	1.7
Liquid Permittivity(meas.)	4.2	normal	1	0.6	2.5
Combined Uncertainty		RSS			10.0
Combined Uncertainty (coverage factor=2)		Normal(k=2)			20.1

Report No : TSC-101-11-AP-25-1 (SAR)

SAR-Z Axis
at Hotspot x:7.11 y:-0.24

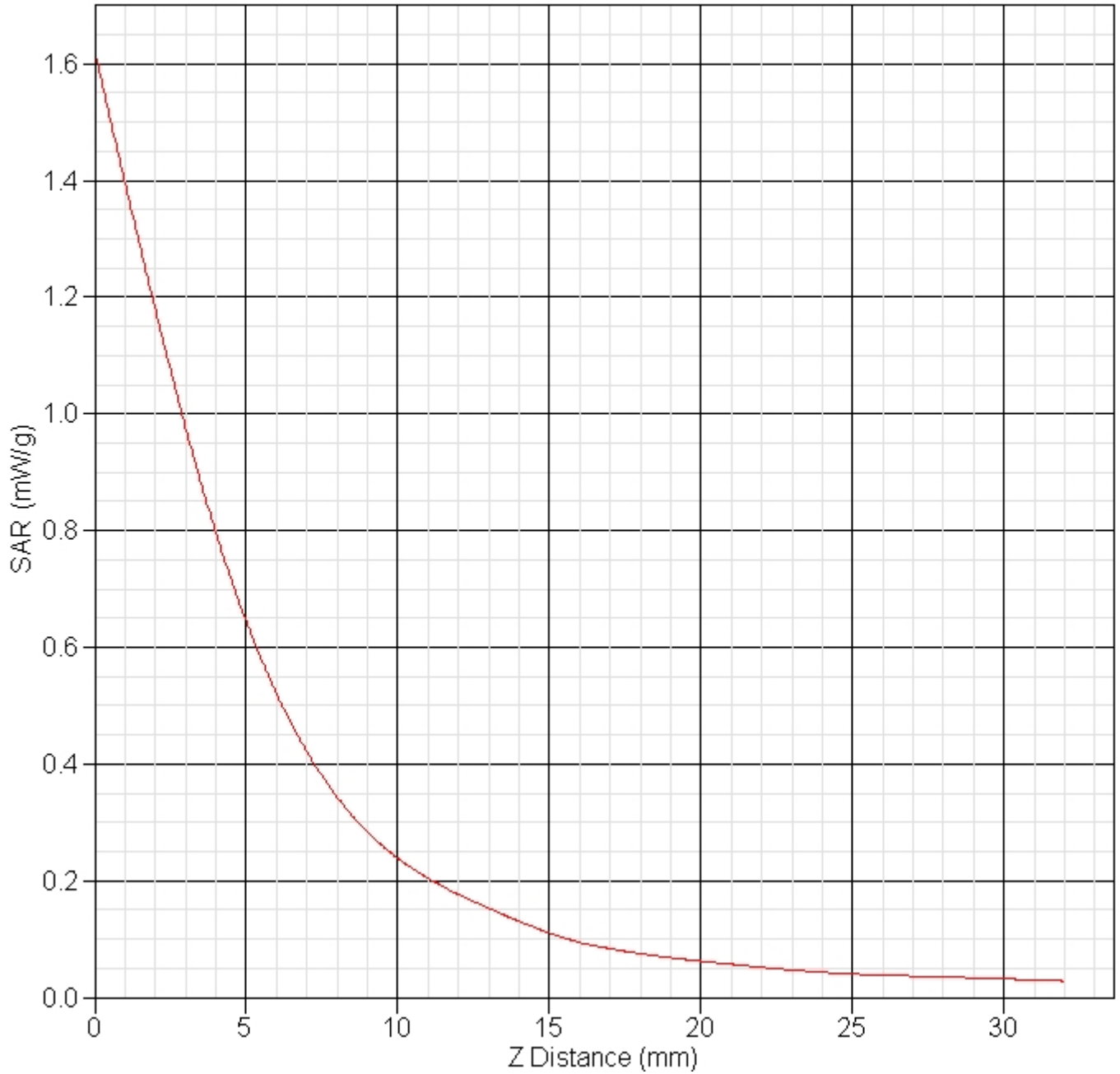

Report No : TSC-101-11-AP-25-1 (SAR)

A.4.2 Dipole Calibration Data

NCL CALIBRATION LABORATORIES

Calibration File No: DC-1471
Project Number: CHT-dipole-2450B-cal-5703

CERTIFICATE OF CALIBRATION

It is certified that the equipment identified below has been calibrated in the
NCL CALIBRATION LABORATORIES by qualified personnel following recognized
procedures and using transfer standards traceable to NRC/NIST.

CHTL Validation Dipole

Manufacturer: APREL Laboratories
Part number: ALS-D-2450-S-2
Frequency: 2450 MHz
Serial No: 2450-220-00751

Customer: CHTL

Calibrated: 14th November 2012
Released on: 14th November 2012

This Calibration Certificate is Incomplete Unless Accompanied with the Calibration Results Summary

Released By: _____



Art Brennan, Quality Manager

NCL CALIBRATION LABORATORIES

303 Terry Fox Drive, Suite 102
Kanata, Ontario
CANADA K2K 3J1

Division of APREL
TEL: (613) 435-8300
FAX: (613) 435-8306

Report No : TSC-101-11-AP-25-1 (SAR)

NCL Calibration Laboratories

Division of APREL Laboratories.

Conditions

Dipole 2450, 220-00751 was a re-calibration.

Ambient Temperature of the Laboratory: 22 °C +/- 0.5°C
Temperature of the Tissue: 21 °C +/- 0.5°C

We the undersigned attest that to the best of our knowledge the calibration of this subject has been accurately conducted and that all information contained within the results pages have been reviewed for accuracy.



Art Brennan, Quality Manager

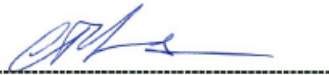

Constantin Teodorian, Test Engineer

This page has been reviewed for content and attested to by signature within this document.

Report No : TSC-101-11-AP-25-1 (SAR)

NCL Calibration Laboratories
 Division of APREL Laboratories.

Calibration Results Summary

The following results relate the Calibrated Dipole and should be used as a quick reference for the user.

Mechanical Dimensions (APREL)

Length: 51.5 mm
 Height: 30.4 mm

Electrical Specification

Test	Result
S11 R/L	-27.845 dB
SWR	1.085 U
Impedance	47.510 Ω

System Validation Results

Frequency	1 Gram	10 Gram	Peak
2450 MHz	50.754	23.857	101.89

Feed power 30dbm.

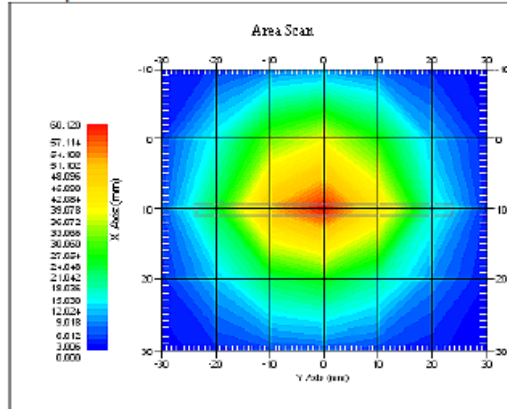

This page has been reviewed for content and attested to by signature within this document.

Report No : TSC-101-11-AP-25-1 (SAR)

NCL Calibration Laboratories

Division of APREL Laboratories.

Introduction

This Calibration Report has been produced in line with the SSI Dipole Calibration Procedure SSI-TP-018-ALSAS. The results contained within this report are for Validation Dipole 2450-220-00751. The calibration routine consisted of a three-step process. Step 1 was a mechanical verification of the dipole to ensure that it meets the mechanical specifications. Step 2 was an Electrical Calibration for the Validation Dipole, where the SWR, Impedance, and the Return loss were assessed. Step 3 involved a System Validation using the ALSAS-10U, along with APREL E-020 130 MHz to 26 GHz E-Field Probe Serial Number 212.

References

SSI-TP-018-ALSAS Dipole Calibration Procedure
SSI-TP-016 Tissue Calibration Procedure
IEEE 1528 "Recommended Practice for Determining the Peak Spatial-Average Specific Absorption Rate (SAR) in the Human Body Due to Wireless Communications Devices: Experimental Techniques"

Conditions

Dipole 2450-220-00751 was a re-calibration.

Ambient Temperature of the Laboratory: 22 °C +/- 0.5°C
Temperature of the Tissue: 20 °C +/- 0.5°C

Dipole Calibration uncertainty

The calibration uncertainty for the dipole is made up of various parameters presented below.

Mechanical	1%
Positioning Error	1.22%
Electrical	1.7%
Tissue	2.2%
Dipole Validation	2.2%
TOTAL	8.32% (16.64% K=2)

This page has been reviewed for content and attested to by signature within this document.

Report No : TSC-101-11-AP-25-1 (SAR)

NCL Calibration Laboratories
Division of APREL Laboratories.

Dipole Calibration Results

Mechanical Verification

APREL Length	APREL Height	Measured Length	Measured Height
51.5 mm	30.4 mm	52.4 mm	30.6 mm

Tissue Validation

Body Tissue 2450 MHz	Measured
Dielectric constant, ϵ_r	51.23
Conductivity, σ [S/m]	1.92

This page has been reviewed for content and attested to by signature within this document.

Report No : TSC-101-11-AP-25-1 (SAR)

NCL Calibration Laboratories
 Division of APREL Laboratories.

Electrical Calibration

Test	Result
S11 R/L	-27.845 dB
SWR	1.085 U
Impedance	47.510 Ω

The Following Graphs are the results as displayed on the Vector Network Analyzer.

S11 Parameter Return Loss

S11 FORWARD REFLECTION

LOG MAGNITUDE REF -20.000 dB 4.000 dB/DIV

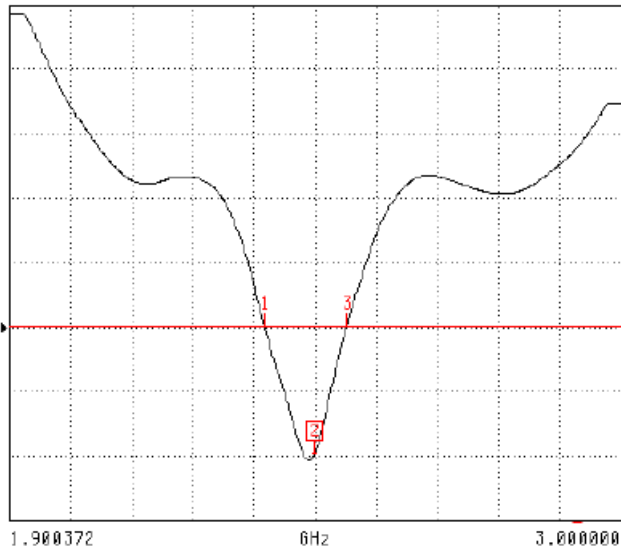

CH 1 - S11
 5.0584 mm REF
 0.000 dB OFFSET
 0.00° OFFSET

▶ MARKER 2
 2.450000 GHz
 -27.845 dB

MARKER TO MAX
 MARKER TO MIN

- 1 2.359346 GHz
-20.011 dB
- 3 2.506004 GHz
-20.013 dB

MARKER READOUT
 FUNCTIONS

This page has been reviewed for content and attested to by signature within this document.

Report No : TSC-101-11-AP-25-1 (SAR)

NCL Calibration Laboratories
 Division of APREL Laboratories.

SWR

S11 FORWARD REFLECTION

SWR ▶REF-1.000 U 1.000 U/DIV

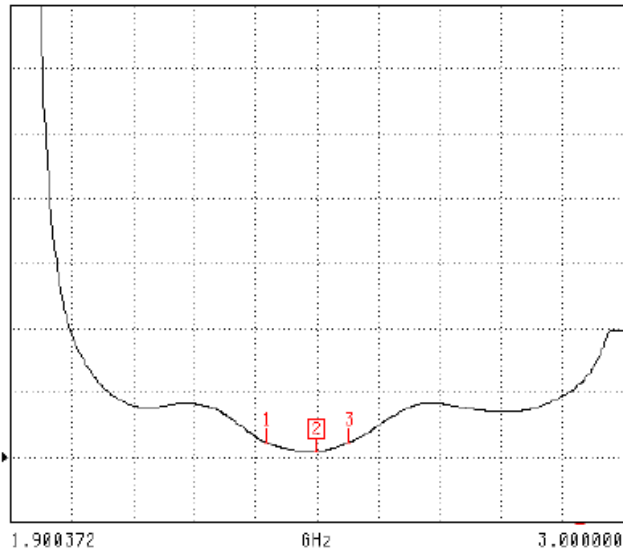

CH 1 - S11
 5.0584 nm REF
 0.000 dB OFFSET
 0.00° OFFSET

▶ MARKER 2
 2.450000 GHz
 1.085 U

MARKER TO MAX
 MARKER TO MIN

1 2.359346 GHz
 1.226 U

3 2.506004 GHz
 1.225 U

MARKER READOUT
 FUNCTIONS

This page has been reviewed for content and attested to by signature within this document.

Report No : TSC-101-11-AP-25-1 (SAR)

NCL Calibration Laboratories
 Division of APREL Laboratories.

Smith Chart Dipole Impedance

S11 FORWARD REFLECTION
 IMPEDANCE

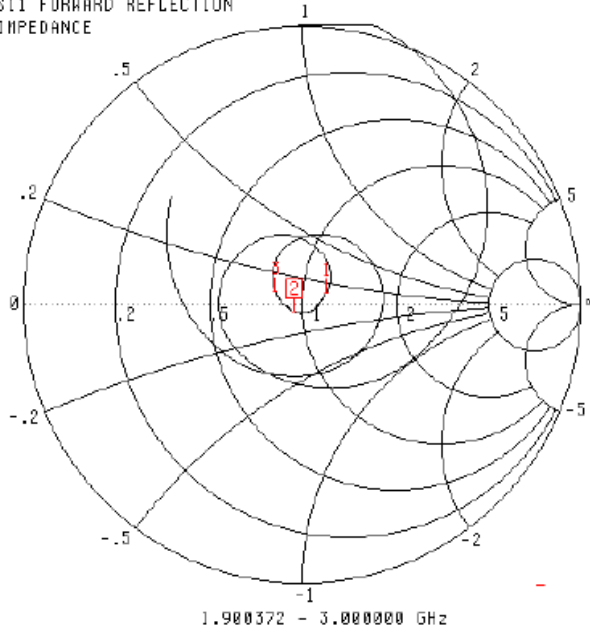

CH 1 - S11
 5.0584 mm REF
 0.000 dB OFFSET
 0.00° OFFSET

▶ MARKER 2
 2.450000 GHz
 47.510 Ω
 -2.852 jΩ

MARKER TO MAX
 MARKER TO MIN

1 2.359346 GHz
 59.778 Ω
 4.707 jΩ
3 2.506004 GHz
 41.587 Ω
 3.699 jΩ

MARKER READOUT
 FUNCTIONS

Test Equipment

The test equipment used during Probe Calibration, manufacturer, model number and, current calibration status are listed and located on the main APREL server R:\NCL\Calibration Equipment\Instrument List May 2012.

Report No : TSC-101-11-AP-25-1 (SAR)

A.4.3 Probe Calibration Data

NCL CALIBRATION LABORATORIES

Calibration File No.: PC-1470

Client.: CHTL

CERTIFICATE OF CALIBRATION

It is certified that the equipment identified below has been calibrated in the
NCL CALIBRATION LABORATORIES by qualified personnel following recognized
procedures and using transfer standards traceable to NRC/NIST.

Equipment: Miniature Isotropic RF Probe
Record of Calibration
Manufacturer: APREL Laboratories
Model No.: E-020
Serial No.: 257

Calibration Procedure: D01-032-E020-V2, D22-012-Tissue, D28-002-Dipole
Project No: CHT-E20-cal-5702

Calibrated: 14th November 2012
Released on: 14th November 2012

This Calibration Certificate is Incomplete Unless Accompanied with the Calibration Results Summary

Released By:  _____
Art Brennan, Quality Manager

NCL CALIBRATION LABORATORIES
303 Terry Fox Drive, Suite 102 Division of APREL
Kanata, Ontario TEL: (613) 435-8300
CANADA K2K 3J1 FAX: (613) 435-8306

Report No : TSC-101-11-AP-25-1 (SAR)

NCL Calibration Laboratories

Division of APREL Inc.

Introduction

This Calibration Report reproduces the results of the calibration performed in line with the references listed below. Calibration is performed using accepted methodologies as per the references listed below. Probes are calibrated for air, and tissue and the values reported are the results from the physical quantification of the probe through meteorological practices.

Calibration Method

Probes are calibrated using the following methods.

<1000MHz

TEM Cell for sensitivity in air

Standard phantom using temperature transfer method for sensitivity in tissue

>1000MHz

Waveguide* method to determine sensitivity in air and tissue

*Waveguide is numerically (simulation) assessed to determine the field distribution and power

The boundary effect for the probe is assessed using a standard flat phantom where the probe output is compared against a numerically simulated series of data points

References

- o IEEE Standard 1528 (2003) including Amendment 1
IEEE Recommended Practice for Determining the Peak Spatial-Average Specific Absorption Rate (SAR) in the Human Head from Wireless Communications Devices: Measurement Techniques
- o EN 62209-1 (2006)
Human Exposure to RF Fields from hand-held and body-mounted wireless communication devices - Human models, instrumentation, and procedures-Part 1: Procedure to measure the Specific Absorption Rate (SAR) for hand-held mobile wireless devices
- o IEC 62209-2 Ed. 1.0 (2010-03)
Human exposure to RF fields from hand-held and body-mounted wireless devices - Human models, instrumentation, and procedures - Part 2: specific absorption rate (SAR) for wireless communication devices (30 MHz - 6 GHz)
- o TP-D01-032-E020-V2 E-Field probe calibration procedure
- o D22-012-Tissue dielectric tissue calibration procedure
- o D28-002-Dipole procedure for validation of SAR system using a dipole
- o IEEE 1309 Draft Standard for Calibration of Electromagnetic Field Sensors and Probes, Excluding Antennas, from 9kHz to 40GHz

Report No : TSC-101-11-AP-25-1 (SAR)

NCL Calibration Laboratories

Division of APREL Inc.

Conditions

Probe 257 was a recalibration.

Ambient Temperature of the Laboratory: 22 °C +/- 1.5°C
Temperature of the Tissue: 21 °C +/- 1.5°C
Relative Humidity: < 60%

Primary Measurement Standards

Instrument	Serial Number	Cal due date
Power meter Anritsu MA2408A	90025437	Nov.4, 2013
Power Sensor Anritsu MA2481D	103555	Nov 4, 2013
Attenuator HP 8495A (70dB)	1944A10711	Sept. 14, 2013
Network Analyzer Anritsu MT8801C	MB11855	Feb. 8, 2013

Secondary Measurement Standards

Signal Generator Agilent E4438C -506	MY55182336	June 7, 2013
--------------------------------------	------------	--------------

Attestation

The below named signatories have conducted the calibration and review of the data which is presented in this calibration report.

We the undersigned attest that to the best of our knowledge the calibration of this subject has been accurately conducted and that all information contained within the results pages have been reviewed for accuracy.



Art Brennan, Quality Manager



Dan Brooks, Test Engineer

Report No : TSC-101-11-AP-25-1 (SAR)

NCL Calibration Laboratories

Division of APREL Inc.

Probe Summary

Probe Type:	E-Field Probe E020
Serial Number:	257
Frequency:	As presented on page 5
Sensor Offset:	1.56
Sensor Length:	2.5
Tip Enclosure:	Composite*
Tip Diameter:	< 5 mm
Tip Length:	60 mm
Total Length:	290 mm

*Resistive to recommended tissue recipes per IEEE-1528

Sensitivity in Air

Channel X:	1.2 $\mu\text{V}/(\text{V}/\text{m})^2$
Channel Y:	1.2 $\mu\text{V}/(\text{V}/\text{m})^2$
Channel Z:	1.2 $\mu\text{V}/(\text{V}/\text{m})^2$
Diode Compression Point:	95 mV

Report No : TSC-101-11-AP-25-1 (SAR)

NCL Calibration Laboratories

Division of APREL Inc.

Calibration for Tissue (Head H, Body B)

Frequency	Tissue Type	Measured Epsilon	Measured Sigma	Calibration Uncertainty	Tolerance Uncertainty for 5%*	Conversion Factor
450 H	Head	X	X	X	X	X
450 B	Body	X	X	X	X	X
750 H	Head	X	X	X	X	X
750 B	Body	X	X	X	X	X
835 H	Head	X	X	X	X	X
835 B	Body	X	X	X	X	X
900 H	Head	40.86	0.97	3.5	3.6	6.4
900 B	Body	X	X	X	X	X
1450 H	Head	X	X	X	X	X
1450 B	Body	X	X	X	X	X
1500 H	Head	X	X	X	X	X
1500 B	Body	X	X	X	X	X
1640 H	Head	X	X	X	X	X
1640 B	Body	X	X	X	X	X
1750 H	Head	X	X	X	X	X
1750 B	Body	X	X	X	X	X
1800 H	Head	X	X	X	X	X
1800 B	Body	X	X	X	X	X
1900 H	Head	38.47	1.34	3.5	2.7	5.3
1900 B	Body	X	X	X	X	X
2000 H	Head	X	X	X	X	X
2000 B	Body	X	X	X	X	X
2100 H	Head	X	X	X	X	X
2100 B	Body	X	X	X	X	X
2300 H	Head	X	X	X	X	X
2300 B	Body	X	X	X	X	X
2450 H	Head	X	X	X	X	X
2450B	Body	51.23	1.92	3.5	3.5	4.5
2600 H	Head	X	X	X	X	X
2600 B	Body	X	X	X	X	X
3000 H	Head	X	X	X	X	X
3000 B	Body	X	X	X	X	X
3600 H	Head	X	X	X	X	X
3600 B	Body	X	X	X	X	X
5200 H	Head	X	X	X	X	X
5200 B	Body	X	X	X	X	X
5600 H	Head	X	X	X	X	X
5600 B	Body	X	X	X	X	X
5800 H	Head	X	X	X	X	X
5800 B	Body	X	X	X	X	X

Report No : TSC-101-11-AP-25-1 (SAR)

NCL Calibration Laboratories

Division of APREL Inc.

Boundary Effect:

Uncertainty resulting from the boundary effect is less than 2.1% for the distance between the tip of the probe and the tissue boundary, when less than 0.58mm.

Spatial Resolution:

The spatial resolution uncertainty is less than 1.5% for 4.9mm diameter probe.
The spatial resolution uncertainty is less than 1.0% for 2.5mm diameter probe.

DAQ-PAQ Contribution

To minimize the uncertainty calculation all tissue sensitivity values were calculated using a load impedance of 5 M Ω .

Boundary Effect:

For a distance of 0.58mm the worst case evaluated uncertainty (increase in the probe sensitivity) is less than 2.1%.

NOTES:

*The maximum deviation from the centre frequency when comparing the lower to upper range is listed.

Report No : TSC-101-11-AP-25-1 (SAR)

NCL Calibration Laboratories
Division of APREL Inc.

Receiving Pattern Air

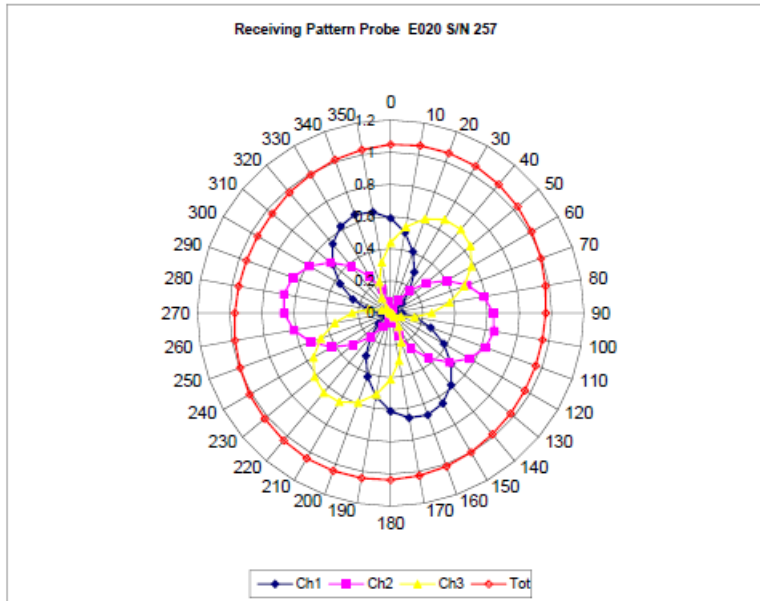

Report No : TSC-101-11-AP-25-1 (SAR)

NCL Calibration Laboratories
Division of APREL Inc.

Isotropy Error Air

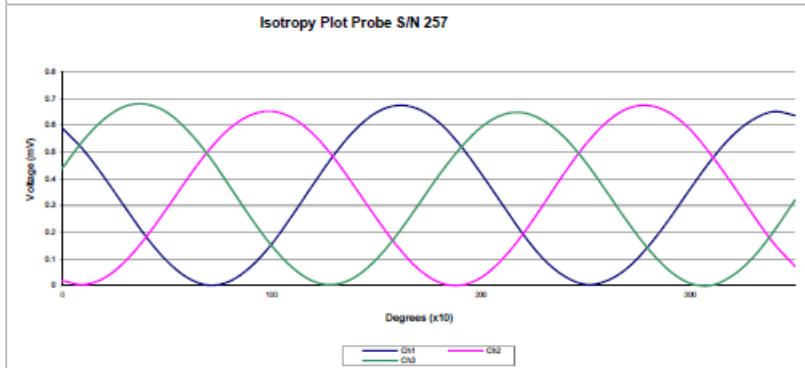
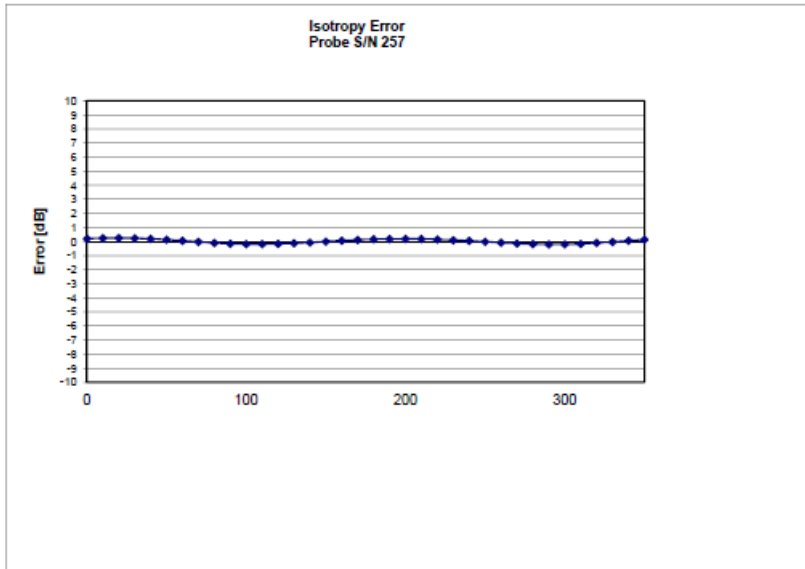

Isotropy Tissue: 0.10 dB

Report No : TSC-101-11-AP-25-1 (SAR)

NCL Calibration Laboratories
Division of APREL Inc.

Dynamic Range

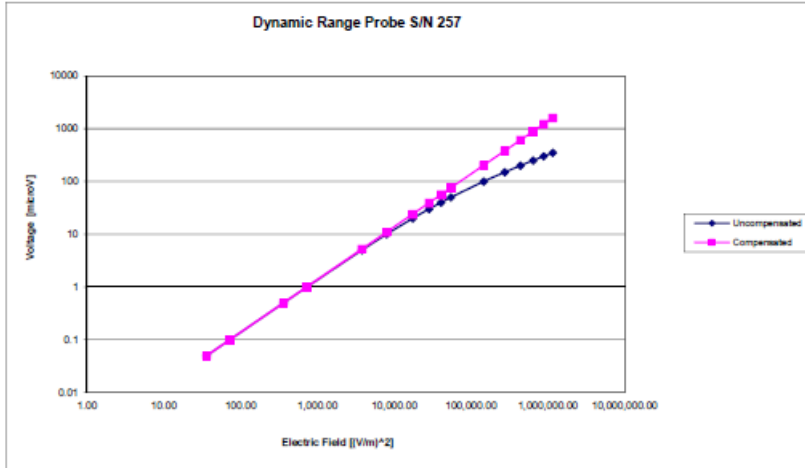

Report No : TSC-101-11-AP-25-1 (SAR)

NCL Calibration Laboratories
Division of APREL Inc.

Video Bandwidth

Probe Frequency Characteristics

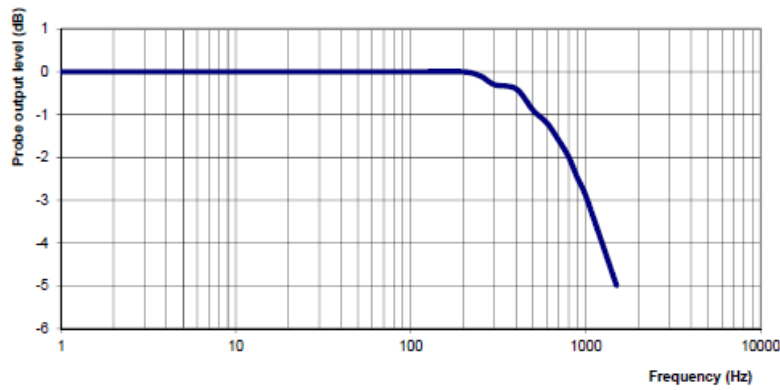

Video Bandwidth at 500 Hz: 1 dB
Video Bandwidth at 1.02 KHz: 3 dB

Test Equipment

The test equipment used during Probe Calibration, manufacturer, model number and, current calibration status are listed and located on the main APREL server R:\NCL\Calibration Equipment\Instrument List May 2012.