

Mid Frequency and With the ALC threshold level

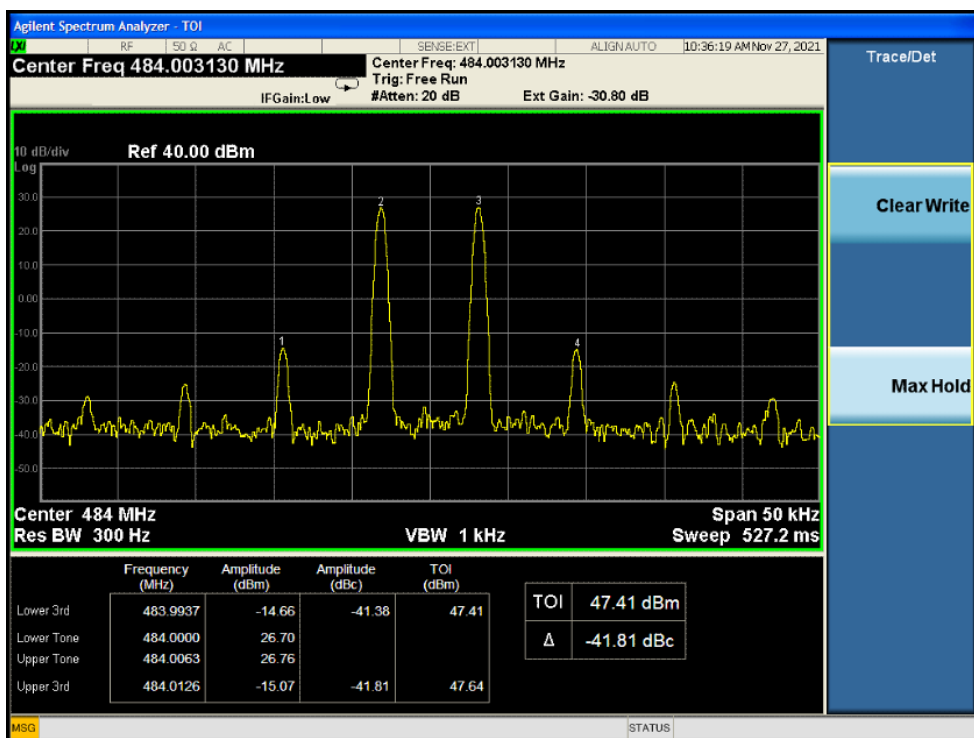

Mid Frequency and With the input signal amplitude set 3 dB above the ALC threshold

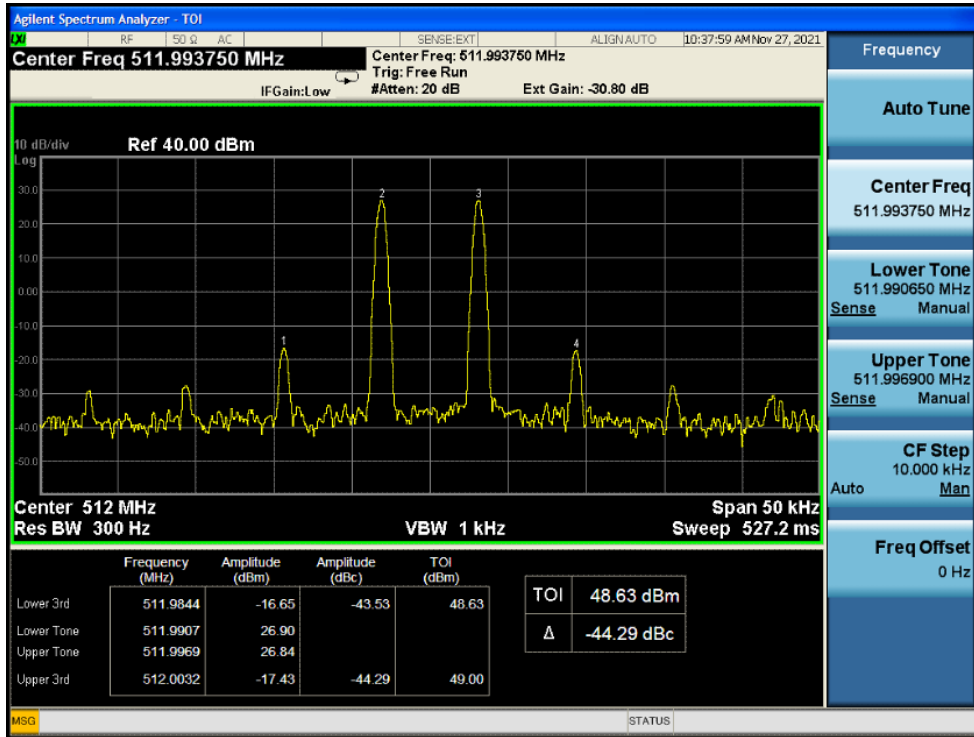

High Frequency and With the ALC threshold level

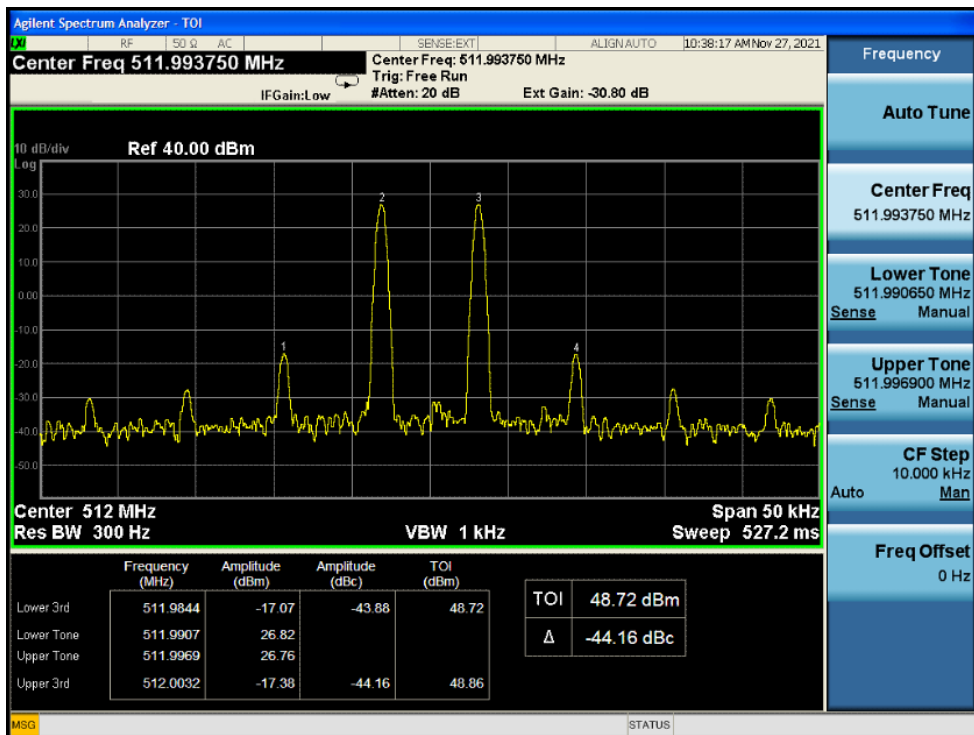

High Frequency and With the input signal amplitude set 3 dB above the ALC threshold

10.8.5.1.2.2. Channel Bandwidth:12.5kHz

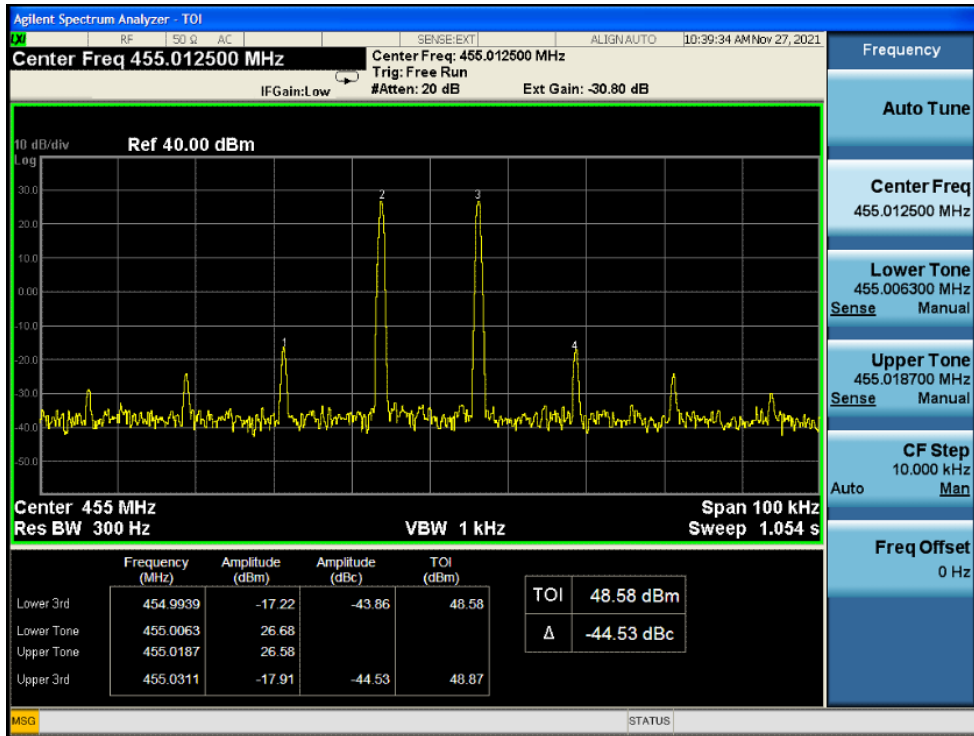

Low Frequency and With the ALC threshold level

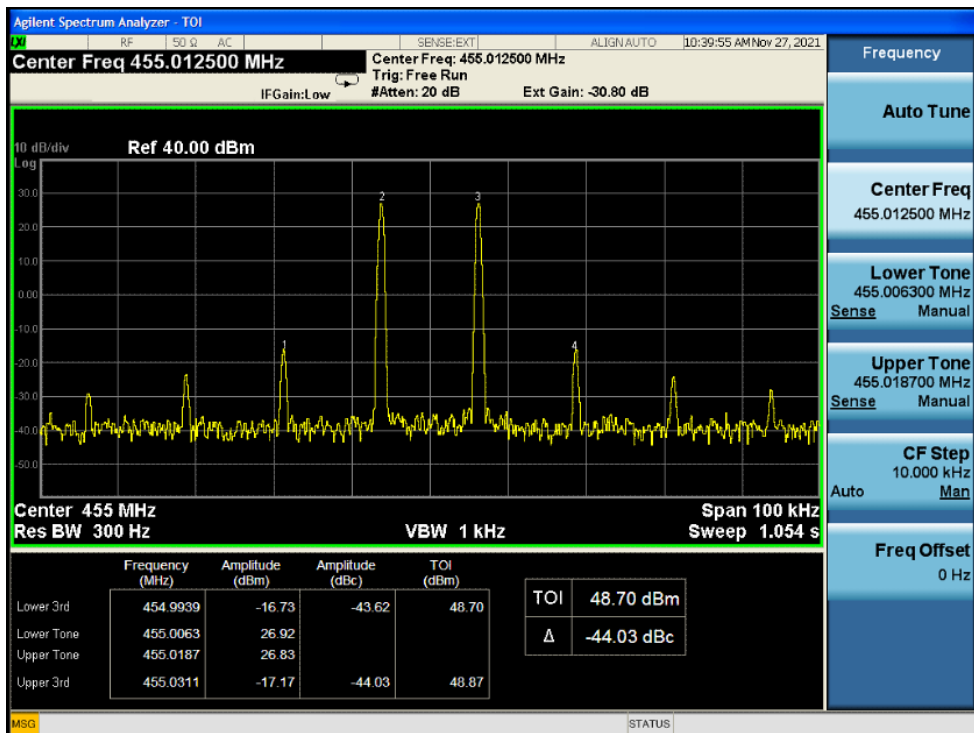

Low Frequency and With the input signal amplitude set 3 dB above the ALC threshold

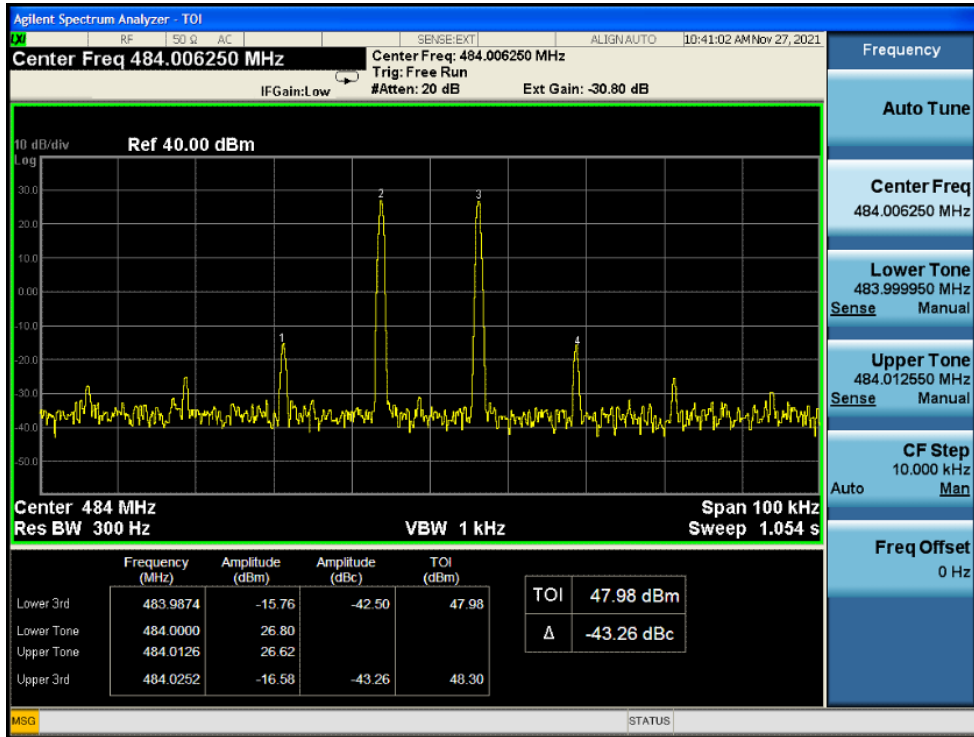

Mid Frequency and With the ALC threshold level

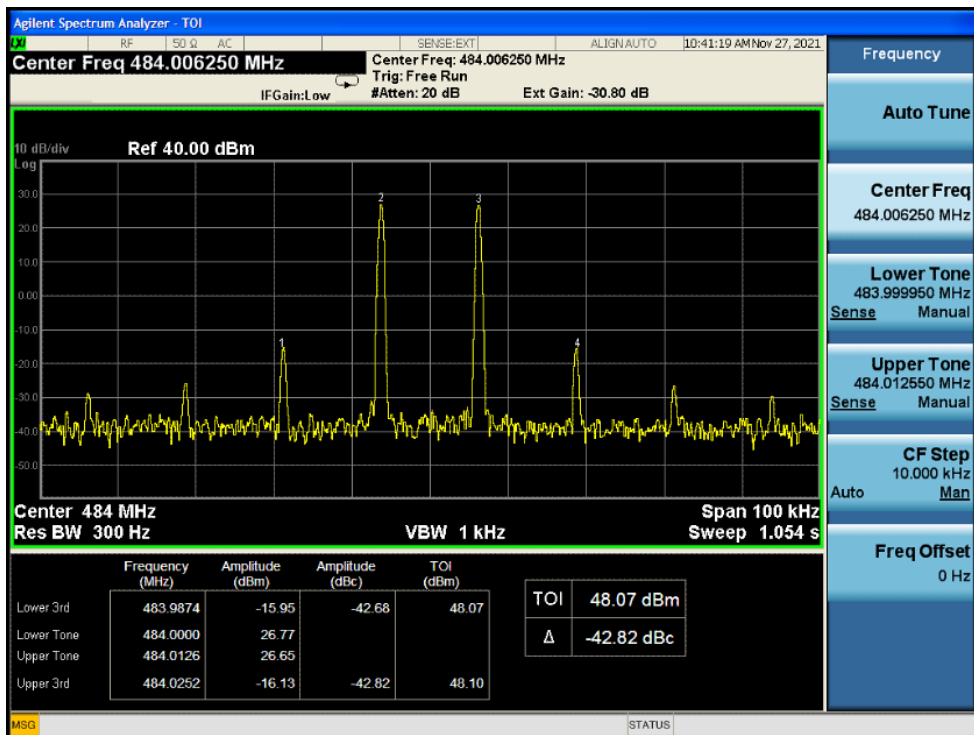

Mid Frequency and With the input signal amplitude set 3 dB above the ALC threshold

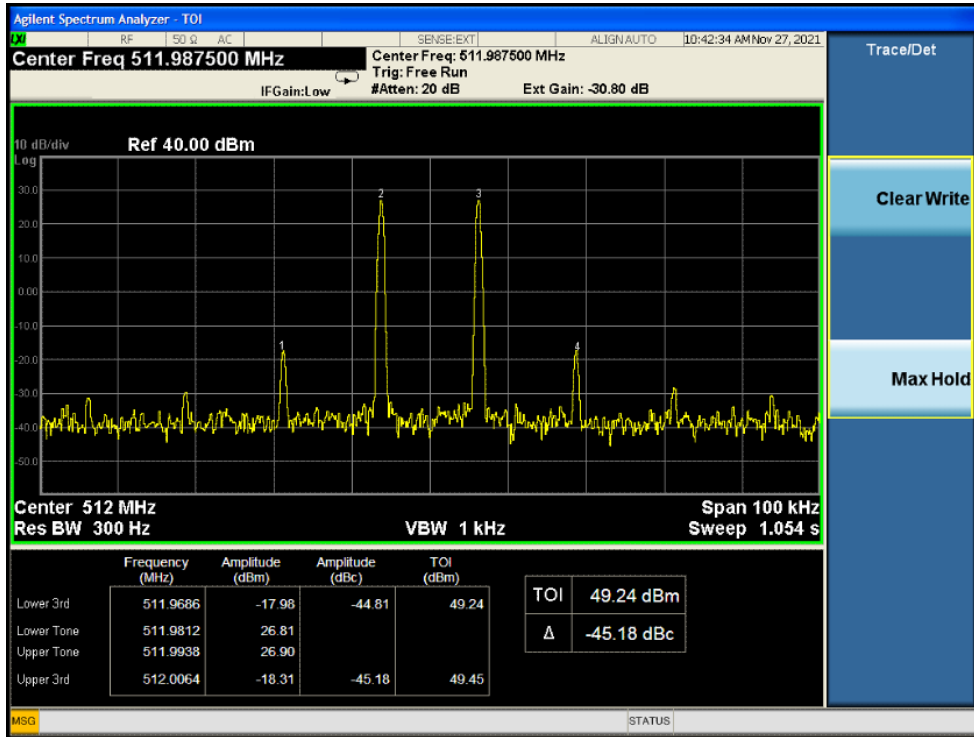

High Frequency and With the ALC threshold level

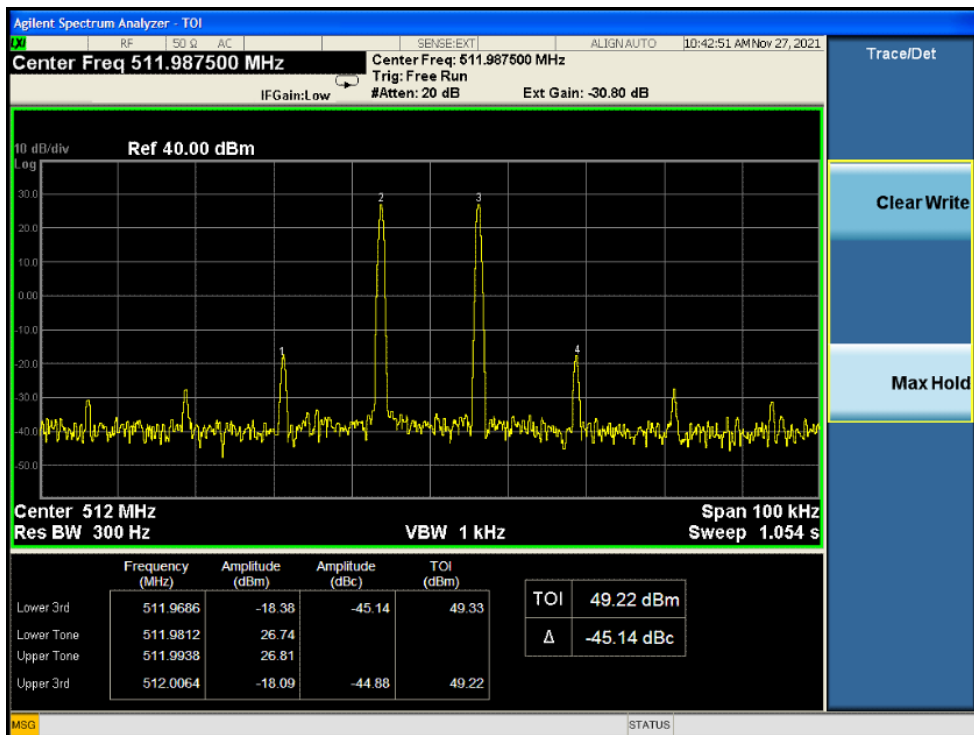

High Frequency and With the input signal amplitude set 3 dB above the ALC threshold

10.8.5.1.2.3. Channel Bandwidth: 25kHz

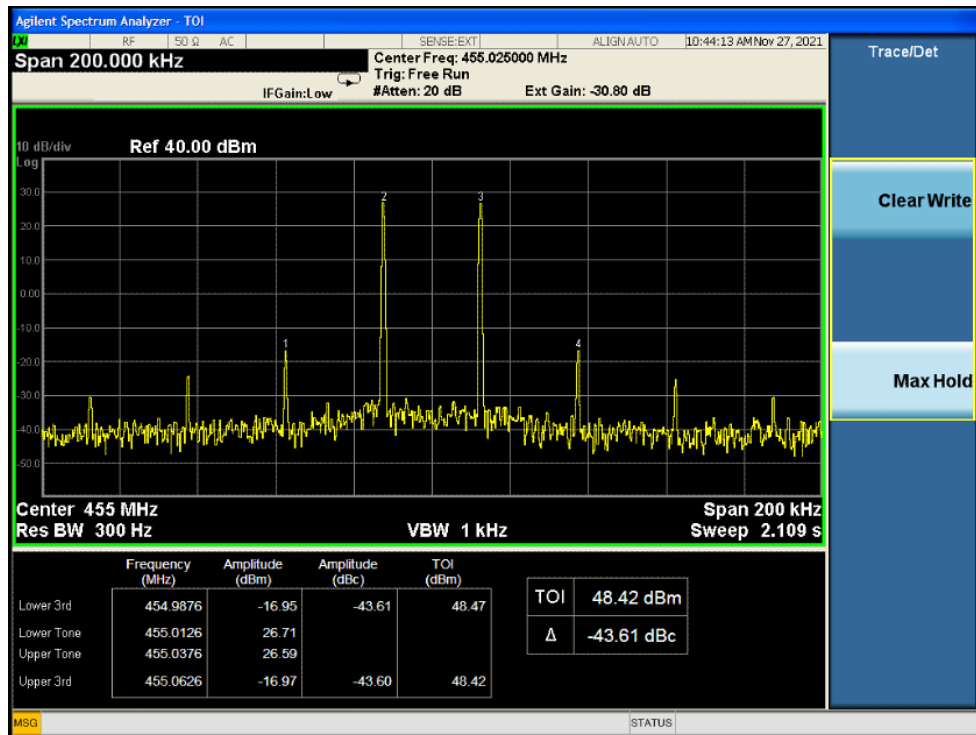

Low Frequency and With the ALC threshold level

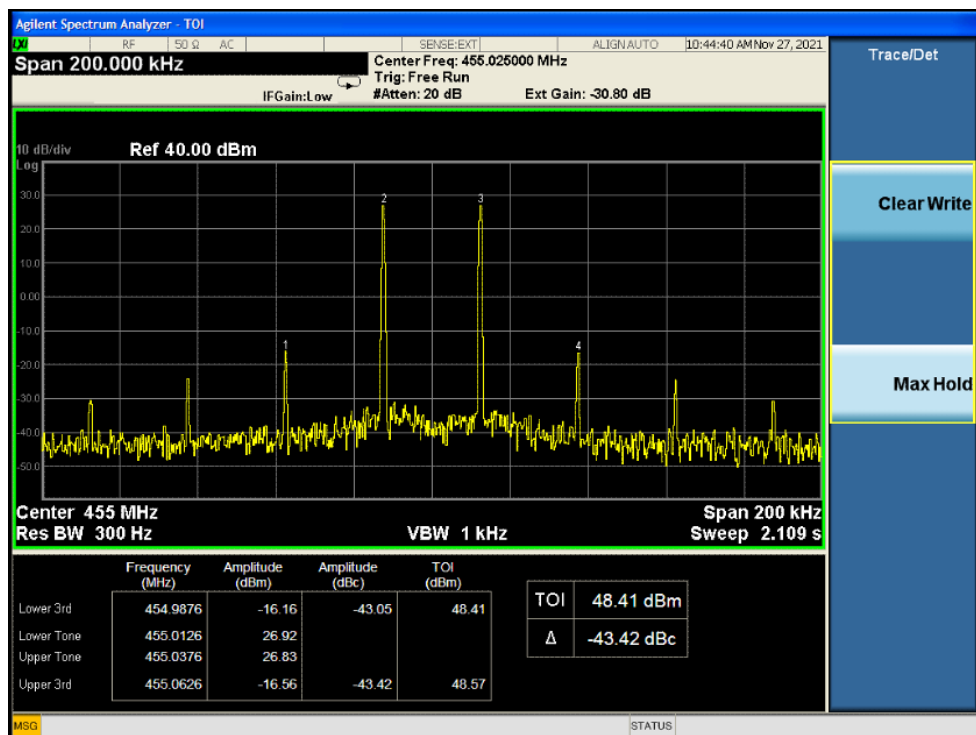

Low Frequency and With the input signal amplitude set 3 dB above the ALC threshold

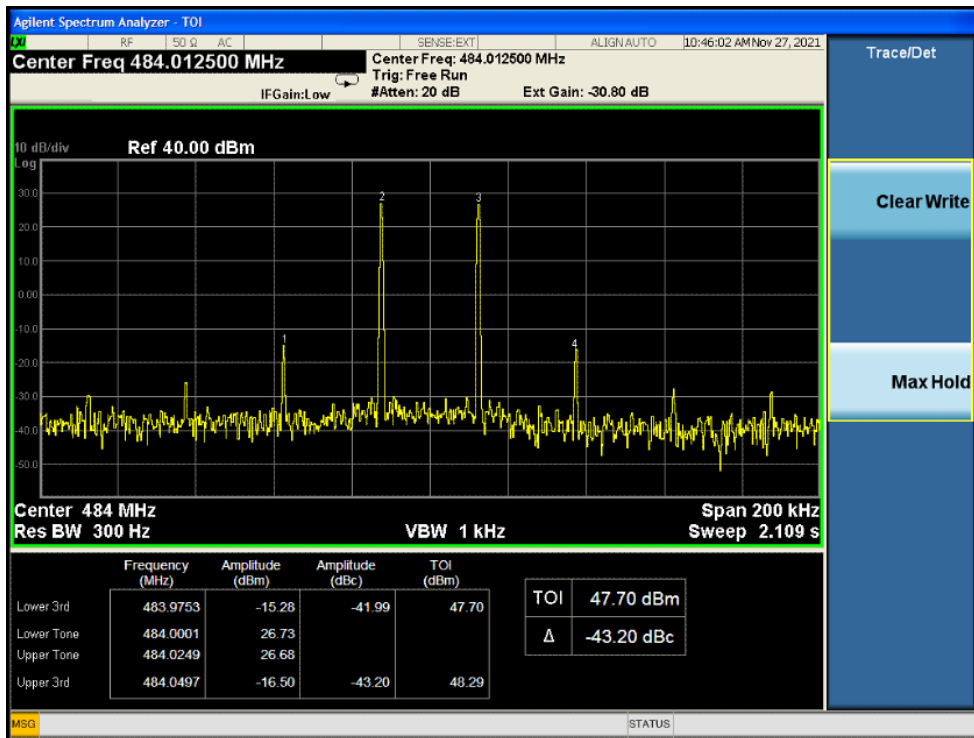

Mid Frequency and With the ALC threshold level

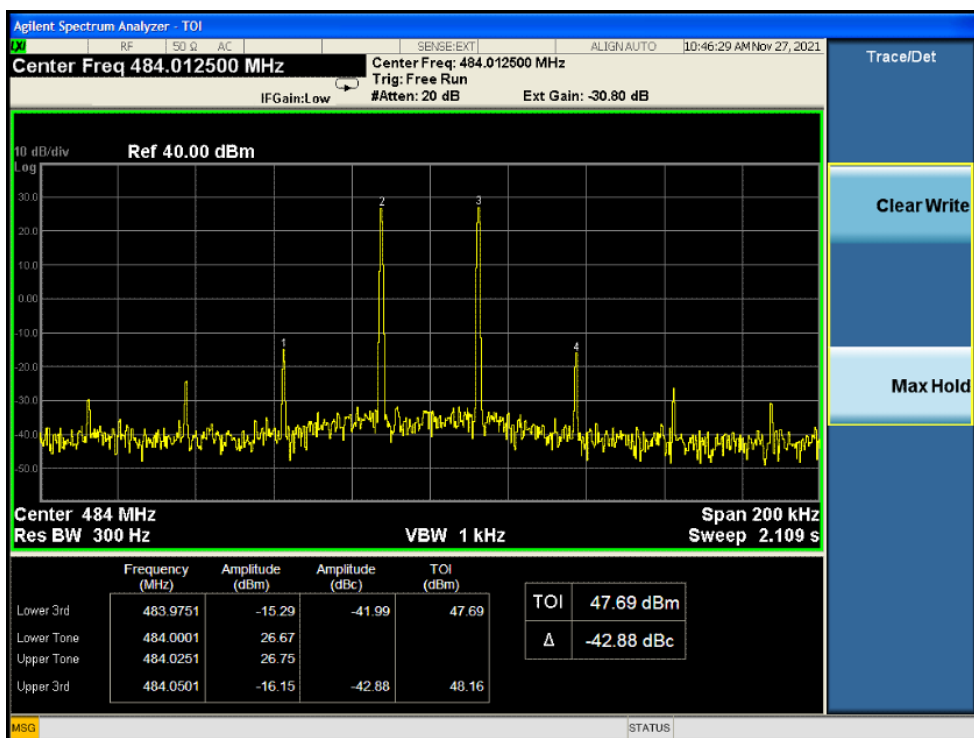

Mid Frequency and With the input signal amplitude set 3 dB above the ALC threshold

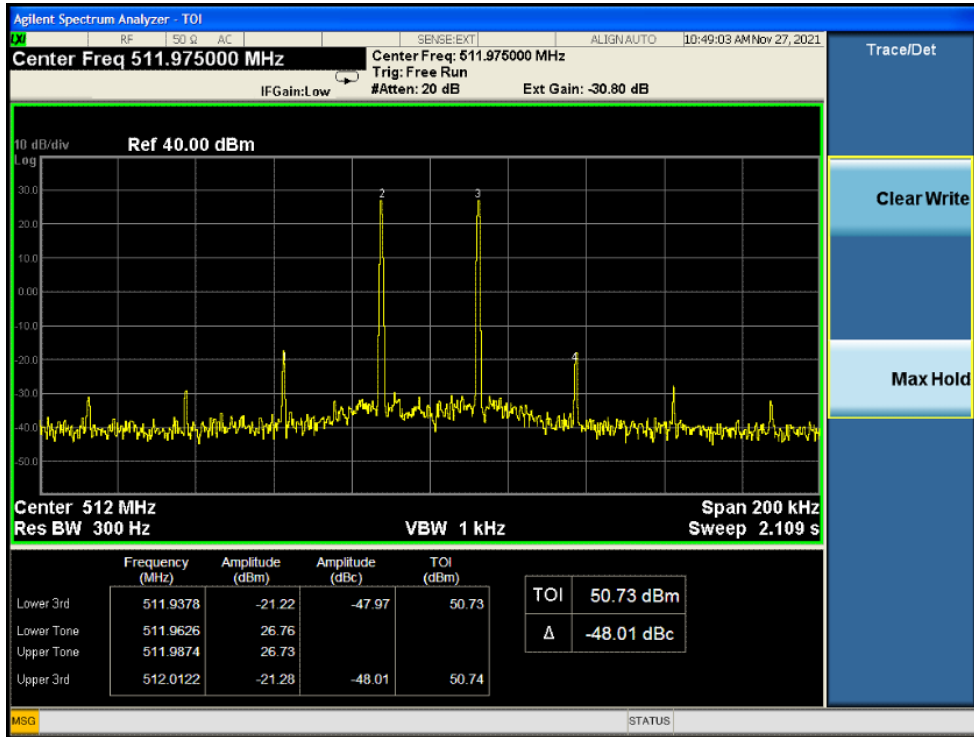

High Frequency and With the ALC threshold level

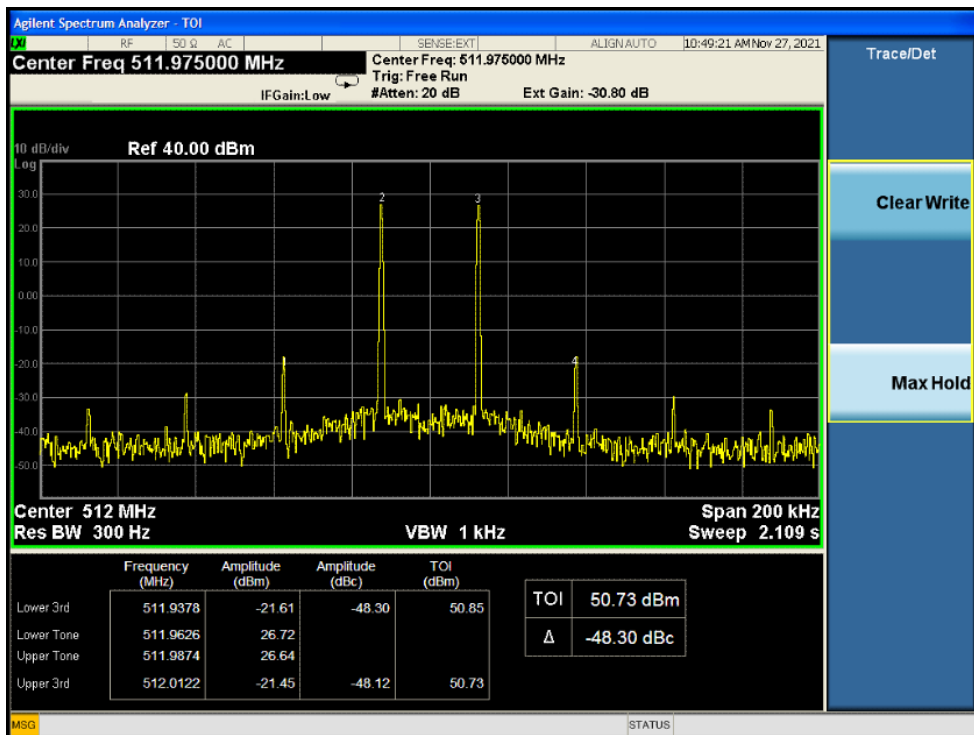

High Frequency and With the input signal amplitude set 3 dB above the ALC threshold

10.8.5.2. System test

10.8.5.2.1. Uplink transmit mode

10.8.5.2.1.1. Channel Bandwidth: 6.25 kHz

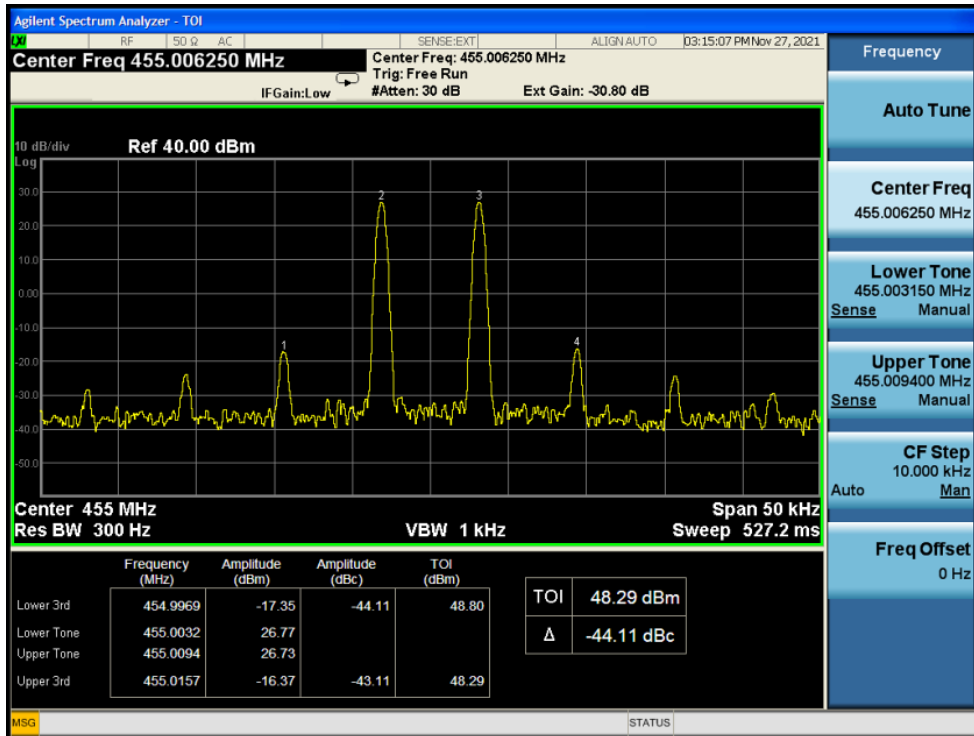

Low Frequency and With the ALC threshold level

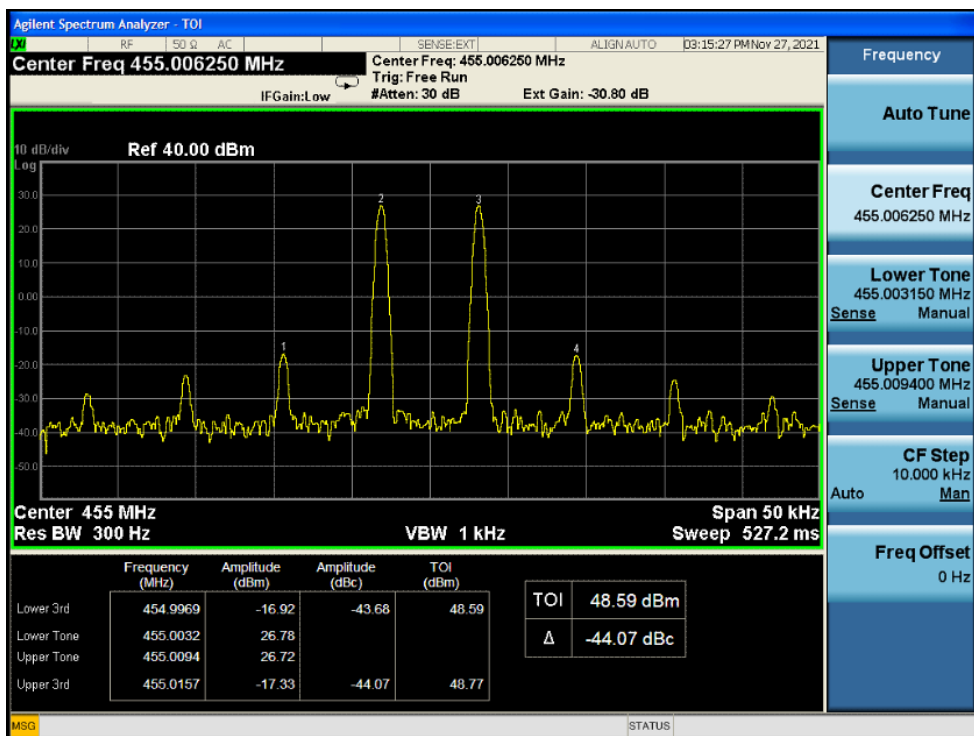

Low Frequency and With the input signal amplitude set 3 dB above the ALC threshold

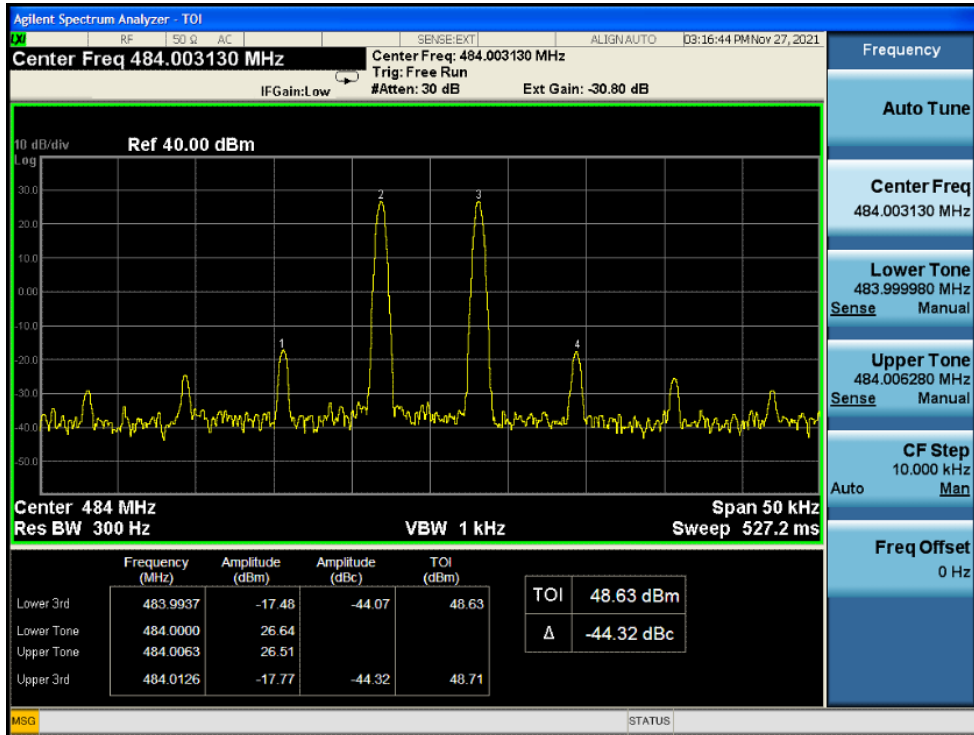

Mid Frequency and With the ALC threshold level

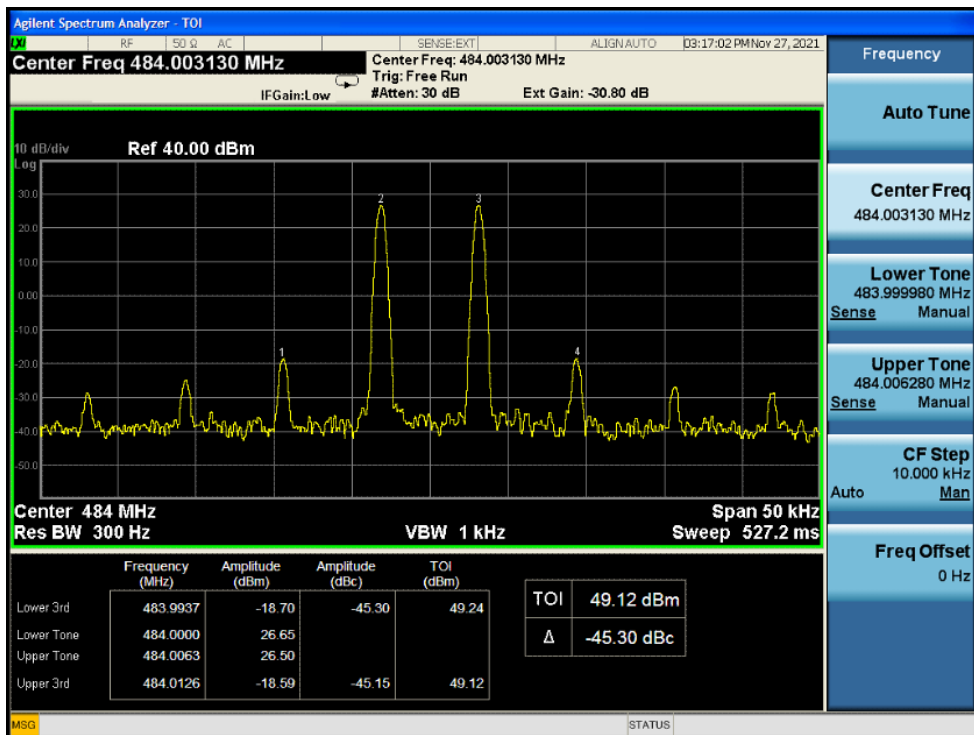

Mid Frequency and With the input signal amplitude set 3 dB above the ALC threshold

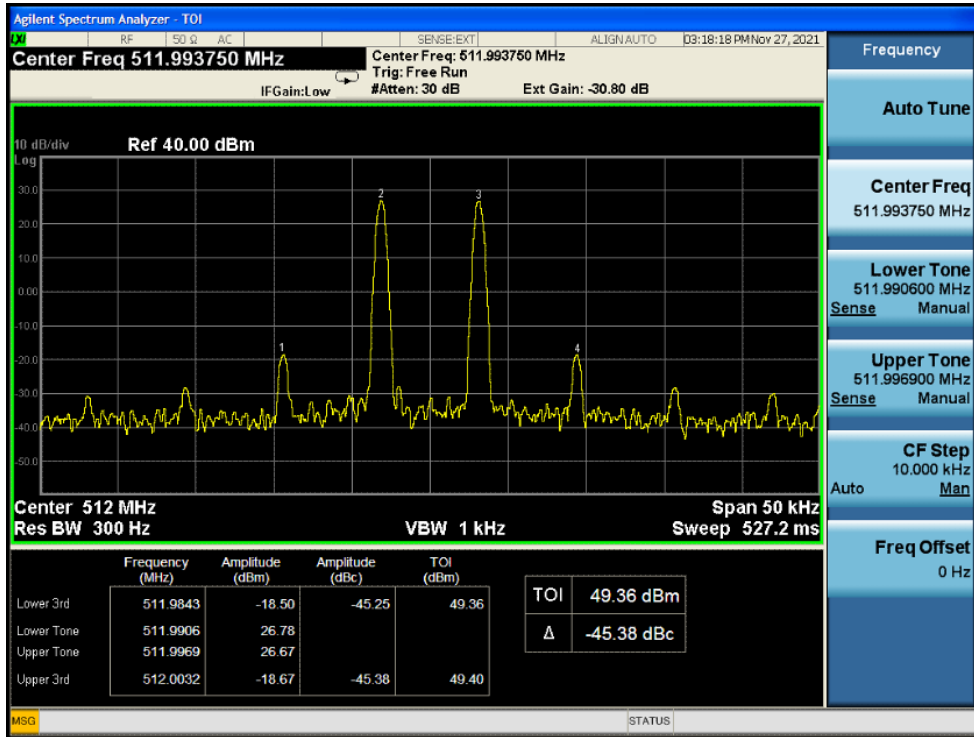

High Frequency and With the ALC threshold level

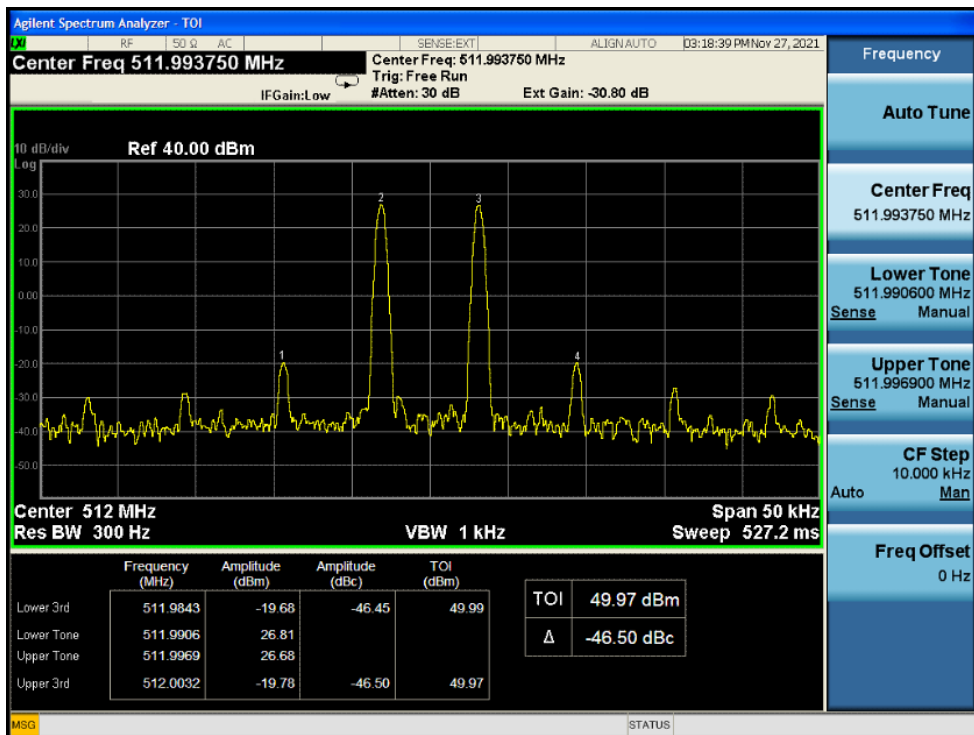

High Frequency and With the input signal amplitude set 3 dB above the ALC threshold

10.8.5.2.1.2. Channel Bandwidth:12.5kHz

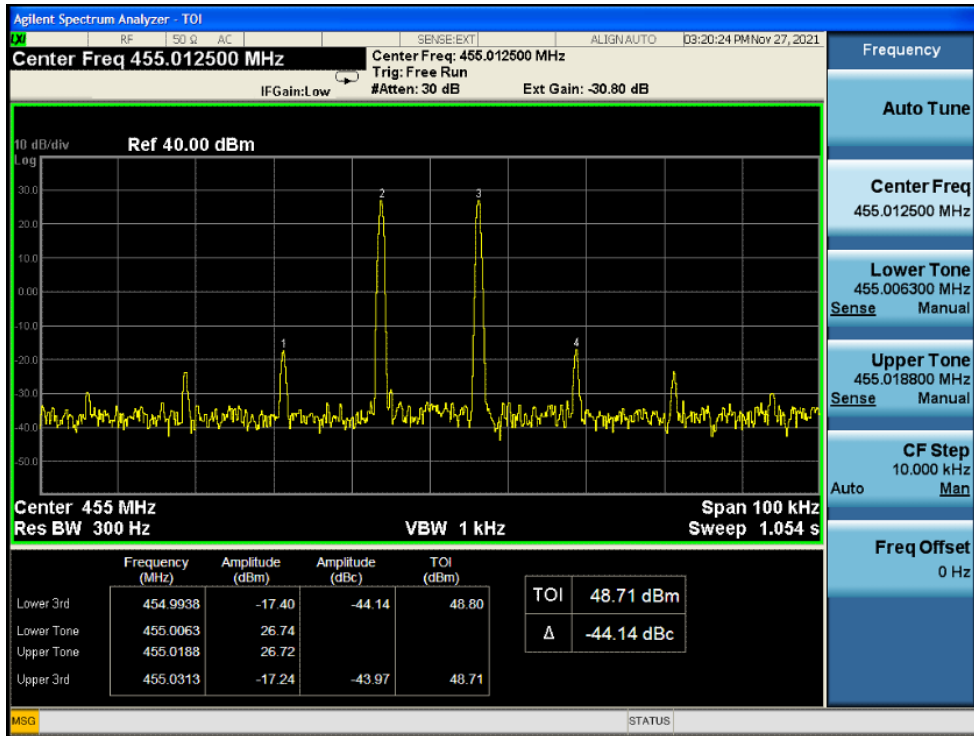

Low Frequency and With the ALC threshold level

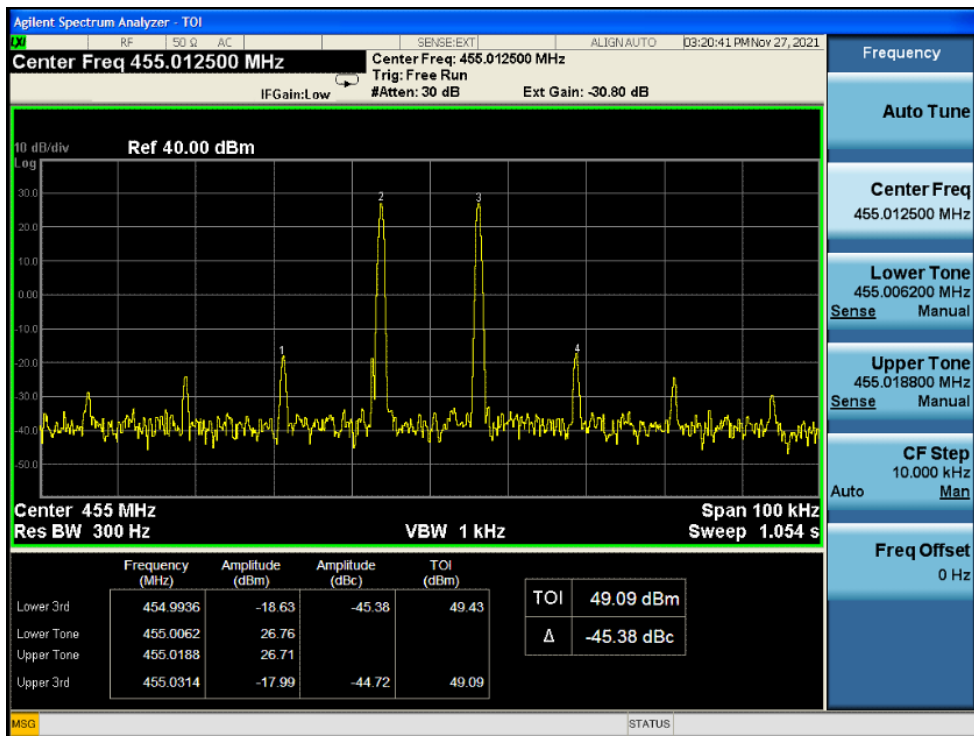

Low Frequency and With the input signal amplitude set 3 dB above the ALC threshold

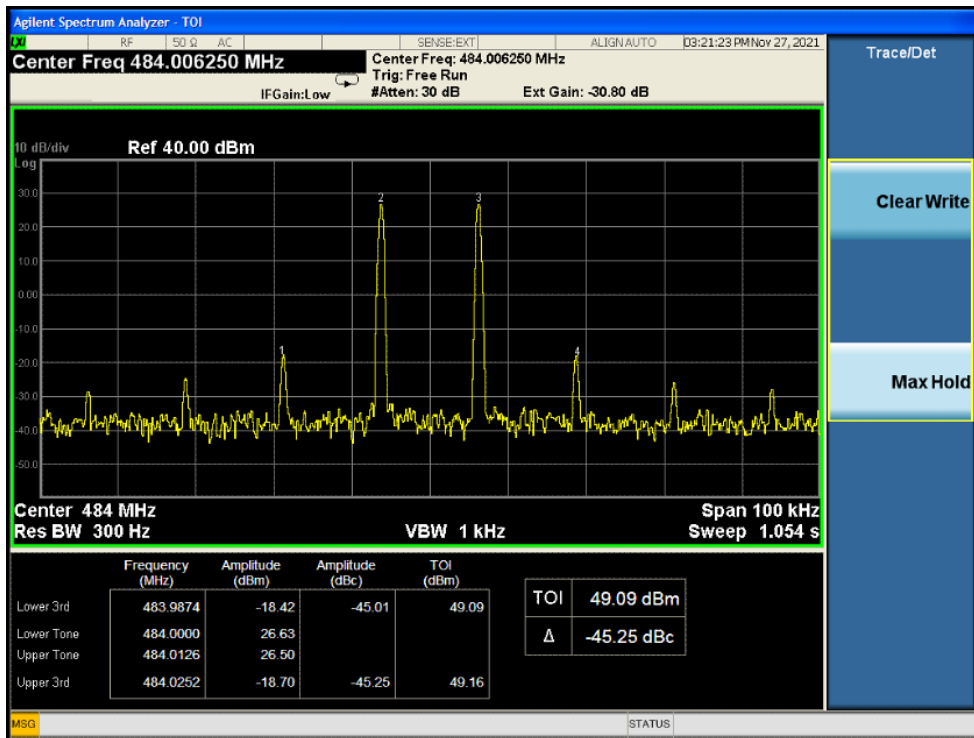

Mid Frequency and With the ALC threshold level

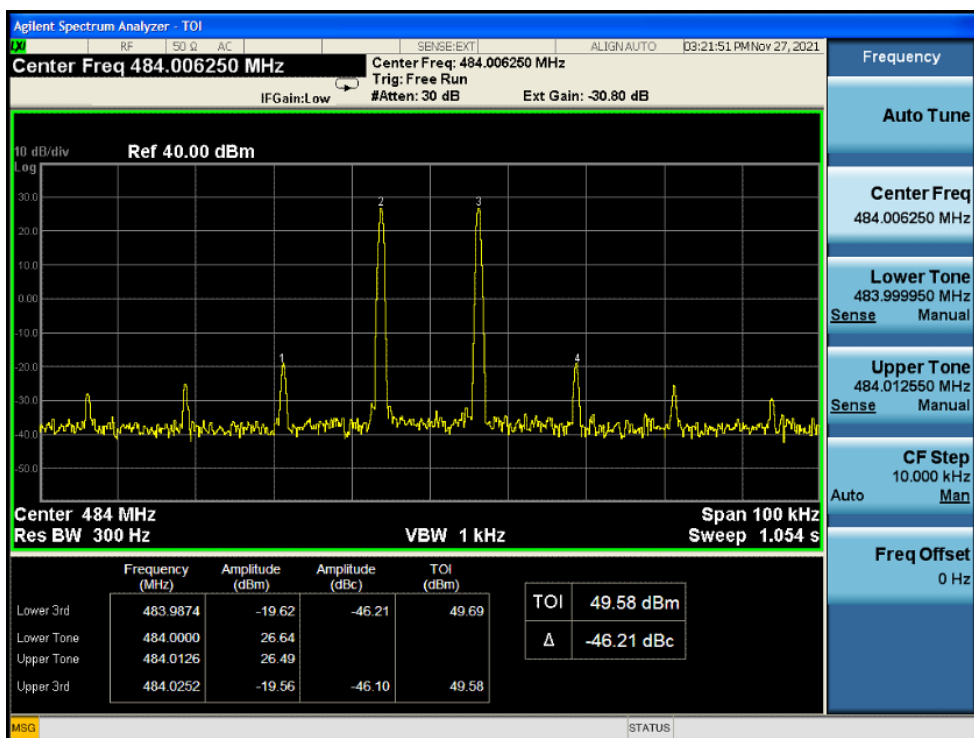

Mid Frequency and With the input signal amplitude set 3 dB above the ALC threshold

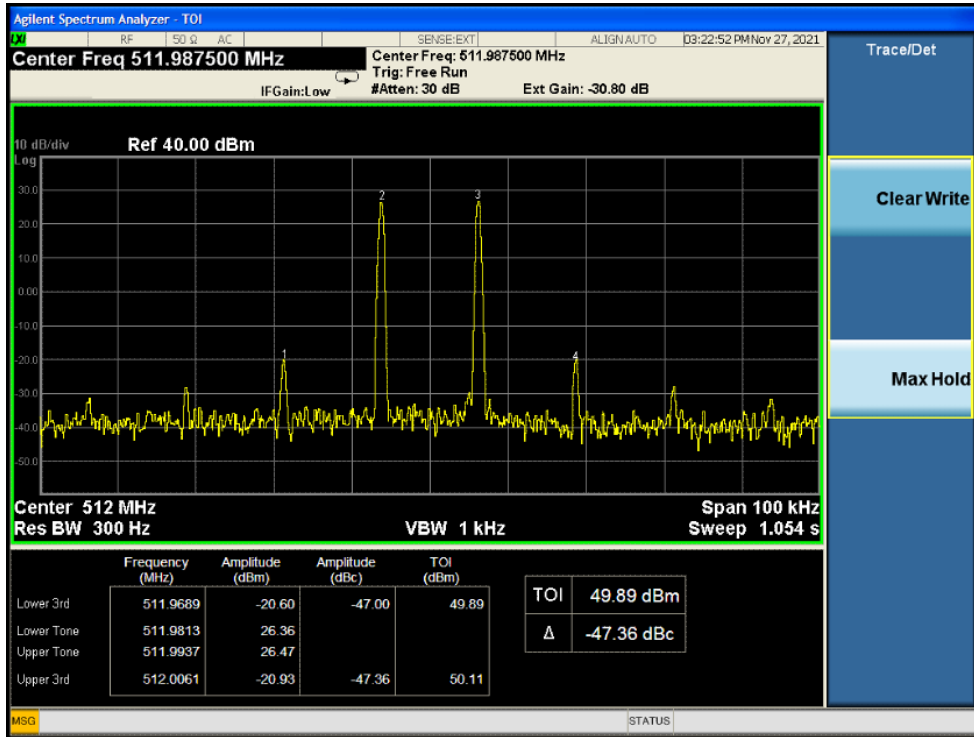

High Frequency and With the ALC threshold level

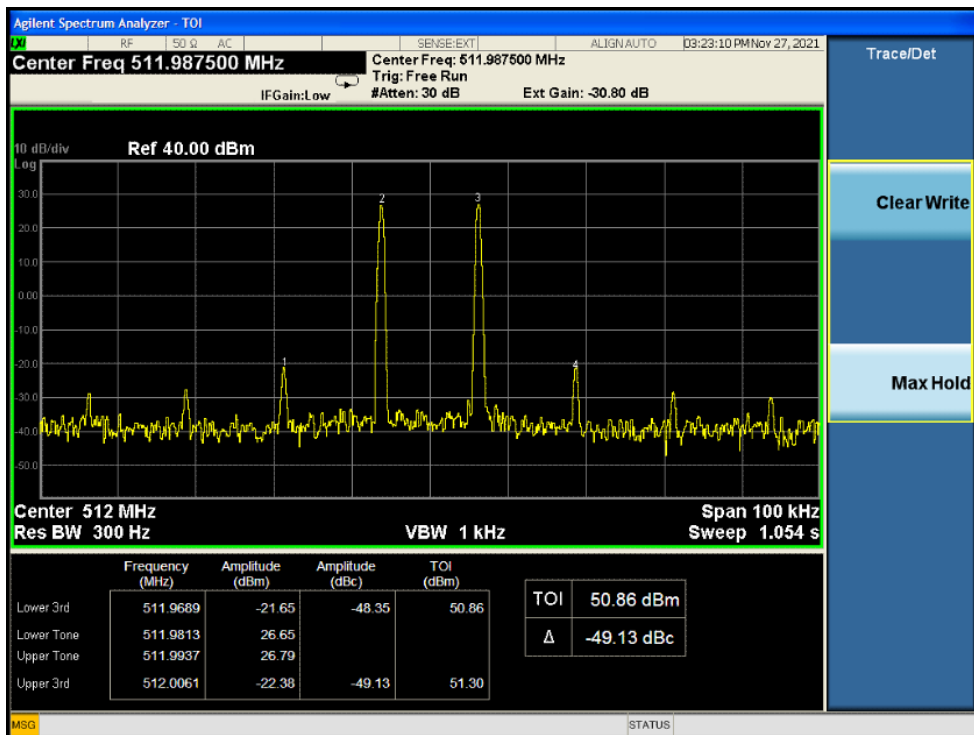

High Frequency and With the input signal amplitude set 3 dB above the ALC threshold

10.8.5.2.1.3. Channel Bandwidth: 25kHz

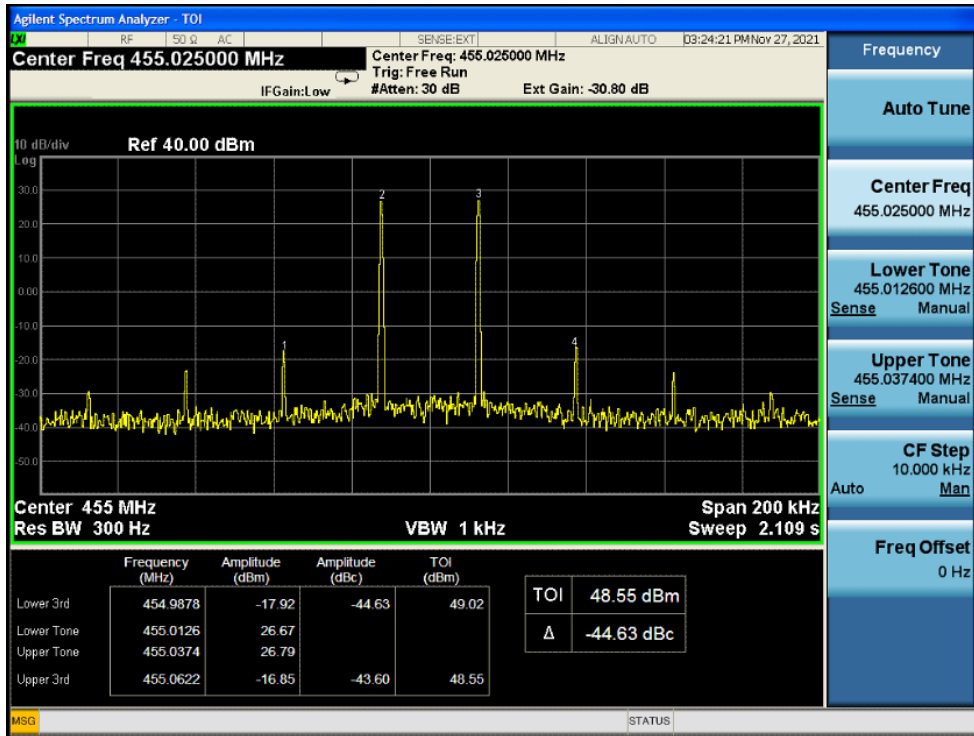

Low Frequency and With the ALC threshold level

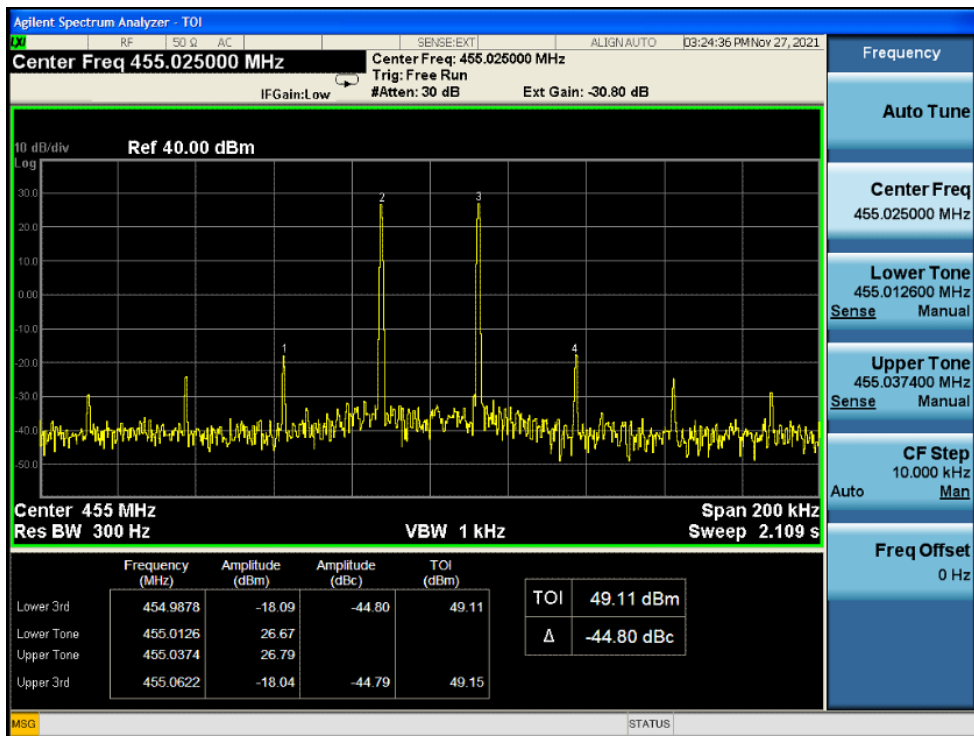

Low Frequency and With the input signal amplitude set 3 dB above the ALC threshold

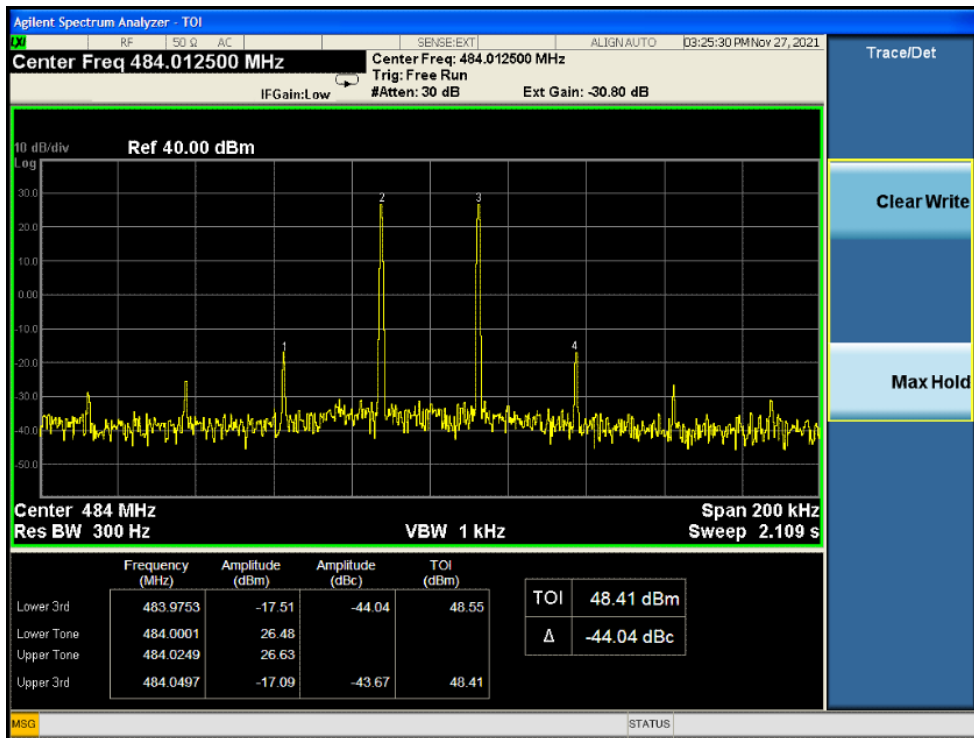

Mid Frequency and With the ALC threshold level

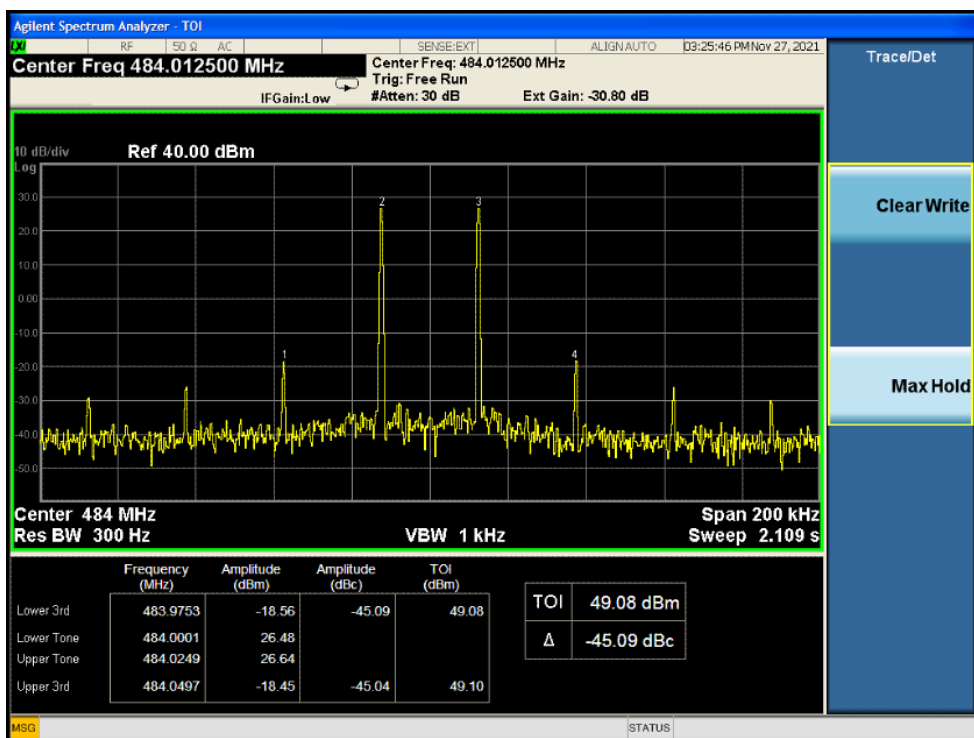

Mid Frequency and With the input signal amplitude set 3 dB above the ALC threshold

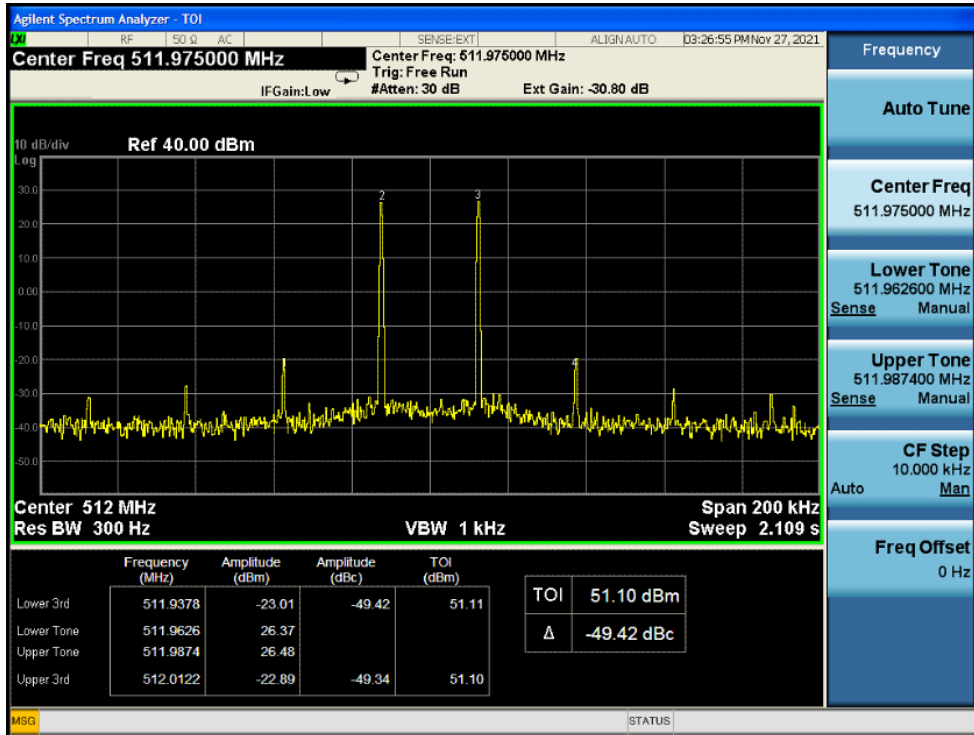

High Frequency and With the ALC threshold level

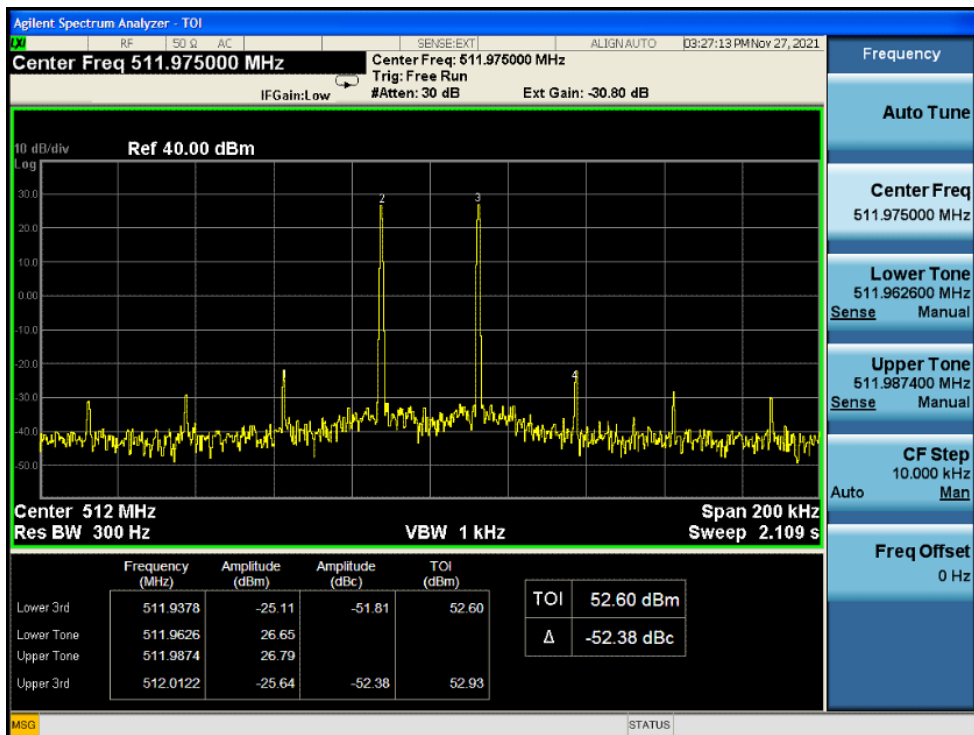

High Frequency and With the input signal amplitude set 3 dB above the ALC threshold

10.9. Conducted spurious emissions

Test requirement: KDB 935210 D05 clause 4.7.3
FCC PART 2.1051
FCC PART 90.219 (e)(3)
Test Method: KDB 935210 D05/4.7.3

10.9.1. Limit

The EUT shall comply with sections 4.7.3 of KDB 935210 D05.

Refer to the applicable rule part(s) for specified limits on unwanted (out-of-band/out-of-block and spurious) emissions (e.g., Section 90.210).

Spurious emissions shall be measured using a single test signal sequentially tuned to the low, middle, and high channels or frequencies within each authorized frequency band of operation.

Intermodulation products shall be measured using two CW signals with all available channel spacings (e.g., 12.5 kHz and 6.25 kHz) with the center between these channels being equal to the center frequency f_0 as determined from 4.3.

NOTE—Intermodulation-product spurious emission measurements are not required for single-channel boosters that cannot accommodate two simultaneous signals within the passband.

For a multi-channel enhancer, any intermodulation product level must be attenuated, relative to P, by at least: $43 + 10 \cdot \log_{10} P$ is less stringent than 70dB, that limit was used.

Spurious emissions shall be measured using a single test signal sequentially tuned to the low, middle, and high channels or frequencies within each authorized frequency band of operation.

Out-of-band/out-of-block emissions (including intermodulation products) shall be measured under each of the following two stimulus conditions:

- a) two adjacent test signals sequentially tuned to the lower and upper frequency band/block edges;
- b) a single test signal, sequentially tuned to the lowest and highest frequencies or channels within the frequency band/block under examination.

NOTE—Single-channel boosters that cannot accommodate two simultaneous signals within the passband may be excluded from the test stipulated in step a).

----- The following blanks -----

10.9.2. Test configuration

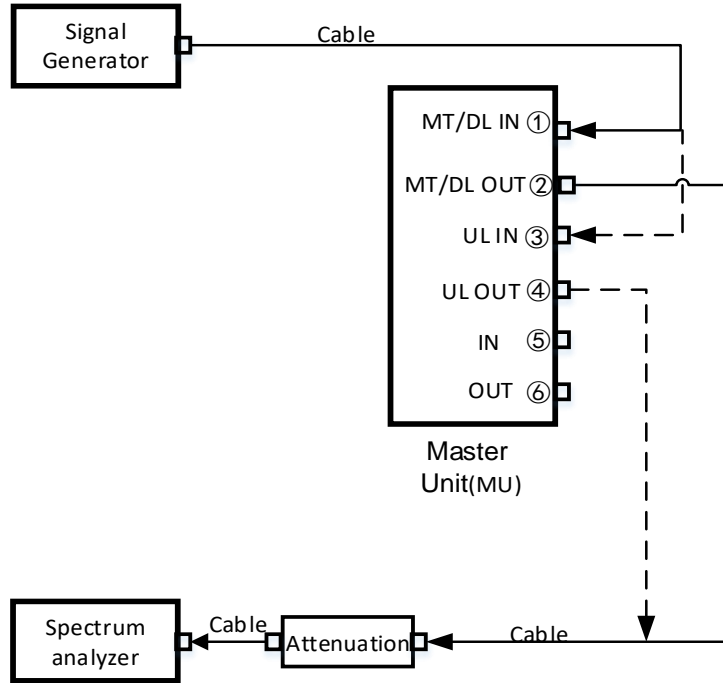

Figure 10.9-1 MU single device test connection diagram

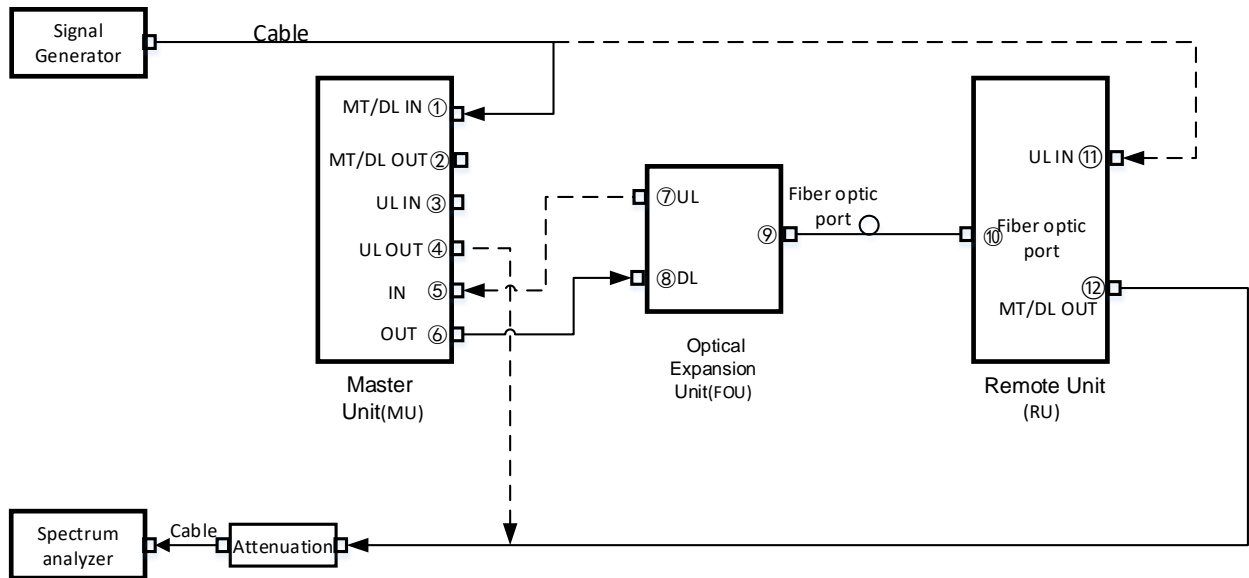

Figure 10.9-2 MU, FOU and RU system test connection diagram

10.9.3. Test procedures

- a) Connect a signal generator to the input of the EUT.
- b) Configure the signal generator to produce a CW signal.
- c) Set the frequency of the CW signal to the center channel of the EUT passband.
- d) Set the output power level so that the resultant signal is just below the AGC threshold (see 4.2).
- e) Connect a spectrum analyzer to the output of the EUT, using appropriate attenuation as necessary.
- f) Set the RBW = 100 kHz. (i.e., for 30 MHz to 1 GHz PLMRS and/or PSRS booster devices)
- g) Set the VBW = $3 \times$ RBW.
- h) Set the Sweep time = auto-couple.
- i) Set the detector to PEAK.
- j) Set the spectrum analyzer start frequency to 30 MHz (or the lowest radio frequency signal generated in the EUT, without going below 9 kHz if the EUT has additional internal clock frequencies), and the stop frequency to $10 \times$ the highest allowable frequency of the EUT passband.
- k) Select MAX HOLD, and use the marker peak function to find the highest emission(s) outside the passband. (This could be either at a frequency lesser or greater than the passband frequencies.)
- l) Capture a plot for inclusion in the test report.

Any frequency outside the authorized bandwidth was attenuated by at least $43+10*\log(P)$ dB. This corresponds to an absolute level of -13dBm ($P_{(dBm)}-(43+10*\log(P_w))$).

NOTE: Select the widest carrier 12.5kHz as the test reference.

----- The following blanks -----

10.9.4. Test results

Test Date (yy-mm-dd): 2021-11-26~11-27

Normal condition: Temp: 27.7~27.8°C, Humid:39~40%, Atmospheric Pressure:101kpa

Supply Voltage: DC -48V and AC 110V, 50Hz

10.9.4.1. Power supply mode: DC -48V

10.9.4.1.1. MU single device test

Frequency range		Max. Spurious Limit(dBm)	RBW (kHz)	Max. Spurious mark Level (dBm)	Margin ^{1*} (dB)	Result
(1) Downlink transmit mode						
Low frequency 450.0125MHz	9kHz~1GHz	-13	100	-29.7	16.7	PASS
	1GHz~6GHz	-13	100	-47.5	34.5	PASS
Middle frequency 479.0MHz	9kHz~1GHz	-13	100	-26.8	13.8	PASS
	1GHz~6GHz	-13	100	-41.7	28.7	PASS
High frequency 508.9875MHz	9kHz~1GHz	-13	100	-42.3	29.3	PASS
	1GHz~6GHz	-13	100	-35.5	22.5	PASS
(2) Uplink transmit mode						
Low frequency 455.0125MHz	9kHz~1GHz	-13	100	-22.8	9.8	PASS
	1GHz~6GHz	-13	100	-51.5	38.5	PASS
Middle frequency 484.0MHz	9kHz~1GHz	-13	100	-25.2	12.2	PASS
	1GHz~6GHz	-13	100	-51.6	38.6	PASS
High frequency 511.9875MHz	9kHz~1GHz	-13	100	-43.2	30.2	PASS
	1GHz~6GHz	-13	100	-32.9	19.9	PASS
NOTE 1: ^{1*} --Margin= specification limit -Maximum mark level.						
NOTE 2: The signal to input the EUT is a CW signal.						

10.9.4.1.2. System test

Frequency range		Max. Spurious Limit(dBm)	RBW (kHz)	Max. Spurious mark Level (dBm)	Margin ^{1*} (dB)	Result
(3) Uplink transmit mode						
Low frequency 455.0125MHz	9kHz~1GHz	-13	100	-22.7	9.7	PASS
	1GHz~6GHz	-13	100	-51.6	38.6	PASS
Middle frequency 484.0MHz	9kHz~1GHz	-13	100	-26.0	13.0	PASS
	1GHz~6GHz	-13	100	-51.6	38.6	PASS
High frequency 511.9875MHz	9kHz~1GHz	-13	100	-43.8	30.8	PASS
	1GHz~6GHz	-13	100	-32.3	19.3	PASS
NOTE 1: ^{1*} --Margin= specification limit -Maximum mark level.						
NOTE 2: The signal to input the EUT is a CW signal.						

----- The following blanks -----

10.9.4.2. Power supply mode: AC 110V,50/60Hz

10.9.4.2.1. MU single device test

Frequency range		Max. Spurious Limit(dBm)	RBW (kHz)	Max. Spurious mark Level (dBm)	Margin ^{1*} (dB)	Result
(4) Downlink transmit mode						
Low frequency 450.0125MHz	9kHz~1GHz	-13	100	-29.1	16.1	PASS
	1GHz~6GHz	-13	100	-41.4	28.4	PASS
Middle frequency 479.0MHz	9kHz~1GHz	-13	100	-25.1	12.1	PASS
	1GHz~6GHz	-13	100	-40.7	27.7	PASS
High frequency 508.9875MHz	9kHz~1GHz	-13	100	-41.4	28.4	PASS
	1GHz~6GHz	-13	100	-34.0	21.0	PASS
(5) Uplink transmit mode						
Low frequency 455.0125MHz	9kHz~1GHz	-13	100	-23.1	10.1	PASS
	1GHz~6GHz	-13	100	-52.1	39.1	PASS
Middle frequency 484.0MHz	9kHz~1GHz	-13	100	-25.4	12.4	PASS
	1GHz~6GHz	-13	100	-51.7	38.7	PASS
High frequency 511.9875MHz	9kHz~1GHz	-13	100	-43.2	30.2	PASS
	1GHz~6GHz	-13	100	-32.7	19.7	PASS
NOTE 1: ^{1*} --Margin= specification limit -Maximum mark level.						
NOTE 2: The signal to input the EUT is a CW signal.						

----- The following blanks -----

10.9.4.2.2. System test

Frequency range		Max. Spurious Limit(dBm)	RBW (kHz)	Max. Spurious mark Level (dBm)	Margin ^{1*} (dB)	Result
(6) Uplink transmit mode						
Low frequency 455.0125MHz	9kHz~1GHz	-13	100	-22.6	9.6	PASS
	1GHz~6GHz	-13	100	-51.7	38.7	PASS
Middle frequency 484.0MHz	9kHz~1GHz	-13	100	-25.4	12.4	PASS
	1GHz~6GHz	-13	100	-51.5	38.5	PASS
High frequency 511.9875MHz	9kHz~1GHz	-13	100	-41.9	28.9	PASS
	1GHz~6GHz	-13	100	-32.3	19.3	PASS
NOTE 1: ^{1*} --Margin= specification limit -Maximum mark level.						
NOTE 2: The signal to input the EUT is a CW signal.						

----- The following blanks -----

10.10. Frequency stability

Test requirement: KDB 935210 D05 clause 4.8
 FCC PART 2 1055(a)(2)
 FCC PART 90.213
 FCC PART 90.219 (e)(4)(i)

Test Method: KDB 935210 D05/4.8
 FCC PART 2 1055(b)

10.10.1. Limit

The EUT shall comply with sections 4.8 of KDB 935210 D05.

Section 90.219(e)(4)(i) requires that a signal being retransmitted by an amplifier, repeater, or industrial booster meets the frequency stability requirements of Section 90.213. However, this requirement presumes that the EUT processes an input signal in ways that can influence the output signal frequency/frequencies; however, most signal boosters do not incorporate an oscillator). If the amplifier, booster, or repeater does not alter the input signal in any way, then a frequency stability test may not be required.

When performing frequency stability measurements on these types of devices, the instability associated with the EUT must be isolated from any frequency instability associated with the measurement instrumentation. One method for realizing such isolation is to connect the reference clock input of the signal generator to the reference output of the frequency counter, to confirm that any frequency instability is associated with the EUT, and is not due to differences between the reference oscillators internal to the measurement instrumentation.

Unless noted elsewhere, transmitters used in the services governed by this part must have a minimum frequency stability as specified in the following table 10.10-1.

Table 10.10-1 Frequency stability limits

frequency range(MHz)	Minimum Frequency Stability(ppm)
450~512	±0.5
NOTE: ppm means parts per million.	

NOTE 1: RF channels to be tested for single-carrier: Middle frequency

NOTE 2: Modulation type is CW.

----- The following blanks -----

10.10.2. Test configuration

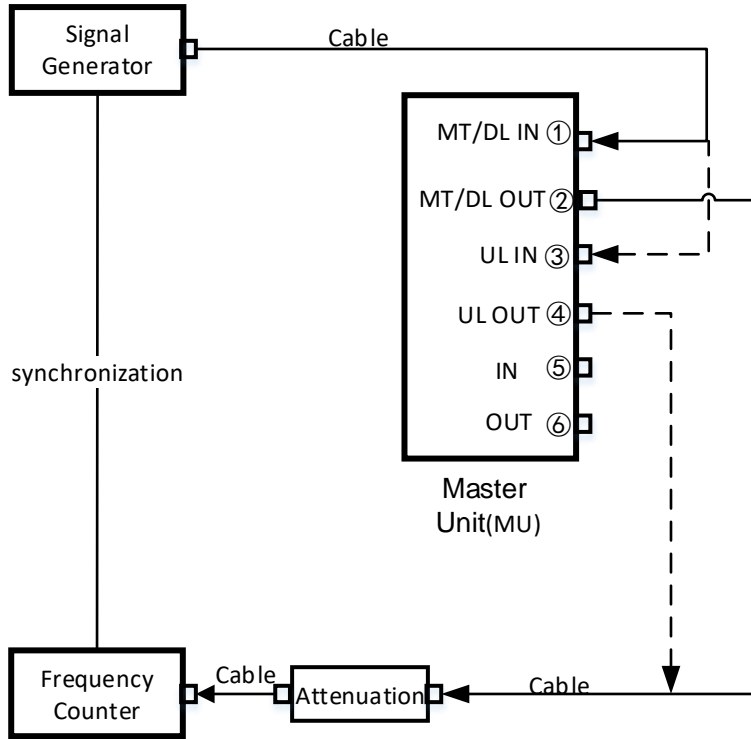

Figure 10.10-1 MU single device test connection diagram

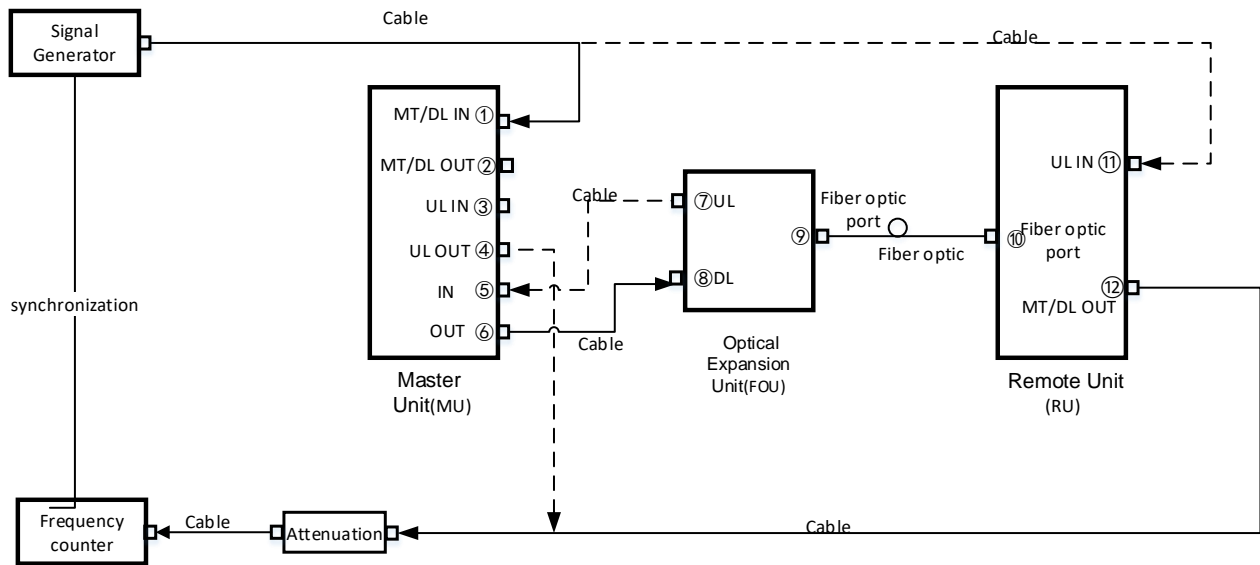

Figure 10.10-2 MU, FOU and RU system test connection diagram

10.10.3. Test procedures

10.10.3.1. FCC PART 2 1055(a) (1)

§2.1055 Measurements required: Frequency stability.

(a) The frequency stability shall be measured with variation of ambient temperature as follows:

(1) From -30° to $+50^{\circ}$ centigrade for all equipment except that specified in paragraphs (a) (2) and (3) of this section.

(2) From -20° to $+50^{\circ}$ centigrade for equipment to be licensed for use in the Maritime Services under part 80 of this chapter, except for Class A, B, and S Emergency Position Indicating Radiobeacons (EPIRBs), and equipment to be licensed for use above 952 MHz at operational fixed stations in all services, stations in the Local Television Transmission Service and Point-to-Point Microwave Radio Service under part 21 of this chapter, equipment licensed for use aboard aircraft in the Aviation Services under part 87 of this chapter, and equipment authorized for use in the Family Radio Service under part 95 of this chapter.

(3) From 0° to $+50^{\circ}$ centigrade for equipment to be licensed for use in the Radio Broadcast Services under part 73 of this chapter.

(b) Frequency measurements shall be made at the extremes of the specified temperature range and at intervals of not more than 10° centigrade through the range. A period of time sufficient to stabilize all of the components of the oscillator circuit at each temperature level shall be allowed prior to frequency measurement. The short term transient effects on the frequency of the transmitter due to keying (except for broadcast transmitters) and any heating element cycling normally occurring at each ambient temperature level also shall be shown. Only the portion or portions of the transmitter containing the frequency determining and stabilizing circuitry need be subjected to the temperature variation test.

10.10.3.2. ANSI C63.26-2015 clause 5.6.3

5.6.3 Procedure for frequency stability testing

Frequency stability is a measure of the frequency drift due to temperature and supply voltage variations, with reference to the frequency measured at $+20^{\circ}\text{C}$ and rated supply voltage.

The operating carrier frequency shall be set up in accordance with the manufacturer's published operation and instruction manual prior to the commencement of these tests. No adjustment of any frequency determining circuit element shall be made subsequent to this initial set-up. Frequency stability is tested:

- a) At 10°C intervals of temperatures between -30°C and $+50^{\circ}\text{C}$ at the manufacturer's rated supply voltage, and
- b) At $+20^{\circ}\text{C}$ temperature and $\pm 15\%$ supply voltage variations. If a product is specified to operate over a range of input voltage then the -15% variation is applied to the lowermost voltage and the $+15\%$ is applied to the uppermost voltage.

During the test all necessary settings, adjustments and control of the EUT have to be performed without disturbing the test environment, i.e., without opening the environmental chamber. The frequency stabilities can be maintained to a lesser temperature range provided that the transmitter is automatically inhibited from operating outside the lesser temperature range. For handheld equipment that is only capable of operating from internal batteries and the supply voltage cannot be varied, the frequency stability tests shall be performed at the nominal battery voltage and the battery end point voltage specified by the manufacturer. An external supply voltage can be used and set at the internal battery nominal voltage, and again at the battery operating end point voltage which shall be specified by the equipment manufacturer.

If an unmodulated carrier is not available, the mean frequency of a modulated carrier can be obtained by using a frequency counter with gating time set to an appropriately large multiple of bit periods (gating time depending on the required accuracy). Full details on the choice of values shall be included in the test report.

NOTE 1: Input power supply range limits by manufacturer's declare:

MU typical DC input power: DC -48V;

RU typical DC input power: DC -48V;

NOTE 2:MU, FOU and RU Operating Temperature limits by manufacturer's declare: -33°C to +55°C.

----- **The following blanks** -----

10.10.4. Test results

Test Date (yy-mm-dd): 2021-12-11

Normal condition: Temp: 24.4°C, Humid:50%, Atmospheric Pressure:101kpa

Extreme test conditions:

Temp range: -30°C~+50°C

Test Date: 2021-12-11~12-12

Supply Voltage: DC -48V

10.10.4.1. MU single device test

10.10.4.1.1. Downlink transmit mode

Temperature (°C)	Voltage	Input carrier Frequency (MHz)	Output carrier Frequency error(Hz)	Limit (ppm)	Frequency stability (ppm)	Result
-20	DC -40.8V(-48*85%)	479.0	-1.1	±0.5	-0.0023	PASS
	DC -48V	479.0	0.6	±0.5	0.0013	PASS
	DC -55.2V(-48*115%)	479.0	0.8	±0.5	0.0017	PASS
-10	DC -40.8V(-48*85%)	479.0	0.7	±0.5	0.0015	PASS
	DC -48V	479.0	-0.6	±0.5	-0.0013	PASS
	DC -55.2V(-48*115%)	479.0	0.8	±0.5	0.0017	PASS
0	DC -40.8V(-48*85%)	479.0	0.8	±0.5	0.0017	PASS
	DC -48V	479.0	0.7	±0.5	0.0015	PASS
	DC -55.2V(-48*115%)	479.0	0.8	±0.5	0.0017	PASS
10	DC -40.8V(-48*85%)	479.0	-0.6	±0.5	-0.0013	PASS
	DC -48V	479.0	-1.0	±0.5	-0.0021	PASS
	DC -55.2V(-48*115%)	479.0	0.8	±0.5	0.0017	PASS
20	DC -40.8V(-48*85%)	479.0	0.8	±0.5	0.0017	PASS
	DC -48V	479.0	-1.1	±0.5	-0.0023	PASS
	DC -55.2V(-48*115%)	479.0	0.9	±0.5	0.0019	PASS
30	DC -40.8V(-48*85%)	479.0	0.7	±0.5	0.0015	PASS
	DC -48V	479.0	0.8	±0.5	0.0017	PASS
	DC -55.2V(-48*115%)	479.0	-1.0	±0.5	-0.0021	PASS
40	DC -40.8V(-48*85%)	479.0	-1.2	±0.5	-0.0025	PASS
	DC -48V	479.0	0.8	±0.5	0.0017	PASS
	DC -55.2V(-48*115%)	479.0	0.7	±0.5	0.0015	PASS
50	DC -40.8V(-48*85%)	479.0	-0.5	±0.5	-0.0010	PASS
	DC -48V	479.0	0.9	±0.5	0.0019	PASS