

With the input signal amplitude set 3 dB above the AGC threshold  
Middle Frequency: 479.0MHz

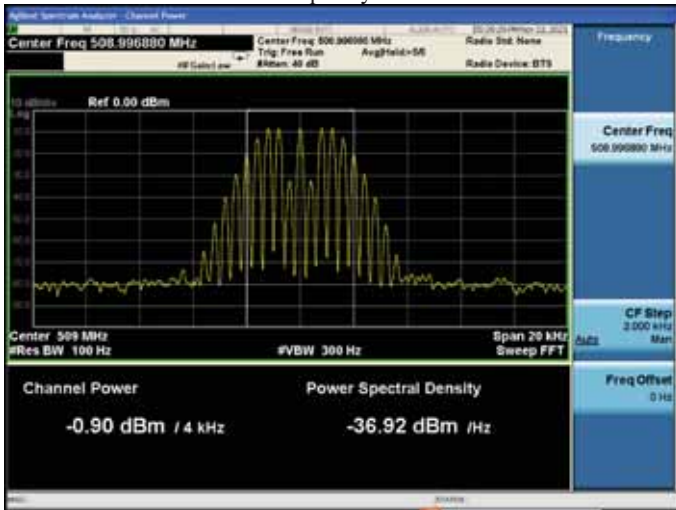

Input signal  
High Frequency: 508.99688MHz

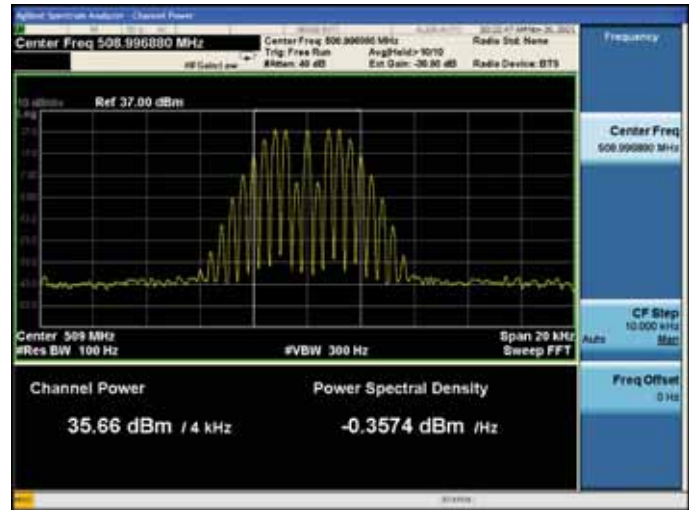

With the input signal amplitude set the AGC threshold  
High Frequency: 508.99688MHz

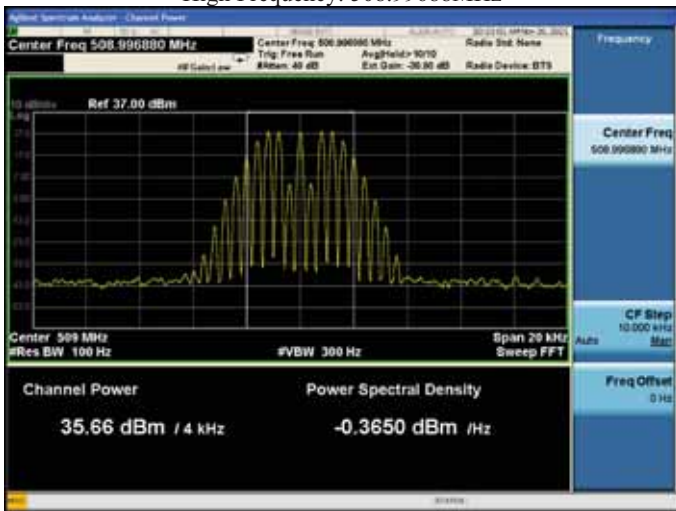

With the input signal amplitude set 3 dB above the AGC threshold  
High Frequency: 508.99688MHz

10.5.5.3.1.1.4. 12.5kHz Analog FM mode

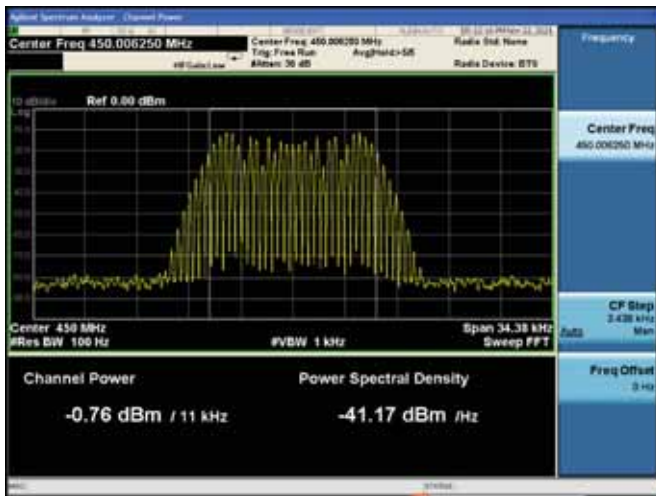

Input signal  
Low Frequency: 450.00625MHz



With the input signal amplitude set the AGC threshold  
Low Frequency: 450.00625MHz

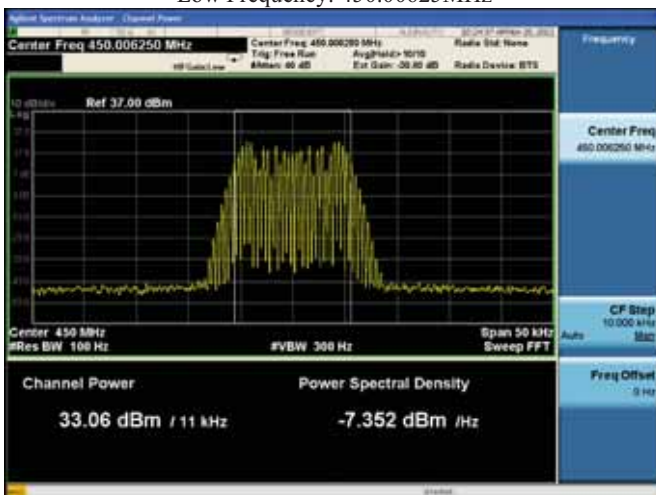

With the input signal amplitude set 3 dB above the AGC threshold  
Low Frequency: 450.00625MHz

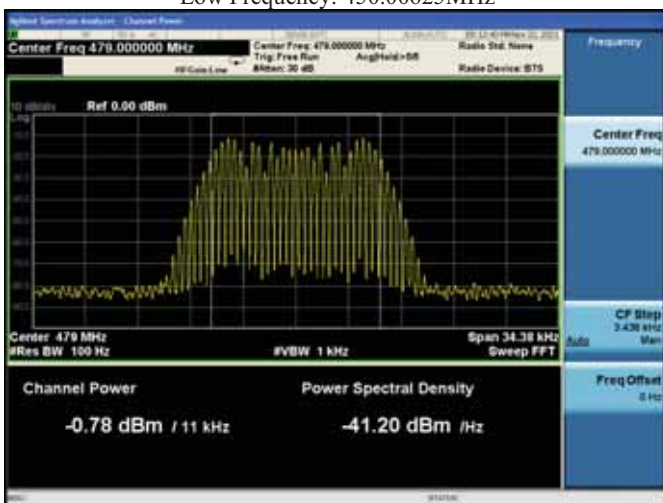

Input signal  
Middle Frequency: 479.0MHz

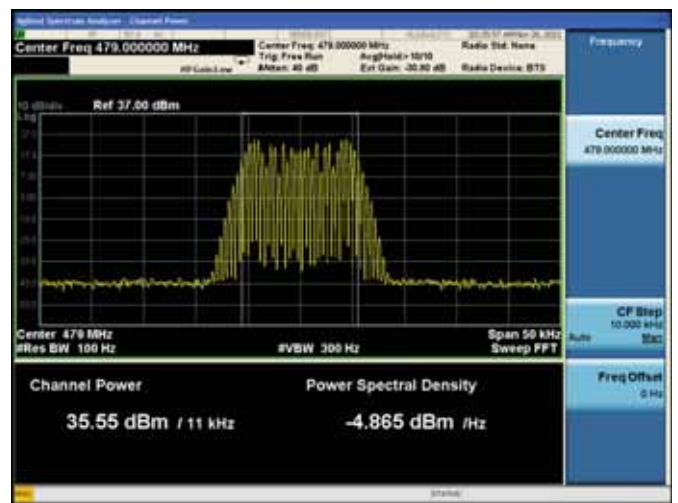

With the input signal amplitude set the AGC threshold  
Middle Frequency: 479.0MHz

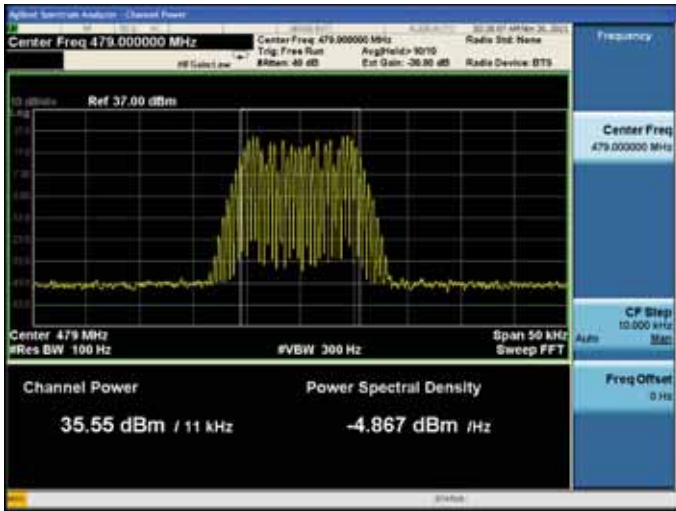

With the input signal amplitude set 3 dB above the AGC threshold  
Middle Frequency: 479.0MHz

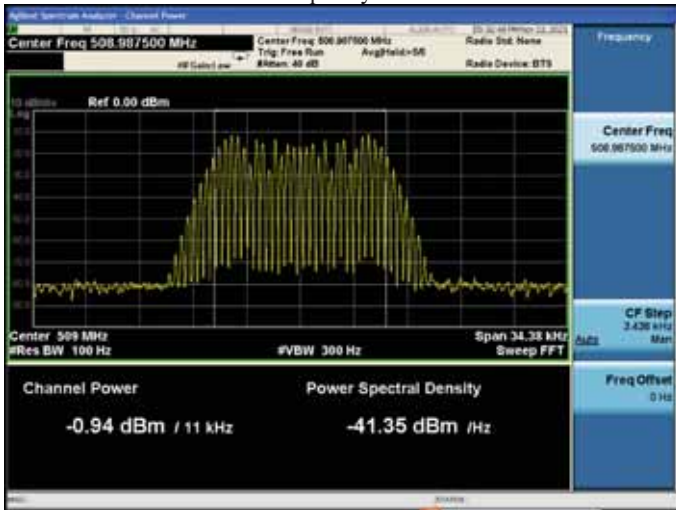

Input signal  
High Frequency: 508.99375MHz

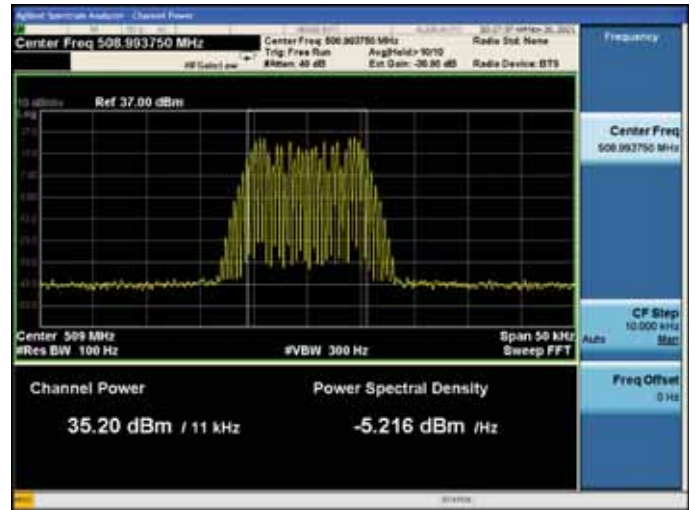

With the input signal amplitude set the AGC threshold  
High Frequency: 508.99375MHz

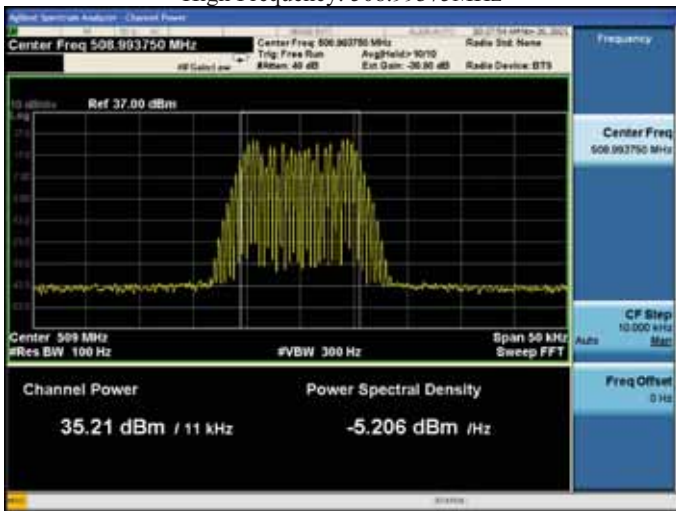

With the input signal amplitude set 3 dB above the AGC threshold  
High Frequency: 508.99375MHz



10.5.5.3.1.1.5. 25kHz Analog FM mode

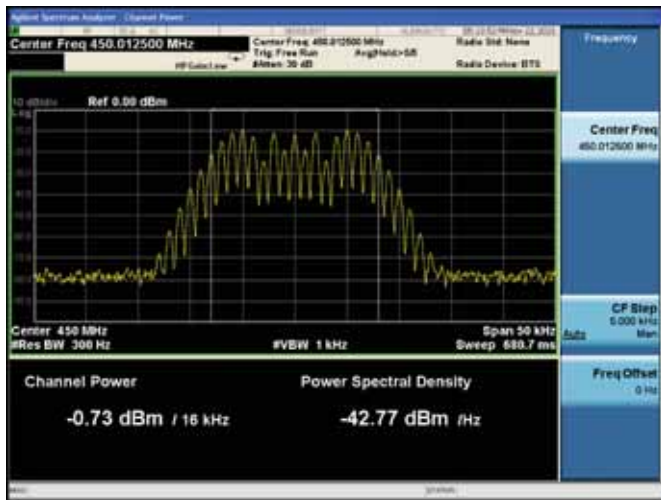

Input signal  
 Low Frequency: 450.0125MHz

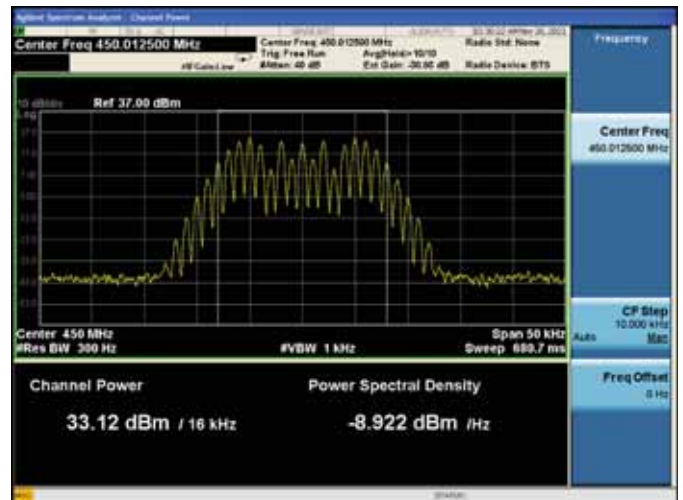

With the input signal amplitude set the AGC threshold  
 Low Frequency: 450.0125MHz

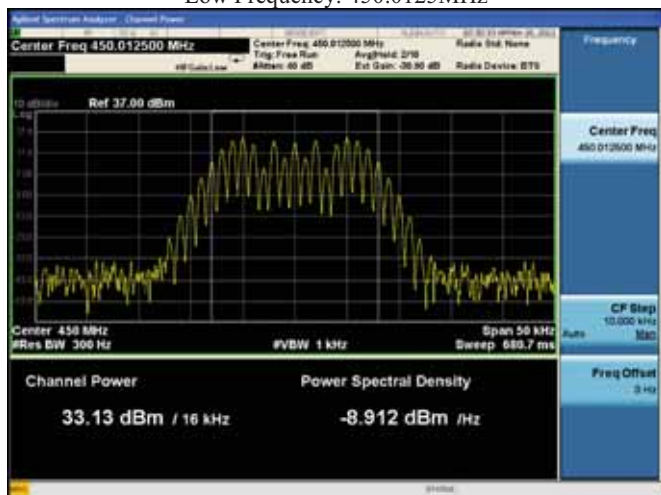

With the input signal amplitude set 3 dB above the AGC threshold  
 Low Frequency: 450.0125MHz

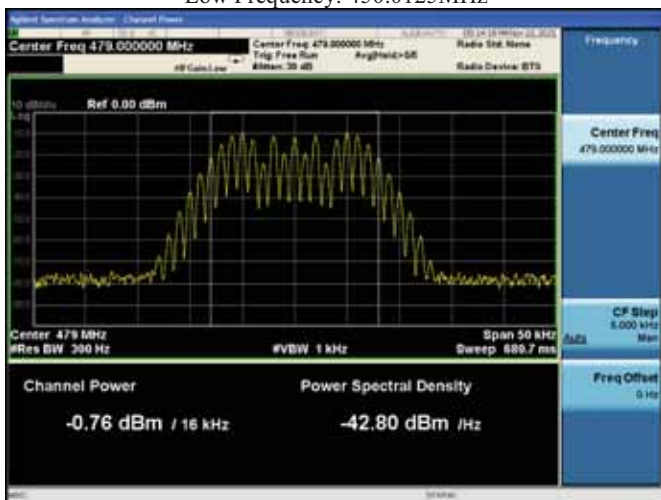

Input signal  
 Middle Frequency: 479.0MHz

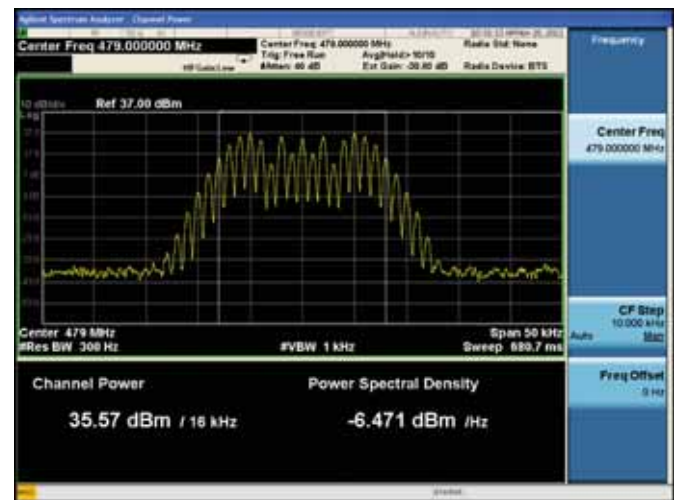

With the input signal amplitude set the AGC threshold  
 Middle Frequency: 479.0MHz

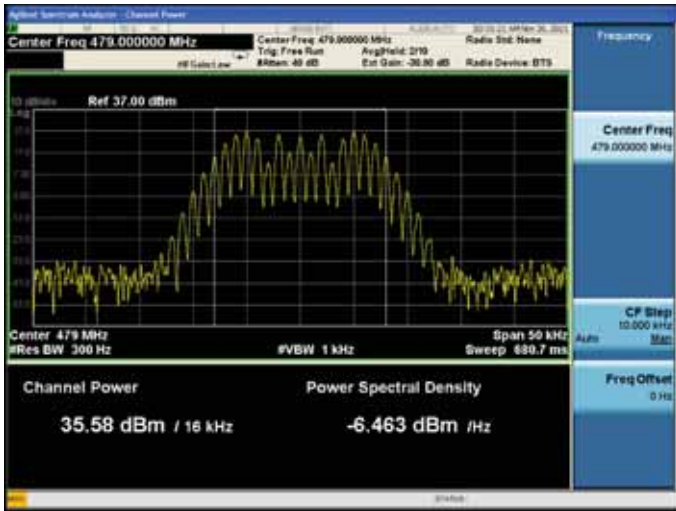

With the input signal amplitude set 3 dB above the AGC threshold  
Middle Frequency: 479.0MHz

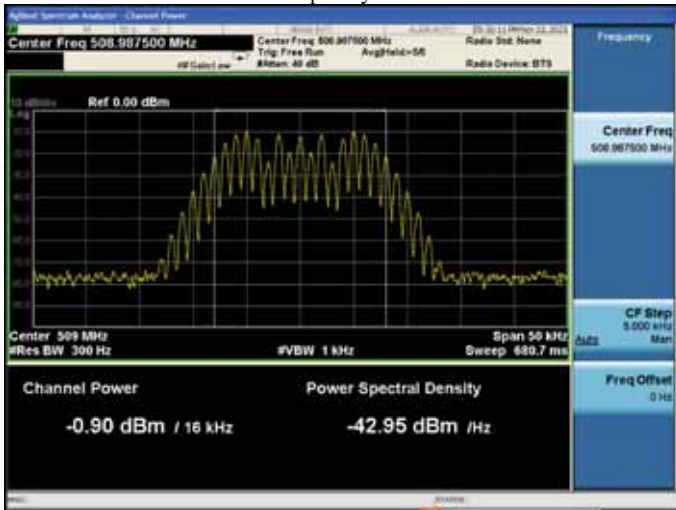

Input signal  
High Frequency: 508.9875MHz

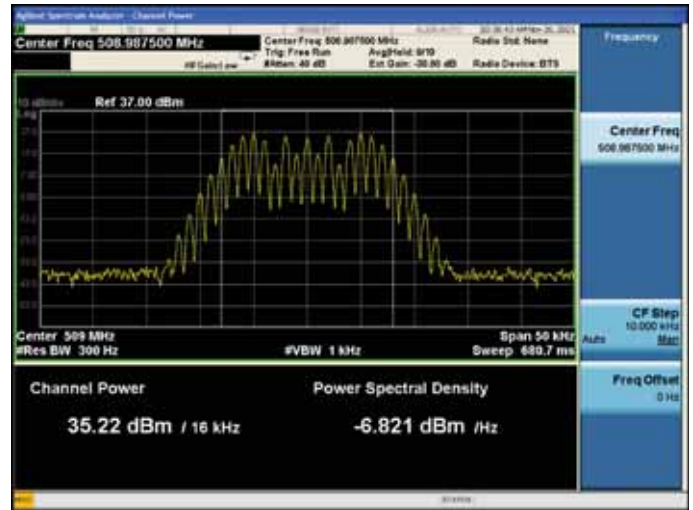

With the input signal amplitude set the AGC threshold  
High Frequency: 508.9875MHz

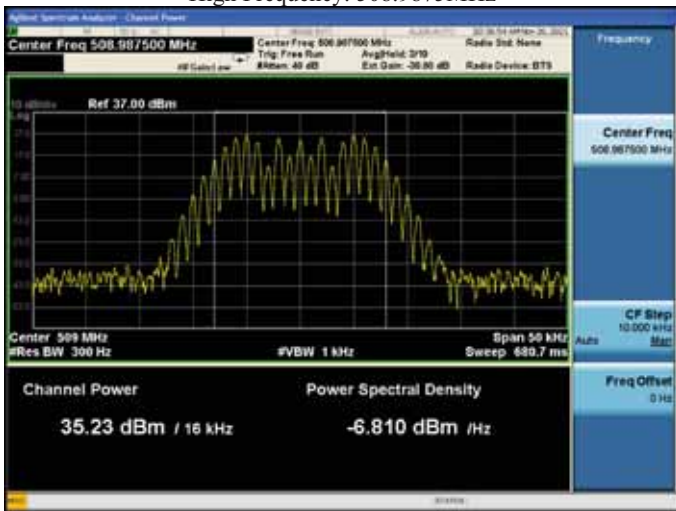

With the input signal amplitude set 3 dB above the AGC threshold  
High Frequency: 508.9875MHz

10.5.5.3.1.2. Uplink

10.5.5.3.1.2.1. P25 Phase I(C4FM) mode

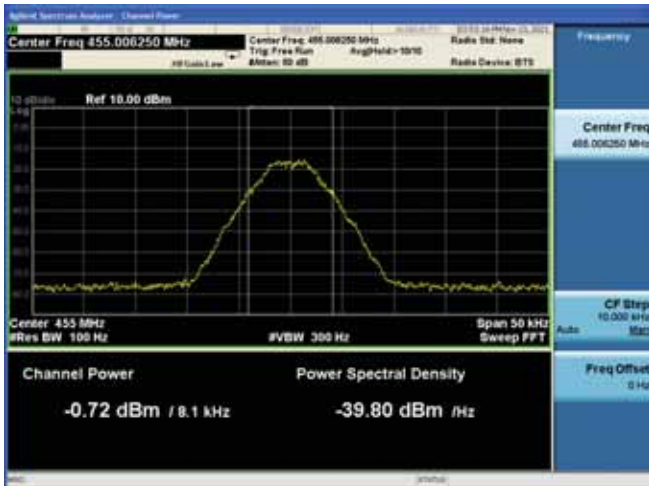

Input signal  
Low Frequency: 455.00625MHz

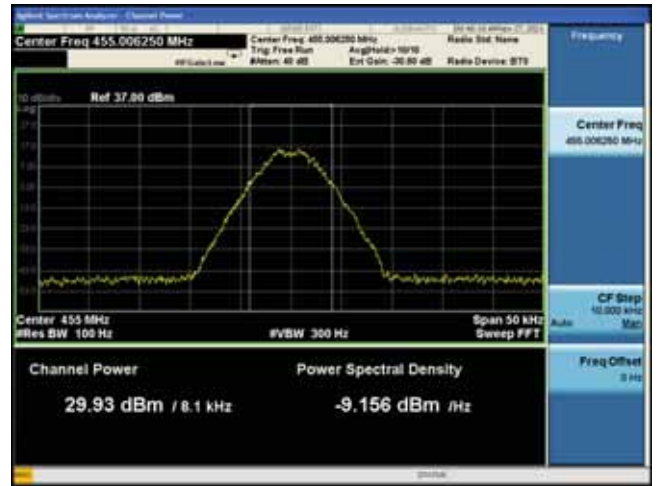

With the input signal amplitude set the AGC threshold  
Low Frequency: 455.00625MHz

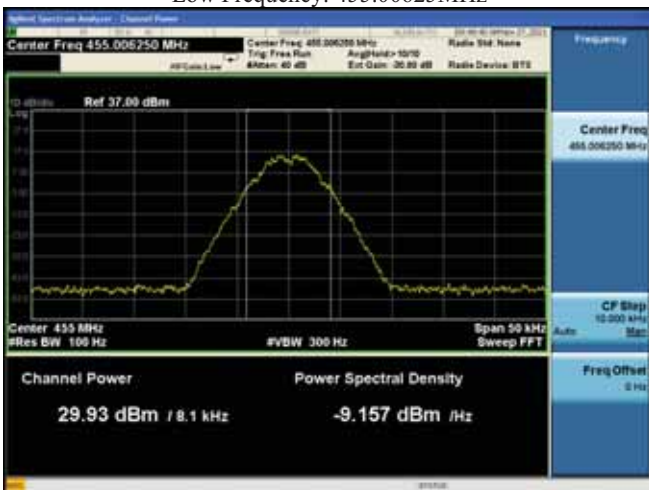

With the input signal amplitude set 3 dB above the AGC threshold  
Low Frequency: 455.00625MHz

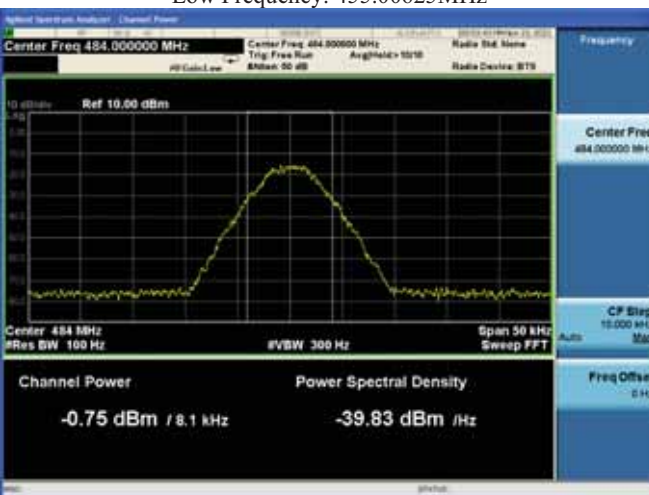

Input signal  
Middle Frequency: 484.0MHz

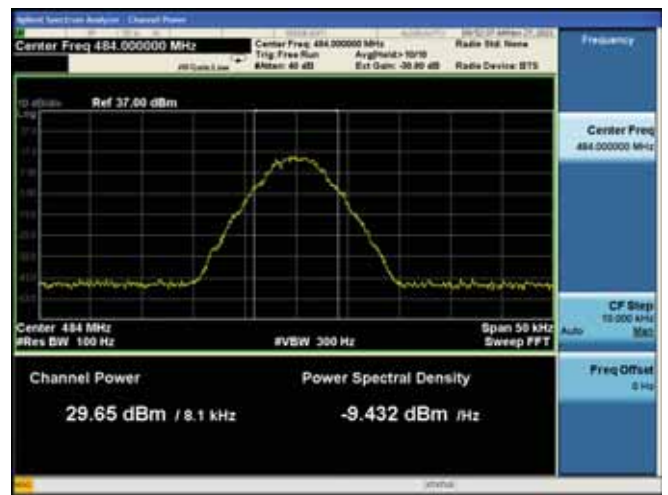

With the input signal amplitude set the AGC threshold  
Middle Frequency: 484.0MHz



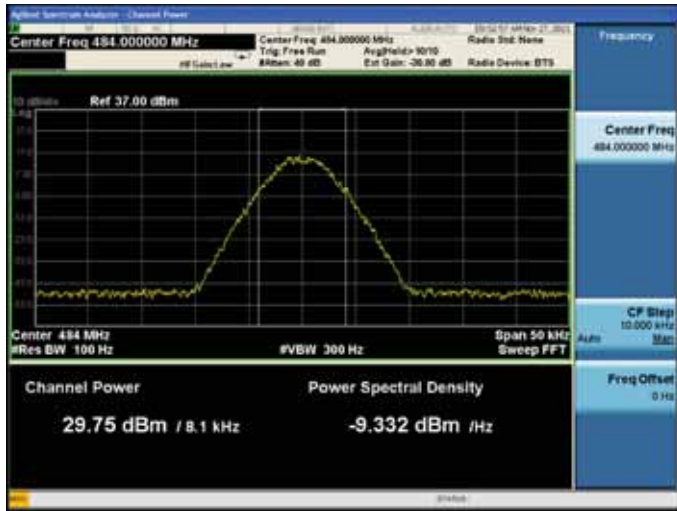

With the input signal amplitude set 3 dB above the AGC threshold  
Middle Frequency: 484.0MHz

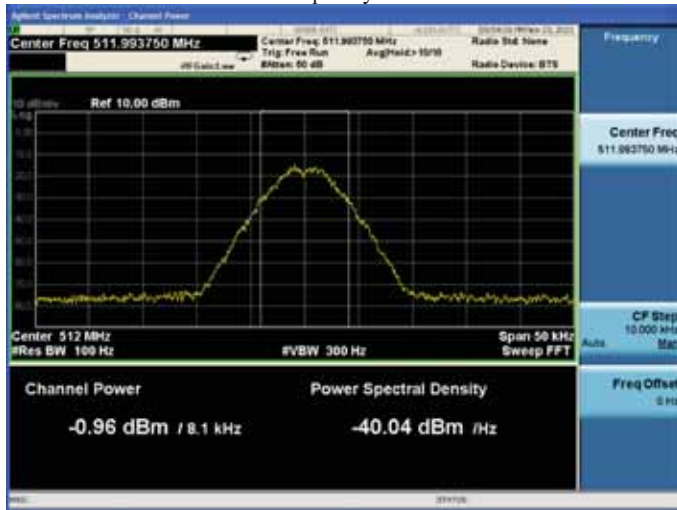

Input signal  
High Frequency: 511.99375MHz



With the input signal amplitude set the AGC threshold  
High Frequency: 511.99375MHz

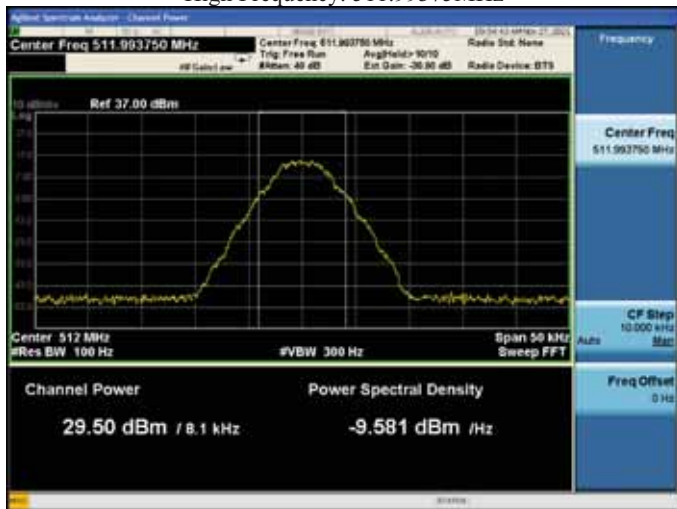

With the input signal amplitude set 3 dB above the AGC threshold  
High Frequency: 511.99375MHz

10.5.5.3.1.2.2. P25 Phase II(H-DQPSK) mode



Input signal

Low Frequency: 455.00625MHz

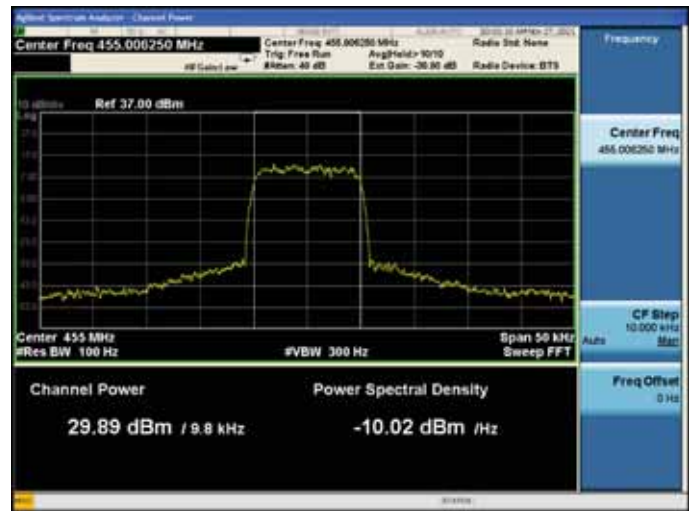

With the input signal amplitude set the AGC threshold

Low Frequency: 455.00625MHz

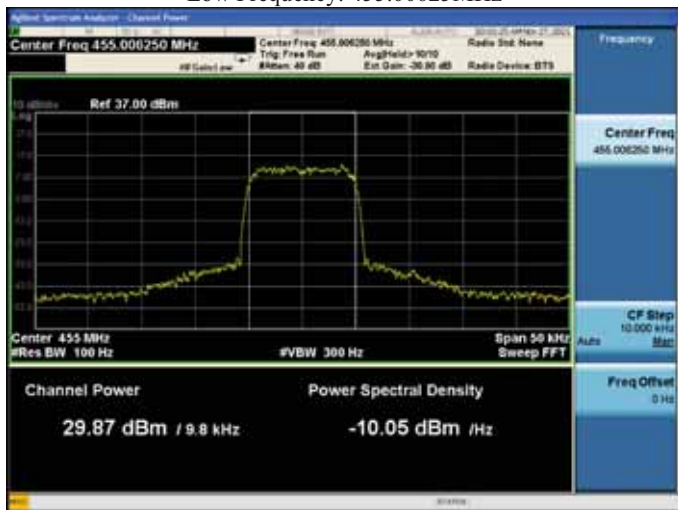

With the input signal amplitude set 3 dB above the AGC threshold

Low Frequency: 455.00625MHz



Input signal

Middle Frequency: 484.0MHz

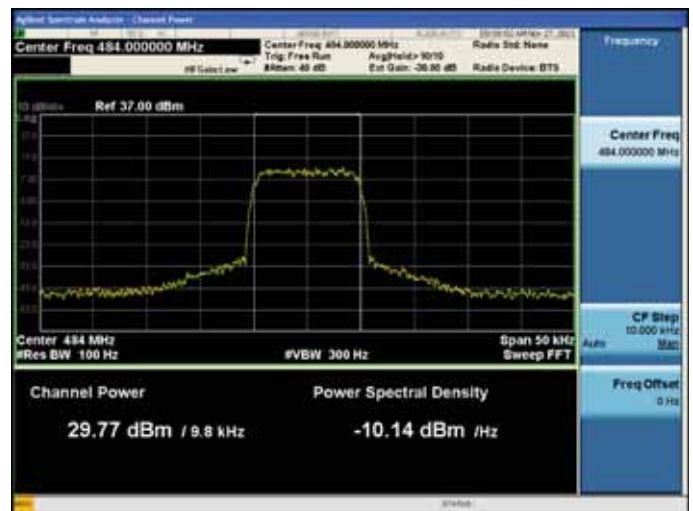

With the input signal amplitude set the AGC threshold

Middle Frequency: 484.0MHz





With the input signal amplitude set 3 dB above the AGC threshold  
Middle Frequency: 484.0MHz

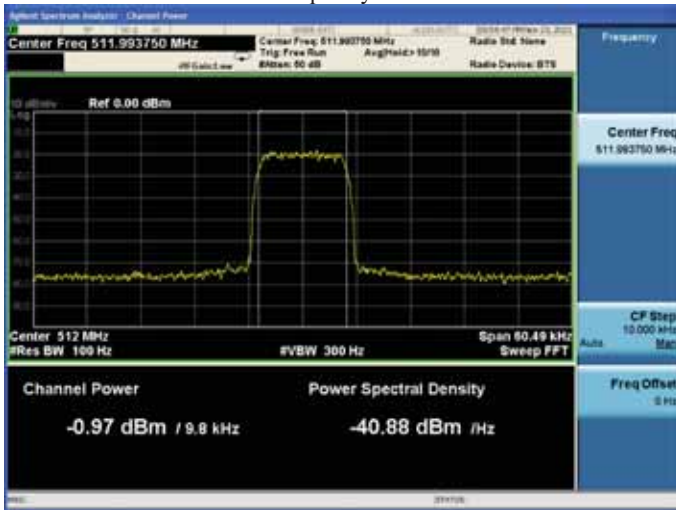

Input signal  
High Frequency: 511.99375MHz



With the input signal amplitude set the AGC threshold  
High Frequency: 511.99375MHz

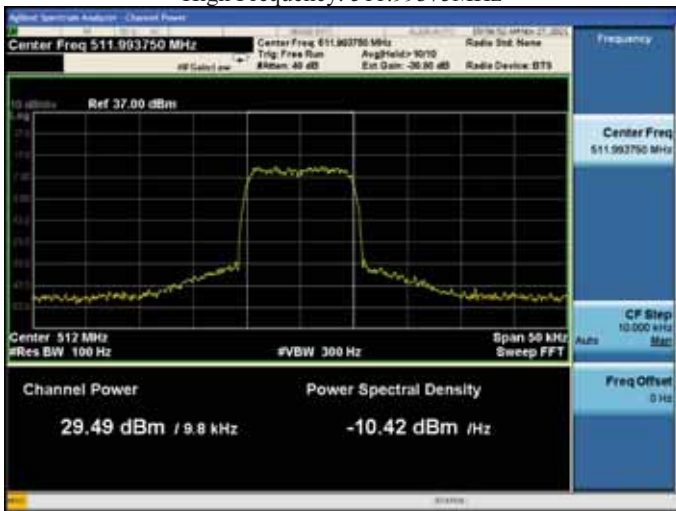

With the input signal amplitude set 3 dB above the AGC threshold  
High Frequency: 511.99375MHz

10.5.5.3.1.2.3. 6.25kHz Analog FM mode

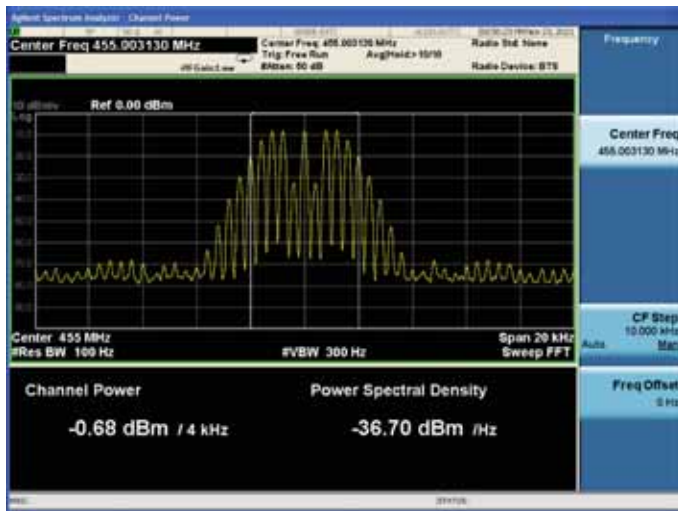

Input signal  
 Low Frequency: 455.00313MHz

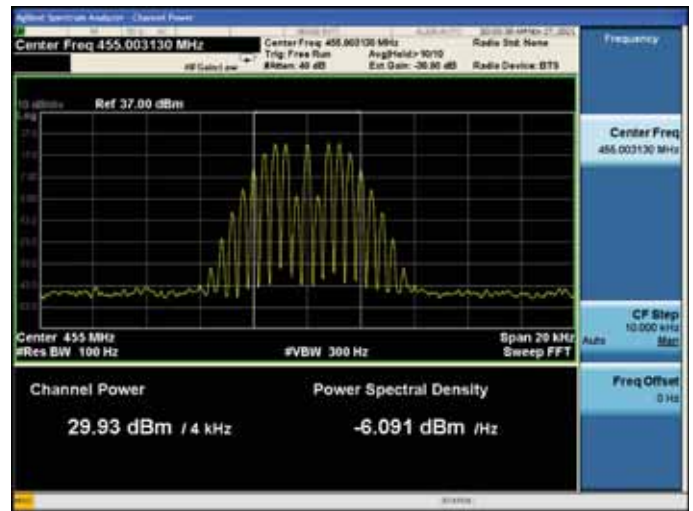

With the input signal amplitude set the AGC threshold  
 Low Frequency: 455.00313MHz

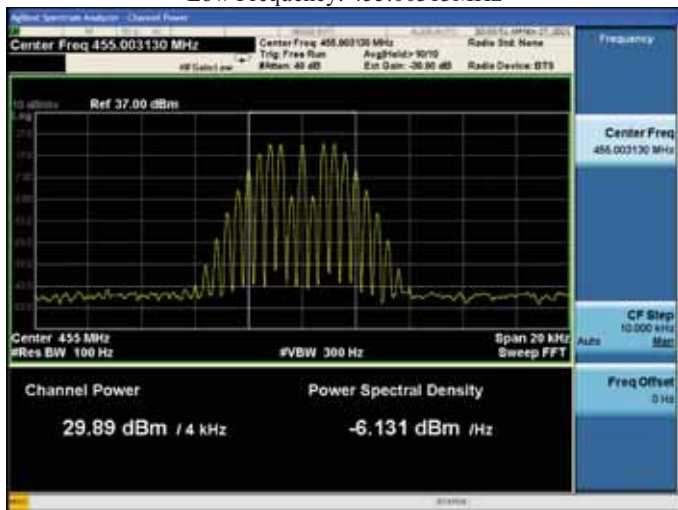

With the input signal amplitude set 3 dB above the AGC threshold  
 Low Frequency: 455.00313MHz



Input signal  
 Middle Frequency: 484.0MHz

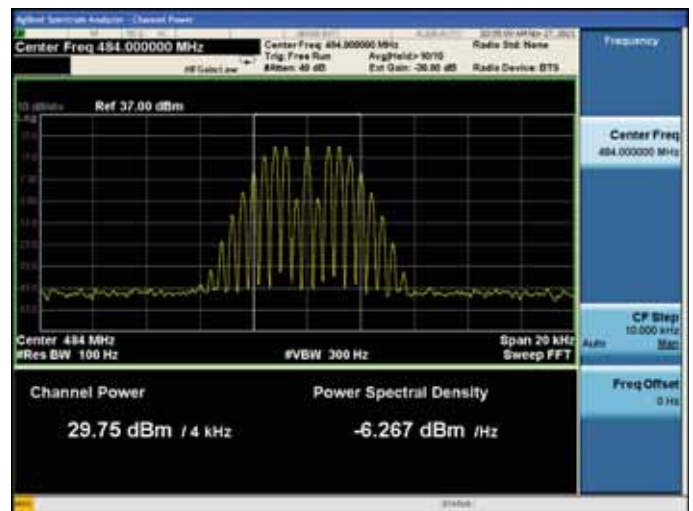

With the input signal amplitude set the AGC threshold  
 Middle Frequency: 484.0MHz



With the input signal amplitude set 3 dB above the AGC threshold  
Middle Frequency: 484.0MHz

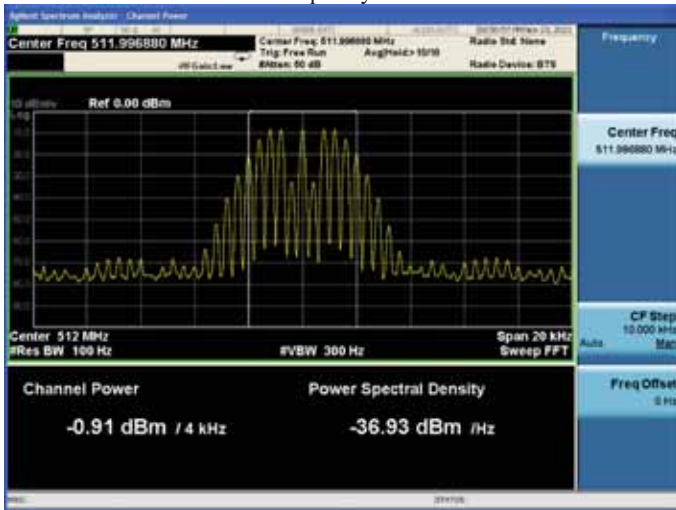

Input signal  
High Frequency: 511.99688MHz



With the input signal amplitude set the AGC threshold  
High Frequency: 511.99688MHz

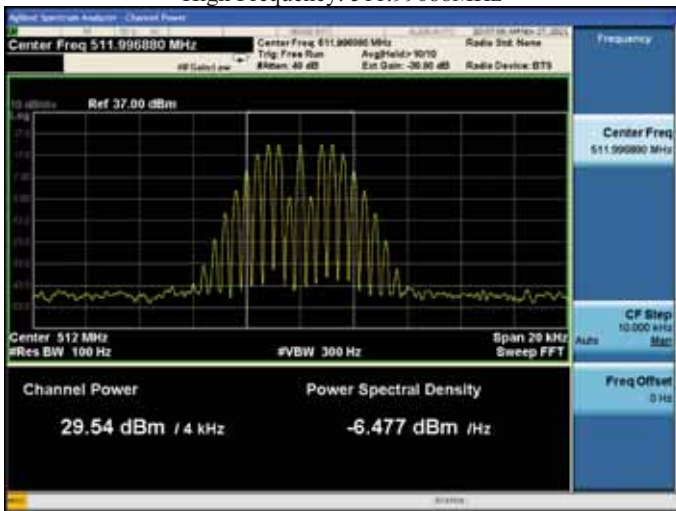

With the input signal amplitude set 3 dB above the AGC threshold  
High Frequency: 511.99688MHz



10.5.5.3.1.2.4. 12.5kHz Analog FM mode

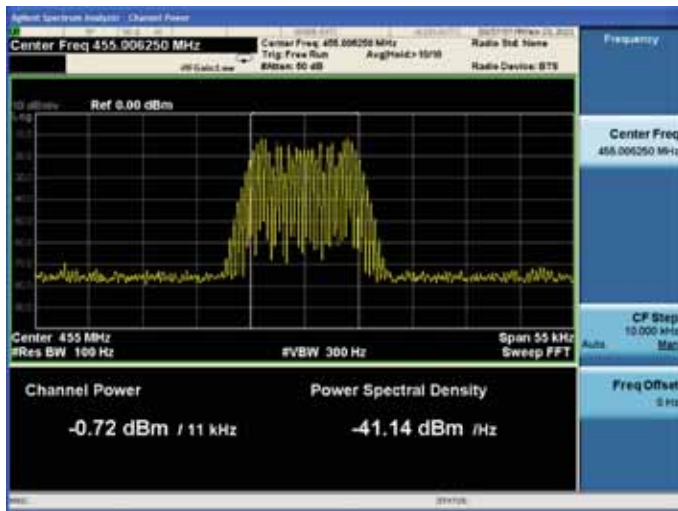

Input signal  
 Low Frequency: 455.00625MHz

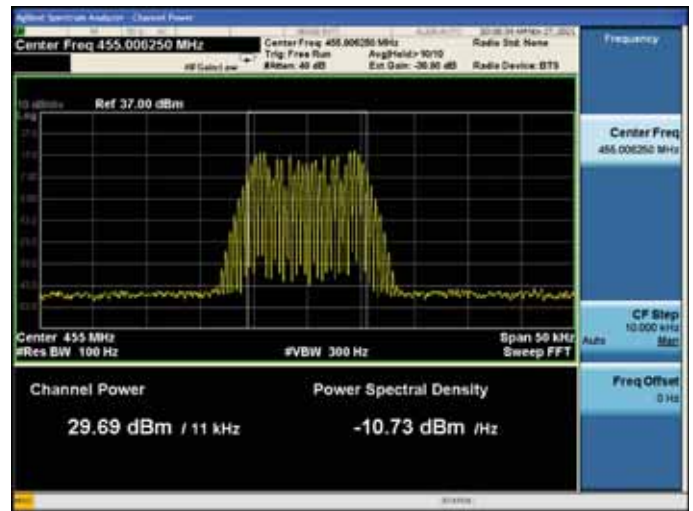

With the input signal amplitude set the AGC threshold  
 Low Frequency: 455.00625MHz



With the input signal amplitude set 3 dB above the AGC threshold  
 Low Frequency: 455.00625MHz

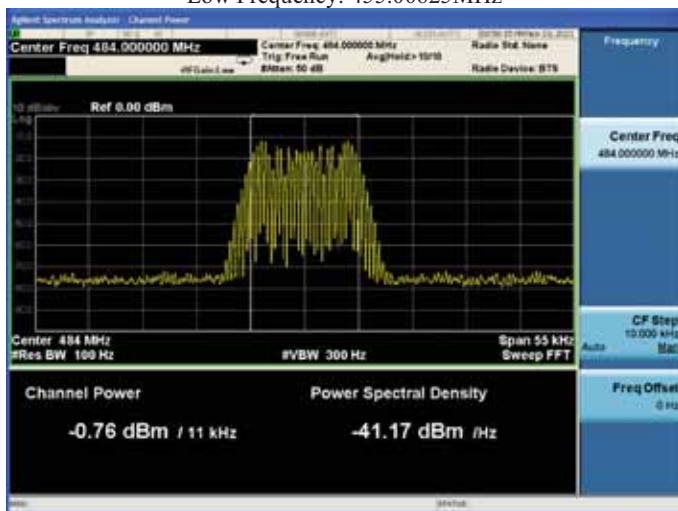

Input signal  
 Middle Frequency: 484.0MHz

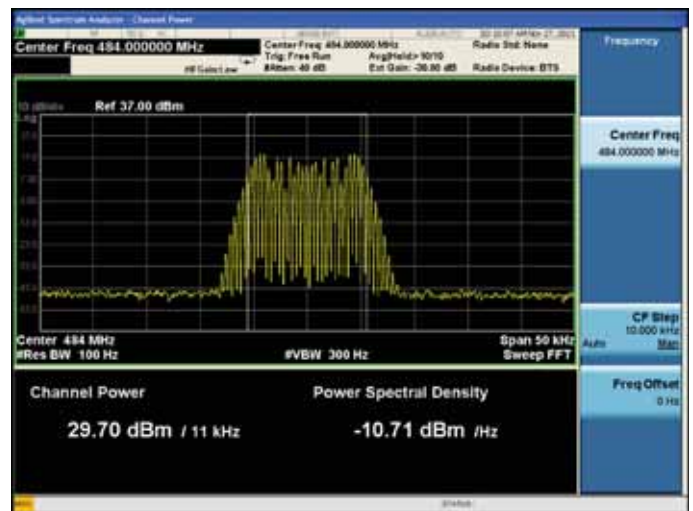

With the input signal amplitude set the AGC threshold  
 Middle Frequency: 484.0MHz

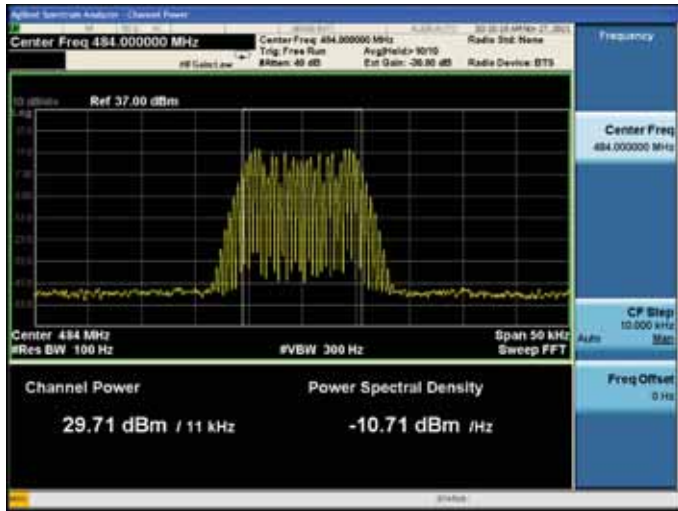

With the input signal amplitude set 3 dB above the AGC threshold  
Middle Frequency: 484.0MHz

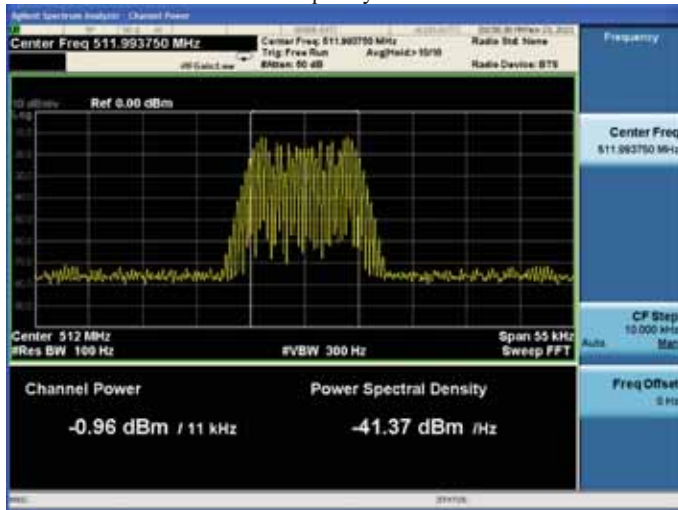

Input signal  
High Frequency: 511.99375MHz



With the input signal amplitude set the AGC threshold  
High Frequency: 511.99375MHz

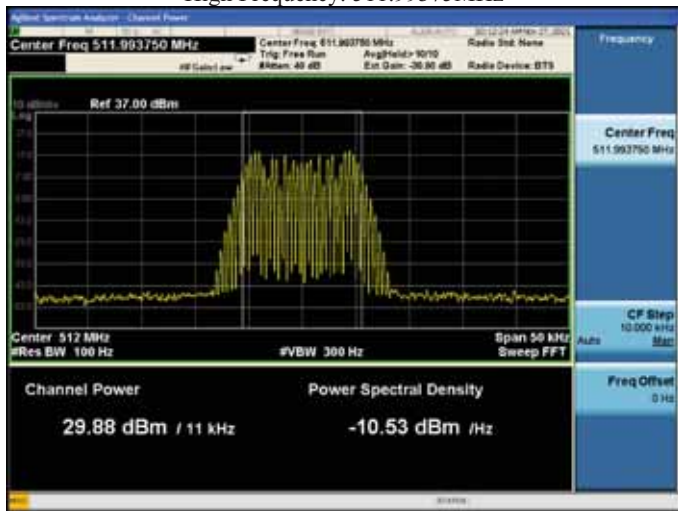

With the input signal amplitude set 3 dB above the AGC threshold  
High Frequency: 511.99375MHz

10.5.5.3.1.2.5. 25kHz Analog FM mode

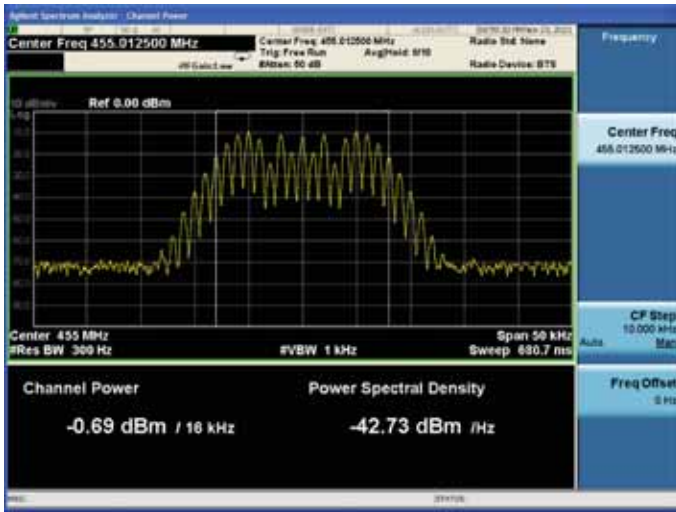

Input signal  
Low Frequency: 455.0125MHz

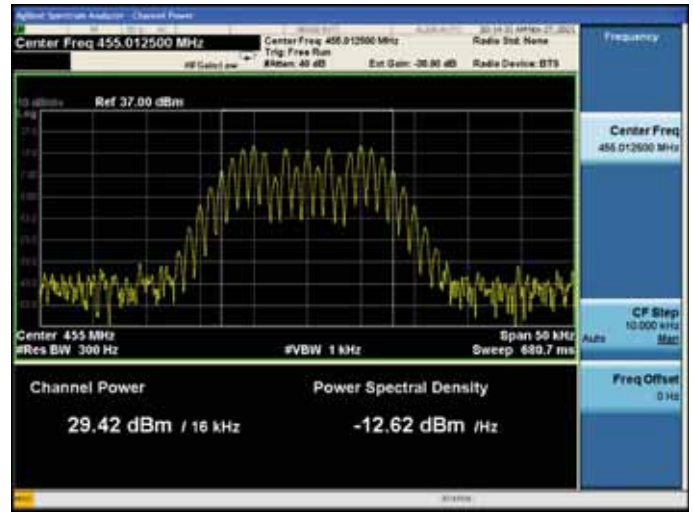

With the input signal amplitude set the AGC threshold  
Low Frequency: 455.0125MHz

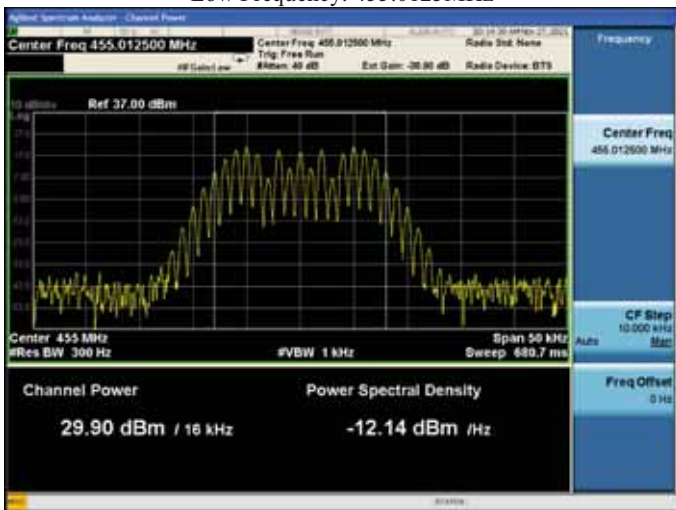

With the input signal amplitude set 3 dB above the AGC threshold  
Low Frequency: 455.0125MHz

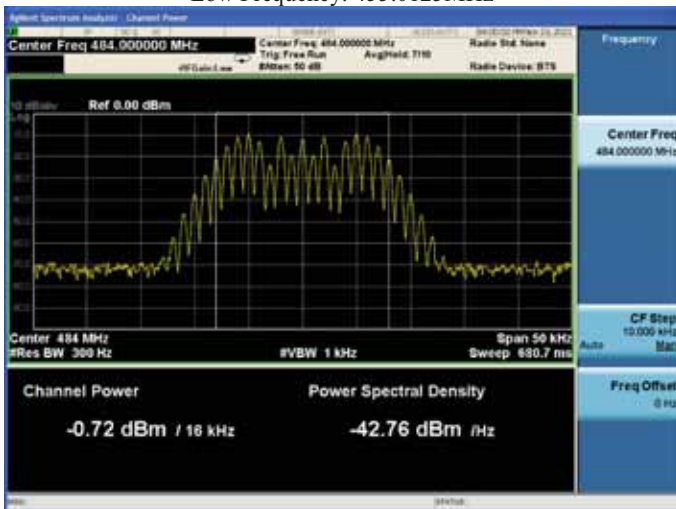

Input signal  
Middle Frequency: 484.0MHz



With the input signal amplitude set the AGC threshold  
Middle Frequency: 484.0MHz



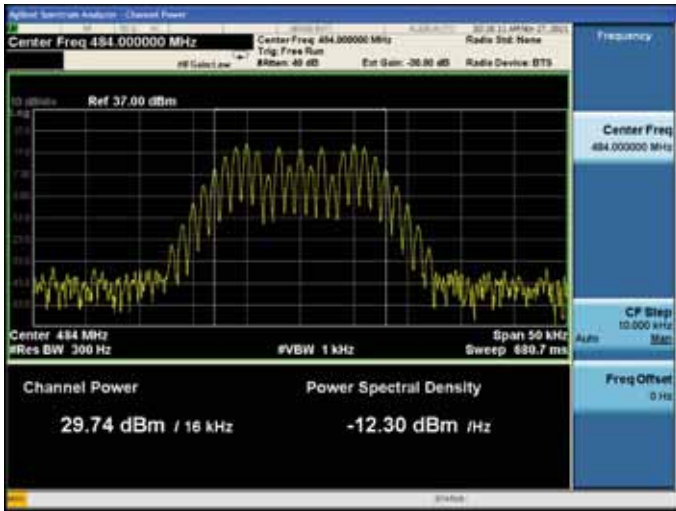

With the input signal amplitude set 3 dB above the AGC threshold  
Middle Frequency: 484.0MHz

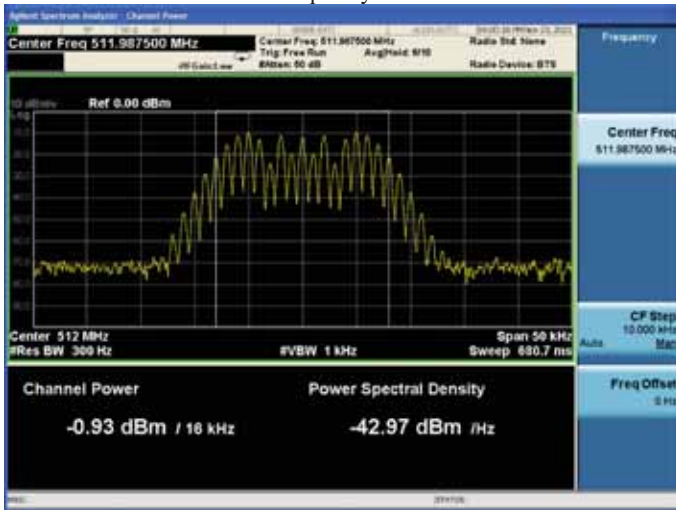

Input signal  
High Frequency: 511.9875MHz

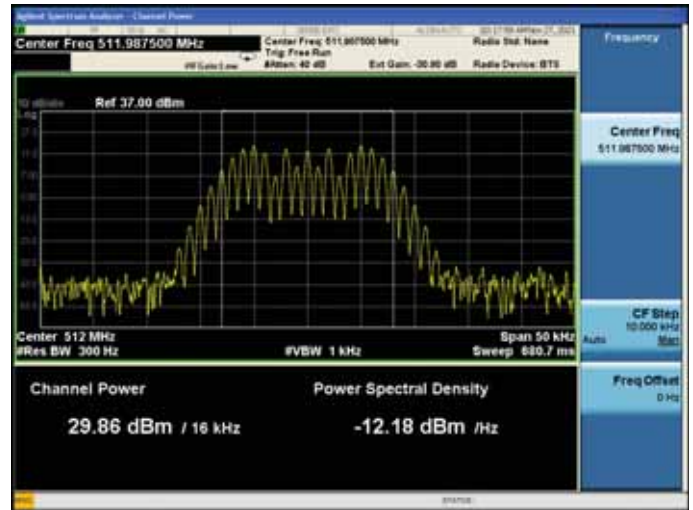

With the input signal amplitude set the AGC threshold  
High Frequency: 511.9875MHz



With the input signal amplitude set 3 dB above the AGC threshold  
High Frequency: 511.9875MHz

10.5.5.3.2. System test

10.5.5.3.2.1. Uplink

10.5.5.3.2.1.1. P25 Phase I(C4FM) mode

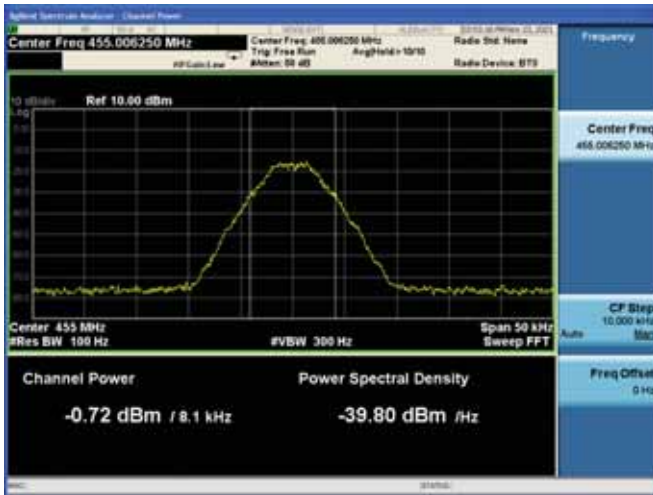

Input signal

Low Frequency: 455.00625MHz

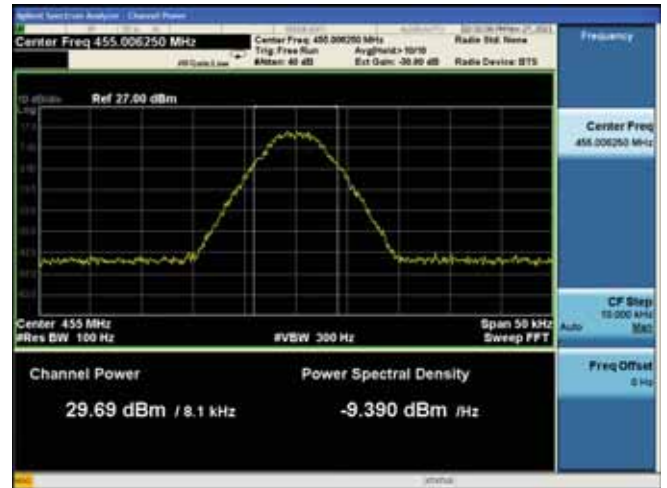

With the input signal amplitude set the AGC threshold

Low Frequency: 455.00625MHz

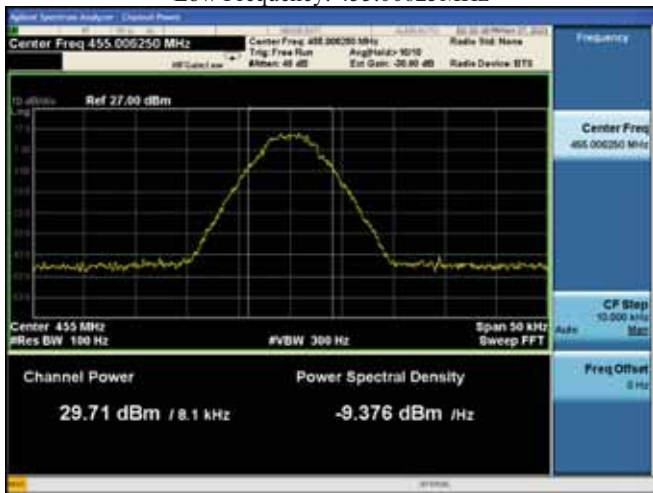

With the input signal amplitude set 3 dB above the AGC threshold

Low Frequency: 455.00625MHz

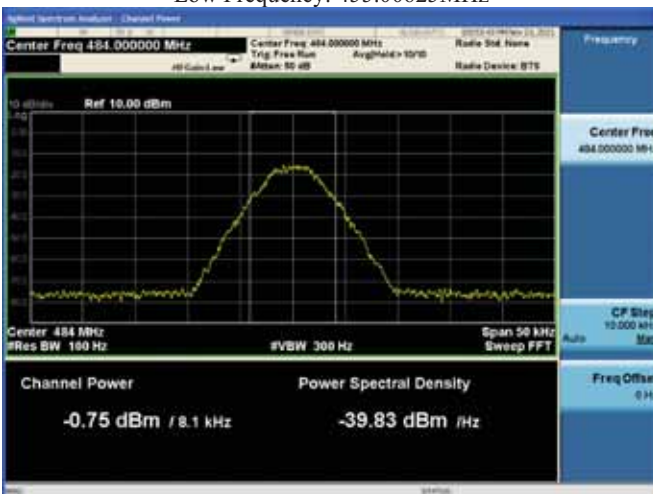

Input signal

Middle Frequency: 484.0MHz

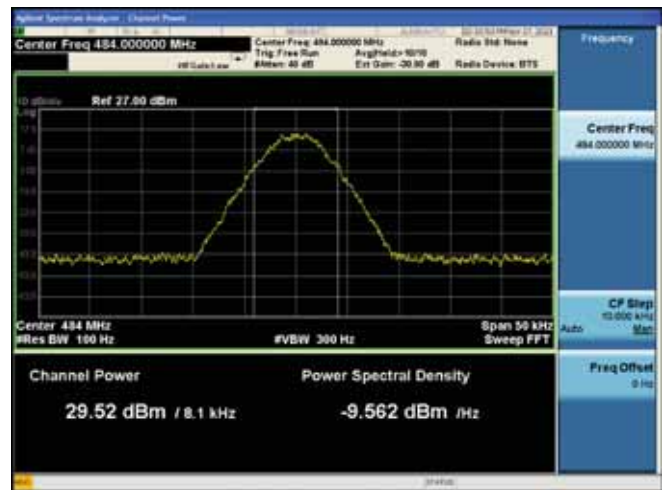

With the input signal amplitude set the AGC threshold

Middle Frequency: 484.0MHz

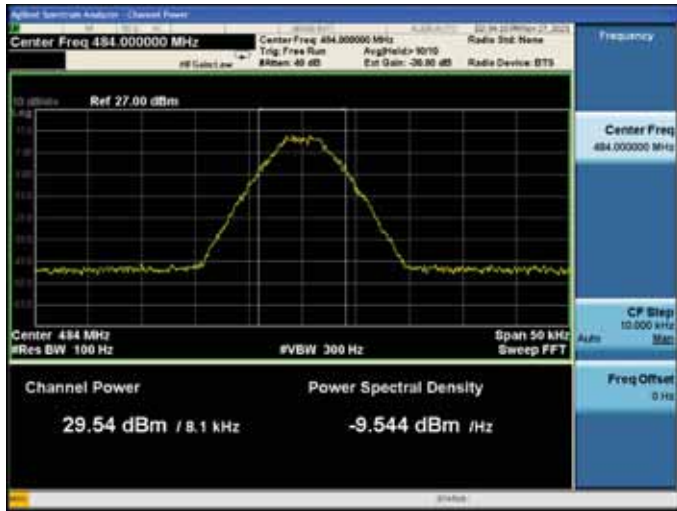

With the input signal amplitude set 3 dB above the AGC threshold  
Middle Frequency: 484.0MHz

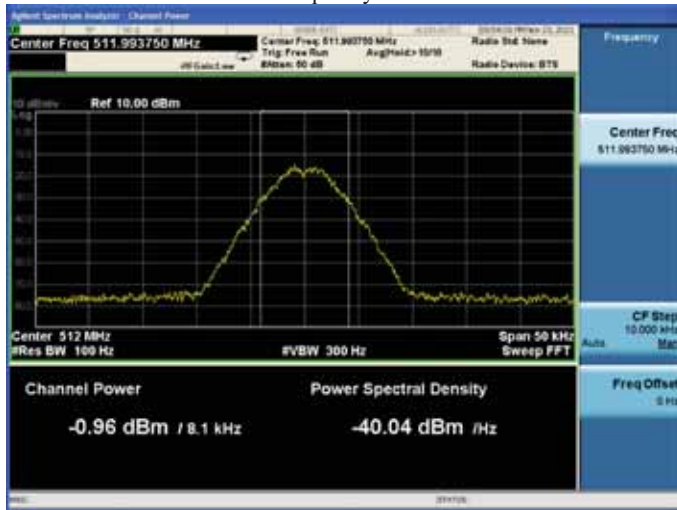

Input signal  
High Frequency: 511.99375MHz



With the input signal amplitude set the AGC threshold  
High Frequency: 511.99375MHz

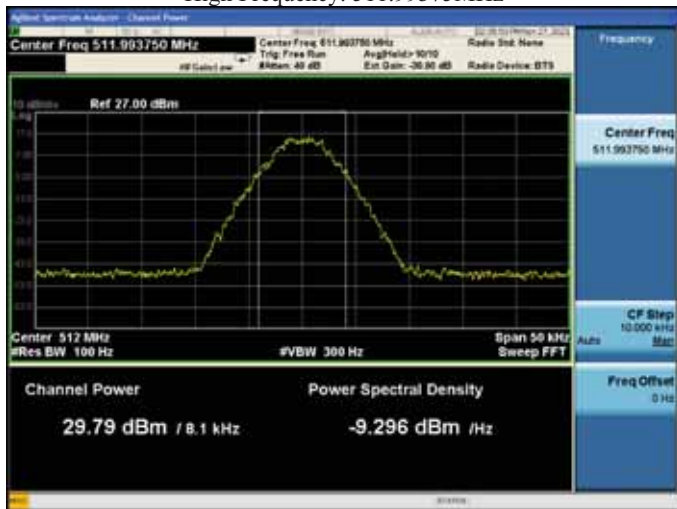

With the input signal amplitude set 3 dB above the AGC threshold  
High Frequency: 511.99375MHz



10.5.5.3.2.1.2. P25 Phase II(H-DQPSK) mode



Input signal  
 Low Frequency: 455.00625MHz

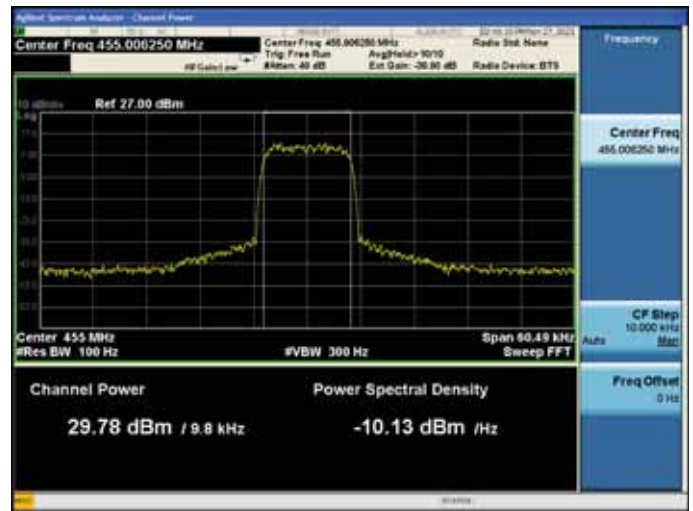

With the input signal amplitude set the AGC threshold  
 Low Frequency: 455.00625MHz

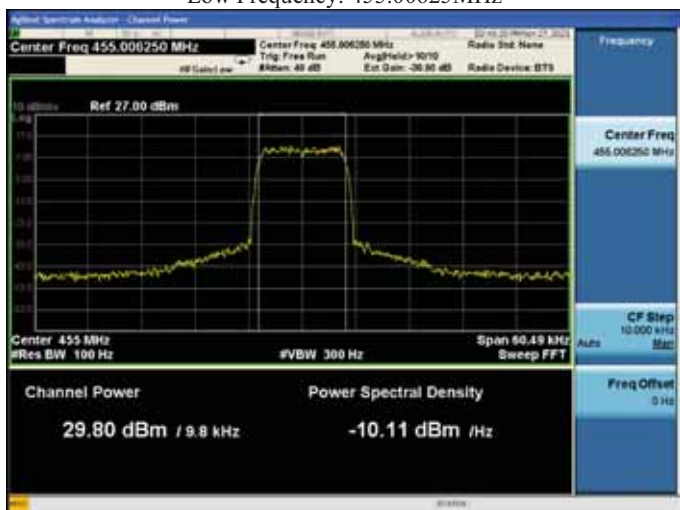

With the input signal amplitude set 3 dB above the AGC threshold  
 Low Frequency: 455.00625MHz



Input signal  
 Middle Frequency: 484.0MHz

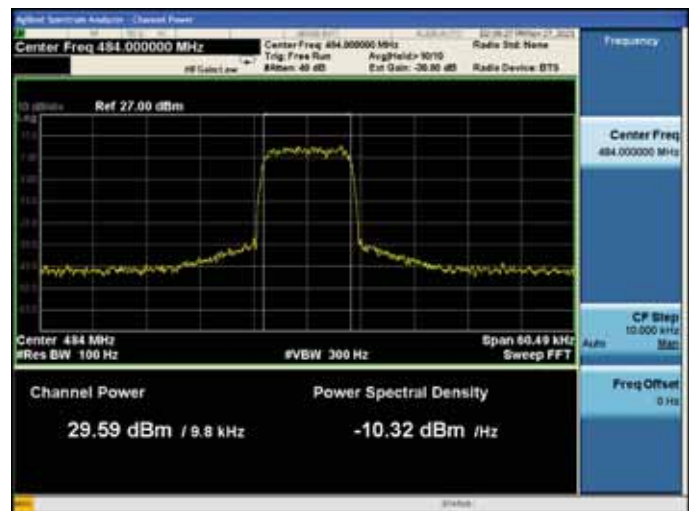

With the input signal amplitude set the AGC threshold  
 Middle Frequency: 484.0MHz

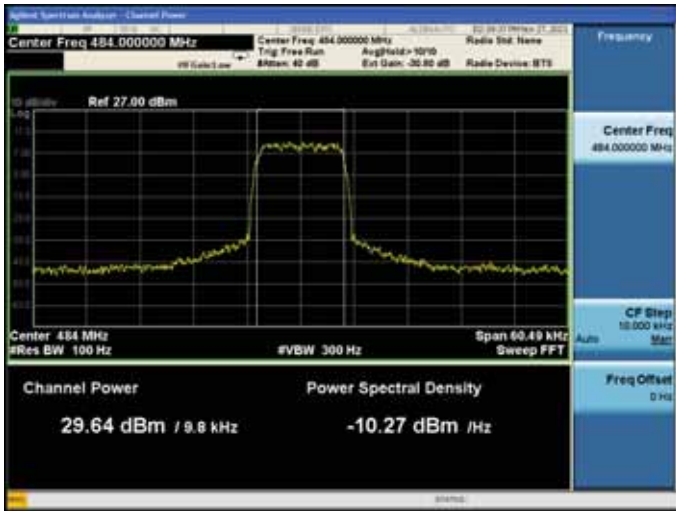

With the input signal amplitude set 3 dB above the AGC threshold  
 Middle Frequency: 484.0MHz

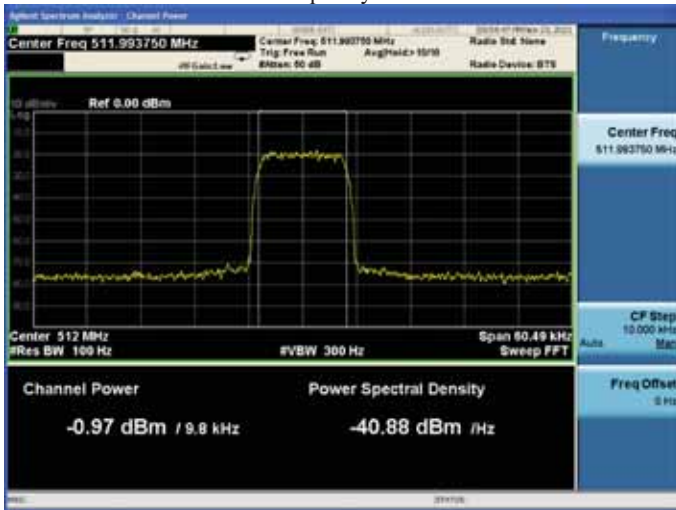

Input signal  
 High Frequency: 511.99375MHz

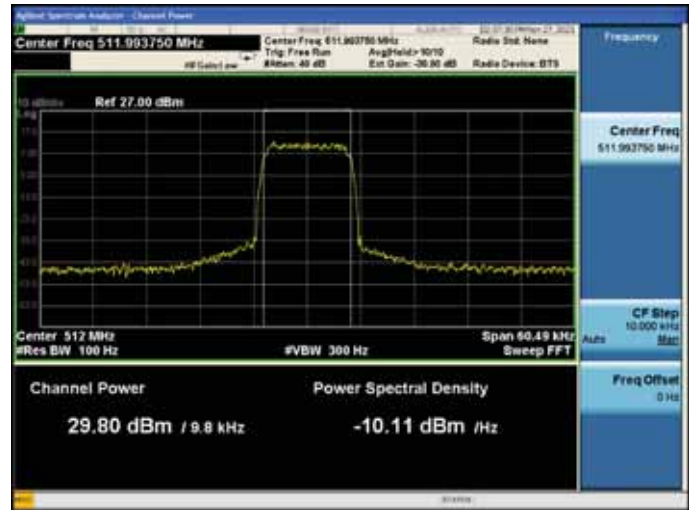

With the input signal amplitude set the AGC threshold  
 High Frequency: 511.99375MHz

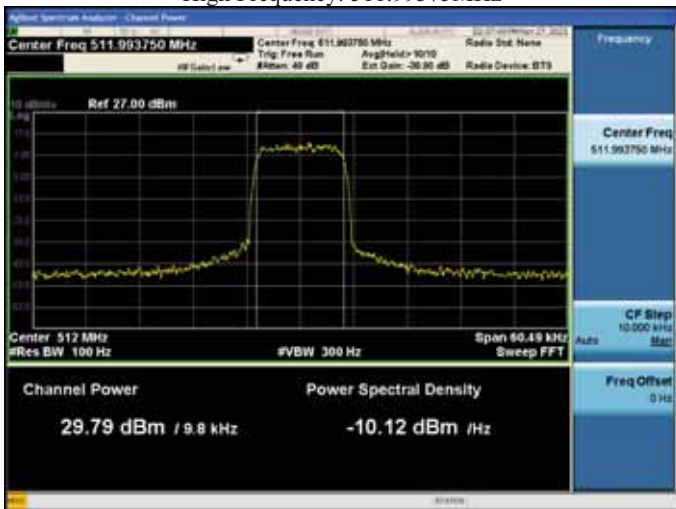

With the input signal amplitude set 3 dB above the AGC threshold  
 High Frequency: 511.99375MHz

10.5.5.3.2.1.3. 6.25kHz Analog FM mode

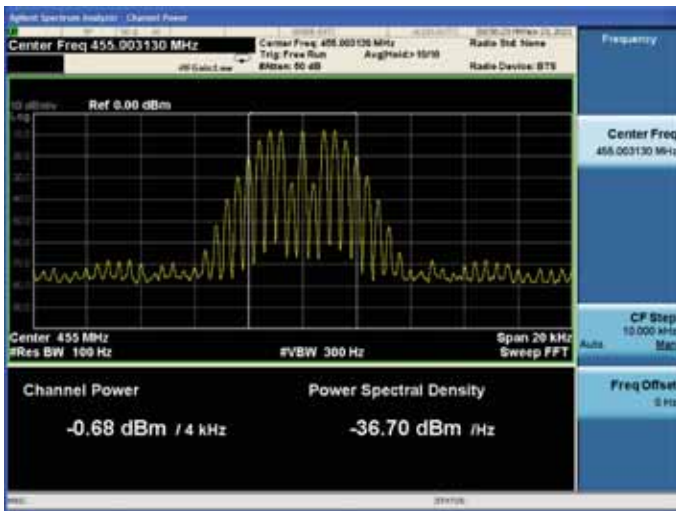

Input signal  
 Low Frequency: 455.00313MHz



With the input signal amplitude set the AGC threshold  
 Low Frequency: 455.00313MHz

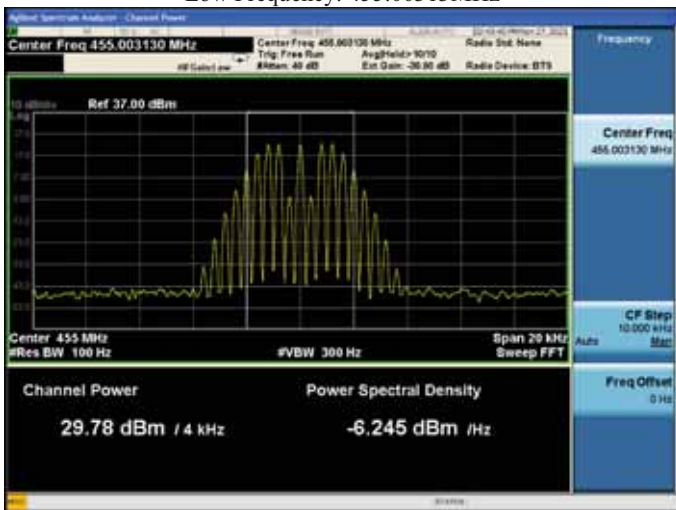

With the input signal amplitude set 3 dB above the AGC threshold  
 Low Frequency: 455.00313MHz

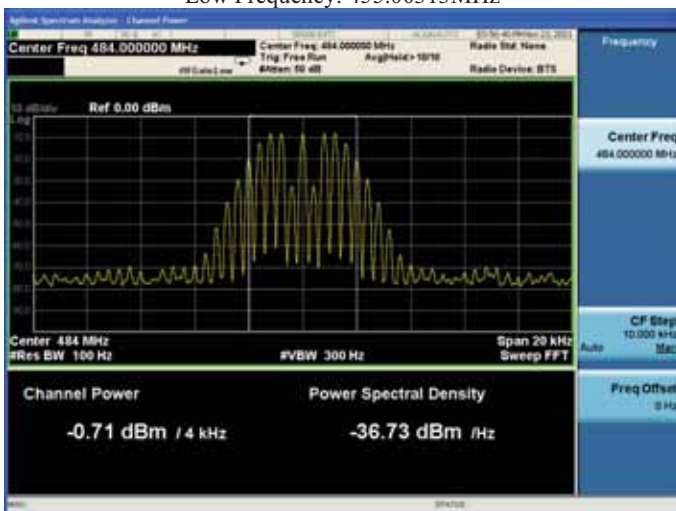

Input signal  
 Middle Frequency: 484.0MHz

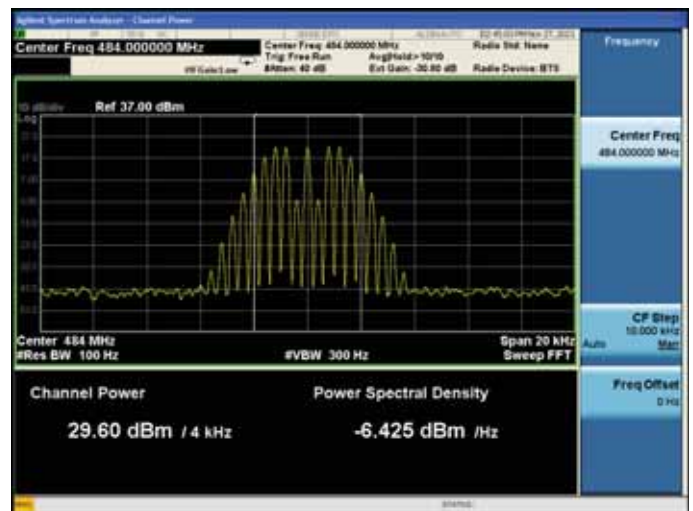

With the input signal amplitude set the AGC threshold  
 Middle Frequency: 484.0MHz



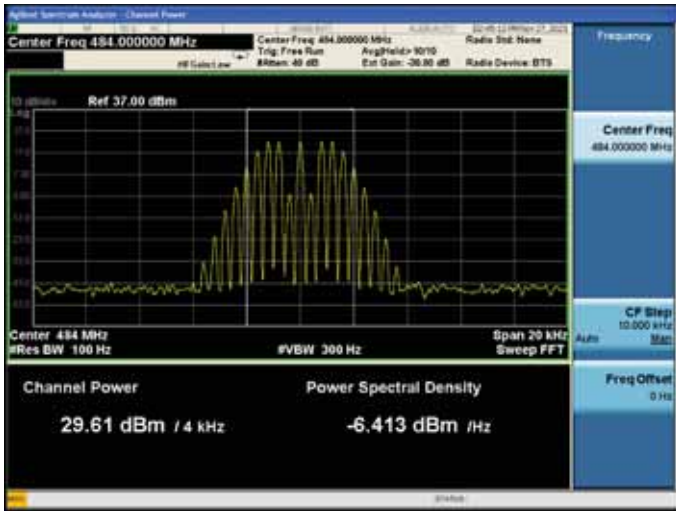

With the input signal amplitude set 3 dB above the AGC threshold  
Middle Frequency: 484.0MHz

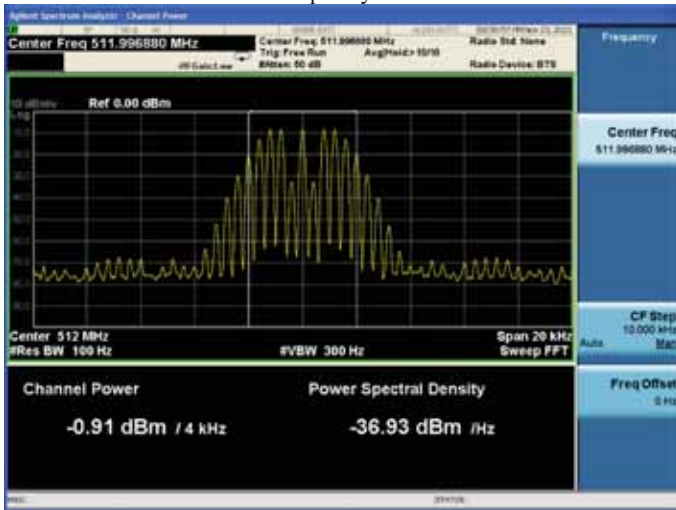

Input signal  
High Frequency: 511.99688MHz



With the input signal amplitude set the AGC threshold  
High Frequency: 511.99688MHz

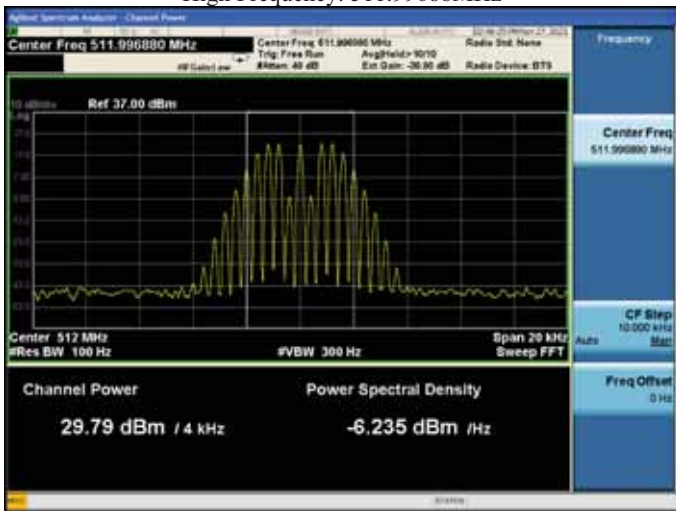

With the input signal amplitude set 3 dB above the AGC threshold  
High Frequency: 511.99688MHz

10.5.5.3.2.1.4. 12.5kHz Analog FM mode

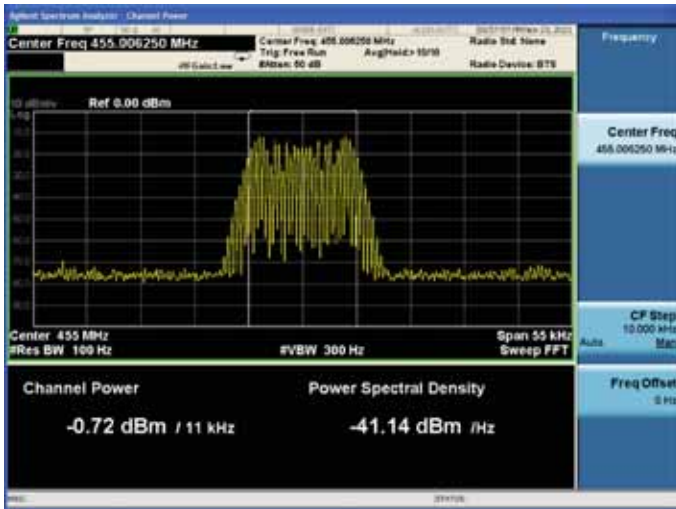

Input signal  
 Low Frequency: 455.00625MHz



With the input signal amplitude set the AGC threshold  
 Low Frequency: 455.00625MHz

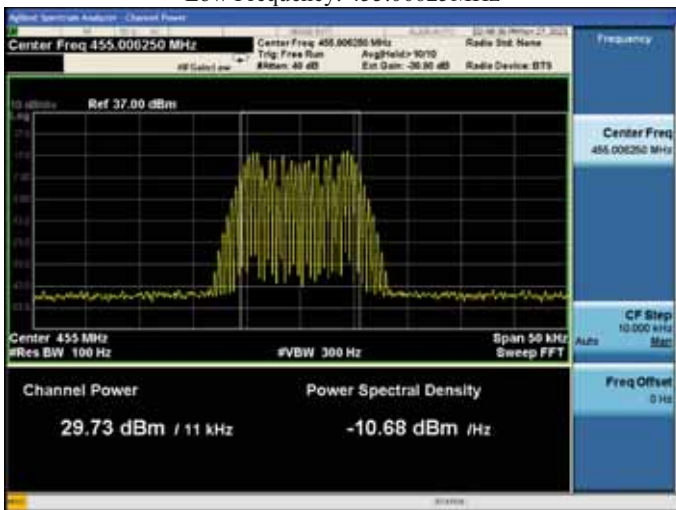

With the input signal amplitude set 3 dB above the AGC threshold  
 Low Frequency: 455.00625MHz



Input signal  
 Middle Frequency: 484.0MHz



With the input signal amplitude set the AGC threshold  
 Middle Frequency: 484.0MHz

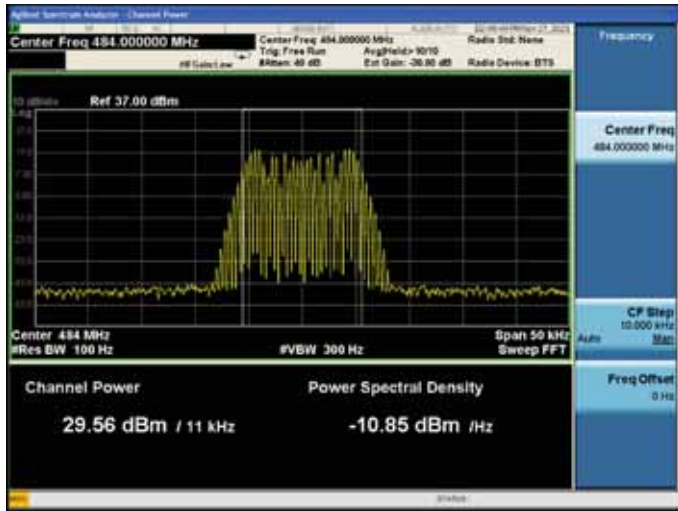

With the input signal amplitude set 3 dB above the AGC threshold  
Middle Frequency: 484.0MHz

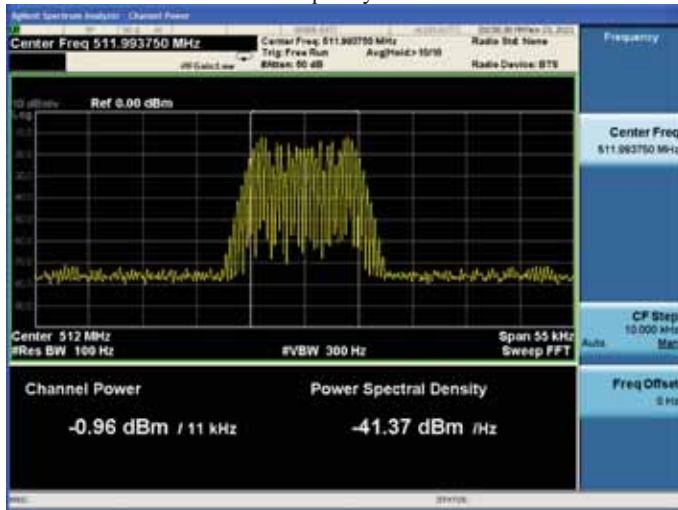

Input signal  
High Frequency: 511.99375MHz



With the input signal amplitude set the AGC threshold  
High Frequency: 511.99375MHz

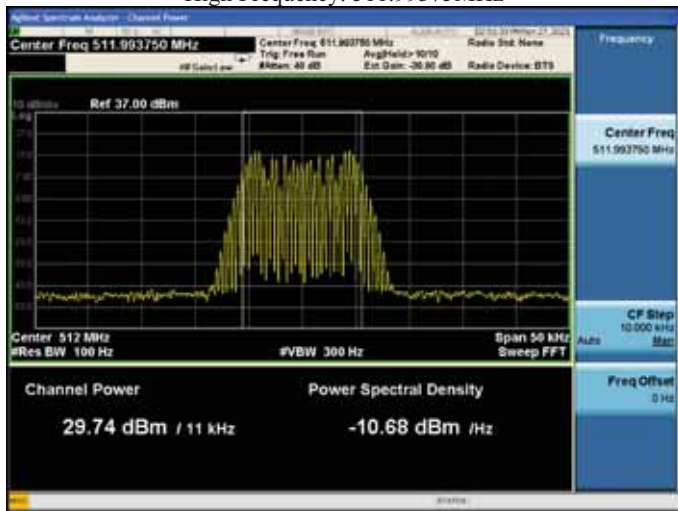

With the input signal amplitude set 3 dB above the AGC threshold  
High Frequency: 511.99375MHz



10.5.5.3.2.1.5. 25kHz Analog FM mode

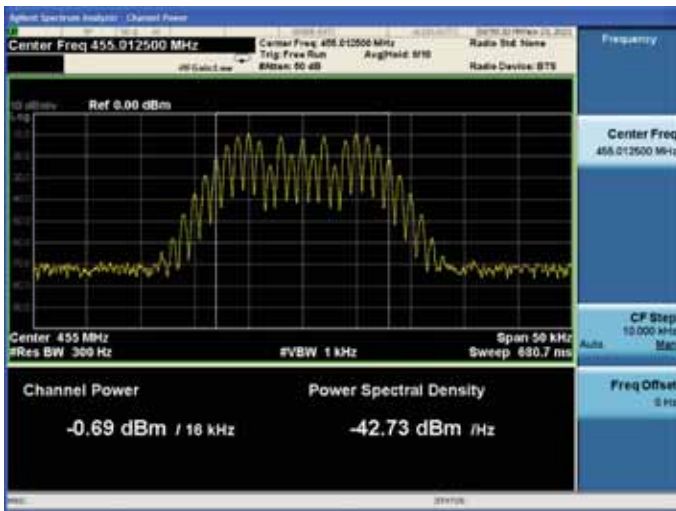

Input signal  
 Low Frequency: 455.0125MHz

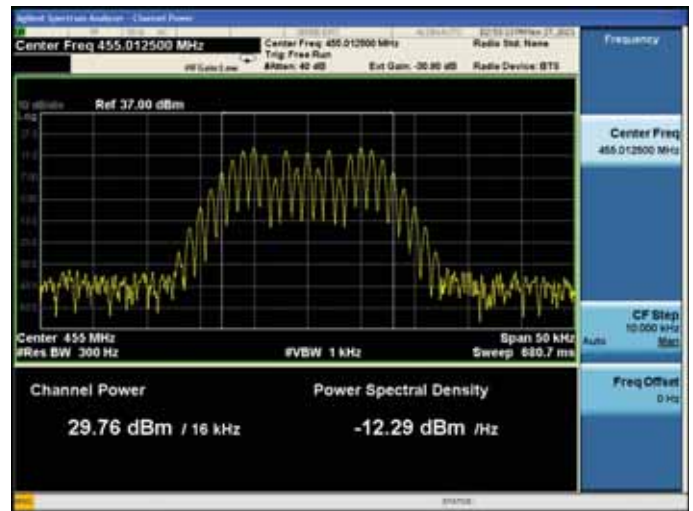

With the input signal amplitude set the AGC threshold  
 Low Frequency: 455.0125MHz

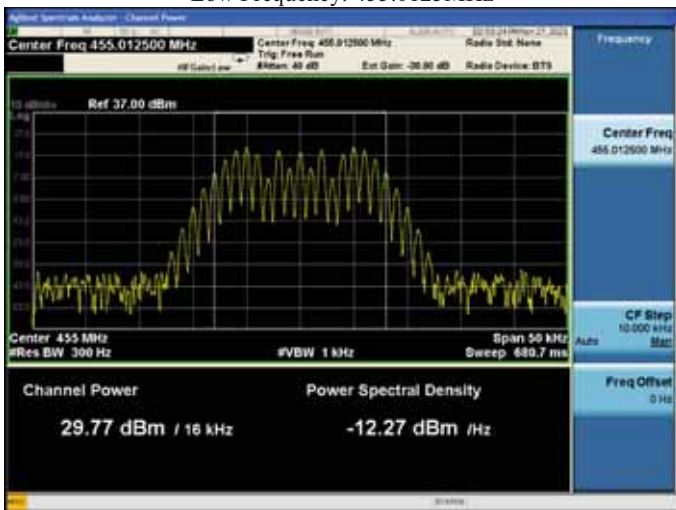

With the input signal amplitude set 3 dB above the AGC threshold  
 Low Frequency: 455.0125MHz

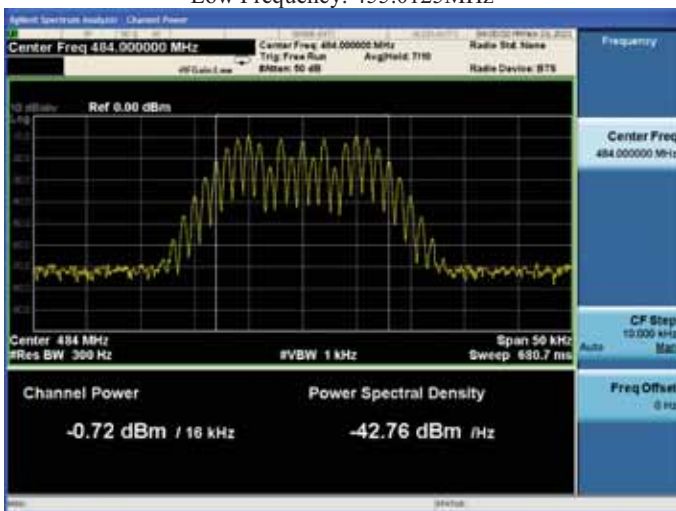

Input signal  
 Middle Frequency: 484.0MHz

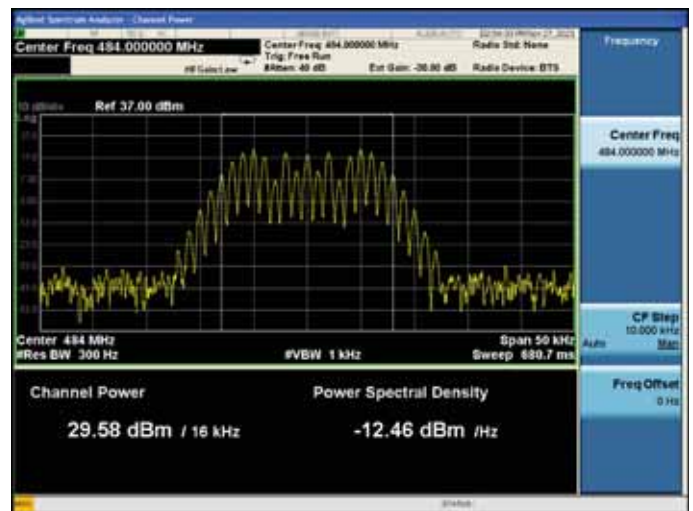

With the input signal amplitude set the AGC threshold  
 Middle Frequency: 484.0MHz



With the input signal amplitude set 3 dB above the AGC threshold  
Middle Frequency: 484.0MHz

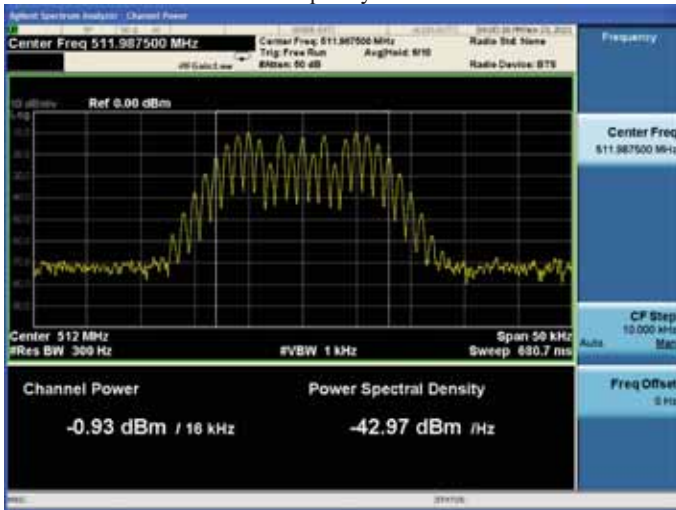

Input signal  
High Frequency: 511.9875MHz



With the input signal amplitude set the AGC threshold  
High Frequency: 511.9875MHz



With the input signal amplitude set 3 dB above the AGC threshold  
High Frequency: 511.9875MHz

### 10.6. Mean power and amplifier/booster gain

Test requirement: KDB 935210 D05 clause 4.5  
 FCC PART 90.219 (e)(1)  
 Test Method: KDB 935210 D05 clause 4.5

#### 10.6.1. Requirements

According to KDB 935210 D05 clause 4.5, the mean input and output power and the amplifier gain was measured by adjusting the internal gain control of the EUT to the maximum gain for which equipment certification is sought. Any EUT attenuation settings were set to their minimum value.

Input power levels (Downlink and Uplink) were set to maximum input ratings while confirming that the device is not capable of operating in saturation (Non-linear mode) at the rated input levels, including during the performance of the input/output power measurements.

FCC PART 90.219 (e)(1) requirement:

**(e) Device Specifications.** In addition to the general rules for equipment certification in §90.203(a)(2) and part 2, subpart J of this chapter, a signal booster must also meet the rules in this paragraph.

**(1) The output power capability of a signal booster must be designed for deployments providing a radiated power not exceeding 5 Watts ERP for each retransmitted channel.**

#### 10.6.2. Test configuration

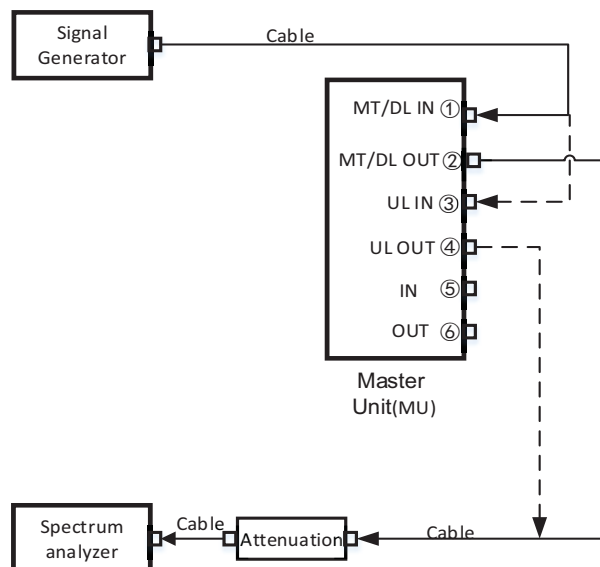

Figure 10.6-1 MU single device test connection diagram



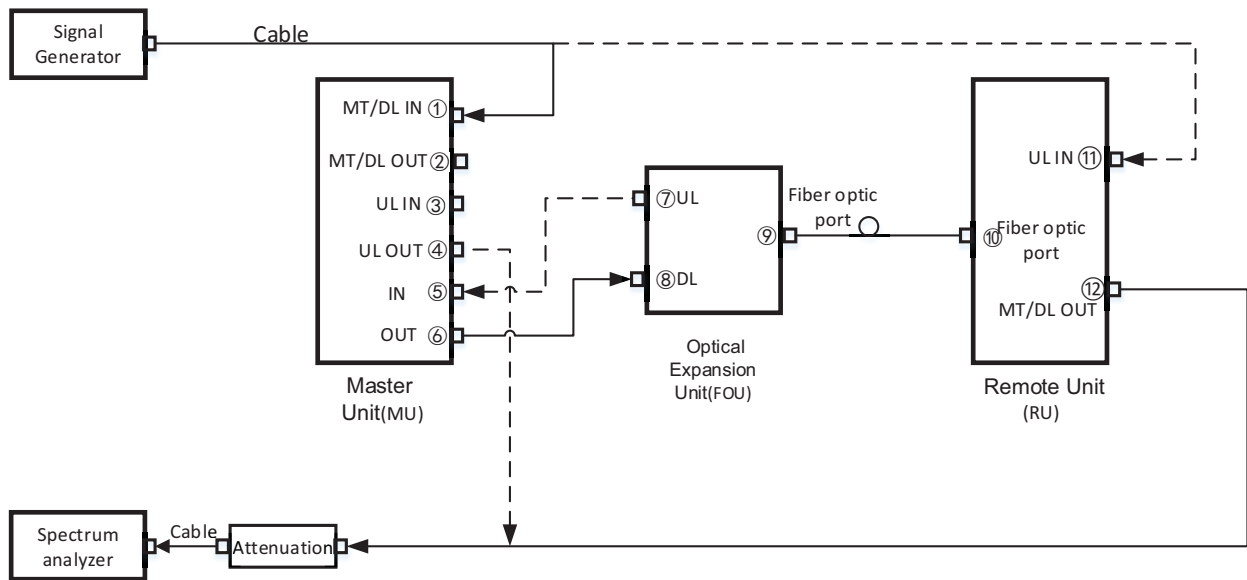

Figure 10.6-2 MU, FOU and RU system test connection diagram

### 10.6.3. Test procedures

- a) Connect a signal generator to the input of the EUT.
- b) Configure to generate the AWGN (broadband) test signal.
- c) The frequency of the signal generator shall be set to the frequency  $f_0$  as determined from 3.3.
- d) Connect a spectrum analyzer or power meter to the output of the EUT using appropriate attenuation as necessary.
- e) Set the signal generator output power to a level that produces an EUT output level that is just below the AGC threshold (see 3.2), but not more than 0.5 dB below.
- f) Measure and record the output power of the EUT; use 3.5.3 or 3.5.4 for power measurement.
- g) Remove the EUT from the measurement setup. Using the same signal generator settings, repeat the power measurement at the signal generator port, which was used as the input signal to the EUT, and record as the input power. EUT gain may be calculated as described in 3.5.5.
- h) Repeat steps f) and g) with input signal amplitude set to 3 dB above the AGC threshold level.
- i) Repeat steps e) to h) with the narrowband test signal.
- j) Repeat steps e) to i) for all frequency bands authorized for use by the EUT.

----- The following blanks -----

#### 10.6.4. Test results

Test Date (yy-mm-dd): 2021-11-27~11-29

Normal condition: Temp: 27.6~27.9°C, Humid:38~42%, Atmospheric Pressure:101kpa

Supply Voltage: DC -48V and AC 110V, 50Hz

##### 10.6.4.1. DC supply mode

##### 10.6.4.1.1. Mean power and gain

##### 10.6.4.1.1.1. MU single device test

Test link	Freq. (MHz)	Sig output power (dBm)	Input Cable Loss (dB)	Peak power (dBm)	Output Atten (dB)	Output Cable Loss (dB)	Output power (dBm)	Output power (W)	Gain (dB)
Down <sup>(1)</sup>	450.00313	-67.9	1.1	2.1	30	0.8	32.9	1.95	101.9
Down <sup>(2)</sup>	450.00313	-64.9	1.1	2.1	30	0.8	32.9	1.95	98.9
Down <sup>(1)</sup>	479.0	-68.0	1.1	5.0	30	0.8	35.8	3.80	104.9
Down <sup>(2)</sup>	479.0	-65.0	1.1	5.0	30	0.8	35.8	3.80	101.9
Down <sup>(1)</sup>	508.99688	-67.3	1.1	4.9	30	0.8	35.7	3.72	104.1
Down <sup>(2)</sup>	508.99688	-64.3	1.1	4.9	30	0.8	35.7	3.72	101.1
Up <sup>(1)</sup>	455.00313	-71.0	1.1	-0.9	30	0.8	29.9	0.98	102
Up <sup>(2)</sup>	455.00313	-68.0	1.1	-0.9	30	0.8	29.9	0.98	99
Up <sup>(1)</sup>	484.0	-72.4	1.1	-1.0	30	0.8	29.8	0.95	103.3
Up <sup>(2)</sup>	484.0	-69.4	1.1	-1.0	30	0.8	29.8	0.95	100.3
Up <sup>(1)</sup>	511.99688	-69.8	1.1	-1.2	30	0.8	29.6	0.91	100.5
Up <sup>(2)</sup>	511.99688	-66.8	1.1	-1.2	30	0.8	29.6	0.91	97.5

NOTE 1: <sup>(1)</sup> Level is 0.5 dB below AGC threshold; <sup>(2)</sup> Level is 3dB above AGC threshold.

NOTE 2: The modulation mode with the largest output power is selected as a typical representative to record the data, the downlink/uplink modulation mode is 6.25kHz Analog FM mode.

##### 10.6.4.1.1.2. System test

Test link	Freq. (MHz)	Sig output power (dBm)	Input Cable Loss (dB)	Peak power (dBm)	Output Atten (dB)	Output Cable Loss (dB)	Output power (dBm)	Output power (W)	Gain (dB)
Up <sup>(1)</sup>	455.00313	-70.9	1.1	-1.0	30	0.8	29.8	0.95	101.8
Up <sup>(2)</sup>	455.00313	-67.9	1.1	-1.0	30	0.8	29.8	0.95	98.8
Up <sup>(1)</sup>	484.0	-73.5	1.1	-1.2	30	0.8	29.6	0.91	104.2
Up <sup>(2)</sup>	484.0	-70.5	1.1	-1.2	30	0.8	29.6	0.91	101.2

Up <sup>(1)</sup>	511.99688	-70.4	1.1	-1.0	30	0.8	29.8	0.95	101.3
Up <sup>(2)</sup>	511.99688	-67.4	1.1	-1.0	30	0.8	29.8	0.95	98.3

NOTE 1: <sup>(1)</sup> Level is 0.5 dB below AGC threshold; <sup>(2)</sup> Level is 3dB above AGC threshold.

NOTE 2: The modulation mode with the largest output power is selected as a typical representative to record the data, the uplink modulation mode is 6.25kHz Analog FM mode.

----- **The following blanks** -----



## 10.6.4.1.2. ERP Calculations

## 10.6.4.1.2.1. MU single device test

Test link	Freq. (MHz)	EUT Max. output power (dBm)	Max. Ant Gain(dBi)	Duty Cycle (%)	ERP (W)	ERP Limit (W)	AGC Mode
Down	450.00313	32.9	0	100	1.95	5	-0.5dB Below
	450.00313	32.9	0	100	1.95	5	+3.0dB above
	479.0	35.8	0	100	3.80	5	-0.5dB Below
	479.0	35.8	0	100	3.80	5	+3.0dB above
	508.99688	35.7	0	100	3.72	5	-0.5dB Below
	508.99688	35.7	0	100	3.72	5	+3.0dB above
Up	455.00313	29.9	0	100	0.98	5	-0.5dB Below
	455.00313	29.9	0	100	0.98	5	+3.0dB above
	484.0	29.8	0	100	0.95	5	-0.5dB Below
	484.0	29.8	0	100	0.95	5	+3.0dB above
	511.99688	29.6	0	100	0.91	5	-0.5dB Below
	511.99688	29.6	0	100	0.91	5	+3.0dB above

NOTE: The maximum external antenna gain is 0dbi by manufacturer declares.

## 10.6.4.1.2.2. System test

Test link	Freq. (MHz)	EUT Max. output power (dBm)	Max. Ant Gain(dBi)	Duty Cycle (%)	ERP (W)	ERP Limit (W)	AGC Mode
Up	455.00313	29.8	0	100	0.95	5	-0.5dB Below
	455.00313	29.8	0	100	0.95	5	+3.0dB above
	484.0	29.6	0	100	0.91	5	-0.5dB Below
	484.0	29.6	0	100	0.91	5	+3.0dB above
	511.99688	29.8	0	100	0.95	5	-0.5dB Below
	511.99688	29.8	0	100	0.95	5	+3.0dB above

NOTE: The maximum external antenna gain is 0dbi by manufacturer declares.

## 10.6.4.2.AC supply mode

## 10.6.4.2.1. Mean power and gain

## 10.6.4.2.1.1. MU single device test

Test link	Freq. (MHz)	Sig output power (dBm)	Input Cable Loss (dB)	Peak power (dBm)	Output Atten (dB)	Output Cable Loss (dB)	Output power (dBm)	Output power (W)	Gain (dB)
Down <sup>(1)</sup>	450.00313	-67.1	1.1	2.3	30	0.8	33.1	2.04	101.3
Down <sup>(2)</sup>	450.00313	-64.1	1.1	2.3	30	0.8	33.1	2.04	98.3
Down <sup>(1)</sup>	479.0	-68.7	1.1	4.8	30	0.8	35.6	3.63	105.4
Down <sup>(2)</sup>	479.0	-65.7	1.1	4.8	30	0.8	35.6	3.63	102.4
Down <sup>(1)</sup>	508.99688	-67.1	1.1	4.5	30	0.8	35.3	3.39	103.5
Down <sup>(2)</sup>	508.99688	-64.1	1.1	4.5	30	0.8	35.3	3.39	100.5
Up <sup>(1)</sup>	455.00313	-69.6	1.1	-1.1	30	0.8	29.7	0.93	100.4
Up <sup>(2)</sup>	455.00313	-66.6	1.1	-1.1	30	0.8	29.7	0.93	97.4
Up <sup>(1)</sup>	484.0	-72.6	1.1	-0.9	30	0.8	29.9	0.98	103.6
Up <sup>(2)</sup>	484.0	-69.6	1.1	-0.9	30	0.8	29.9	0.98	100.6
Up <sup>(1)</sup>	511.99688	-69.1	1.1	-0.8	30	0.8	30.0	1.00	100.2
Up <sup>(2)</sup>	511.99688	-66.1	1.1	-0.7	30	0.8	30.1	1.02	97.3

NOTE 1: <sup>(1)</sup> Level is 0.5 dB below AGC threshold; <sup>(2)</sup> Level is 3dB above AGC threshold.

NOTE 2: The modulation mode with the largest output power is selected as a typical representative to record the data, the downlink/uplink modulation mode is 6.25kHz Analog FM mode.

## 10.6.4.2.1.2. System test

Test link	Freq. (MHz)	Sig output power (dBm)	Input Cable Loss (dB)	Peak power (dBm)	Output Atten (dB)	Output Cable Loss (dB)	Output power (dBm)	Output power (W)	Gain (dB)
Up <sup>(1)</sup>	455.00313	-71.5	1.1	-1.0	30	0.8	29.8	0.95	102.4
Up <sup>(2)</sup>	455.00313	-68.5	1.1	-1.0	30	0.8	29.8	0.95	99.4
Up <sup>(1)</sup>	484.0	-73.8	1.1	-1.2	30	0.8	29.6	0.91	104.5
Up <sup>(2)</sup>	484.0	-70.8	1.1	-1.2	30	0.8	29.6	0.91	101.5
Up <sup>(1)</sup>	511.99688	-70.6	1.1	-1.0	30	0.8	29.8	0.95	101.5
Up <sup>(2)</sup>	511.99688	-67.6	1.1	-1.0	30	0.8	29.8	0.95	98.5

NOTE 1: <sup>(1)</sup> Level is 0.5 dB below AGC threshold; <sup>(2)</sup> Level is 3dB above AGC threshold.

NOTE 2: The modulation mode with the largest output power is selected as a typical representative to record the data, the uplink modulation mode is 6.25kHz Analog FM mode.

## 10.6.4.2.2. ERP Calculations

## 10.6.4.2.2.1. MU single device test

Test link	Freq. (MHz)	EUT Max. output power (dBm)	Max. Ant Gain(dBi)	Duty Cycle (%)	ERP (W)	ERP Limit (W)	AGC Mode
Down	450.00313	33.1	0	100	2.04	5	-0.5dB Below
	450.00313	33.1	0	100	2.04	5	+3.0dB above
	479.0	35.6	0	100	3.63	5	-0.5dB Below
	479.0	35.6	0	100	3.63	5	+3.0dB above
	508.99688	35.3	0	100	3.39	5	-0.5dB Below
	508.99688	35.3	0	100	3.39	5	+3.0dB above
Up	455.00313	29.7	0	100	0.93	5	-0.5dB Below
	455.00313	29.7	0	100	0.93	5	+3.0dB above
	484.0	29.9	0	100	0.98	5	-0.5dB Below
	484.0	29.9	0	100	0.98	5	+3.0dB above
	511.99688	30.0	0	100	1.00	5	-0.5dB Below
	511.99688	30.1	0	100	1.02	5	+3.0dB above

NOTE: The maximum external antenna gain is 0dBi by manufacturer declares.

## 10.6.4.2.2.2. System test

Test link	Freq. (MHz)	EUT Max. output power (dBm)	Max. Ant Gain(dBi)	Duty Cycle (%)	ERP (W)	ERP Limit (W)	AGC Mode
Up	455.00313	29.8	0	100	0.95	5	-0.5dB Below
	455.00313	29.8	0	100	0.95	5	+3.0dB above
	484.0	29.6	0	100	0.91	5	-0.5dB Below
	484.0	29.6	0	100	0.91	5	+3.0dB above
	511.99688	29.8	0	100	0.95	5	-0.5dB Below
	511.99688	29.8	0	100	0.95	5	+3.0dB above

NOTE: The maximum external antenna gain is 0dBi by manufacturer declares.

10.7. Noise figure

Test requirement: KDB 935210 D05 clause 4.6  
 FCC PART 90.219 (e)(2)  
 Test Method: KDB 935210 D05/4.6

10.7.1. Requirements

According to FCC PART 90 §90.219 (e) (2) requirement, the noise figure limit of a signal booster must be given in table 10.7-1.

Table 10.7-1 Noise figure limits

frequency range(MHz)	Max. Noise figure limit(dB)
450~512	9

10.7.2. Test configuration

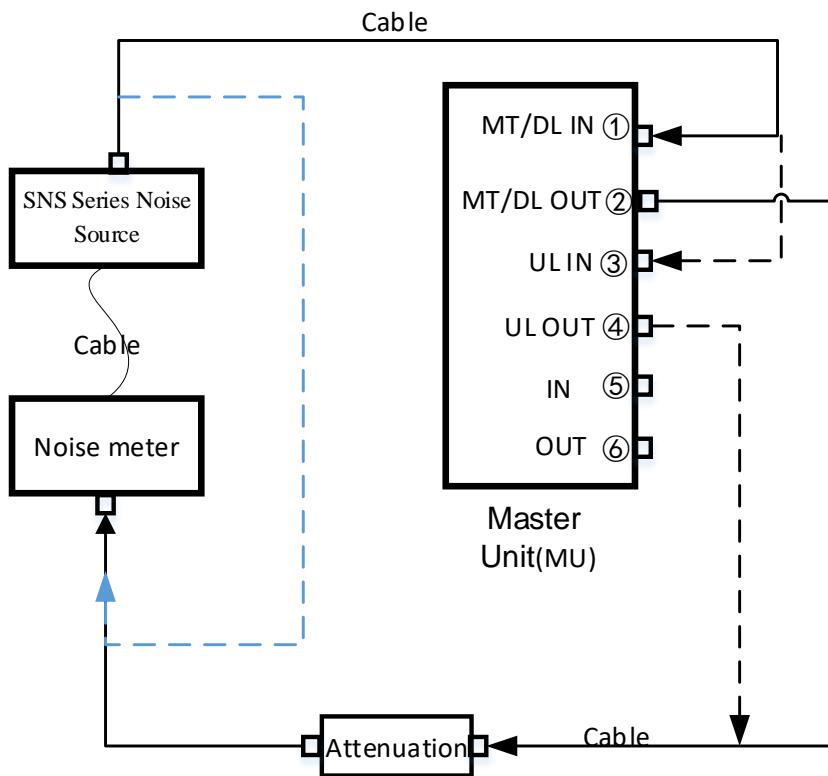

Figure 10.7-1 MU Single device test connection diagram

NOTE: The green dotted line is the instrument calibration path.



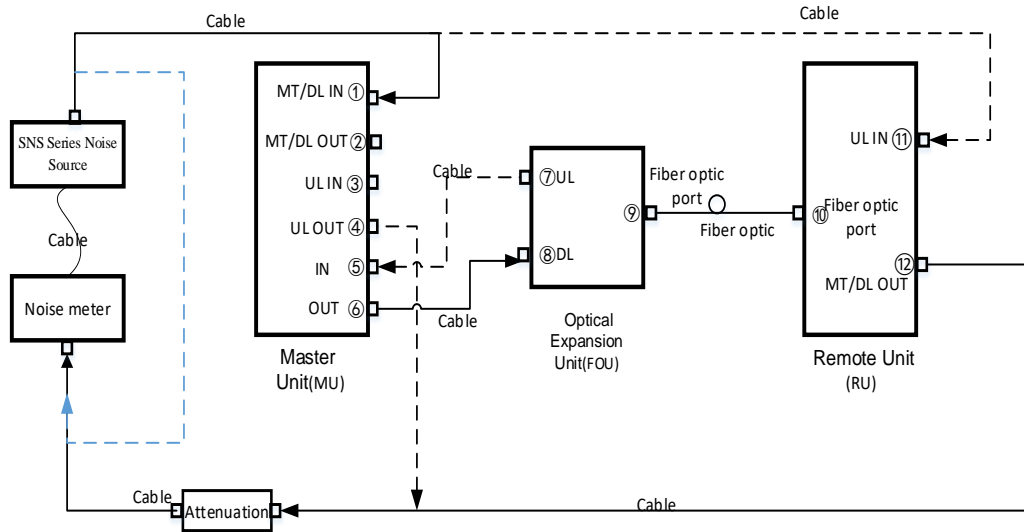

Figure 10.7-2MU, FOU and RU system test diagram

NOTE: The green dotted line is the instrument calibration path.

### 10.7.3. Test procedures

- (1) Connect the device as illustrated Figure, when the output power is over the maximum value of the Noise meter, add the attenuator to avoid destroying;
- (2) Set the EUT operating band and maximum gain;
- (3) Set the relevant parameters for 400MHz of device and connect the dotted line to calibrate;
- (4) After calibrating, according to the solid line connecting and testing Noise figure and record data;
- (5) Repeat RF Low, middle and high frequency to be tested and Repeat steps (2) to (4);

----- The following blanks -----

## 10.7.4. Test results

Test Date (yy-mm-dd): 2021-11-25

Normal condition: Temp: 27.3°C, Humid: 36%, Atmospheric Pressure:101kpa

Supply Voltage: DC -48V

## 10.7.4.1.MU single device test

Test link	Test frequency (MHz)	Max. Limit (dB)	Noise figure data(dB)	Margin (dB)	Result
Downlink	Low frequency range	9	1.60	7.40	PASS
	Middle frequency range		1.66	7.34	PASS
	High frequency range		2.09	6.91	PASS
Uplink	Low frequency range	9	3.95	5.05	PASS
	Middle frequency range		3.91	5.09	PASS
	High frequency range		5.69	3.31	PASS
NOTE 1: Margin= specification limit - Noise figure data.					
NOTE 2: The widest frequency range is 10MHz.					

## 10.7.4.2.System test

Test link	Test frequency (MHz)	Max. Limit (dB)	Noise figure data(dB)	Margin (dB)	Result
Uplink	Low frequency range	9	4.97	4.03	PASS
	Middle frequency range		4.78	4.22	PASS
	High frequency range		4.57	4.43	PASS
NOTE 1: Margin= specification limit - Noise figure data.					
NOTE 2: The widest frequency range is 10MHz.					

10.7.5. Test screenshot

10.7.5.1.MU single device test

10.7.5.1.1. Downlink

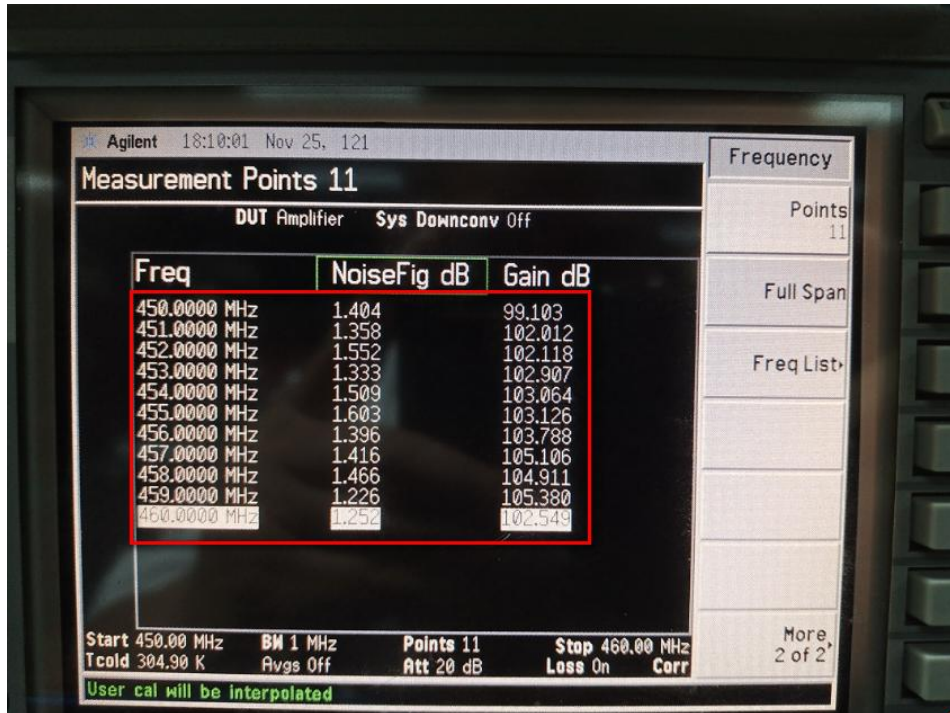

Low frequency range

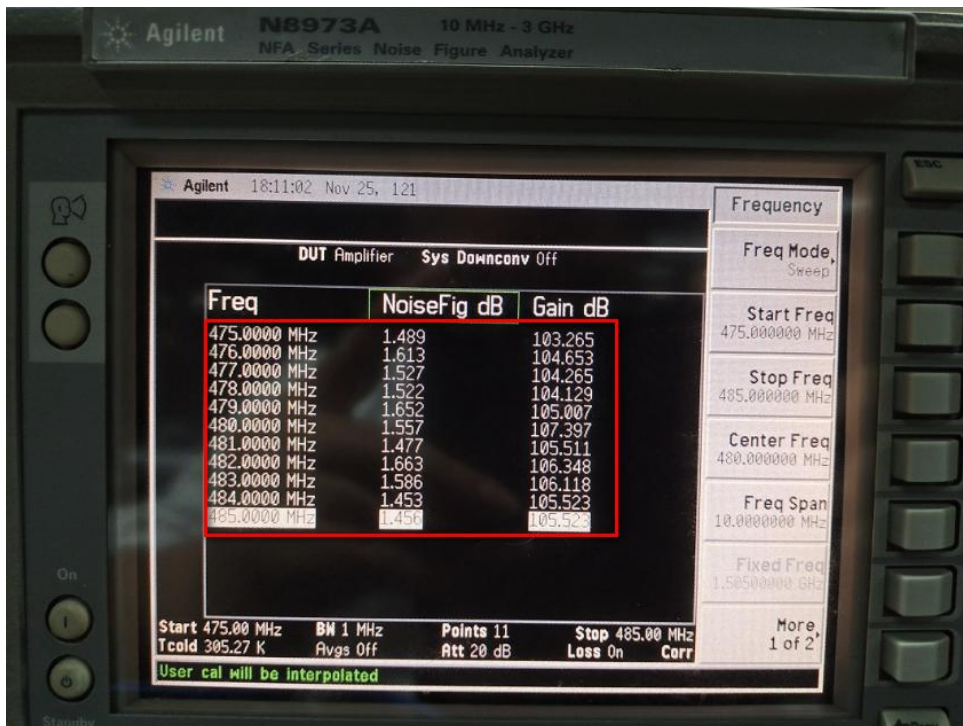

Middle frequency range

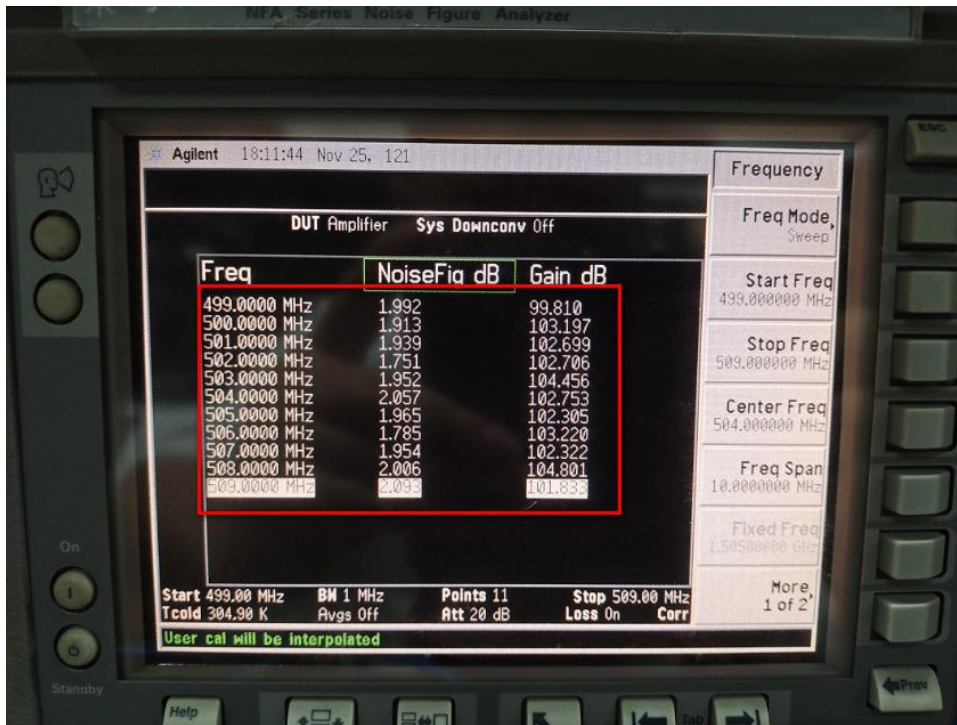

High frequencyrange

10.7.5.1.2. Uplink



Low frequency range





Middle frequency range

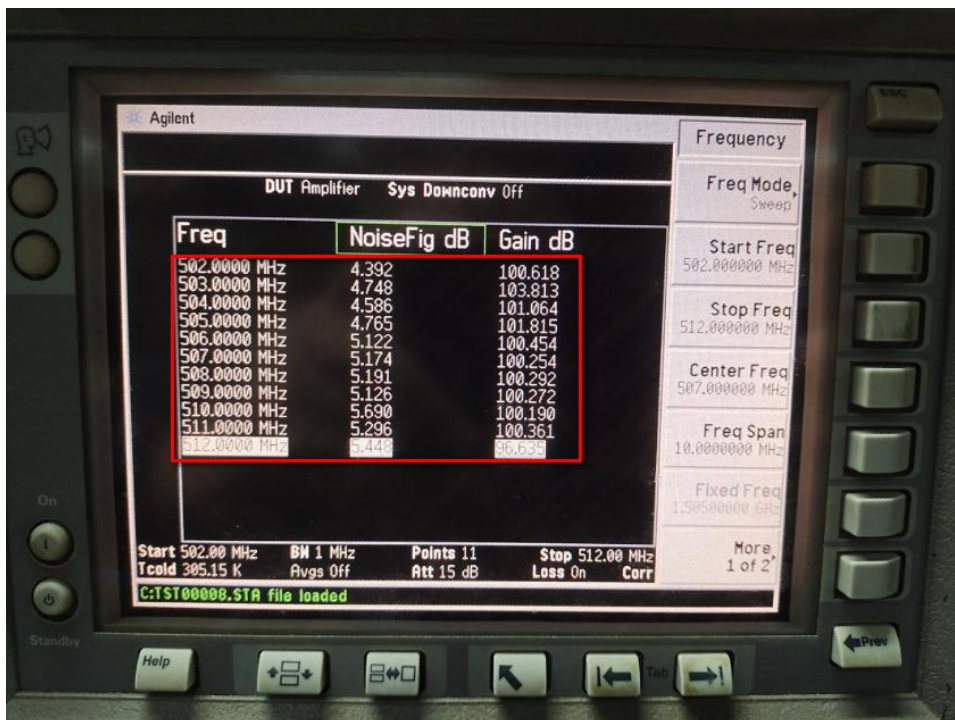

High frequency range

10.7.5.2. System test

10.7.5.2.1. Uplink

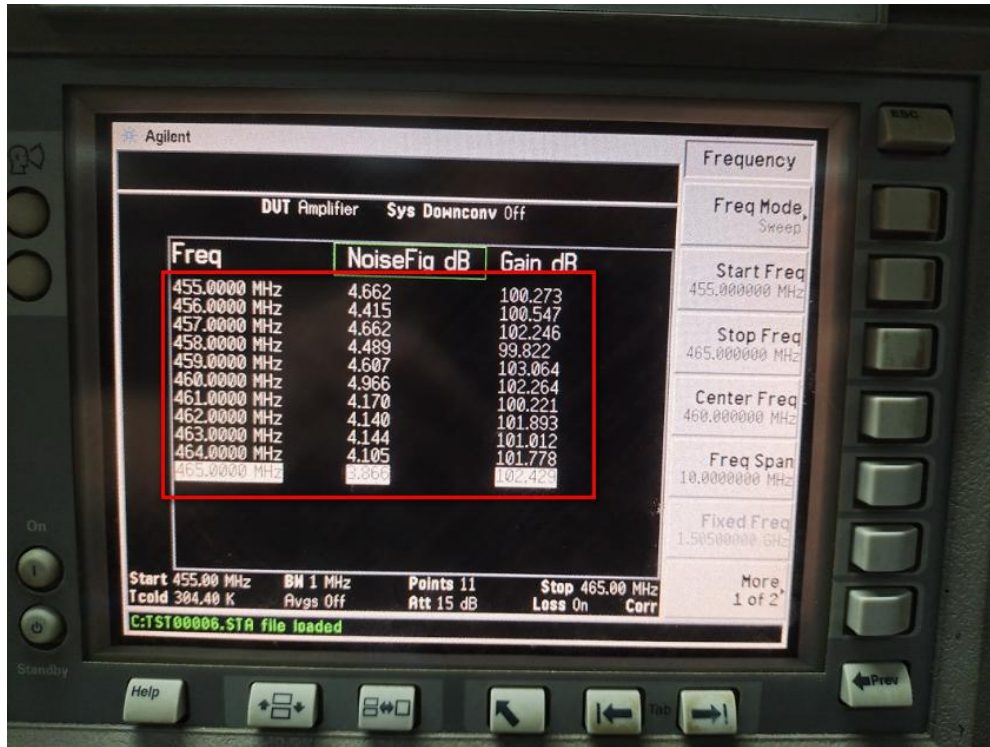

Low frequency range

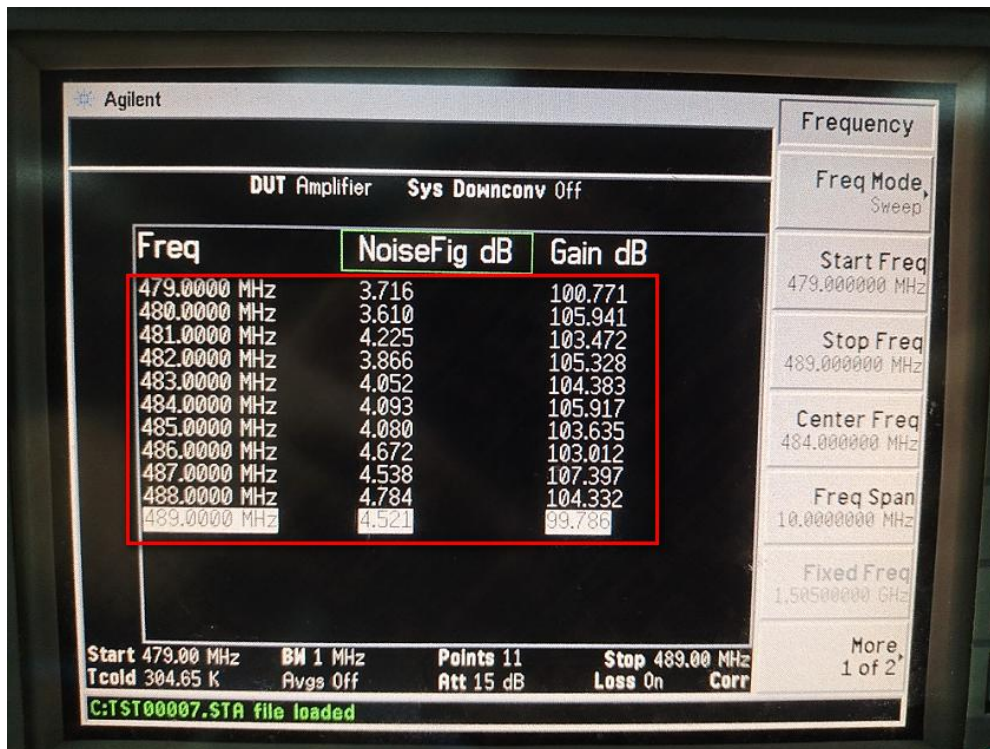

Middle frequency range

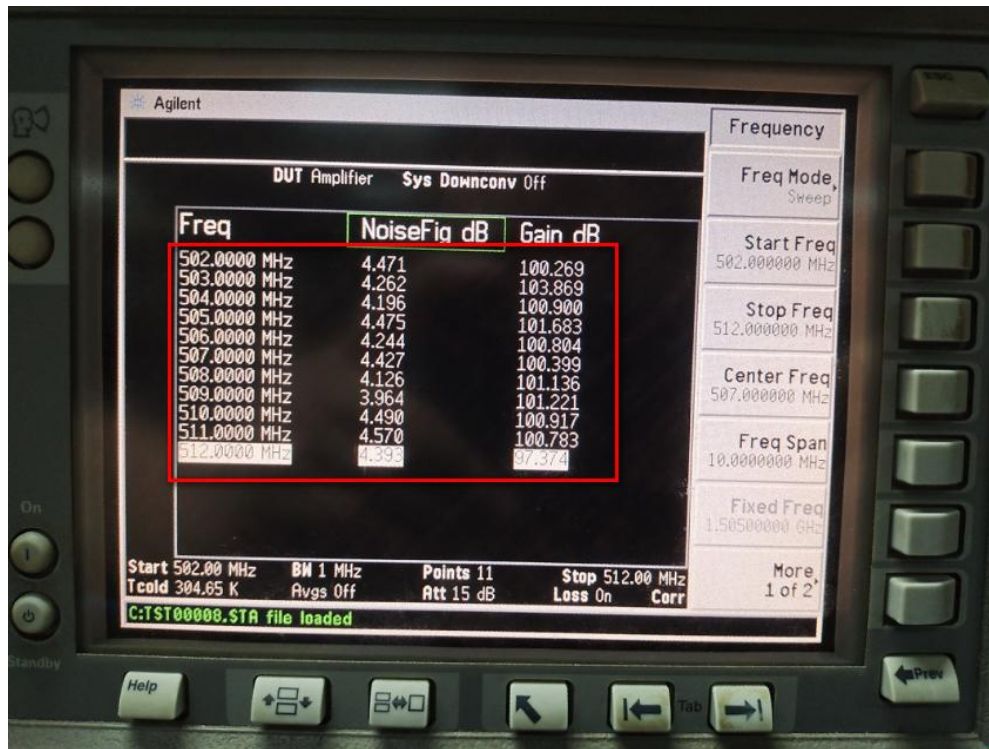

High frequency range



## 10.8. Out-of-band/out-of-block emissions

Test requirement: KDB 935210 D05 clause 4.7.2  
FCC PART 2.1051  
FCC PART 90.219 (d)(6)(i)  
FCC PART 90.219 (e)(3)

Test Method: KDB 935210 D05/4.7.1 and 4.7.2

### 10.8.1. Requirements

The EUT shall comply with sections 4.7.2 of KDB 935210 D05.

Refer to the applicable rule part(s) for specified limits on unwanted (out-of-band/out-of-block and spurious) emissions (e.g., Section 90.210).

Spurious emissions shall be measured using a single test signal sequentially tuned to the low, middle, and high channels or frequencies within each authorized frequency band of operation.

Intermodulation products shall be measured using two CW signals with all available channel spacings (e.g., 12.5 kHz and 6.25 kHz) with the center between these channels being equal to the center frequency  $f_0$  as determined from 4.3.

NOTE—Intermodulation-product spurious emission measurements are not required for single-channel boosters that cannot accommodate two simultaneous signals within the passband.

For a multi-channel enhancer, any intermodulation product level must be attenuated, relative to P, by at least:  $43 + 10 \cdot \log_{10} P$  is less stringent than 70dB, that limit was used.

Spurious emissions shall be measured using a single test signal sequentially tuned to the low, middle, and high channels or frequencies within each authorized frequency band of operation.

Out-of-band/out-of-block emissions (including intermodulation products) shall be measured under each of the following two stimulus conditions:

- a) two adjacent test signals sequentially tuned to the lower and upper frequency band/block edges;
- b) a single test signal, sequentially tuned to the lowest and highest frequencies or channels within the frequency band/block under examination.

NOTE—Single-channel boosters that cannot accommodate two simultaneous signals within the passband may be excluded from the test stipulated in step a).



10.8.2. Test configuration

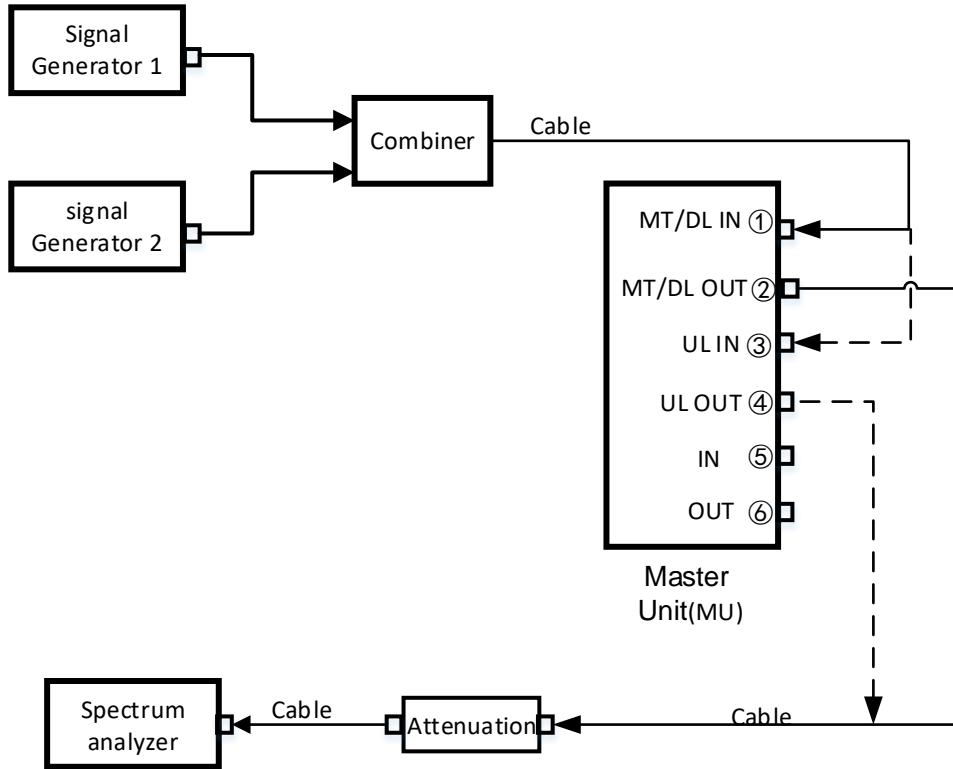

Figure 10.8-1 MU single device test connection diagram

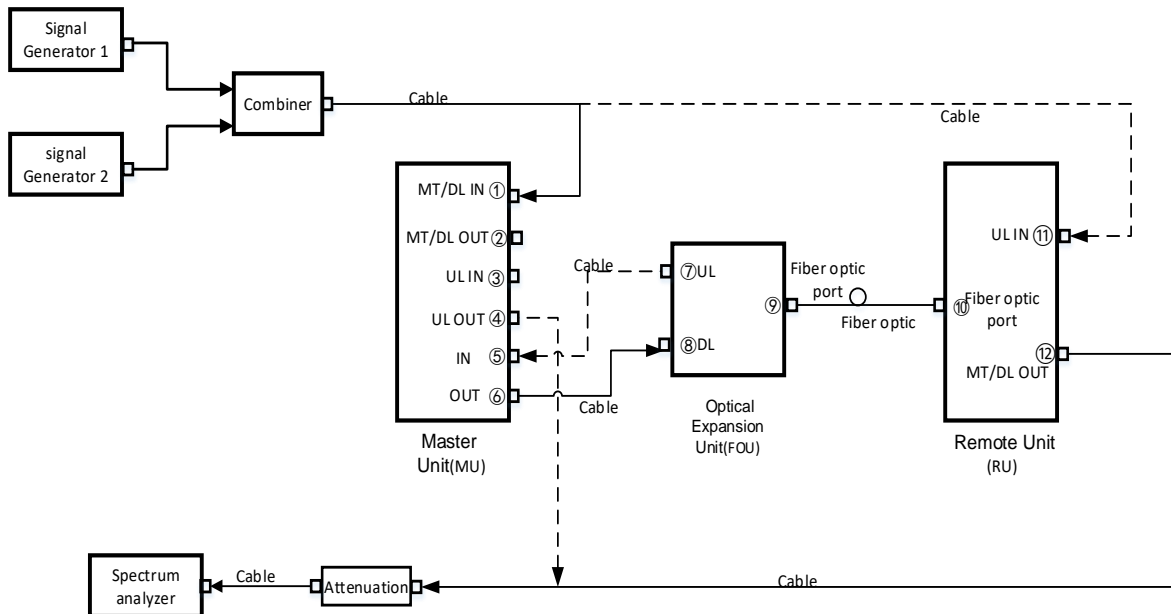

Figure 10.8-2 MU, FOU and RU system test connection diagram

### 10.8.3. Test procedures

- a) Connect a signal generator to the input of the EUT.  
If the signal generator is not capable of producing two independent modulated carriers simultaneously, then two discrete signal generators can be connected, with an appropriate combining network to support the two-signal test.
- b) Configure the two signal generators to produce CW on frequencies spaced consistent with 4.7.1, with amplitude levels set to just below the AGC threshold (see 4.2). Set the signal generator amplitudes so that the power from each into the EUT is equivalent.
- c) Connect a spectrum analyzer to the EUT output.
- d) Set the span to 100 kHz.
- e) Set RBW = 300 Hz with VBW  $\geq 3 \times$  RBW.
- f) Set the detector to power averaging (rms).
- g) Place a marker on highest intermodulation product amplitude.
- h) Capture the plot for inclusion in the test report.
- i) Repeat steps c) to h) with the composite input power level set to 3 dB above the AGC threshold.
- j) Repeat steps b) to i) for all operational bands.

Any frequency outside the authorized bandwidth was attenuated by at least  $43+10*\log(P)$ dB. This corresponds to an absolute level of -13dBm ( $P_{(dBm)}-(43+10*\log(P_{(w)}))$ ).

----- The following blanks -----

10.8.4. Test results

Test Date (yy-mm-dd): 2021-11-26~11-27

Normal condition: Temp: 27.7~27.8°C, Humid:39~40%, Atmospheric Pressure:101kpa

Supply Voltage: DC -48V

10.8.4.1.MU single device test

10.8.4.1.1. Downlink transmit mode

Test frequency	Intermodulation product Limit (dBm)	Max. intermodulation product (dBm)	Margin (dB)	Result	
(1) With the ALC threshold level					
Channel Bandwidth: 6.25kHz	Low frequency: f1:450.00313MHz f2:450.00938MHz	-13	-14.6	1.6	PASS
	Mid frequency: f1:479.0MHz f2:479.00625MHz	-13	-15.2	2.2	PASS
	High frequency: f1:508.99063MHz f2:508.99688MHz	-13	-22.7	9.7	PASS
Channel Bandwidth: 12.5kHz	Low frequency: f1:450.00625MHz f2:450.01875MHz	-13	-15.1	2.1	PASS
	Mid frequency: f1:479.0MHz f2:479.0125MHz	-13	-14.6	1.6	PASS
	High frequency: f1:508.98125MHz f2:508.99375MHz	-13	-25.0	12.0	PASS
Channel Bandwidth: 25kHz	Low frequency: f1:450.0125MHz f2:450.0375MHz	-13	-14.3	1.3	PASS
	Mid frequency: f1:479.0MHz f2:479.025MHz	-13	-14.5	1.5	PASS
	High frequency: f1:508.9625MHz f2:508.9875MHz	-13	-24.4	11.4	PASS
(2) With the input signal amplitude set 3 dB above the AGC threshold					
Channel Bandwidth: 6.25kHz	Low frequency: f1:450.00313MHz f2:450.00938MHz	-13	-15.1	2.1	PASS
	Mid frequency: f1:479.0MHz f2:479.00625MHz	-13	-13.8	0.8	PASS
	High frequency: f1:508.99063MHz f2:508.99688MHz	-13	-20.8	7.8	PASS
Channel Bandwidth: 12.5kHz	Low frequency: f1:450.00625MHz f2:450.01875MHz	-13	-14.6	1.6	PASS
	Mid frequency: f1:479.0MHz f2:479.0125MHz	-13	-14.6	1.6	PASS
	High frequency:	-13	-23.6	10.6	PASS

	f1:508.98125MHz f2:508.99375MHz				
Channel Bandwidth: 25kHz	Low frequency: f1:450.0125MHz f2:450.0375MHz	-13	-14.6	11.6	PASS
	Mid frequency: f1:479.0MHz f2:479.025MHz	-13	-14.3	11.3	PASS
	High frequency: f1:508.9625MHz f2:508.9875MHz	-13	-27.2	14.2	PASS
NOTE 1: Intermodulation products select the worst data record.					
NOTE 2: Margin= specification limit -Maximum mark level.					

10.8.4.1.2. Uplink transmit mode

Test frequency	Intermodulation product Limit (dBm)	Max. intermodulation product (dBm)	Margin (dB)	Result	
(3) With the ALC threshold level					
Channel Bandwidth: 6.25kHz	Low frequency: f1:455.00313MHz f2:455.00938MHz	-13	-16.0	3.0	PASS
	Mid frequency: f1:484.0MHz f2:484.00625MHz	-13	-14.6	1.6	PASS
	High frequency: f1:511.99063MHz f2:511.99688MHz	-13	-16.7	3.7	PASS
Channel Bandwidth: 12.5kHz	Low frequency: f1:455.00625MHz f2:455.01875MHz	-13	-17.2	4.2	PASS
	Mid frequency: f1:484.0MHz f2:484.0125MHz	-13	-15.8	2.8	PASS
	High frequency: f1:511.98125MHz f2:511.99375MHz	-13	-18.0	5.0	PASS
Channel Bandwidth: 25kHz	Low frequency: f1:455.0125MHz f2:455.0375MHz	-13	-17.0	4.0	PASS
	Mid frequency: f1:484.0MHz f2:484.025MHz	-13	-15.3	2.3	PASS
	High frequency: f1:511.9625MHz f2:511.9875MHz	-13	-21.2	8.2	PASS
(4) With the input signal amplitude set 3 dB above the AGC threshold					
Channel Bandwidth: 6.25kHz	Low frequency: f1:455.00313MHz f2:455.00938MHz	-13	-15.5	2.5	PASS
	Mid frequency: f1:484.0MHz f2:484.00625MHz	-13	-14.7	1.7	PASS
	High frequency: f1:511.99063MHz f2:511.99688MHz	-13	-17.1	4.1	PASS
Channel Bandwidth: 12.5kHz	Low frequency: f1:455.00625MHz f2:455.01875MHz	-13	-16.7	3.7	PASS



	Mid frequency: f1:484.0MHz f2:484.0125MHz	-13	-16.0	3.0	PASS
	High frequency: f1:511.98125MHz f2:511.99375MHz	-13	-18.1	5.1	PASS
Channel Bandwidth: 25kHz	Low frequency: f1:455.0125MHz f2:455.0375MHz	-13	-16.2	3.2	PASS
	Mid frequency: f1:484.0MHz f2:484.025MHz	-13	-15.3	2.3	PASS
	High frequency: f1:511.9625MHz f2:511.9875MHz	-13	-21.6	8.6	PASS

NOTE 1: Intermodulation products select the worst data record.

NOTE 2: Margin= specification limit -Maximum mark level.

----- The following blanks -----

## 10.8.4.2. System test

## 10.8.4.2.1. Uplink transmit mode

Test frequency	Intermodulation product Limit (dBm)	Max. intermodulation product (dBm)	Margin (dB)	Result	
(5) With the ALC threshold level					
Channel Bandwidth: 6.25kHz	Low frequency: f1:455.00313MHz f2:455.00938MHz	-13	-16.4	3.4	PASS
	Mid frequency: f1:484.0MHz f2:484.00625MHz	-13	-17.5	4.5	PASS
	High frequency: f1:511.99063MHz f2:511.99688MHz	-13	-18.5	5.5	PASS
Channel Bandwidth: 12.5kHz	Low frequency: f1:455.00625MHz f2:455.01875MHz	-13	-17.2	4.2	PASS
	Mid frequency: f1:484.0MHz f2:484.0125MHz	-13	-18.4	5.4	PASS
	High frequency: f1:511.98125MHz f2:511.99375MHz	-13	-20.6	7.6	PASS
Channel Bandwidth: 25kHz	Low frequency: f1:455.0125MHz f2:455.0375MHz	-13	-16.8	3.8	PASS
	Mid frequency: f1:484.0MHz f2:484.025MHz	-13	-17.1	4.1	PASS
	High frequency: f1:511.9625MHz f2:511.9875MHz	-13	-22.9	9.9	PASS
(6) With the input signal amplitude set 3 dB above the AGC threshold					
Channel Bandwidth: 6.25kHz	Low frequency: f1:455.00313MHz f2:455.00938MHz	-13	-16.9	3.9	PASS
	Mid frequency: f1:484.0MHz f2:484.00625MHz	-13	-18.6	5.6	PASS
	High frequency: f1:511.99063MHz f2:511.99688MHz	-13	-19.7	6.7	PASS
Channel Bandwidth: 12.5kHz	Low frequency: f1:455.00625MHz f2:455.01875MHz	-13	-18.0	5.0	PASS
	Mid frequency: f1:484.0MHz f2:484.0125MHz	-13	-19.6	6.6	PASS
	High frequency: f1:511.98125MHz f2:511.99375MHz	-13	-21.6	8.6	PASS
Channel Bandwidth: 25kHz	Low frequency: f1:455.0125MHz f2:455.0375MHz	-13	-18.0	5.0	PASS
	Mid frequency: f1:484.0MHz f2:484.025MHz	-13	-18.5	5.5	PASS

	High frequency: f1:511.9625MHz f2:511.9875MHz	-13	-25.1	12.1	PASS
NOTE 1: Intermodulation products select the worst data record.					
NOTE 2: Margin= specification limit -Maximum mark level.					

----- **The following blanks** -----

10.8.5. Test screenshot

10.8.5.1. MU single device test

10.8.5.1.1. Downlink transmit mode

10.8.5.1.1.1. Channel Bandwidth:6.25kHz

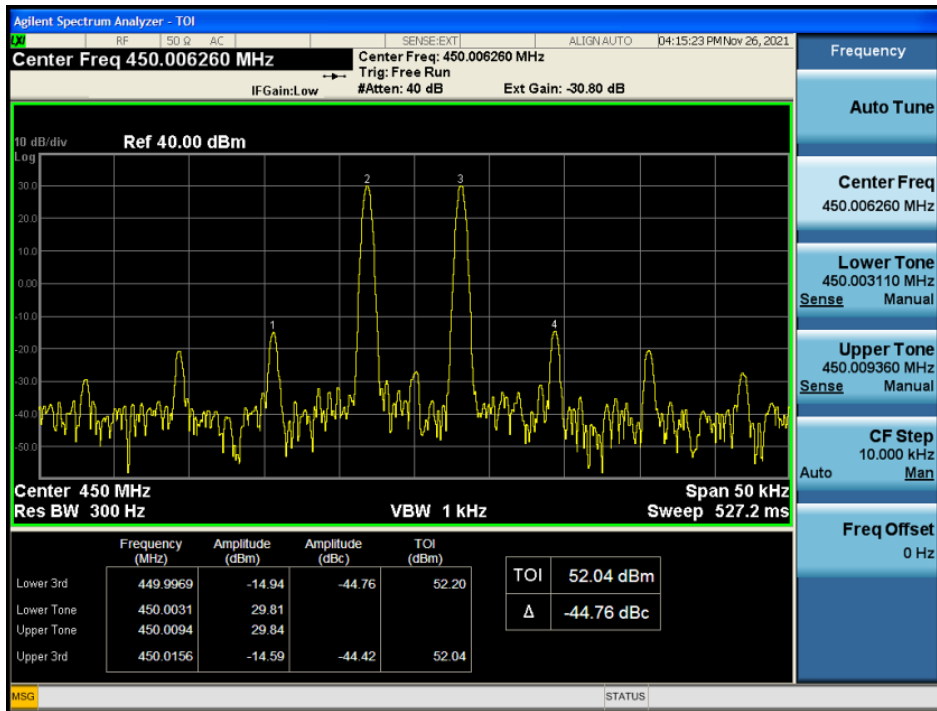

Low Frequency and With the ALC threshold level

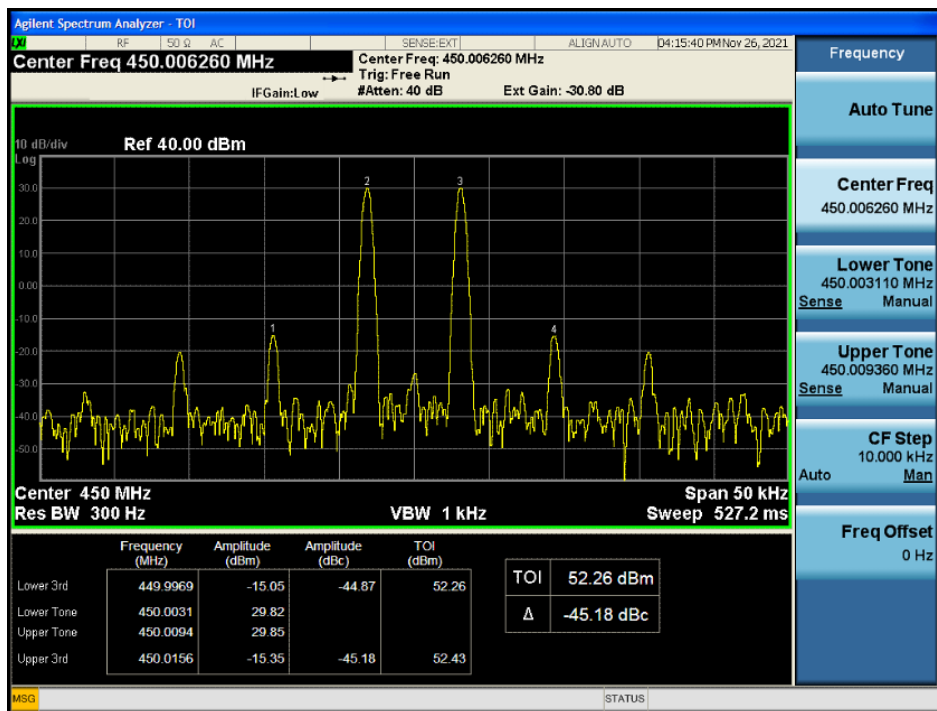

Low Frequency and With the input signal amplitude set 3 dB above the ALC threshold



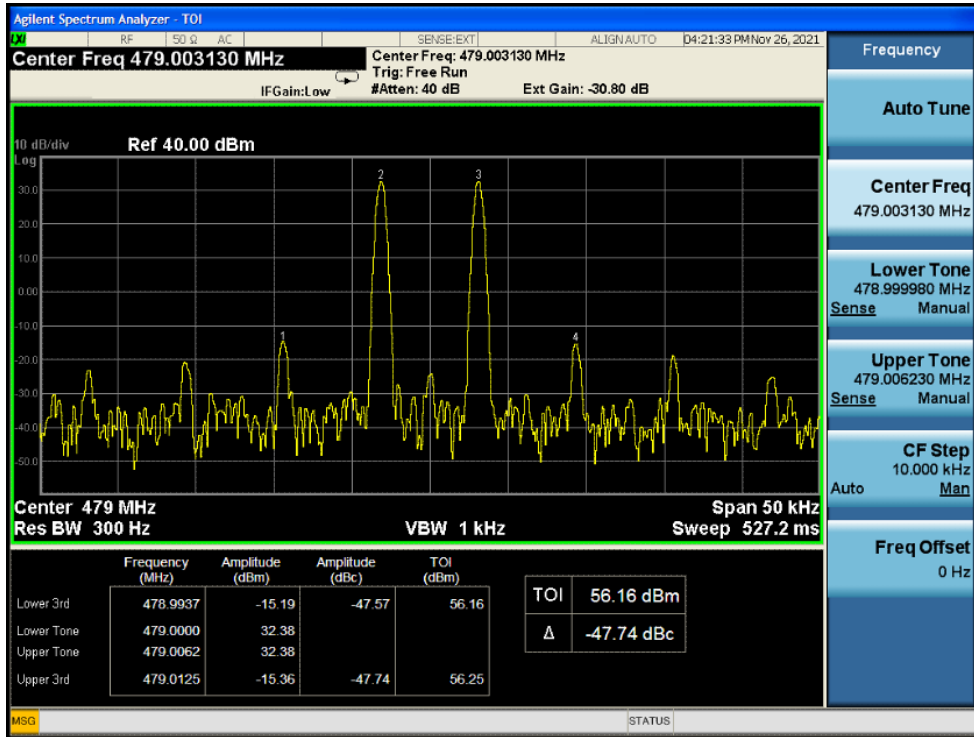

Mid Frequency and With the ALC threshold level

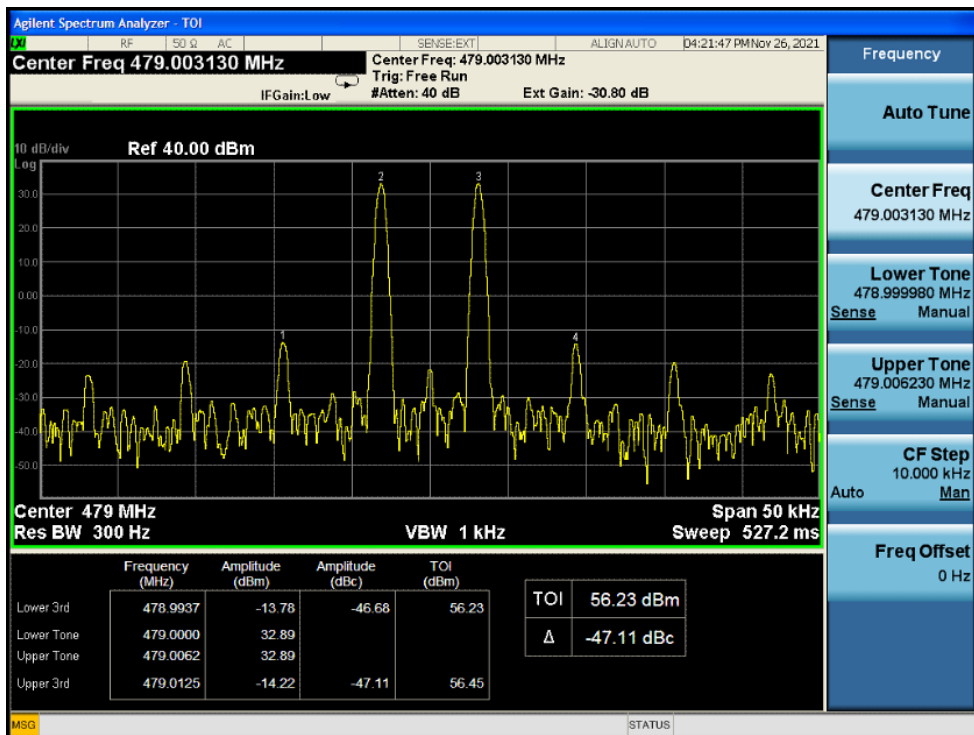

Mid Frequency and With the input signal amplitude set 3 dB above the ALC threshold

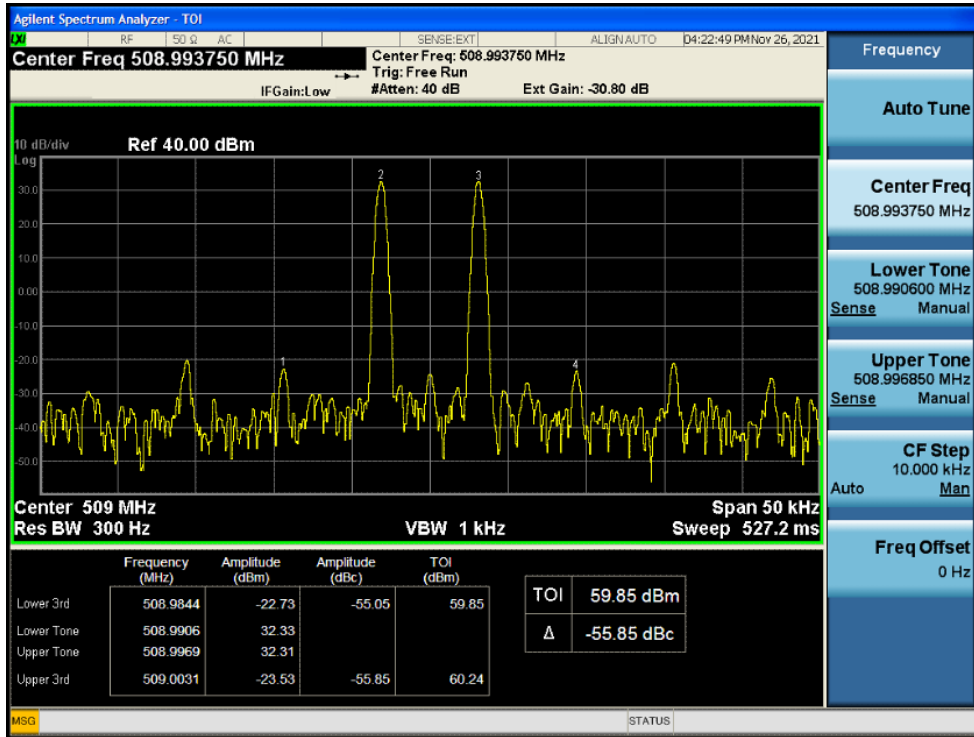

High Frequency and With the ALC threshold level

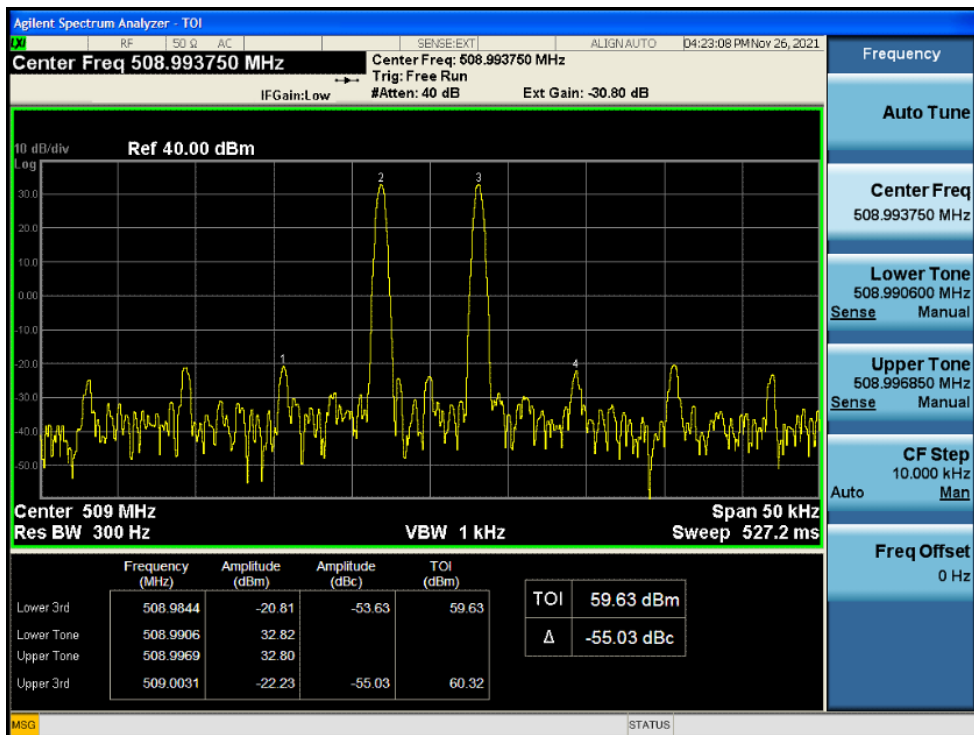

High Frequency and With the input signal amplitude set 3 dB above the ALC threshold

10.8.5.1.1.2. Channel Bandwidth:12.5kHz

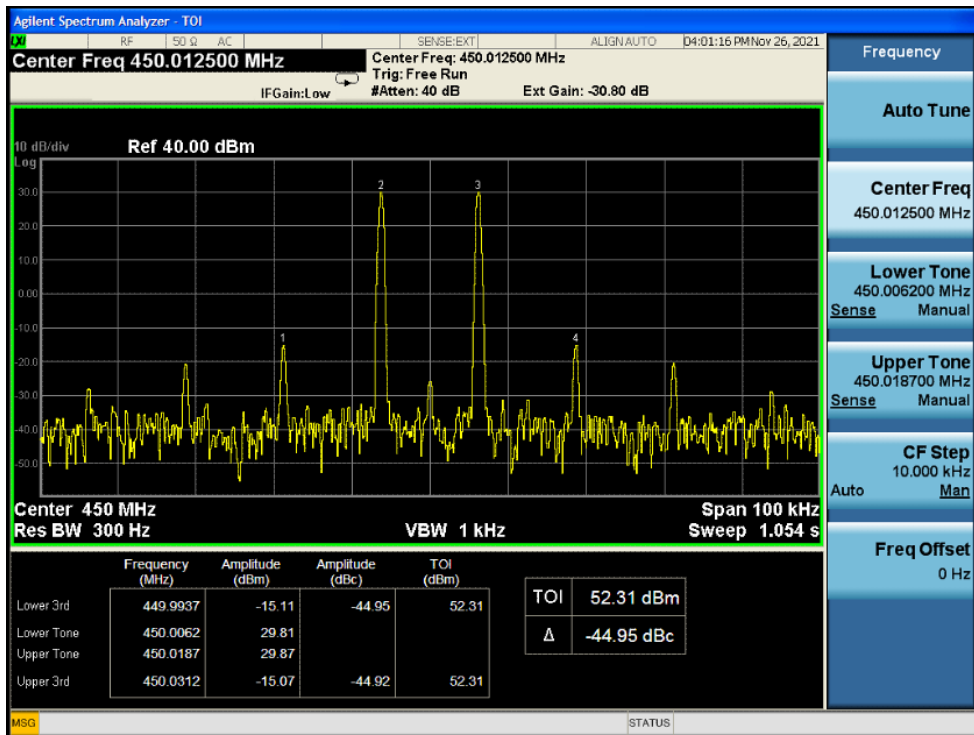

Low Frequency and With the ALC threshold level

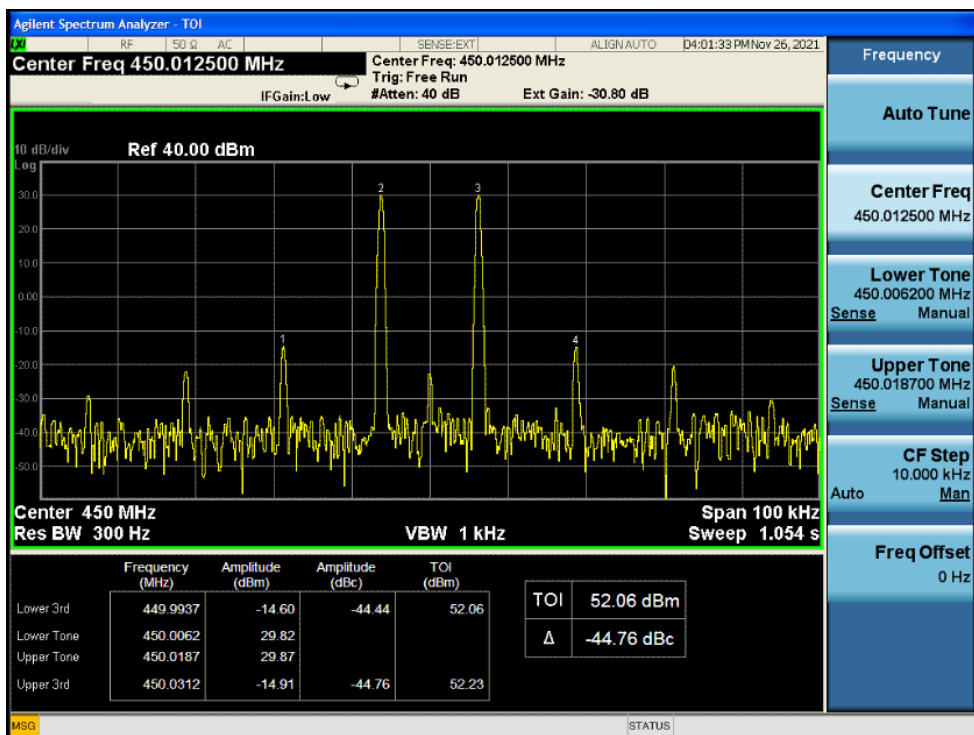

Low Frequency and With the input signal amplitude set 3 dB above the ALC threshold

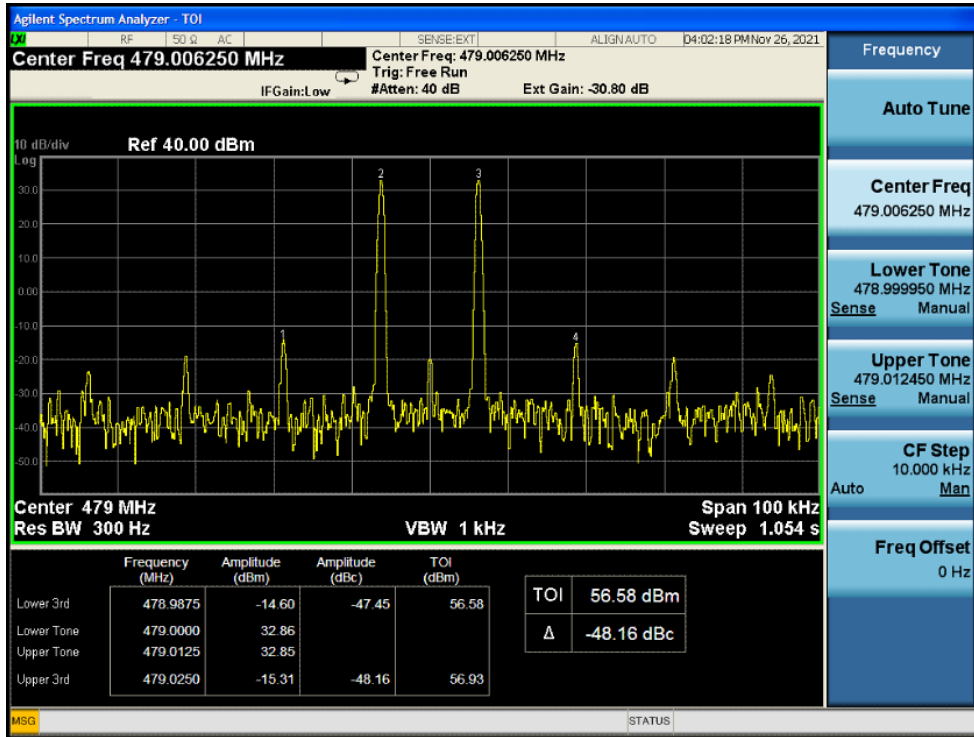

Mid Frequency and With the ALC threshold level

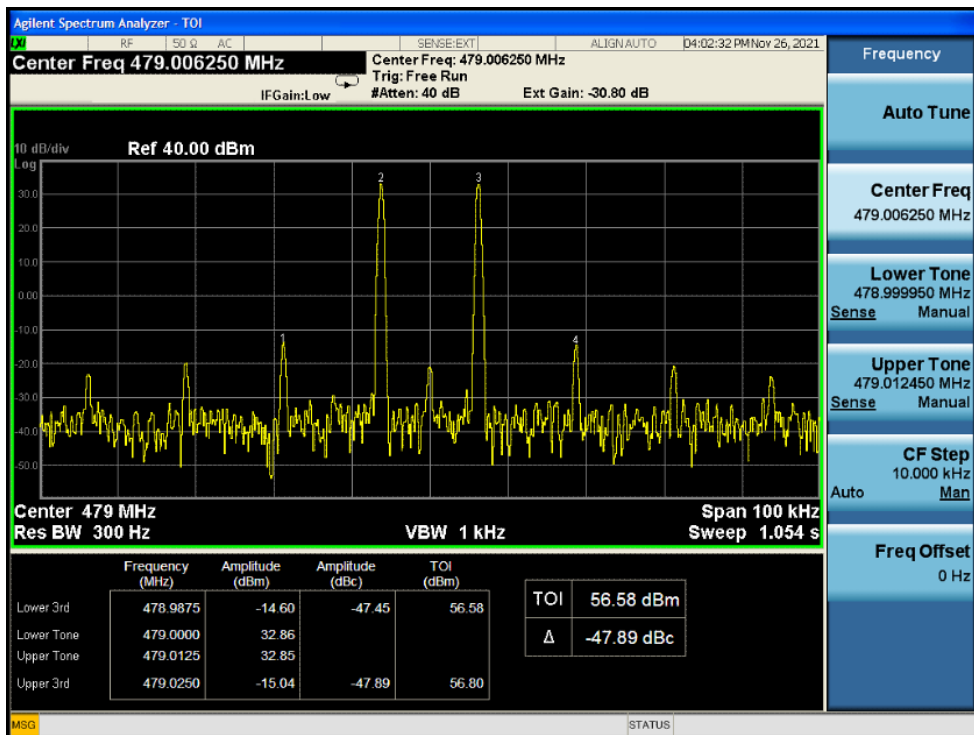

Mid Frequency and With the input signal amplitude set 3 dB above the ALC threshold

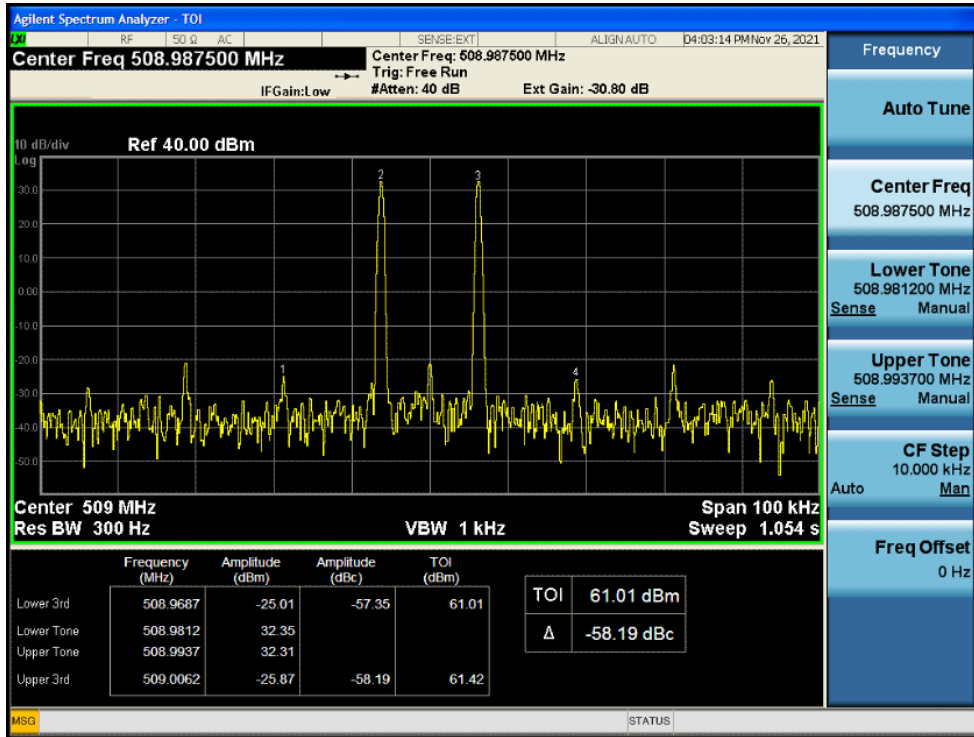

High Frequency and With the ALC threshold level

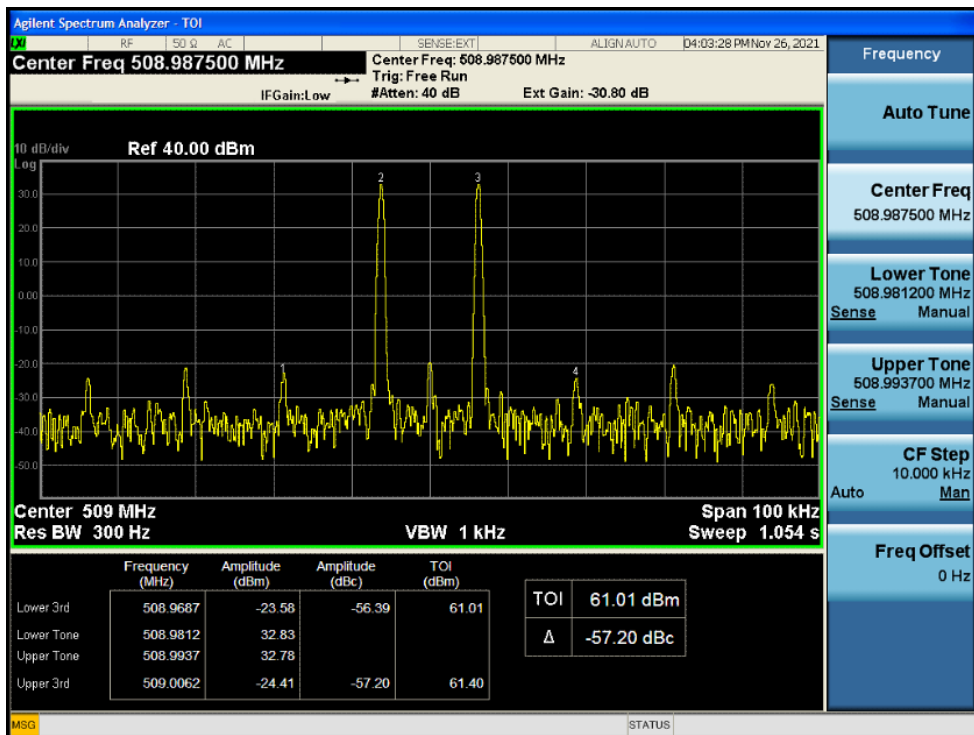

High Frequency and With the input signal amplitude set 3 dB above the ALC threshold



10.8.5.1.1.3. Channel Bandwidth: 25kHz

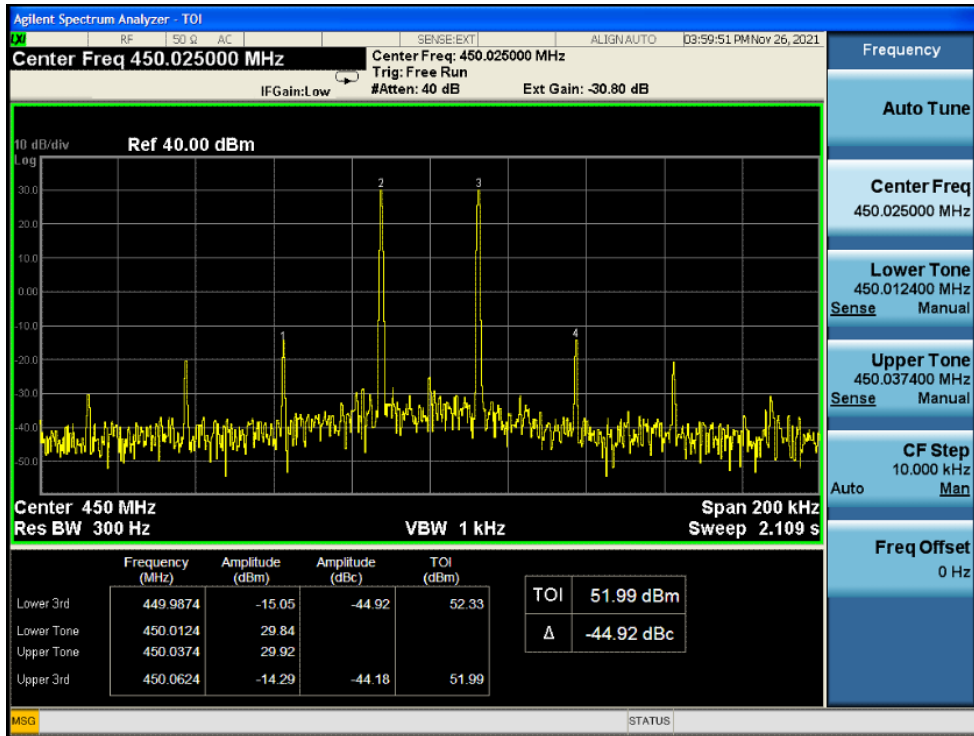

Low Frequency and With the ALC threshold level

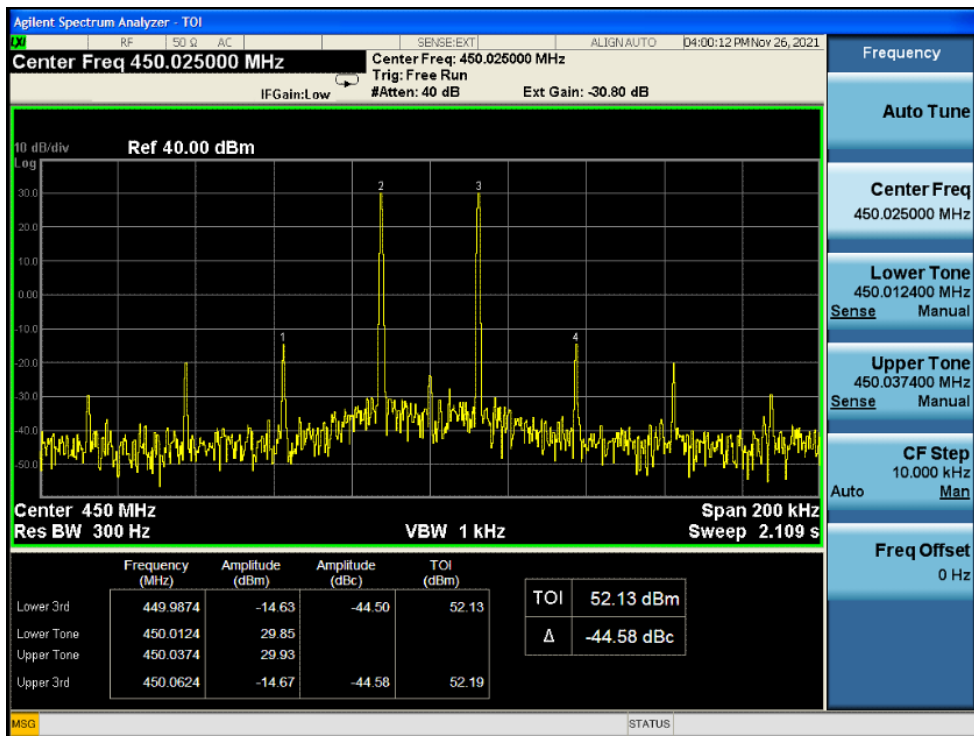

Low Frequency and With the input signal amplitude set 3 dB above the ALC threshold

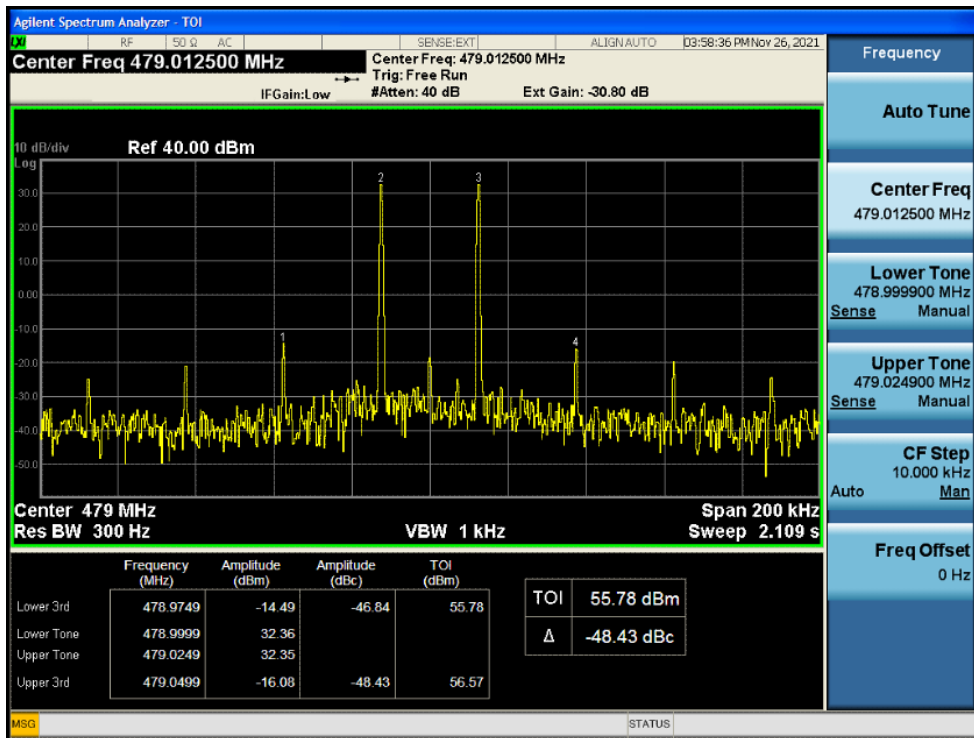

Mid Frequency and With the ALC threshold level

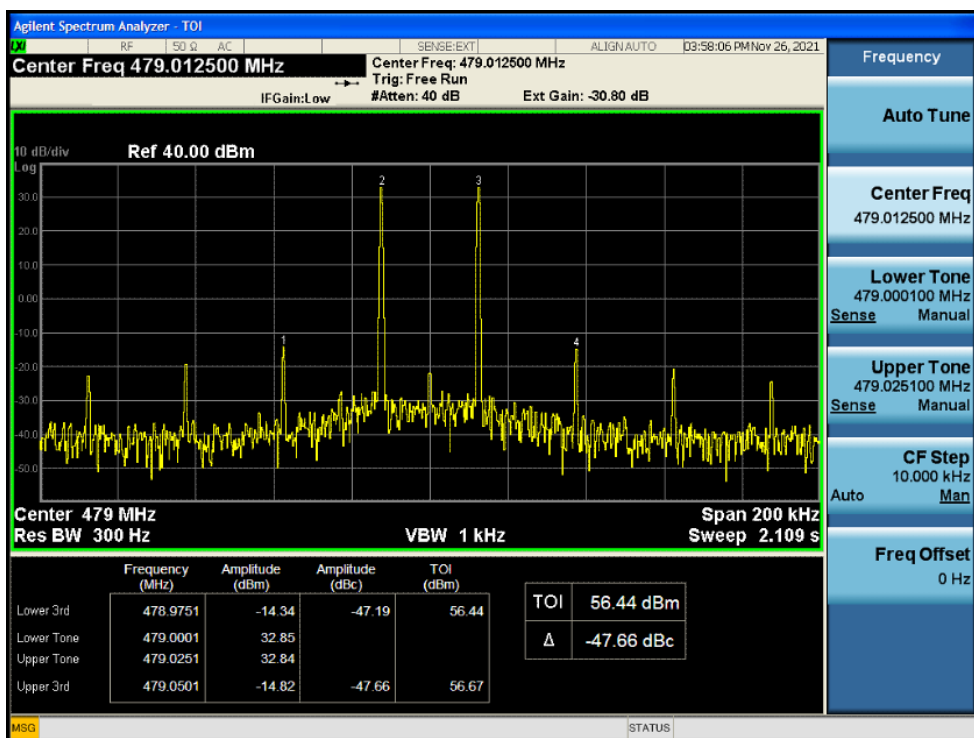

Mid Frequency and With the input signal amplitude set 3 dB above the ALC threshold

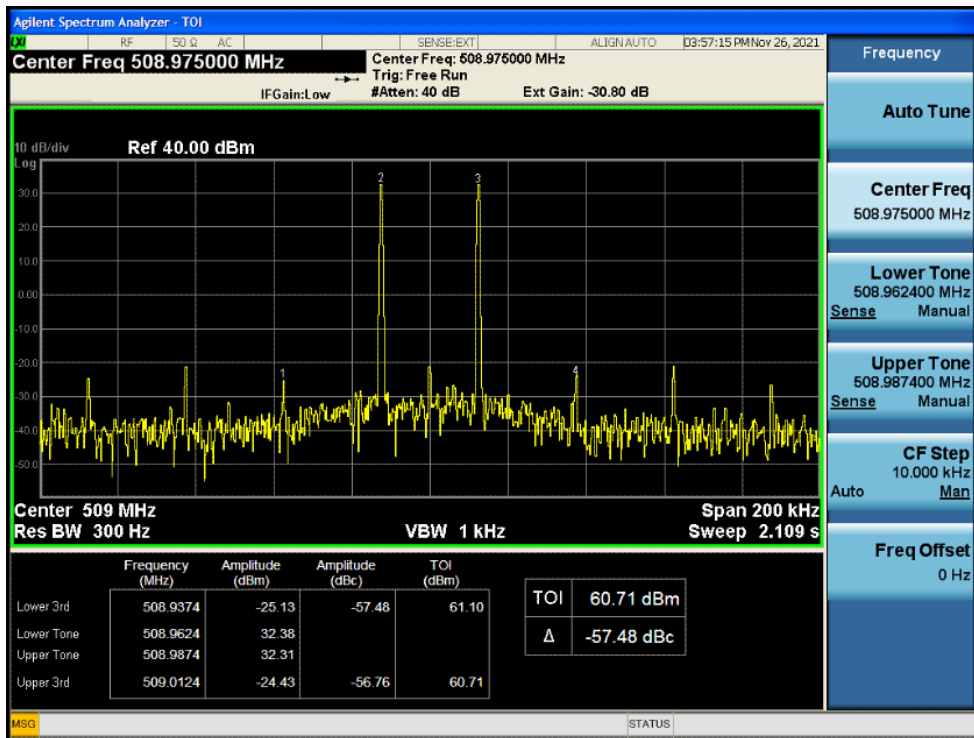

High Frequency and With the ALC threshold level

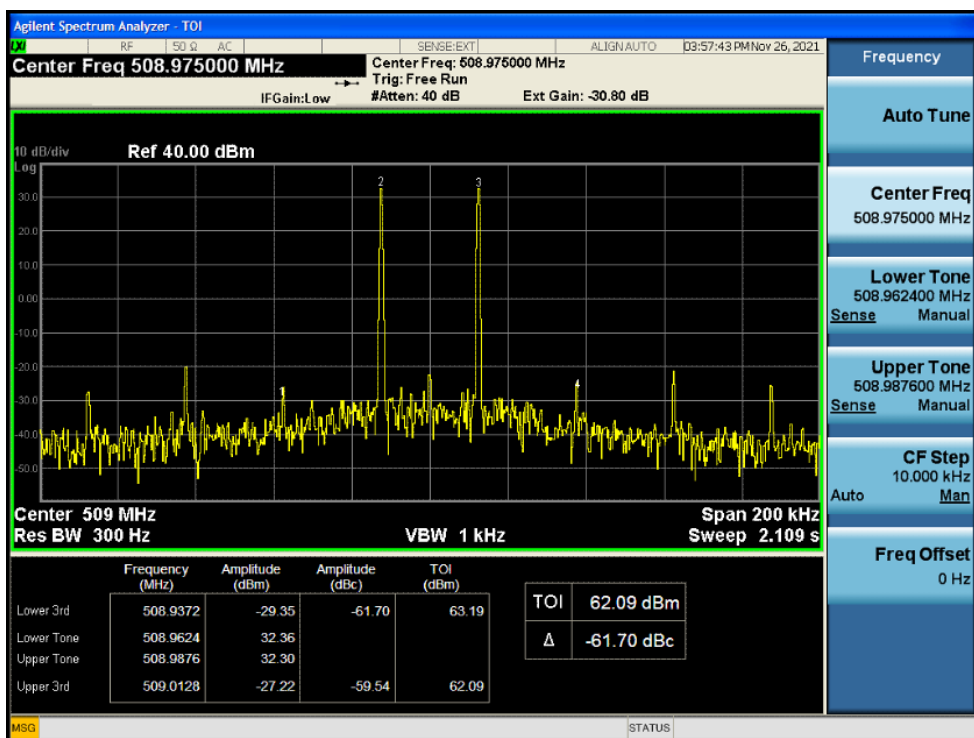

High Frequency and With the input signal amplitude set 3 dB above the ALC threshold

10.8.5.1.2. Uplink transmit mode

10.8.5.1.2.1. Channel Bandwidth:6.25kHz

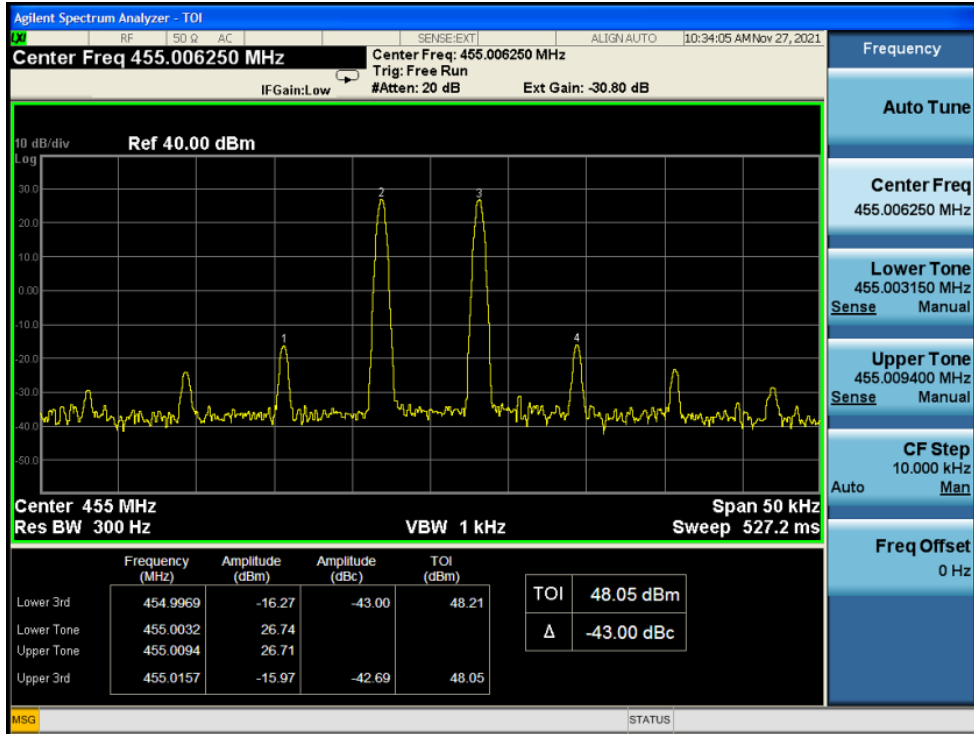

Low Frequency and With the ALC threshold level

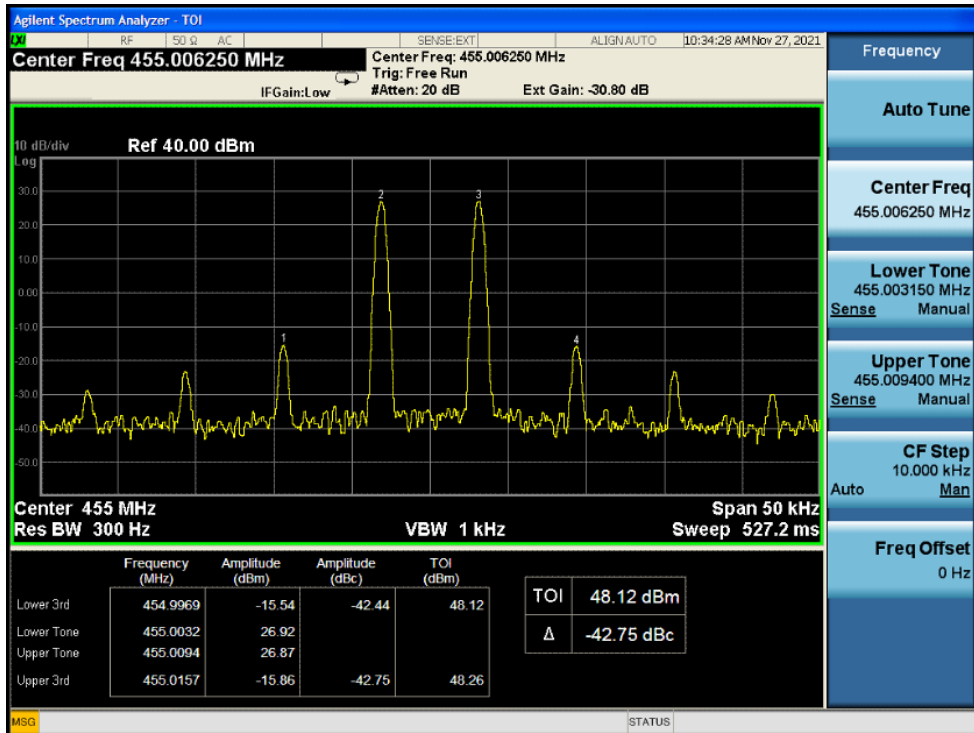

Low Frequency and With the input signal amplitude set 3 dB above the ALC threshold