

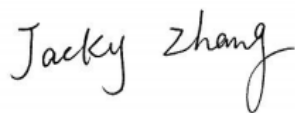



TEST REPORT

Report No.:	E201704241213-1	Application No.:	E201704241213
Applicant:	Comba Telecom Ltd.		
Applicant Address:	611 East Wing, No. 8 Science Park West Avenue, Hong Kong Science Park, Tai Po, Hong Kong		
Sample Description:	700/800MHz Public Safety Bi-directional Amplifier		
Model:	RX-7W22-B		
Adding Model:	RX-7W22A48-B		
Test Location:	EMC Laboratory of Guangzhou GRG Metrology and Test Co., Ltd.		
Test Specification:	FCC PART 2--- FREQUENCY ALLOCATIONS AND RADIO TREATY MATTERS; GENERAL RULES AND REGULATIONS. FCC PART 90-- PRIVATE LAND MOBILE RADIO SERVICES.		
Test Date:	2017-05-16 to 2017-07-11		
Issue Date:	2017-07-12		
Test Result:	<i>Pass.</i>		
Prepared By:	Reviewed By:	Approved By:	
Jacky zhang/ Test Engineer	Lyn xiao/ Technical Assistance	Yong Dai / Manager	
			
Date: 2017-07-12	Date: 2017-07-12	Date: 2017-07-12	
Other Aspects:			
Abbreviations: <i>ok / P = passed; fail / F = failed; n.a. / N = not applicable</i>			
The test result in this test report refers exclusively to the presented test sample. This report shall not be reproduced except in full, without the written approval of GRGT.			

DIRECTIONS OF TEST

1. This station carries out test task according to the national regulation of verifications which can be traced to National Primary Standards and BIPM.
2. The test report merely corresponds to the test sample. It is not permitted to copy extracts of these test result without the written permission of the test laboratory.
3. If there is any objection concerning the test, the client should inform the laboratory within 15 days from the date of receiving the test report.

Table of Contents

- 1 GENERAL DESCRIPTION OF EUT..... 4**
 - 1.1 CLIENT INFORMATION..... 4
 - 1.2 MANUFACTURER AND FACTORY..... 4
 - 1.3 BASIC DESCRIPTION OF EUT..... 4
 - 1.4 STANDARDS APPLICABLE FOR TESTING..... 5
 - 1.5 SIGNAL CONTROL PROCESS..... 5
 - 1.6 ABBREVIATIONS AND ACRONYMS..... 6
- 2 TEST RESULT SUMMARY 6**
- 3 LABORATORY AND ACCREDITATIONS 7**
 - 3.1 TEST LOCATION 7
 - 3.2 ACCREDITATIONS 7
- 4 MEASUREMENTS UNCERTAINTY 7**
- 5 DEVICES USED DURING TEST 8**
- 6 RADIO TECHNICAL REQUIREMENT SPECIFICATION 9**
 - 6.1 RADIATED OUTPUT POWER..... 9**
 - 6.1.1 *Limit*..... 9
 - 6.1.2 *Test configuration*..... 9
 - 6.1.3 *Test procedures*..... 10
 - 6.1.4 *Test Results*..... 11
 - 6.1.5 *Test screenshot*..... 18
 - 6.2 OCCUPIED BANDWIDTH 31**
 - 6.2.1 *Limit*..... 31
 - 6.2.2 *Test configuration*..... 32
 - 6.2.3 *Test procedures*..... 32
 - 6.2.4 *Test Results*..... 34
 - 6.2.5 *Test screenshot*..... 39
 - 6.3 EMISSION MASK 57**
 - 6.3.1 *Limit*..... 57
 - 6.3.2 *Test configuration*..... 59
 - 6.3.3 *Test procedures*..... 60
 - 6.3.4 *Test Results*..... 61
 - 6.3.5 *Test screenshot*..... 65
 - 6.4 CONDUCTED SPURIOUS EMISSIONS 77**
 - 6.4.1 *Limit*..... 77
 - 6.4.2 *Test configuration*..... 77
 - 6.4.3 *Test procedures*..... 78
 - 6.4.4 *Test Results*..... 79
 - 6.5 FREQUENCY STABILITY 83**
 - 6.5.1 *Limit*..... 83
 - 6.5.2 *Test configuration*..... 83
 - 6.5.3 *Test procedures*..... 84
 - 6.5.4 *Test Results*..... 85
 - 6.5.5 *Test screenshot*..... 86
 - 6.6 NOISE FIGURE..... 87**
 - 6.6.1 *Limit*..... 87
 - 6.6.2 *Test configuration*..... 87
 - 6.6.3 *Test procedures*..... 88
 - 6.6.4 *Test Results*..... 89
 - 6.6.5 *Test screenshot*..... 89
 - 6.7 INTERMODULATION PRODUCT 91**
 - 6.7.1 *Limit*..... 91
 - 6.7.2 *Test configuration*..... 91
 - 6.7.3 *Test procedures*..... 92
 - 6.7.4 *Test Results*..... 93

6.7.5 Test screenshot 98

6.8 RADIATED SPURIOUS EMISSIONS 108

6.8.1 Limit..... 108

6.8.2 Test configuration 108

6.8.3 Test procedures 109

6.8.4 Test Results..... 111

APPENDIX A. PHOTOGRAPH OF THE TEST CONNECTION DIAGRAM..... 116

1 General description of EUT

1.1 Client information

Name: Comba Telecom Ltd.
Address: 611 East Wing, No. 8 Science Park West Avenue, Hong Kong Science Park, Tai Po, Hong Kong

1.2 Manufacturer and Factory

Manufacture Name: Comba Telecom systems (China) Ltd.
Address: No.10 Shenzhou Road, Guangzhou Science City, Guangzhou 510663, Guangdong, P.R. China
Factory: Comba Telecom Technology (Guangzhou) Ltd.
Address: No.6 Jinbi Road, Economics and Technology Development District, Guangzhou Guangdong China

1.3 Basic description of EUT

Product Name: 700/800MHz Public Safety Bi-directional Amplifier
Product Model: RX-7W22-B
Adding Model: RX-7W22A48-B
Trade Name: Comba
Power Supply^①: AC 100~240V, 50/60Hz
DC -48V
Power cord: AC power cord (4m)
DC power cord (4m)
Frequency Band^②: 700MHz Band:
Downlink: 758MHz ~ 775MHz, Uplink: 788MHz ~805MHz
800MHz Band:
Downlink: 851MHz ~862MHz, Uplink: 806MHz ~ 817MHz
Type of Modulation^③: C4FM, Tetra ,Analog FM and LTE
Normal Power Output: Downlink: 33dBm
Uplink: 27dBm
Normal System Gain: Downlink: 90dB
Uplink: 90dB
Operating Temperature: -33°C to +60°C
Operating Humidity: 5% to 95%
Antenna Type: N/A

Note: ^① Power Supply of The device is AC 100~240V, 50/60Hz or DC -48V, It uses different power modules and Surge protector module.

^② PS Guardband: Downlink:768MHz~769MHz and Uplink: 798MHz ~ 799MHz.

© LTE Modulation : Downlink: 758MHz ~768MHz, Uplink: 788MHz ~ 798MHz, LTE channel Bandwidth is 10MHz.

1.4 Standards applicable for testing

The standard used FCC part 2, part 90, KDB 935210 D05 and EIA/TIA 603- D-2010.

1.5 Signal control process

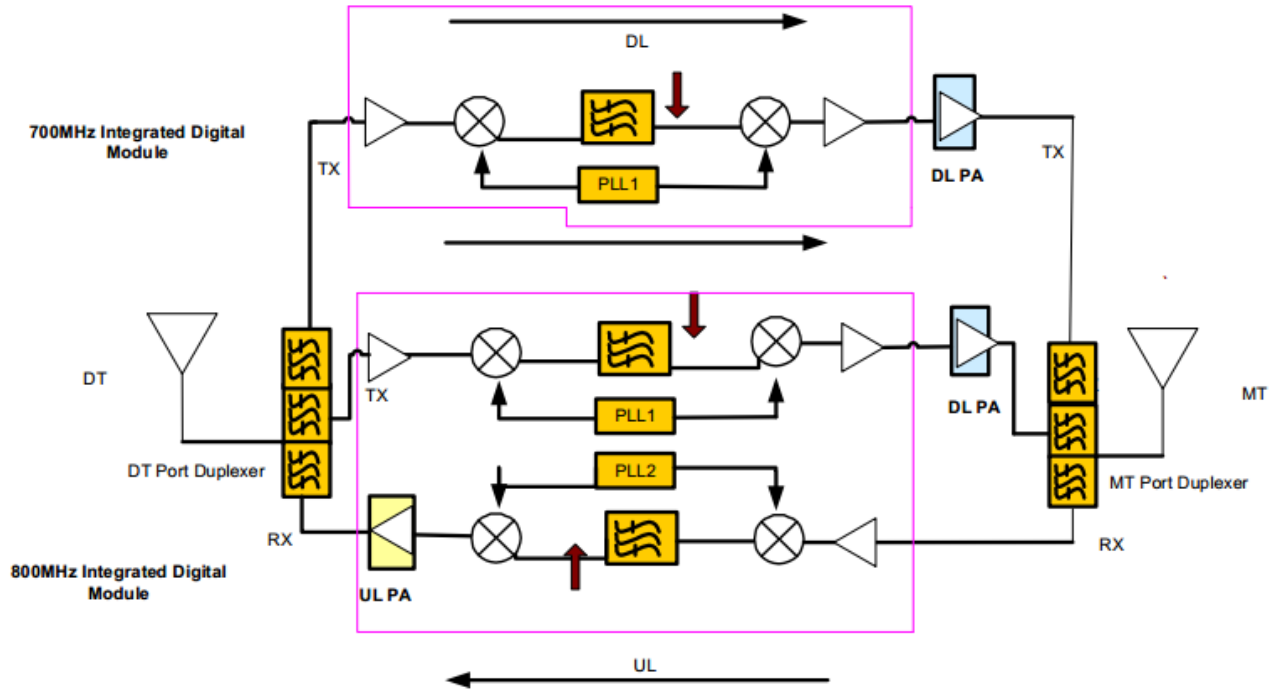

Figure 1: PS BDA Functional Block Diagram

In the downlink, the BTS signals are received by donor antenna of the device. After the duplexer, the signals are sent to the LNA module for pre-amplification and digital RF integrated module for digital filtering and frequency conversion. Then the DL signals will be sent to downlink PA to amplify power and filter via duplexer. After amplification, the signals are transmitted at the MT port to the service antenna.

In the uplink, the mobile signals are received by the service antenna. After the MT port integrated duplexer, the signals are sent to the LNA module, integrated module for digital filtering, then to PA for power amplification and to duplexer. After that, the uplink signals are sent to the donor antenna for transmission back to the BTS.

1.6 Abbreviations and acronyms

For the purposes of the reporter, the following symbols can be applied:

AC	Alternating current
DC	Direct current
AVR	Average(detector)
dB	decibel
dBm	Decibel referred to one milliwalt
EIRP	Equivalent isotropically radiated power
ERP	Effective radiated power
F	Frequency
GHz	Gigahertz
RF	Radio Frequency
PS	Public safety
DL	Downlink
UL	Uplink
LNA	Low Noise Amplifier
SDR	Software Defined Radio

2 Test result summary

Test Item	Test Requirement	Test Method	Result
Radiated output power	Part 90.219(e)(1)	FCC part 2.1046& KDB 935210 D05 Indus Booster Basic Meas v01r01	PASS
Occupied bandwidth	Part 90.219(a)	FCC part 2. 1049& KDB 935210 D05 Indus Booster Basic Meas v01r01	PASS
Emission mask	Part 90.210(b), Part 90.210(c), Part 90.210(g). Part 90.210(h)	FCC part 2. 1047& FCC part 2. 1051 & KDB 935210 D05 Indus Booster Basic Meas v01r01	PASS
Intermodulation product	Part 90.219(e)(3)	KDB 935210 D05 Indus Booster Basic Meas v01r01	PASS
Frequency stability	part 90.213 & part 90.539	KDB 935210 D05 Indus Booster Basic Meas v01r01	PASS
Noise figure	Part 90.219(e)(2)	KDB 935210 D05 Indus Booster Basic Meas v01r01	PASS
Radiated spurious emissions	Part 90.219(e)(3)	KDB 935210 D05 Indus Booster Basic Meas v01r01 EIA/TIA 603- D/2.2.12	PASS
Conducted spurious emissions	Part 90.219(e)(3)	KDB 935210 D05 Indus Booster Basic Meas v01r01	PASS

Notes:

- (1). This is a Class B broadband Industrial signal booster device and it is a Non-SDR.
- (2). The device has audio low pass filters.
- (3). The modulation methods used in this test are C4FM, Tetra, Analog FM and LTE.

3 Laboratory and accreditations

3.1 Test location

The tests and measurements refer to this report were performed by Guangzhou GRG Metrology and Test Co., Ltd.

Add.: 163 Pingyun Rd, West of Huangpu Ave, Guangzhou, 510656, P. R. China

Telephone: +86-20-38699959, 38699960, 38699961

Fax : +86-20-38695185

3.2 Accreditations

Our laboratories are accredited and approved by the following approval agencies according to ISO/IEC 17025.

USA	FCC Listed Lab No. 688188
Canada	Registration No.:8355A-1

4 Measurements uncertainty

Where relevant, the following measurement uncertainty levels have been estimated for tests performed on the EUT as specified in CISPR 16-4-2:

Measurement		Frequency	Uncertainty
Radiated Emission	Horizontal	30MHz~1000MHz	4.2dB
	Horizontal	1GHz~6GHz	4.2dB
	Vertical	30MHz~1000MHz	4.4dB
	Vertical	1GHz~6GHz	4.4dB
Conducted Emission		9kHz~150kHz	2.6dB
		150kHz~30MHz	2.4dB

This uncertainty represents an expanded uncertainty factor of $k=2$.

5 Devices used during test

Name of Device	Manufacturer	Model	Serial Number	Calibration Due(yy-mm-dd)	Calibration Interval
Signal Generator	R&S	SMJ100A	101647	2017-05-10	2018-05-09
Signal Generator	Agilent	E4438C	MY42082584	2017-01-15	2018-01-14
Spectrum analyzer	R&S	FSV3	102004	2017-05-09	2018-05-08
Spectrum analyzer	Agilent	N9010A	MY49061079	2017-03-26	2018-03-25
SNS Series Noise Source	Agilent	N4000A	MY44421910	2017-04-15	2018-04-14
NFA Series Noise Figure Analyzer	Agilent	N8973A	MY45271261	2017-04-15	2018-04-14
Frequency meter	FLUKE	PM6685R	SM826664	2017-05-13	2018-05-12
Voltage parameters tester	China weibo	PF1211	0112104	2016-08-12	2017-08-11
DC power supply	Puxin Henan	P6030A	200823	2016-09-09	2017-09-08
Voltage regulator	China tianzheng	TDGC2J-3	1027	2016-10-19	2017-10-18
Radiated Spurious Emission					
Bi-Log Antenna	ETS-LINDGR EN	3142C	00075971	2017-03-02	2018-03-01
Horn antenna	ETS.LINDGR EN	3117	00075824	2016-07-14	2017-07-13
EMI Receiver	Rohde & Schwarz	ESU 40	100526	2016-12-27	2017-12-26
Semi anechoic chamber	ETS	966(RFD-F/A-100)	3730	2016-12-06	2017-12-05

6 Radio technical requirement specification

6.1 Radiated output power

Test Date (yy-mm-dd): 2017-05-16 to 2017-07-11

Test environment: Normal

Ambient Temp 24.1°C~26.1°C, Humid 46%~51%, Atmospheric Pressure 101kpa

Power supply: AC 120V 50/60Hz
DC -48V

Test Method: FCC part 2. 1046& KDB 935210 D05 Indus Booster Basic Meas v01r01

Test Requirement: FCC part 90.219(e)(1)

6.1.1 Limit

The output power capability of a signal booster must be designed for deployments providing a radiated power not exceeding 5 Watts ERP for each retransmitted channel according to tables 1.

Table 1 Maximum output power limits

Assigned frequency range(MHz)	Maximum output power(ERP)	
	W	dBm
Above 150	5	37.00

NOTE:

1. RF channels to be tested for single-carrier: Low frequency, Mid frequency and High frequency.
2. Modulation types are C4FM, Tetra and Analog FM and LTE.
3. The nominal output power by Manufacturer declaration: Downlink 33dBm ± 1dB and Uplink 27dBm ± 1dB.

6.1.2 Test configuration

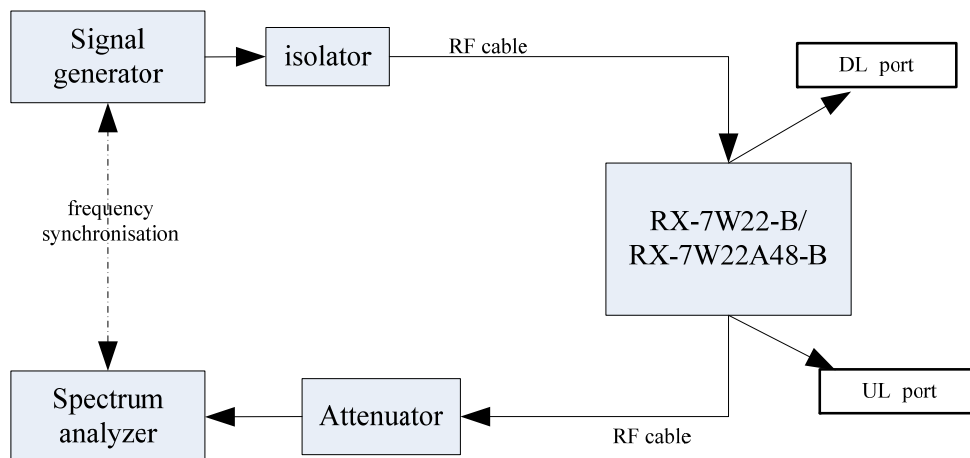

Figure 1: Maximum output power arrangement for Downlink

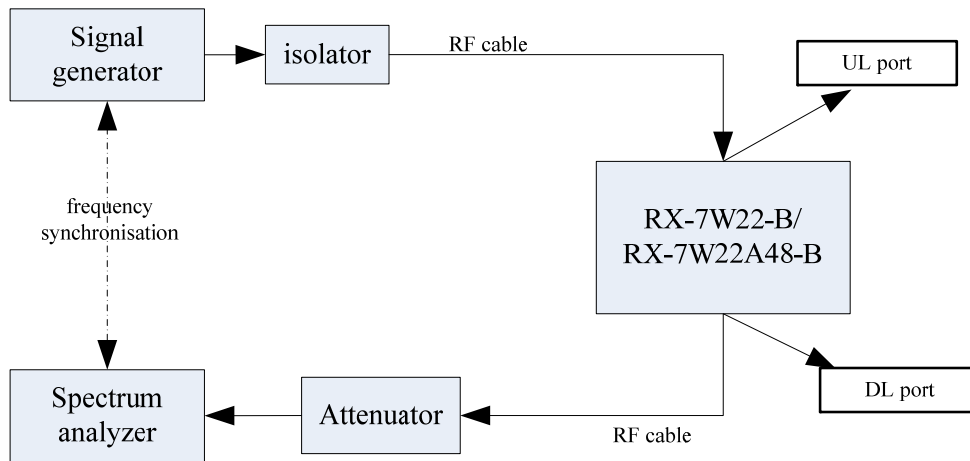

Figure 2: Maximum output power arrangement for Uplink

6.1.3 Test procedures

- (1) Connect the device as illustrated Figure 1 and Figure 2, when the output power is over the maximum value of the Spectrum Analyzer, add the attenuator to avoid destroying.
- (2) The signal generator should initially be configured to produce either of the required test signals (i.e., broadband).
- (3) Set the signal generator frequency to the center frequency of the EUT operating band.
- (4) While monitoring the output power of the EUT, measured using the methods of in KDB Publication 971168 [R8], increase the input level until a 1 dB increase in the input signal power no longer causes a 1 dB increase in the output signal power.
- (5) Record this level as the ALC threshold level.
- (6) Repeat the procedure with the remaining test signal.
- (7) Repeat RF channels to be tested for single-carrier: Low frequency and High frequency.

Note: The device has ALC function.

6.1.4 Test Results

6.1.4.1 700MHz Band

6.1.4.1.1 Modulation signal: LTE

Resolution Bandwidth:	100kHz
Video Bandwidth:	1MHz
Configuration:	Single Band
Carrier band:	10MHz
Operating frequency range:	Downlink: 758MHz~768MHz Uplink:788MHz~798MHz

Carrier frequency (MHz)	Input power (dBm)	Output power ^{1*} (dBm)	Limit(dBm)	Margin ^{2*} (dB)	Result
1. Input Power: AC 120V, 50/60Hz					
(1). Downlink transmit mode					
763.0	-57.20	33.74	37.00	-3.26	pass
(2). Uplink transmit mode					
793.0	-63.30	26.60	37.00	-10.40	pass
2. Input Power: DC -48V					
(3). Downlink transmit mode					
763.0	-57.20	33.03	37.00	-3.34	pass
(4). Uplink transmit mode					
793.0	-62.80	26.60	37.00	-10.50	pass
Note: 1*--Output power means to Maximum value from output port (with ALC). 2*--Margin= Maximum ERP- specification limit.					

6.1.4.1.2 Modulation signal: C4FM

Resolution Bandwidth:	100 Hz
Video Bandwidth:	300 Hz
Detector mode:	Peak
Trace mode:	RMS
Symbol Rate:	4.8ksps
Configuration:	Single Band
Operating frequency range:	Downlink: 769MHz~775MHz Uplink:799MHz~805MHz

Carrier frequency (MHz)	Input power (dBm)	Output power ^{1*} (dBm)	Limit(dBm)	Margin ^{2*} (dB)	Result
1. Input Power: AC 120V,50/60Hz					
(1). Downlink transmit mode					
769.00625	-56.50	32.73	37.00	-4.27	pass
772.00625	-57.10	32.70	37.00	-4.30	pass
774.99375	-57.00	32.32	37.00	-4.68	pass
(2). Uplink transmit mode					
799.00625	-62.80	27.15	37.00	-9.85	pass
802.00625	-63.00	27.27	37.00	-9.73	pass
804.99375	-63.20	27.28	37.00	-9.72	pass
2. Input Power: DC -48V					
(3). Downlink transmit mode					
769.00625	-56.40	33.15	37.00	-3.85	pass
772.00625	-57.20	33.09	37.00	-3.91	pass
774.99375	-56.60	32.82	37.00	-4.18	pass
(4). Uplink transmit mode					
799.00625	-63.00	26.80	37.00	-10.20	pass
802.00625	-63.00	27.01	37.00	-9.99	pass
804.99375	-63.00	27.01	37.00	-9.99	pass
Note:					
1*--Output power means to Maximum value from output port (with ALC).					
2*--Margin= Maximum ERP- specification limit.					

6.1.4.1.3 Modulation signal: Tetra

Resolution Bandwidth:	300 Hz
Video Bandwidth:	1 kHz
Detector mode:	Peak
Trace mode:	RMS
Symbol Rate:	18ksps
Configuration:	Single Band
Operating frequency range:	Downlink: 769MHz~775MHz Uplink:799MHz~805MHz

Carrier frequency (MHz)	Input power (dBm)	Output power ^{1*} (dBm)	Limit(dBm)	Margin ^{2*} (dB)	Result
1. Input Power: AC 120V,50/60Hz					
(1). Downlink transmit mode					
769.0125	-56.90	32.69	37.00	-4.31	pass
772.0125	-57.20	32.61	37.00	-4.39	pass
774.9875	-57.10	32.34	37.00	-4.64	pass
(2). Uplink transmit mode					
799.0125	-62.60	27.40	37.00	-9.60	pass
802.0125	-62.70	27.52	37.00	-9.48	pass
804.9875	-62.90	27.53	37.00	-9.47	pass
2. Input Power: DC -48V					
(3). Downlink transmit mode					
769.0125	-56.50	33.14	37.00	-3.86	pass
772.0125	-57.20	33.08	37.00	-3.92	pass
774.9875	-56.70	32.81	37.00	-4.19	pass
(4). Uplink transmit mode					
799.0125	-62.70	27.20	37.00	-9.80	pass
802.0125	-62.90	27.33	37.00	-9.67	pass
804.9875	-62.90	27.32	37.00	-9.68	pass
Note: 1*--Output power means to Maximum value from output port (with ALC). 2*--Margin= Maximum ERP- specification limit.					

6.1.4.1.4 Modulation signal: Analog FM

Resolution Bandwidth:	300 Hz
Video Bandwidth:	1 kHz
Detector mode:	Peak
Trace mode:	RMS
Symbol Rate:	1ksps
Frequency Dev:	10kHz
Configuration:	Single Band
Operating frequency range:	Downlink: 769MHz~775MHz Uplink:799MHz~805MHz

Carrier frequency (MHz)	Input power (dBm)	Output power ^{1*} (dBm)	Limit(dBm)	Margin ^{2*} (dB)	Result
1. Input Power: AC 120V,50/60Hz					
(1). Downlink transmit mode					
769.0125	-56.80	33.61	37.00	-3.39	pass
772.0125	-57.20	33.54	37.00	-3.46	pass
774.9875	-57.10	33.24	37.00	-3.76	pass
(2). Uplink transmit mode					
799.0125	-62.90	27.11	37.00	-9.89	pass
802.0125	-62.90	27.26	37.00	-9.74	pass
804.9875	-63.20	27.26	37.00	-9.74	pass
2. Input Power: DC -48V					
(3). Downlink transmit mode					
769.0125	-56.40	33.20	37.00	-3.80	pass
772.0125	-57.20	33.12	37.00	-3.88	pass
774.9875	-56.60	32.84	37.00	-4.16	pass
(4). Uplink transmit mode					
799.0125	-63.00	26.90	37.00	10.10	pass
802.0125	-63.10	27.03	37.00	-9.97	pass
804.9875	-63.10	27.04	37.00	-9.96	pass
Note: 1*--Output power means to Maximum value from output port (with ALC). 2*--Margin= Maximum ERP- specification limit.					

6.1.4.2 800MHz Band

6.1.4.2.1 Modulation signal: C4FM

Resolution Bandwidth:	100 Hz
Video Bandwidth:	300 Hz
Detector used:	RMS
Configuration:	Single Band
Symbol Rate:	4.8ksps
Operating frequency range:	Downlink: 851MHz~862MHz Uplink:806MHz~817MHz

Carrier frequency (MHz)	Input power (dBm)	Output power ^{1*} (dBm)	Limit(dBm)	Margin ^{2*} (dB)	Result
1. Input Power: AC 120V, 50/60Hz					
(1). Downlink transmit mode					
851.00625	-55.80	33.35	37.00	-3.65	pass
856.50625	-56.20	33.41	37.00	-3.59	pass
861.99375	-57.00	33.41	37.00	-3.59	pass
(2). Uplink transmit mode					
806.00625	-62.10	27.39	37.00	-9.61	pass
811.50625	-61.90	27.43	37.00	-9.57	pass
816.99375	-62.10	27.45	37.00	-9.55	pass
2. Input Power: DC -48V					
(3). Downlink transmit mode					
851.00625	-55.50	33.39	37.00	-3.61	pass
856.50625	-56.20	33.61	37.00	-3.39	pass
861.99375	-56.90	33.31	37.00	-3.69	pass
(4). Uplink transmit mode					
806.00625	-62.10	27.14	37.00	-9.86	pass
811.50625	-62.00	27.30	37.00	-9.70	pass
816.99375	-60.70	27.16	37.00	-9.84	pass
Note:					
1*--Output power means to Maximum value from output port (with ALC).					
2*--Margin= Maximum ERP- specification limit.					

6.1.4.2.2 Modulation signal: Tetra

Resolution Bandwidth:	300 Hz
Video Bandwidth:	1 kHz
Detector used:	RMS
Configuration:	Single Band
Symbol Rate:	18ksps
Operating frequency range:	Downlink: 851MHz~862MHz Uplink:806MHz~817MHz

Carrier frequency (MHz)	Input power (dBm)	Output power ^{1*} (dBm)	Limit(dBm)	Margin ^{2*} (dB)	Result
1. Input Power: AC 120V,50/60Hz					
(1). Downlink transmit mode					
851.0125	-55.70	33.05	37.00	-3.95	pass
856.5125	-56.70	33.42	37.00	-3.58	pass
861.9875	-57.40	33.41	37.00	-3.69	pass
(2). Uplink transmit mode					
806.0125	-61.90	27.55	37.00	-9.45	pass
811.5125	-62.00	27.55	37.00	-9.45	pass
816.9875	-61.90	27.65	37.00	-9.35	pass
2. Input Power: DC -48V					
(3). Downlink transmit mode					
851.0125	-55.50	33.34	37.00	-3.66	pass
856.5125	-56.20	33.62	37.00	-3.38	pass
861.9875	-57.00	33.24	37.00	-3.76	pass
(4). Uplink transmit mode					
806.0125	-62.00	27.44	37.00	-9.56	pass
811.5125	-61.80	27.60	37.00	-9.40	pass
816.9875	-61.60	27.43	37.00	-9.57	pass
Note: 1*--Output power means to Maximum value from output port (with ALC). 2*--Margin= Maximum ERP- specification limit.					

6.1.4.2.3 Modulation signal: Analog FM

Resolution Bandwidth:	300 Hz
Video Bandwidth:	1 kHz
Detector used:	RMS
Configuration:	Single Band
Symbol Rate:	1ksps
Frequency Dev:	10kHz
Operating frequency range:	Downlink: 851MHz~862MHz Uplink:806MHz~817MHz

Carrier frequency (MHz)	Input power (dBm)	Output power ^{1*} (dBm)	Limit(dBm)	Margin ^{2*} (dB)	Result
1. Input Power: AC 120V,50/60Hz					
(1). Downlink transmit mode					
851.0125	-55.90	33.33	37.00	-3.67	pass
856.5125	-56.60	33.38	37.00	-3.62	pass
861.9875	-57.00	33.38	37.00	-3.62	pass
(2). Uplink transmit mode					
806.0125	-62.10	27.40	37.00	-9.60	pass
811.5125	-62.00	27.27	37.00	-9.73	pass
816.9875	-61.50	27.45	37.00	-9.55	pass
2. Input Power: DC -48V					
(3). Downlink transmit mode					
851.0125	-55.70	33.40	37.00	-3.60	pass
856.5125	-56.20	33.59	37.00	-3.41	pass
861.9875	-56.90	33.29	37.00	-3.71	pass
(4). Uplink transmit mode					
806.0125	-62.20	27.15	37.00	-9.85	pass
811.5125	-62.10	27.31	37.00	-9.69	pass
816.9875	-61.70	27.20	37.00	-9.80	pass
Note:					
1*--Output power means to Maximum value from output port (with ALC).					
2*--Margin= Maximum ERP- specification limit.					

6.1.5 Test screenshot

6.1.5.1 700MHz Band

6.1.5.1.1 Modulation signal: LTE

1). AC 120V, 50/60Hz

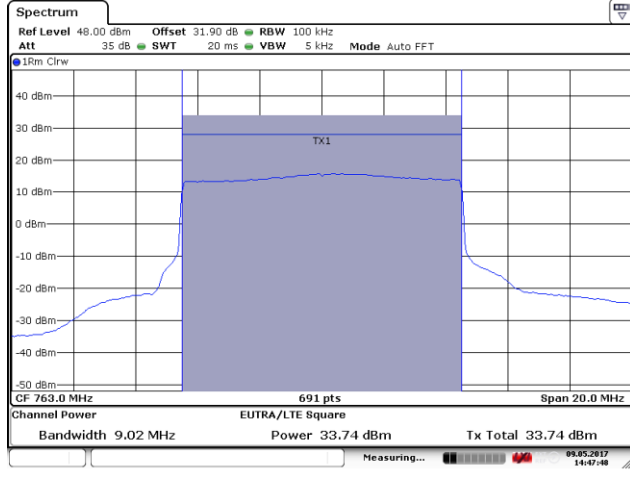

Downlink Frequency: 763MHz

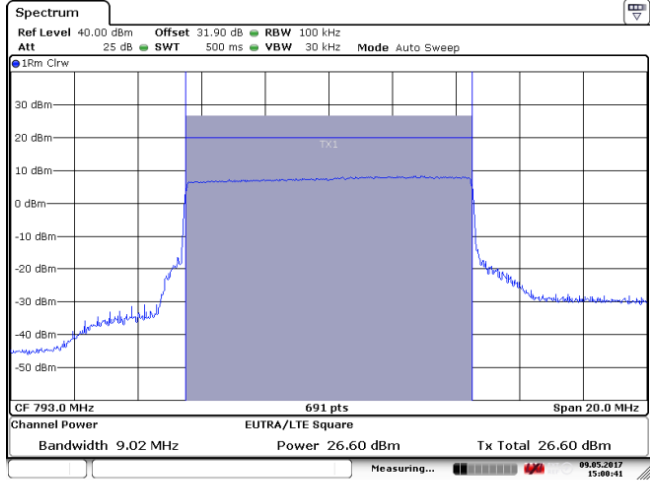

Uplink Frequency: 793MHz

2). DC -48V

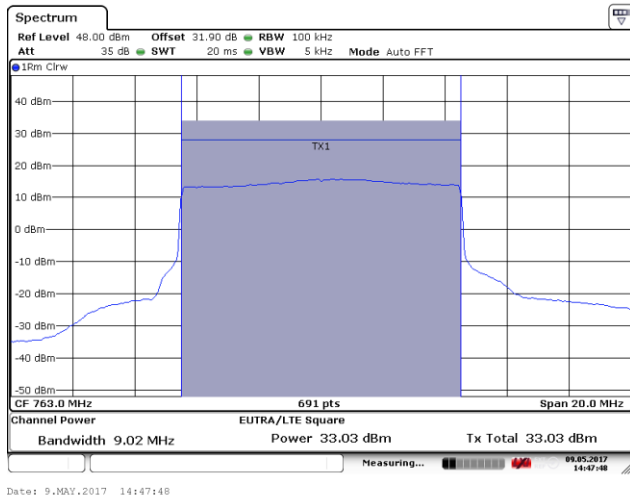

Downlink Frequency: 763MHz

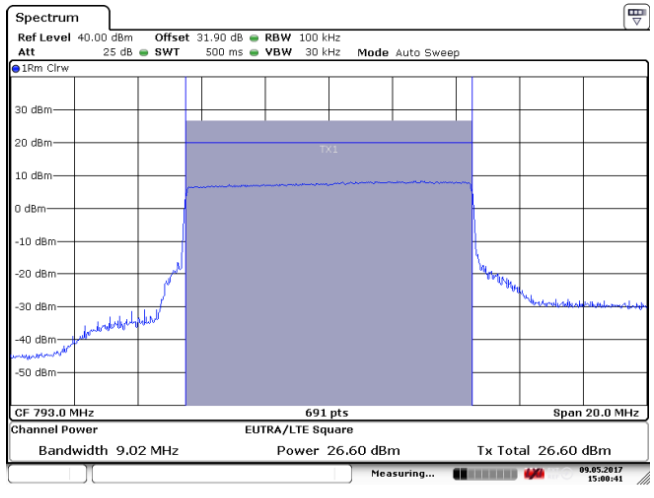

Uplink Frequency: 793MHz

6.1.5.1.2 Modulation signal: C4FM

(1) Downlink

1). AC 120V, 50/60Hz

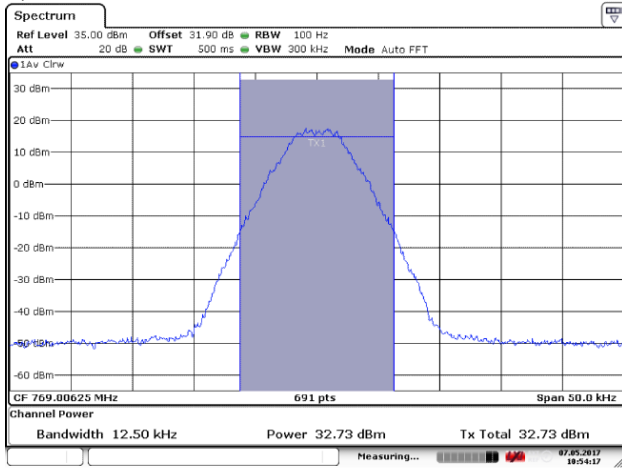

Date: 7.MAY.2017 10:54:17

Low Frequency: 769.00625MHz

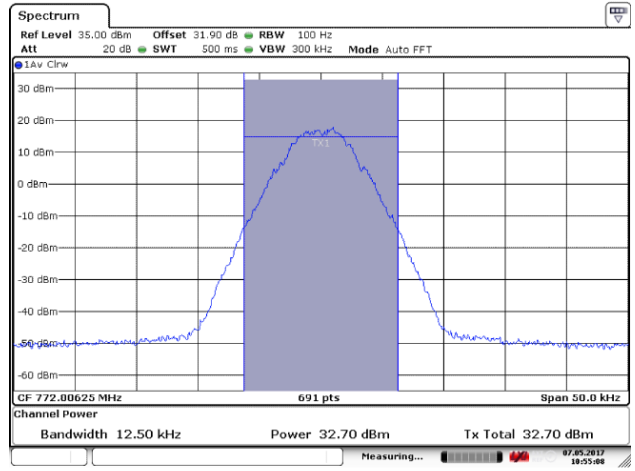

Date: 7.MAY.2017 10:55:08

Mid Frequency: 772.00625MHz

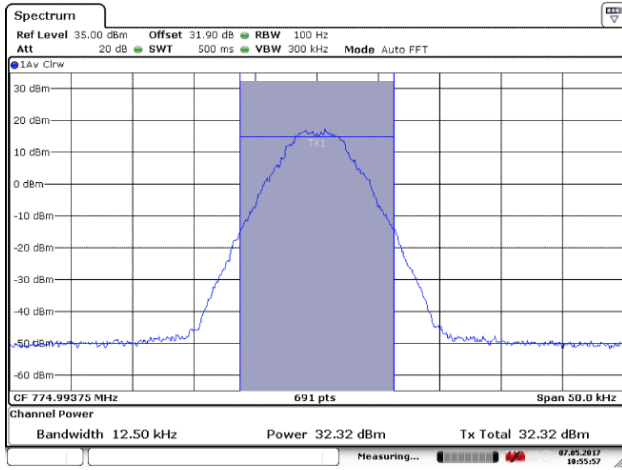

Date: 7.MAY.2017 10:55:57

High Frequency: 774.99375MHz

2). DC -48V

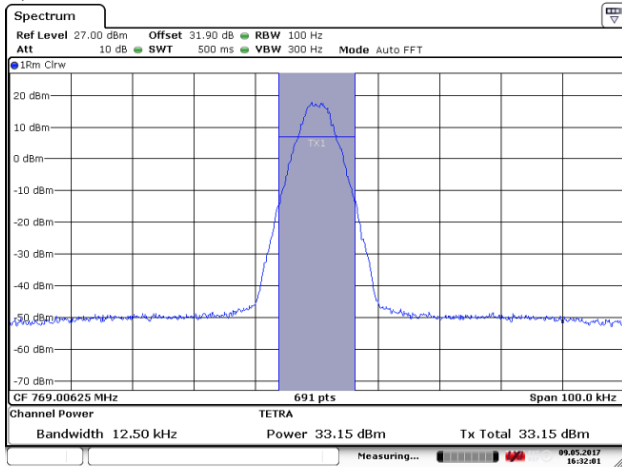

Date: 9.MAY.2017 16:32:01

Low Frequency: 769.00625MHz

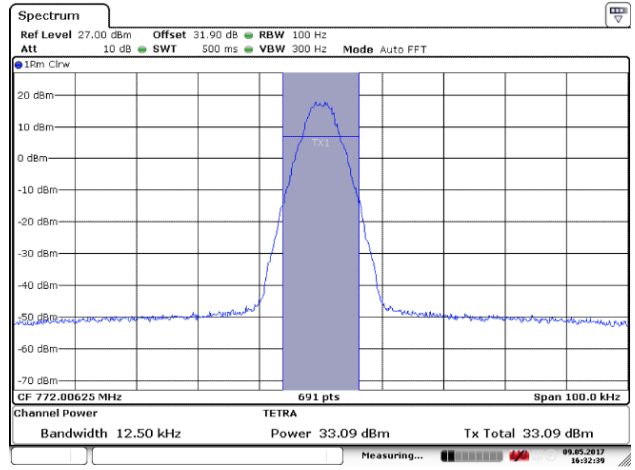

Date: 9.MAY.2017 16:32:39

Mid Frequency: 772.00625MHz

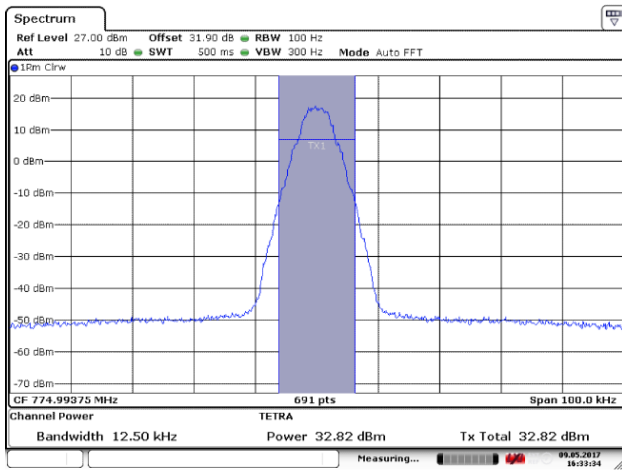

High Frequency: 774.99375MHz

(2) Uplink

1). AC 120V, 50/60Hz

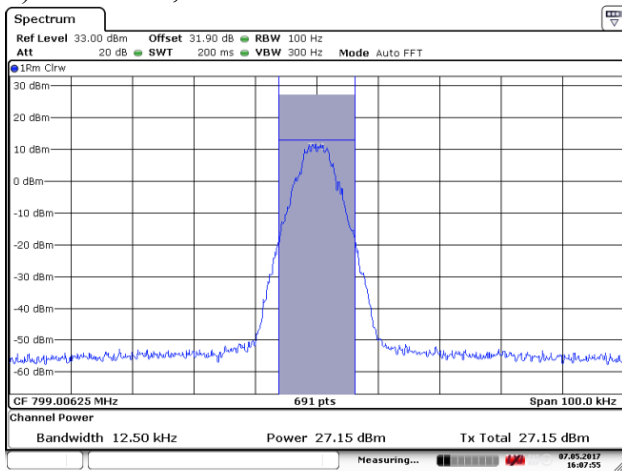

Low Frequency: 799.00625MHz

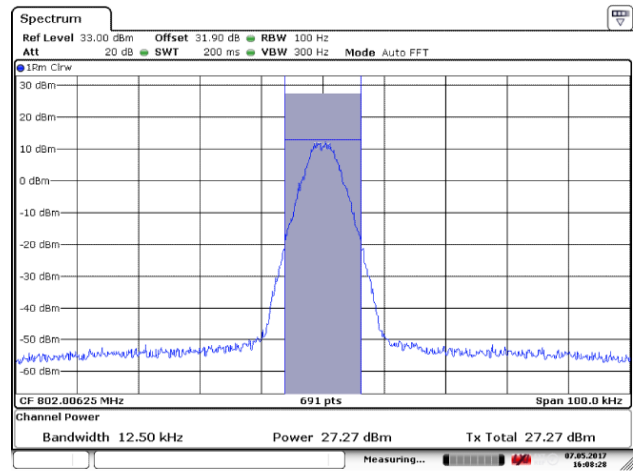

Mid Frequency: 802.00625MHz

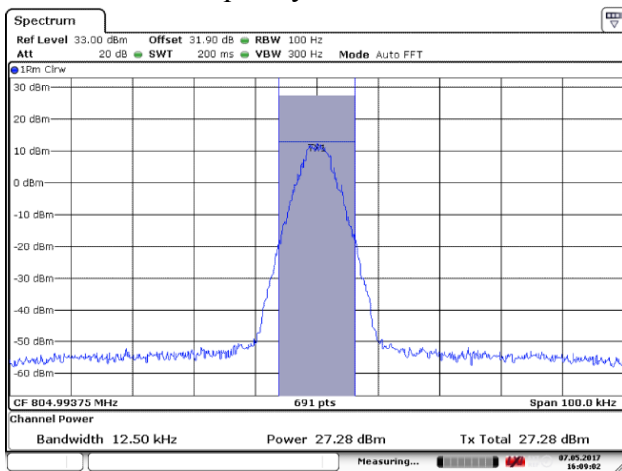

High Frequency: 804.99375MHz

2). DC -48V

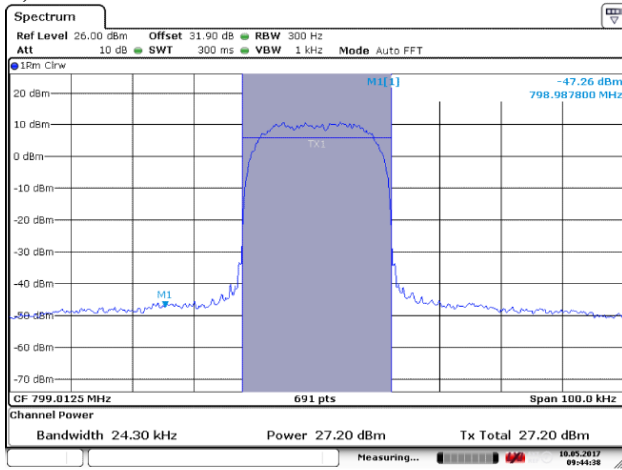

Low Frequency: 799.00625MHz

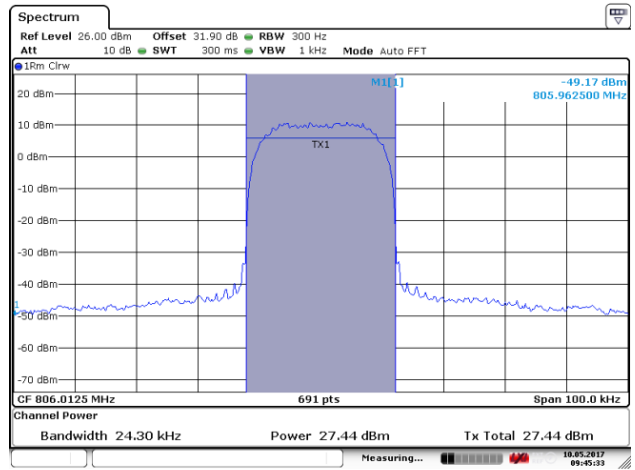

Mid Frequency: 802.00625MHz

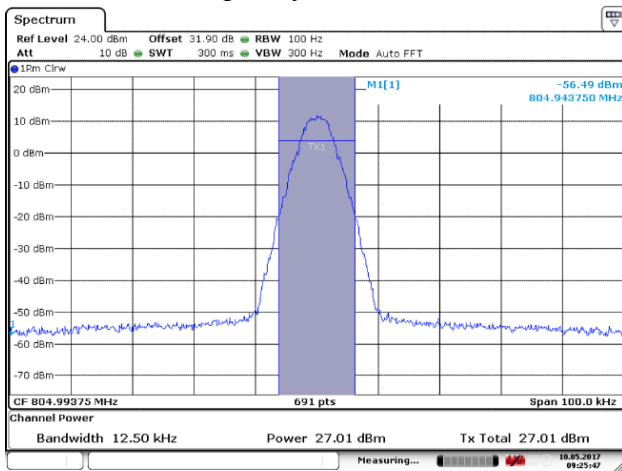

High Frequency: 804.99375MHz

6.1.5.1.3 Modulation signal: Tetra

(1) Downlink

1). AC 120V, 50/60Hz

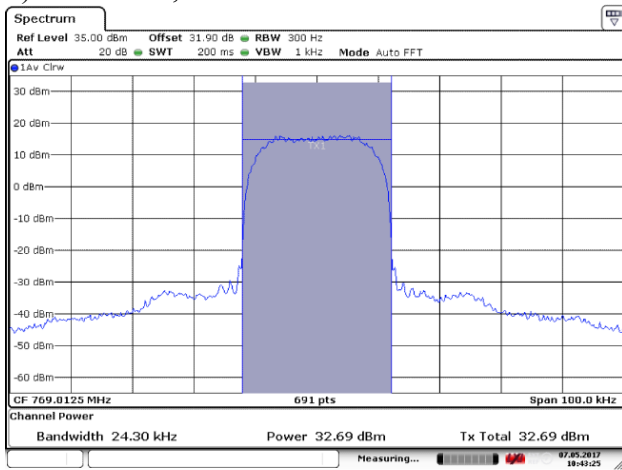

Low Frequency: 769.0125MHz

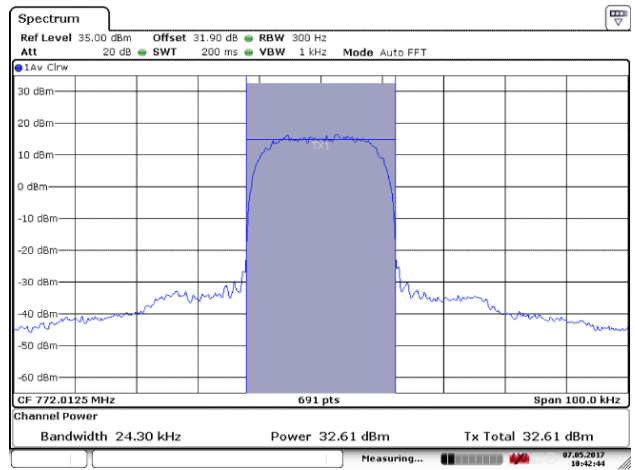

Mid Frequency: 772.0125MHz

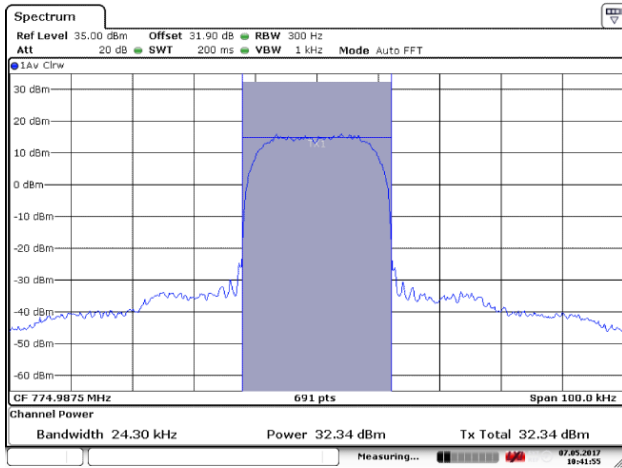

High Frequency: 774.9875MHz

2). DC -48V

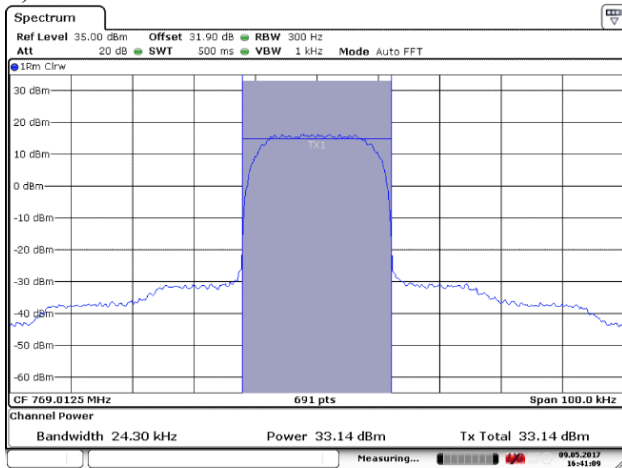

Low Frequency: 769.0125MHz

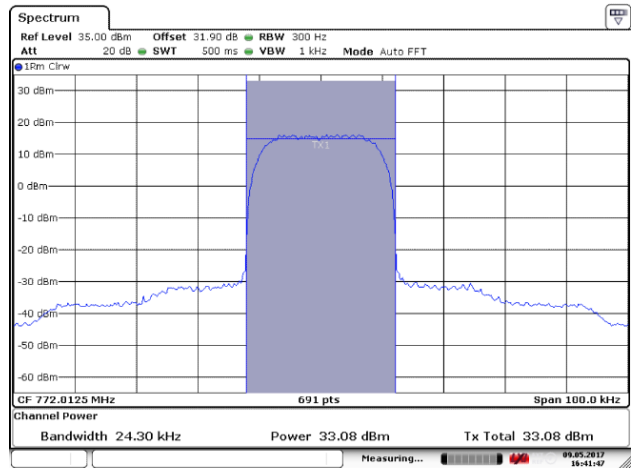

Mid Frequency: 772.0125MHz

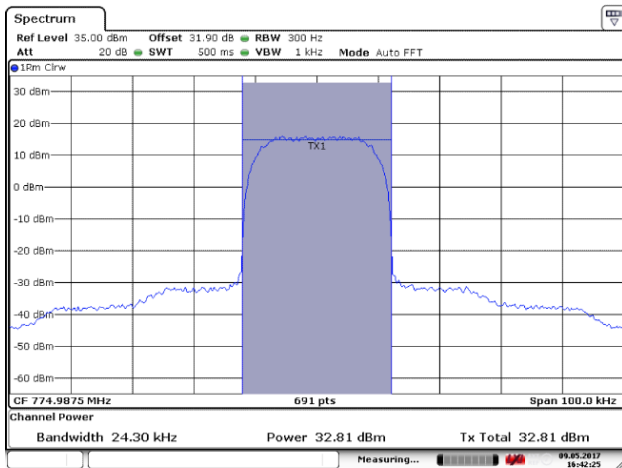

High Frequency: 774.9875MHz

(2) Uplink

1). AC 120V, 50/60Hz

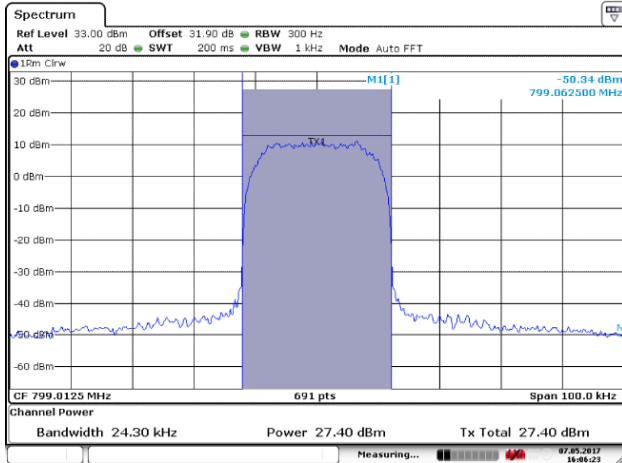

Low Frequency: 799.0125MHz

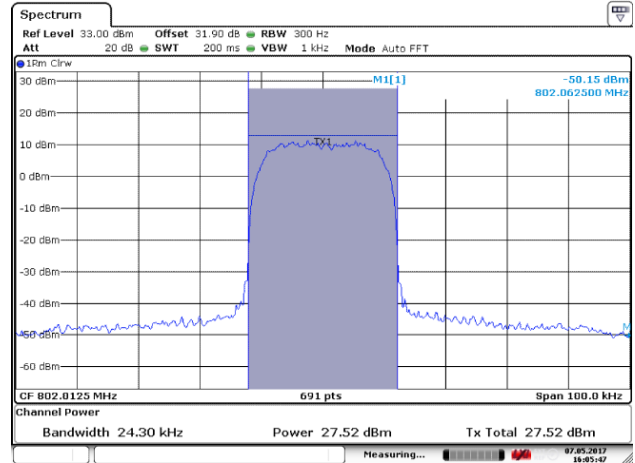

Mid Frequency: 802.0125MHz

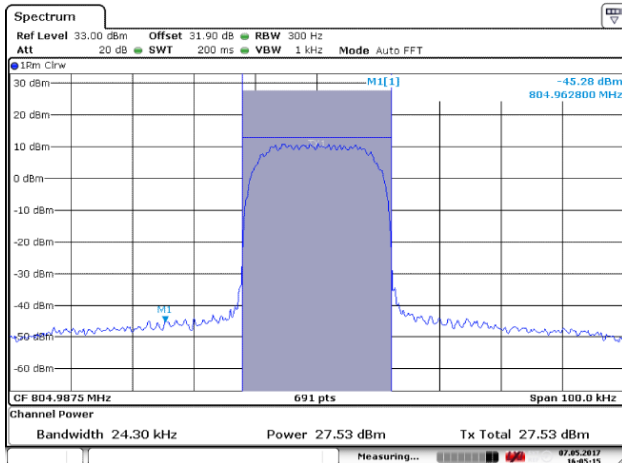

High Frequency: 804.9875MHz

2). DC -48V

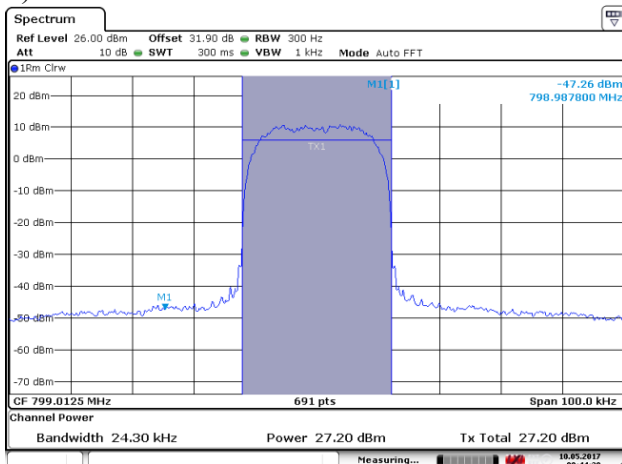

Low Frequency: 799.0125MHz

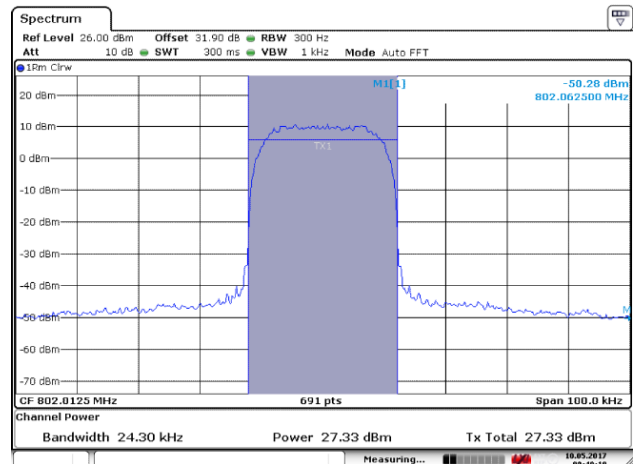

Mid Frequency: 802.0125MHz

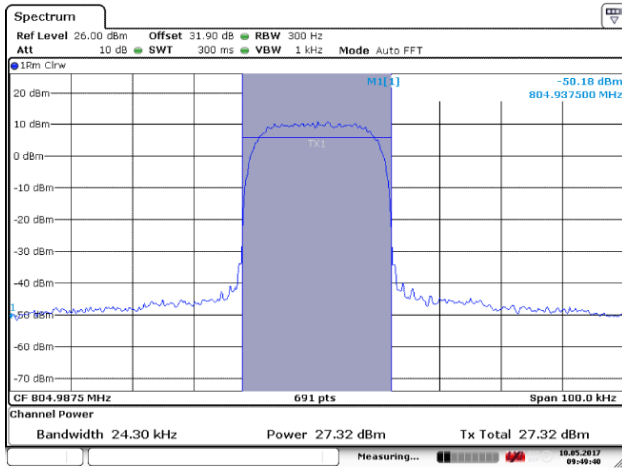

High Frequency: 804.9875MHz

6.1.5.1.4 Modulation signal: Analog FM(10kHz/1kHz)

(1) Downlink

1). AC 120V, 50/60Hz

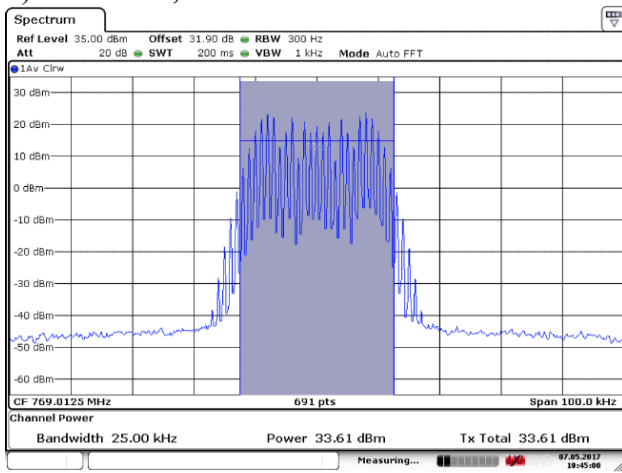

Low Frequency: 769.0125MHz

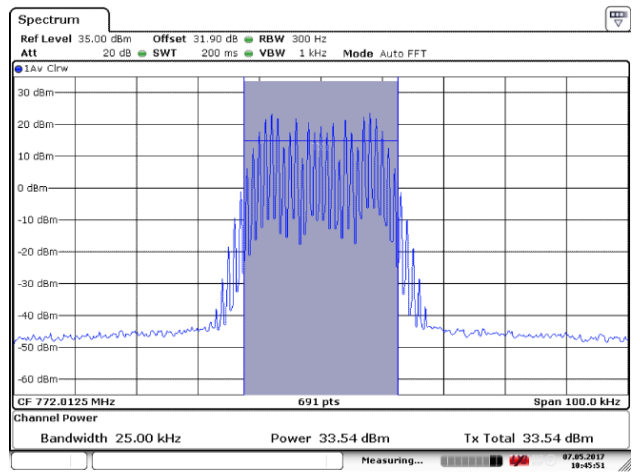

Mid Frequency: 772.0125MHz

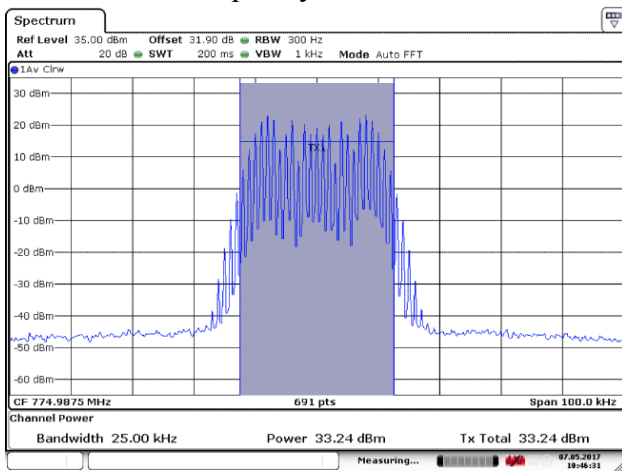

High Frequency: 774.9875MHz

2). DC -48V

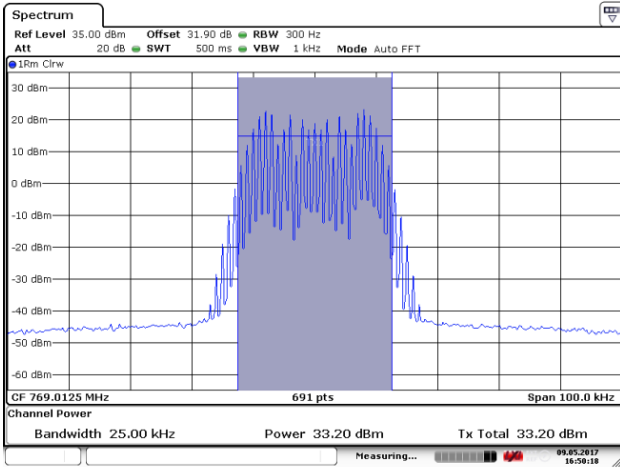

Low Frequency: 769.0125MHz

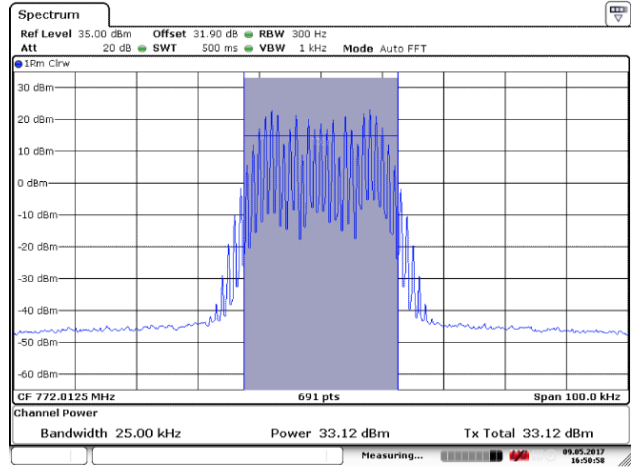

Mid Frequency: 772.0125MHz

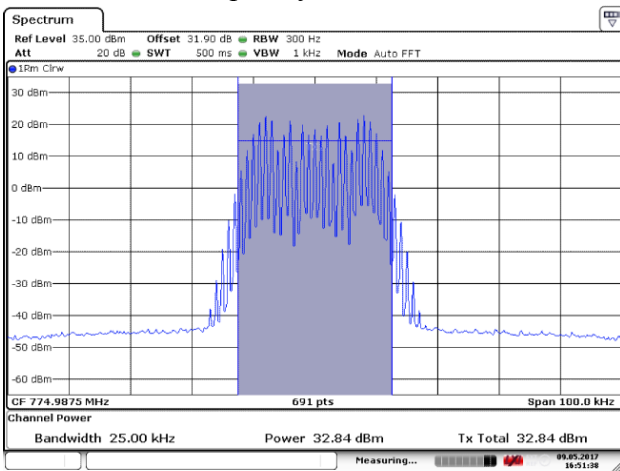

High Frequency: 774.9875MHz

(2) Uplink

1). AC 120V, 50/60Hz

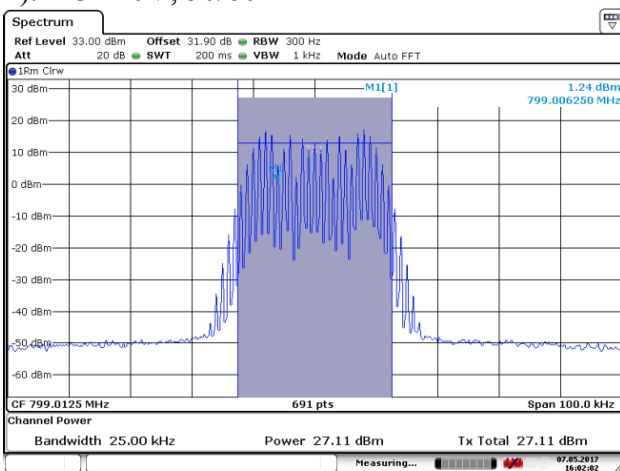

Low Frequency: 799.0125MHz

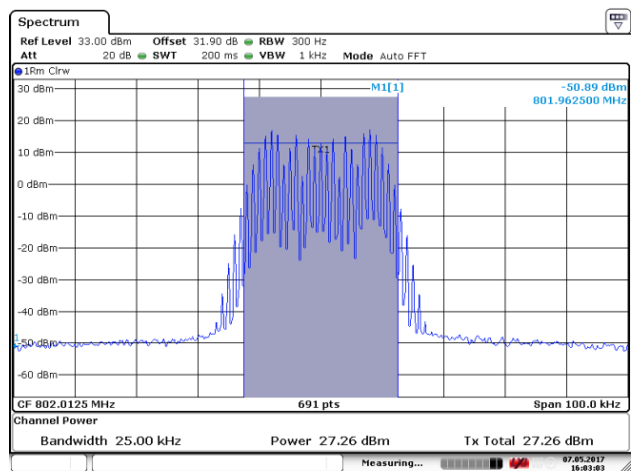

Mid Frequency: 802.0125MHz

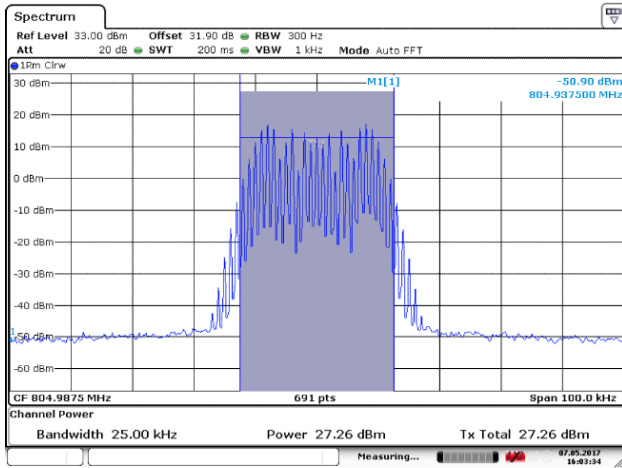

Date: 7.MAY.2017 16:03:34

High Frequency: 804.9875MHz

2). DC -48V

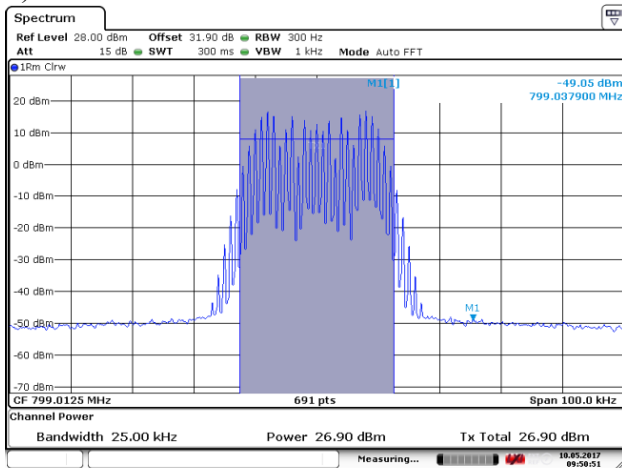

Date: 10.MAY.2017 09:50:51

Low Frequency: 799.0125MHz

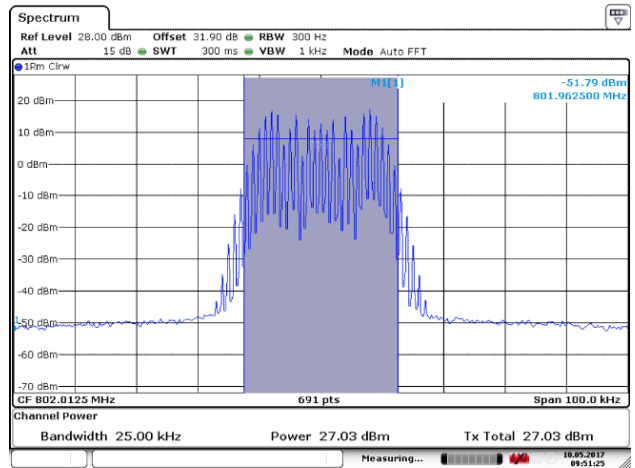

Date: 10.MAY.2017 09:51:25

Mid Frequency: 802.0125MHz

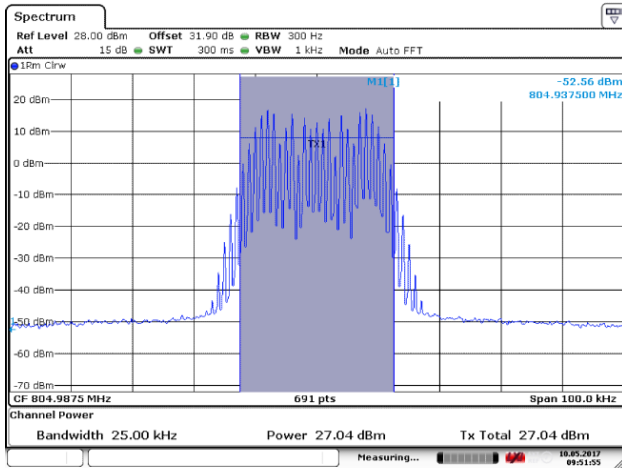

Date: 10.MAY.2017 09:51:55

High Frequency: 804.9875MHz

6.1.5.2 800MHz Band

6.1.5.2.1 Modulation signal: C4FM

(1) Downlink

1). AC 120V, 50/60Hz

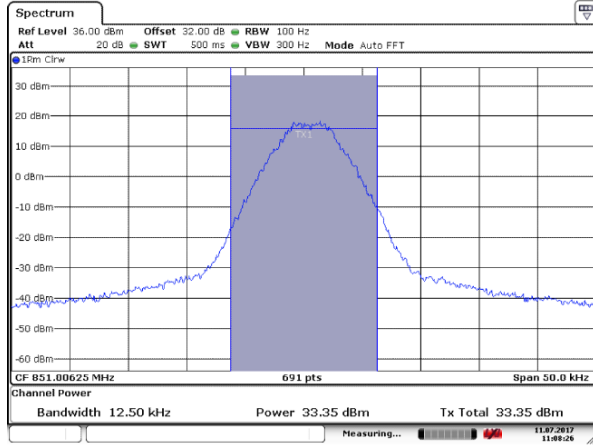

Date: 11.JUL.2017 11:08:26

Low Frequency: 851.00625MHz

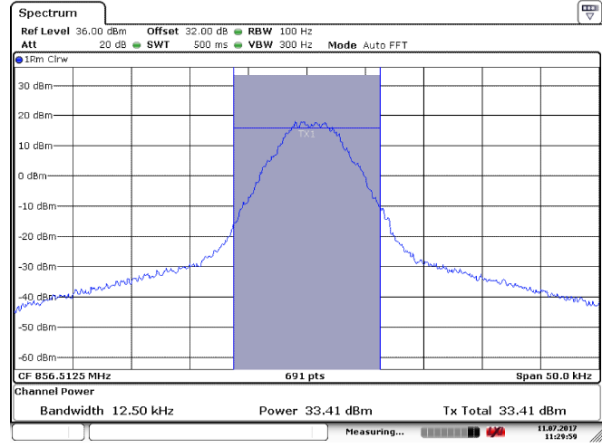

Date: 11.JUL.2017 11:29:59

Mid Frequency: 856.50625MHz

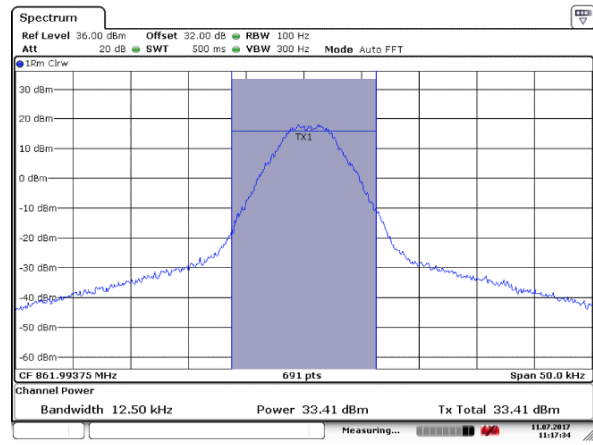

Date: 11.JUL.2017 11:17:34

High Frequency: 861.99375MHz

(2) Uplink

1). AC 120V, 50/60Hz

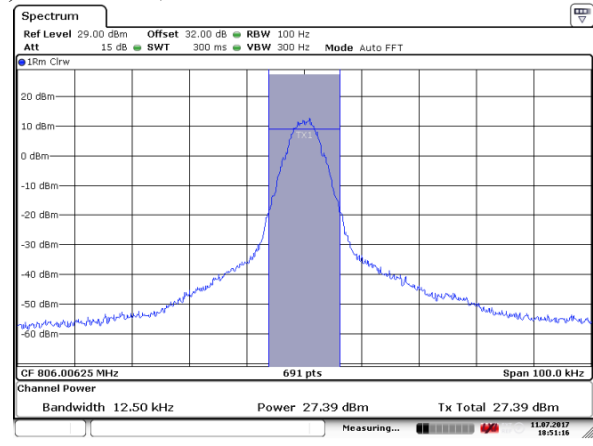

Date: 11.JUL.2017 18:51:16

Low Frequency: 806.00625MHz

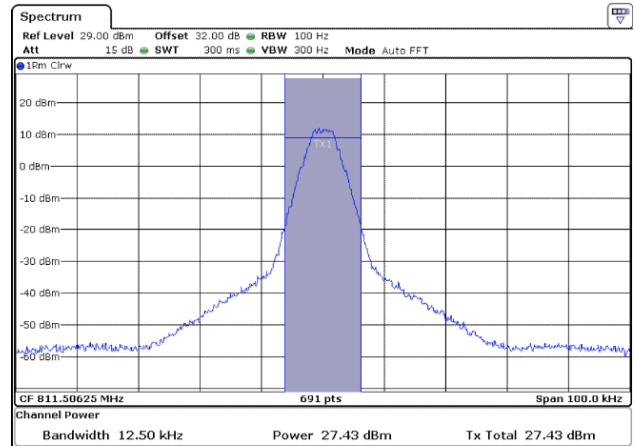

Date: 11.JUL.2017 18:52:45

Mid Frequency: 811.50625MHz

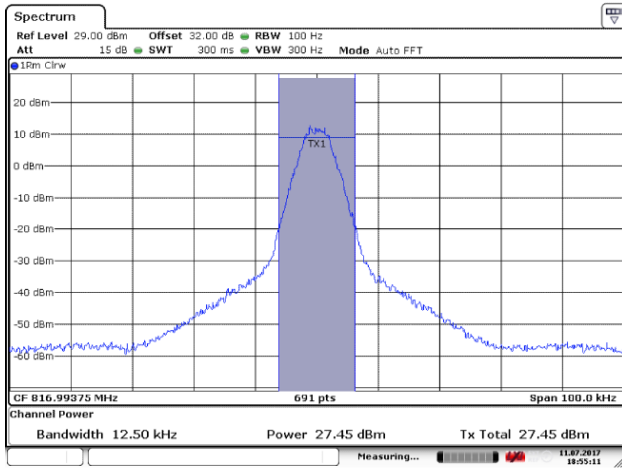

High Frequency: 816.99375MHz

6.1.5.2.2 Modulation signal: Tetra

(1) Downlink

1). AC 120V, 50/60Hz

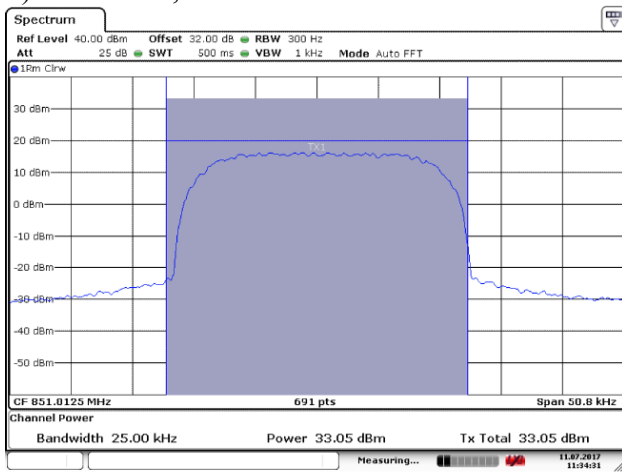

Low Frequency: 851.0125MHz

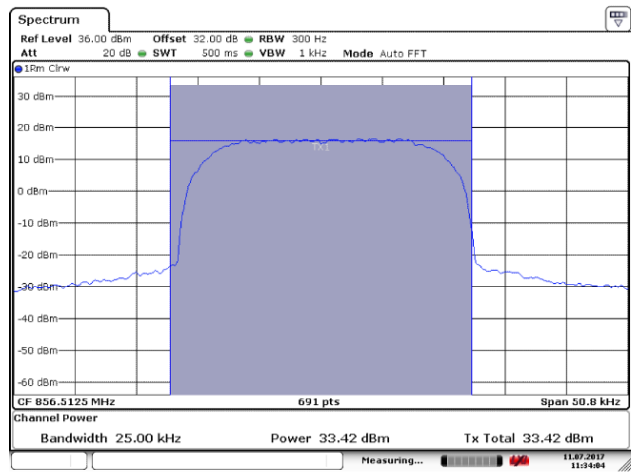

Mid Frequency: 856.5125MHz

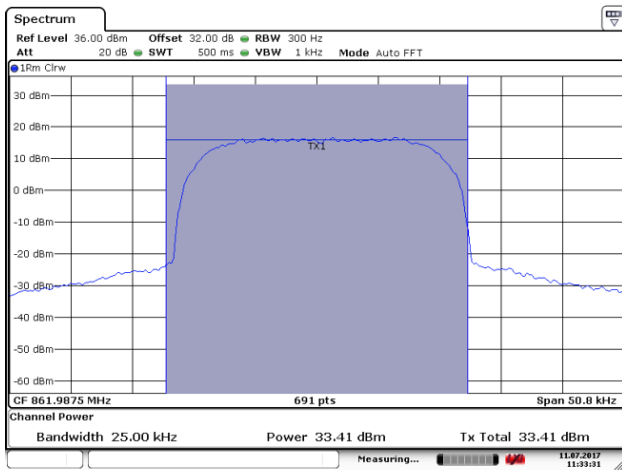

High Frequency: 861.9875MHz

(2) Uplink

1). AC 120V, 50/60Hz

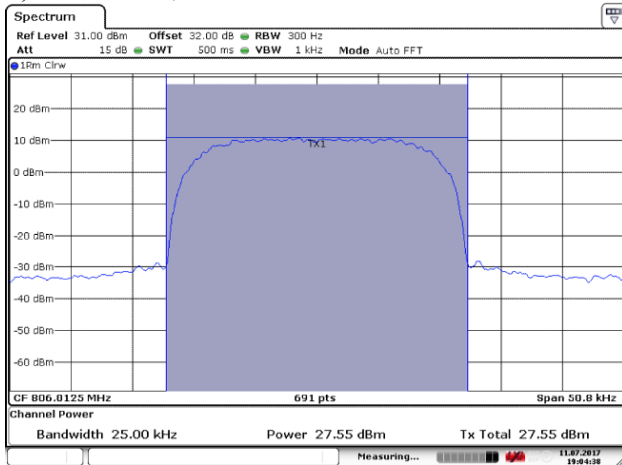

Low Frequency: 806.0125MHz

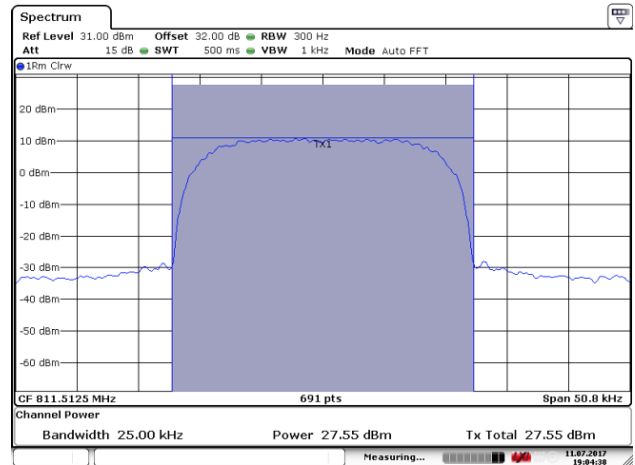

Mid Frequency: 811.5125MHz

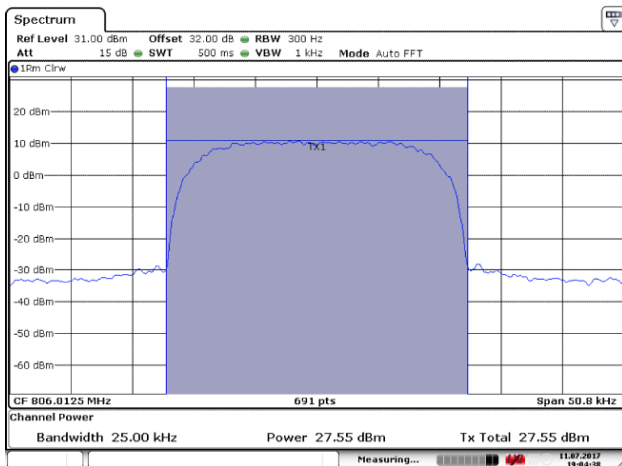

High Frequency: 816.9875MHz

6.1.5.2.3 Modulation signal: Analog FM(10kHz/1kHz)

(1) Downlink

1). AC 120V, 50/60Hz

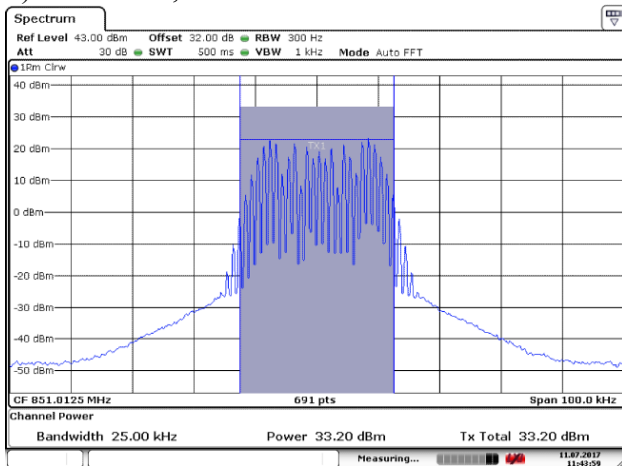

Low Frequency: 851.0125MHz

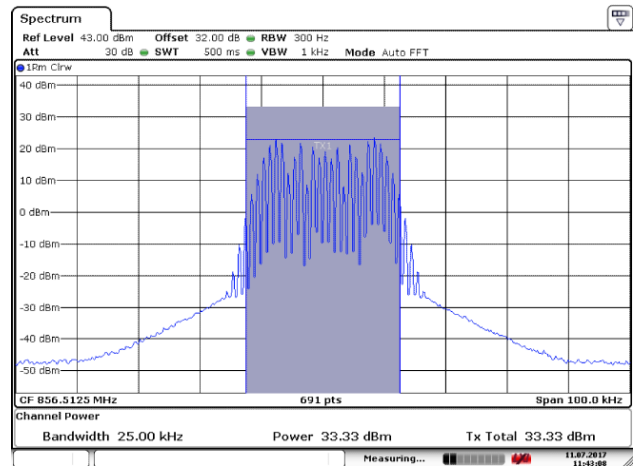

Mid Frequency: 856.5125MHz

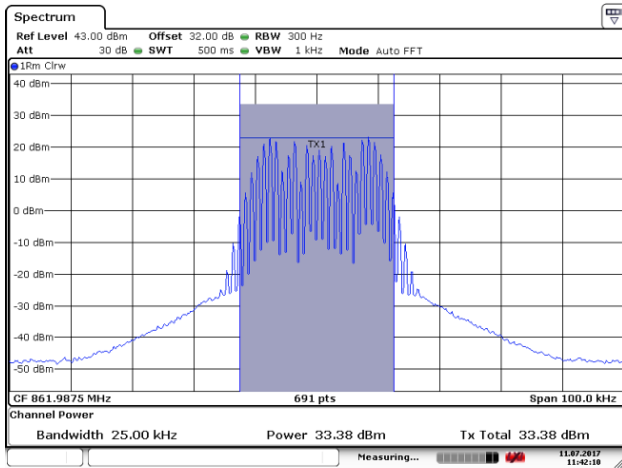

High Frequency: 861.9875MHz

(2) Uplink

1). AC 120V, 50/60Hz

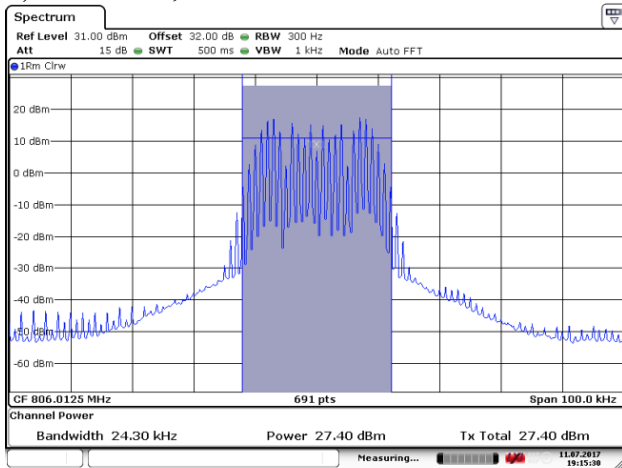

Low Frequency: 806.0125MHz

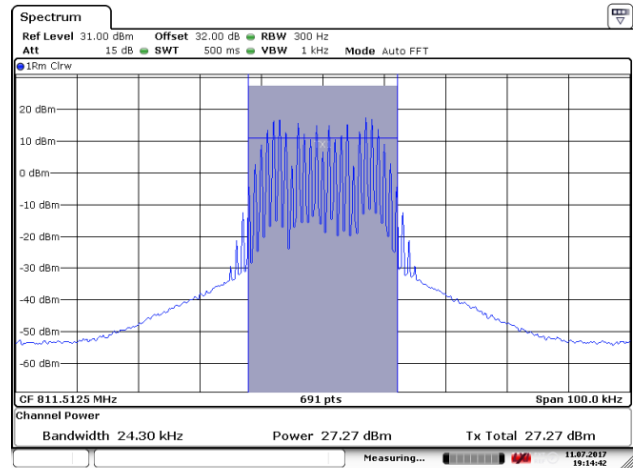

Mid Frequency: 811.5125MHz

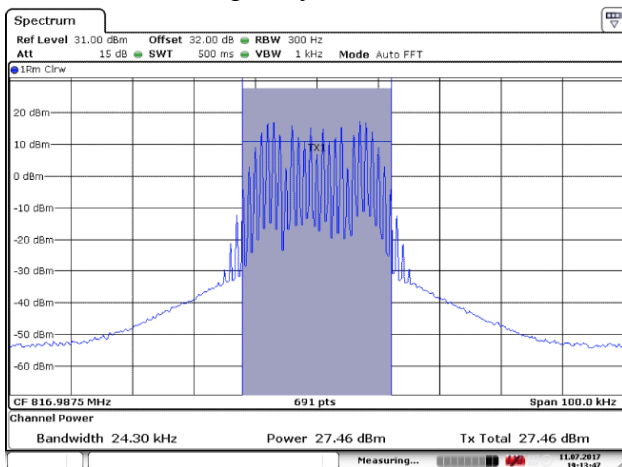

High Frequency: 816.9875MHz