

11.8.5.2.2.2. Uplink

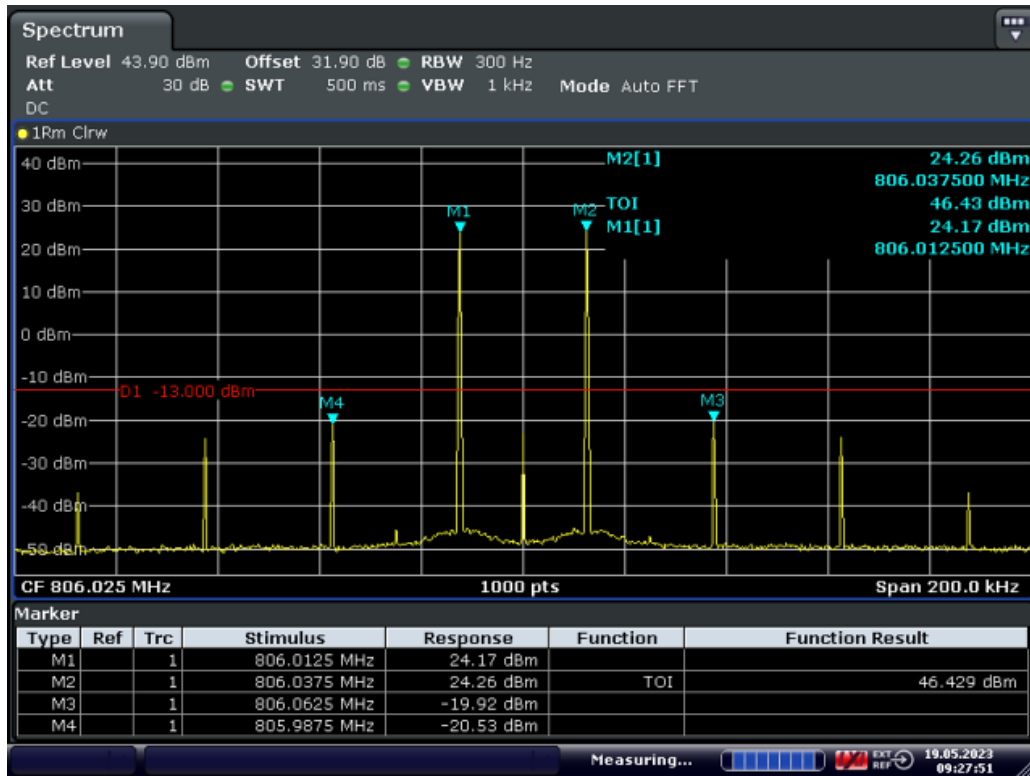

Date: 19.MAY.2023 09:27:51

Low Frequency and with the ALC threshold level

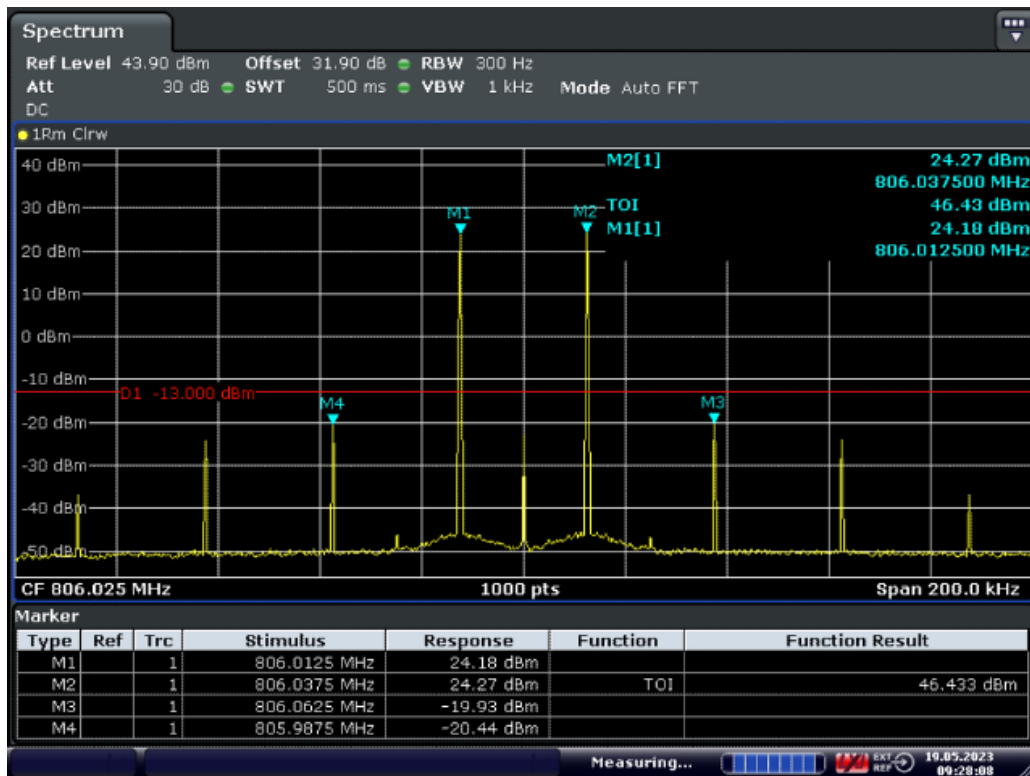

Date: 19.MAY.2023 09:28:08

Low Frequency and with the input signal amplitude set 3 dB above the ALC threshold

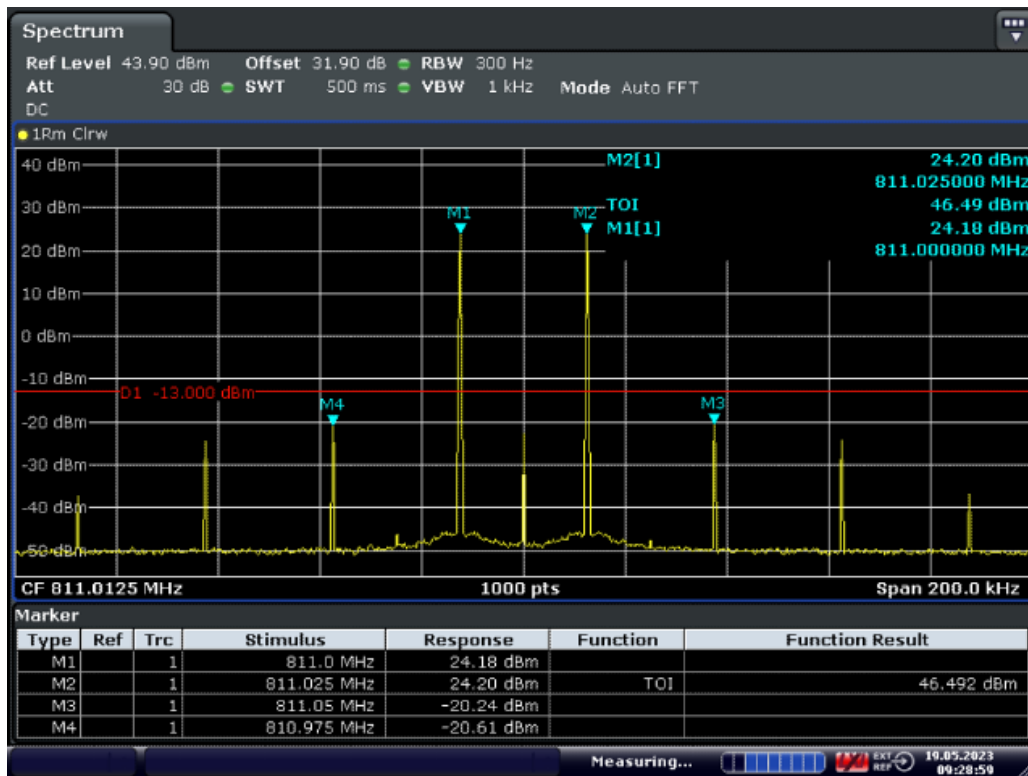

Date: 19.MAY.2023 09:28:59

Mid Frequency and with the ALC threshold level

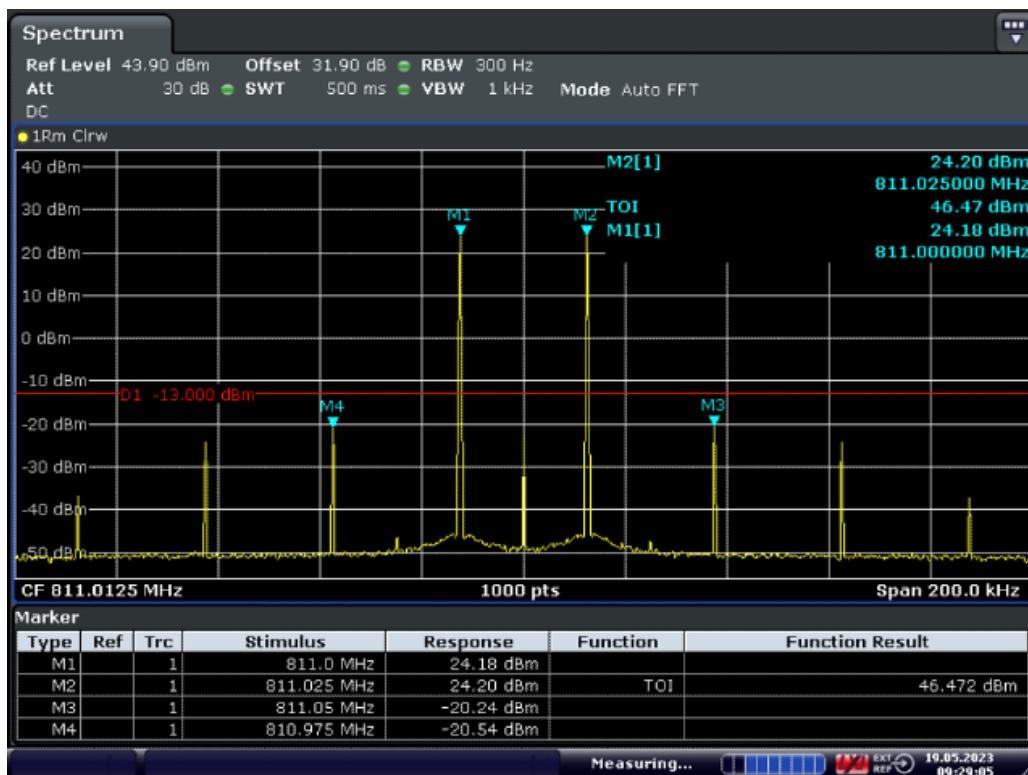

Date: 19.MAY.2023 09:29:05

Mid Frequency and with the input signal amplitude set 3 dB above the ALC threshold

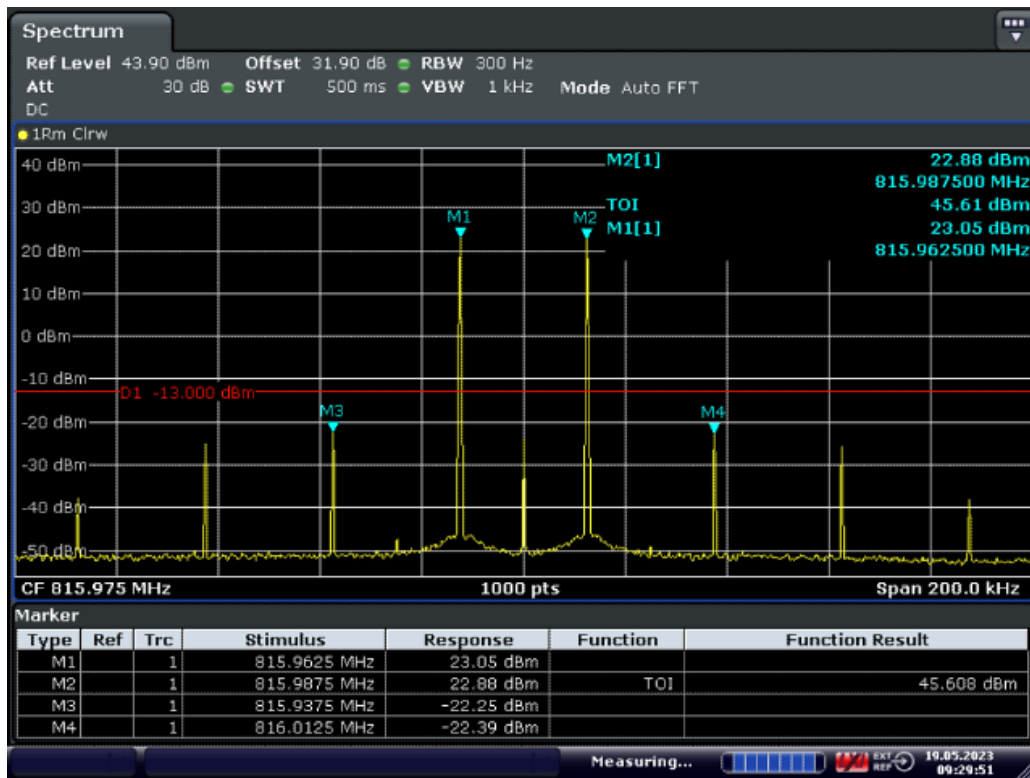

Date: 19.MAY.2023 09:29:51

High Frequency and with the ALC threshold level

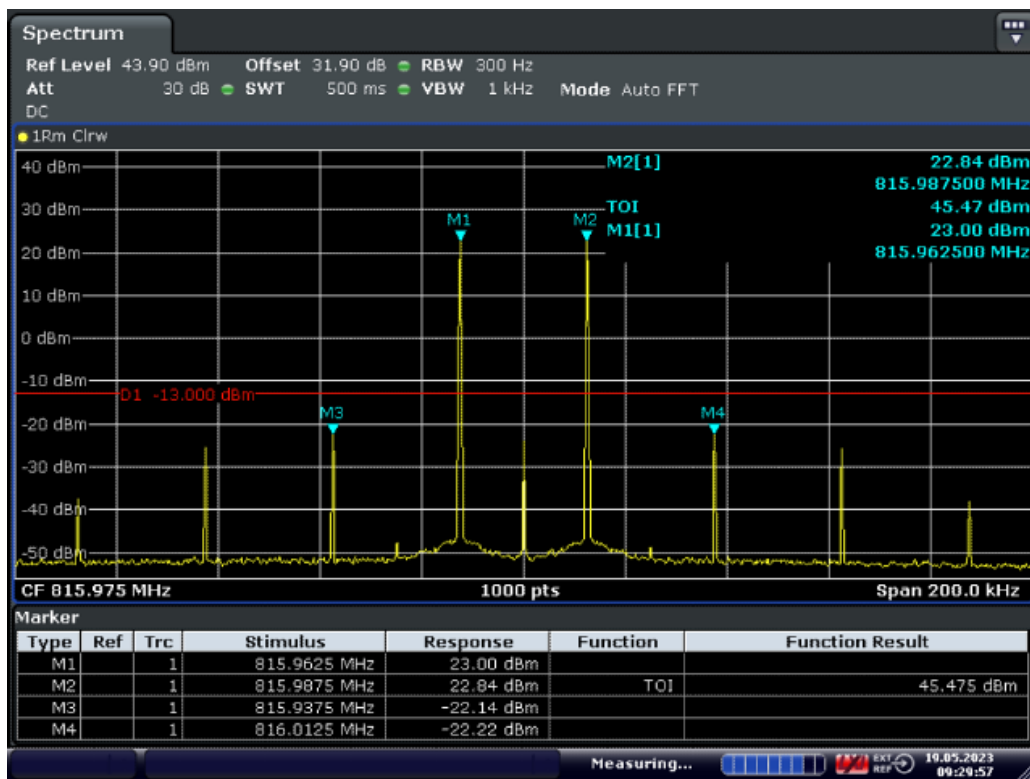

Date: 19.MAY.2023 09:29:57

High Frequency and with the input signal amplitude set 3 dB above the ALC threshold

11.9. Conducted spurious emissions

Test requirement: KDB 935210 D05 clause 4.7.3  
 FCC PART 2.1051  
 FCC PART 90.219 (e)(3)  
 Test Method: KDB 935210 D05/4.7.3

11.9.1. Limit

Refer to the applicable rule part(s) for specified limits on unwanted (out-of-band/out-of-block and spurious) emissions (e.g., Section 90.210).

Spurious emissions shall be measured using a single test signal sequentially tuned to the low, middle, and high channels or frequencies within each authorized frequency band of operation.

Intermodulation products shall be measured using two CW signals with all available channel spacings (e.g., 12.5 kHz and 6.25 kHz) with the center between these channels being equal to the center frequency  $f_0$  as determined from 4.3.

NOTE—Intermodulation-product spurious emission measurements are not required for single-channel boosters that cannot accommodate two simultaneous signals within the passband.

For a multi-channel enhancer, any intermodulation product level must be attenuated, relative to P, by at least:  $43 + 10 \cdot \log_{10} P$  is less stringent than 70dB, that limit was used.

Spurious emissions shall be measured using a single test signal sequentially tuned to the low, middle, and high channels or frequencies within each authorized frequency band of operation.

Out-of-band/out-of-block emissions (including intermodulation products) shall be measured under each of the following two stimulus conditions:

- a) two adjacent test signals sequentially tuned to the lower and upper frequency band/block edges;
- b) a single test signal, sequentially tuned to the lowest and highest frequencies or channels within the frequency band/block under examination.

NOTE—Single-channel boosters that cannot accommodate two simultaneous signals within the passband may be excluded from the test stipulated in step a).

11.9.2. Test configuration

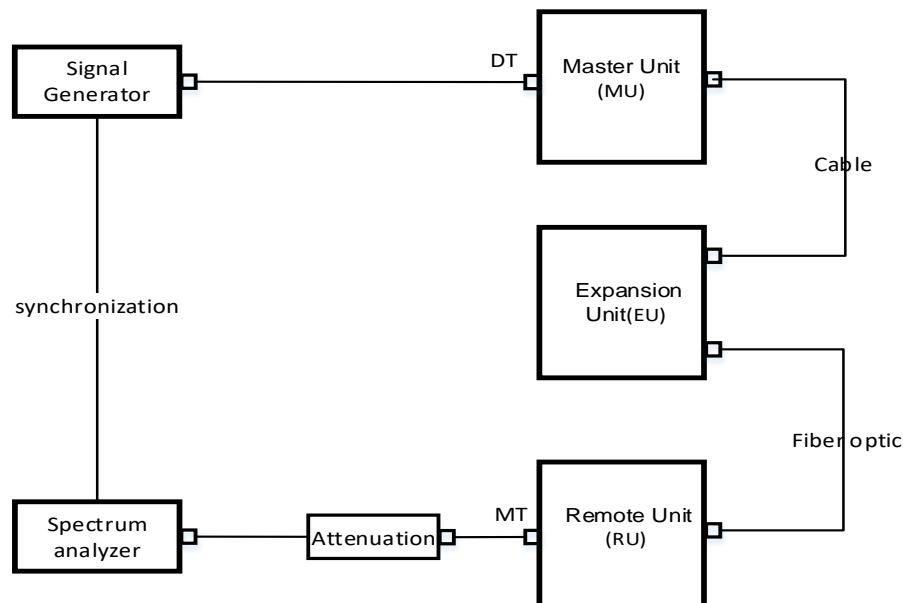

Figure 11.9-1 Downlink connection diagram

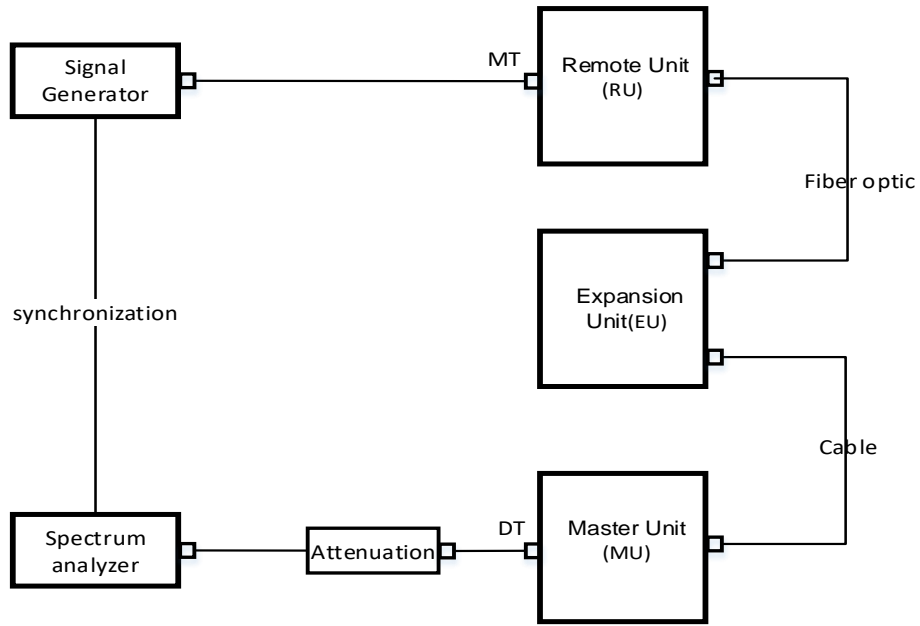

Figure 11.9-2 Uplink connection diagram

----- The following blanks -----

## 11.9.3. Test procedures

- a) Connect a signal generator to the input of the EUT.
- b) Configure the signal generator to produce a CW signal.
- c) Set the frequency of the CW signal to the center channel of the EUT passband.
- d) Set the output power level so that the resultant signal is just below the AGC threshold (see 4.2).
- e) Connect a spectrum analyzer to the output of the EUT, using appropriate attenuation as necessary.
- f) Set the RBW = 100 kHz. (i.e., for 30 MHz to 1 GHz PLMRS and/or PSRS booster devices)
- g) Set the VBW =  $3 \times$  RBW.
- h) Set the Sweep time = auto-couple.
- i) Set the detector to PEAK.
- j) Set the spectrum analyzer start frequency to 30 MHz (or the lowest radio frequency signal generated in the EUT, without going below 9 kHz if the EUT has additional internal clock frequencies), and the stop frequency to  $10 \times$  the highest allowable frequency of the EUT passband.
- k) Select MAX HOLD, and use the marker peak function to find the highest emission(s) outside the passband. (This could be either at a frequency lesser or greater than the passband frequencies.)
- l) Capture a plot for inclusion in the test report.

Any frequency outside the authorized bandwidth was attenuated by at least  $43+10*\log(P)$ dB. This corresponds to an absolute level of  $-13\text{dBm} (P_{\text{dBm}}-(43+10*\log(P_{\text{W}})))$ .

----- The following blanks -----

11.9.4. Test results

Test Date (yy-mm-dd): 2023-05-19

Normal condition: Temp: 26.9°C, Humid: 55%, Atmospheric Pressure:101kpa

Supply Voltage: AC 110V, 50Hz

11.9.4.1. 700MHz Band

Test Frequency		Spurious Limit(dBm)	RBW (kHz)	Max. Spurious Mark Level (dBm)	Margin <sup>1*</sup> (dB)	Result
(1) Downlink Transmit (Frequency range: 769MHz~775MHz)						
Frequency 772.0MHz	9kHz~1GHz	-13.0	100	-47.8	34.8	PASS
	1GHz~10GHz	-13.0	100	-50.9	37.9	PASS
(2) Uplink Transmit (Frequency range: 799MHz~805MHz)						
Frequency 802.0MHz	9kHz~1GHz	-13.0	100	-46.1	33.1	PASS
	1GHz~10GHz	-13.0	100	-50.4	37.4	PASS
NOTE: <sup>1*</sup> --Margin= specification limit -Maximum mark level.						

11.9.4.2. 800MHz Band

Frequency range		Max. Spurious Limit(dBm)	RBW (kHz)	Max. Spurious mark Level (dBm)	Margin <sup>1*</sup> (dB)	Result
(1) Downlink transmit mode (Frequency range: 851MHz~861MHz)						
frequency 856.0MHz	9kHz~1GHz	-13.0	100	-48.7	35.7	PASS
	1GHz~8.6GHz	-13.0	100	-50.6	37.6	PASS
(2) Uplink transmit mode(Frequency range: 806MHz~816MHz)						
frequency 811.0MHz	9kHz~1GHz	-13.0	100	-46.4	33.4	PASS
	1GHz~8.6GHz	-13.0	100	-50.0	37.0	PASS
NOTE 1: <sup>1*</sup> --Margin= specification limit -Maximum mark level.						

----- The following blanks -----

11.9.5. Test screenshot

11.9.5.1. 700MHz Band

11.9.5.1.1. Downlink

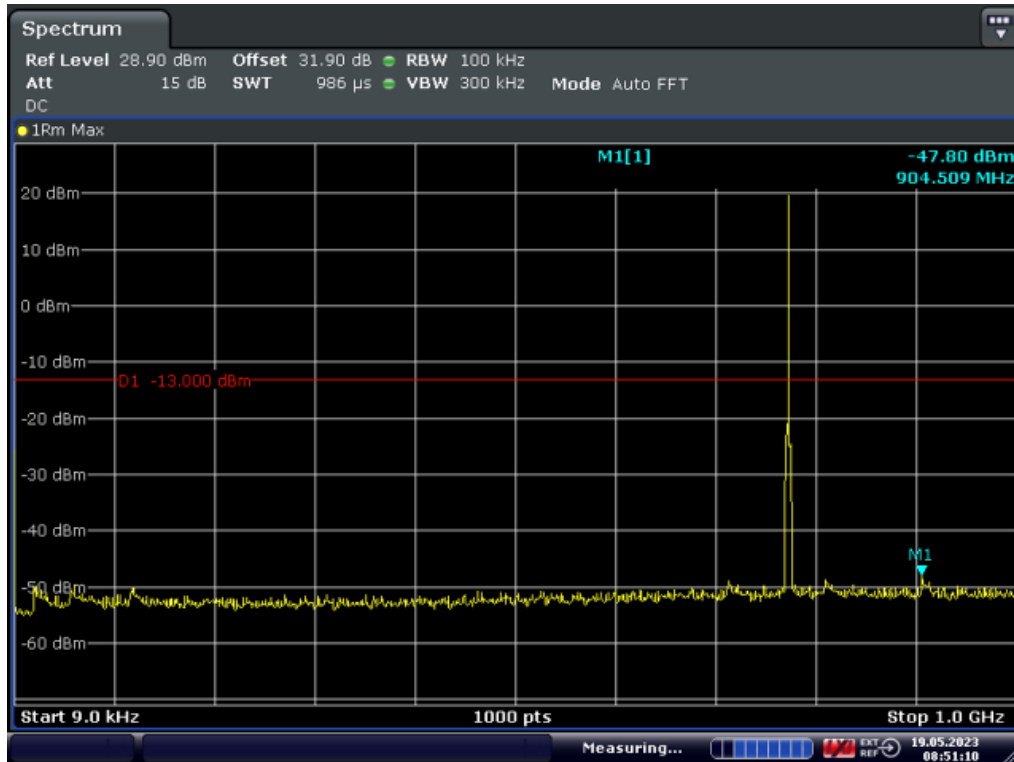

Date: 19.MAY.2023 08:51:10

9kHz~1GHz

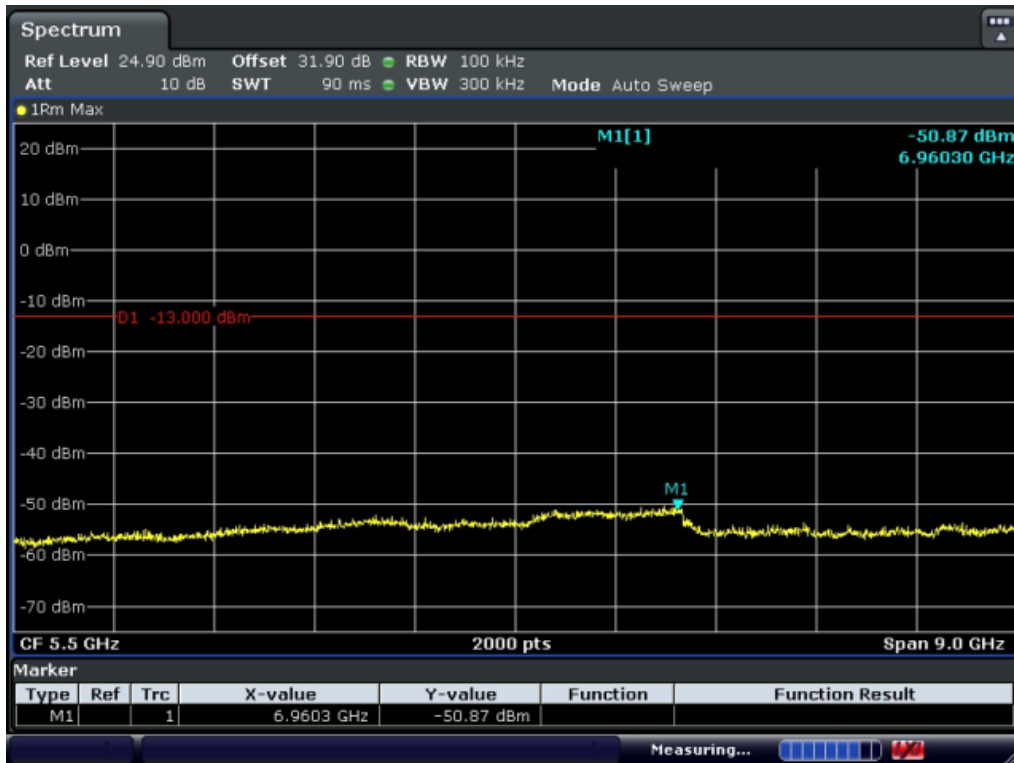

Date: 19.MAY.2023 08:46:40

1GHz~10GHz



11.9.5.1.2. Uplink

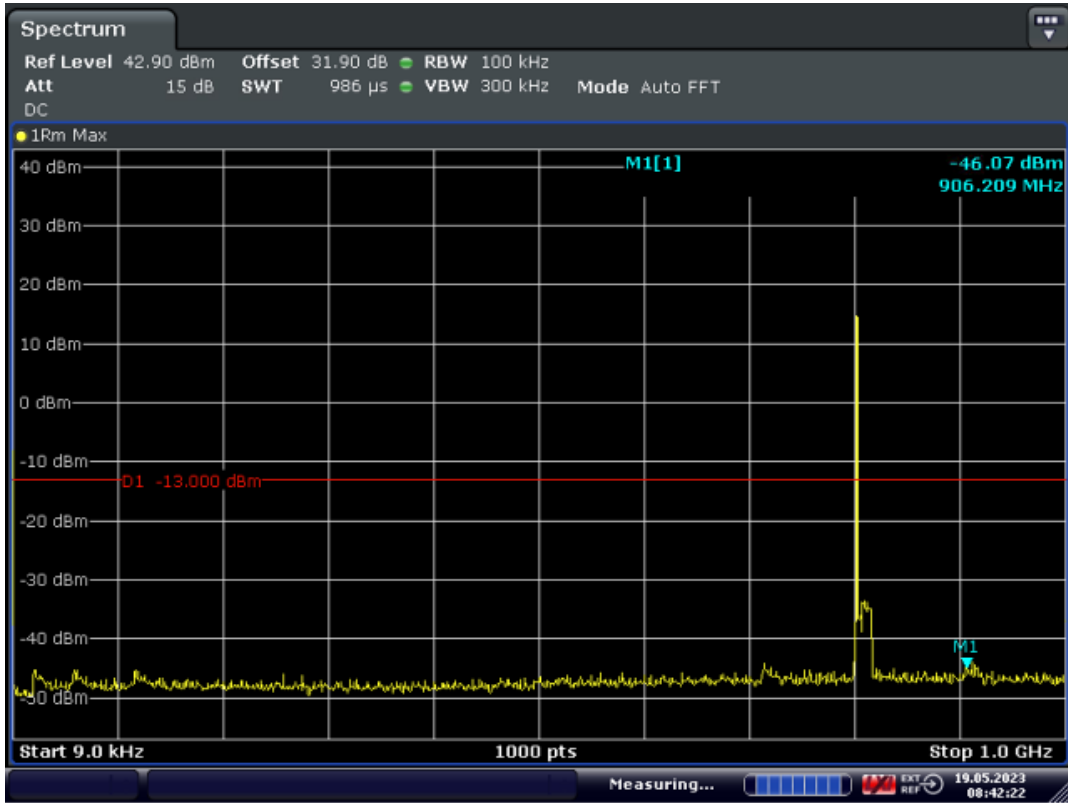

Date: 19.MAY.2023 08:42:22

9kHz~1GHz

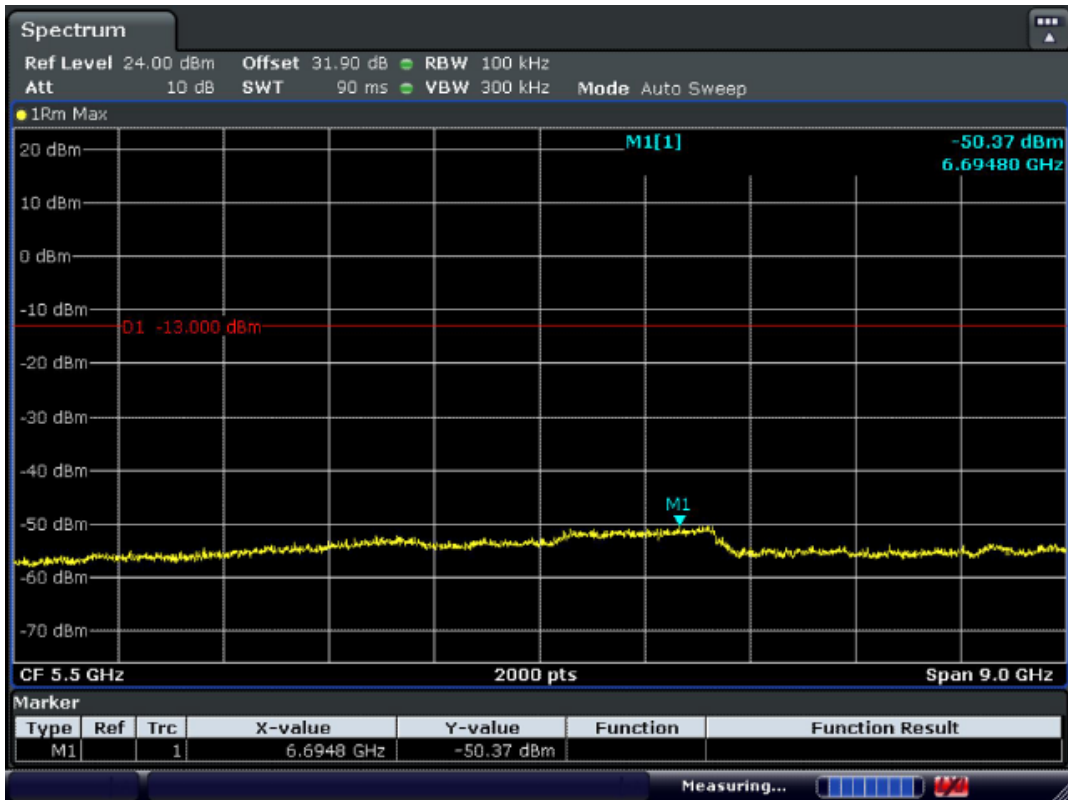

Date: 19.MAY.2023 08:45:05

1GHz~10GHz

11.9.5.2. 800MHz Band

11.9.5.2.1. Downlink

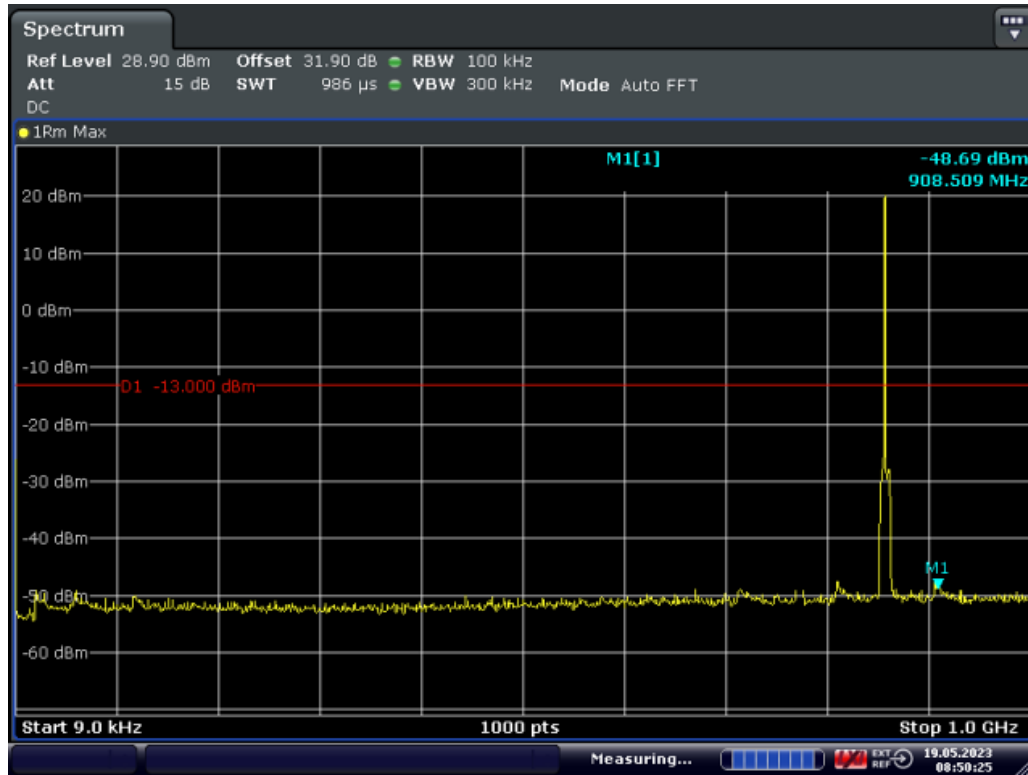

Date: 19.MAY.2023 08:50:25

9kHz~1GHz

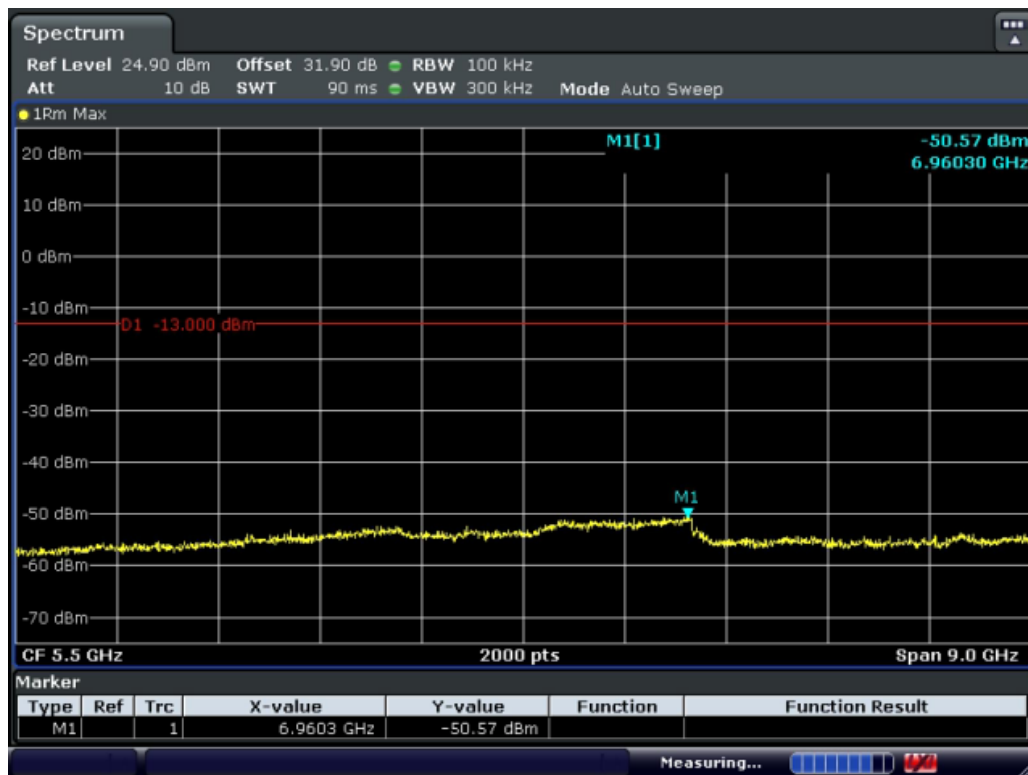

Date: 19.MAY.2023 08:47:09

1GHz~10GHz

11.9.5.2.2. Uplink

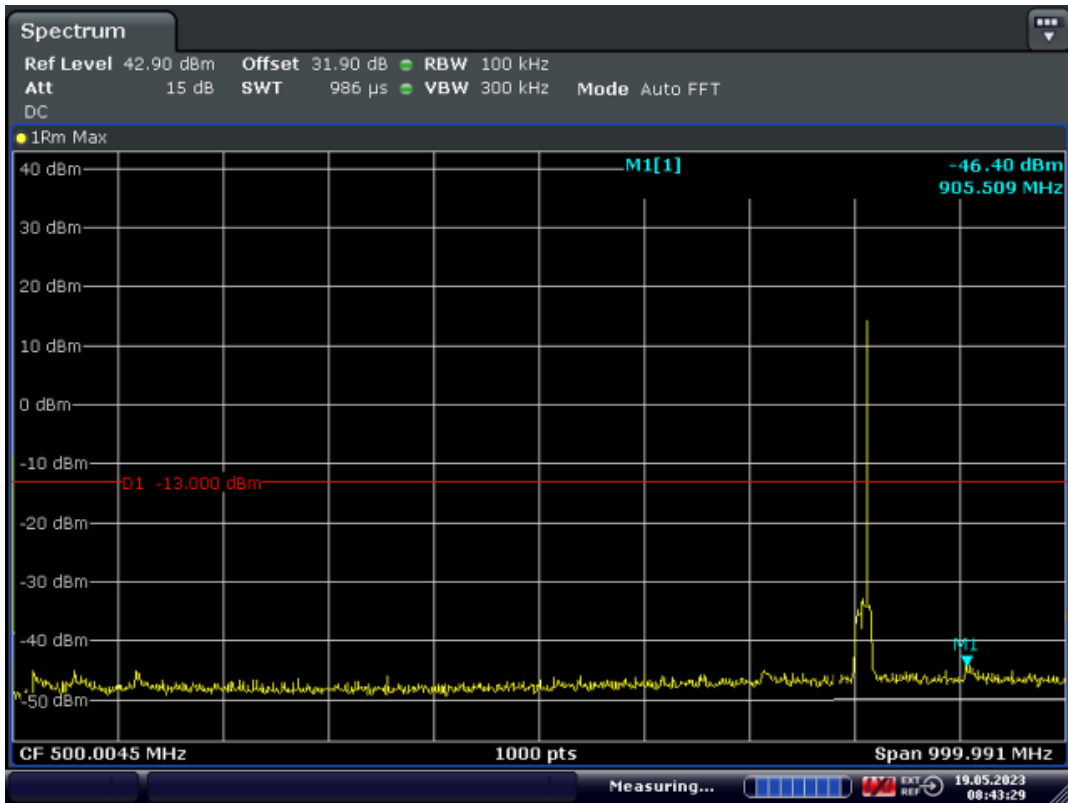

Date: 19.MAY.2023 08:43:29

9kHz~1GHz

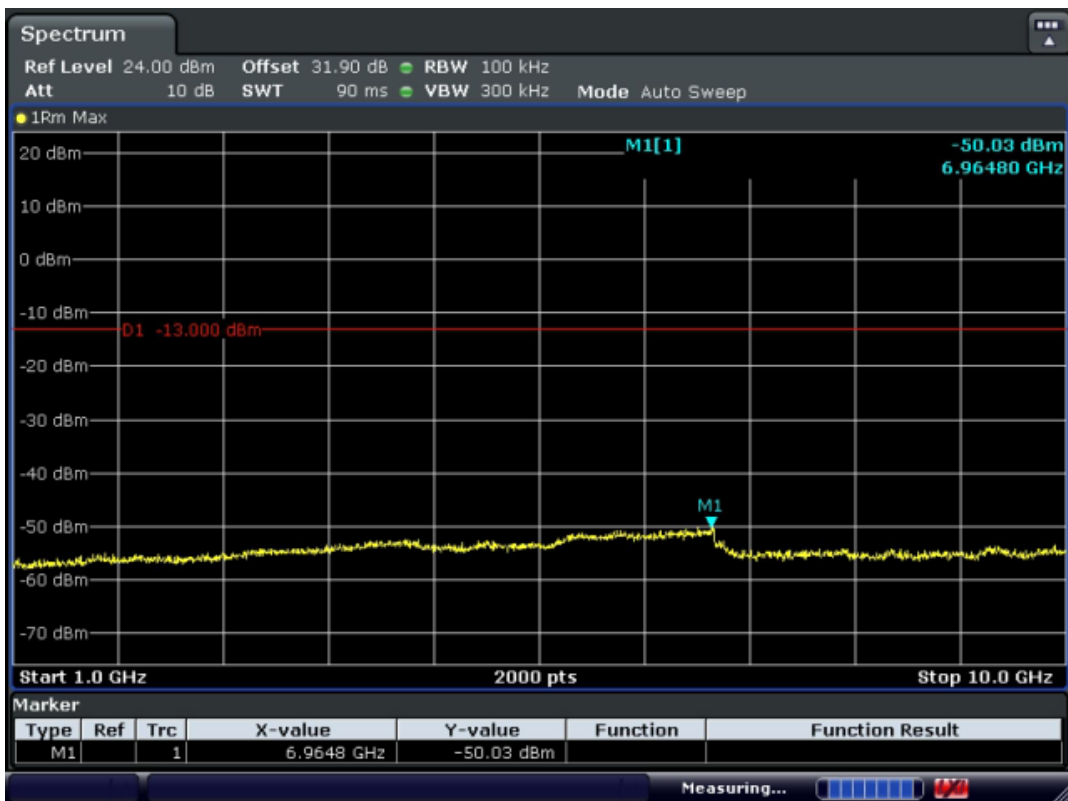

Date: 19.MAY.2023 08:45:23

1GHz~10GHz

11.10. Frequency stability

Test requirement: KDB 935210 D05 clause 4.8  
 FCC PART 2 1055(a)(2)  
 FCC PART 90.213 and 90.539  
 FCC PART 90.219 (e)(4)(i)  
 Test Method: KDB 935210 D05/4.8  
 FCC PART 2 1055(b)

11.10.1.Limit

Section 90.219(e)(4)(i) requires that a signal being retransmitted by an amplifier, repeater, or industrial booster meets the frequency stability requirements of Section 90.213. However, this requirement presumes that the EUT processes an input signal in ways that can influence the output signal frequency/frequencies; however, most signal boosters do not incorporate an oscillator). If the amplifier, booster, or repeater does not alter the input signal in any way, then a frequency stability test may not be required.

When performing frequency stability measurements on these types of devices, the instability associated with the EUT must be isolated from any frequency instability associated with the measurement instrumentation. One method for realizing such isolation is to connect the reference clock input of the signal generator to the reference output of the frequency counter, to confirm that any frequency instability is associated with the EUT, and is not due to differences between the reference oscillators internal to the measurement instrumentation.

Unless noted elsewhere, transmitters used in the services governed by this part must have a minimum frequency stability as specified in the following table 10.10-1.

Table 10.10-1Frequency stability limits

frequency range(MHz)	Minimum Frequency Stability(ppm)
769-775/799-805	± 1.5(Channel Bandwidth 12.5kHz) ± 2.5(Channel Bandwidth 25kHz)
806-809/851-854	± 1.0
809-816/854-861	± 1.5

NOTE 1: RF channels to be tested for single-carrier: Middle frequency

NOTE 2: Modulation type is CW.

11.10.2. Test configuration

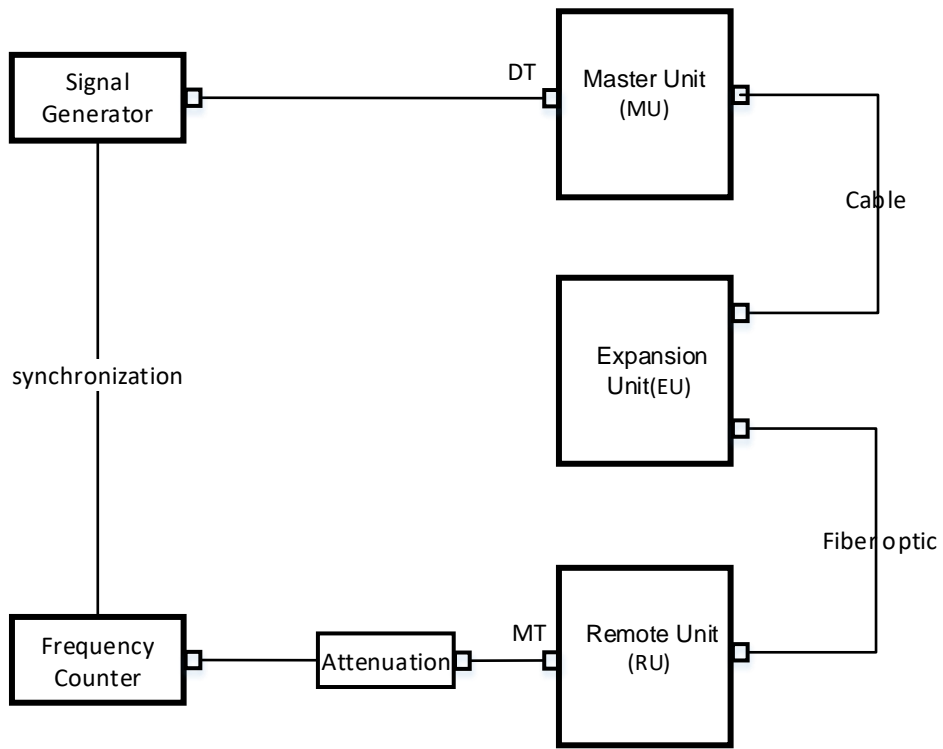

Figure 11.10-1 Downlink connection diagram

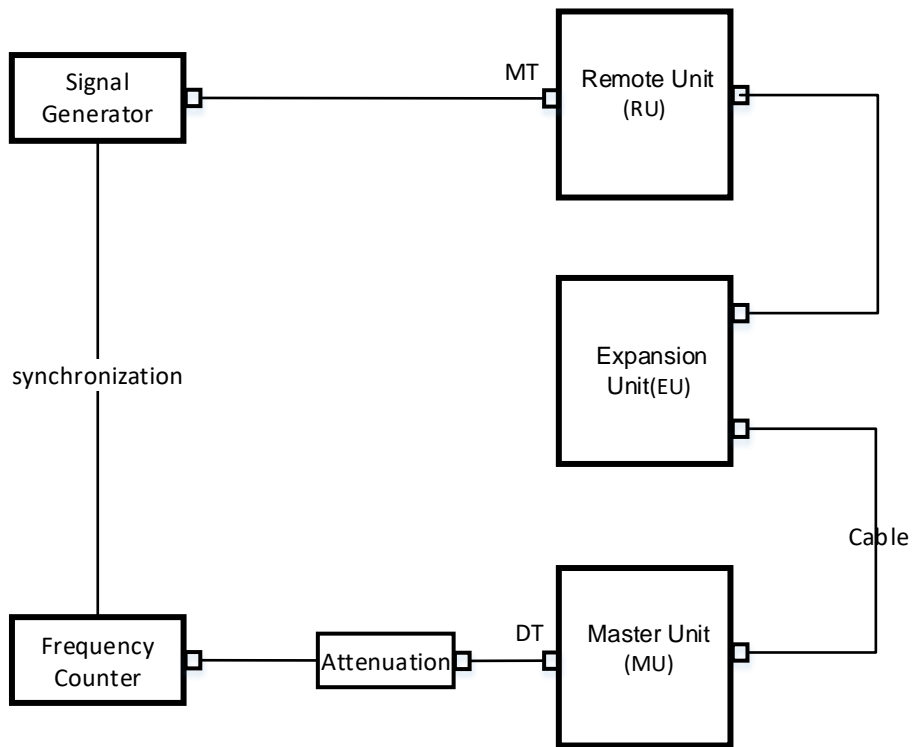

Figure 11.10-2 Uplink connection diagram

### 11.10.3. Test procedures

#### 11.10.3.1. FCC PART 2 1055(a) (2)

##### **§2.1055 Measurements required: Frequency stability.**

(a) The frequency stability shall be measured with variation of ambient temperature as follows:

(1) From  $-30^{\circ}$  to  $+50^{\circ}$  centigrade for all equipment except that specified in paragraphs (a) (2) and (3) of this section.

(2) From  $-20^{\circ}$  to  $+50^{\circ}$  centigrade for equipment to be licensed for use in the Maritime Services under part 80 of this chapter, except for Class A, B, and S Emergency Position Indicating Radiobeacons (EPIRBs), and equipment to be licensed for use above 952 MHz at operational fixed stations in all services, stations in the Local Television Transmission Service and Point-to-Point Microwave Radio Service under part 21 of this chapter, equipment licensed for use aboard aircraft in the Aviation Services under part 87 of this chapter, and equipment authorized for use in the Family Radio Service under part 95 of this chapter.

(3) From  $0^{\circ}$  to  $+50^{\circ}$  centigrade for equipment to be licensed for use in the Radio Broadcast Services under part 73 of this chapter.

(b) Frequency measurements shall be made at the extremes of the specified temperature range and at intervals of not more than  $10^{\circ}$  centigrade through the range. A period of time sufficient to stabilize all of the components of the oscillator circuit at each temperature level shall be allowed prior to frequency measurement. The short term transient effects on the frequency of the transmitter due to keying (except for broadcast transmitters) and any heating element cycling normally occurring at each ambient temperature level also shall be shown. Only the portion or portions of the transmitter containing the frequency determining and stabilizing circuitry need be subjected to the temperature variation test.

## 11.10.3.2.ANSI C63.26-2015 clause 5.6.3

**5.6.3 Procedure for frequency stability testing**

Frequency stability is a measure of the frequency drift due to temperature and supply voltage variations, with reference to the frequency measured at +20 °C and rated supply voltage.

The operating carrier frequency shall be set up in accordance with the manufacturer's published operation and instruction manual prior to the commencement of these tests. No adjustment of any frequency determining circuit element shall be made subsequent to this initial set-up. Frequency stability is tested:

- a) At 10 °C intervals of temperatures between –30 °C and +50 °C at the manufacturer's rated supply voltage, and
- b) At +20 °C temperature and ±15% supply voltage variations. If a product is specified to operate over a range of input voltage then the –15% variation is applied to the lowermost voltage and the +15% is applied to the uppermost voltage.

During the test all necessary settings, adjustments and control of the EUT have to be performed without disturbing the test environment, i.e., without opening the environmental chamber. The frequency stabilities can be maintained to a lesser temperature range provided that the transmitter is automatically inhibited from operating outside the lesser temperature range. For handheld equipment that is only capable of operating from internal batteries and the supply voltage cannot be varied, the frequency stability tests shall be performed at the nominal battery voltage and the battery end point voltage specified by the manufacturer. An external supply voltage can be used and set at the internal battery nominal voltage, and again at the battery operating end point voltage which shall be specified by the equipment manufacturer.

If an unmodulated carrier is not available, the mean frequency of a modulated carrier can be obtained by using a frequency counter with gating time set to an appropriately large multiple of bit periods (gating time depending on the required accuracy). Full details on the choice of values shall be included in the test report.

Frequency stability is a measure of the frequency drift due to temperature and supply voltage variations, with reference to the frequency measured at +20 °C and rated supply voltage.

The operating carrier frequency shall be set up in accordance with the manufacturer's published operation and instruction manual prior to the commencement of these tests. No adjustment of any frequency determining circuit element shall be made subsequent to this initial set-up. Frequency stability is tested:

- a) At 10 °C intervals of temperatures between –30 °C and +50 °C at the manufacturer's rated supply voltage, and
- b) At +20 °C temperature and ±15% supply voltage variations. If a product is specified to operate over a range of input voltage then the –15% variation is applied to the lowermost voltage and the +15% is applied to the uppermost voltage.

During the test all necessary settings, adjustments and control of the EUT have to be performed without disturbing the test environment, i.e., without opening the environmental chamber. The frequency stabilities can be maintained to a lesser temperature range provided that the transmitter is automatically inhibited from operating outside the lesser temperature range. For handheld equipment that is only capable of operating from internal batteries and the supply voltage cannot be varied, the frequency stability tests shall be performed at the nominal battery voltage and the battery end point voltage specified by the manufacturer. An external supply voltage can be used and set at the internal battery nominal voltage, and again at the battery operating end point voltage which shall be specified by the equipment manufacturer.

If an unmodulated carrier is not available, the mean frequency of a modulated carrier can be obtained by using a frequency counter with gating time set to an appropriately large multiple of bit periods (gating time depending on the required accuracy). Full details on the choice of values shall be included in the test report.

## 11.10.4. Test results

Test Date (yy-mm-dd): 2023-06-04

Normal condition: Temp:25.5°C, Humid: 45%, Atmospheric Pressure:101kpa

Extreme test conditions:

Temp range: -30°C~+50°C

Test Date: 2023-06-04

## 11.10.4.1.Downlink

## 11.10.4.1.1. The center frequency is 772.0MHz

Temperature (°C)	Voltage	Input carrier Frequency (MHz)	Comparison of deviation value between output frequency and input frequency(Hz)	Limit (ppm)	Frequency stability (ppm)	Result
-30	AC 93.5V(110*85%)	772.0	-1.0	±1.5	-0.0013	PASS
	AC 110V	772.0	0.7	±1.5	0.0009	PASS
	AC 126.5V(110*115%)	772.0	0.3	±1.5	0.0004	PASS
-20	AC 93.5V(110*85%)	772.0	0.0	±1.5	0.0000	PASS
	AC 110V	772.0	0.4	±1.5	0.0005	PASS
	AC 126.5V(110*115%)	772.0	-0.1	±1.5	-0.0001	PASS
-10	AC 93.5V(110*85%)	772.0	-0.4	±1.5	-0.0005	PASS
	AC 110V	772.0	-0.1	±1.5	-0.0001	PASS
	AC 126.5V(110*115%)	772.0	0.0	±1.5	0.0000	PASS
0	AC 93.5V(110*85%)	772.0	0.2	±1.5	0.0003	PASS
	AC 110V	772.0	0.3	±1.5	0.0004	PASS
	AC 126.5V(110*115%)	772.0	0.6	±1.5	0.0008	PASS
10	AC 93.5V(110*85%)	772.0	-1.0	±1.5	-0.0013	PASS
	AC 110V	772.0	-0.2	±1.5	-0.0003	PASS
	AC 126.5V(110*115%)	772.0	0.6	±1.5	0.0008	PASS
20	AC 93.5V(110*85%)	772.0	1.1	±1.5	0.0014	PASS
	AC 110V	772.0	-0.8	±1.5	-0.0010	PASS
	AC 126.5V(110*115%)	772.0	-0.7	±1.5	-0.0009	PASS
30	AC 93.5V(110*85%)	772.0	-0.7	±1.5	-0.0009	PASS
	AC 110V	772.0	0.0	±1.5	0.0000	PASS
	AC 126.5V(110*115%)	772.0	0.4	±1.5	0.0005	PASS
40	AC 93.5V(110*85%)	772.0	0.2	±1.5	0.0003	PASS
	AC 110V	772.0	1.0	±1.5	0.0013	PASS
	AC 126.5V(110*115%)	772.0	0.4	±1.5	0.0005	PASS
50	AC 93.5V(110*85%)	772.0	1.1	±1.5	0.0014	PASS
	AC 110V	772.0	0.8	±1.5	0.0010	PASS



	AC 126.5V(110*115%)	772.0	-0.1	±1.5	-0.0001	PASS
NOTE: The test result is accurate to 4 decimal places.						

## 11.10.4.1.2. The center frequency is 856MHz

Temperature (°C)	Voltage	Input carrier Frequency (MHz)	Comparison of deviation value between output frequency and input frequency(Hz)	Limit (ppm)	Frequency stability (ppm)	Result
-30	AC 93.5V(110*85%)	856.0	0.7	±1.0	0.0008	PASS
	AC 110V	856.0	0.3	±1.0	0.0004	PASS
	AC 126.5V(110*115%)	856.0	-0.5	±1.0	-0.0006	PASS
-20	AC 93.5V(110*85%)	856.0	-0.7	±1.0	-0.0008	PASS
	AC 110V	856.0	-0.5	±1.0	-0.0006	PASS
	AC 126.5V(110*115%)	856.0	-0.1	±1.0	-0.0001	PASS
-10	AC 93.5V(110*85%)	856.0	0.1	±1.0	0.0001	PASS
	AC 110V	856.0	-0.8	±1.0	-0.0009	PASS
	AC 126.5V(110*115%)	856.0	0.2	±1.0	0.0002	PASS
0	AC 93.5V(110*85%)	856.0	-0.1	±1.0	-0.0001	PASS
	AC 110V	856.0	0.9	±1.0	0.0011	PASS
	AC 126.5V(110*115%)	856.0	0.9	±1.0	0.0011	PASS
10	AC 93.5V(110*85%)	856.0	0.4	±1.0	0.0005	PASS
	AC 110V	856.0	1.2	±1.0	0.0014	PASS
	AC 126.5V(110*115%)	856.0	-0.2	±1.0	-0.0002	PASS
20	AC 93.5V(110*85%)	856.0	-1.0	±1.0	-0.0012	PASS
	AC 110V	856.0	0.9	±1.0	0.0011	PASS
	AC 126.5V(110*115%)	856.0	0.6	±1.0	0.0007	PASS
30	AC 93.5V(110*85%)	856.0	0.8	±1.0	0.0009	PASS
	AC 110V	856.0	-1.0	±1.0	-0.0012	PASS
	AC 126.5V(110*115%)	856.0	-0.7	±1.0	-0.0008	PASS
40	AC 93.5V(110*85%)	856.0	-0.3	±1.0	-0.0004	PASS
	AC 110V	856.0	0.9	±1.0	0.0011	PASS
	AC 126.5V(110*115%)	856.0	0.4	±1.0	0.0005	PASS
50	AC 93.5V(110*85%)	856.0	-0.1	±1.0	-0.0001	PASS
	AC 110V	856.0	-0.9	±1.0	-0.0011	PASS
	AC 126.5V(110*115%)	856.0	-0.7	±1.0	-0.0008	PASS

NOTE: The test result is accurate to 4 decimal places.

## 11.10.4.2.Uplink

## 11.10.4.2.1. The center frequency is 802.0MHz

Temperature (°C)	Voltage	Input carrier Frequency (MHz)	Comparison of deviation value between output frequency and input frequency(Hz)	Limit (ppm)	Frequency stability (ppm)	Result
-30	AC 93.5V(110*85%)	802.0	-0.7	±1.5	-0.0009	PASS
	AC 110V	802.0	-1.2	±1.5	-0.0015	PASS
	AC 126.5V(110*115%)	802.0	-1.0	±1.5	-0.0012	PASS
-20	AC 93.5V(110*85%)	802.0	0.8	±1.5	0.0010	PASS
	AC 110V	802.0	-0.4	±1.5	-0.0005	PASS
	AC 126.5V(110*115%)	802.0	0.9	±1.5	0.0011	PASS
-10	AC 93.5V(110*85%)	802.0	-1.1	±1.5	-0.0014	PASS
	AC 110V	802.0	-1.1	±1.5	-0.0014	PASS
	AC 126.5V(110*115%)	802.0	-0.9	±1.5	-0.0011	PASS
0	AC 93.5V(110*85%)	802.0	1.2	±1.5	0.0015	PASS
	AC 110V	802.0	0.2	±1.5	0.0002	PASS
	AC 126.5V(110*115%)	802.0	-1.2	±1.5	-0.0015	PASS
10	AC 93.5V(110*85%)	802.0	-0.8	±1.5	-0.0010	PASS
	AC 110V	802.0	0.2	±1.5	0.0002	PASS
	AC 126.5V(110*115%)	802.0	-0.7	±1.5	-0.0009	PASS
20	AC 93.5V(110*85%)	802.0	0.0	±1.5	0.0000	PASS
	AC 110V	802.0	-0.6	±1.5	-0.0007	PASS
	AC 126.5V(110*115%)	802.0	1.1	±1.5	0.0014	PASS
30	AC 93.5V(110*85%)	802.0	-0.2	±1.5	-0.0002	PASS
	AC 110V	802.0	-0.1	±1.5	-0.0001	PASS
	AC 126.5V(110*115%)	802.0	0.4	±1.5	0.0005	PASS
40	AC 93.5V(110*85%)	802.0	-0.2	±1.5	-0.0002	PASS
	AC 110V	802.0	0.1	±1.5	0.0001	PASS
	AC 126.5V(110*115%)	802.0	-0.3	±1.5	-0.0004	PASS
50	AC 93.5V(110*85%)	802.0	0.0	±1.5	0.0000	PASS
	AC 110V	802.0	1.0	±1.5	0.0012	PASS
	AC 126.5V(110*115%)	802.0	0.6	±1.5	0.0007	PASS

NOTE: The test result is accurate to 4 decimal places.

## 11.10.4.2.2. The center frequency is 811MHz

Temperature (°C)	Voltage	Input carrier Frequency (MHz)	Comparison of deviation value between output frequency and input frequency(Hz)	Limit (ppm)	Frequency stability (ppm)	Result
-30	AC 93.5V(110*85%)	811.0	0.5	±1.0	0.0006	PASS
	AC 110V	811.0	0.7	±1.0	0.0009	PASS
	AC 126.5V(110*115%)	811.0	-0.4	±1.0	-0.0005	PASS
-20	AC 93.5V(110*85%)	811.0	0.2	±1.0	0.0002	PASS
	AC 110V	811.0	0.6	±1.0	0.0007	PASS
	AC 126.5V(110*115%)	811.0	-0.2	±1.0	-0.0002	PASS
-10	AC 93.5V(110*85%)	811.0	0.5	±1.0	0.0006	PASS
	AC 110V	811.0	-1.0	±1.0	-0.0012	PASS
	AC 126.5V(110*115%)	811.0	-0.8	±1.0	-0.0010	PASS
0	AC 93.5V(110*85%)	811.0	-0.2	±1.0	-0.0002	PASS
	AC 110V	811.0	0.5	±1.0	0.0006	PASS
	AC 126.5V(110*115%)	811.0	0.8	±1.0	0.0010	PASS
10	AC 93.5V(110*85%)	811.0	0.6	±1.0	0.0007	PASS
	AC 110V	811.0	0.4	±1.0	0.0005	PASS
	AC 126.5V(110*115%)	811.0	0.3	±1.0	0.0004	PASS
20	AC 93.5V(110*85%)	811.0	-0.4	±1.0	-0.0005	PASS
	AC 110V	811.0	0.7	±1.0	0.0009	PASS
	AC 126.5V(110*115%)	811.0	-0.6	±1.0	-0.0007	PASS
30	AC 93.5V(110*85%)	811.0	0.1	±1.0	0.0001	PASS
	AC 110V	811.0	-0.5	±1.0	-0.0006	PASS
	AC 126.5V(110*115%)	811.0	-0.7	±1.0	-0.0009	PASS
40	AC 93.5V(110*85%)	811.0	-0.3	±1.0	-0.0004	PASS
	AC 110V	811.0	-0.4	±1.0	-0.0005	PASS
	AC 126.5V(110*115%)	811.0	-0.6	±1.0	-0.0007	PASS
50	AC 93.5V(110*85%)	811.0	1.0	±1.0	0.0012	PASS
	AC 110V	811.0	-0.1	±1.0	-0.0001	PASS
	AC 126.5V(110*115%)	811.0	-1.1	±1.0	-0.0014	PASS

NOTE: The test result is accurate to 4 decimal places.

## 11.11. Radiated spurious emissions

Test requirement:	KDB 935210 D05 clause 4.9 FCC PART 2.1053 FCC PART 90.219 (e)(3)
Test Method:	KDB 935210 D05 clause 4.9 ANSI C63.26-2015/5.5 ANSI/TIA 603-E-2016 ANSI/TIA-102.CAAA-E-2016

## 11.11.1. Requirements

## 11.11.1.1. KDB 935210 D05 clause 4.9

**4.9 Spurious emissions radiated measurements**

This measurement is intended to produce test data necessary to demonstrate compliance to the radiated spurious emission requirements specified in Section 2.1053 of the FCC rules. This test is intended to capture any emissions that radiate directly from the case, cabinet, control circuits, etc., instead of via the antenna output port, and thus would not be captured in conducted spurious emission measurements. See KDB Publication 971168 [R8] for measurement procedure guidance.

## 11.11.1.2. FCC PART 2.1053

**§2.1053 Measurements required: Field strength of spurious radiation.**

(a) Measurements shall be made to detect spurious emissions that may be radiated directly from the cabinet, control circuits, power leads, or intermediate circuit elements under normal conditions of installation and operation. Curves or equivalent data shall be supplied showing the magnitude of each harmonic and other spurious emission. For this test, single sideband, independent sideband, and controlled carrier transmitters shall be modulated under the conditions specified in paragraph (c) of §2.1049, as appropriate. For equipment operating on frequencies below 890 MHz, an open field test is normally required, with the measuring instrument antenna located in the far-field at all test frequencies. In the event it is either impractical or impossible to make open field measurements (e.g. a broadcast transmitter installed in a building) measurements will be accepted of the equipment as installed. Such measurements must be accompanied by a description of the site where the measurements were made showing the location of any possible source of reflections which might distort the field strength measurements. Information submitted shall include the relative radiated power of each spurious emission with reference to the rated power output of the transmitter, assuming all emissions are radiated from halfwave dipole antennas.

(b) The measurements specified in paragraph (a) of this section shall be made for the following equipment:

(1) Those in which the spurious emissions are required to be 60 dB or more below the mean power of the transmitter.

(2) All equipment operating on frequencies higher than 25 MHz.

(3) All equipment where the antenna is an integral part of, and attached directly to the transmitter.

(4) Other types of equipment as required, when deemed necessary by the Commission.

[39 FR 5919, Feb. 15, 1974. Redesignated and amended at 63 FR 36599, July 7, 1998]

According to FCC PART 2.1053 requirement, this test was performed to measure radiated spurious emissions from the EUT. The test is intended to capture any emissions that radiate directly from the case, cabinet, control circuits, etc., instead of via the antenna output port, and thus would not be captured in conducted spurious emission measurements.

Spurious emissions of zone enhancers shall be suppressed as much as possible. Any emissions must be attenuated below the power (P) of the highest emissions contained within the authorized, by at

least:  $43+10*\log_{10} P$  or 70dB, whichever is less stringent, where P is the total RF output power of the test tones in Watts. Since  $43+10*\log_{10} P$  is less stringent than 70dB, that limit was used.

----- **The following blanks** -----

## 11.11.2. Test configuration

### 11.11.2.1. Below 1GHz

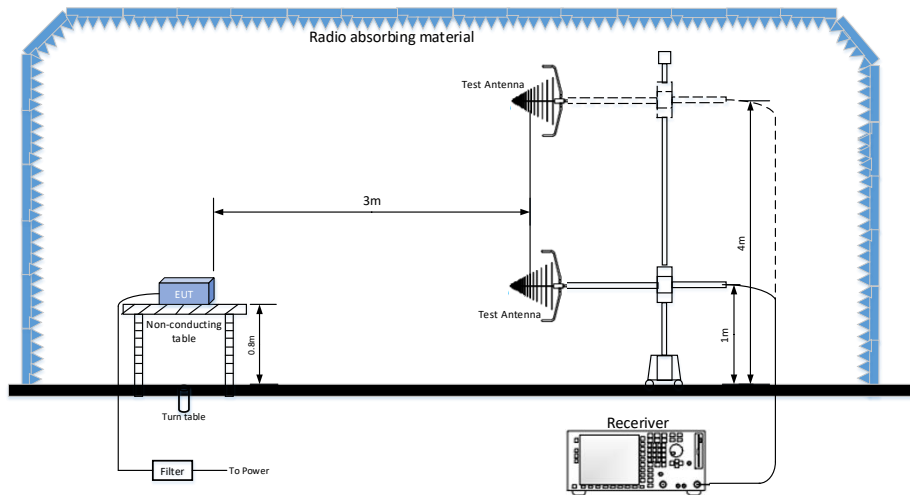

### 11.11.2.2. Above 1GHz

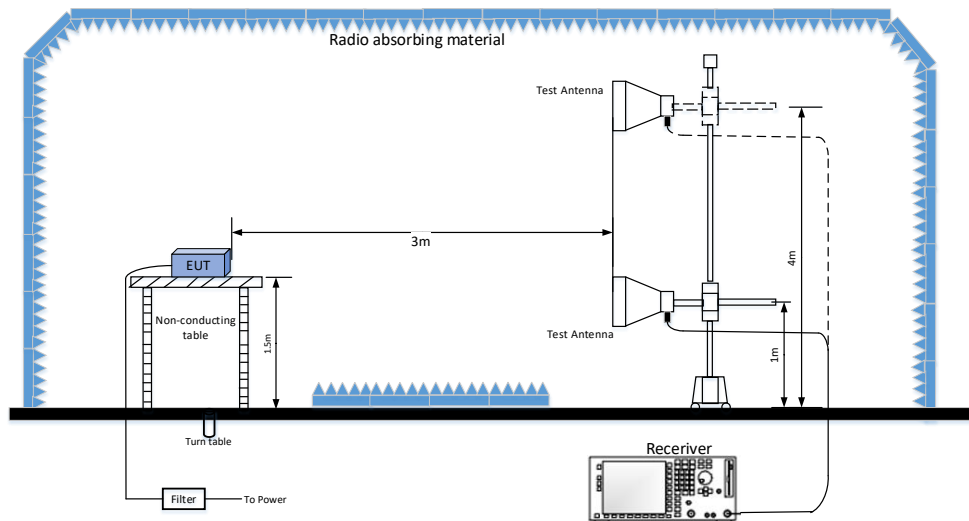

## 11.11.3. Test procedures

According to the test method of ANSIC63.26-2015/5.5.2.3.1 Test arrangements for tabletop EUTs:

### 11.11.3.1. Below 1GHz

For radiated emissions measurements performed at frequencies less than or equal to 1GHz, the EUT shall be placed on a RF-transparent table or support at a nominal height of 80 cm above the reference ground plane. Radiated measurements shall be made with the measurement antenna positioned in both horizontal and vertical polarization. The measurement antenna shall be varied from 1 m to 4 m in height above the reference ground in a search for the relative positioning that produces the maximum radiated signal level (i.e., field strength or received power). When orienting the measurement antenna in vertical polarization, the minimum height of the lowest element of the antenna shall clear the site reference ground plane by at least 25 cm.

Figure 8.8.2-1 of ANSIC63.26-2015 shows a typical EUT configuration with a wireless device place on a tabletop on an appropriate radiated test site. The measurement antenna shall be placed at the specified distance from the closest point of the EUT. Tabletop devices shall be placed on a RF transparent platform with nominal top surface dimensions of 1m by 1.5m. Any necessary support equipment shall be placed far enough away from the EUT, such that changes in relative position of the EUT and support equipment do not influence the measured values. If the EUT requires a connection to a server or computer, via control/data cable(s), to exercise the product, then the controlling server or computer may be placed outside of the test area.

### 11.11.3.2. Above 1GHz

For radiated measurements performed at frequencies above 1GHz, the EUT shall be placed on an RF transparent table or support at a nominal height of 1.5m above the ground plane. Radiated measurements shall be made with the measurement antenna positioned in both horizontal and vertical polarization. The height scan of the measurement antenna shall be varied from 1m to 4m in a search for the relative positioning that produces the maximum radiated signal level (i.e., field strength or received power). When using the direct field strength method and the EUT is manipulated through three different orientations, then the scan height range of the measurement antenna is limited to 2.5m, or 0.5m above the top of EUT, whichever is higher.

Radiated unwanted emissions measurements shall be made over the frequency range specified in 5.1 of ANSIC 63.26-2015, dependent upon the relevant operational frequency band, these radiated measurements shall be made around the EUT (or alternatively, with the EUT rotated on a turntable), while varying the measurement antenna height and examining both horizontal and vertical polarization of the measurement antenna, as described above. Ordinarily, this will require the use of a turntable and an antenna positioned.

The EUT shall be set up in its typical configuration and arrangement and operated in its various modes of operation. Unless the EUT uses an integral antenna, the EUT shall be terminated with a non-radiating transmitter load. In cases where the EUT uses an adjustable antenna, the antenna shall be adjusted through typical positions and lengths to maximize emissions levels, EUTs with integral antennas shall be evaluated in their normal orientation. Where EUTs are designed to be installed in one of two distinct orientations, they shall be tested in both of their possible orientations. EUTs that can be operated in one of multiple orientations (e.g., handheld, portable, or modular devices) shall be tested in a minimum of three orientations. When large antennas or antennas not structurally supported by the EUT are utilized, a RF transparent supporting structure shall be used to facilitate the compliance testing. In all cases, the EUT, including the transmit antenna, shall be orientated such that the measurement of the emissions is maximized.

### 11.11.3.3. Final radiated emissions testing procedure

- (1) Connect the device as illustrated;
- (2) Place the EUT in the center of the turntable. The EUT shall be configured to transmit into the standard non-radiating load (for measuring radiated spurious emissions), connected with cables of minimal length unless specified otherwise. If the EUT uses an adjustable antenna, the antenna shall be positioned to the length that produces the worst case emission at the fundamental operating frequency.
- (3) Adjust the spectrum analyzer for the following setting;  
RBW=100 kHz for spurious emission below 1 GHz, and 1MHz for spurious emission above 1GHz;  
VBW=300k for spurious emission below 1GHz, and 3MHz for spurious emission above 1GHz;
- (4) Sweep speed slow enough to maintain measurement calibration;
- (5) Detector Mode= Positive Peak;
- (6) Place the transmitter to be tested on the turntable in the standard test site, or FCC listed site compliant with ANSI C63.4-2001 clause 5.4. The transmitter is transmitting into a non-radiating load that is placed on the turntable, the RF cable to this load should be of minimum length. For transmitters with integral antennas, the tests are to be run with the unit operating into the integral antenna.
- (7) For each spurious measurement the test antenna should be adjusted to the correct length for the frequency involved. This length may be determined from a calibration ruler supplied with the device. Measurements shall be made from the lowest radio frequency generated in the device to the tenth harmonic of the carrier, except for the region close to the carrier equal to  $\pm$  the test bandwidth.
- (8) Key the transmitter with normal modulation base the standard.
- (9) For each spurious frequency, raise and lower the test antenna from 1 m to 4 m to obtain a maximum reading on the spectrum analyzer with the test antenna at horizontal polarity. Then the turntable should

be rotated 360° to determine the maximum reading. Repeat this procedure to obtain the highest possible reading. Record this maximum reading.

- (10) Repeat step (9) for each spurious frequency with the test antenna polarized vertically.
- (11) Calculate power in dBm into a reference ideal half-wave dipole antenna by reducing the readings obtained by the power loss in the cable between the generator and the antenna, and further corrected for the gain of the substitution antenna used relative to an ideal half-wave dipole antenna by the following formula:

$$P_d(\text{dBm}) = P_g(\text{dBm}) - \text{cable loss}(\text{dB}) + \text{antenna gain}(\text{dB})$$

Where:  $P_d$  is the dipole equivalent power and  $P_g$  is the generator output power into the substitution antenna.

During the test, when the EUT is in Downlink working state, the test radiated emissions is the worst, so the data is recorded.

NOTE 1: It is permissible to use other antennas provided they can be referenced to a dipole.

NOTE 2: Effective radiated power(e.r.p) refers to the radiation of a half wave tuned dipole instead of an isotropic antenna. There is a constant difference of 2.15 dB between e.i.r.p and  
 $e.r.p.(\text{dBm}) = e.i.r.p(\text{dB}) - 2.15$

NOTE 3: The test frequency is set as the center frequency of the frequency band.



11.11.4. Test results

11.11.4.1. Below 1GHz

11.11.4.1.1. 700MHz Band

11.11.4.1.1.1. Polarization type: Horizontal

Test Result:	PASS	Polarization:	Horizontal
Standard:	FCC PART 90	Power Source:	AC 110V, 50Hz
Test item:	Radiation spurious emissions	Date:	2023-05-31
Temp.(°C)/Hum.(%RH):	23.2°C/54%RH	Time:	10:37:41
EUT:	Public Safety DAS	Test mode:	Downlink mode
Model:	RH78V3-B	Distance:	3m
Note:	/		



No.	Frequency	Reading	Correct	Result	Limit	Margin	Remark
	(MHz)	(dBm)	Factor(dB)	(dBm)	(dBm)	(dB)	
1	31.7341	-93.19	31.19	-62.00	-13.00	-49.00	peak
2	51.4530	-87.80	29.17	-58.63	-13.00	-45.63	peak
3	174.1811	-71.89	23.49	-48.40	-13.00	-35.40	peak
4	413.8470	-90.44	27.78	-62.66	-13.00	-49.66	peak
5	645.1195	-95.41	33.92	-61.49	-13.00	-48.49	peak
6	994.3963	-97.22	35.89	-61.33	-13.00	-48.33	peak

NOTE 1: When the read value of the test frequency does not exceed the peak limit, peak is used instead of RMS value.

NOTE 2: In the above figure, ① means downlink signal, its frequency is 772MHz.,

11.11.4.1.1.2. Polarization type: Vertical

Test Result:	PASS	Polarization:	Vertical
Standard:	FCC PART 90	Power Source:	AC 110V, 50Hz
Test item:	Radiation spurious emissions	Date:	2023-05-31
Temp.(°C)/Hum.(%RH):	23.2°C/54%RH	Time:	10:42:04
EUT:	Public Safety DAS	Test mode:	Downlink mode
Model:	RH78V3-B	Distance:	3m
Note:	/		

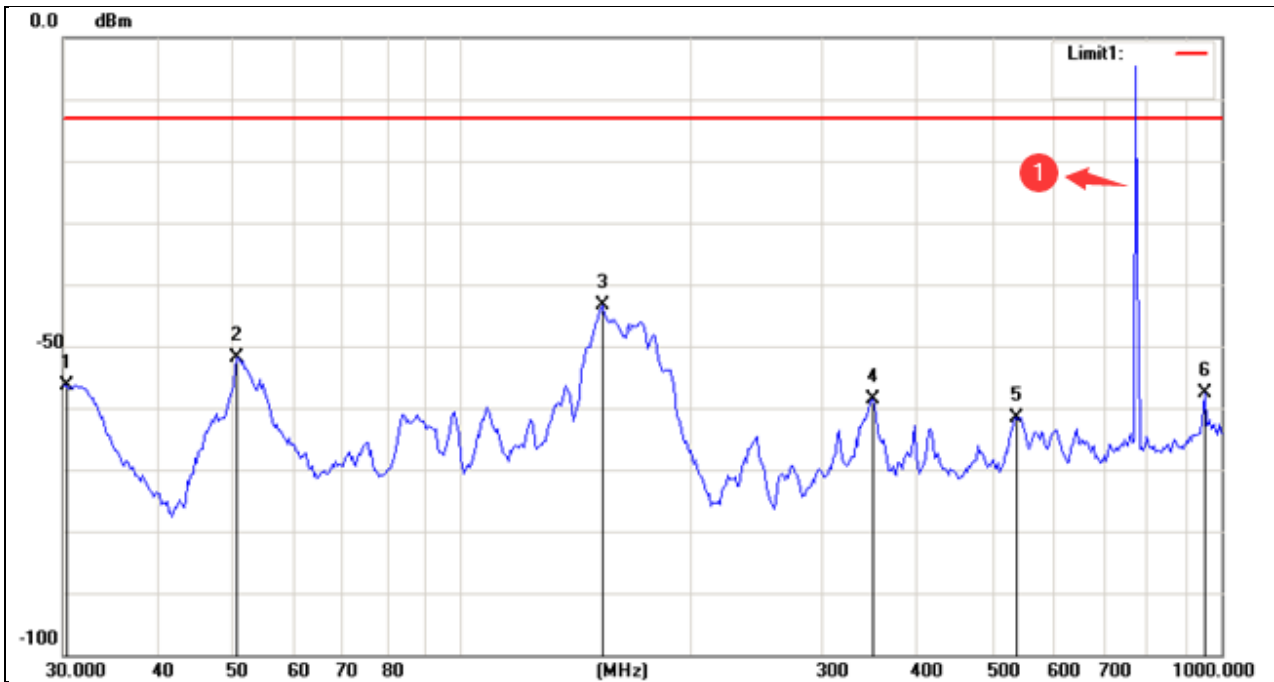

No.	Frequency	Reading	Correct	Result	Limit	Margin	Remark
	(MHz)	(dBm)	Factor(dB)	(dBm)	(dBm)	(dB)	
1	30.3391	-79.65	23.37	-56.28	-13.00	-43.28	peak
2	50.8779	-77.75	25.96	-51.79	-13.00	-38.79	peak
3	153.9253	-70.72	27.27	-43.45	-13.00	-30.45	peak
4	347.6834	-86.39	27.66	-58.73	-13.00	-45.73	peak
5	538.9442	-92.32	30.75	-61.57	-13.00	-48.57	peak
6	950.6823	-93.61	35.98	-57.63	-13.00	-44.63	peak

NOTE 1: When the read value of the test frequency does not exceed the peak limit, peak is used instead of RMS value.

NOTE 2: In the above figure, ① means downlink signal, its frequency is 772MHz,.

11.11.4.1.2. 800MHz Band

11.11.4.1.2.1. Polarization type: Horizontal

Test Result:	PASS	Polarization:	Horizontal
Standard:	FCC PART 90	Power Source:	AC 110V, 50Hz
Test item:	Radiation spurious emissions	Date:	2023-05-31
Temp.(°C)/Hum.(%RH):	23.2°C/54%RH	Time:	10:34:20
EUT:	Public Safety DAS	Test mode:	Downlink mode
Model:	RH78V3-B	Distance:	3m
Note:	/		

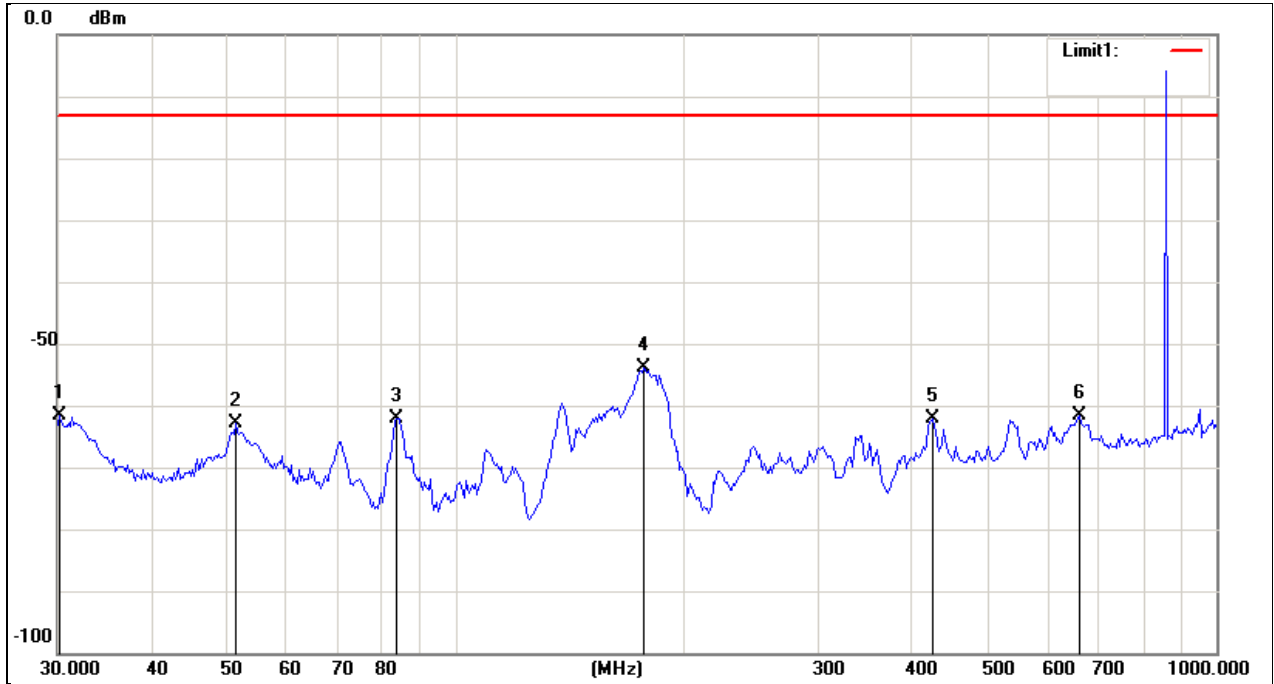

No.	Frequency	Reading	Correct	Result	Limit	Margin	Remark
	(MHz)	(dBm)	Factor(dB)	(dBm)	(dBm)	(dB)	
1	30.1691	-93.24	31.65	-61.59	-13.00	-48.59	peak
2	51.4530	-92.04	29.17	-62.87	-13.00	-49.87	peak
3	83.8947	-83.89	21.80	-62.09	-13.00	-49.09	peak
4	177.1425	-77.67	23.68	-53.99	-13.00	-40.99	peak
5	423.2548	-90.91	28.67	-62.24	-13.00	-49.24	peak
6	659.7846	-95.86	34.23	-61.63	-13.00	-48.63	peak

NOTE 1: When the read value of the test frequency does not exceed the peak limit, peak is used instead of RMS value.

NOTE 2: In the above figure, ① means downlink signal, its frequency is 856MHz,.

11.11.4.1.2.2. Polarization type: Vertical

Test Result:	PASS	Polarization:	Vertical
Standard:	FCC PART 90	Power Source:	AC 110V, 50Hz
Test item:	Radiation spurious emissions	Date:	2023-05-31
Temp.(°C)/Hum.(%RH):	23.2°C/54%RH	Time:	10:29:44
EUT:	Public Safety DAS	Test mode:	Downlink mode
Model:	RH78V3-B	Distance:	3m
Note:	/		

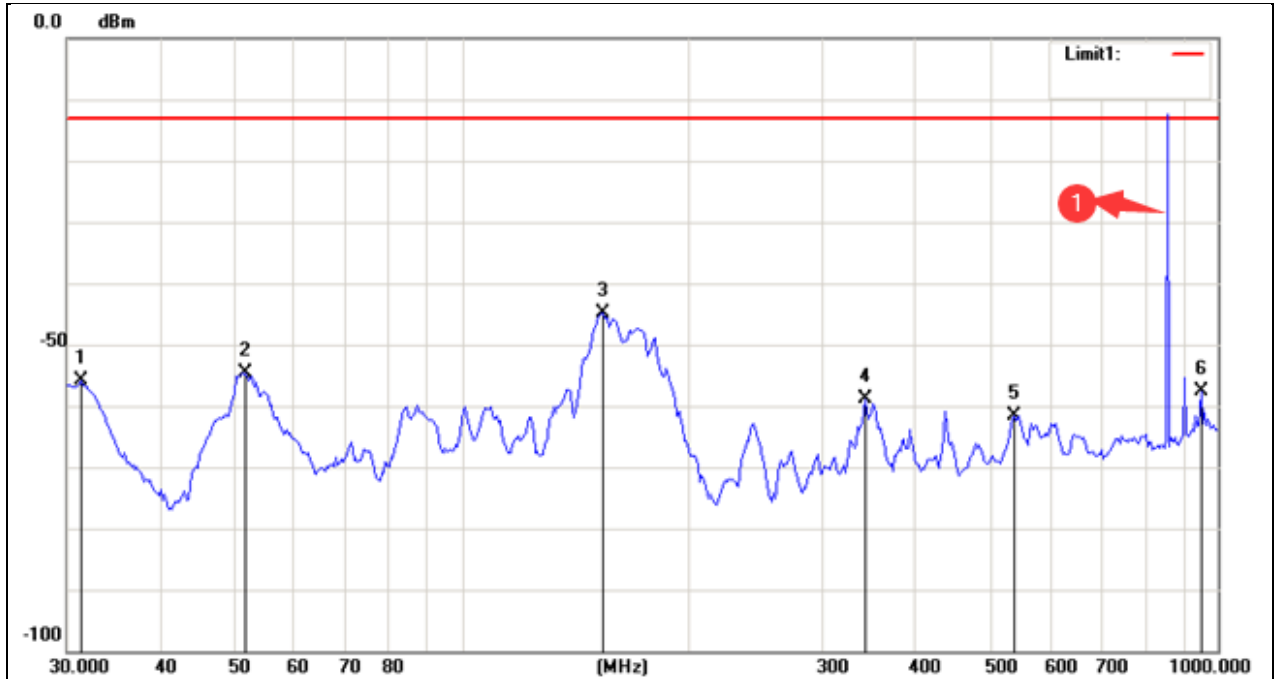

No.	Frequency	Reading	Correct	Result	Limit	Margin	Remark
	(MHz)	(dBm)	Factor(dB)	(dBm)	(dBm)	(dB)	
1	31.3795	-79.13	23.26	-55.87	-13.00	-42.87	peak
2	51.7429	-80.48	25.87	-54.61	-13.00	-41.61	peak
3	153.9253	-72.02	27.27	-44.75	-13.00	-31.75	peak
4	341.8711	-86.30	27.39	-58.91	-13.00	-45.91	peak
5	538.9442	-92.45	30.75	-61.70	-13.00	-48.70	peak
6	950.6823	-93.50	35.98	-57.52	-13.00	-44.52	peak

NOTE 1: When the read value of the test frequency does not exceed the peak limit, peak is used instead of RMS value.

NOTE 2: In the above figure, ① means downlink signal, its frequency is 856MHz,.

11.11.4.2. Above 1GHz

11.11.4.2.1. 700MHz Band

11.11.4.2.1.1. Polarization type: Horizontal

Test Result:	PASS	Polarization:	Horizontal
Standard:	FCC PART 90	Power Source:	AC 110V, 50Hz
Test item:	Radiation spurious emissions	Date:	2023-05-31
Temp.(°C)/Hum.(%RH):	23.2°C/54%RH	Time:	10:08:45
EUT:	Public Safety DAS	Test mode:	Downlink mode
Model:	RH78V3-B	Distance:	3m
Note:	/		

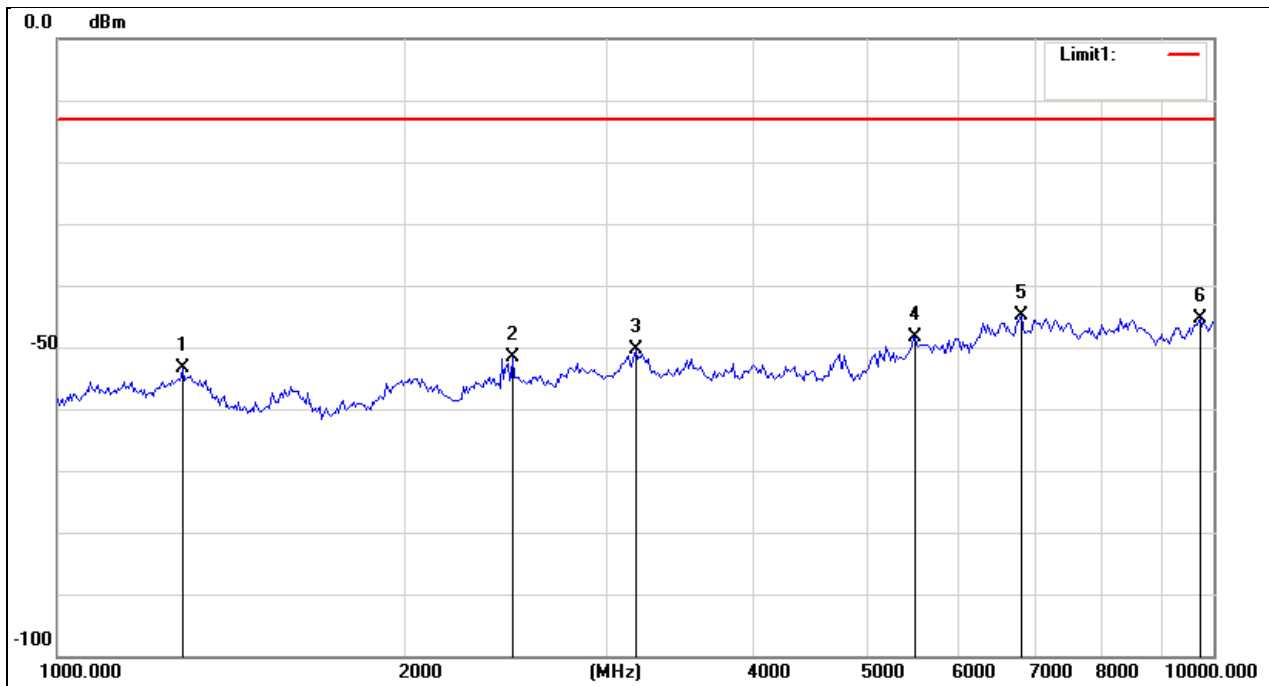

No.	Frequency	Reading	Correct	Result	Limit	Margin	Remark
	(MHz)	(dBm)	Factor(dB)	(dBm)	(dBm)	(dB)	
1	1285.211	-63.44	10.00	-53.44	-13.00	-40.44	peak
2	2478.739	-61.80	10.09	-51.71	-13.00	-38.71	peak
3	3162.278	-61.85	11.56	-50.29	-13.00	-37.29	peak
4	5520.611	-65.85	17.60	-48.25	-13.00	-35.25	peak
5	6812.921	-66.58	21.77	-44.81	-13.00	-31.81	peak
6	9745.005	-67.42	21.93	-45.49	-13.00	-32.49	peak

NOTE: When the read value of the test frequency does not exceed the peak limit, peak is used instead of RMS value.

11.11.4.2.1.2. Polarization type: Vertical

Test Result:	PASS	Polarization:	Vertical
Standard:	FCC PART 90	Power Source:	AC 110V, 50Hz
Test item:	Radiation spurious emissions	Date:	2023-05-31
Temp.(°C)/Hum.(%RH):	23.2°C/54%RH	Time:	10:05:27
EUT:	Public Safety DAS	Test mode:	Downlink mode
Model:	RH78V3-B	Distance:	3m
Note:	/		

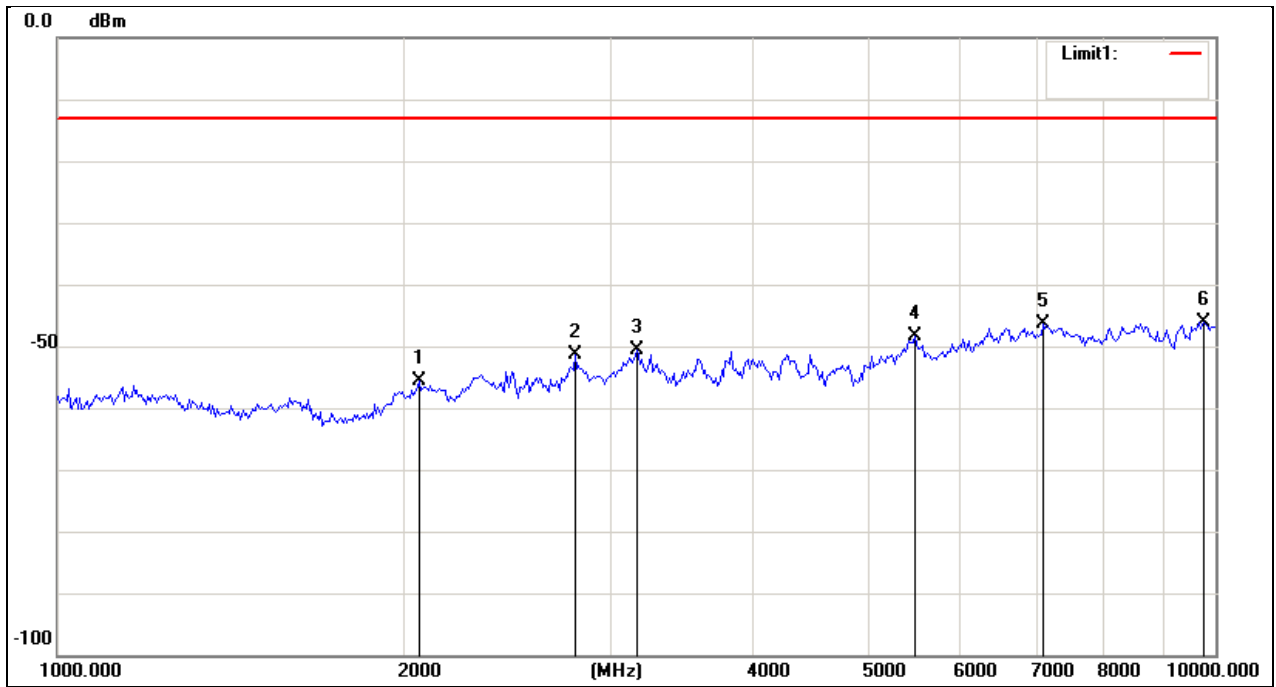

No.	Frequency	Reading	Correct	Result	Limit	Margin	Remark
	(MHz)	(dBm)	Factor(dB)	(dBm)	(dBm)	(dB)	
1	2053.525	-64.35	8.66	-55.69	-13.00	-42.69	peak
2	2799.725	-61.93	10.67	-51.26	-13.00	-38.26	peak
3	3162.278	-61.99	11.34	-50.65	-13.00	-37.65	peak
4	5500.278	-66.10	17.65	-48.45	-13.00	-35.45	peak
5	7095.149	-68.34	21.99	-46.35	-13.00	-33.35	peak
6	9781.031	-68.22	22.11	-46.11	-13.00	-33.11	peak

NOTE: When the read value of the test frequency does not exceed the peak limit, peak is used instead of RMS value.

11.11.4.2.2. 800MHz Band

11.11.4.2.2.1. Polarization type: Horizontal

Test Result:	PASS	Polarization:	Horizontal
Standard:	FCC PART 90	Power Source:	AC 110V, 50Hz
Test item:	Radiation spurious emissions	Date:	2023-05-31
Temp.(°C)/Hum.(%RH):	23.2°C/54%RH	Time:	10:12:18
EUT:	Public Safety DAS	Test mode:	Downlink mode
Model:	RH78V3-B	Distance:	3m
Note:	/		

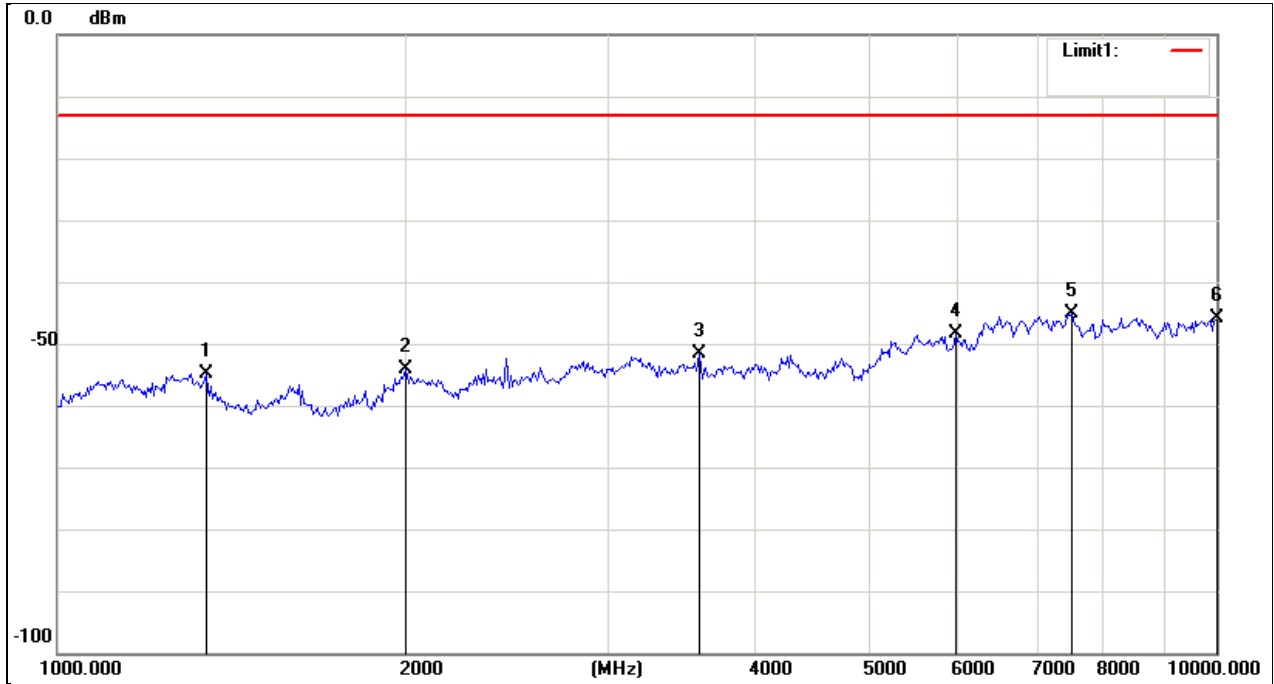

No.	Frequency	Reading	Correct	Result	Limit	Margin	Remark
	(MHz)	(dBm)	Factor(dB)	(dBm)	(dBm)	(dB)	
1	1343.399	-63.80	9.00	-54.80	-13.00	-41.80	peak
2	2001.161	-63.80	9.80	-54.00	-13.00	-41.00	peak
3	3584.984	-63.91	12.26	-51.65	-13.00	-38.65	peak
4	5965.420	-66.56	18.25	-48.31	-13.00	-35.31	peak
5	7498.942	-67.21	22.09	-45.12	-13.00	-32.12	peak
6	10000.000	-68.55	22.70	-45.85	-13.00	-32.85	peak

NOTE: When the read value of the test frequency does not exceed the peak limit, peak is used instead of RMS value.

11.11.4.2.2.2. Polarization type: Vertical

Test Result:	PASS	Polarization:	Vertical
Standard:	FCC PART 90	Power Source:	AC 110V, 50Hz
Test item:	Radiation spurious emissions	Date:	2023-05-31
Temp.(°C)/Hum.(%RH):	23.2°C/54%RH	Time:	10:16:29
EUT:	Public Safety DAS	Test mode:	Downlink mode
Model:	RH78V3-B	Distance:	3m
Note:	/		

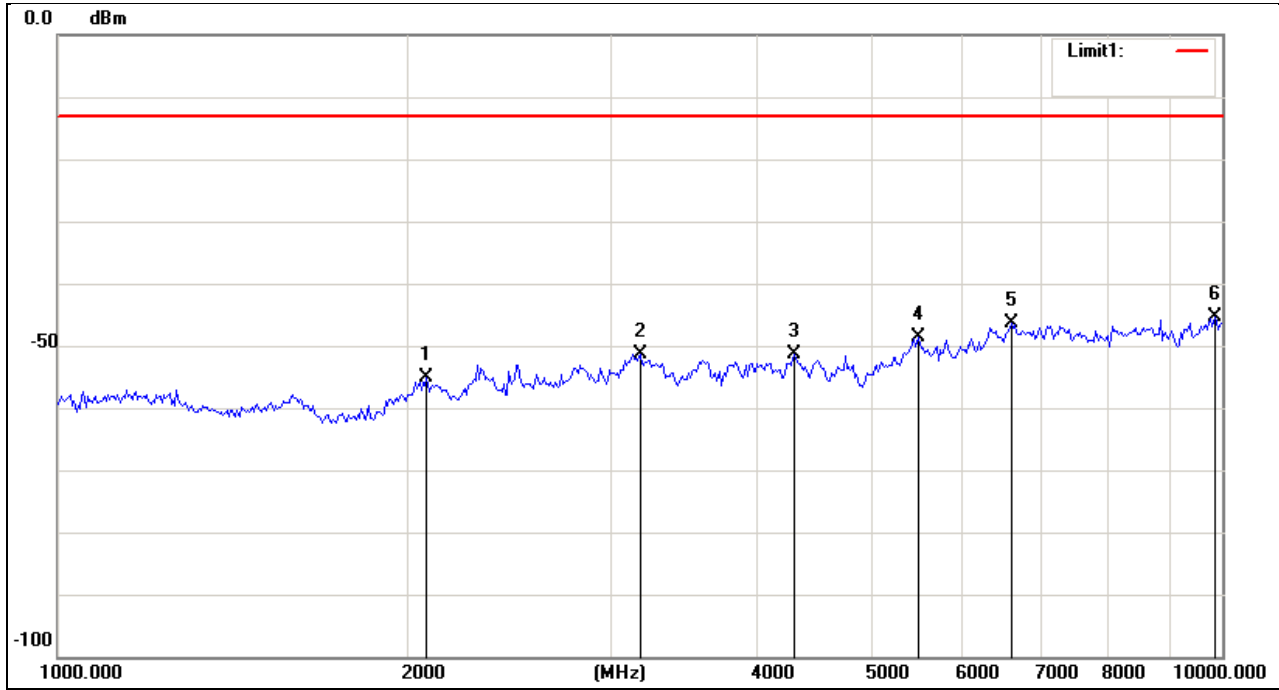

No.	Frequency	Reading	Correct	Result	Limit	Margin	Remark
	(MHz)	(dBm)	Factor(dB)	(dBm)	(dBm)	(dB)	
1	2076.384	-64.25	9.06	-55.19	-13.00	-42.19	peak
2	3162.278	-62.74	11.34	-51.40	-13.00	-38.40	peak
3	4295.491	-65.93	14.68	-51.25	-13.00	-38.25	peak
4	5480.019	-66.37	17.78	-48.59	-13.00	-35.59	peak
5	6590.377	-67.35	20.93	-46.42	-13.00	-33.42	peak
6	9853.482	-67.48	22.06	-45.42	-13.00	-32.42	peak

NOTE: When the read value of the test frequency does not exceed the peak limit, peak is used instead of RMS value.



**APPENDIX A. PHOTOGRAPH OF THE TEST CONNECTION DIAGRAM**

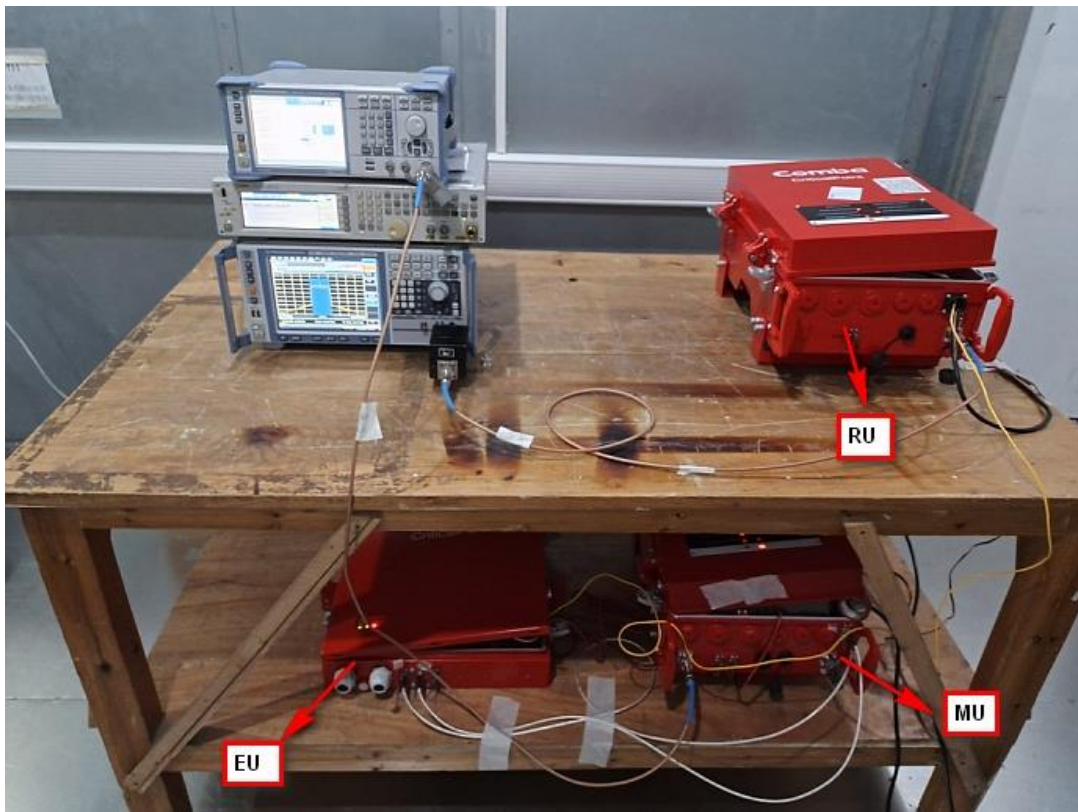

Normal temperature test scenario



Test scenario-2

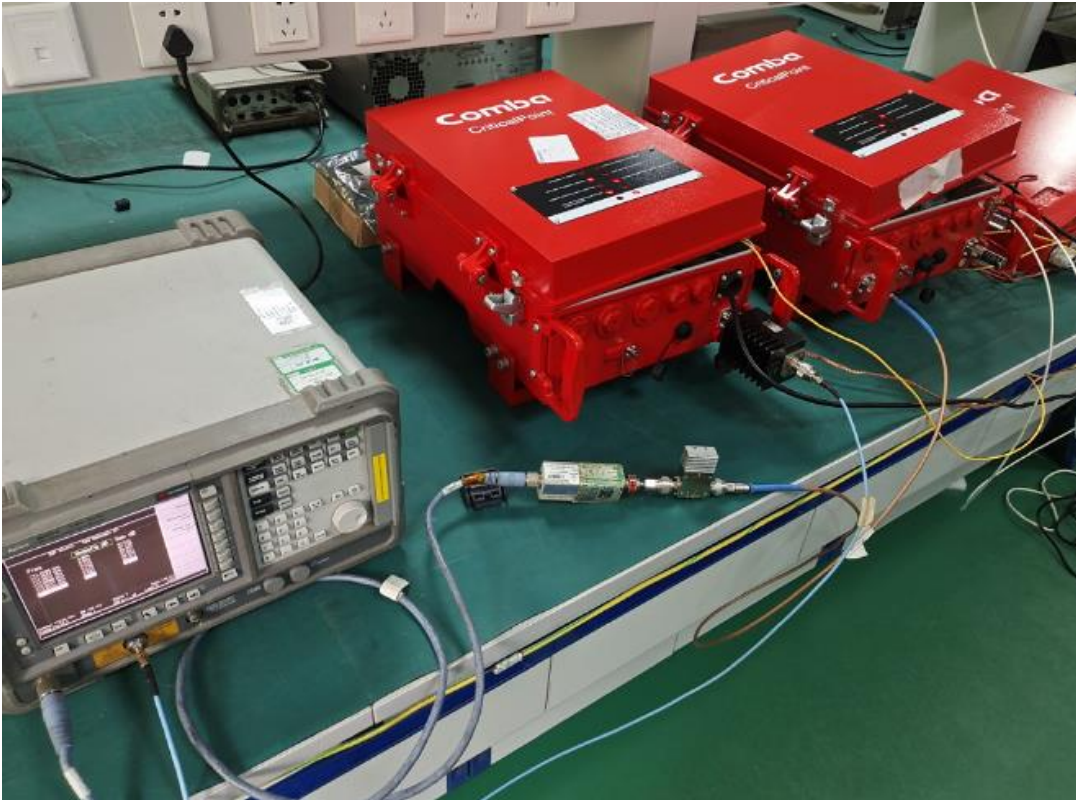

Test scenario-3



Temperature change test-1



Temperature change test-2



Temperature change test-3



Temperature change test-4

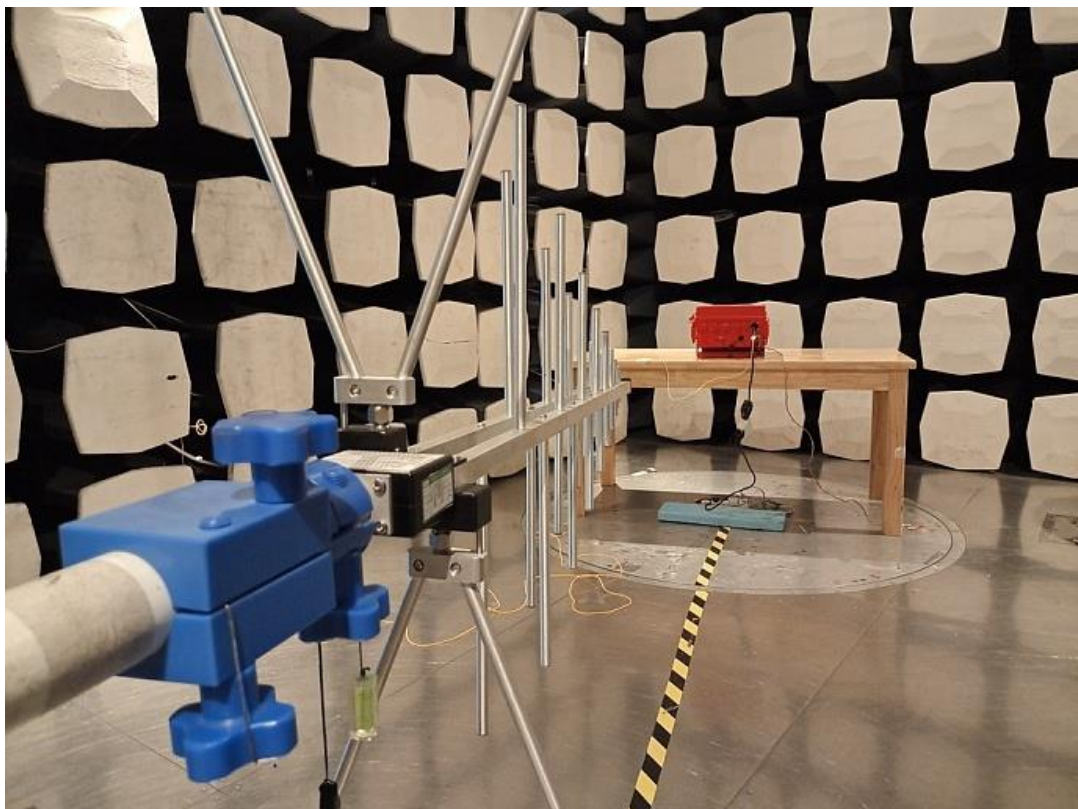

Radiated spurious emissions—Below 1GHz

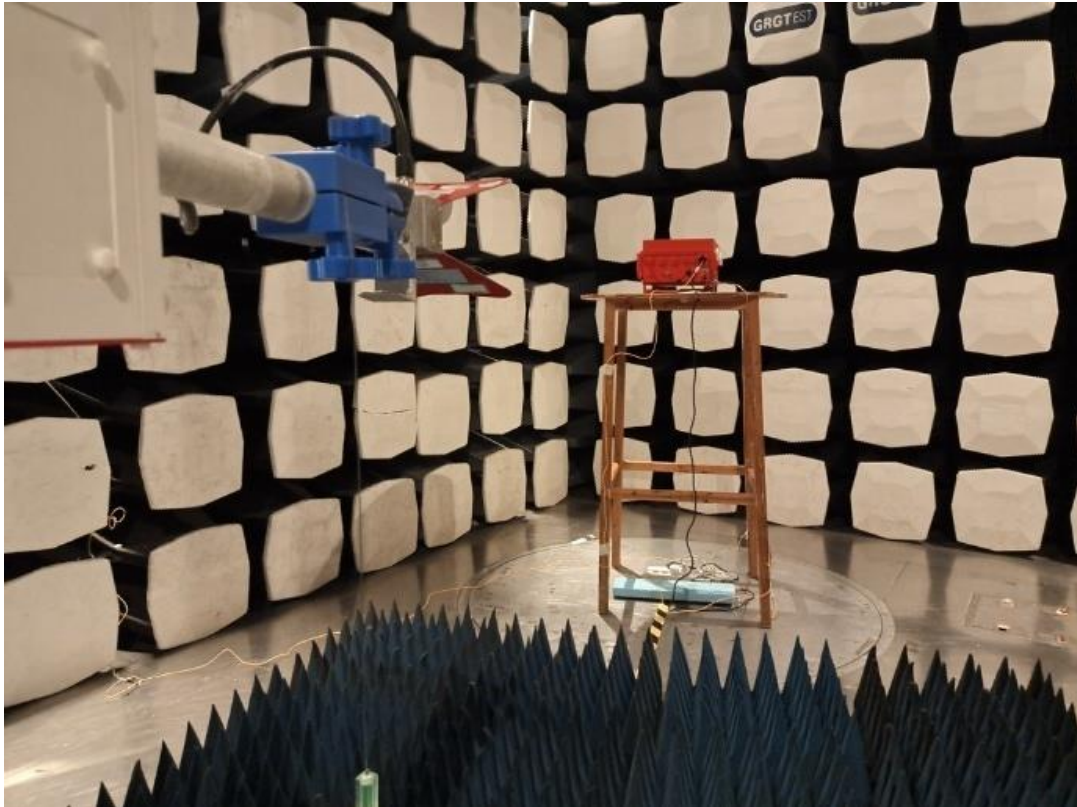

Radiated spurious emissions—Above 1GHz

----- The following blanks -----

## APPENDIX B. PHOTOGRAPHS OF EUT

### B.1 External photos



Top surface



Front surface



Side surface-1



Side surface-2



Behind surface

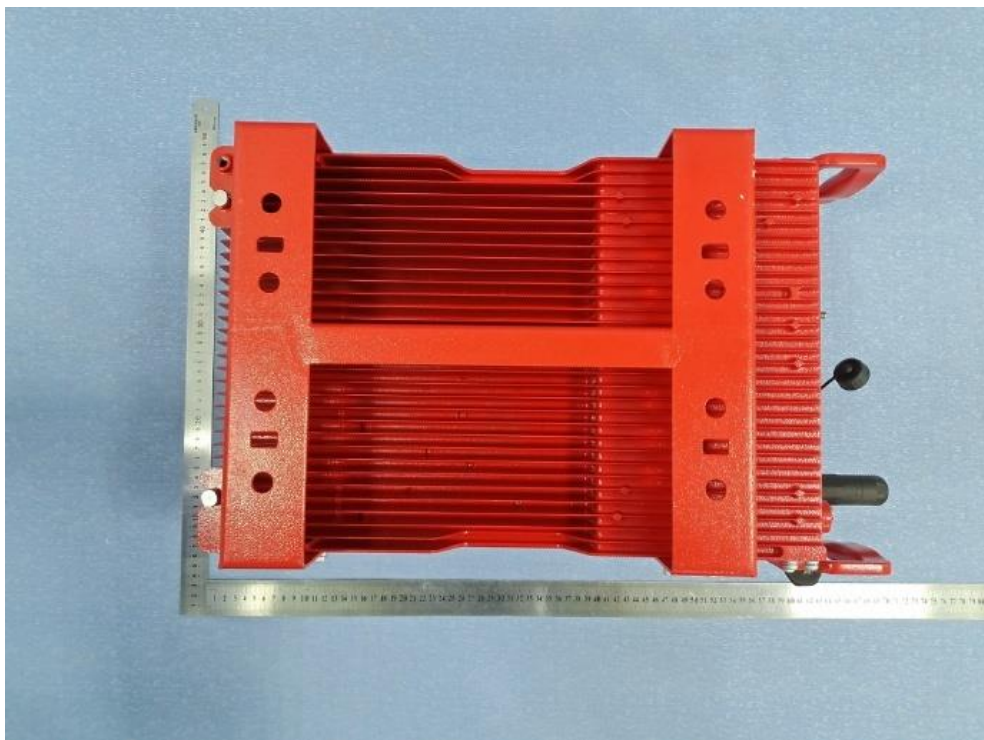

Bottom surface

----- End of Report -----