

10.2.3.4. Analog FM (12.5kHz)

10.2.3.4.1. Downlink

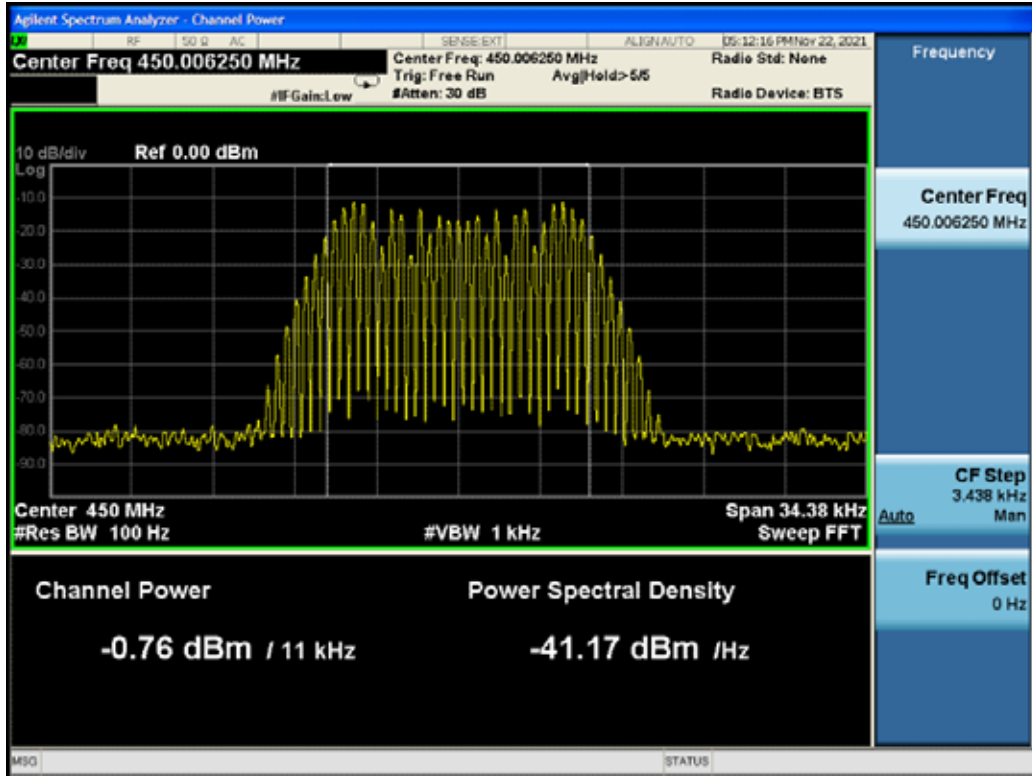

Low Frequency: 450.00625MHz

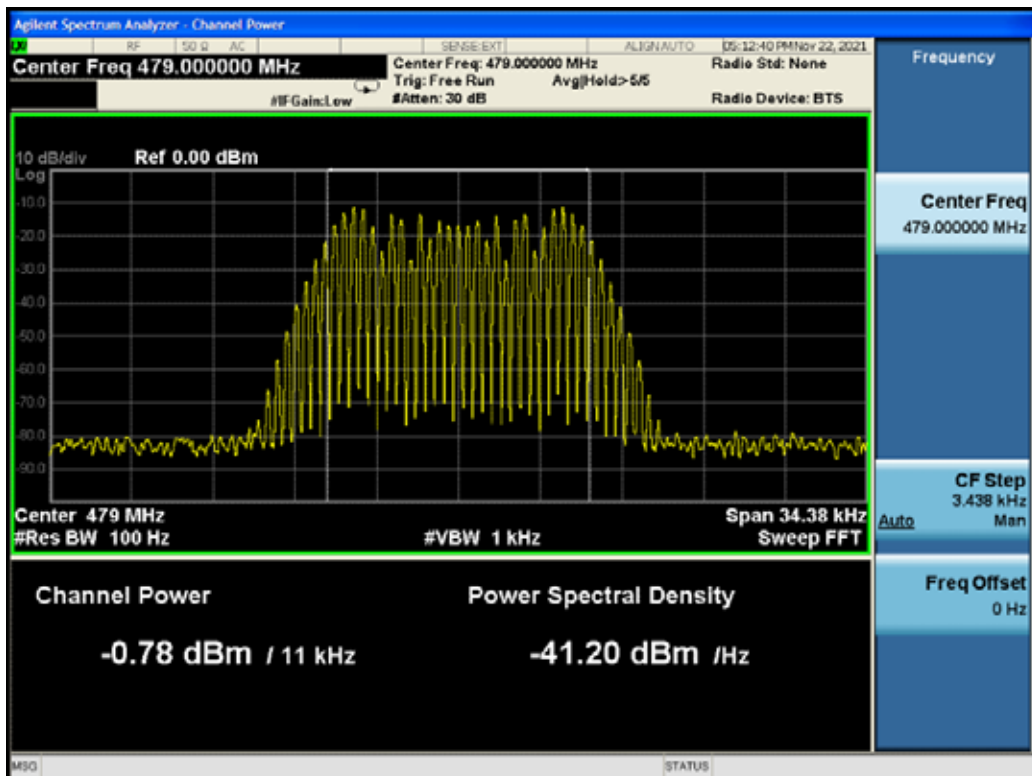

Middle Frequency: 479.0MHz

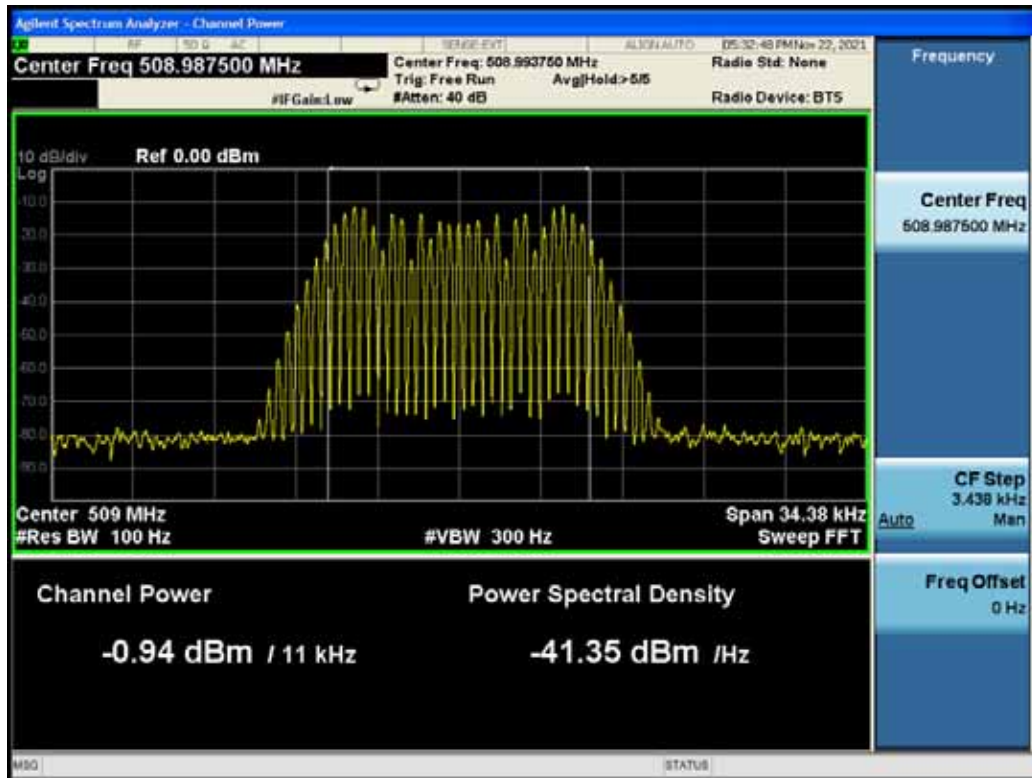

High Frequency: 508.99375MHz

10.2.3.4.2. Uplink

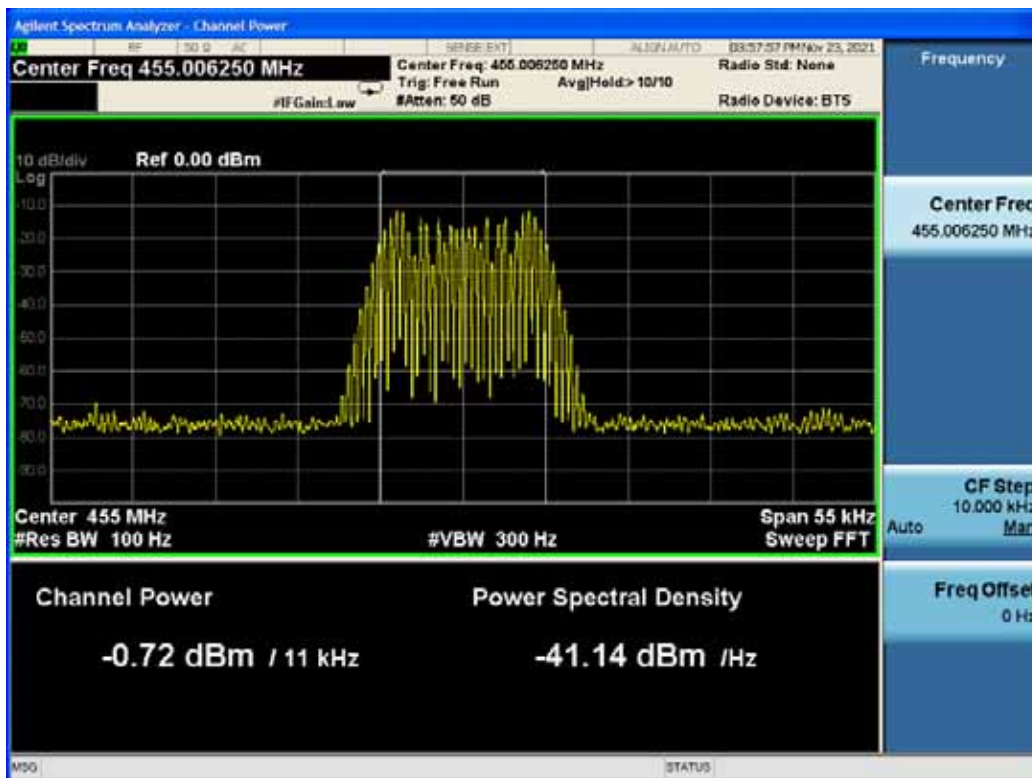

Low Frequency: 455.00625MHz

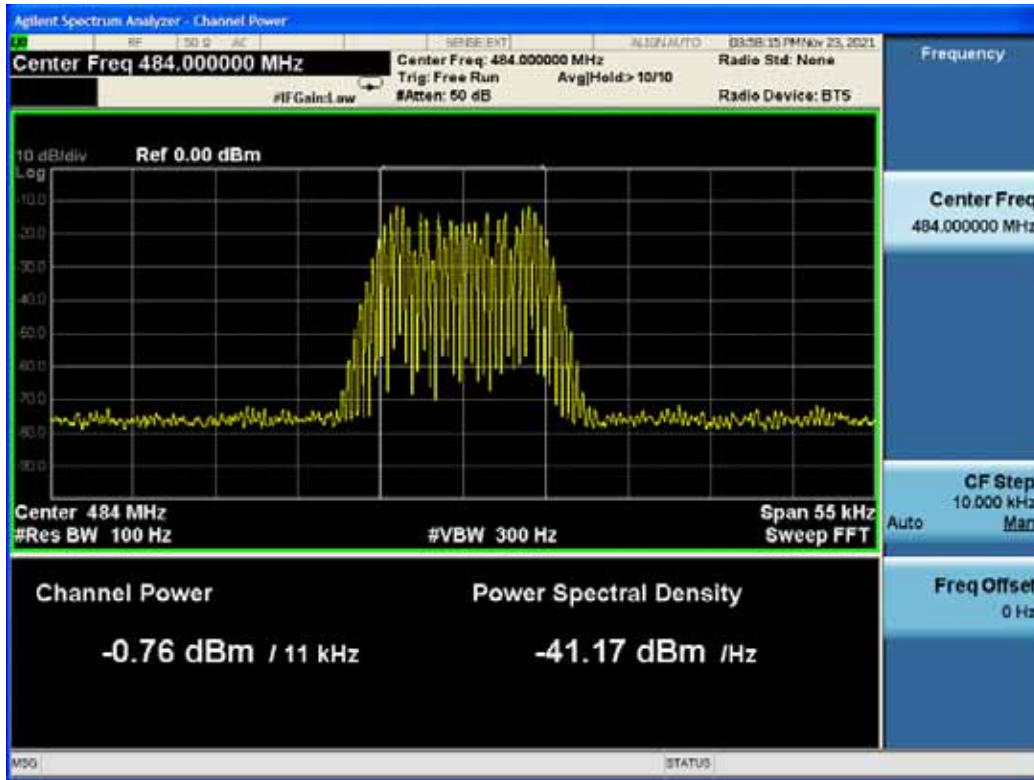

Middle Frequency: 484.0MHz

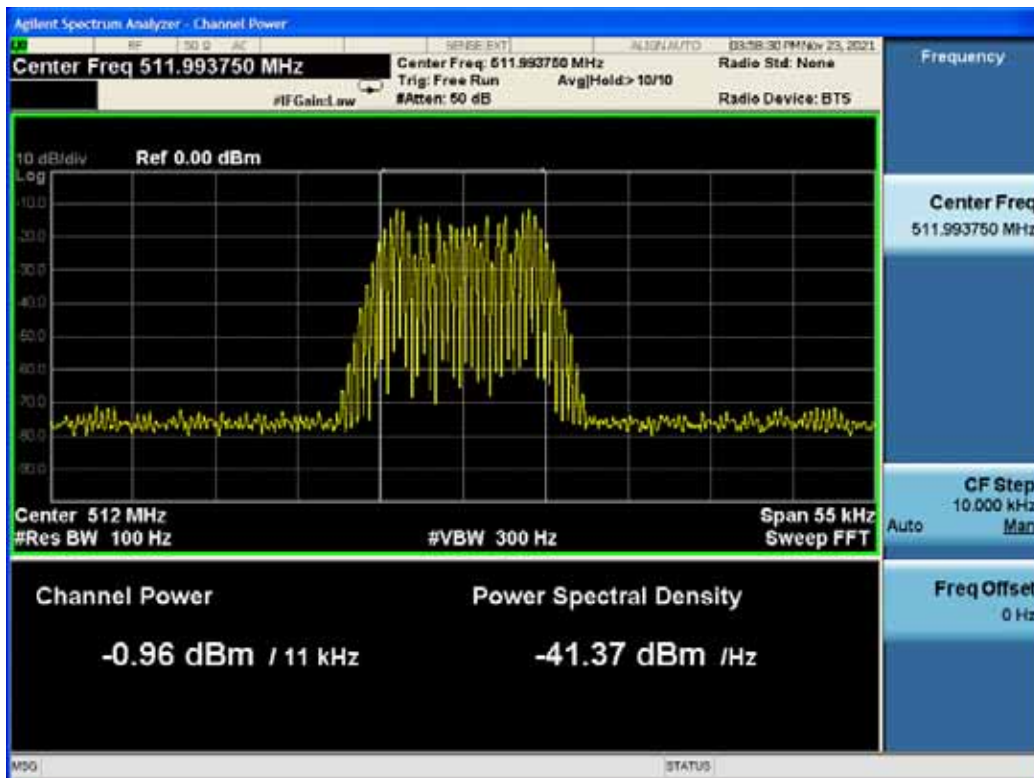

High Frequency: 511.99375MHz

10.2.3.5. Analog FM (25kHz)

10.2.3.5.1. Downlink

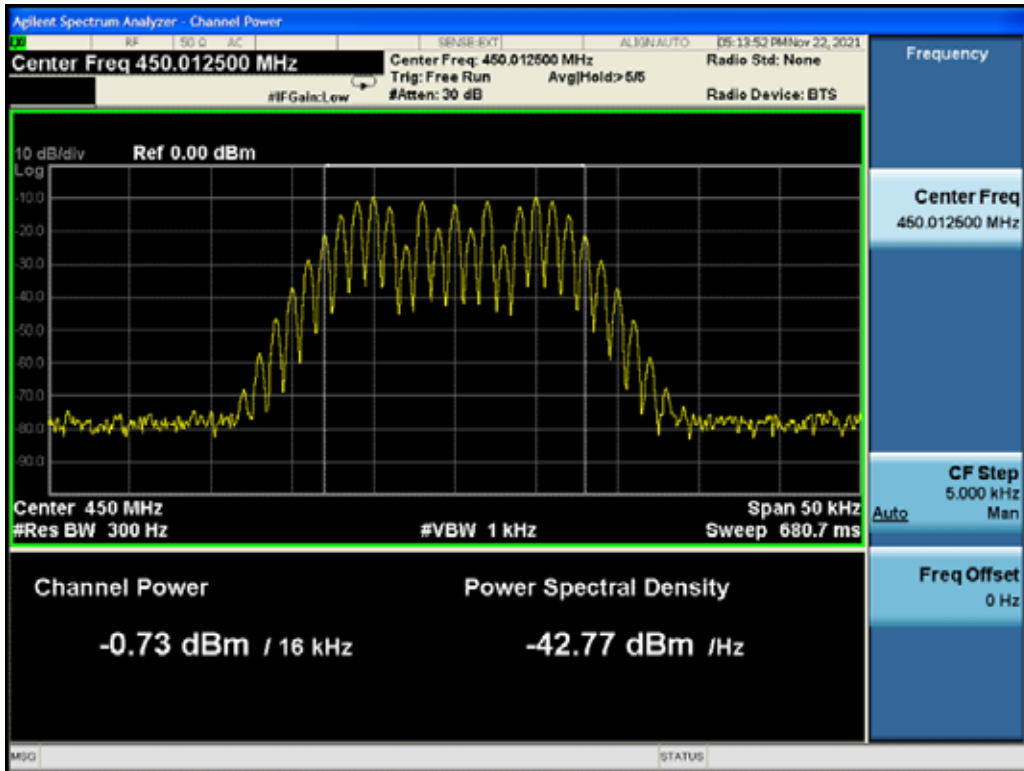

Low Frequency: 450.0125MHz

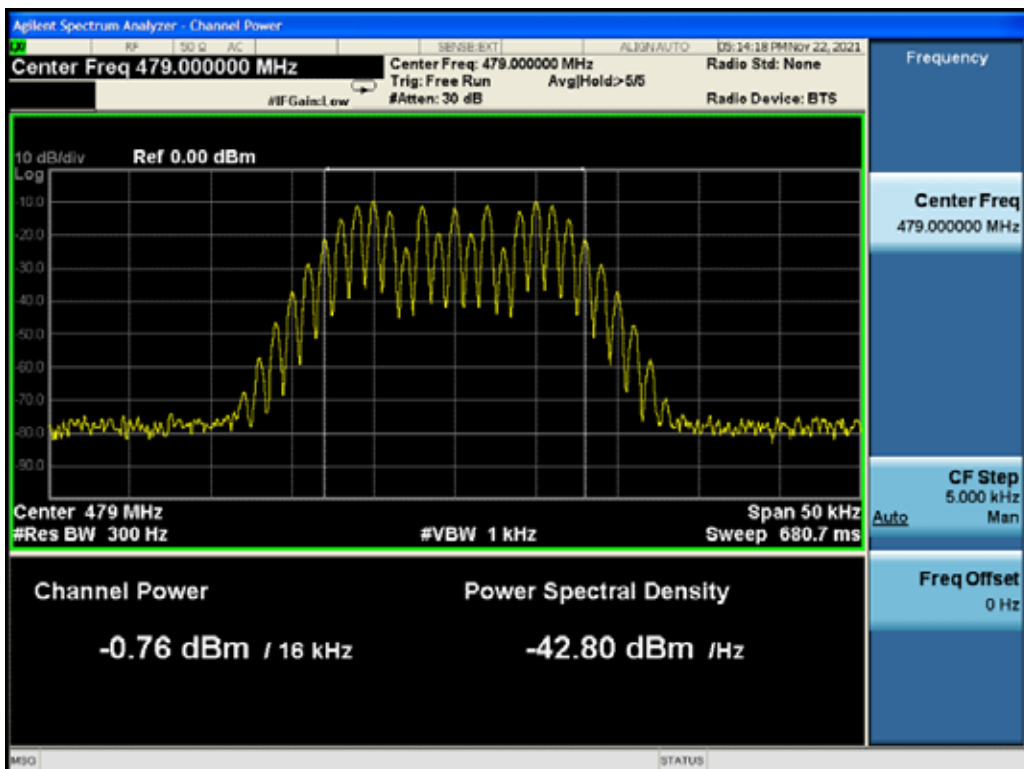

Middle Frequency: 479.0MHz

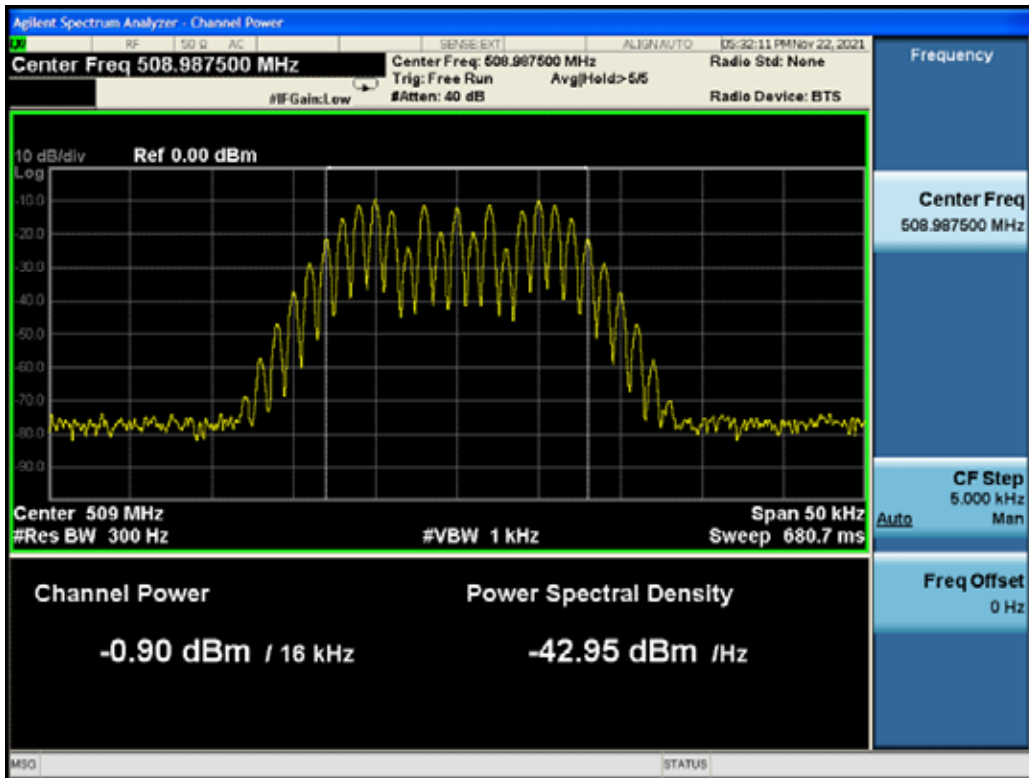

High Frequency: 508.9875MHz

10.2.3.5.2. Uplink

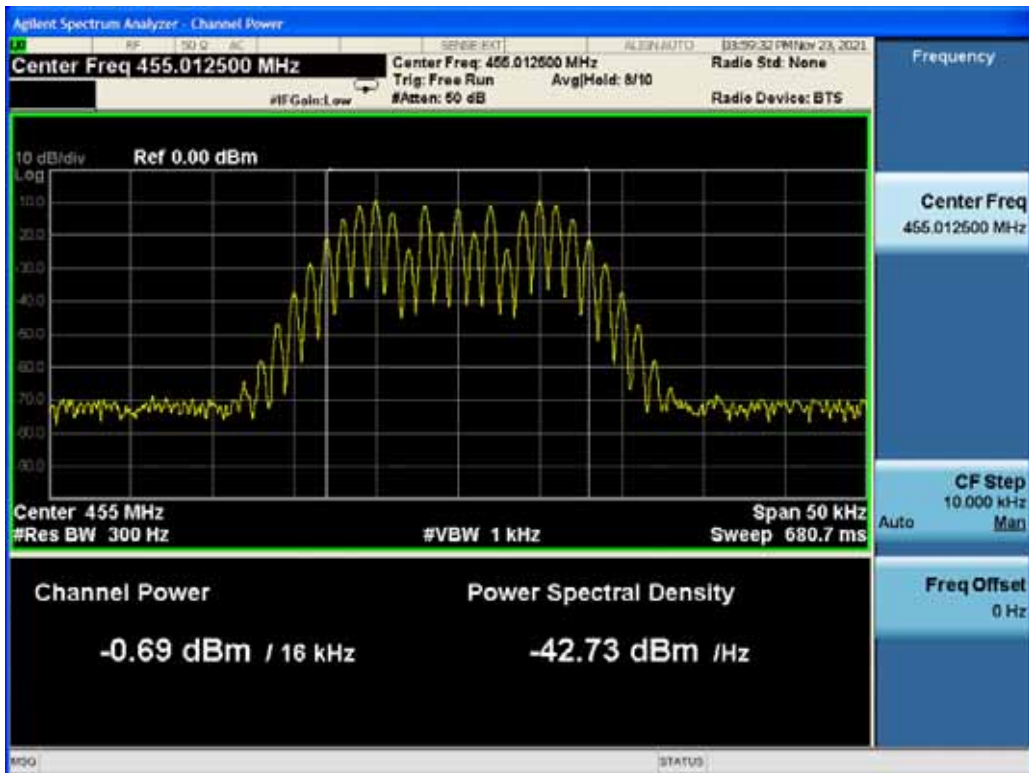

Low Frequency: 455.0125MHz

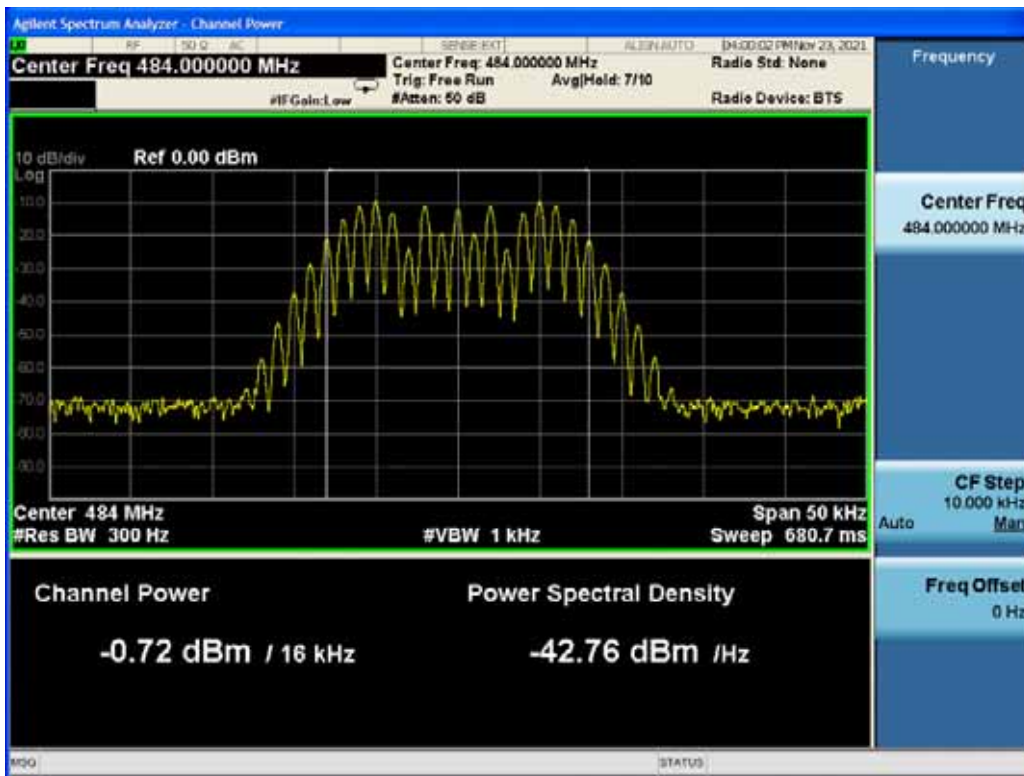

Middle Frequency: 484.0MHz

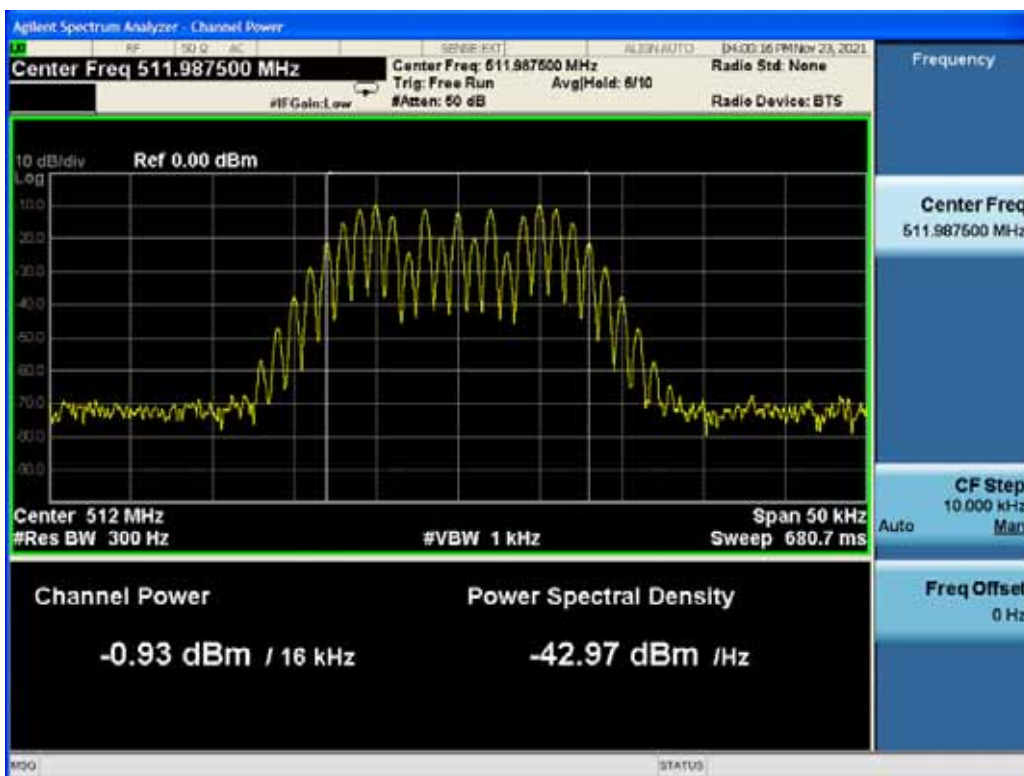

High Frequency: 511.9875MHz

10.3. AGC Threshold

Requirements: KDB 935210 D05 clause 4.2

Test Method: KDB 935210 D05 clause 3.2

10.3.1. Requirements

Testing at and above the AGC threshold will be required.⁶ The AGC threshold shall be determined by applying the procedure of 3.2, but with the signal generator configured to produce a test signal defined in Table 1, a CW input signal, or a digitally modulated signal, consistent with the discussion about signal types in 4.1.

10.3.2. Test configuration

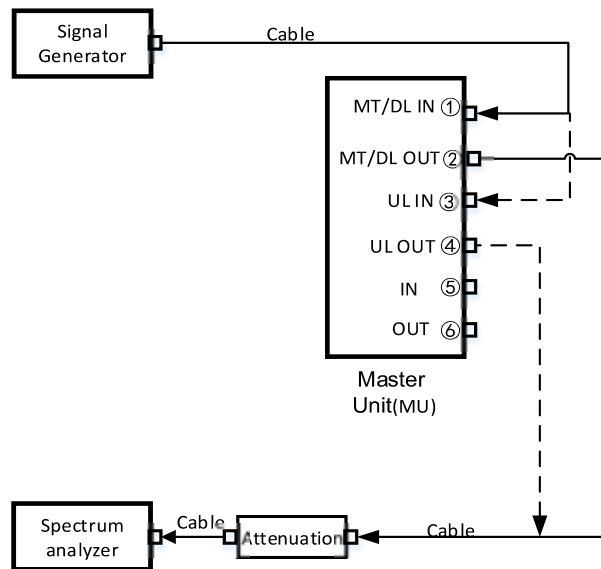

Figure 10.3-1 MU single device test connection diagram

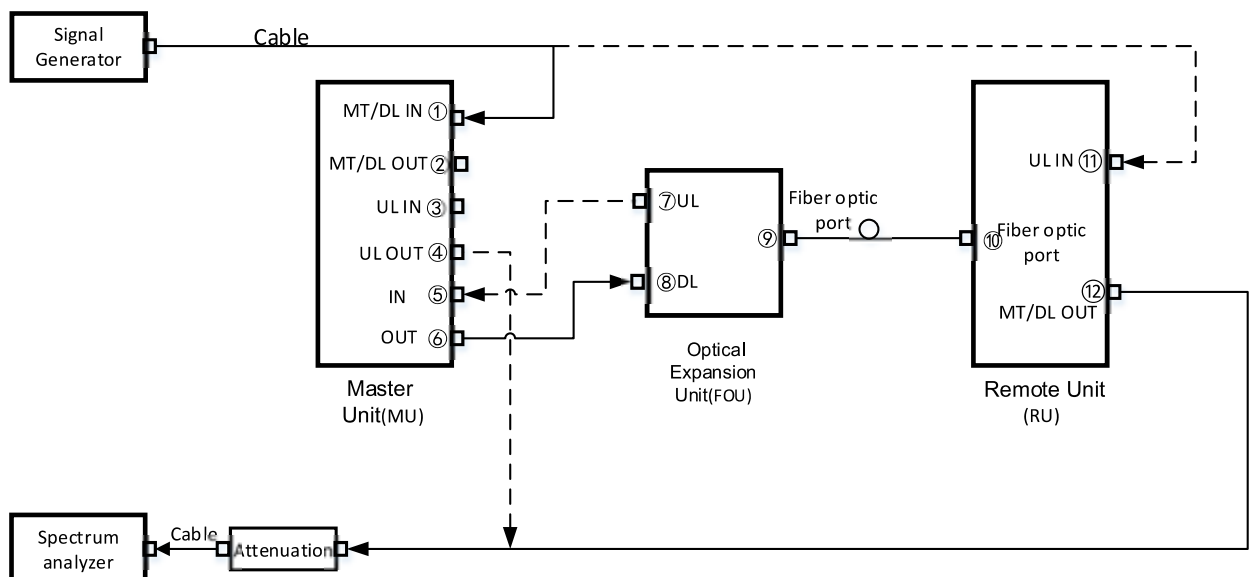

Figure 10.3-2 MU, FOU and RU system test connection diagram

10.3.3. Test procedures

3.2 Measuring AGC threshold level

The AGC threshold is to be determined as follows.³

In the case of fiber-optic distribution systems, the RF input port of the equipment under test (EUT) refers to the RF input of the supporting equipment RF to optical convertor; see also descriptions and diagrams for typical DAS booster systems in KDB Publication 935210 D02 [R7].

Devices intended to be directly connected to an RF source (donor port) only need to be evaluated for any over-the-air transmit paths.

- a) Connect a signal generator to the input of the EUT.
- b) Connect a spectrum analyzer or power meter to the output of the EUT using appropriate attenuation as necessary.
- c) The signal generator should initially be configured to produce either of the required test signals (i.e., broadband or narrowband).
- d) Set the signal generator frequency to the center frequency of the EUT operating band.
- e) While monitoring the output power of the EUT, measured using the methods of 3.5.3 or 3.5.4, increase the input level until a 1 dB increase in the input signal power no longer causes a 1 dB increase in the output signal power.
- f) Record this level as the AGC threshold level.
- g) Repeat the procedure with the remaining test signal.

———— The following blanks ————

10.3.4. Test results

Test Date (yy-mm-dd): 2021-11-26

Normal condition: Temp: 27.7°C, Humid:39%, Atmospheric Pressure:101kpa

Supply Voltage: DC -48V

10.3.4.1. System test

10.3.4.1.1. Downlink

Test frequency	Signal output power (dBm)	EUT Input cable loss (dB)	EUT Corrected Input power (dBm)	EUT Corrected Output power (dBm)
Downlink 479.0MHz	-73.9	1.1	-75.0	30.2
	-72.9	1.1	-74.0	31.2
	-71.9	1.1	-73.0	32.2
	-70.9	1.1	-72.0	33.2
	-69.9	1.1	-71.0	34.2
	-68.9	1.1	-70.0	35.2
	-67.9	1.1	-69.0	35.2
	-66.9	1.1	-68.0	35.2
	-65.9	1.1	-67.0	35.2
	-64.9	1.1	-66.0	35.2
	-63.9	1.1	-65.0	35.2

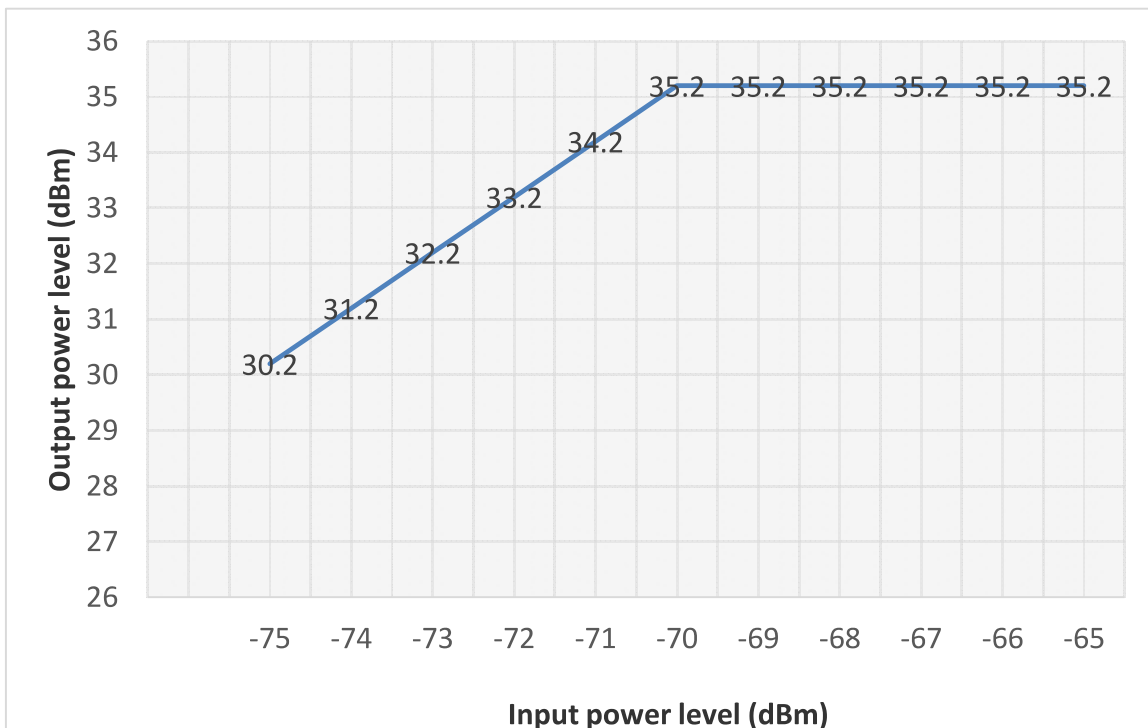

10.4. Out-of-band rejection

Test requirement: KDB 935210 D05 clause 4.3
FCC PART 90.219 (a)
FCC PART 90.219 (d)((7))

Test Method: KDB 935210 D05 clause 4.3

10.4.1. Requirements

According to KDB 935210 D05 clause 4.3 requirement, a signal booster shall reject amplification of other signals outside of its passband. Adjust the internal gain control of the EUT to the maximum gain for which equipment certification is sought.

10.4.2. Test configuration

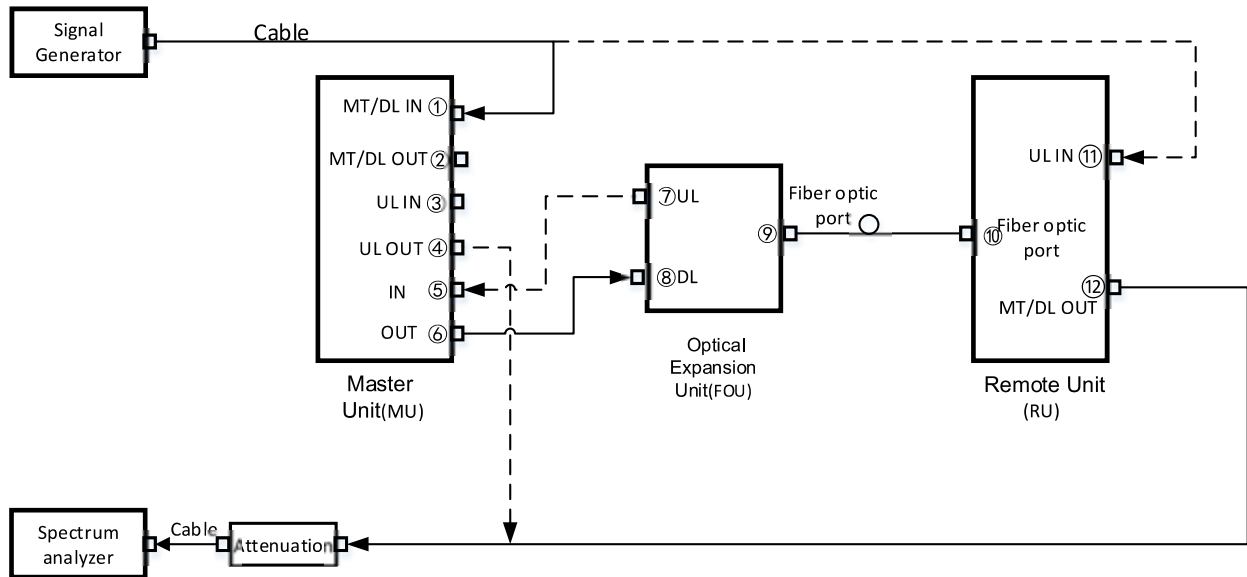

Figure 10.4-1 MU, FOU and RU system test connection diagram

----- The following blanks -----

10.4.3. Test procedures

- a) Connect a signal generator to the input of the EUT.
- b) Configure a swept CW signal with the following parameters:
 - 1) Frequency range = ± 250 % of the manufacturer's specified pass band.
 - 2) The CW amplitude shall be 3 dB below the AGC threshold (see 4.2), and shall not activate the AGC threshold throughout the test.
 - 3) Dwell time = approximately 10 ms.
 - 4) Frequency step = 50 kHz.
- c) Connect a spectrum analyzer to the output of the EUT using appropriate attenuation.
- d) Set the RBW of the spectrum analyzer to between 1 % and 5 % of the manufacturer's rated passband, and $VBW = 3 \times RBW$.
- e) Set the detector to Peak and the trace to Max-Hold.
- f) After the trace is completely filled, place a marker at the peak amplitude, which is designated as f_0 , and with two additional markers (use the marker-delta method) at the 20 dB bandwidth (i.e., at the points where the level has fallen by 20 dB).
- g) Capture the frequency response plot for inclusion in the test report.

————— The following blanks —————

10.4.4. Test results

Test Date (yy-mm-dd): 2021-11-26
 Normal condition: Temp: 27.7°C, Humid:39%, Atmospheric Pressure:101kpa
 Supply Voltage: DC -48V

10.4.4.1. System test

RBW (kHz)	VBW (kHz)	Peak frequency (MHz)	Peak power (dBm)	20dB BW (MHz)
(1) Downlink				
1000	3000	467.2	30.46	64.4

———— The following blanks ————

10.4.5. Test screenshot

10.4.5.1. System test



Downlink:

10.5. Input VS output Comparison

Test requirement: KDB 935210 D05 clause 4.4
FCC PART 2.1049(c)
FCC PART 90.219 (e)(4)(ii)
FCC PART 90.219 (e)(4)(iii)

Test Method: KDB 935210 D05 clause 4.4

10.5.1. Requirements

10.5.1.1. Emission mask

According to KDB 935210 D05 clause 4.4 requirement:

4.4 Input-versus-output signal comparison

Compliance with the emission mask of the EUT output shall be measured for the public safety service signal types as specified in 4.1.

According to the characteristics of the product and FCC PART 90.210 requirement, clause (b), clause (c), clause (d) and clause (e) in FCC PART 90.210 are used, except as indicated elsewhere in this part, transmitters used in the radio services governed by this part must comply with the emission masks outlined in this section. Measurements of emission power can be expressed in either peak or average values provided that emission powers are expressed with the same parameters used to specify the unmodulated transmitter carrier power. For transmitters that do not produce a full power unmodulated carrier, reference to the unmodulated transmitter carrier power refers to the total power contained in the channel bandwidth. Unless indicated elsewhere in this part, the table in this section specifies the emission masks for device operating under this part.

§90.210 Emission masks.

Except as indicated elsewhere in this part, transmitters used in the radio services governed by this part must comply with the emission masks outlined in this section. Unless otherwise stated, per paragraphs (d)(4), (e)(4), and (o) of this section, measurements of emission power can be expressed in either peak or average values provided that emission powers are expressed with the same parameters used to specify the unmodulated transmitter carrier power. For transmitters that do not produce a full power unmodulated carrier, reference to the unmodulated transmitter carrier power refers to the total power contained in the channel bandwidth. Unless indicated elsewhere in this part, the table in this section specifies the emission masks for equipment operating under this part.

APPLICABLE EMISSION MASKS

Frequency band (MHz)	Mask for equipment with audio low pass filter	Mask for equipment without audio low pass filter
Below 25 ¹	A or B	A or C
25-50	B	C
72-76	B	C
150-174 ²	B, D, or E	C, D or E
150 paging only	B	C
220-222	F	F
421-512 ^{2 5}	B, D, or E	C, D, or E
450 paging only	B	G
806-809/851-854 ⁶	B	H
809-824/854-869 ³⁵	B, D	D, G.
896-901/935-940	I	J
902-928	K	K
929-930	B	G
4940-4990 MHz	L or M	L or M
5850-5925 ⁴		
All other bands	B	C

NOTE: Emission Mask B and Mask C –25 kHz channel;
 Emission Mask D—12.5 kHz channel;
 Emission Mask E—6.25kHz;

10.5.1.1.1. Emission Mask B

(b) *Emission Mask B.* For transmitters that are equipped with an audio low-pass filter, the power of any emission must be attenuated below the unmodulated carrier power (P) as follows:

- (1) On any frequency removed from the assigned frequency by more than 50 percent, but not more than 100 percent of the authorized bandwidth: At least 25 dB.
- (2) On any frequency removed from the assigned frequency by more than 100 percent, but not more than 250 percent of the authorized bandwidth: At least 35 dB.
- (3) On any frequency removed from the assigned frequency by more than 250 percent of the authorized bandwidth: At least 43 + 10 log (P) dB.

(c) *Emission Mask C.* For transmitters that are not equipped with an audio low-pass filter, the power of any emission must be attenuated below the unmodulated carrier output power (P) as follows:

10.5.1.1.2. Emission Mask C

(c) *Emission Mask C.* For transmitters that are not equipped with an audio low-pass filter, the power of any emission must be attenuated below the unmodulated carrier output power (P) as follows:

(1) On any frequency removed from the center of the authorized bandwidth by a displacement frequency (f_d in kHz) of more than 5 kHz, but not more than 10 kHz: At least $83 \log (f_d/5)$ dB;

(2) On any frequency removed from the center of the authorized bandwidth by a displacement frequency (f_d in kHz) of more than 10 kHz, but not more than 250 percent of the authorized bandwidth: At least $29 \log (f_d^2/11)$ dB or 50 dB, whichever is the lesser attenuation;

(3) On any frequency removed from the center of the authorized bandwidth by more than 250 percent of the authorized bandwidth: At least $43 + 10 \log (P)$ dB.

10.5.1.1.3. Emission Mask D

(d) *Emission Mask D—12.5 kHz channel bandwidth equipment.* For transmitters designed to operate with a 12.5 kHz channel bandwidth, any emission must be attenuated below the power (P) of the highest emission contained within the authorized bandwidth as follows:

(1) On any frequency from the center of the authorized bandwidth f_0 to 5.625 kHz removed from f_0 : Zero dB.

(2) On any frequency removed from the center of the authorized bandwidth by a displacement frequency (f_d in kHz) of more than 5.625 kHz but no more than 12.5 kHz: At least $7.27(f_d - 2.88 \text{ kHz})$ dB.

(3) On any frequency removed from the center of the authorized bandwidth by a displacement frequency (f_d in kHz) of more than 12.5 kHz: At least $50 + 10 \log (P)$ dB or 70 dB, whichever is the lesser attenuation.

(4) The reference level for showing compliance with the emission mask shall be established using a resolution bandwidth sufficiently wide (usually two or three times the channel bandwidth) to capture the true peak emission of the equipment under test. In order to show compliance with the emission mask up to and including 50 kHz removed from the edge of the authorized bandwidth, adjust the resolution bandwidth to 100 Hz with the measuring instrument in a peak hold mode. A sufficient number of sweeps must be measured to insure that the emission profile is developed. If video filtering is used, its bandwidth must not be less than the instrument resolution bandwidth. For emissions beyond 50 kHz from the edge of the authorized bandwidth, see paragraph (o) of this section. If it can be shown that use of the above instrumentation settings do not accurately represent the true interference potential of the equipment under test, an alternate procedure may be used provided prior Commission approval is obtained.

10.5.1.1.4. Emission Mask E

(e) *Emission Mask E—6.25 kHz or less channel bandwidth equipment.* For transmitters designed to operate with a 6.25 kHz or less bandwidth, any emission must be attenuated below the power (P) of the highest emission contained within the authorized bandwidth as follows:

(1) On any frequency from the center of the authorized bandwidth f_0 to 3.0 kHz removed from f_0 : Zero dB.

(2) On any frequency removed from the center of the authorized bandwidth by a displacement frequency (f_d in kHz) of more than 3.0 kHz but no more than 4.6 kHz: At least $30 + 16.67(f_d - 3 \text{ kHz})$ or $55 + 10 \log(P)$ or 65 dB, whichever is the lesser attenuation.

(3) On any frequency removed from the center of the authorized bandwidth by more than 4.6 kHz: At least $55 + 10 \log(P)$ or 65 dB, whichever is the lesser attenuation.

(4) The reference level for showing compliance with the emission mask shall be established using a resolution bandwidth sufficiently wide (usually two or three times the channel bandwidth) to capture the true peak emission of the equipment under test. In order to show compliance with the emission mask up to and including 50 kHz removed from the edge of the authorized bandwidth, adjust the resolution bandwidth to 100 Hz with the measuring instrument in a peak hold mode. A sufficient number of sweeps must be measured to insure that the emission profile is developed. If video filtering is used, its bandwidth must not be less than the instrument resolution bandwidth. For emissions beyond 50 kHz from the edge of the authorized bandwidth, see paragraph (o) of this section. If it can be shown that use of the above instrumentation settings do not accurately represent the true interference potential of the equipment under test, an alternate procedure may be used provided prior Commission approval is obtained.

10.5.1.2. Occupied bandwidth

10.5.1.2.1. FCC PART 2.1049(c)

§2.1049 Measurements required: Occupied bandwidth.

The occupied bandwidth, that is the frequency bandwidth such that, below its lower and above its upper frequency limits, the mean powers radiated are each equal to 0.5 percent of the total mean power radiated by a given emission shall be measured under the following conditions as applicable:

(a) Radiotelegraph transmitters for manual operation when keyed at 16 dots per second.

(b) Other keyed transmitters—when keyed at the maximum machine speed.

(c) Radiotelephone transmitters equipped with a device to limit modulation or peak envelope power shall be modulated as follows. For single sideband and independent sideband transmitters, the input level of the modulating signal shall be 10 dB greater than that necessary to produce rated peak envelope power.

(1) Other than single sideband or independent sideband transmitters—when modulated by a 2500 Hz tone at an input level 16 dB greater than that necessary to produce 50 percent modulation. The input level shall be established at the frequency of maximum response of the audio modulating circuit.

(2) Single sideband transmitters in A3A or A3J emission modes—when modulated by two tones at frequencies of 400 Hz and 1800 Hz (for 3.0 kHz authorized bandwidth), or 500 Hz and 2100 Hz (for 3.5 kHz authorized bandwidth), or 500 Hz and 2400 Hz (for 4.0 kHz authorized bandwidth), applied simultaneously. The input levels of the tones shall be so adjusted that the two principal frequency components of the radio frequency signal produced are equal in magnitude.

10.5.1.2.2. FCC PART 90.219 (e)(4)(ii)

(4) A signal booster must be designed such that all signals that it retransmits meet the following requirements:

(i) The signals are retransmitted on the same channels as received. Minor departures from the exact provider or reference frequencies of the input signals are allowed, *provided that* the retransmitted signals meet the requirements of §90.213.

<https://www.ecfr.gov/cgi-bin/text-idx?SID=2097cbcdce8abb94d012e95530a44e05&mc=true&node=pt47.5.90&rgn=div5>

020/6/15

Electronic Code of Federal Regulations (eCFR)

(ii) There is no change in the occupied bandwidth of the retransmitted signals.

(iii) The retransmitted signals continue to meet the unwanted emissions limits of §90.210 applicable to the corresponding received signals (assuming that these received signals meet the applicable unwanted emissions limits by a reasonable margin).

According to FCC PART 2.1049(c), FCC PART 90.219 (e)(4)(ii) and (iii) requirement, the occupied bandwidth, that is the frequency bandwidth such that below its lower and above its upper frequency limits, the mean powers radiated are each equal to 0.5 percent of the total mean power radiated by a given emission shall be measured.

———— The following blanks ————

10.5.2. Test configuration

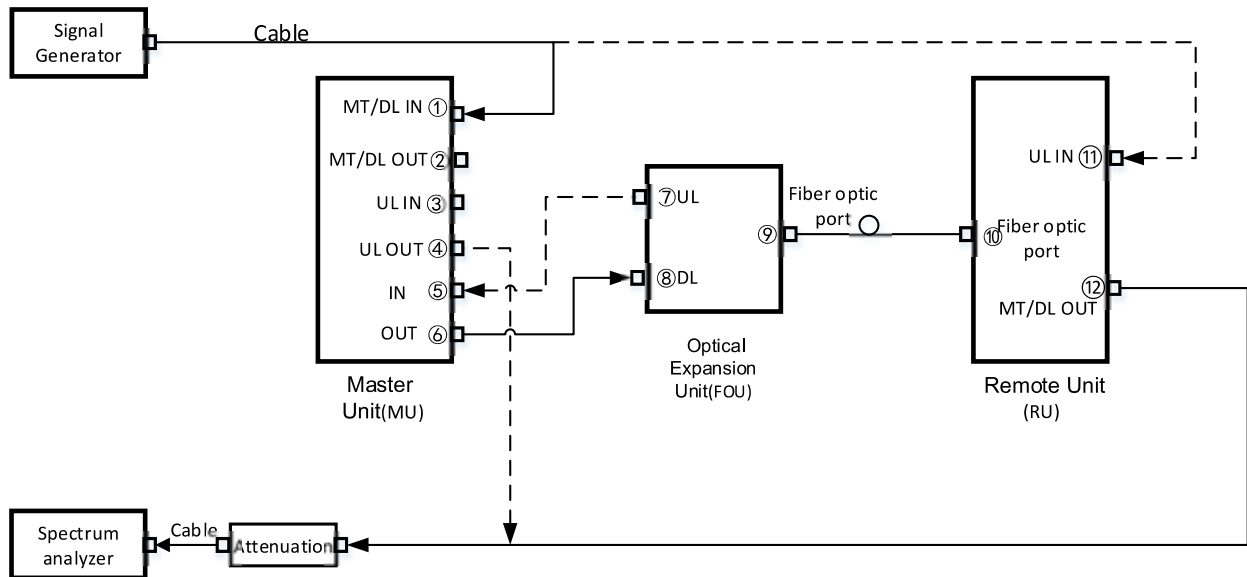

Figure 10.5-1 MU, FOU and RU system test connection diagram

10.5.3. Test procedures

- a) Connect a signal generator to the input of the EUT.
- b) Configure the signal generator to transmit the appropriate test signal associated with the public safety emission designation (see Table 1).
- c) Configure the signal level to be just below the AGC threshold (see results from 4.2).
- d) Connect a spectrum analyzer to the output of the EUT using appropriate attenuation as necessary.
- e) Set the spectrum analyzer center frequency to the nominal EUT channel center frequency. The span range for the spectrum analyzer shall be between $2 \times$ to $5 \times$ the EBW (or OBW).
- f) The nominal RBW shall be 300 Hz for 16K0F3E, and 100 Hz for all other emissions types.
- g) Set the reference level of the spectrum analyzer to accommodate the maximum input amplitude level, i.e., the level at f_0 per 4.3.
- h) Set spectrum analyzer detection mode to peak, and trace mode to max hold.
- i) Allow the trace to fully stabilize.
- j) Confirm that the signal is contained within the appropriate emissions mask.
- k) Use the marker function to determine the maximum emission level and record the associated frequency.
- l) Capture the emissions mask plot for inclusion in the test report (output signal spectra).
- m) Measure the EUT input signal power (signal generator output signal) directly from the signal generator using power measurement guidance provided in KDB Publication 971168 [R8] (input signal spectra).
- n) Compare the spectral plot of the output signal (determined in step k), to the input signal (determined in step l) to affirm they are similar (in passband and rolloff characteristic features and relative spectral locations).
- o) Repeat steps d) to n) with the input signal amplitude set 3 dB above the AGC threshold.
- p) Repeat steps b) to o) for all authorized operational bands and emissions types (see applicable regulatory specifications, e.g., Section 90.210).
- q) Include all accumulated spectral plots depicting EUT input signal and EUT output signal in the test report, and note any observed dissimilarities.

———— The following blanks ————

10.5.4. Test results

Test Date (yy-mm-dd): 2021-11-22 to 2021-12-07

Normal condition: Temp: 24.5~27.7°C, Humid:36~45%, Atmospheric Pressure:101kpa

Supply Voltage: DC -48V

10.5.4.1.Emission mask

10.5.4.1.1. System test

10.5.4.1.1.1. P25 Phase I(C4FM) mode

Carrier frequency	Input signal status	Limit	Test Data	Result
(1) Downlink transmit mode				
Low frequency: 450.00625 MHz	with the input signal amplitude set the AGC threshold	Mask D	See clause 10.5.5.1.1.1.1	PASS
	with the input signal amplitude set 3 dB above the AGC threshold	Mask D	See clause 10.5.5.1.1.1.1	PASS
Mid frequency: 479.0 MHz	with the input signal amplitude set the AGC threshold	Mask D	See clause 10.5.5.1.1.1.1	PASS
	with the input signal amplitude set 3 dB above the AGC threshold	Mask D	See clause 10.5.5.1.1.1.1	PASS
High frequency: 508.99375MHz	with the input signal amplitude set the AGC threshold	Mask D	See clause 10.5.5.1.1.1.1	PASS
	with the input signal amplitude set 3 dB above the AGC threshold	Mask D	See clause 10.5.5.1.1.1.1	PASS

10.5.4.1.1.2. P25 Phase II(H-DQPSK) mode

Carrier frequency	Input signal status	Limit	Test Data	Result
(2) Downlink transmit mode				
Low frequency: 450.00625 MHz	with the input signal amplitude set the AGC threshold	Mask D	See clause 10.5.5.1.1.1.2	PASS
	with the input signal amplitude set 3 dB above the AGC threshold	Mask D	See clause 10.5.5.1.1.1.2	PASS
Mid frequency: 479.0 MHz	with the input signal amplitude set the AGC threshold	Mask D	See clause 10.5.5.1.1.1.2	PASS
	with the input signal amplitude set 3 dB above the AGC threshold	Mask D	See clause 10.5.5.1.1.1.2	PASS
High frequency: 508.99375MHz	with the input signal amplitude set the AGC threshold	Mask D	See clause 10.5.5.1.1.1.2	PASS
	with the input signal amplitude set 3 dB above the AGC threshold	Mask D	See clause 10.5.5.1.1.1.2	PASS

10.5.4.1.1.3. 6.25kHz Analog FM mode

Carrier frequency	Input signal status	Limit	Test Data	Result
(3) Downlink transmit mode				
Low frequency: 450.00313 MHz	with the input signal amplitude set the AGC threshold	Mask E	See clause 10.5.5.1.1.1.3	PASS
	with the input signal amplitude set 3 dB above the AGC threshold	Mask E	See clause 10.5.5.1.1.1.3	PASS

Mid frequency: 479.0 MHz	with the input signal amplitude set the AGC threshold	Mask E	See clause 10.5.5.1.1.1.3	PASS
	with the input signal amplitude set 3 dB above the AGC threshold	Mask E	See clause 10.5.5.1.1.1.3	PASS
High frequency: 508.99688MHz	with the input signal amplitude set the AGC threshold	Mask E	See clause 10.5.5.1.1.1.3	PASS
	with the input signal amplitude set 3 dB above the AGC threshold	Mask E	See clause 10.5.5.1.1.1.3	PASS

10.5.4.1.1.4. 12.5kHz Analog FM mode

Carrier frequency	Input signal status	Limit	Test Data	Result
(4) Downlink transmit mode				
Low frequency: 450.00625 MHz	with the input signal amplitude set the AGC threshold	Mask D	See clause 10.5.5.1.1.1.4	PASS
	with the input signal amplitude set 3 dB above the AGC threshold	Mask D	See clause 10.5.5.1.1.1.4	PASS
Mid frequency: 479.0 MHz	with the input signal amplitude set the AGC threshold	Mask D	See clause 10.5.5.1.1.1.4	PASS
	with the input signal amplitude set 3 dB above the AGC threshold	Mask D	See clause 10.5.5.1.1.1.4	PASS
High frequency: 508.99375MHz	with the input signal amplitude set the AGC threshold	Mask D	See clause 10.5.5.1.1.1.4	PASS
	with the input signal amplitude set 3 dB above the AGC threshold	Mask D	See clause 10.5.5.1.1.1.4	PASS

10.5.4.1.1.5. 25kHz Analog FM mode

Carrier frequency	Input signal status	Limit	Test Data	Result
(5) Downlink transmit mode				
Low frequency: 450.0125 MHz	with the input signal amplitude set the AGC threshold	Mask B+ Mask C	See clause 10.5.5.1.1.1.5	PASS
	with the input signal amplitude set 3 dB above the AGC threshold	Mask B+ Mask C	See clause 10.5.5.1.1.1.5	PASS
Mid frequency: 479.0 MHz	with the input signal amplitude set the AGC threshold	Mask B+ Mask C	See clause 10.5.5.1.1.1.5	PASS
	with the input signal amplitude set 3 dB above the AGC threshold	Mask B+ Mask C	See clause 10.5.5.1.1.1.5	PASS
High frequency: 508.9875MHz	with the input signal amplitude set the AGC threshold	Mask B+ Mask C	See clause 10.5.5.1.1.1.5	PASS
	with the input signal amplitude set 3 dB above the AGC threshold	Mask B+ Mask C	See clause 10.5.5.1.1.1.5	PASS

10.5.4.2. Occupied bandwidth

10.5.4.2.1. System test

10.5.4.2.1.1. P25 Phase I(C4FM) mode

Carrier frequency	Input signal status	Test Data
(6) Downlink transmit mode		
Low frequency: 450.00625 MHz	with the input signal amplitude set the AGC threshold	See clause 10.5.5.2.1.1.1
	with the input signal amplitude set 3 dB above the AGC threshold	See clause 10.5.5.2.1.1.1
Mid frequency: 479.0 MHz	with the input signal amplitude set the AGC threshold	See clause 10.5.5.2.1.1.1
	with the input signal amplitude set 3 dB above the AGC threshold	See clause 10.5.5.2.1.1.1
High frequency: 508.99375MHz	with the input signal amplitude set the AGC threshold	See clause 10.5.5.2.1.1.1
	with the input signal amplitude set 3 dB above the AGC threshold	See clause 10.5.5.2.1.1.1

10.5.4.2.1.2. P25 Phase II(H-DQPSK) mode

Carrier frequency	Input signal status	Test Data
(7) Downlink transmit mode		
Low frequency: 450.00625 MHz	with the input signal amplitude set the AGC threshold	See clause 10.5.5.2.1.1.2
	with the input signal amplitude set 3 dB above the AGC threshold	See clause 10.5.5.2.1.1.2
Mid frequency: 479.0 MHz	with the input signal amplitude set the AGC threshold	See clause 10.5.5.2.1.1.2
	with the input signal amplitude set 3 dB above the AGC threshold	See clause 10.5.5.2.1.1.2
High frequency: 508.99375MHz	with the input signal amplitude set the AGC threshold	See clause 10.5.5.2.1.1.2
	with the input signal amplitude set 3 dB above the AGC threshold	See clause 10.5.5.2.1.1.2

10.5.4.2.1.3. 6.25kHz Analog FM mode

Carrier frequency	Input signal status	Test Data
(8) Downlink transmit mode		
Low frequency: 450.00313 MHz	with the input signal amplitude set the AGC threshold	See clause 10.5.5.2.1.1.3
	with the input signal amplitude set 3 dB above the AGC threshold	See clause 10.5.5.2.1.1.3
Mid frequency: 479.0 MHz	with the input signal amplitude set the AGC threshold	See clause 10.5.5.2.1.1.3
	with the input signal amplitude set 3 dB above the AGC threshold	See clause 10.5.5.2.1.1.3
High frequency: 508.99688MHz	with the input signal amplitude set the AGC threshold	See clause 10.5.5.2.1.1.3
	with the input signal amplitude set 3 dB above the AGC threshold	See clause 10.5.5.2.1.1.3

10.5.4.2.1.4. 12.5kHz Analog FM mode

Carrier frequency	Input signal status	Test Data
(9) Downlink transmit mode		
Low frequency: 450.00625 MHz	with the input signal amplitude set the AGC threshold	See clause 10.5.5.2.1.1.4
	with the input signal amplitude set 3 dB above the AGC threshold	See clause 10.5.5.2.1.1.4
Mid frequency: 479.0 MHz	with the input signal amplitude set the AGC threshold	See clause 10.5.5.2.1.1.4
	with the input signal amplitude set 3 dB above the AGC threshold	See clause 10.5.5.2.1.1.4
High frequency: 508.99375MHz	with the input signal amplitude set the AGC threshold	See clause 10.5.5.2.1.1.4
	with the input signal amplitude set 3 dB above the AGC threshold	See clause 10.5.5.2.1.1.4

10.5.4.2.1.5. 25kHz Analog FM mode

Carrier frequency	Input signal status	Test Data
(10) Downlink transmit mode		
Low frequency: 450.0125 MHz	with the input signal amplitude set the AGC threshold	See clause 10.5.5.2.1.1.5
	with the input signal amplitude set 3 dB above the AGC threshold	See clause 10.5.5.2.1.1.5
Mid frequency: 479.0 MHz	with the input signal amplitude set the AGC threshold	See clause 10.5.5.2.1.1.5
	with the input signal amplitude set 3 dB above the AGC threshold	See clause 10.5.5.2.1.1.5
High frequency: 508.9875MHz	with the input signal amplitude set the AGC threshold	See clause 10.5.5.2.1.1.5
	with the input signal amplitude set 3 dB above the AGC threshold	See clause 10.5.5.2.1.1.5

———— The following blanks ————

10.5.4.3.Input VS output Comparison

10.5.4.3.1. System test

10.5.4.3.1.1. P25 Phase I(C4FM) mode

Carrier frequency	Input VS output Comparison status	Test data
(1) Downlink transmit mode		
Low frequency: 450.00625 MHz	Input signal	See clause 10.5.5.3.1.1.1
	with the input signal amplitude set the AGC threshold	See clause 10.5.5.3.1.1.1
	with the input signal amplitude set 3 dB above the AGC threshold	See clause 10.5.5.3.1.1.1
Mid frequency: 479.0 MHz	Input signal	See clause 10.5.5.3.1.1.1
	with the input signal amplitude set the AGC threshold	See clause 10.5.5.3.1.1.1
	with the input signal amplitude set 3 dB above the AGC threshold	See clause 10.5.5.3.1.1.1
High frequency: 508.99375MHz	Input signal	See clause 10.5.5.3.1.1.1
	with the input signal amplitude set the AGC threshold	See clause 10.5.5.3.1.1.1
	with the input signal amplitude set 3 dB above the AGC threshold	See clause 10.5.5.3.1.1.1

10.5.4.3.1.2. P25 Phase II(H-DQPSK) mode

Carrier frequency	Input VS output Comparison status	Test data
(2) Downlink transmit mode		
Low frequency: 450.00625 MHz	Input signal	See clause 10.5.5.3.1.1.2
	with the input signal amplitude set the AGC threshold	See clause 10.5.5.3.1.1.2
	with the input signal amplitude set 3 dB above the AGC threshold	See clause 10.5.5.3.1.1.2
Mid frequency: 479.0 MHz	Input signal	See clause 10.5.5.3.1.1.2
	with the input signal amplitude set the AGC threshold	See clause 10.5.5.3.1.1.2
	with the input signal amplitude set 3 dB above the AGC threshold	See clause 10.5.5.3.1.1.2
High frequency: 508.99375MHz	Input signal	See clause 10.5.5.3.1.1.2
	with the input signal amplitude set the AGC threshold	See clause 10.5.5.3.1.1.2
	with the input signal amplitude set 3 dB above the AGC threshold	See clause 10.5.5.3.1.1.2

10.5.4.3.1.3. 6.25kHz Analog FM mode

Carrier frequency	Input VS output Comparison status	Test data
(3) Downlink transmit mode		
Low frequency: 450.00625 MHz	Input signal	See clause 10.5.5.3.1.1.3
	with the input signal amplitude set the AGC threshold	See clause 10.5.5.3.1.1.3
	with the input signal amplitude set 3 dB above the AGC threshold	See clause 10.5.5.3.1.1.3

Mid frequency: 479.0 MHz	Input signal	See clause 10.5.5.3.1.1.3
	with the input signal amplitude set the AGC threshold	See clause 10.5.5.3.1.1.3
	with the input signal amplitude set 3 dB above the AGC threshold	See clause 10.5.5.3.1.1.3
High frequency: 508.99375MHz	Input signal	See clause 10.5.5.3.1.1.3
	with the input signal amplitude set the AGC threshold	See clause 10.5.5.3.1.1.3
	with the input signal amplitude set 3 dB above the AGC threshold	See clause 10.5.5.3.1.1.3

10.5.4.3.1.4. 12.5kHz Analog FM mode

Carrier frequency	Input VS output Comparison status	Test data
(4) Downlink transmit mode		
Low frequency: 450.00625 MHz	Input signal	See clause 10.5.5.3.1.1.4
	with the input signal amplitude set the AGC threshold	See clause 10.5.5.3.1.1.4
	with the input signal amplitude set 3 dB above the AGC threshold	See clause 10.5.5.3.1.1.4
Mid frequency: 479.0 MHz	Input signal	See clause 10.5.5.3.1.1.4
	with the input signal amplitude set the AGC threshold	See clause 10.5.5.3.1.1.4
	with the input signal amplitude set 3 dB above the AGC threshold	See clause 10.5.5.3.1.1.4
High frequency: 508.99375MHz	Input signal	See clause 10.5.5.3.1.1.4
	with the input signal amplitude set the AGC threshold	See clause 10.5.5.3.1.1.4
	with the input signal amplitude set 3 dB above the AGC threshold	See clause 10.5.5.3.1.1.4

10.5.4.3.1.5. 25kHz Analog FM mode

Carrier frequency	Input VS output Comparison status	Test data
(5) Downlink transmit mode		
Low frequency: 450.00625 MHz	Input signal	See clause 10.5.5.3.1.1.5
	with the input signal amplitude set the AGC threshold	See clause 10.5.5.3.1.1.5
	with the input signal amplitude set 3 dB above the AGC threshold	See clause 10.5.5.3.1.1.5
Mid frequency: 479.0 MHz	Input signal	See clause 10.5.5.3.1.1.5
	with the input signal amplitude set the AGC threshold	See clause 10.5.5.3.1.1.5
	with the input signal amplitude set 3 dB above the AGC threshold	See clause 10.5.5.3.1.1.5
High frequency: 508.99375MHz	Input signal	See clause 10.5.5.3.1.1.5
	with the input signal amplitude set the AGC threshold	See clause 10.5.5.3.1.1.5
	with the input signal amplitude set 3 dB above the AGC threshold	See clause 10.5.5.3.1.1.5

———— The following blanks ————

- 10.5.5. Test screenshot
- 10.5.5.1. Emission mask
- 10.5.5.1.1. System test
- 10.5.5.1.1.1. Downlink
- 10.5.5.1.1.1.1. P25 Phase I(C4FM) mode

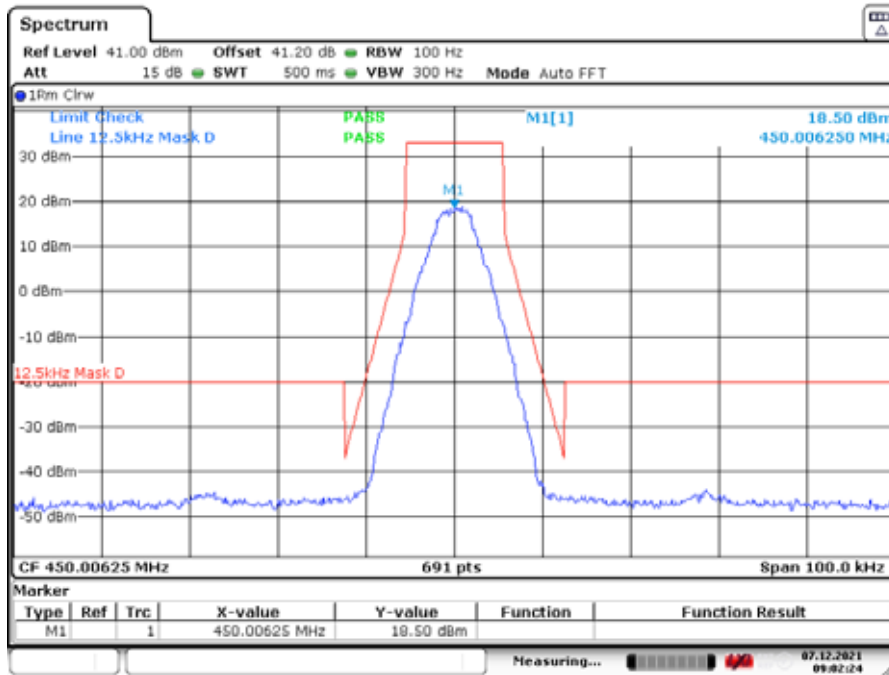

Date: 7.DEC.2021 09:02:24

With the input signal amplitude set the AGC threshold
 Low Frequency: 450.00625MHz

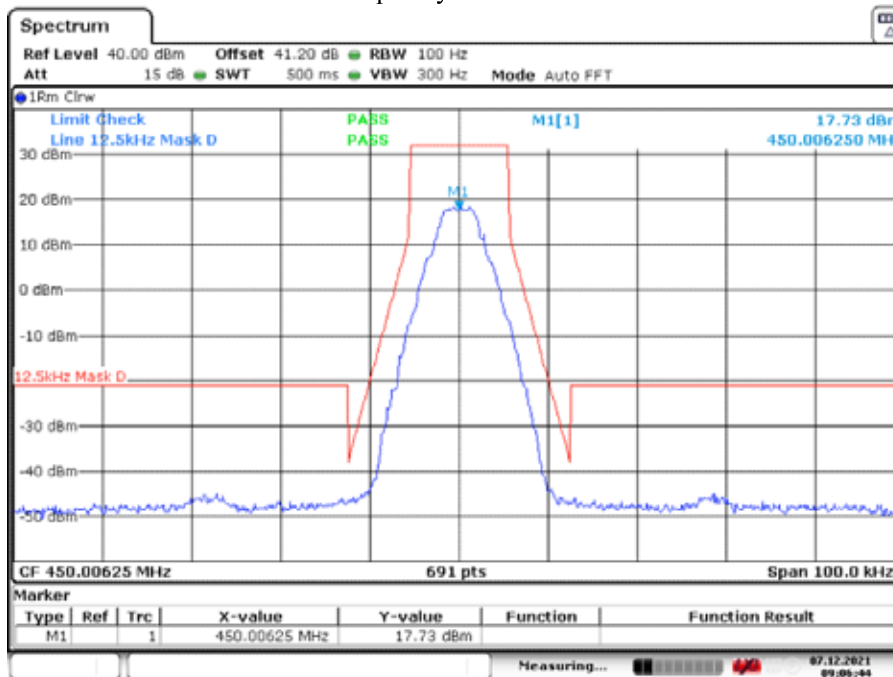

Date: 7.DEC.2021 09:06:45

With the input signal amplitude set 3 dB above the AGC threshold
 Low Frequency: 450.00625MHz

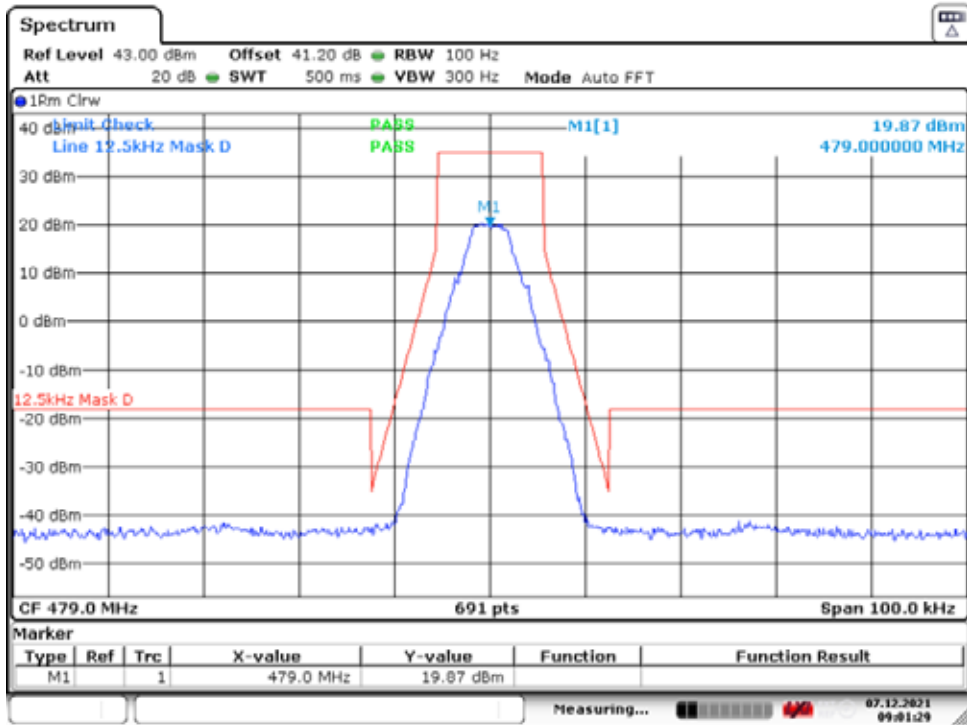

Date: 7.DEC.2021 09:01:29

With the input signal amplitude set the AGC threshold
 Middle Frequency: 479.0MHz

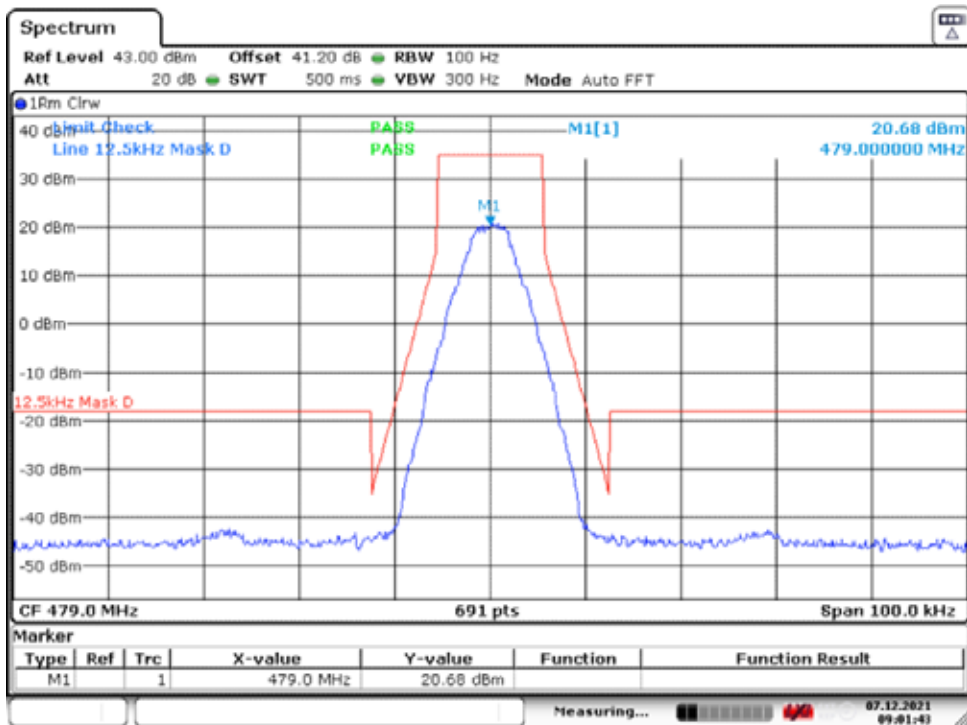

Date: 7.DEC.2021 09:01:44

With the input signal amplitude set 3 dB above the AGC threshold
 Middle Frequency: 479.0MHz

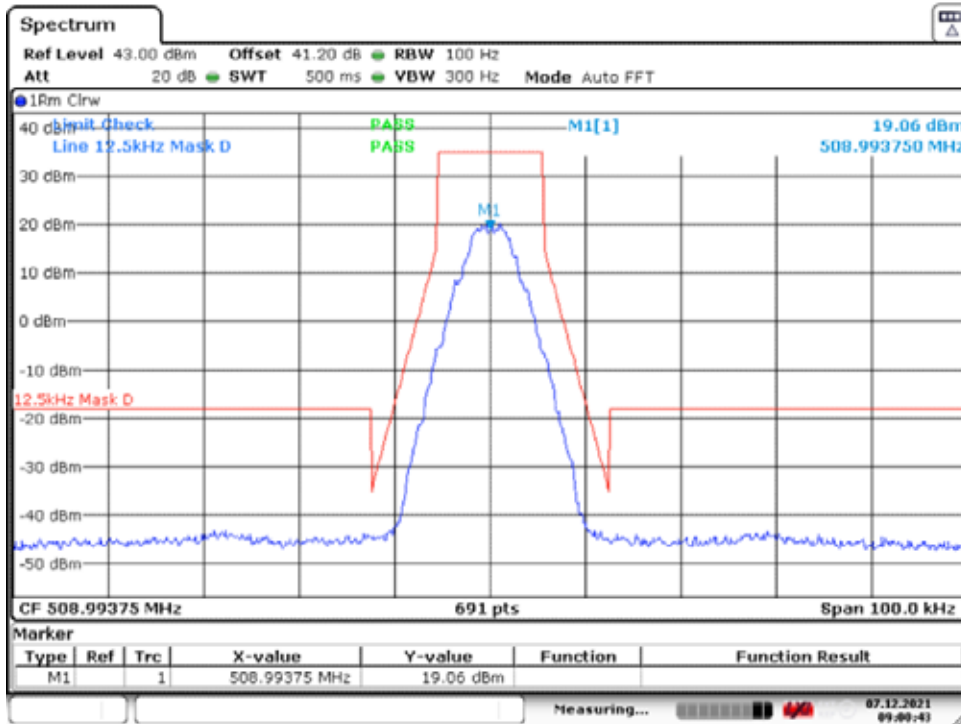

Date: 7. DEC. 2021 09:00:44

With the input signal amplitude set the AGC threshold
High Frequency: 508.99375MHz

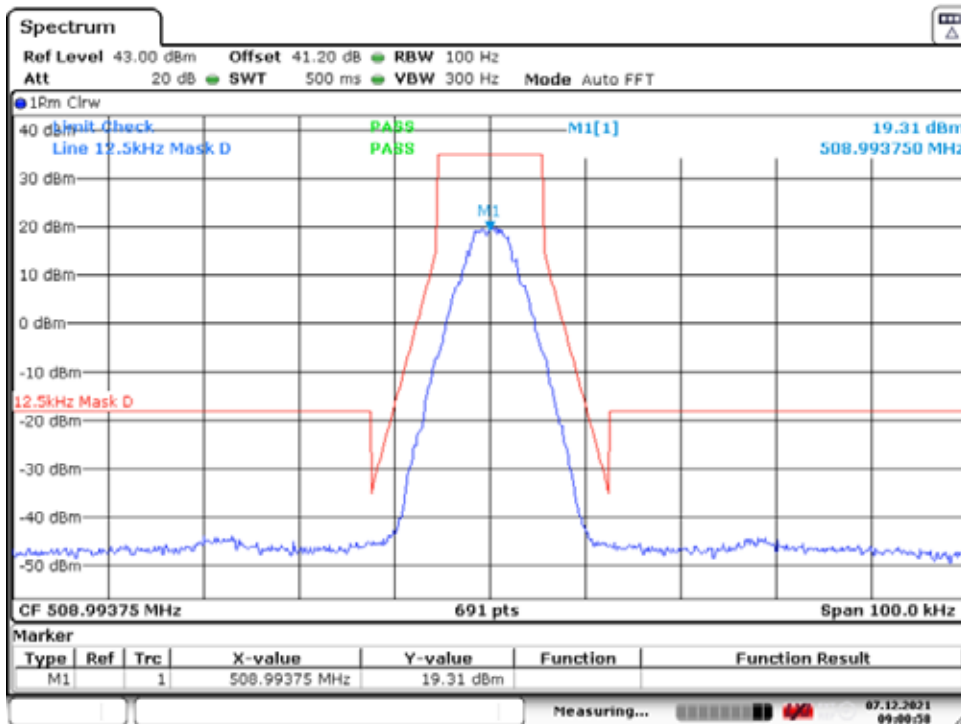

Date: 7. DEC. 2021 09:00:58

With the input signal amplitude set 3 dB above the AGC threshold
High Frequency: 508.99375MHz

10.5.5.1.1.1.2. P25 Phase II(H-DQPSK) mode

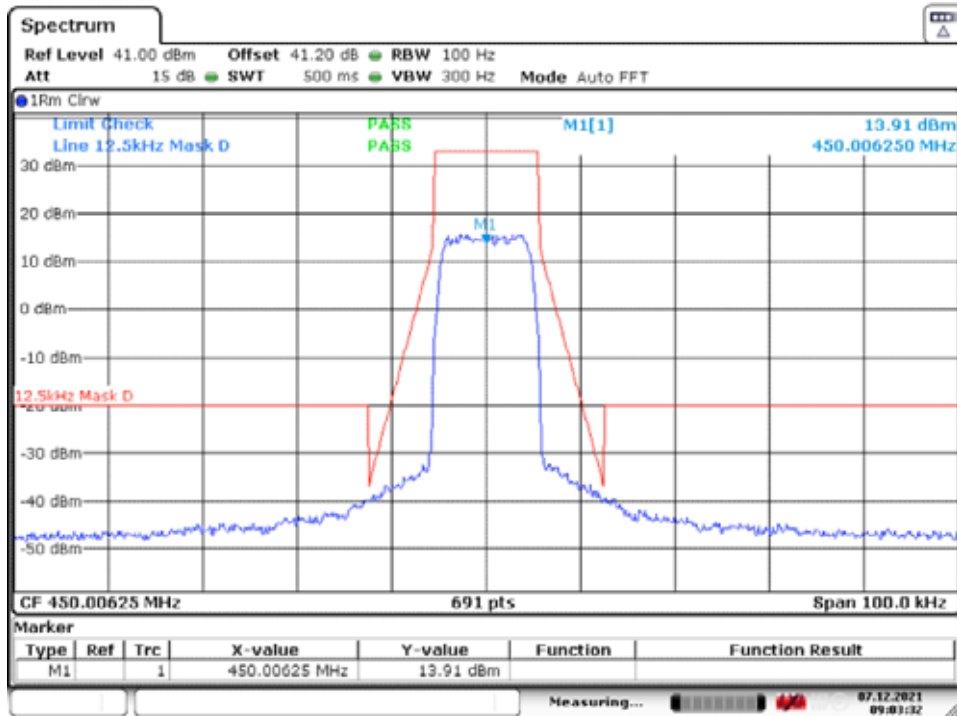

Date: 7.DEC.2021 09:03:32

With the input signal amplitude set the AGC threshold
 Low Frequency: 450.00625MHz

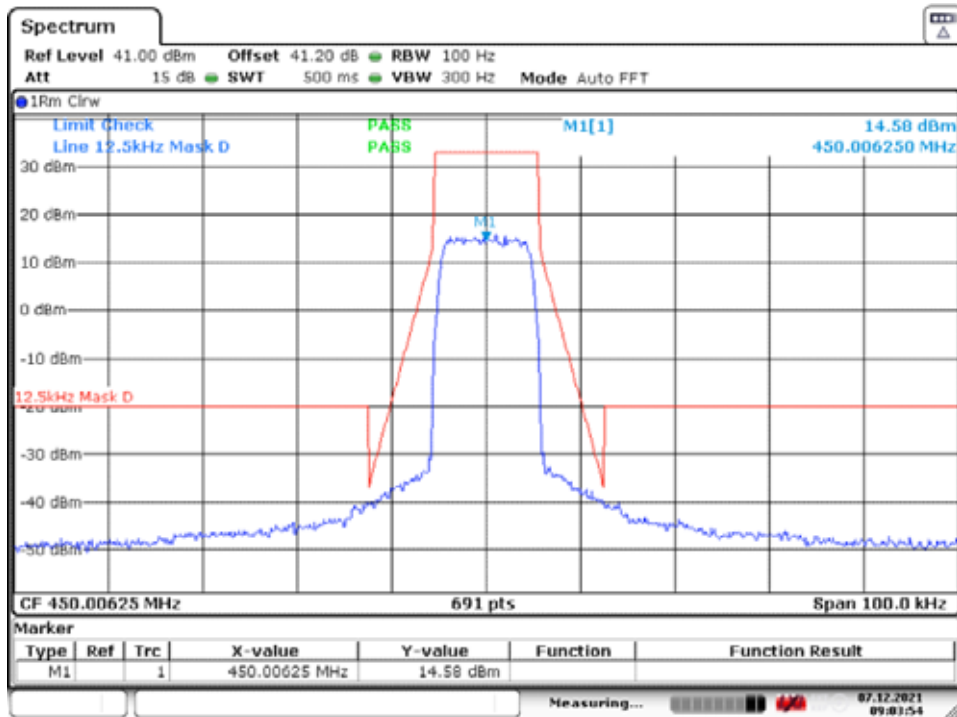

Date: 7.DEC.2021 09:03:55

With the input signal amplitude set 3 dB above the AGC threshold
 Low Frequency: 450.00625MHz

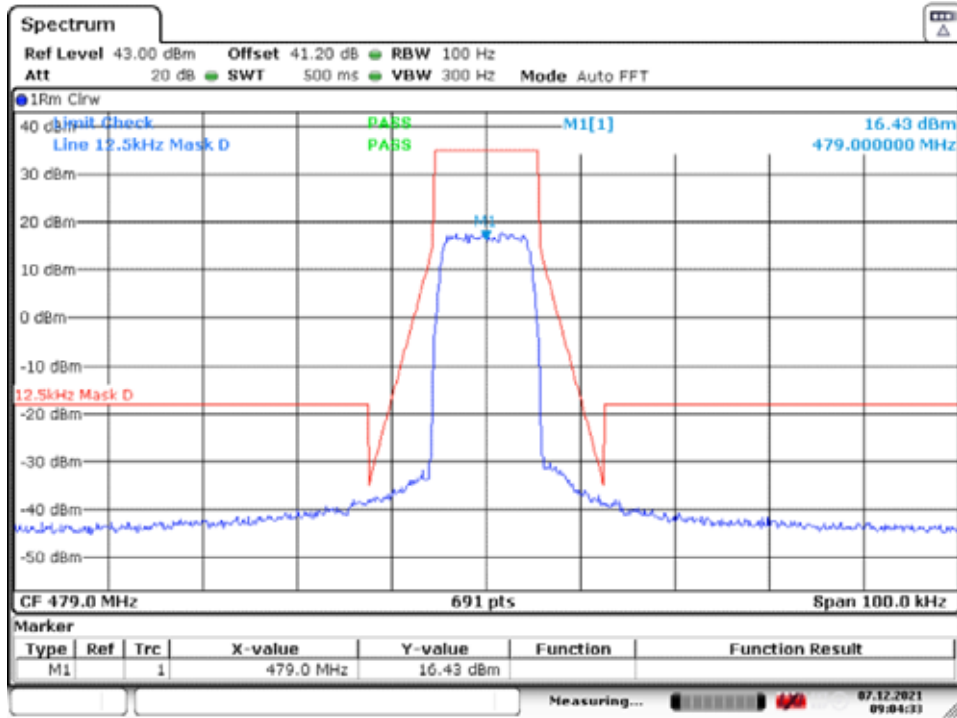

Date: 7.DEC.2021 09:04:33

With the input signal amplitude set the AGC threshold
Middle Frequency: 479.0MHz

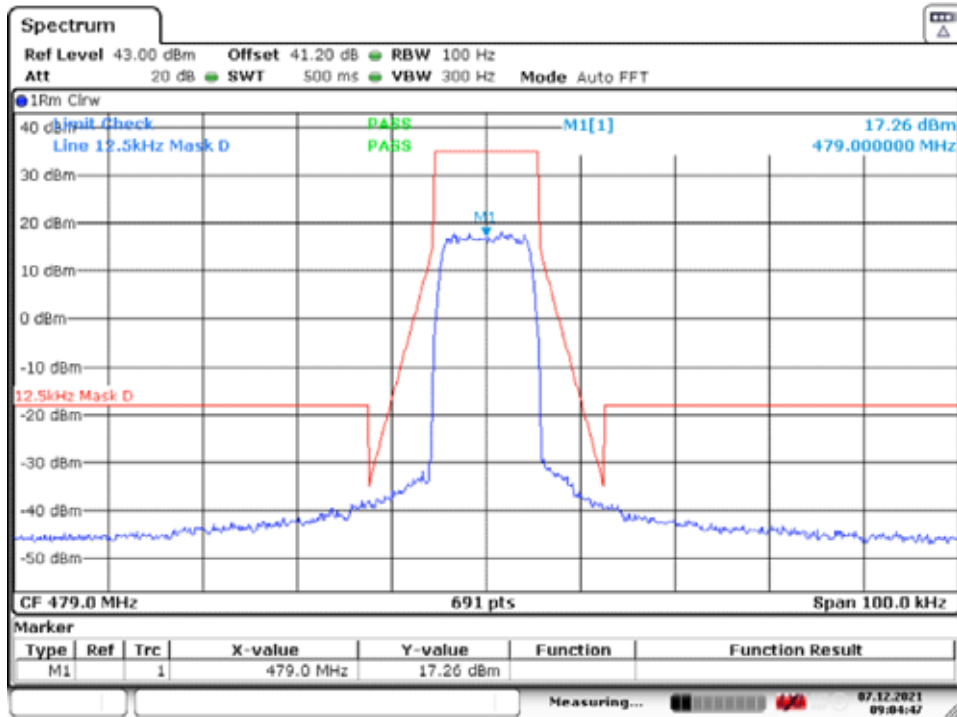

Date: 7.DEC.2021 09:04:47

With the input signal amplitude set 3 dB above the AGC threshold
Middle Frequency: 479.0MHz