

Comba

CriticalPoint Public Safety DAS

DISTRIBUTED ANTENNA SYSTEM

USER MANUAL

Public Safety DAS RH-7W22 Class A QE: 1-0-0

Comba Telecom Ltd.

The information contained herein is the responsibility of and is approved by the following, to whom all enquiries should be directed:

This is an unpublished work the copyright in which vests in Comba International ("Comba"). All rights reserved.

The information contained herein is confidential and the property of Comba and is supplied without liability for errors or omissions. No part may be reproduced, disclosed or used except as authorized by contract or other written permission. The copyright and the foregoing restriction on reproduction and use extend to all media in which the information may be embodied.

0.1 CONTENTS

Section	Page
0.1	CONTENTS.....3
0.2	INDEX TO FIGURES AND TABLES5
0.3	HISTORY.....7
0.4	GLOSSARY OF TERMS8
0.5	SAFETY NOTICES AND ADMONISHMENTS9
1	GENERAL INFORMATION 11
2	EQUIPMENT DESCRIPTION 13
2.1	SYSTEM DIAGRAM.....13
2.2	EQUIPMENT LAYOUT14
2.3	EQUIPMENT CONSTITUTION.....16
3	INSTALLATION.....17
3.1	WARNINGS AND ALERTS17
3.2	SITE PLANNING CONSIDERATIONS.....18
3.2.1	SITE PLANNING18
3.2.2	INSTALLATION CHECKLIST.....19
3.3	INSTALLATION PROCEDURES20
3.3.1	GOODS INWARDS INSPECTION.....20
3.3.2	TOOLS20
3.3.3	PREPARATION.....20
3.3.4	WALL MOUNTING.....21
3.3.5	DRIP-LOOP21
3.4	EQUIPMENT CONNECTORS22
3.4.1	PS DAS CONNECTORS.....22
3.4.2	PS DAS LED Indicators24
3.4.3	GROUNDING CONNECTION.....24
3.4.4	RF CABLE CONNECTION.....24
3.4.5	ETHERNET CONNECTION.....24
4	COMMISSIONING25
4.1	PRE-COMMISSIONING TASKS.....25
4.2	COMMISSIONING PROCEDURE.....26
5	WEB GUI28
5.1	WEB GUI CONNECTION.....28
5.2	WEB GUI INTRODUCTION29
5.2.1	[TOPOLOGY][PARAMETER INFORMATION]29
5.2.2	[TOPOLOGY][FUNCTION].....36
5.2.3	[TOPOLOGY][PROGRAM INFO].....41
5.2.4	[AUTO SETUP].....41
5.2.5	[SYSTEM]47
6	MAINTENANCE51
7	APPENDICES52
7.1	APPENDIX A: TOOLS52

7.2	APPENDIX B: DECLARATION OF HARMFUL SUBSTANCES AND CONTENT	53
7.3	APPENDIX C: LICENSE SWITCH QUICK GUIDE	54
7.4	APPENDIX D: RMA (RETURN MATERIAL AUTHORIZATION).....	56

0.2 INDEX TO FIGURES AND TABLES

Figure 1: Master Unit (MU)	11
Figure 2: Remote Unit (RU)	12
Figure 3: PS DAS Functional Block Diagram.....	13
Figure 4: Layout of the MU Bottom layer	14
Figure 5: Layout of the MU middle layer	14
Figure 6: Layout of the MU top layer	15
Figure 7: Layout of the RU Bottom layer	15
Figure 8: Layout of the RU top layer.....	16
Figure 9: Mounting Rack Overview	20
Figure 10: PS DAS Wall Mounting	21
Figure 11: MU Equipment Connectors	22
Figure 12: RU Equipment Connectors.....	23
Figure 13: Commissioning Procedure	26
Figure 14: Input IP Address	28
Figure 15: Input Domain Name	28
Figure 16: Input User Name and Password.....	28
Figure 17: Web GUI Main Screen	29
Figure 18: Overview Screen – MU	30
Figure 19: Overview Screen – MU	30
Figure 20: Overview Screen – RU.....	31
Figure 21: Device alarm - MU	31
Figure 22: Device alarm - RU.....	32
Figure 23: 800MHz Screen - MU.....	32
Figure 24: 800MHz Screen - RU.....	33
Figure 25: 700MHz Screen - MU.....	34
Figure 26: 700MHz Screen - RU.....	34
Figure 27: Optical Information – MU.....	35
Figure 28: Optical Information – RU	35
Figure 29: [Function] Screen.....	36
Figure 30: Function – Device Info	36
Figure 31: Function – Import & Export.....	37
Figure 32: Function – Summary.....	37
Figure 33: Function – Comm. Setting.....	38
Figure 34: Function –Reset.....	38
Figure 35: Function – Firmware Upgrade	39
Figure 36: Function – Log	39
Figure 37: Function – Alarm Setting.....	40
Figure 38: Function – License.....	40
Figure 39: Program Information	41
Figure 40: Commissioning Procedure – Start.....	42
Figure 41: Commissioning Procedure – Scan	43
Figure 42: Commissioning Procedure – Isolation Detection.....	44
Figure 43: Device Information Setting	45
Figure 44: MU Parameter Setting.....	46
Figure 45: RU Parameter Setting	46
Figure 46: Finish.....	47
Figure 47: System – Import & Export	47
Figure 48: System – Summary.....	48
Figure 49: System – Scan.....	48
Figure 50: System – Remove.....	48
Figure 51: System – Firmware	49
Figure 52: System – Log.....	49
Figure 53: System – Isolation.....	49

Figure 54: Input User Name and Password.....	54
Figure 55: Input License Code.....	55
Figure 56: License switch success.....	55
Table 1: MU Equipment Connectors.....	22
Table 2: RU Equipment Connectors.....	23
Table 3: LED Indicators.....	24
Table 4: Commissioning Task Explanation.....	27

0.3 HISTORY

Change No.	ENU	Details Of Change
1	1-0-0	This manual first created and issued in Dec 2017.

0.4 GLOSSARY OF TERMS

Abbreviation	Definition
ALC	Automatic Level Control
ATT	Attenuator
BTS	Base Transceiver Station
CH	Channel
CSA	Cross Sectional Area
dB	Decibel
dBm	Decibels relative to 1 milliwatt
DL	Downlink
DT	Donor Terminal
DPX	Duplexer
FOU	Fiber Optical Unit
FS	Frequency Selection
Hz	Hertz
ID	Identification
IF	Intermediate Frequency
LNA	Low Noise Amplifier
LOS	Line-of-Sight
MCU	Main Control Unit
MHz	Megahertz
MT	Mobile Terminal
MTBF	Mean Time Between Failures
MU	Master Unit
NF	Noise Figure
OMC	Operation & Maintenance Center
OMT	Operation & Maintenance Terminal
OP	Optical Fiber
PA	Power Amplifier
PLL	Phase Locked Loop
PSU	Power Supply Unit
RF	Radio Frequency
RFU	Radio Frequency Unit
RU	Remote Unit
SMA	Sub-Miniature A Connector
TX/RX	Transmit/Receive
UL	Uplink
VAC	Volts Alternating Current
VDC	Volts Direct Current
VSWR	Voltage Standing Wave Ratio

0.5 SAFETY NOTICES AND ADMONISHMENTS

This document contains safety notices in accordance with appropriate standards. In the interests of conformity with the territory standards for the country concerned, the equivalent territorial admonishments are also shown.

Any installation, adjustment, maintenance and repair of the equipment must only be carried out by trained, authorized personnel. At all times, personnel must comply with any safety notices and instructions.

Specific hazards are indicated by symbol labels on or near the affected parts of the equipment. The labels conform to international standards, are triangular in shape, and are colored black on a yellow background. An informative text label may accompany the symbol label.

Hazard labeling is supplemented by safety notices in the appropriate equipment manual. These notices contain additional information on the nature of the hazard and may also specify precautions.

Note: The grantee is not responsible for any changes or modifications not expressly approved by the party responsible for compliance. Such modifications could void the user's authority to operate the equipment.

For compliance with the occupational/controlled RF exposure limits, each individual antenna used for this transmitter must be installed to provide a separation distance greater than 20 cm or more from all persons during normal operation and must not be co-located with any other antenna for meeting RF exposure requirements.

Warning Notices:

These draw the attention of personnel to hazards that may cause death or injury to the operator or others. Examples of use are cases of high voltage, laser emission, toxic substances, point of high temperature, etc.

The design of the antenna installation needs to be implemented in such a way so as to ensure RF radiation safety levels and non-environmental pollution during operation.

Note: Antennas, feeders and couplers are not included in the packing list; solution provider should consider these accessories according to site conditions.

WARNING! This is **NOT** a **CONSUMER** device. It is designed for installation by **FCC LICENSEES** and **QUALIFIED INSTALLERS**. You **MUST** have an **FCC LICENSE** or express consent of an FCC Licensee to operate this device. Unauthorized use may result in significant forfeiture penalties, including penalties in excess of \$100,000 for each continuing violation.

Note: The grantee is not responsible for any changes or modifications not expressly approved by the party responsible for compliance. Such modifications could void the user's authority to operate the equipment.

Alert:

These draw the attention of personnel to hazards that may cause damage to the equipment. An example of use is the case of static electricity hazard.

Caution notices may also be used in the handbook to draw attention to matters that do not constitute a risk of causing damage to the equipment but where there is a possibility of seriously impairing its performance, e.g. by mishandling or gross maladjustment. Warnings and Cautions within the main text do not incorporate labels and may be in shortened form.

Disconnection of the RU RF connectors may cause damage to the equipment when power is on. The application antenna and RF cable are not provided.

The antenna gain should not exceed 9dBi for uplink and should not exceed 4dBi for downlink

WARNING!

Use only authorized and approved antennas, cables and/or coupling devices! The use of unapproved antennas, cables or coupling devices could cause damage and may be of violation of FCC regulations. The use of unapproved antennas, cables and/or coupling devices is illegal under FCC regulations and may subject the user to fines.

End of Section

1 GENERAL INFORMATION

The Public Safety Distributed Antenna System RH-7W22 (hereinafter called “PS DAS”) consists of Master Unit (MU) and Remote Unit (RU). The MU includes the MU Chassis, Power Supply Unit (PSU), Fiber Optical module and RF module. Optical module with a modular design, it can support up to 8 independent Remote Units. The Remote Unit is designed with a compact form for easy installation; it is an integrated design which supports 2 independent bands, 700MHz and 800MHz.

The low signal transmission loss of optical fiber is applicable for long distance transmission. PS DAS can support the optical transmission of up to 6.5dBo optical loss, equivalent to 8 miles fiber length.

Main Features

- Dual-band configuration supports 700MHz and 800MHz public safety bands
- Supports P25 P1/P2 digital and conventional analog communications simultaneously
- Supports FirstNet™ LTE Band 14 (Class B)
- Up to 32 channels (Class A) / 3 sub bands (Class B)
- Channelized Auto Level Control (ALC) supported (Class A)
- Channelized uplink squelch supported (Class A)
- Web based GUI for intelligent configuration, SNMP supported
- Built-in mandatory isolation test to prevent oscillation
- NFPA 1221 compliant dry contact alarms on MU / RUs
- NFPA 1221 compliant NEMA 4X enclosure for MU / RUs
- Alarming output to supervised circuits for: antenna failure, signal booster failure, and etc.

The following figure shows the enclosure of the PS DAS Master unit and Remote unit.



Figure 1: Master Unit (MU)



Figure 2: Remote Unit (RU)

End of Section

2 EQUIPMENT DESCRIPTION

2.1 SYSTEM DIAGRAM

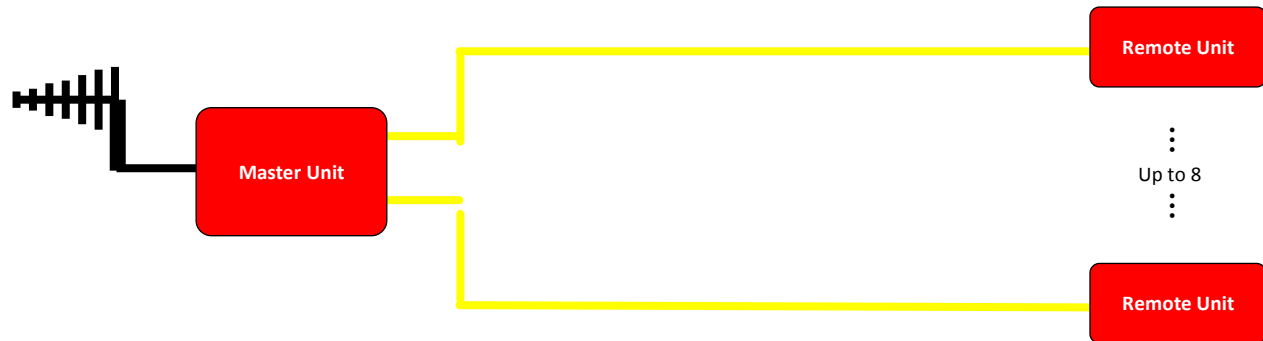

Figure 3: PS DAS Functional Block Diagram

In the downlink path, the BTS signals are received by the donor antenna of the Master Unit. After the duplexer, the signals are sent to the LNA module for pre-amplification and to the digital RF integrated module for digital filtering and frequency conversion. Then the DL signals will be sent to the Remote Unit to amplify power by optical fiber, and filter via the duplexer. After amplification, the signals are transmitted at the MT port to the service antenna.

In the uplink path, the mobile signals are received by the service antenna. After the MT port duplexer, the signals are sent to the LNA, integrated module for digital filtering, then the UL signals will be sent to the Master Unit for power amplification and to the duplexer. After that, the uplink signals are sent to the donor antenna for transmission back to the BTS.

The devices can detect output power, refer to expect output power which is set by user, the device can reduce or increase internal ATT automatically and remain the expected output power. This is the AGC principle.

2.2 EQUIPMENT LAYOUT

Shown below is the internal layout of the PS DAS.

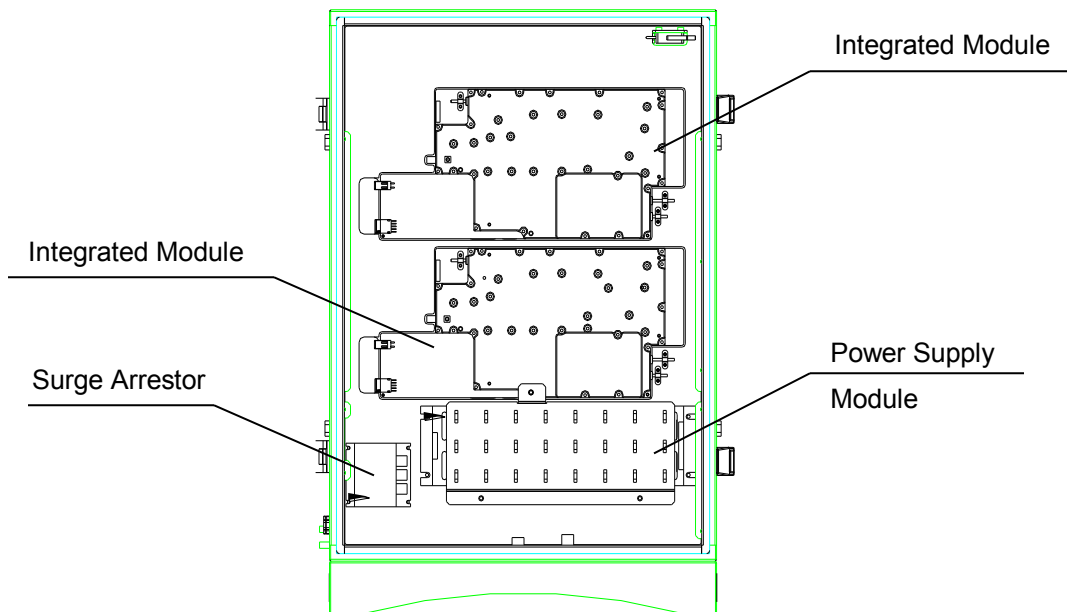

Figure 4: Layout of the MU Bottom layer

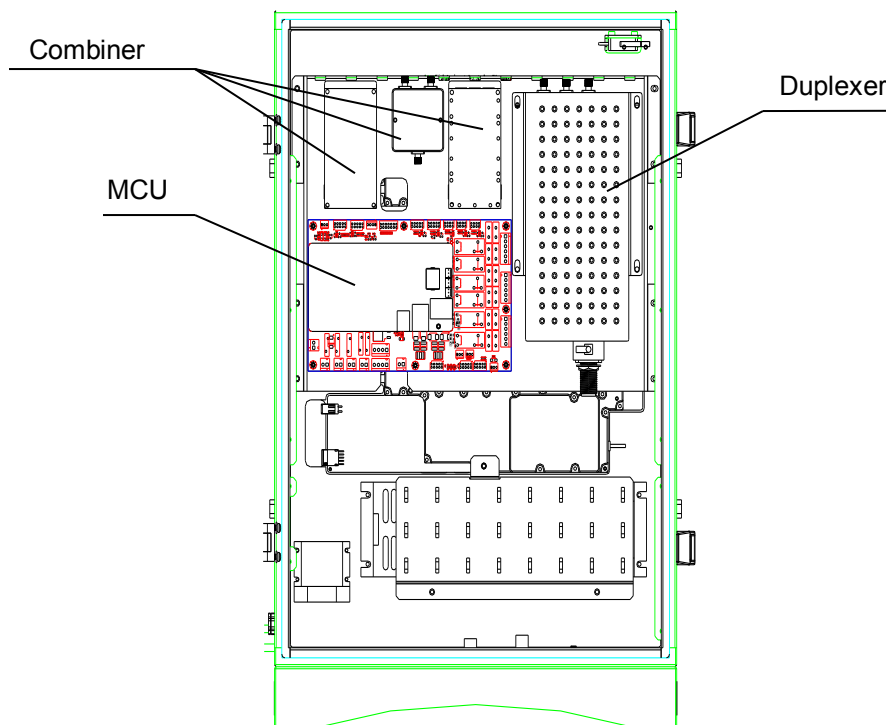

Figure 5: Layout of the MU middle layer

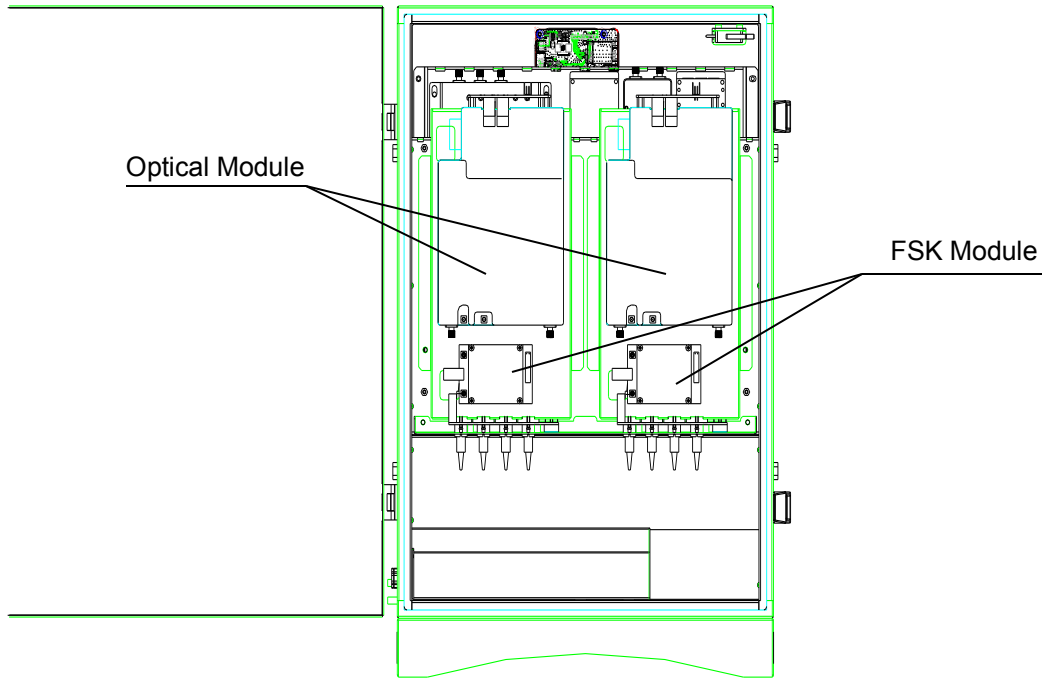

Figure 6: Layout of the MU top layer

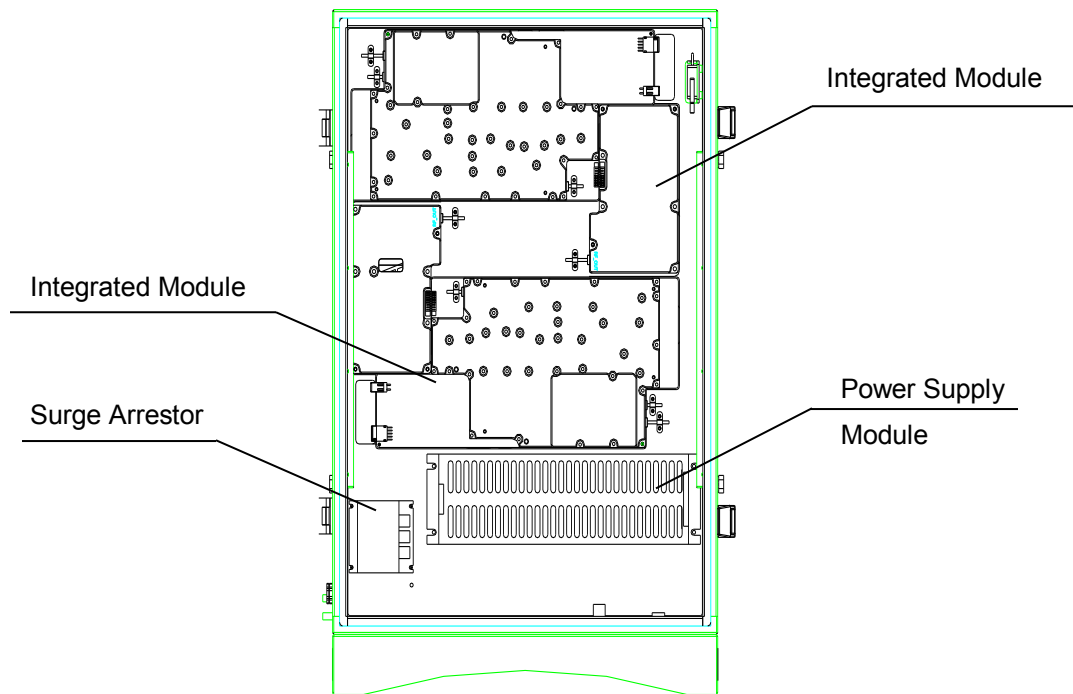

Figure 7: Layout of the RU Bottom layer

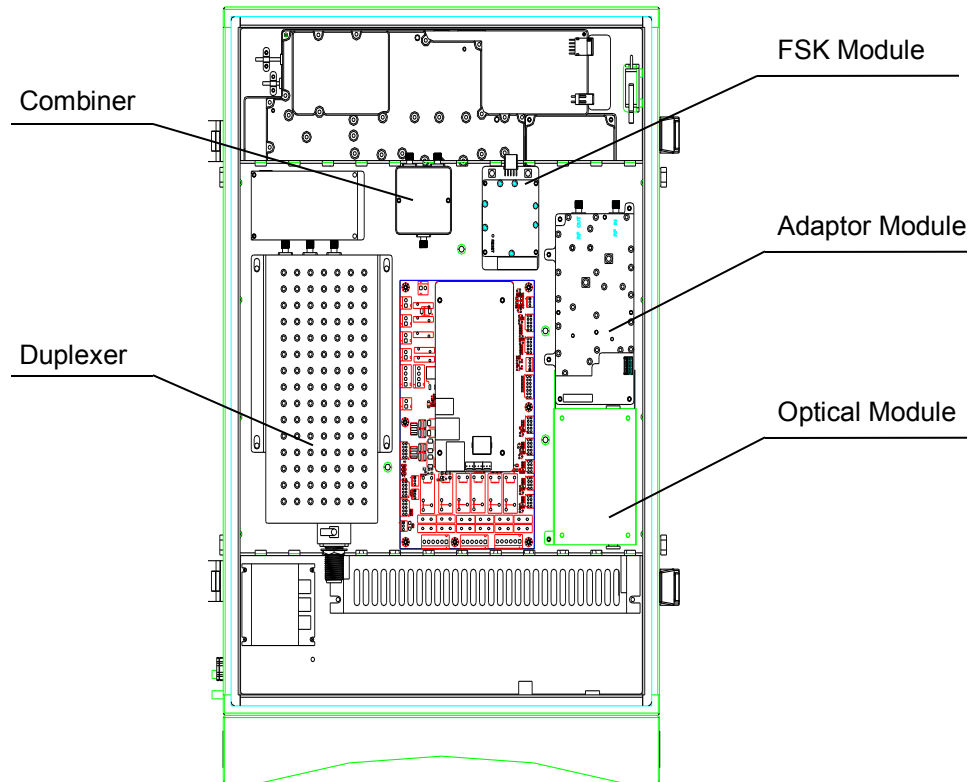

Figure 8: Layout of the RU top layer

2.3 EQUIPMENT CONSTITUTION

The typical PS DAS unit consists of the following components:

Power Amplifier (PA): It provides power amplification for both the UL and DL branches.

Main Control Unit (MCU): The MCU is used to monitor and control the operation of the repeater. It also provides the communication interface for remote control and status indication. LED indicators provide the operation status of the MCU.

Duplexer: The DPX is located near the MT and DT terminals and permits the uplink and downlink signals to share a common antenna.

Digital Integrated Module and Power Amplifier: Consists of the Power Conversion module, RF module, digital process module and monitoring modules. The Power Conversion module converts +28V DC voltage into +9VJK and +9VRF. +9VJK, +9VRF are supplied to the monitoring unit, and the RF unit in the integrated module separately. The RF module amplifies and converts the RF signal to IF signal. The Digital process module converts the IF signal into baseband signal via AD conversion and extraction, and filtering. After that, the IF signal will be amplified and converted to an RF signal by the RF module for RF filtering and amplification. The Monitoring module monitors and controls the system parameters and is the interface for both remote monitoring and local commissioning.

Power Supply Unit (PSU): The PSU converts the input voltage into a stable DC supply to provide power for the internal functional modules.

Optical module: Completes optical signal and RF signal conversion.

3 INSTALLATION

3.1 WARNINGS AND ALERTS

Radio Frequency Energies

There may be situations, particularly for workplace environments near high-powered RF sources, where recommended limits for safe exposure of human beings to RF energy could be exceeded. In such cases, restrictive measures or actions may be necessary to ensure the safe use of RF energy.

High Voltage

The equipment has been designed and constructed to prevent, as far as reasonably practicable danger. Any work activity on or near equipment involving installation, operation or maintenance must be, as far as reasonable, free from danger.

Where there is a risk of damage to electrical systems involving adverse weather, extreme temperatures, wet, corrosive or dirty conditions, flammable or explosive atmospheres, the system must be suitably installed to prevent danger.

Protective Earthing

Equipment provided for the purpose of protecting individuals from electrical risk must be suitable for the purpose and properly maintained and used.

Handling Precautions

This covers a range of activities including lifting, lowering, pushing, pulling, carrying, moving, holding or restraining an object, animal or person from the equipment. It also covers activities that require the use of force or effort, such as pulling a lever, or operating power tools.

Where some of the abovementioned activities are required, the equipment must be handled with care to avoid being damaged.

Electrostatic Discharge (ESD)

Observe standard precautions for handling ESD-sensitive devices. Assume that all solid-state electronic devices are ESD-sensitive. Ensure the use of a grounded wrist strap or equivalent while working with ESD-sensitive devices. Transport, store, and handle ESD-sensitive devices in static-safe environments.

3.2 SITE PLANNING CONSIDERATIONS

3.2.1 SITE PLANNING

Site Considerations

Outdoor equipment are designed to be waterproof, rainproof, and with snow protection. Temporary protection should be taken when the equipment enclosure is opened for installation or maintenance in an outdoor environment. The equipment must not be opened for installation or maintenance in bad weather (e.g. gale, storm rainfall, extreme temperatures and high humidity)

Installation Location

Mounting surface shall be capable of supporting the weight of the equipment.

In order to avoid electromagnetic interference, a proper mounting location must be selected to minimize interference from electromagnetic sources such as large electrical equipment.

Environmental

Humidity has an adverse effect on the reliability of the equipment. It is recommended to install the equipment in locations having stable temperature and unrestricted air-flow.

The installation location for the product should be well ventilated. The equipment has been designed to operate at the temperature range and humidity level as stated in the product specifications in the datasheet.

Direct sun light exposure to the equipment should be avoided. Provide additional shelter if necessary.

Power Supply

The power supply unit (PSU) provides power to all modules within the equipment. Depending on the product variant, it is recommended that the PSU be operated on a dedicated circuit breaker or fused circuit.

Grounding Requirement

Verify that the equipment has been well grounded. This includes antennas and all cables connected to the system. Ensure lightning protection for the antennas is properly grounded.

Cable Routing

Depending on equipment configuration, a variety of types of cables are required. Where applicable, ensure cables are properly routed and secured so that they are not damaged.

Manual Handling

During transportation and installation, take necessary handling precautions to avoid potential physical injury to the installation personnel and the equipment.

3.2.2 INSTALLATION CHECKLIST

- Working space available for installation and maintenance for each mounting arrangement. Ensure unrestricted airflow.
- Ensure earth ground point is within reach of the ground wire.
- Ensure a power source is within reach of the power cord and the power source has sufficient capacity.
- Where appropriate, ensure unused RF connectors are terminated.
- Do not locate the equipment near large transformers or motors that may cause electromagnetic interference.
- Reduce signal loss in feeder cable by minimizing the length and number of RF connections.
- Ensure VSWR of antennas system < 1.5:1.
- Ensure equipment will be operated within the stated environment (see datasheet)
- Observe handling of all cables to prevent damage.
- Donor antenna should have a narrow beamwidth and positioned in line-of-sight (LOS) to the donor BTS site so that the donor signal level is maximized. This allows the use of minimum gain to achieve the maximum DL output power. The UL gain is typically set lower than or equal to the DL gain to minimize noise interference to the donor BTS
- Service antennas should be selected based on the type of service area, e.g., indoor antenna for indoor application, and panel antenna for outdoor application.

3.3 INSTALLATION PROCEDURES

3.3.1 GOODS INWARDS INSPECTION

- Verify the number of packages received against the packing list.
- Check all packages for external damage; report any external damage to the shipping courier. If there is damage, a shipping agent should be present before unpacking and inspecting the contents because damage during transit is the responsibility of the agent.
- Open and check each package against the packing list. If any items are missing, contact Comba.
- Do not remove items from anti-static packing until ready for installation. If damage is discovered at the time of installation, contact the shipping agent.

3.3.2 TOOLS

See Appendix A for a full list of the recommended tools required for installation and routine maintenance.

3.3.3 PREPARATION

- Wall mounting with the masonry bolts supplied, which make use of the outer holes.

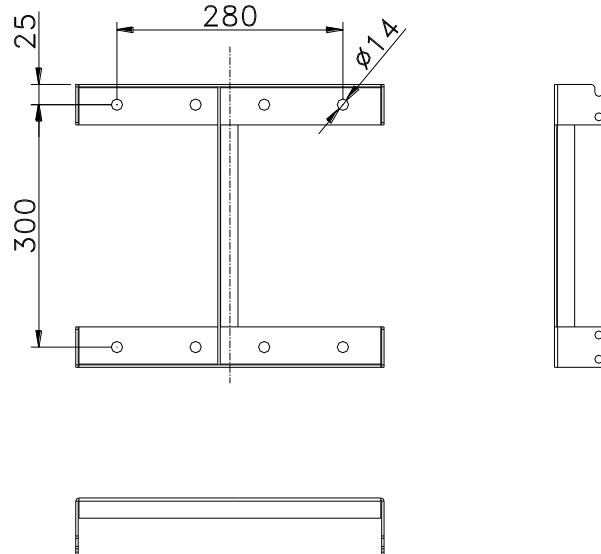

Figure 9: Mounting Rack Overview

3.3.4 WALL MOUNTING

- Drill four holes on the wall using the position of four holes on the mounting rack as a guide. Fix the mounting rack to the wall using four masonry bolts (M10x110mm).
- Install the Mounting Rack to the wall.
- Hang the equipment and secure the enclosure to the mounting rack.

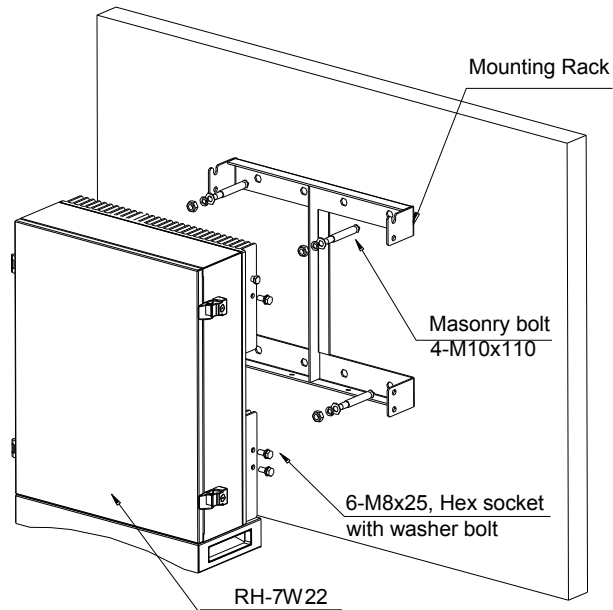

Figure 10: PS DAS Wall Mounting

3.3.5 DRIP-LOOP

Comba recommends that every horizontal cable entry to the equipment forms a 'U' before its entry to the equipment. Water on the cable will drip down at the bottom of the loop and will not accumulate at the equipment connectors.

3.4 EQUIPMENT CONNECTORS

3.4.1 PS DAS CONNECTORS

The PS DAS is designed for all cable entries from the right or left of the enclosure, as shown in the following figure.

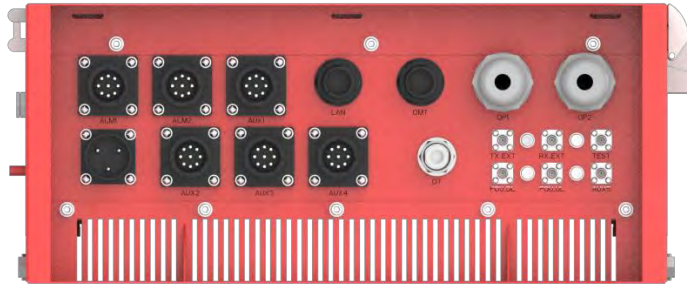

Figure 11: MU Equipment Connectors

Table 1: MU Equipment Connectors

Identifier	Descriptions
Power ¹	Power cable connector for a pre-installed power cord for connection to AC (e.g. DC -48V).
DT	N-Female connector for connection to donor antenna.
Test	SMA connector for DT port test, -22dB coupling to DT port, available for both downlink and uplink test.
TX_EXT/RX_EXT	Extensive RF Unit RF connectors, available for both downlink and uplink test.
FOU_UL/FOU_DL	Extensive Fiber Unit RF connectors, available for both downlink and uplink test.
OP	SC/APC optical fiber access port.
ALM1	Connector for connection to dry contact alarm 1-3.
ALM2	Connector for connection to dry contact alarm 4-6.
AUX1	Connector for connection to external alarm 1-4.
AUX2-4	Connector for extensive units.
AUX5	SMA connector for antenna connecting status detection
LAN	RJ45 Connector for internet connection (Ethernet type only).

¹ The voltage identification is a variant due to electricity system diversity of global regions. The power cable connector might be identified for AC 110V, AC 220V, AC 110V/220V, or DC -48V respectively. Please refer to specific product or contact local sales if any doubt.

OMT	RJ45 Connector for local WEB GUI connection.
OP1~OP2	Optical fiber access port

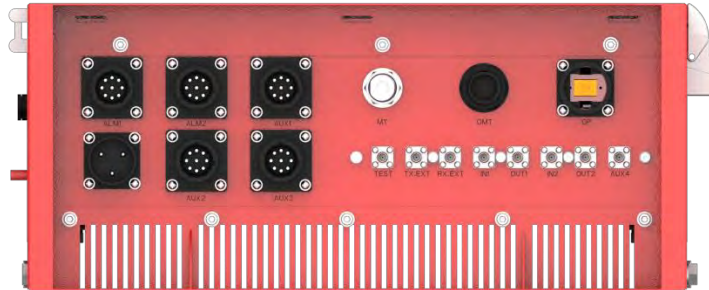

Figure 12: RU Equipment Connectors

Table 2: RU Equipment Connectors

Identifier	Descriptions
Power ¹	Power cable connector for a pre-installed power cord for connection to AC (e.g. DC -48V).
MT	N-Female connector for connection to service antenna.
Test	SMA connector for MT port test, -22dB coupling to MT port, available for both downlink and uplink test.
TX_EXT/RX_EXT	Extensive RF Unit RF connectors, available for both downlink and uplink test.
IN1/OUT1/IN2/OUT2	SMA connector for external filters.
ALM1	Connector for connection to dry contact alarm 1-3.
ALM2	Connector for connection to dry contact alarm 4-6.
AUX1	Connector for connection to external alarm 1-4.
AUX2-3	Connector for extensive units.
AUX4	SMA connector for antenna connecting status detection
OMT	RJ45 Connector for local WEB GUI connection.
OP	SC/APC optical fiber access port.

¹ The voltage identification is a variant due to electricity system diversity of global regions. The power cable connector might be identified for AC 110V, AC 220V, AC 110V/220V, or DC -48V respectively. Please refer to specific product or contact local sales if any doubt.

3.4.2 PS DAS LED Indicators

The LED indicators help user to check the equipment status easily.

Table 3: LED Indicators

Identifier	Colour	Indication
PWR	Green	Power indicator. ON = power on; OFF = power off.
RUN	Green	Operation indicator, flashes every second to indicate normal operation.
ALM	Red	Alarm indicator. ON = alarm; OFF = no alarm.
OP	Green	Indicator for receive optical power. If LED is off, it indicates the receiving optical power is less than -10dBm.

3.4.3 GROUNDING CONNECTION

Ground Connection

To ensure safe operation of the product, a ground (earth) connection is required. For single phase AC power source, the product must be grounded by connecting the “earth wire” of the power cord to the ground terminal of the AC supply. For operating this product with DC power system (such as rectifiers), the product should not be connected to power systems that switch open the return lead because the return lead could function as the ground (earth) connection for the equipment.

Protective Ground Connection

The enclosure must be grounded securely by connecting a copper wire (CSA 16mm²) to the grounding terminal on the equipment/rack, and the other end to a protective ground (i.e. building earth point). An internationally acceptable color code of the ground connection wire is green/yellow.

Such a ground connection implements the “Protective Ground Connection”, and must be connected to the equipment at the designated ground point. In general, do not connect the supply before establishing an adequate ground (earth) connection.

Construct the ground wire, and use appropriate crimp connectors where necessary. Locate and connect the equipment grounding terminal to a protective ground (i.e. building earth point).

3.4.4 RF CABLE CONNECTION

Single band PS DAS RF cables connection is as follows:

- PS DAS MU DT port → Connects to the feeder cable from donor antennas.
- PS DAS RU MT port → Connects to the feeder cable from service antennas.

3.4.5 ETHERNET CONNECTION

Connect Ethernet with ‘LAN’ port in the panel, Ethernet type only.

End of Section

4 COMMISSIONING

4.1 PRE-COMMISSIONING TASKS

After equipment installation, perform the following steps before equipment powering and commissioning:

- Verify that the expected voltage, current and power levels do not violate any ratings.
- Visually inspect the power connection within the equipment. Ensure that the power cable is correctly and securely connected, including the grounding wire, RF cable and other cables.
- Check the grounding connection and verify that the ground resistance is less than 5Ω .
- Test the antenna system and ensure that the echo loss within working frequency is less than -14dB (VSWR<1.5).

4.2 COMMISSIONING PROCEDURE

Perform the following procedures for system commissioning.

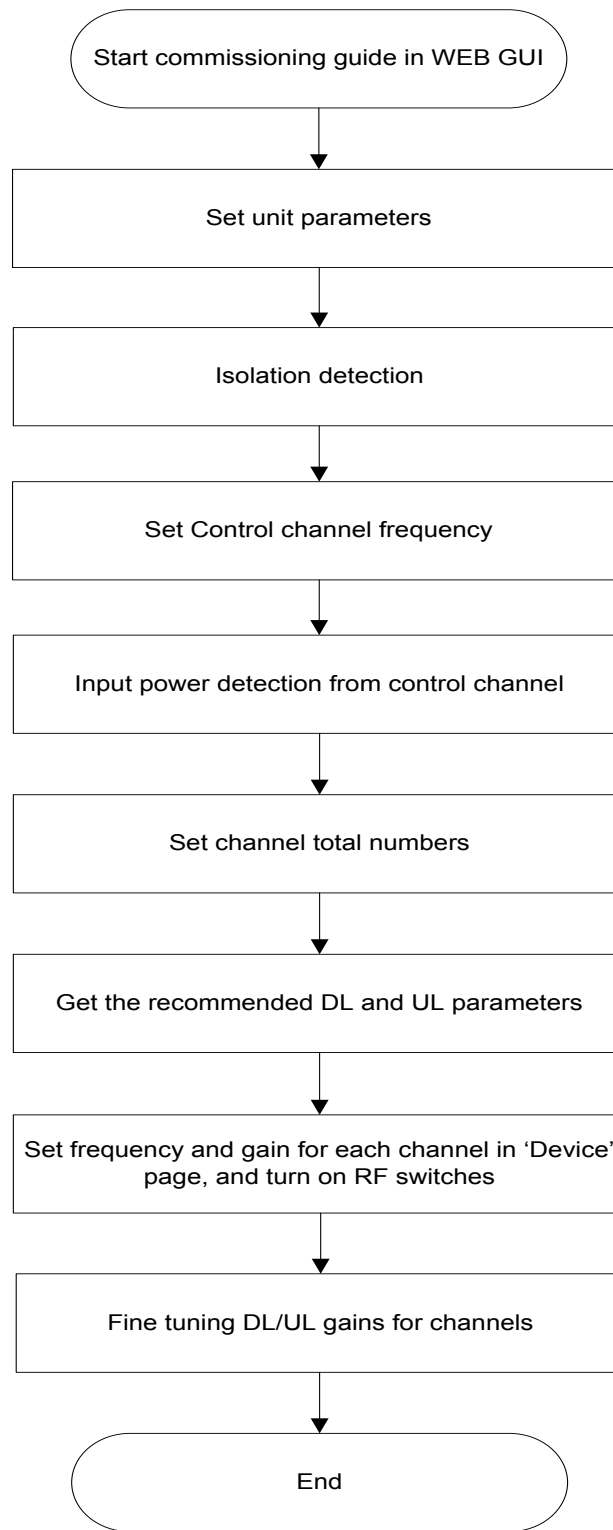

Figure 13: Commissioning Procedure

Table 4: Commissioning Task Explanation

Commissioning Tasks	Observation
1. Isolation detection	<ul style="list-style-type: none"> ● Detect isolation of service antenna and donor antenna.
2. Set control channel frequencies	<ul style="list-style-type: none"> ● Enter the center frequency of the main control channel, the commissioning guide will provide recommended DL/UL gain settings based on main control channel input power and the total channel numbers. ● Users can skip this step and directly finish the commissioning guide even if the frequency information or the total channel numbers are unknown. Users are able to set the DL/UL gain manually any time after the isolation detection has been completed and passed.
3. Set Channel No.	<ul style="list-style-type: none"> ● Enter the total channel numbers
4. Recommended DL and UL gain parameters	<ul style="list-style-type: none"> ● The commissioning guide will provide recommended DL/UL gain settings. ● Users will still need to set all the gains manually in the “Device” pages, and the frequencies for all the independent channels in the same “Device” pages after the commissioning process is finished.

End of Section

5 WEB GUI

The PS DAS can be monitored and controlled via the WEB GUI; use the following guide to finish system parameter setting and commissioning.

5.1 WEB GUI CONNECTION

Step 1: Connect the OMT port to the PC RJ45 port with the supplied RJ45 cable to set up a physical connection.

Step 2: Open a browser (suggested Firefox browser, display resolution is 1024×768), input Web GUI **IP address: 192.168.8.101**, click [Enter].

NOTE: DHCP and DNS are also available to login to the Web GUI. The domain name is: www.combaomt.com.

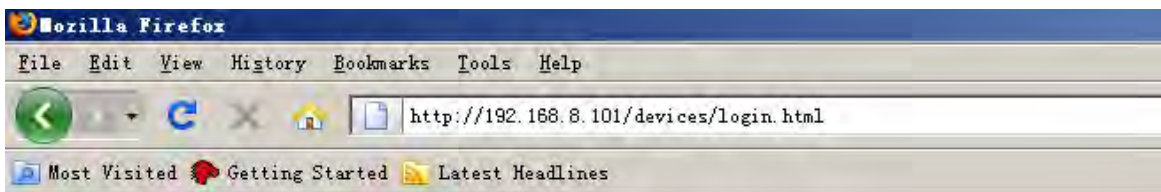

Figure 14: Input IP Address

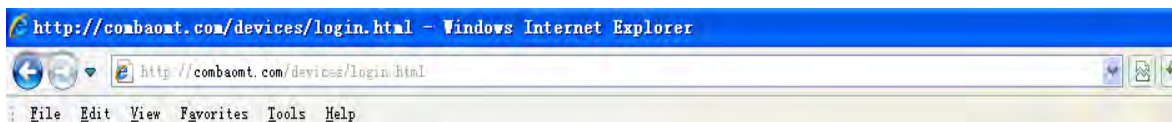

Figure 15: Input Domain Name

Step 3: Input **User Name: admin**; **Password** (default password: **admin**). Click [Log in].

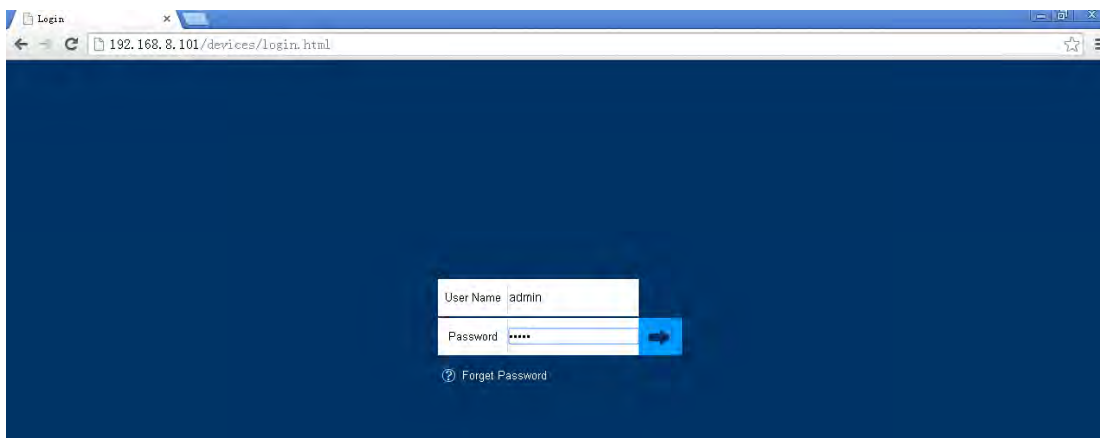

Figure 16: Input User Name and Password

5.2 WEB GUI INTRODUCTION

After log in, the Web GUI main screen will appear.

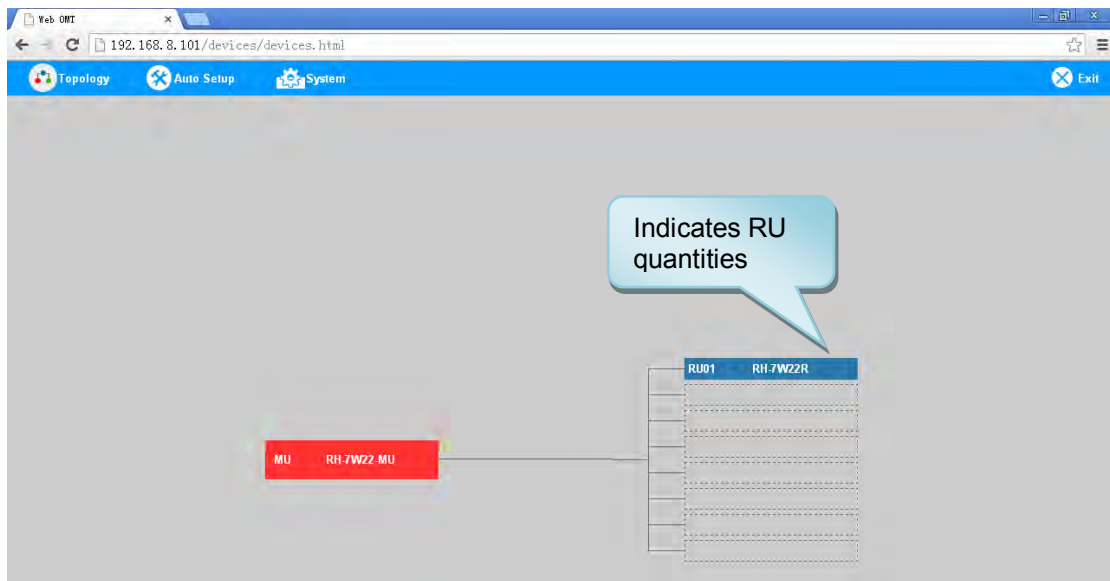

Figure 17: Web GUI Main Screen

On Comba Web GUI Home Screen, there are three Menu bars: **[Topology]**, **[Auto Setup]** and **[System]**.

5.2.1 [TOPOLOGY][PARAMETER INFORMATION]

The [Topology] Screen shows the equipment status, such as setting status, alarm information, etc.

➤ Overview Screen

Dev Model: RH-7W22-MU
 Uptime: 0:13:49 0/0/0
 Date/Time: 12/09/17 15:31:45
 Temperature: 35°C
 Serial Num: 123456
 Dev Info:
 Firmware-Version: M75RH7W22MUEH10V8001
 Site ID: 00000000

Freq Band	800MHz	700MHz	
RF Switch	ON	ON	Setting
UL P_out	2dBm	2dBm	
Target UL P_out	24dBm	24dBm	Setting
UL Rating Gain	30dB	30dB	Setting
DL Rating Gain	60dB	60dB	Setting
Mute Switch	ON	ON	Setting
ALC Mode	VWB	VWB	Setting
UL PA Status	Normal	Normal	
Commission	Not Done	Not Done	
Mute TH	-105dBm	-105dBm	Setting
DL P_in Low Alarm TH	-85dBm	-85dBm	Setting
DL P_in Over Alarm TH	-30dBm	-30dBm	Setting
UL P_out Low Alarm TH	0dBm	0dBm	Setting
UL P_out Over Alarm TH	27dBm	27dBm	Setting
LNA Alarm	<input checked="" type="checkbox"/>	<input checked="" type="checkbox"/>	Setting
PLL Alarm	<input checked="" type="checkbox"/>	<input checked="" type="checkbox"/>	Setting
DL P_in Low Alarm	<input checked="" type="checkbox"/>	<input checked="" type="checkbox"/>	Setting
DL P_in Over Alarm	<input checked="" type="checkbox"/>	<input checked="" type="checkbox"/>	Setting
UL P_out Low Alarm	<input checked="" type="checkbox"/>	<input checked="" type="checkbox"/>	Setting
UL P_out Over Alarm	<input checked="" type="checkbox"/>	<input checked="" type="checkbox"/>	Setting
Shutdown Alarm	<input checked="" type="checkbox"/>	<input checked="" type="checkbox"/>	Setting

Figure 18: Overview Screen – MU

Dev Model: RH-7W22-MU
 Uptime: 0:13:49 0/0/0
 Date/Time: 12/09/17 15:31:45
 Temperature: 35°C
 Serial Num: 123456
 Dev Info:
 Firmware-Version: M75RH7W22MUEH10V8001
 Site ID: 00000000

Freq Band	800MHz	700MHz	
RF Switch	ON	ON	Setting
UL P_out	2dBm	2dBm	
Target UL P_out	24dBm	24dBm	Setting
UL Rating Gain	30dB	30dB	Setting
DL Rating Gain	60dB	60dB	Setting
Mute Switch	ON	ON	Setting
ALC Mode	VWB	VWB	Setting
UL PA Status	Normal	Normal	
Commission	Not Done	Not Done	
Mute TH	-105dBm	-105dBm	Setting
DL P_in Low Alarm TH	-85dBm	-85dBm	Setting
DL P_in Over Alarm TH	-30dBm	-30dBm	Setting
UL P_out Low Alarm TH	0dBm	0dBm	Setting
UL P_out Over Alarm TH	27dBm	27dBm	Setting
LNA Alarm	<input checked="" type="checkbox"/>	<input checked="" type="checkbox"/>	Setting
PLL Alarm	<input checked="" type="checkbox"/>	<input checked="" type="checkbox"/>	Setting
DL P_in Low Alarm	<input checked="" type="checkbox"/>	<input checked="" type="checkbox"/>	Setting
DL P_in Over Alarm	<input checked="" type="checkbox"/>	<input checked="" type="checkbox"/>	Setting
UL P_out Low Alarm	<input checked="" type="checkbox"/>	<input checked="" type="checkbox"/>	Setting
UL P_out Over Alarm	<input checked="" type="checkbox"/>	<input checked="" type="checkbox"/>	Setting
Shutdown Alarm	<input checked="" type="checkbox"/>	<input checked="" type="checkbox"/>	Setting

Figure 19: Overview Screen – MU

Dev Model: RH-7W22P
 Uptime: 05:13 0/0/0
 Date/Time: 12/09/17 15:22:57
 Temperature: 32°C
 Serial Num:
 Dev Info: NA
 Firmware Version: M75RH7W22RWH10V8001
 Site ID: 00000000

Item	800MHz	700MHz	
RF Switch	ON	ON	Setting
DL P_out	<-2dBm	<-2dBm	
UL P_in	<-90dBm	<-90dBm	
DL Gain	35dB	35dB	Setting
UL Rating Gain	65dB	65dB	Setting
DL Rating Gain	35dB	35dB	Setting
Target DL P_out	33dBm	33dBm	Setting
DL P_out Rating	33dBm	33dBm	
ALC Mode	WB	WB	Setting
Mute Switch	OFF	OFF	Setting
Commission	Not Done	Not Done	
DL Calibration	Not Done	Not Done	
UL Calibration	Not Done	Not Done	
DL PA Status	Normal	Normal	
Mute TH	-100dBm	-100dBm	Setting
DL P_out Over Alarm TH	34dBm	34dBm	Setting
DL P_out Low Alarm TH	-3dBm	-3dBm	Setting
UL P_in Alarm TH	-39dBm	-39dBm	Setting
UL P_in Low Alarm TH	-91dBm	-91dBm	Setting
LNA Alarm	●	●	Setting
DL PA Alarm	●	●	Setting
PLL Alarm	●	●	Setting

Figure 20: Overview Screen – RU

➤ Device Alarm

Dev Model: RH-7W22-MU
 Uptime: 0:13:49 0/0/0
 Date/Time: 12/09/17 15:31:45
 Temperature: 35°C
 Serial Num: 123456
 Dev Info:
 Firmware Version: M75RH7W22MUEH10V8001
 Site ID: 00000000

Item	Current Value	Config Value
AC Alarm	●	Disable
DC Alarm	●	Disable
Door Open Alarm	●	Disable
Ext Alm1	●	Disable
Ext Alm2	●	Disable
Ext Alm3	●	Disable
Ext Alm4	●	Disable
Feeder Line Alarm	●	Disable
Over Temperature Alarm	●	Disable
Dry Contact Alm 01	●	
Dry Contact Alm 02	●	
Dry Contact Alm 03	●	
Dry Contact Alm 04	●	
Dry Contact Alm 05	●	
Dry Contact Alm 06	●	

Figure 21: Device alarm - MU

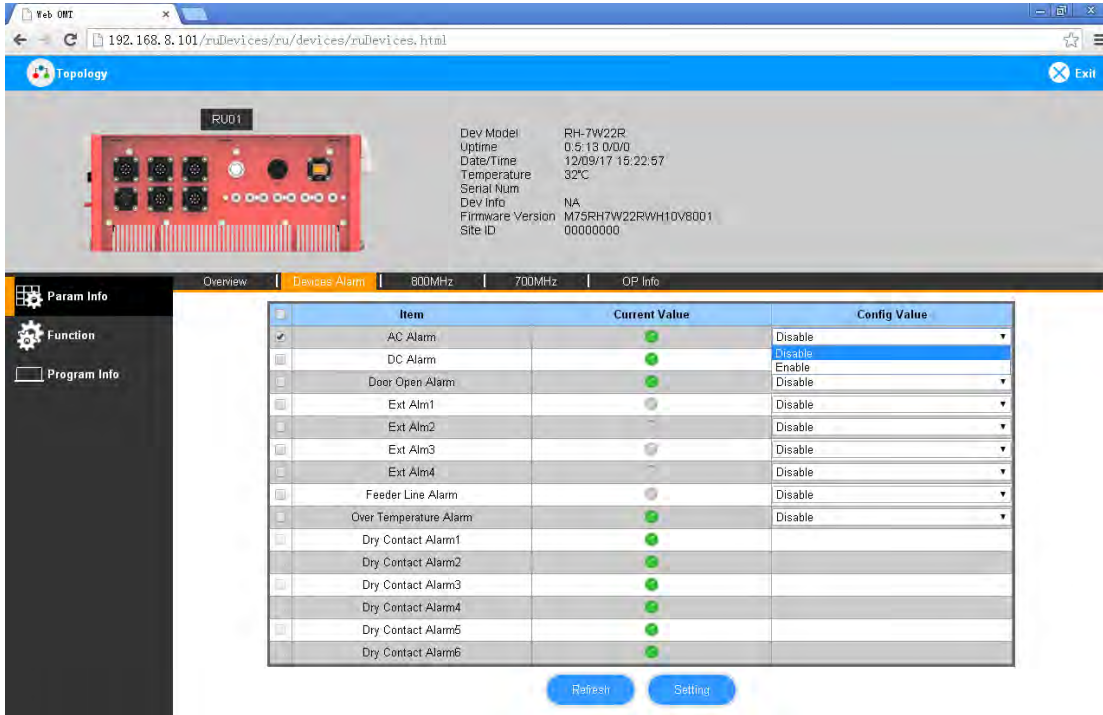

Figure 22: Device alarm - RU

➤ 800MHz Screen

This screen is only available for the dual band PS DAS or 800MHz PS DAS.

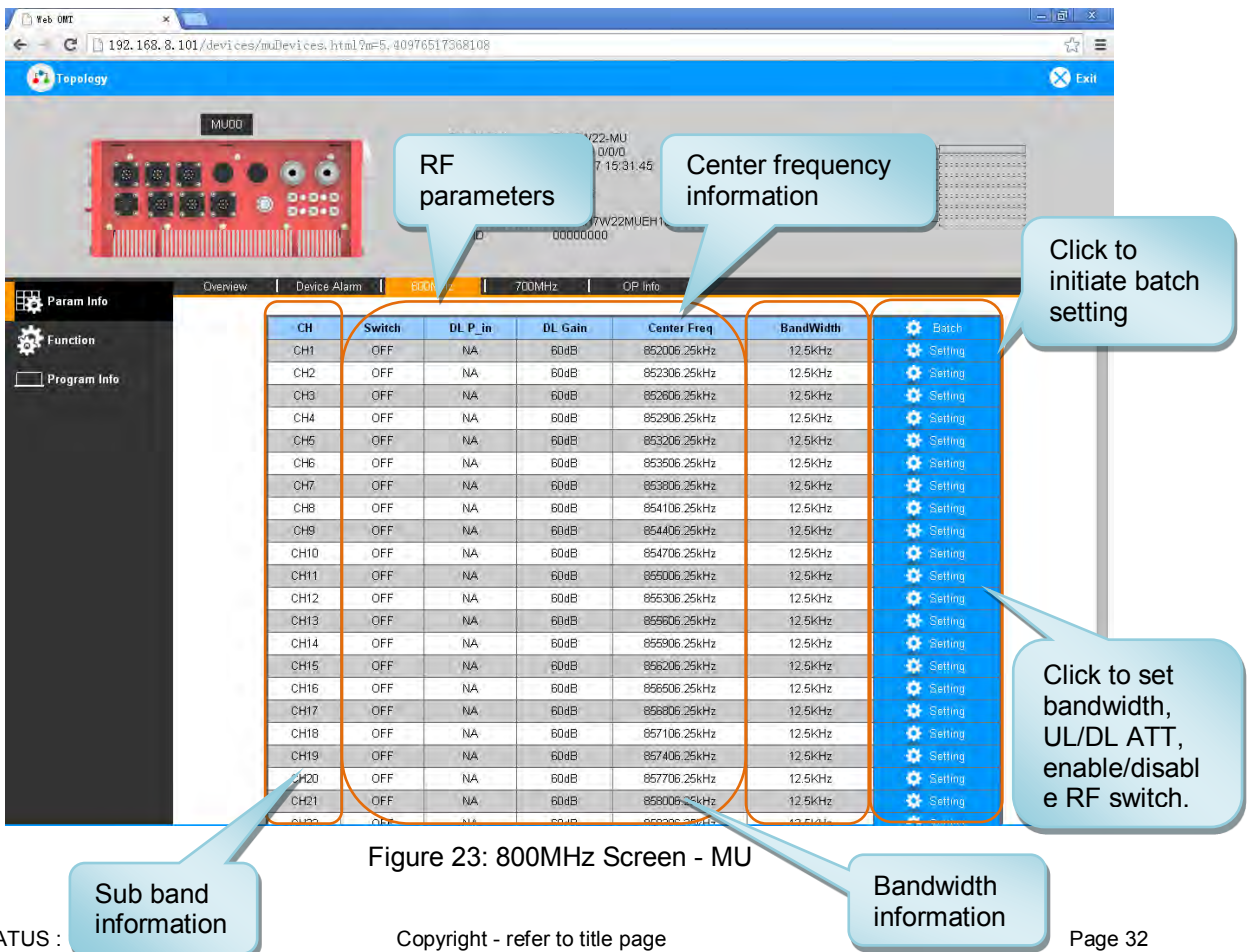

Figure 23: 800MHz Screen - MU

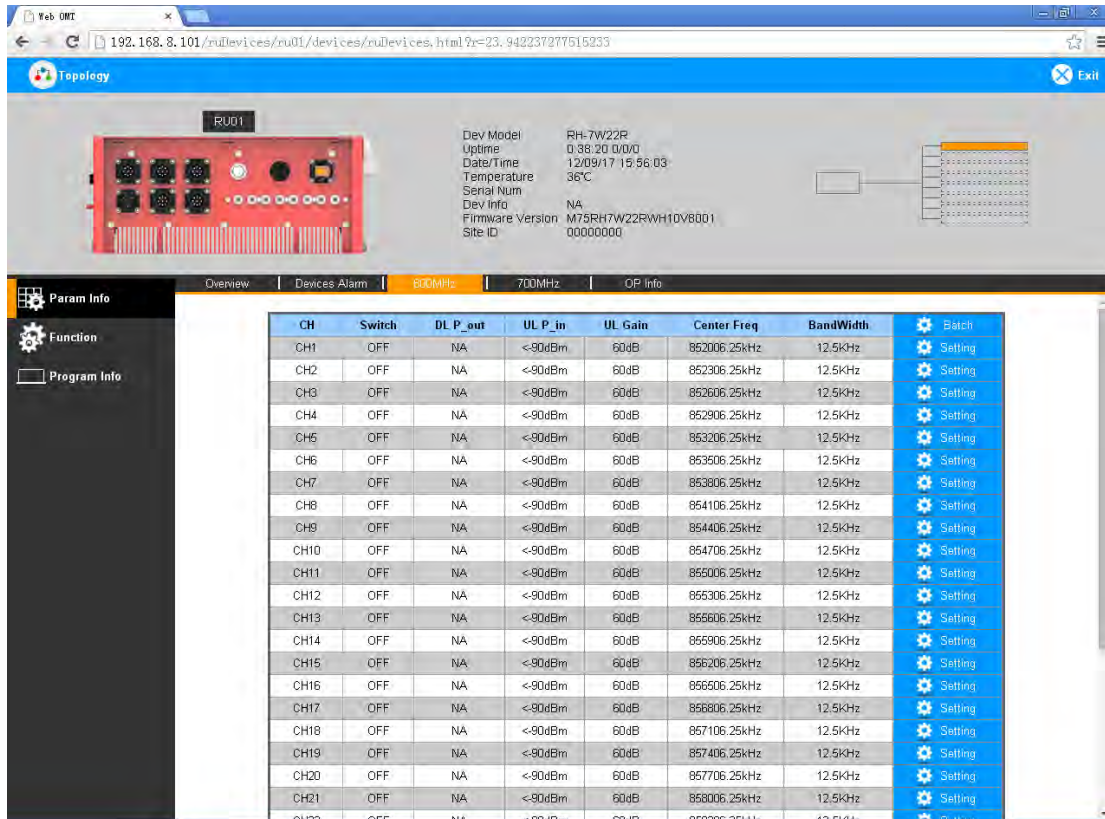

Figure 24: 800MHz Screen - RU

➤ **700MHz Screen**

This screen is only available for the dual band PS DAS or 700MHz PS DAS.

RF parameters

Center frequency information

Click to initiate batch setting

Click to set bandwidth, UL/DL ATT, enable/disable RF switch.

Sub band information

Bandwidth information

CH	Switch	DL P_in	DL Gain	Center Freq	BandWidth	Batch
CH1	OFF	NA	60dB	769006.25kHz	12.5kHz	Setting
CH2	OFF	NA	60dB	772006.25kHz	12.5kHz	Setting
CH3	OFF	NA	60dB	774993.25kHz	12.5kHz	Setting
CH4	OFF	NA	60dB	769156.25kHz	12.5kHz	Setting
CH5	OFF	NA	60dB	769306.25kHz	12.5kHz	Setting
CH6	OFF	NA	60dB	769456.25kHz	12.5kHz	Setting
CH7	OFF	NA	60dB	771896.25kHz	12.5kHz	Setting
CH8	OFF	NA	60dB	772156.25kHz	12.5kHz	Setting
CH9	OFF	NA	60dB	772306.25kHz	12.5kHz	Setting
CH10	OFF	NA	60dB	774543.25kHz	12.5kHz	Setting
CH11	OFF	NA	60dB	774693.25kHz	12.5kHz	Setting
CH12	OFF	NA	60dB	774843.25kHz	12.5kHz	Setting
CH13	OFF	NA	60dB	769606.25kHz	12.5kHz	Setting
CH14	OFF	NA	60dB	769756.25kHz	12.5kHz	Setting
CH15	OFF	NA	60dB	769906.25kHz	12.5kHz	Setting
CH16	OFF	NA	60dB	770056.25kHz	12.5kHz	Setting
CH17	OFF	NA	60dB	770206.25kHz	12.5kHz	Setting
CH18	OFF	NA	60dB	770356.25kHz	12.5kHz	Setting
CH19	OFF	NA	60dB	770506.25kHz	12.5kHz	Setting
CH20	OFF	NA	60dB	770656.25kHz	12.5kHz	Setting
CH21	OFF	NA	60dB	770806.25kHz	12.5kHz	Setting
CH22	OFF	NA	60dB	770956.25kHz	12.5kHz	Setting

Figure 25: 700MHz Screen - MU

CH	Switch	DL P_out	UL P_in	UL Gain	Center Freq	BandWidth	Batch
CH1	OFF	NA	<-90dBm	60dB	769006.25kHz	12.5kHz	Setting
CH2	OFF	NA	<-90dBm	60dB	772006.25kHz	12.5kHz	Setting
CH3	OFF	NA	<-90dBm	60dB	774993.25kHz	12.5kHz	Setting
CH4	OFF	NA	<-90dBm	60dB	769156.25kHz	12.5kHz	Setting
CH5	OFF	NA	<-90dBm	60dB	769306.25kHz	12.5kHz	Setting
CH6	OFF	NA	<-90dBm	60dB	769456.25kHz	12.5kHz	Setting
CH7	OFF	NA	<-90dBm	60dB	771896.25kHz	12.5kHz	Setting
CH8	OFF	NA	<-90dBm	60dB	772156.25kHz	12.5kHz	Setting
CH9	OFF	NA	<-90dBm	60dB	772306.25kHz	12.5kHz	Setting
CH10	OFF	NA	<-90dBm	60dB	774543.25kHz	12.5kHz	Setting
CH11	OFF	NA	<-90dBm	60dB	774693.25kHz	12.5kHz	Setting
CH12	OFF	NA	<-90dBm	60dB	774843.25kHz	12.5kHz	Setting
CH13	OFF	NA	<-90dBm	60dB	769606.25kHz	12.5kHz	Setting
CH14	OFF	NA	<-90dBm	60dB	769756.25kHz	12.5kHz	Setting
CH15	OFF	NA	<-90dBm	60dB	769906.25kHz	12.5kHz	Setting
CH16	OFF	NA	<-90dBm	60dB	770056.25kHz	12.5kHz	Setting
CH17	OFF	NA	<-90dBm	60dB	770206.25kHz	12.5kHz	Setting
CH18	OFF	NA	<-90dBm	60dB	770356.25kHz	12.5kHz	Setting
CH19	OFF	NA	<-90dBm	60dB	770506.25kHz	12.5kHz	Setting
CH20	OFF	NA	<-90dBm	60dB	770656.25kHz	12.5kHz	Setting
CH21	OFF	NA	<-90dBm	60dB	770806.25kHz	12.5kHz	Setting
CH22	OFF	NA	<-90dBm	60dB	770956.25kHz	12.5kHz	Setting

Figure 26: 700MHz Screen - RU

➤ Optical Information

The screenshot shows the web interface for device MU00. The top navigation bar includes 'Overview', 'Device Alarm', '800MHz', '700MHz', and 'OP Info'. The main content area displays a table of optical parameters and their alarm status.

Item	Current Value	Config Value
OP_1 FSK Tx Power	0dBm	
OP_1 Rx Power1	2.3dBm	
OP_1 Rx Power2	<-10dBm	
OP_1 Rx Power3	<-10dBm	
OP_1 Rx Power4	<-10dBm	
OP_1 Tx Power1	-3dBm	
OP_1 Tx Power2	-3dBm	
OP_1 Tx Power3	-3dBm	
OP_1 Tx Power4	-3dBm	
OP_1 AGC Tx Power1	-14dBm	
OP_1 AGC Tx Power2	-14dBm	
OP_1 AGC Tx Power3	-14dBm	
OP_1 AGC Tx Power4	-14dBm	
OP_1 Rx Alarm1	●	Disable
OP_1 Rx Alarm2	●	Disable
OP_1 Rx Alarm3	●	Disable
OP_1 Rx Alarm4	●	Disable
OP_1 Tx Alarm1	●	Disable
OP_1 Tx Alarm2	●	Disable
OP_1 Tx Alarm3	●	Disable
OP_1 Tx Alarm4	●	Disable
OP_2 FSK Tx Power	0dBm	

Annotations in the image include:

- A callout box labeled "Optical parameters" pointing to the table.
- A callout box labeled "Rx/Tx Alarm status" pointing to the alarm status column.
- A callout box labeled "Click to enable/disable alarm" pointing to the dropdown menu for the alarm status.

Figure 27: Optical Information – MU

The screenshot shows the web interface for device RU01. The top navigation bar includes 'Overview', 'Devices Alarm', '800MHz', '700MHz', and 'OP Info'. The main content area displays a table of optical information.

Item	Current Value	Config Value
OP Rx Power	-2.5dBm	
OP Tx Power	4dBm	
OP AGC Tx Power	-3dBm	
OP Rx Alarm	●	Disable
OP Tx Alarm	●	Disable

Buttons for 'Refresh' and 'Setting' are located below the table.

Figure 28: Optical Information – RU

5.2.2 [TOPOLOGY][FUNCTION]

Other parameters can be configured on the [Function] Screen. There are nine function bars list on the middle of the [Function] Screen.

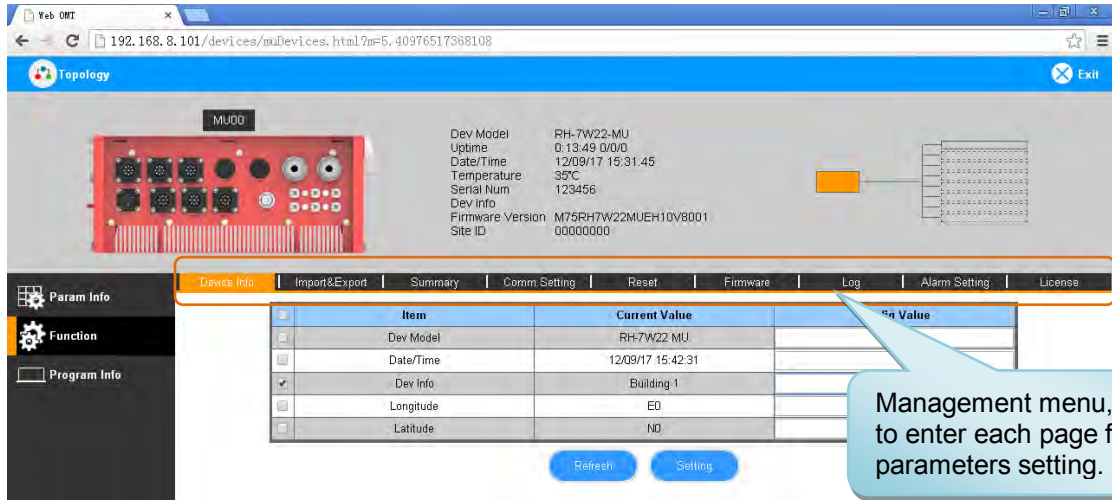

Figure 29: [Function] Screen

➤ Device Info

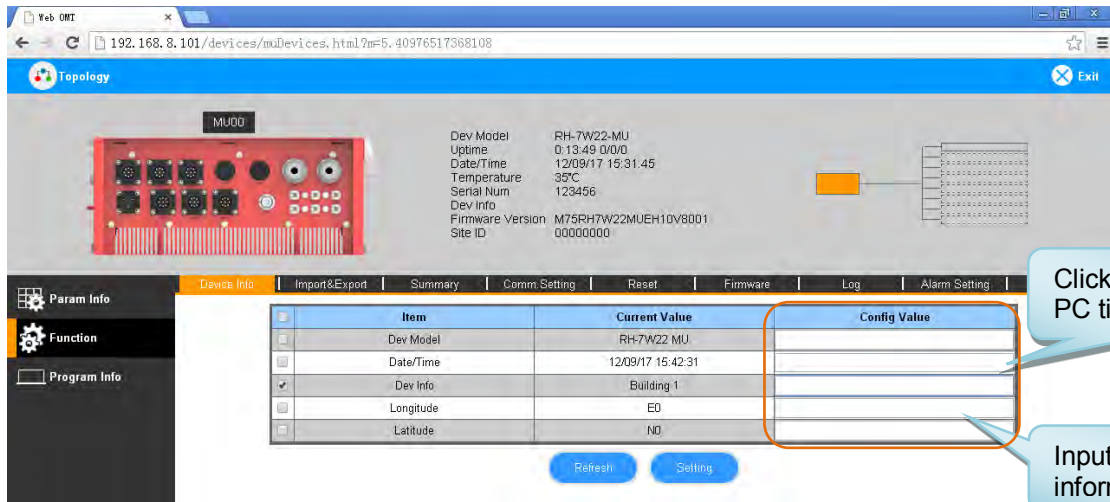

Figure 30: Function – Device Info

➤ Inport&Export

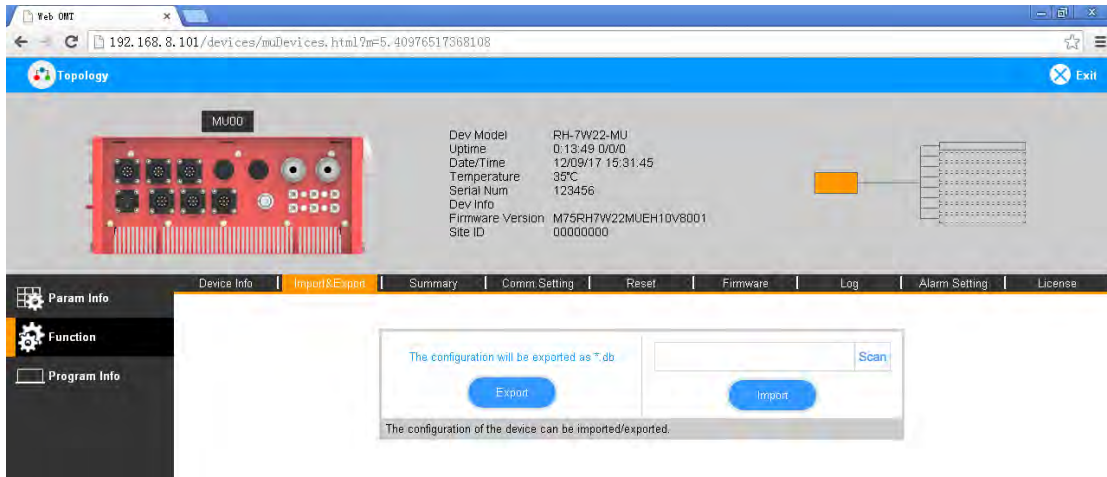

Figure 31: Function – Import & Export

The parameters that can be imported / exported include sub band, alarm enable, ATT value, RF switch, and DL output power.

This function can help users quickly configure PS DAS parameters. For example, if one PS DAS is finished configuration, users can export the parameters and save it as a file on the PC, and then import this file to other PS DASs for faster set up of additional PS DASs.

➤ Summary

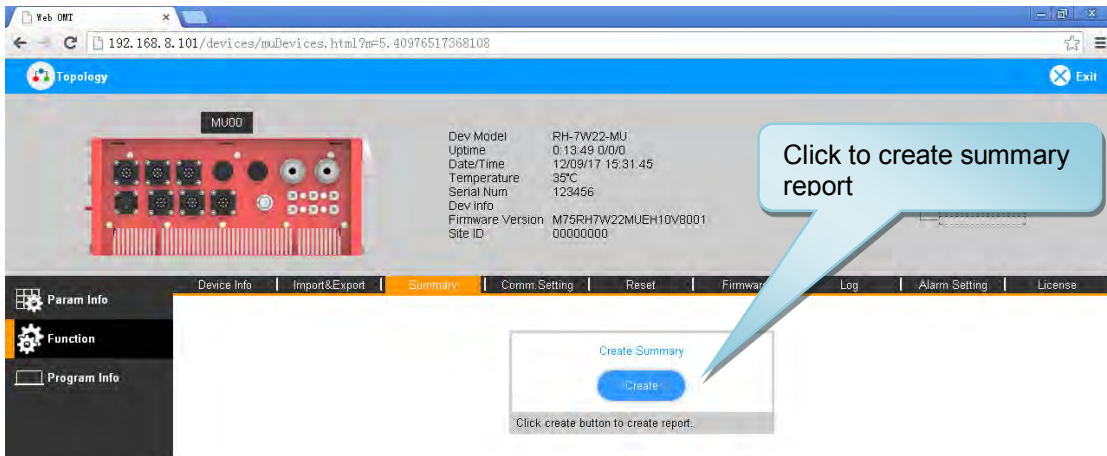

Figure 32: Function – Summary

Note: Click Create to create the report and make sure that PDF Reader software is installed on the computer. If not, the report will not be visible.

The device basic information, an overview of RF information and sub-band RF information are included in this report. Please refer to appendix D for an example of device report.

➤ **Comm. Setting**



Figure 33: Function – Comm. Setting

Note: There are 4 available communication types: SMS, PS, SNMP and ETHERNET. You can choose a suitable type for remote monitoring.

➤ **Reset**

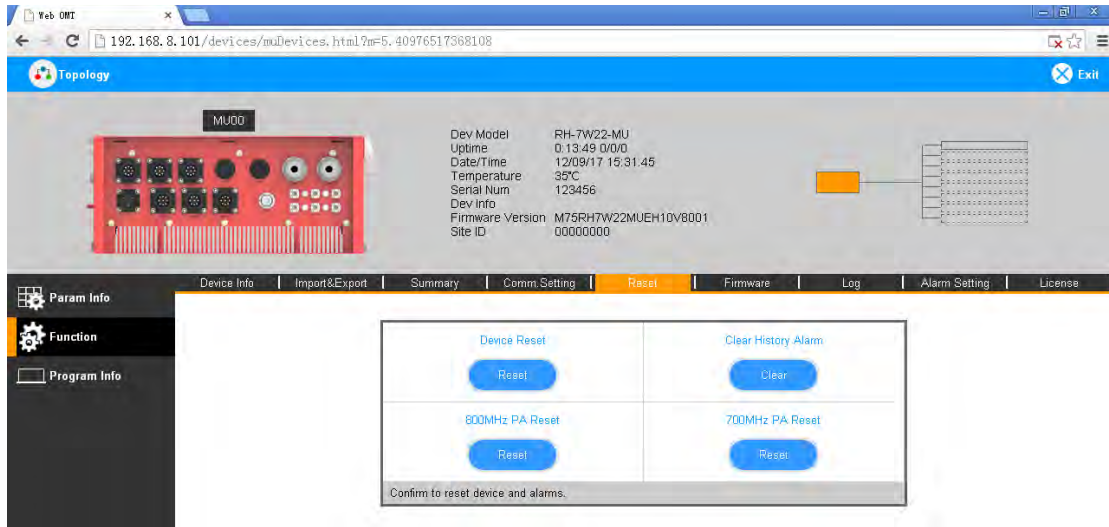

Figure 34: Function –Reset

Note: Click Next, all the parameters and alarms will be reset to factory default value. The Device Reset process will last about 2~4 minutes. For PMU monitor reset, users need to re-login to the WEB GUI.

➤ **Firmware**

There are two functions on the [Firmware] bar: [upgrade] and [swap]. [Upgrade] is used to upgrade software, and [Swap] is to replace the current firmware version with the previous one.

Follow the steps shown below figure to upgrade the firmware.

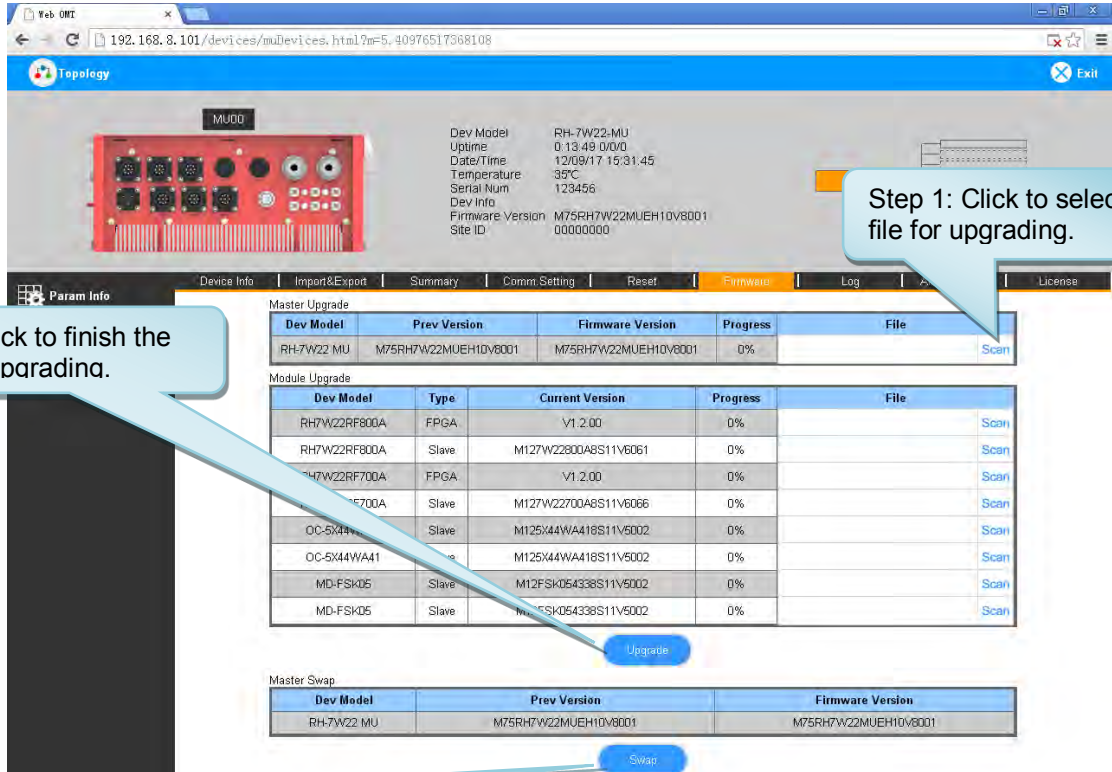

Figure 35: Function – Firmware Upgrade

➤ **Log**

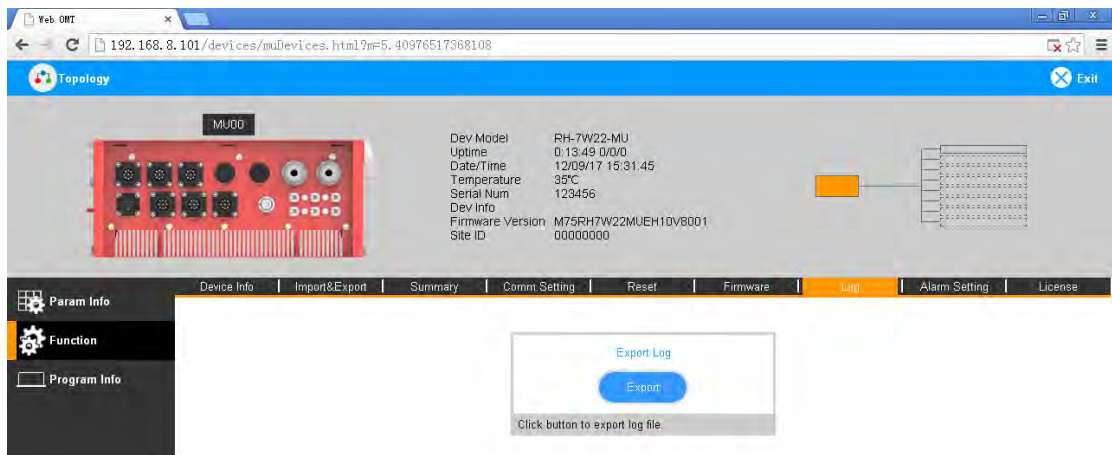

Figure 36: Function – Log

Note: Click Create to create the report (the report can't be created in IE browser) and make sure that PDF Reader software is installed on the computer. If not, the report will not be visible.

➤ Dry Contact

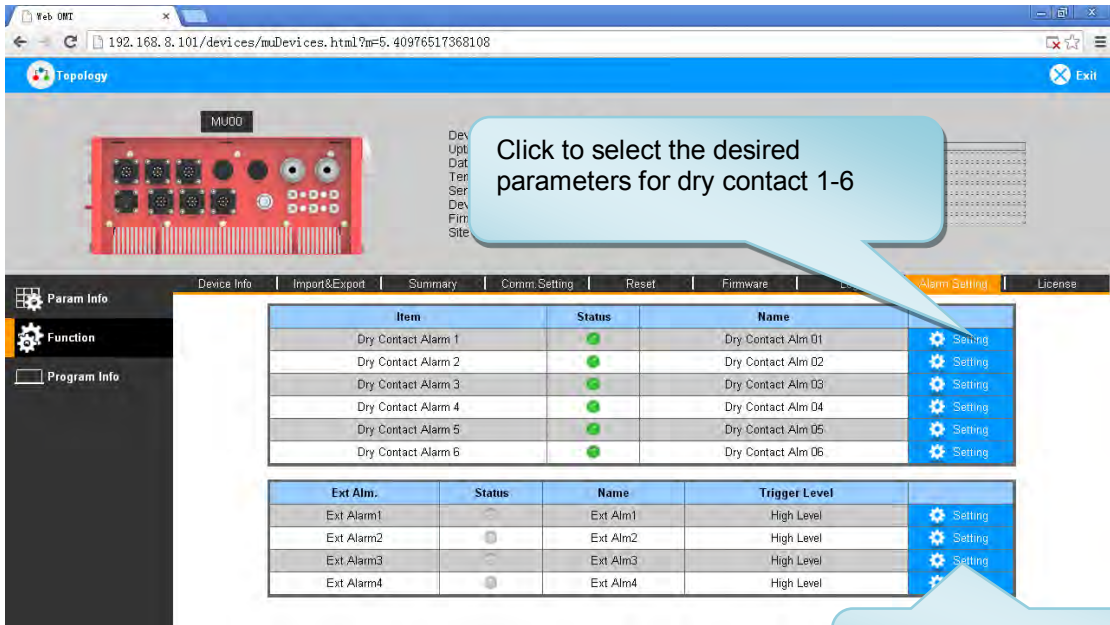

Figure 37: Function – Alarm Setting

Click to select the desired parameters for Ext Alarm 1-4

➤ License

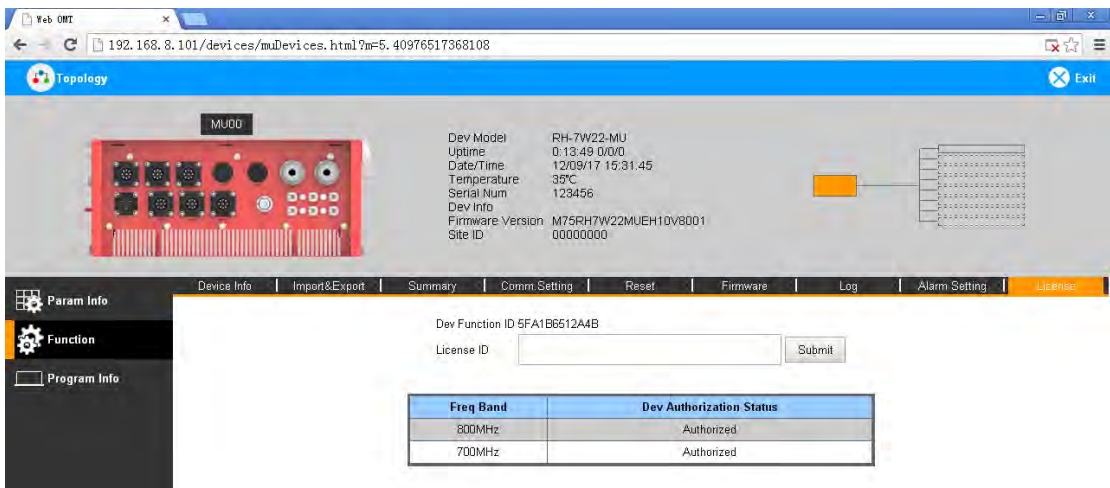

Figure 38: Function – License

For the CriticalPoint DAS, users are able to switch the configuration anytime by changing the license in the WEBOMT. There are 3 difference licenses: 700MHz single band license, 800MHz single band license and 700MHz/800MHz dual band license.

Both 700MHz and 800MHz single band licenses are provided with a single band unit. Users can switch between 700MHz configuration and 800MHz configuration. To upgrade from single band to dual band, users need to purchase the dual band upgrade license.

If the equipment is in dual band originally, no license will be provided, because the equipment already comes with dual band activated.

For more information please refer to appendix B for the license switch guide.

5.2.3 [TOPOLOGY][PROGRAM INFO]

This page is for factory setting only.



Figure 39: Program Information

5.2.4 [AUTO SETUP]

To complete the installation and commissioning, users need to follow the steps below.

Step 1: Click the Menu bar [Auto Setup] on home screen, a work flow will be displayed.

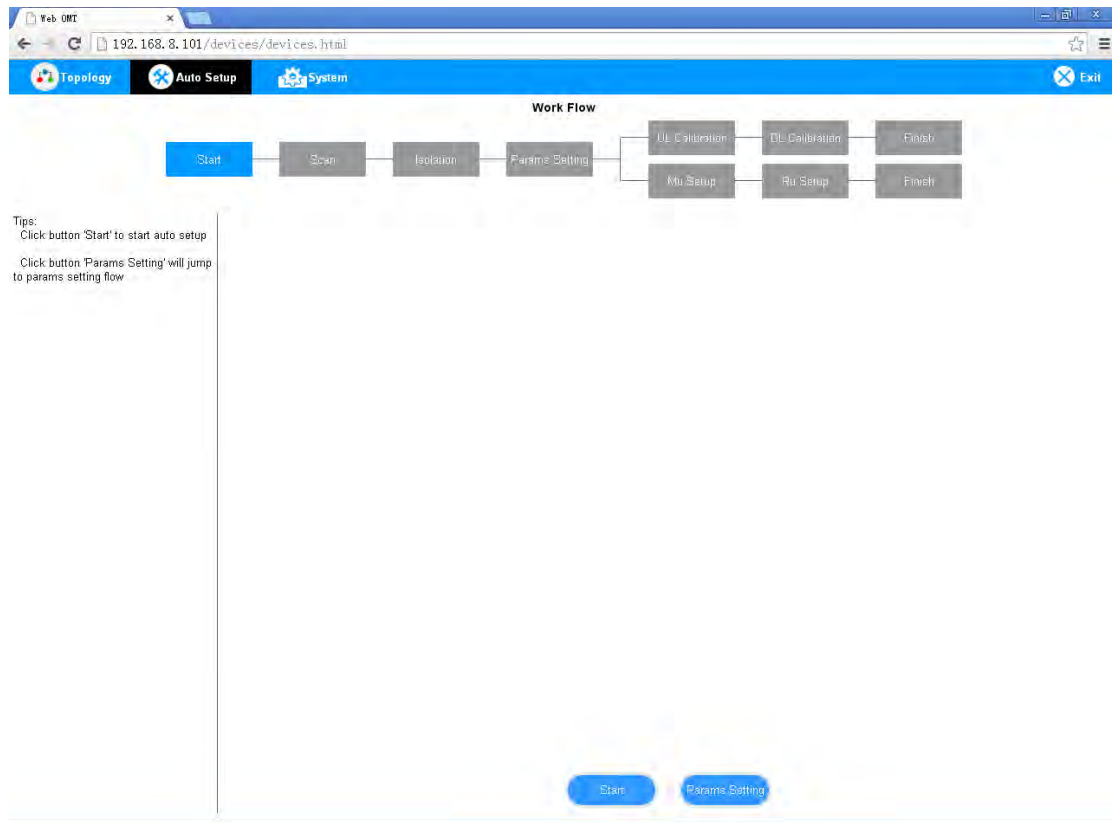

Figure 40: Commissioning Procedure – Start

Step 2: Click [Start] to start the process.

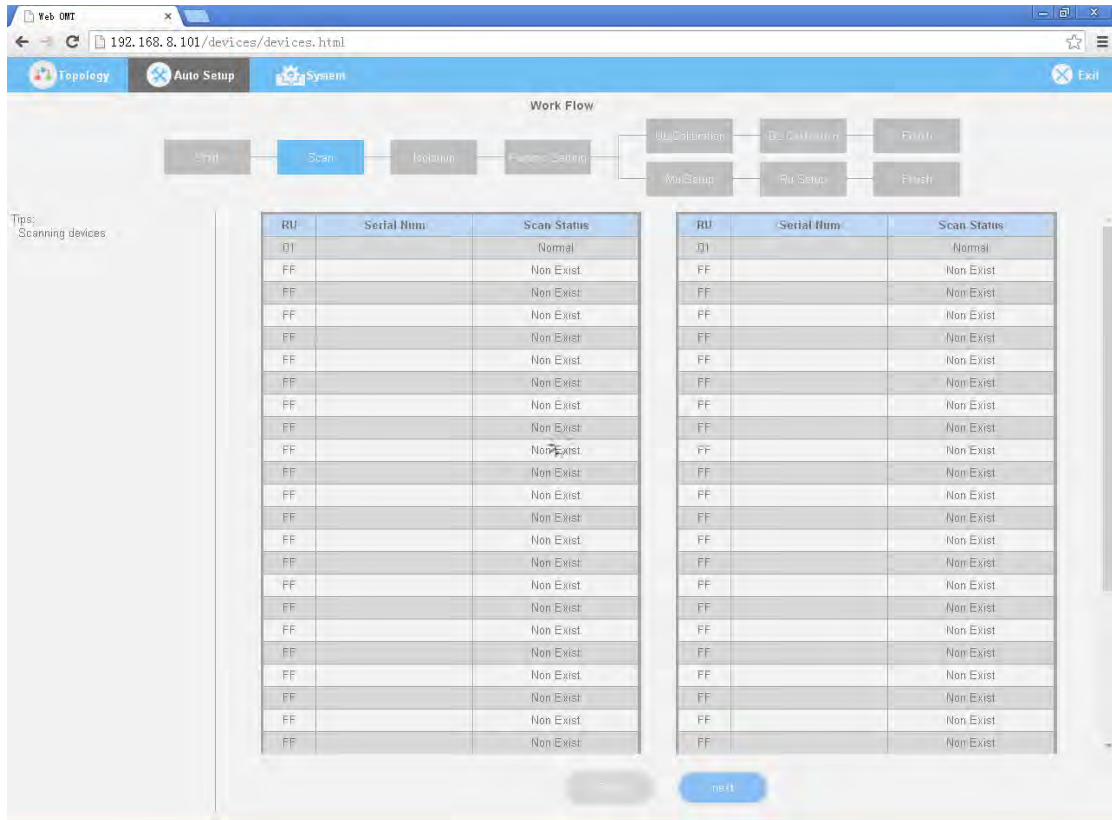

Figure 41: Commissioning Procedure – Scan

NOTE: Make sure the device is connected with appropriate donor and service antennas before proceeding to step 3.

Step 3: Click [Next] to enter to Isolation Detection Screen.

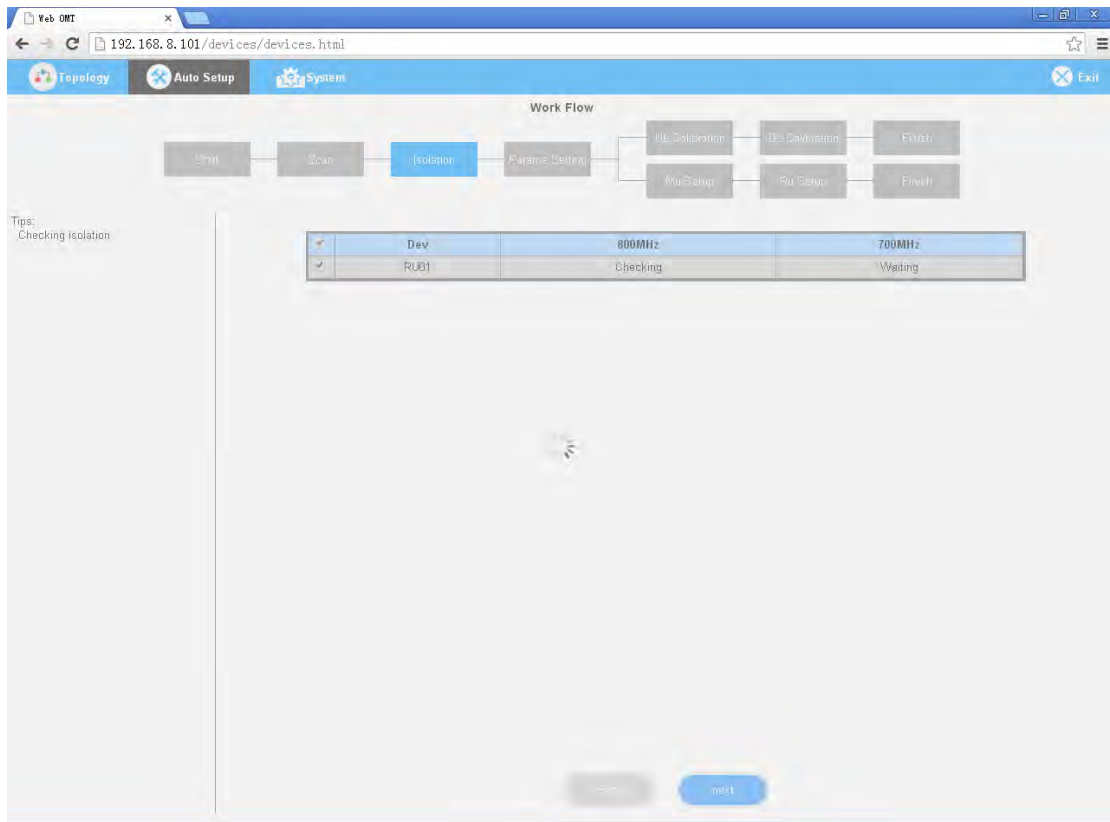

Figure 42: Commissioning Procedure – Isolation Detection

Step 4: Click [Next] to set the site information.

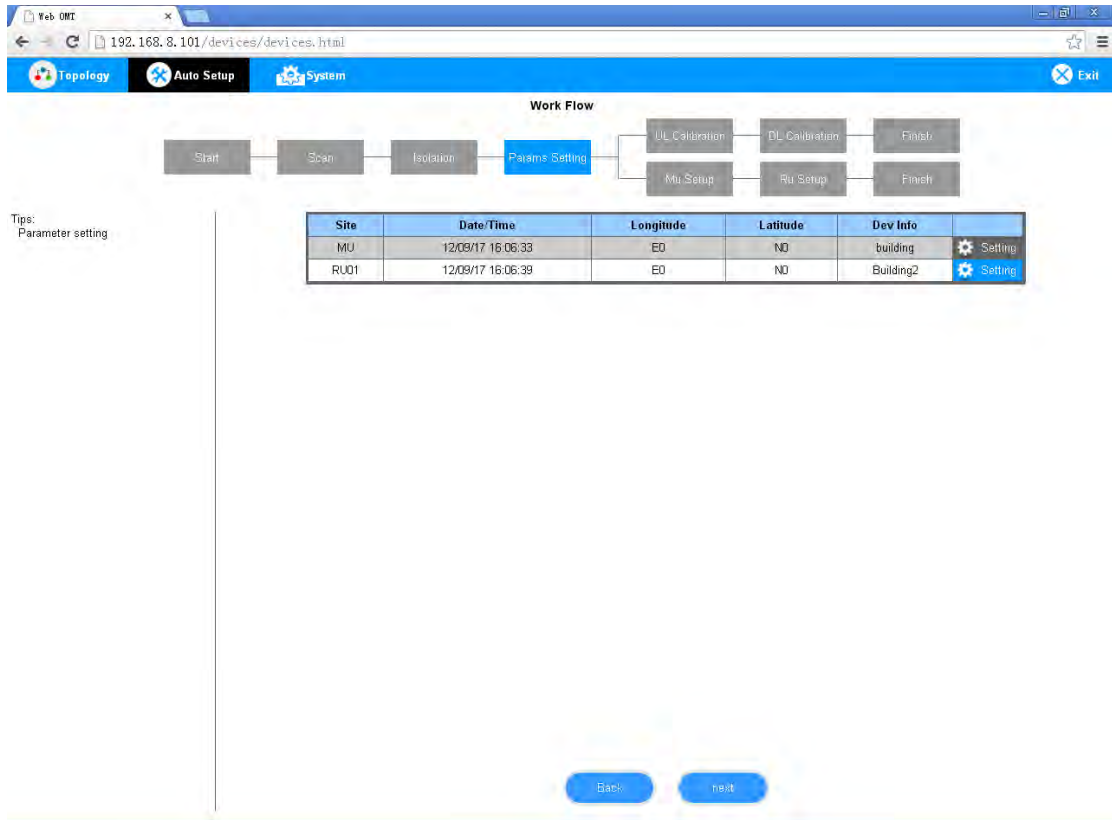

Figure 43: Device Information Setting

It is mainly used to record device location and Date/Time provides a time reference. Clicking the Config Value of Date/Time will update the Date/Time automatically.

Step 5: Click [MU Setup] to MU parameter setting.

Tip: MU setup

Sub Band	Switch	DL Gain	Center Freq	BandWidth	Setup
800MHz-CH1	OFF	60dB	852006.25kHz	12.5kHz	Setup
800MHz-CH2	OFF	60dB	852306.25kHz	12.5kHz	Setup
800MHz-CH3	OFF	60dB	852606.25kHz	12.5kHz	Setup
800MHz-CH4	OFF	60dB	852906.25kHz	12.5kHz	Setup
800MHz-CH5	OFF	60dB	853206.25kHz	12.5kHz	Setup
800MHz-CH6	OFF	60dB	853506.25kHz	12.5kHz	Setup
800MHz-CH7	OFF	60dB	853806.25kHz	12.5kHz	Setup
800MHz-CH8	OFF	60dB	854106.25kHz	12.5kHz	Setup
800MHz-CH9	OFF	60dB	854406.25kHz	12.5kHz	Setup
800MHz-CH10	OFF	60dB	854706.25kHz	12.5kHz	Setup
800MHz-CH11	OFF	60dB	855006.25kHz	12.5kHz	Setup
800MHz-CH12	OFF	60dB	855306.25kHz	12.5kHz	Setup
800MHz-CH13	OFF	60dB	855606.25kHz	12.5kHz	Setup
800MHz-CH14	OFF	60dB	855906.25kHz	12.5kHz	Setup
800MHz-CH15	OFF	60dB	856206.25kHz	12.5kHz	Setup
800MHz-CH16	OFF	60dB	856506.25kHz	12.5kHz	Setup
800MHz-CH17	OFF	60dB	856806.25kHz	12.5kHz	Setup
800MHz-CH18	OFF	60dB	857106.25kHz	12.5kHz	Setup
800MHz-CH19	OFF	60dB	857406.25kHz	12.5kHz	Setup
800MHz-CH20	OFF	60dB	857706.25kHz	12.5kHz	Setup
800MHz-CH21	OFF	60dB	858006.25kHz	12.5kHz	Setup
800MHz-CH22	OFF	60dB	858306.25kHz	12.5kHz	Setup
800MHz-CH23	OFF	60dB	858606.25kHz	12.5kHz	Setup

Figure 44: MU Parameter Setting

Step 6: Click [Next] to RU parameter setting.

Tip: RU setup

Sub Band	Switch	DL Gain	Center Freq	BandWidth	Setup
800MHz-CH1	OFF	60dB	852006.25kHz	12.5kHz	Setup
800MHz-CH2	OFF	60dB	852306.25kHz	12.5kHz	Setup
800MHz-CH3	OFF	60dB	852606.25kHz	12.5kHz	Setup
800MHz-CH4	OFF	60dB	852906.25kHz	12.5kHz	Setup
800MHz-CH5	OFF	60dB	853206.25kHz	12.5kHz	Setup
800MHz-CH6	OFF	60dB	853506.25kHz	12.5kHz	Setup
800MHz-CH7	OFF	60dB	853806.25kHz	12.5kHz	Setup
800MHz-CH8	OFF	60dB	854106.25kHz	12.5kHz	Setup
800MHz-CH9	OFF	60dB	854406.25kHz	12.5kHz	Setup
800MHz-CH10	OFF	60dB	854706.25kHz	12.5kHz	Setup
800MHz-CH11	OFF	60dB	855006.25kHz	12.5kHz	Setup
800MHz-CH12	OFF	60dB	855306.25kHz	12.5kHz	Setup
800MHz-CH13	OFF	60dB	855606.25kHz	12.5kHz	Setup
800MHz-CH14	OFF	60dB	855906.25kHz	12.5kHz	Setup
800MHz-CH15	OFF	60dB	856206.25kHz	12.5kHz	Setup
800MHz-CH16	OFF	60dB	856506.25kHz	12.5kHz	Setup
800MHz-CH17	OFF	60dB	856806.25kHz	12.5kHz	Setup
800MHz-CH18	OFF	60dB	857106.25kHz	12.5kHz	Setup
800MHz-CH19	OFF	60dB	857406.25kHz	12.5kHz	Setup
800MHz-CH20	OFF	60dB	857706.25kHz	12.5kHz	Setup
800MHz-CH21	OFF	60dB	858006.25kHz	12.5kHz	Setup
800MHz-CH22	OFF	60dB	858306.25kHz	12.5kHz	Setup
800MHz-CH23	OFF	60dB	858606.25kHz	12.5kHz	Setup

Figure 45: RU Parameter Setting

Step 7: Select [Finish] and click [OK] to finish commissioning.

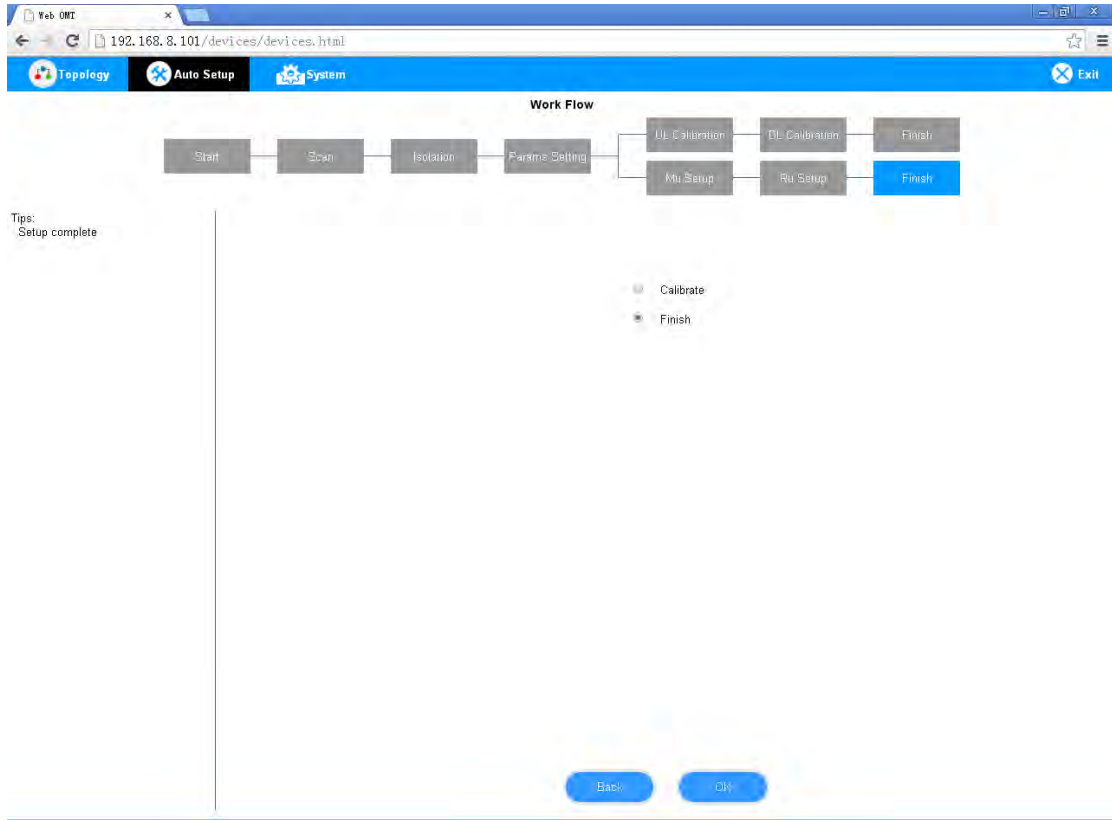

Figure 46: Finish

5.2.5 [SYSTEM]

➤ Inport&Export



Figure 47: System – Import & Export

Here can be imported / exported both MU and RU parameters.

The parameters that can be imported / exported include sub band, alarm enable, ATT value, RF switch, and DL output power.

➤ **Summary**



Figure 48: System – Summary

Here can create both MU and RU summary report.

The device basic information, an overview of RF information and sub-band RF information are included in this report.

➤ **Scan**

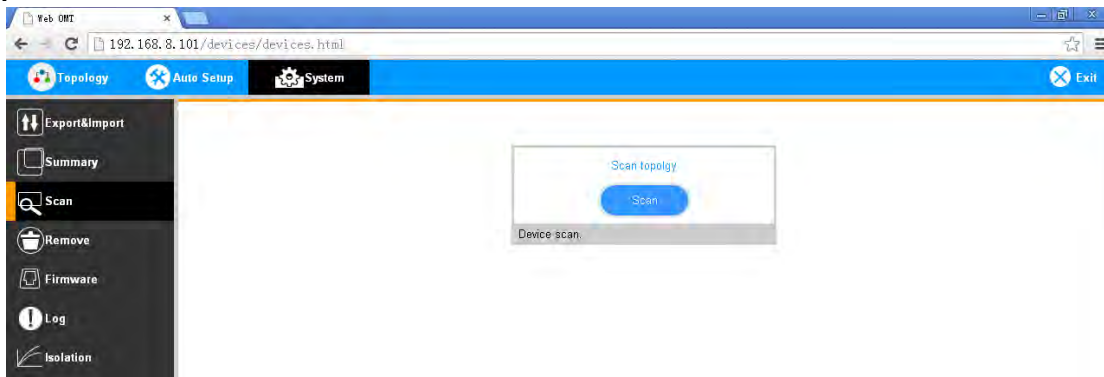

Figure 49: System – Scan

Here can scan the all the system equipment quantities.

➤ **Reset**



Figure 50: System – Remove

Here can remove RUs.

➤ **Firmware**



Figure 51: System – Firmware

Here can upgrade both MU and RU firmware, and swap them.

➤ **Log**

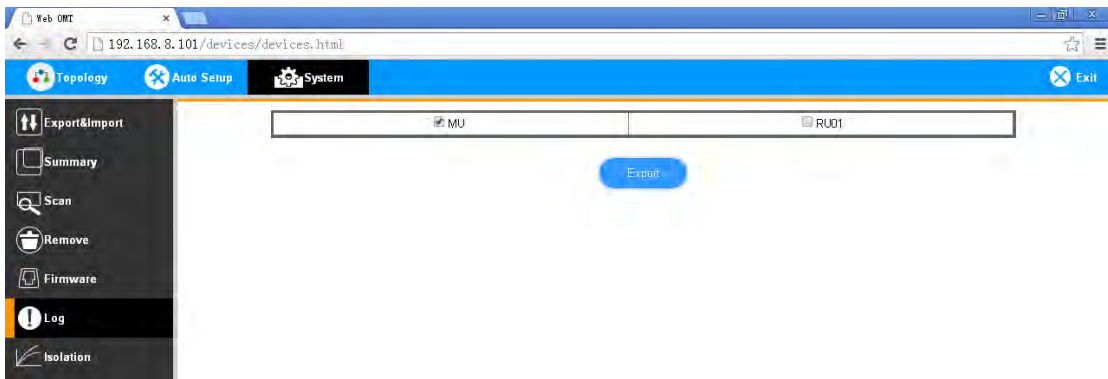

Figure 52: System – Log

Here can export both MU and RU log report.

➤ **Isolation**



Figure 53: System – Isolation

Here can check different RUs isolation.

End of Section

6 MAINTENANCE

The PS DAS is designed for trouble-free operation and generally does not need maintenance. Maintenance activities should only be carried out by trained personnel.

Periodic inspection of the repeater equipment(s) is recommended, the recommended tasks includes:

- Verify the direction and position of antennas. Re-align if necessary.
- Make sure the cable connector and sealing on the RF cable connectors are not damaged.
- Verify lightning and grounding protection is in good condition.

End of Section

7 APPENDICES

7.1 APPENDIX A: TOOLS

The following are the recommended list of tools for new installation and routine maintenance.

- Slotted Screwdriver
- Philips Screwdriver
- Ring Spanner (Assorted size: 12~20mm)
- Electrically operated drill and masonry drill bits \varnothing 12mm
- Anti-static Wrist Strap
- Side Cutter
- Frequency Counter (e.g. FLUKE PM6685R)
- RF Power Meter (e.g. Bird 5000)

7.2 APPENDIX B: DECLARATION OF HARMFUL SUBSTANCES AND CONTENT

Product Name: Public Safety BDA

Model: RX-7W22

Harmful substance and content of this product as below table shown:

Part Name	Harmful Substance					
	Pb	Hg	Cd	Cr (VI)	PBB	PBDE
A	×	○	○	○	○	○
B	×	○	○	○	○	○

Note: Above table complies with SJ/T 11364.

○: Indicates that the harmful substance content in all homogeneous materials for corresponding part is under the limited requirement of GB/T 26572.

×: Indicates that the harmful substance content in at least one single homogeneous material for the corresponding part exceeds the limited requirement of GB/T 26572.

Remark: The content of the parts marked with “×” above exceeds the requirement as there is still no mature alternative technologies to achieve the replacement of poisonous and harmful materials or elements.

7.3 APPENDIX C: LICENSE SWITCH QUICK GUIDE

For CriticalPoint DAS, users are able to switch the configuration anytime by changing the license in the WEBOMT. There are 3 difference licenses: 700MHz single band license, 800MHz single band license and 700MHz/800MHz dual band license.

Both 700MHz and 800MHz single band licenses are provided with a single band unit. Users can switch between 700MHz configuration and 800MHz configuration. To upgrade from single band to dual band configurations, users need to purchase the dual band upgrade license..

If the equipment is in dual band originally, no license will be provided, because the equipment already comes with dual band activated.

Please follow the steps to switch configuration by license:

Step 1: Connect the unit “OMT port” to a laptop with an Ethernet cable.

Step 2: Wait approximately 1 minute until the IP address is established. Open the browser (Firefox is recommended), login to WEBGUI with: www.combaomt.com or 192.168.8.101.

Step 3: Input User Name: admin; Password: (default: admin). Click [Log in].

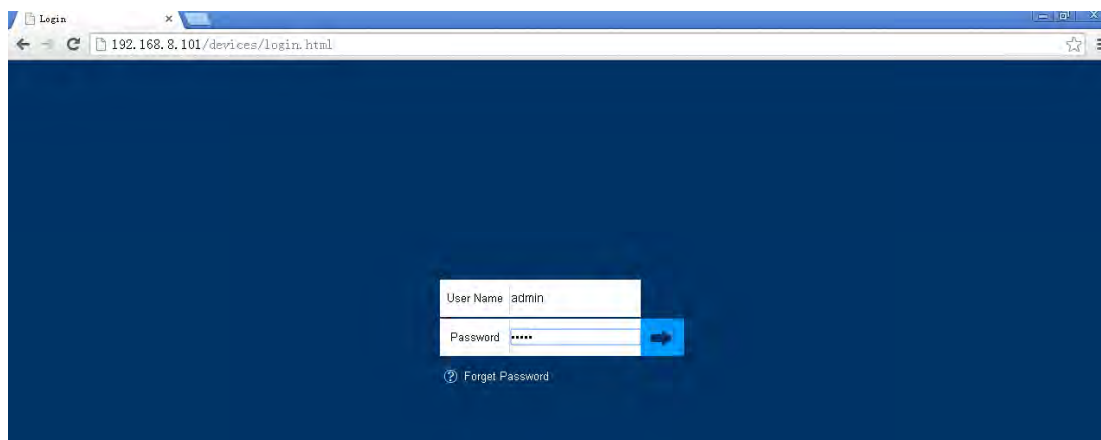

Figure 54: Input User Name and Password

Step 4: Go to Function -> License as shown in figure blow. Input the license code in the License field and click submit to continue. The license code is presented as a label on the equipment.

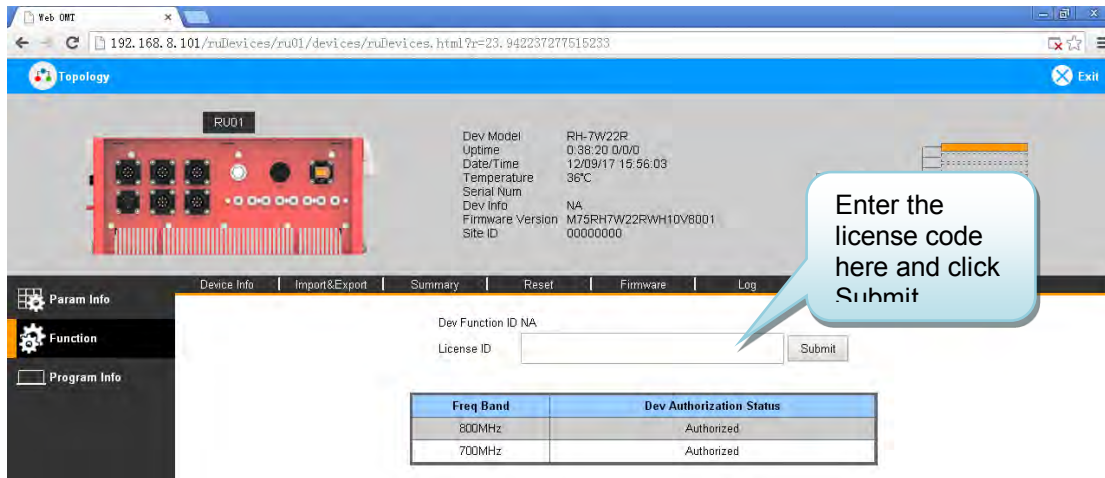

Figure 55: Input License Code

Step 5: Refresh the page from the browser, and if the Dev Authorization Status shows the specific band is authorized, it means the license switch was successful.

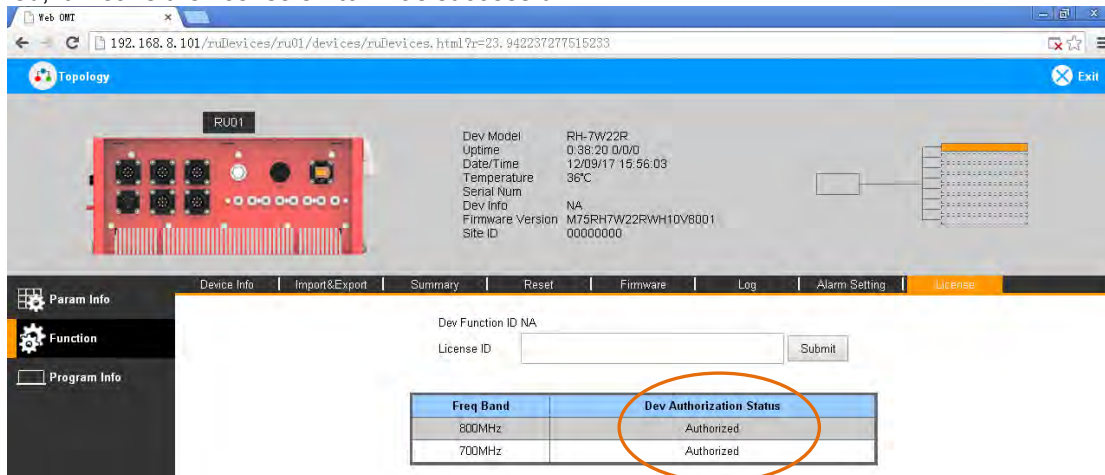



Figure 56: License switch success

7.4 APPENDIX D: RMA (RETURN MATERIAL AUTHORIZATION)



Comba Telecom Ltd.
 611 East Wing, No. 8 Science Park West Avenue, Hong Kong Science Park, Tai Po, Hong Kong
 Tel: +852 2636 6861 Fax: +852 2637 0966

RMA Request Form
 Date: _____

From: _____
 Address: _____
 Tel: _____ Fax: _____
 E-Mail: _____
 ATTN: _____

Product Information:

Item	Model	Serial Number	Return Category	Qty	Problem Description
1					
2					
3					
4					
5					
6					
7					
8					
9					
10					

Notes:
 1. For 'Return Category' column, please select from **A**: Return of Defective Product, **B**: Return of Trial Sample, or **C**: Return of New and Unused Product.
 2. If **A** or **C** category of return product is chosen, please give short description of the problem or reason for returning.

Transportation Information:
 Location of Product: _____
 Transportation Method: _____
 Shipping Forwarder: _____

Note: Location of Product must be stated, while 'Transportation Method' or 'Shipping Forwarder' can be left blank if not determined.

Signature:

For Comba Use (Only)
 Return Merchandise Authorization Number (RMA#): _____
 Recommended Action: _____
 Shipment and Handling Cost to be paid by: _____

Approved by: _____

Date: _____

End of Section

End of Document



Comba Telecom Inc.

235 Charcot Ave, San Jose, CA 95131, USA

Tel: +1 866 802 7961

Fax: +1 408 526 0181

Email: customer.nam@comba-telecom.com

www.combausea.com