

**Comba**

**mBDA-200**

# **BAND SELECTIVE WIRELESS REPEATER**

**USER MANUAL**

**MBDA-200 QE: 1-0-0**

**Comba Telecom Ltd.**

**The information contained herein is the responsibility of and is approved by the following, to whom all enquiries should be directed in the first instance:**

**This is an unpublished work the copyright in which vests in Comba International ("Comba"). All rights reserved.**

**The information contained herein is confidential and the property of Comba and is supplied without liability for errors or omissions. No part may be reproduced, disclosed or used except as authorised by contract or other written permission. The copyright and the foregoing restriction on reproduction and use extend to all media in which the information may be embodied.**

## 0.1 CONTENTS

Section	Page
0.1 CONTENTS .....	3
0.2 INDEX TO FIGURES AND TABLES .....	5
0.3 HISTORY .....	7
0.4 GLOSSARY OF TERMS.....	8
0.5 SAFETY NOTICES AND ADMONISHMENTS.....	8
1 GENERAL INFORMATION .....	10
2 EQUIPMENT DESCRIPTION.....	11
2.1 SYSTEM DIAGRAM.....	11
2.2 EQUIPMENT LAYOUT .....	12
2.3 EQUIPMENT CONSTITUTION.....	13
2.4 KIT OF PART .....	13
3 INSTALLATION .....	14
3.1 WARNINGS AND ALERTS.....	14
3.2 SITE PLANNING CONSIDERATIONS.....	15
3.3 INSTALLATION PROCEDURES .....	16
3.4 EQUIPMENT CONNECTORS .....	25
3.5 EQUIPMENT CONNECTION .....	28
4 COMMISSIONING .....	30
4.1 PRE-COMMISSIONING TASKS.....	30
4.2 LED INDICATORS.....	30
4.3 COMMISSIONING PROCEDURE .....	31
5 WEB GUI .....	33
5.1 WEB GUI CONNECTION.....	33
5.2 WEB GUI INTRODUCTION .....	34
5.2.1 [DEVICES].....	34
5.2.2 [COMMISSIONING] .....	37
5.2.3 [FIRMWARE] .....	38
5.2.4 [MANAGEMENT].....	39
5.3 COMMISSIONING PROCEDURE .....	45
6 MAINTENANCE .....	52

**7 APPENDICES ..... 53**

**7.1 APPENDIX A: TOOLS FOR INSTALLATION AND MAINTENANCE..... 53**

**7.2 APPENDIX B: RMA (RETURN MATERIAL AUTHORIZATION) ..... 54**

## 0.2 INDEX TO FIGURES AND TABLES

Figure 1: mBDA-200.....	10
Figure 2: System Diagram.....	11
Figure 3: Layout of mBDA.....	12
Figure 4: mBDA Screen.....	17
Figure 5: mBDA Rack.....	18
Figure 6: Remove Cover Plates.....	18
Figure 7: PMU Installation.....	19
Figure 8: RF Unit Installation.....	19
Figure 9: mBDA Installation Finish.....	20
Figure 10: Equipment Cabinet with Pallet.....	21
Figure 11: mBDA Installation.....	21
Figure 12: Secure the Screws.....	22
Figure 13: Finish Installaiton.....	22
Figure 14: Mounting Rack.....	23
Figure 15: Angle Iron Installation.....	23
Figure 16: mBDA Installation.....	24
Figure 17: Secure the Enclosure.....	24
Figure 18: Finish Installaiton.....	25
Figure 19: mBDA Front Panel Connectors.....	26
Figure 20: mBDA Rear Panel Connectors.....	26
Figure 21: mBDA Grounding (mBDA Rear Panel).....	28
Figure 22: mBDA Power Connection (Rear Panel).....	29
Figure 23: Pins Allocation for "EXT_ALM" Port for mBDA.....	29
Figure 24: Commissiong Flow Chart.....	31
Figure 25: PC IP Address Setting.....	33
Figure 26: Input IP Address.....	33
Figure 27: Input Domain Name.....	33
Figure 28: Input User Name and Password.....	34
Figure 29: Web GUI Main Screen.....	34
Figure 30: [Devices] Sceen.....	35
Figure 31: Power & Monitoring Unit.....	35
Figure 32: RF Unit.....	36
Figure 33: RF Unit Detail Information.....	37
Figure 34: [Commissioning] Screen.....	37
Figure 35: [Firmware] Screen – Upgrade.....	38
Figure 36: [Firmware] Screen – Pop-up Window 1.....	38
Figure 37: [Firmware] Screen - Swap.....	39
Figure 38: [Management] Sceen.....	39
Figure 39: Management – Import&Export.....	40
Figure 40: Management – IP Setting.....	41
Figure 41: Management – SNMP Setting.....	41
Figure 42: Management – Security.....	42
Figure 43: Modify Password.....	42
Figure 44: Management – Device Reset.....	43
Figure 45: Management – PA Reset.....	43
Figure 46: Management – Device Info.....	44
Figure 47: Management – Isolation.....	44
Figure 48: Management – Report.....	45
Figure 49: Commissioning Procedure - Start.....	45
Figure 50: Commissioning Procedure – Site Info. Setting.....	46
Figure 51: Dev Info & Date/Time.....	46
Figure 52: Commissioning Procedure – Isolation Detective.....	47
Figure 53: Commissioning Procedure – Isolation Detective Confirm.....	47

Figure 54: Commissioning Procedure –Isolation Detection Failed.....47  
Figure 55: Commissioning Procedure –Isolation Detection Finish.....48  
Figure 56: Commissioning Procedure – Subband bandwidth and Switch Setting .....49  
Figure 57: Commissioning Procedure – DL Output Power Setting Screen .....49  
Figure 58: Commissioning Procedure – DL Output Power Setting .....50  
Figure 59: DL Output Power Over Exceed .....50  
Figure 60: Commissioning Procedure – Finish .....51

Table 1: mBDA Components ..... 13  
Table 2: KOP ..... 13  
Table 3: mBDA Connections.....26  
Table 4: Pin Definition of “EXT\_ALM” Port for mBDA .....29  
Table 5: LED Indications.....30  
Table 6: Commissioning Procedure ..... 32

### 0.3 HISTORY

Change No.	ENU	Details Of Change
1	1-0-0	This user manual first created in Jan 2014.

## 0.4 GLOSSARY OF TERMS

ALC	Automatic Level Control
ATT	Attenuation
BDA	Bi-direction Amplifier
BS	Base Station
BTS	Base Transceiver Station
DL	Downlink
DT	Donor Terminal
FOU	Fiber Optical Unit
GUI	Graphic User Interface
ID	Identification
LNA	Low Noise Amplifier
MCU	Main Control Unit
MT	Mobile Terminal
MTBF	Mean Time Between Failures
MBDA	Master Unit
NC	Normally Closed
NF	Noise Figure
NO	Normally Open
OMC	Operation & Maintenance Center
OMT	Operation & Maintenance Terminal
PA	Power Amplifier
POI	Point of Interconnects
PSU	Power Supply Unit
RF	Radio Frequency
RFU	Radio Frequency Unit
RU	Remote Unit
SMA	Sub-Miniature "A" Connector
TX/RX	Transmit/Receive
UL	Uplink
VAC	Volts Alternating Current
VSWR	Voltage Standing Wave Ratio
WCDMA	Wideband Code Division MBDAItriple Access

## 0.5 SAFETY NOTICES AND ADMONISHMENTS

This document contains safety notices in accordance with appropriate standards. In the interests of conformity with the territory standards for the country concerned, the equivalent territorial admonishments are also shown.



Any installation, adjustment, maintenance and repair of the equipment must only be carried out by trained, authorized personnel. At all times, personnel must comply with any safety notices and instructions.

Specific hazards are indicated by symbol labels on or near the affected parts of the equipment. The labels conform to international standards, are triangular in shape, and are coloured black on a yellow background. An informative text label may accompany the symbol label.

Hazard labeling is supplemented by safety notices in the appropriate equipment manual. These notices contain additional information on the nature of the hazard and may also specify precautions.

**WARNING!** This is **NOT** a **CONSUMER** device. It is designed for installation by **FCC LICENSEES** and **QUALIFIED INSTALLERS**. You **MUST** have an **FCC LICENSE** or express consent of an FCC License to operate this device. Unauthorized use may result in significant forfeiture penalties, including penalties in excess of \$100,000 for each continuing violation.

**Note:** The grantee is not responsible for any changes or modifications not expressly approved by the party responsible for compliance. Such modifications could void the user's authority to operate the equipment.

This device complies with Part 15 of the FCC Rules. Operation is subject to the following two conditions: (1) this device may not cause harmful interference, and (2) this device must accept any interference received, including interference that may cause undesired operation.

For compliance with the general population RF exposure limits, each individual antenna used for this transmitter must be installed to provide a separation distance greater than 41.4986cm or more from all persons during normal operation and must not be co-located with any other antenna for meeting RF exposure requirements.

**Alert:**

These draw the attention of personnel to hazards that may cause damage to the equipment. An example of use is the case of static electricity hazard.

Caution notices may also be used in the handbook to draw attention to matters that do not constitute a risk of causing damage to the equipment but where there is a possibility of seriously impairing its performance, e.g. by mishandling or gross maladjustment. Warnings and Cautions within the main text do not incorporate labels and may be in shortened form.

The application antenna and RF cable are not provided. The antenna gain should not exceed 10 dBi.

End of Section

## 1 GENERAL INFORMATION

The mBDA-200 Band Selective Wireless Repeater is designed for operation in 850MHz and 1900MHz networks. Digital band-specific linear amplifier amplifies the desired BTS carriers and provides superior out-of-band rejection. Typical units with adjustable bandwidth are programmed to specific requirements of the network. Remote configuration and surveillance is possible through Comba's remote control and monitoring system, via PC or wireless modem to the OMC.

### Main feature:

mBDA-200 is a high quality repeater with the following features:

- Supports GSM, CDMA and WCDMA operating.
- Supports multi operator configurations and up to 3 sub bands per band.
- Adjustable sub band via OMT software.
- Friendly and easy Web OMT interface via RJ45 connection.
- Integrated network card for remote configuration, monitoring and control.

The figure below shows the enclosure.



Figure 1: mBDA-200

NOTE: RF module is slot independent.

End of Section

## 2 EQUIPMENT DESCRIPTION

### 2.1 SYSTEM DIAGRAM

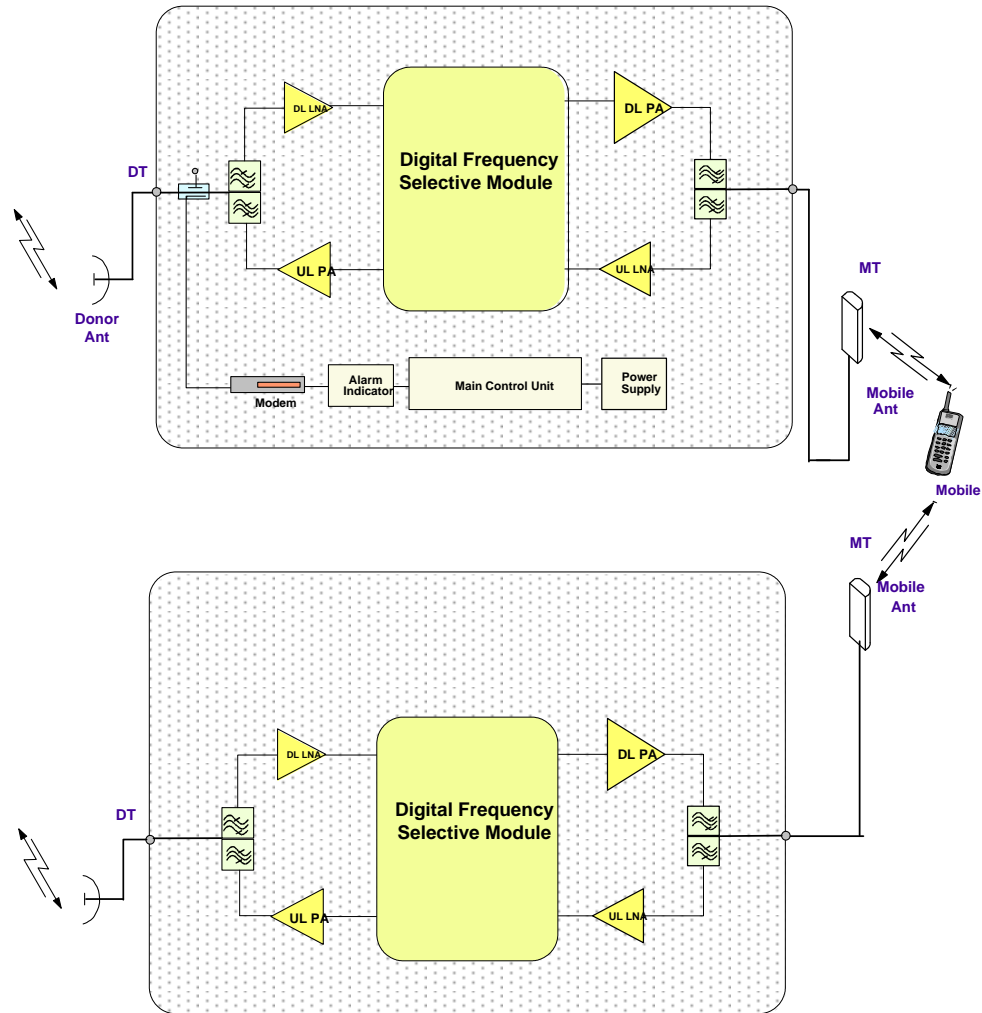

Figure 2: System Diagram

In the downlink, the BTS signals are received by donor antenna of the repeater. After the duplexer, the signals are sent to the LNA module for pre-amplification and digital RF integrated module for digital filtering and frequency conversion. Then the DL signals will be sent to downlink PA to amplify power and filter via duplexer. After amplification, the signals are transmitted via the MT port to the service antenna.

In the uplink, the mobile signals are received by the service antenna. After the MT port integrated duplexer, the signals are sent to the LNA, integrated module for digital filtering, then to PA for power amplification and to duplexer. After that, the uplink signals are sent to the donor antenna for transmission back to the BTS.

2.2 EQUIPMENT LAYOUT

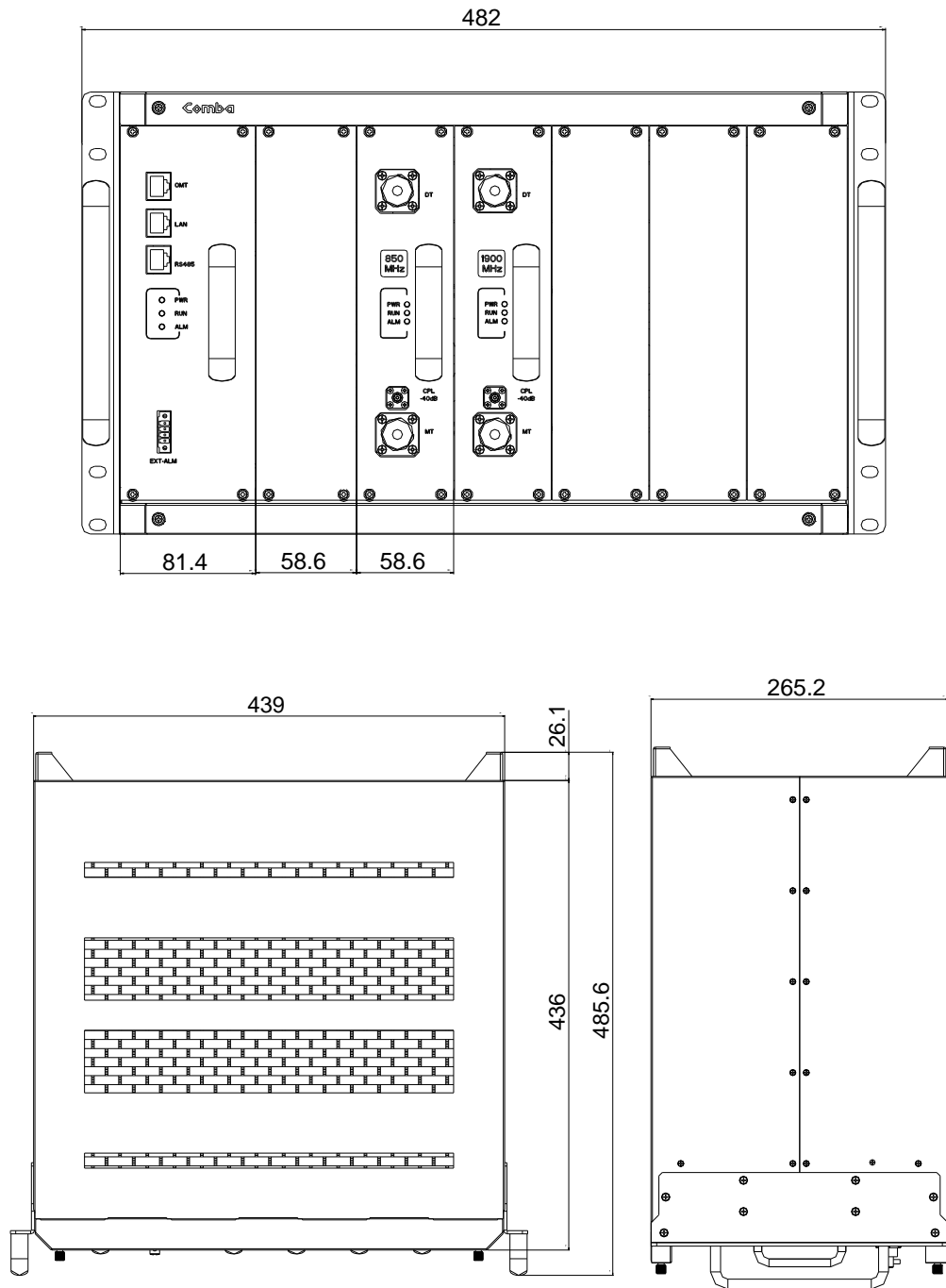

Figure 3: Layout of mBDA

## 2.3 EQUIPMENT CONSTITUTION



mBDA consists of the following parts:

Table 1: mBDA Components

Module	Description
mBDA-RACK	There are total 7 slots in the main chassis, where six slots for RF Units and Combiner Units, rest-one slot for Power & Monitoring Unit.
mBDA-PMU	Power & Monitoring Unit (PMU) converts the input voltage into stable DC to supply power for each RF module and provides monitor control.
mBDA-RFU	RF Unit processes UL/DL signal and amplifies the signal for coverage.

## 2.4 KIT OF PART

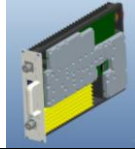
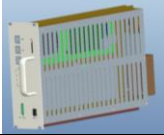
Table 2: KOP

Item	Qty	Image
Rack	1	
RF Unit (RFU) <b>(Packing separately)</b>	1~2	
Power & Monitoring Unit (PMU) <b>(Packing separately)</b>	1	
Power Supply Cable (13 Feet 1 inch)	1	
Communication Cable	1	

End of Section

## 3 INSTALLATION

### 3.1 WARNINGS AND ALERTS

#### Radio Frequency Energies

There may be situations, particularly for workplace environments near high-powered RF sources, where recommended limits for safe exposure of human beings to RF energy could be exceeded. In such cases, restrictive measures or actions may be necessary to ensure the safe use of RF energy.

#### High Voltage

The equipment has been designed and constructed to prevent practicable danger, as far as reasonably possible. Any work activity on or near equipment involving installation, operation or maintenance must be free from danger, as far as reasonably possible.

Where there is a risk of damage to electrical systems involving adverse weather, extreme temperatures, wet, corrosive or dirty conditions, flammable or explosive atmospheres, the system must be suitably installed to prevent danger.

#### Protective Earthing

For the purpose of protecting individuals from electrical risk, the equipment provided must be safety in design and properly maintained and used.

#### Handling Precautions

This covers a range of activities including lifting, lowering, pushing, pulling, carrying, moving, holding or restraining an object or person. It also covers activities that require the use of force or effort, such as pulling a lever, or operating power tools.

#### Electrostatic Discharge (ESD)

Observe standard precautions for handling ESD-sensitive devices. Assume that all solid-state electronic devices are ESD-sensitive. Ensure the use of a grounded wrist strap or equivalent while working with ESD-sensitive devices. Transport, store, and handle ESD-sensitive devices in static-safe environments.

## 3.2 SITE PLANNING CONSIDERATIONS

### 3.2.1 SITE PLANNING

#### Site Considerations

There may be situations, particularly for workplace environments near high-powered RF sources, where recommended limits for safe exposure of human beings to RF energy could be exceeded. In such cases, restrictive measures or actions may be necessary to ensure the safe use of RF energy.

#### Installation Location

Mounting surface shall be capable of supporting the weight of the equipment.

In order to avoid electromagnetic interference, a proper mounting location must be selected to minimize interference from electromagnetic sources such as large electrical equipment.

#### Environmental

Humidity has an adverse effect on the reliability of the equipment. It is recommended to install the equipment in locations having stable temperature and unrestricted air-flow.

The installation location for the system should be well ventilated. The equipment has been designed to operate at the temperature range and humidity level as stated in the product specifications.

#### Powering

The power & monitoring unit (PMU) provides power to all modules within the equipment. Depending on the product variant, it is recommended that the PMU operates on a dedicated AC circuit breaker or fused circuit.

#### Grounding Requirement

Verify that the equipment has been well grounded. This includes antennas and all cables connected to the system. Ensure lightning protection for the antennas is properly grounded.

#### Cable Routing

Depending on equipment configuration, a variety of types of cables are connected to the equipment: coaxial cables, power cable, communication cable, and commissioning cable. Where applicable, ensure cables are properly routed and secured so that they are not damaged.

#### Manual Handling

During transportation and installation, take necessary handling precautions to avoid potential physical injury to the installation personnel and the equipment.

### 3.2.2 SYSTEM INSTALLATION CHECKLIST

- Working space available for installation and maintenance for each mounting arrangement. Ensure unrestricted airflow.
- Ensure earthing point is within reach of the ground wire. (2m; 6 ft. 10 in.).
- Ensure a power source is within reach of the power cord and the power source has sufficient capacity.
- Where appropriate, ensure unused RF connectors are terminated.
- Where appropriate, ensure unused optical fiber connectors are protected.
- Do not locate the equipment near large transformers or motors that may cause electromagnetic interference.
- Reduce signal loss in feeder cable by minimizing the length and number of RF connections.
- Ensure the equipment will be operated within the stated environment (refer to datasheet).
- Where appropriate, confirm availability of suitably terminated grade of RF.
- Observe handling of all cables to prevent damage.

## 3.3 INSTALLATION PROCEDURES

### 3.3.1 GOODS INWARDS INSPECTION

mBDA was factory tested, inspected, packed, and delivered to the carrier with utmost care. Do not accept shipment from carrier which shows damage or shortage until the carrier's agent endorses a statement of the irregularity on the face of the carrier's receipt. Without documentary evidence, a claim cannot be processed.

Open and check each package against the packing list. For any shortage, contact Comba Telecom Systems. Do not remove items from packing materials until installation.

### 3.3.2 TOOLS

See Appendix A for a full list of tools required for installation and maintenance.



### 3.3.3 ASSEMBLING

mBDA consists of 3 parts: Rack, PMU and RFUs. All the units are packed separately. Follow the steps below to assemble.

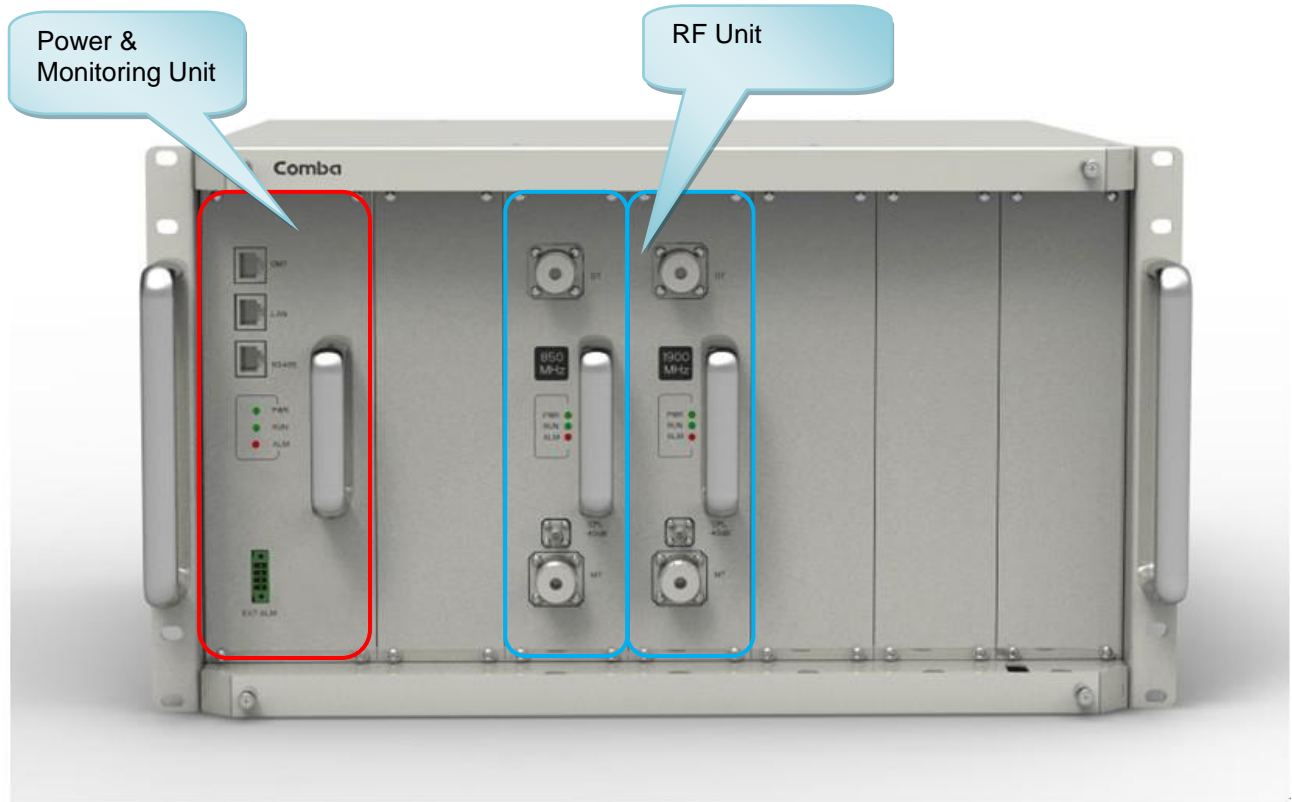

Figure 4: mBDA Screen

Step1: The rack with cover plates is shown as Figure 5. Please remove the cover plates, before installing related modules. Show as Figure 6. PMU must be installed at the left slot; RF Units are slot independent, and can be installed to other six slots.

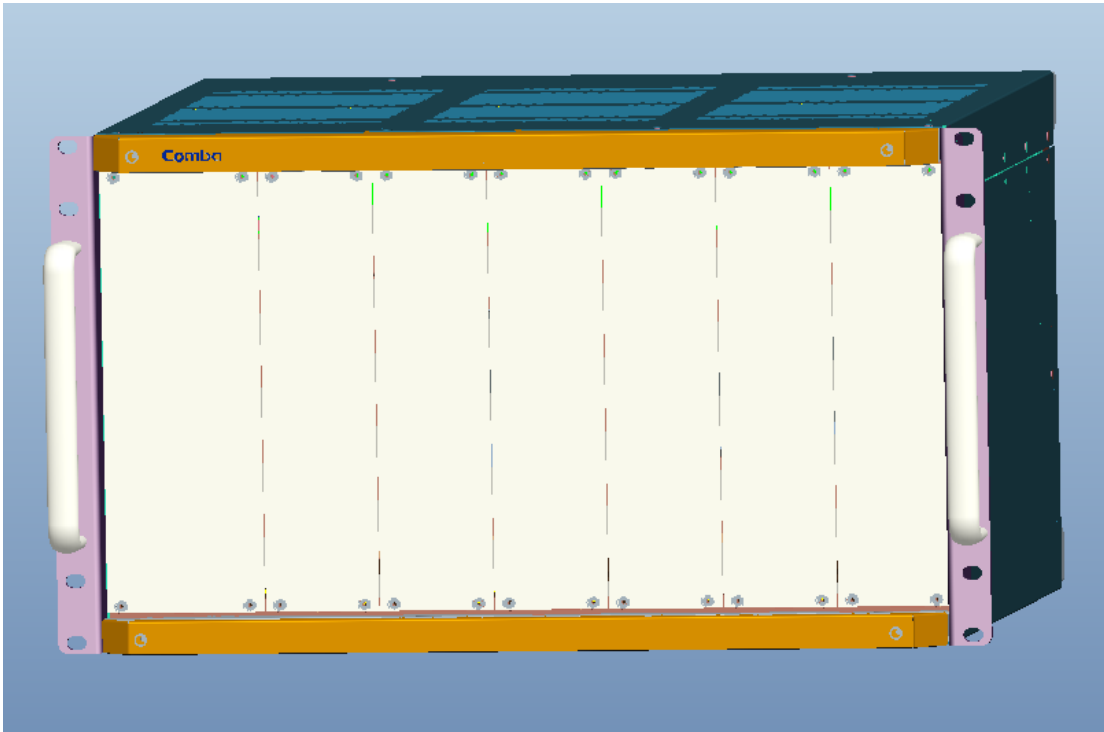

Figure 5: mBDA Rack

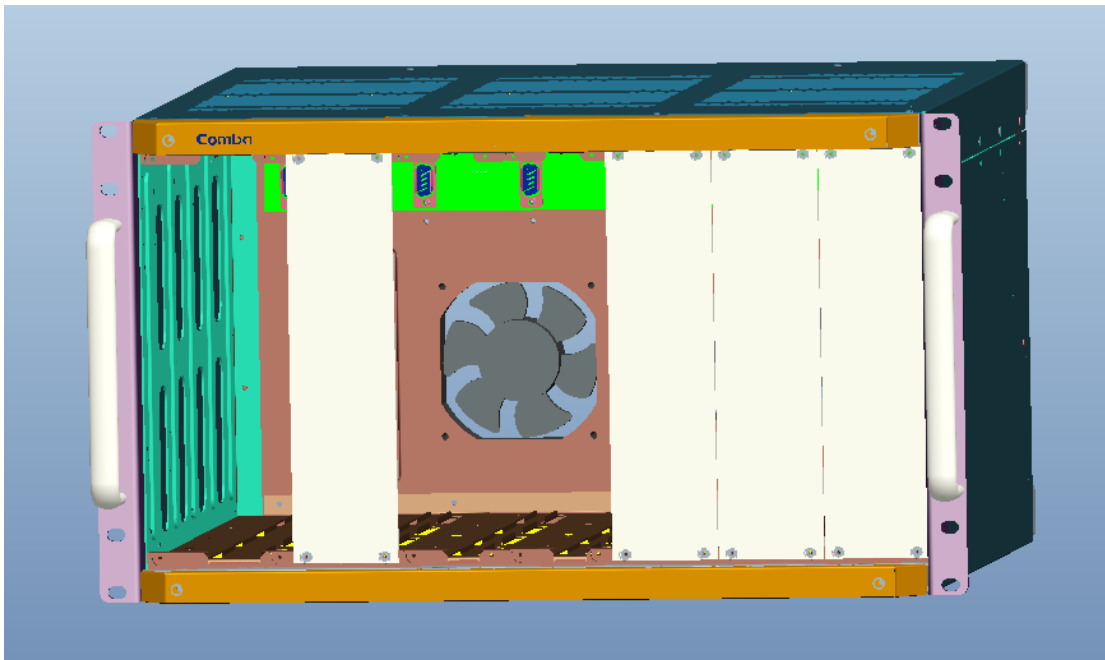

Figure 6: Remove Cover Plates

Step 2: PMU installation: Insert PMU and fasten the screws.

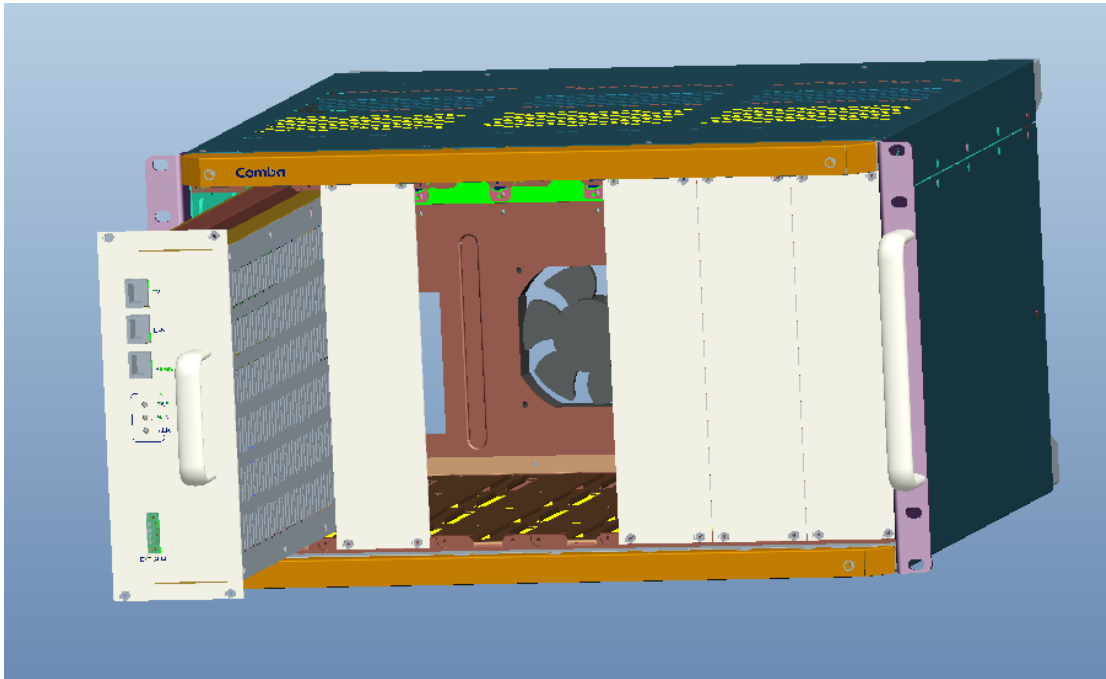

Figure 7: PMU Installation

Step 3: RF Units installation: Insert RFUs and fasten the screws.

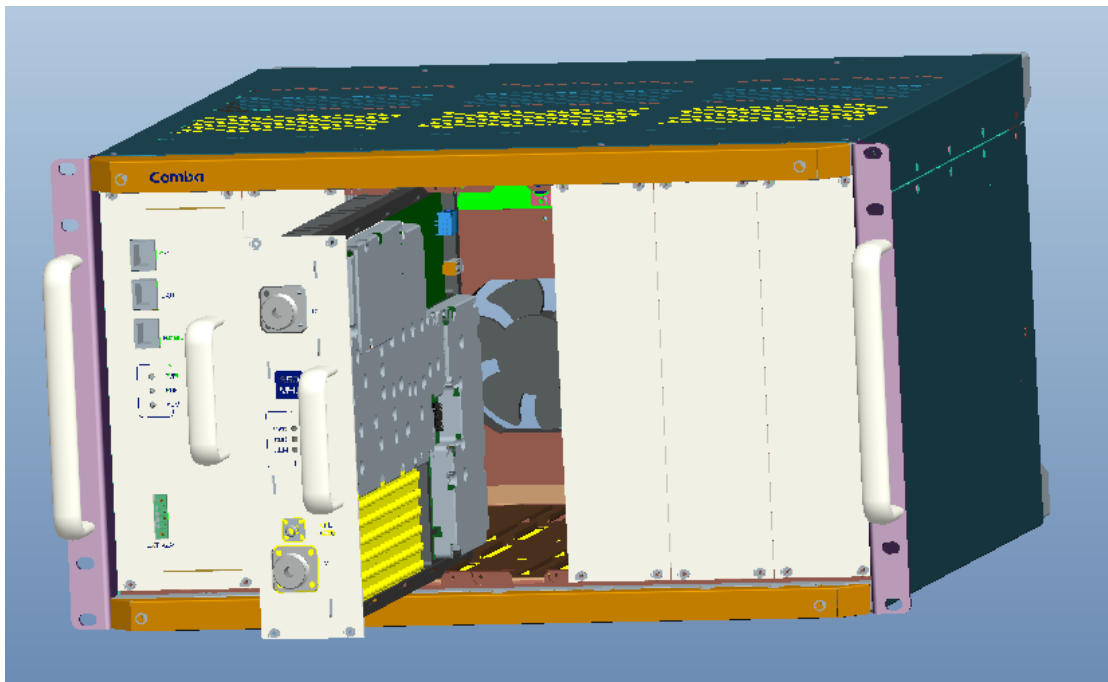

Figure 8: RF Unit Installation

Step 4: Finish Installation.

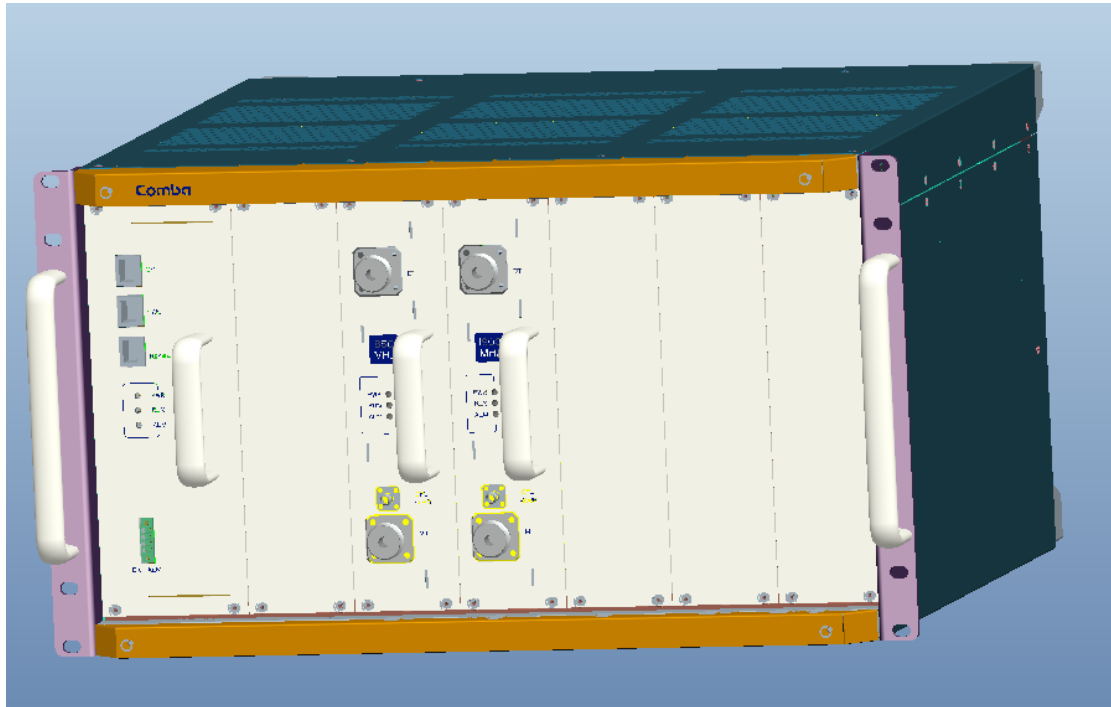

Figure 9: mBDA Installation Finish

### 3.3.4 mBDA IN NORMAL EQUIPMENT CABINET

mBDA is an indoor type device. It can be installed in normal equipment cabinet, the installation procedures are shown as below:

Step 1: Make sure the equipment cabinet is available with pallet, and the pallet is fixed steadily (Equipment Cabinet nuts, screws and pallet are not provided.). Use cabinet nuts, screws and pallet as recommended by rack manufacturer.

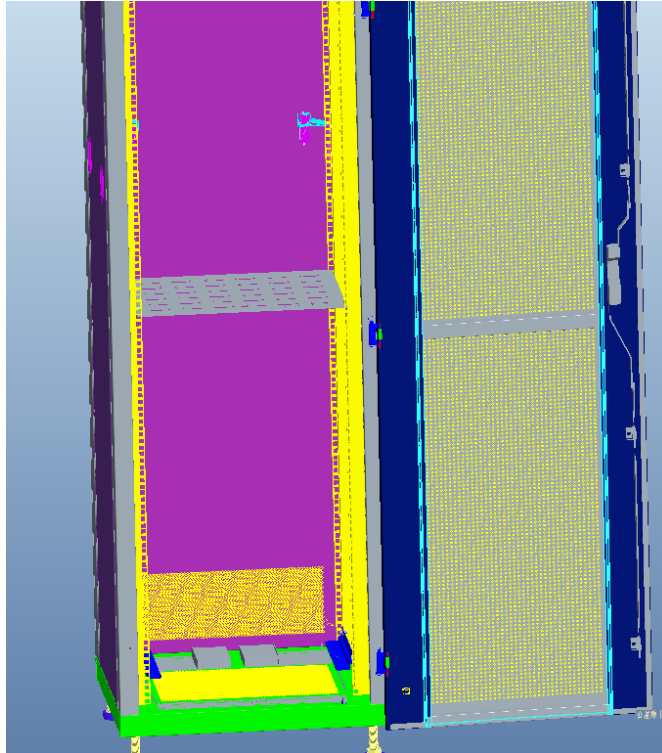

Figure 10: Equipment Cabinet with Pallet

Step 2: Install the mBDA on to the pallet.

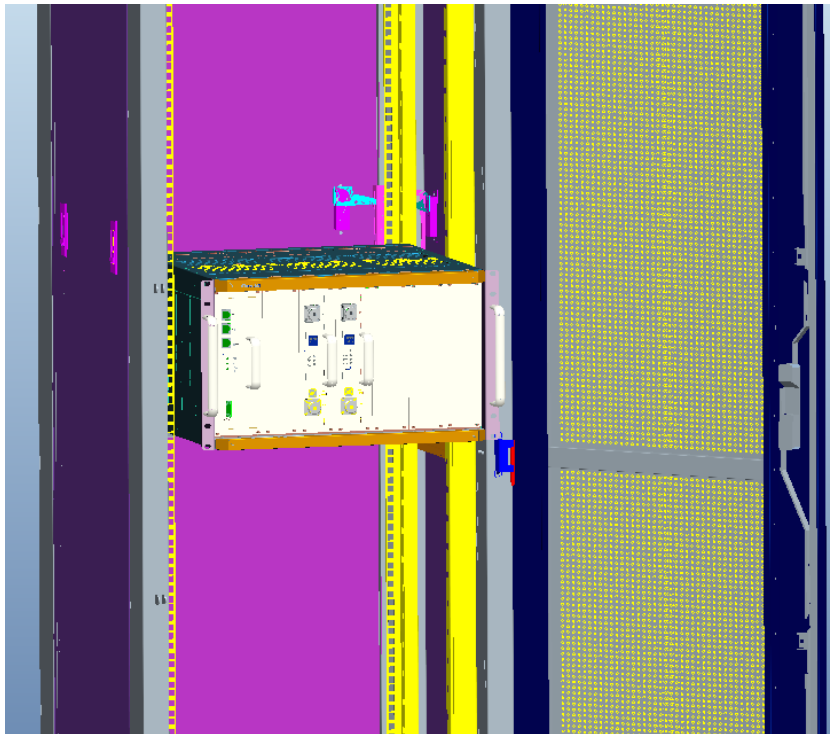

Figure 11: mBDA Installation

Step 3: Attach the mBDA onto the cabinet with the recommended rack screws.

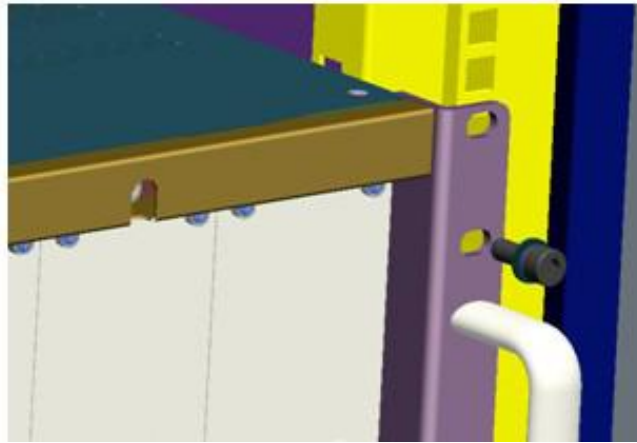

Figure 12: Secure the Screws

Step 4: Finish installation.

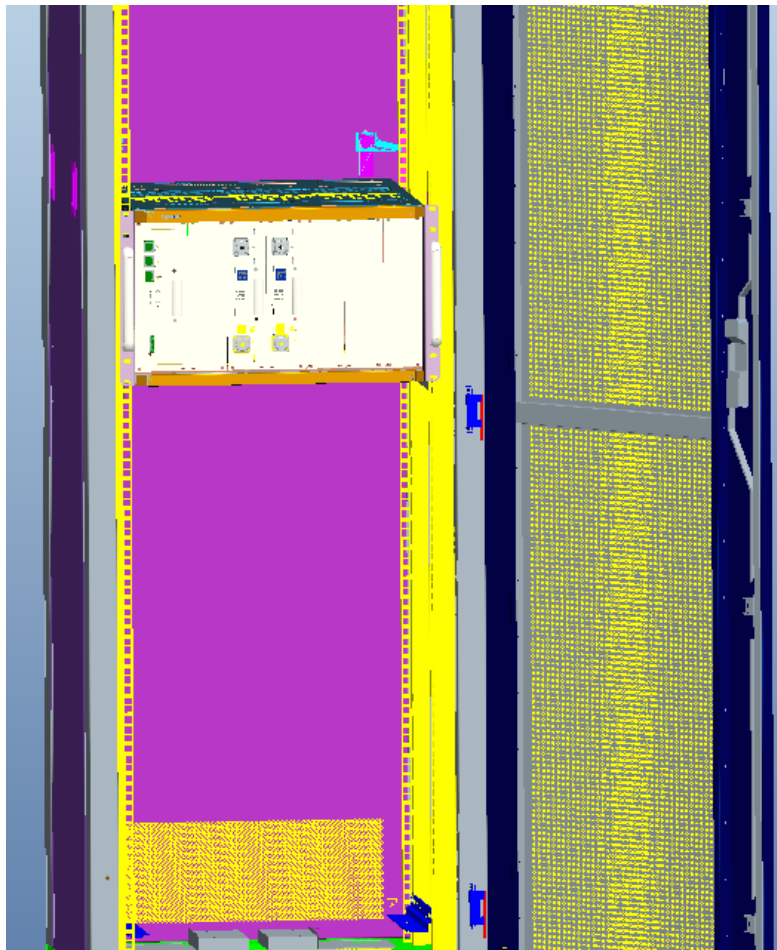

Figure 13: Finish Installaiton

### 3.3.5 mBDA IN 19" RACK MOUNTING

mBDA can also be installed in 19" rack mounting, the installation procedures are shown as below:

Step 1: Install right angle bracket and left angle bracket on back of the mounting rack. (19" Rack nuts, screws and Angel Iron are not provided.) Use rack nuts and screws as recommended by rack manufacturer. The Angle Iron is an optional assesor.

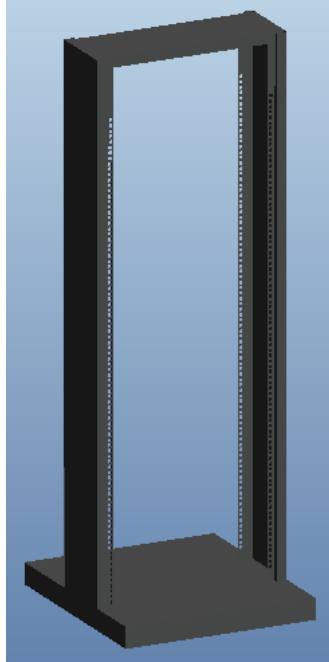

Figure 14: Mounting Rack

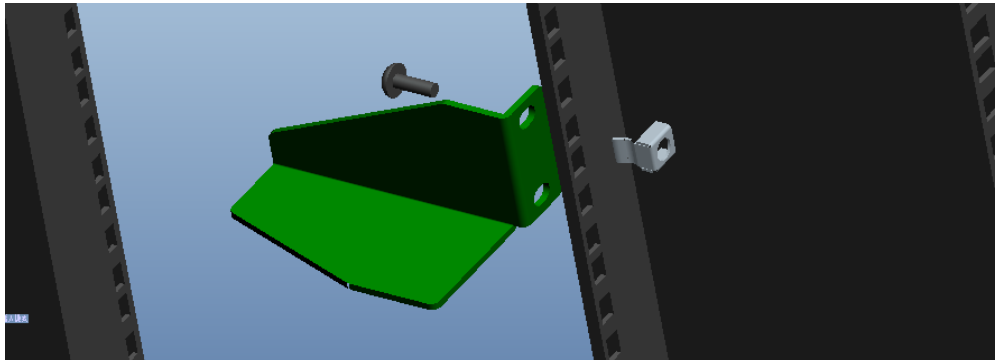

Figure 15: Angle Iron Installation

Step2: Slide the mBDA on to the angle brackets and confirm it is level. The left and right angle brackets need to be ordered separately.

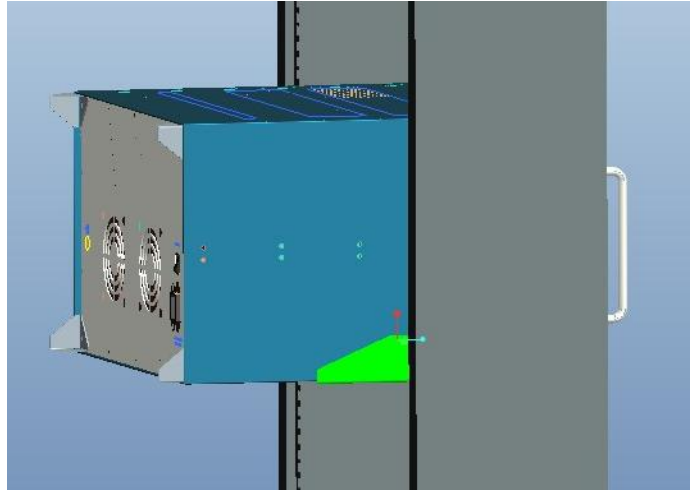

Figure 16: mBDA Installation

Step 3: Attach the mBDA onto the rack with the recommended rack screws.

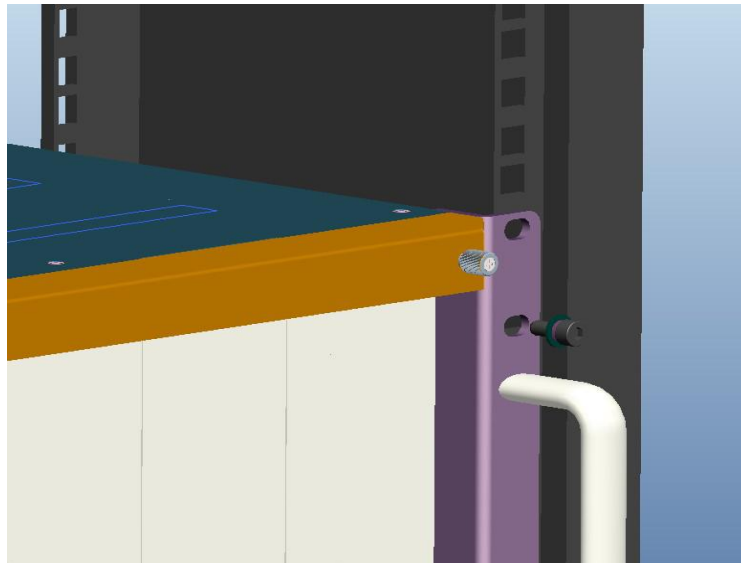

Figure 17: Secure the Enclosure

Step 4: Finish installation.



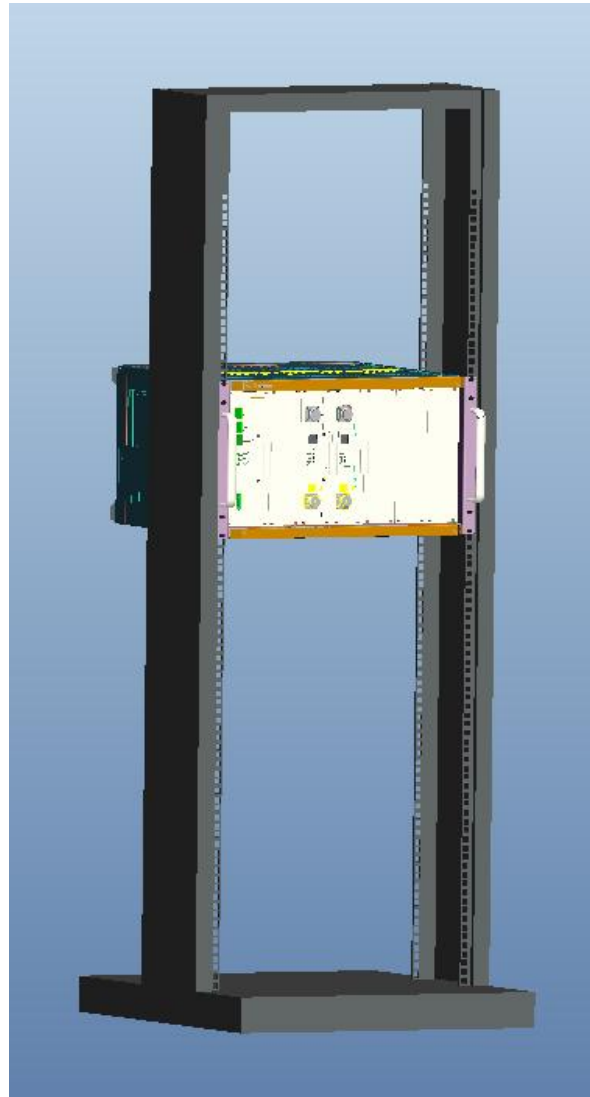

Figure 18: Finish Installaiton

### 3.4 EQUIPMENT CONNECTORS

The figure below presents the connectors of mBDA.



Figure 19: mBDA Front Panel Connectors



Figure 20: mBDA Rear Panel Connectors

Table 3: mBDA Connections

Identifier	Functional Description
1. OMT/LAN/RS485	OMT port is for local commissioning; LAN port is for remote connection; RS485 is for extension connection when adding extended equipment.
2. LED indicator	LED indicator. Refer to Table 5 for the detailed information.
3.EXT_ALM	External alarm connector with 4 pins. Refer to Table 4 for the detailed information.
4.DT	RF input port, Mini Din female
5.CPL	Output coupler port, -40dB, QMA female
6.MT	RF output port, Mini Din female

7. 	Grounding connector.
8. FAN	Fan inside
9. POWER	Power switch.
10. AC100~240V	AC power supply connector.

## 3.5 EQUIPMENT CONNECTION

### 3.5.1 GROUNDING CONNECTION

**⚠ WARNING!**

This unit must always be grounded. Consult an appropriate electrical inspection authority or an electrician if you are uncertain that suitable grounding is available.

Do not connect power before grounding.

### 3.5.2 mBDA GROUNDING CONNECTION

Step 1: Connect the GND cable to the GND connector and the building EARTH. Recommended GND cable size is # 12 AWG.

Step 2: Ensure the GND cable is connected to building GND.

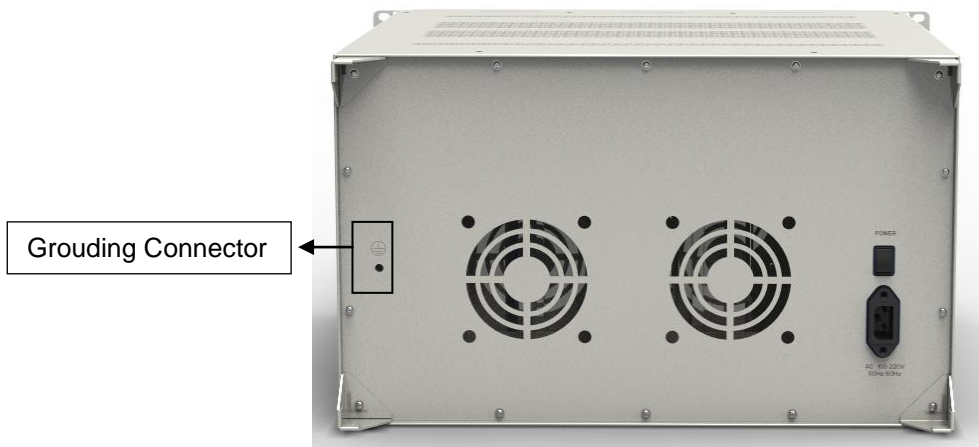

Figure 21: mBDA Grounding (mBDA Rear Panel)

### 3.5.3 mBDA CONNECTIONS

Step 1: Connect the mBDA DT port to the RF Source downlink, and then connect mBDA MT port with RF Source uplink.

Step 2: Connect the power cable to the power supply port (100-240VAC, 1Amp maximum).

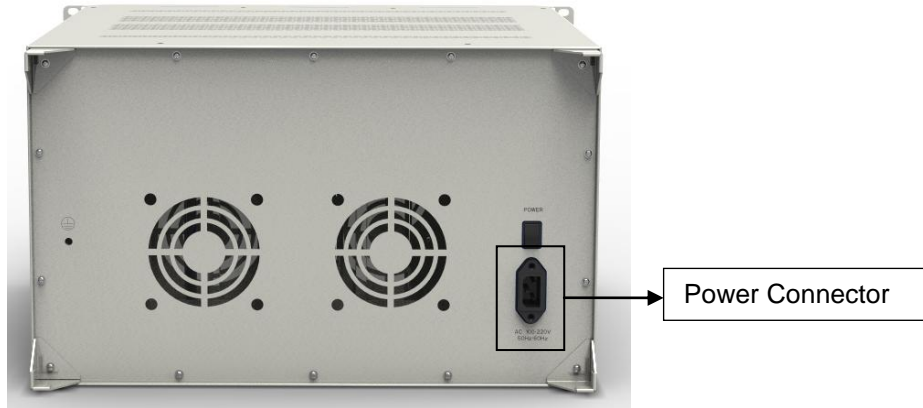

Figure 22: mBDA Power Connection (Rear Panel)

### 3.5.4 EXTERNAL ALARM CONNECTION

For EXT-ALM, this is a 4-pin connector. The following figure and table show the pin allocation and definition. Pin numbering are shown looking-into the connector on the enclosure.

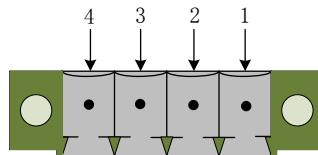

Figure 23: Pins Allocation for “EXT\_ALM” Port for mBDA

Table 4: Pin Definition of “EXT\_ALM” Port for mBDA

Pin number	1	2	3	4
Alarm definition	EXT. Alarm 1	GND	EXT. Alarm 2	GND

Note: Users need to configure Ext Alm 1~2 on WEB GUI to realize External Alarm (Refer to Chapter 5).

### 3.5.5 CONNECT TO PC

The local commissioning and management for mBDA is achieved through connecting to the WEB based GUI.

#### Connect mBDA to PC

Connect mBDA “OMT” port (RJ45) to the RJ45 port of PC with supplied Ethernet cable to achieve local monitoring and management.

End of Section

## 4 COMMISSIONING

### 4.1 PRE-COMMISSIONING TASKS

After equipment installation, perform the following steps before equipment powering and commissioning, check that the expected voltage, current, and power levels do not violate any ratings. Double check all connections including ground before applying power. Do not manipulate circuits or make changes when power is applied:

- Visually inspect the power connection within the equipment. Ensure that all cables are correctly and securely connected, including power cables, grounding wires and RF cables.
- Check grounding connection and verify that the ground resistance is less than 5Ω.
- Connect the equipment to the PC.
- Power on equipment.
- Monitor the initialization of the equipment through the LEDs on the panel. Refer to detailed LEDs information in the next section.

### 4.2 LED INDICATORS

Diagnostic LEDs are located on the equipment front panel; each indicates the status of a particular function:

Table 5: LED Indications

LED Indicator	Normal Status	Indication
PWR	Steady green	Power indicator. If LED is off, it indicates the system has no power.
RUN	Flashing green (1 time/sec)	mBDA operation indicator. After initialization (1~2 minutes), the LED should flash at once per sec. (When upgrade firmware, LED will flash rapidly)
ALM	OFF	Alarm indicator. If LED is RED, there is an alarm.

### 4.3 COMMISSIONING PROCEDURE

System commissioning can commence after the monitoring system has completed self initialization. The commissioning procedure is shown below:

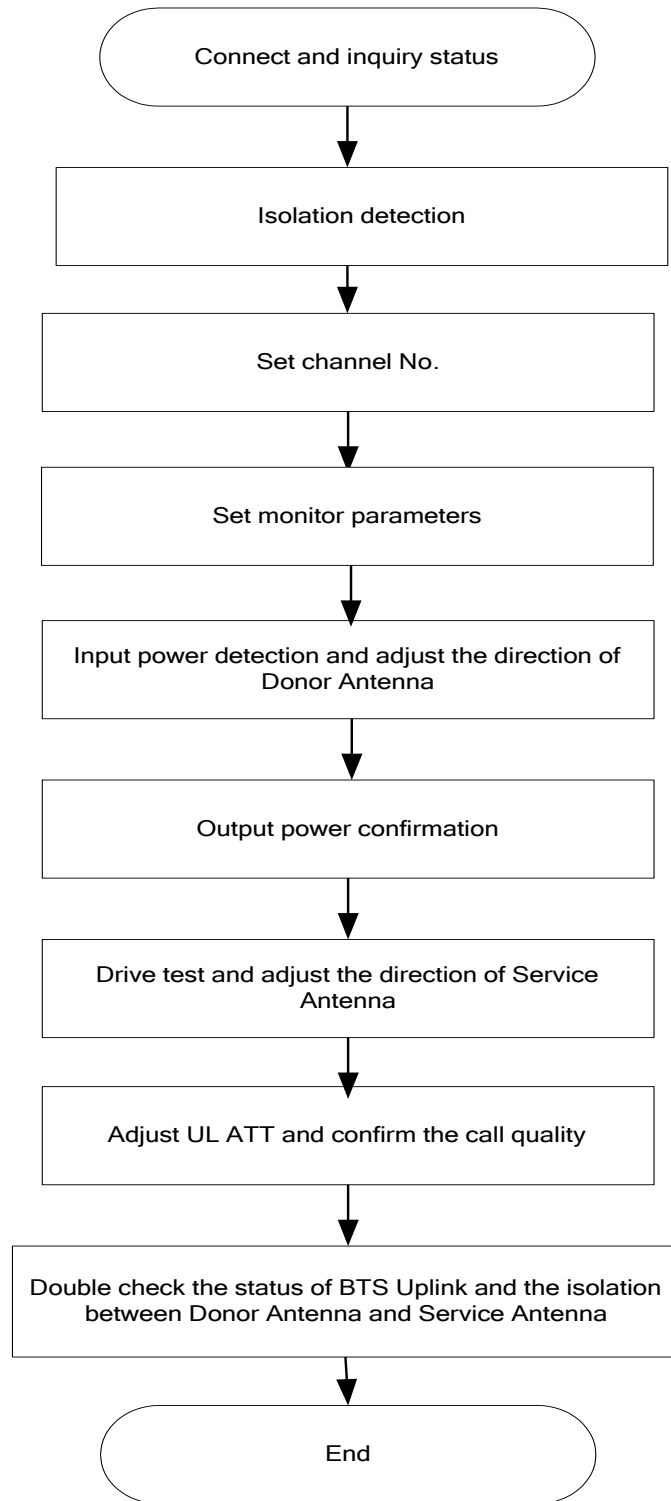

Figure 24: Commissioning Flow Chart

Table 6: Commissioning Procedure

Commissioning Tasks	Observation
1. On-line and Inquiry status	<ul style="list-style-type: none"> <li>● Activate the OMT Main window. The system Initialization will completed in about 2 minutes.</li> <li>● Click “Connect” button to enquire the repeater’s status. Proceed if there is no alarm; else check the failure and attend to the alarm.</li> </ul>
2. Isolation detection	<ul style="list-style-type: none"> <li>● Detect isolation of service antenna and donor antenna.</li> </ul>
3. Set Channel No.	<ul style="list-style-type: none"> <li>● Keep RF switch ON and set the channel number of the repeater’s operating frequency.</li> </ul>
4. Adjust Downlink Output Power and align donor antenna	<ul style="list-style-type: none"> <li>● Observe DL input power from measured value. Align the direction of donor antenna until the DL input power reading is maximized.</li> <li>● Note: To ensure that the measured DL input power is accurate, one should set the DL ATT to “0” before performing the check.</li> </ul>
5. Configure [Equipment ID]	<ul style="list-style-type: none"> <li>● Go to [Properties Info] and set [Equipment ID].</li> </ul>
6. Comm. Config	<ul style="list-style-type: none"> <li>● Enable the power supply by selecting “On” in [RF] -&gt; [Switch]; go to [Properties Info.] -&gt; [Comm. Config.] and set OMC Phones No. , the service No. of SMSC, Report Mode.</li> </ul>
7. Select Monitoring Parameters	<ul style="list-style-type: none"> <li>● Select the equipment controlled and monitored parameters.</li> <li>● If the external devices are connected to the equipment for management, please enable in the [External Alarm Info.] Interface.</li> </ul>
8. Test coverage area field intensity and adjust service antenna.	<ul style="list-style-type: none"> <li>● Use test-handset to verify field intensity within the coverage area. If needed, realign the service antenna to achieve the desired coverage.</li> <li>● Note: If during operation, the equipment gain could not be set to maximum or the output power is not high enough due to insufficient donor and service antennas isolation, then the antennas’ position should be changed to increase isolation. If the output power is too high and ALC is activated, then adjust the DL ATT to achieve optimal DL Gain.</li> </ul>
9. Verify UL gain and ensure test call produces good voice quality and there is no interfering BTS	<ul style="list-style-type: none"> <li>● Adjust UL gain and perform test calls. Typically, the UL gain is set around 5dB less than DL gain. Perform test calls in the coverage area while adjusting UL gain if required.</li> <li>● Note: If the repeater is near the BTS and the test call performance is poor, this may be due to UL noise interference to the BTS. Users can calculate and determine if the repeater UL noise will interfere with the BTS.</li> <li>● Verify again that there is no unacceptable interference to BTS.</li> </ul>

End of Section



## 5 WEB GUI

mBDA can be monitored and controlled by WEB GUI, follow below contents to achieve system parameter setting and commissioning.

### 5.1 WEB GUI CONNECTION

**Step 1:** Connect PMU OMT port to PC RJ45 port with the supplied Ethernet cable to set up a physical connection.

**Step 2:** Go to laptop Control Panel\Network and Internet\Local Area Connection. Right click it and click Properties. Then follow the steps shown in figure below.

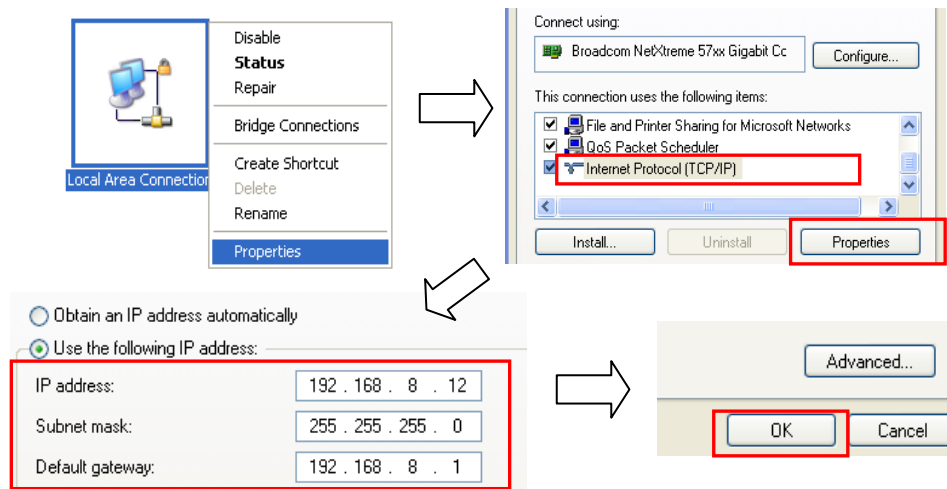

Figure 25: PC IP Address Setting

**Step 3:** Open browser (browser IE7.0, IE8.0, Chrome or Firefox, suggest display resolution is 1024x768), input Web GUI **IP address: 192.168.8.101**, click [Enter].

NOTE: DHCP and DNS are also available to login Web GUI. The domain name is: [www.combaomt.com](http://www.combaomt.com).

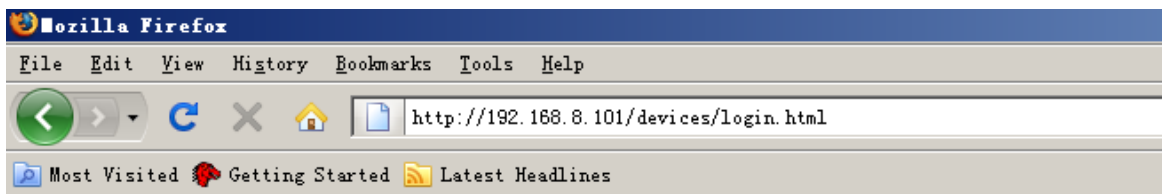

Figure 26: Input IP Address

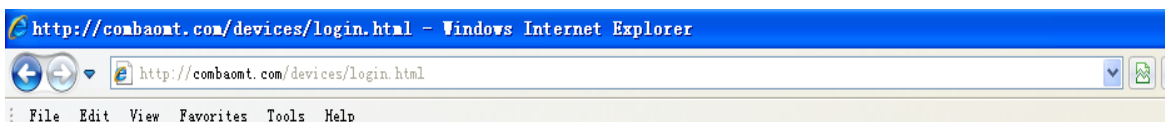

Figure 27: Input Domain Name

Step 2: Input **User Name: admin**; **Password** (default password: **admin**). Click [Log in].

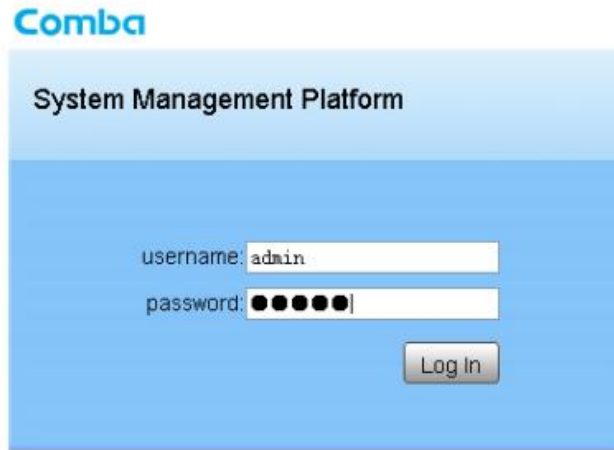

Figure 28: Input User Name and Password

## 5.2 WEB GUI INTRODUCTION

After log in, the Web GUI main screen will appear.

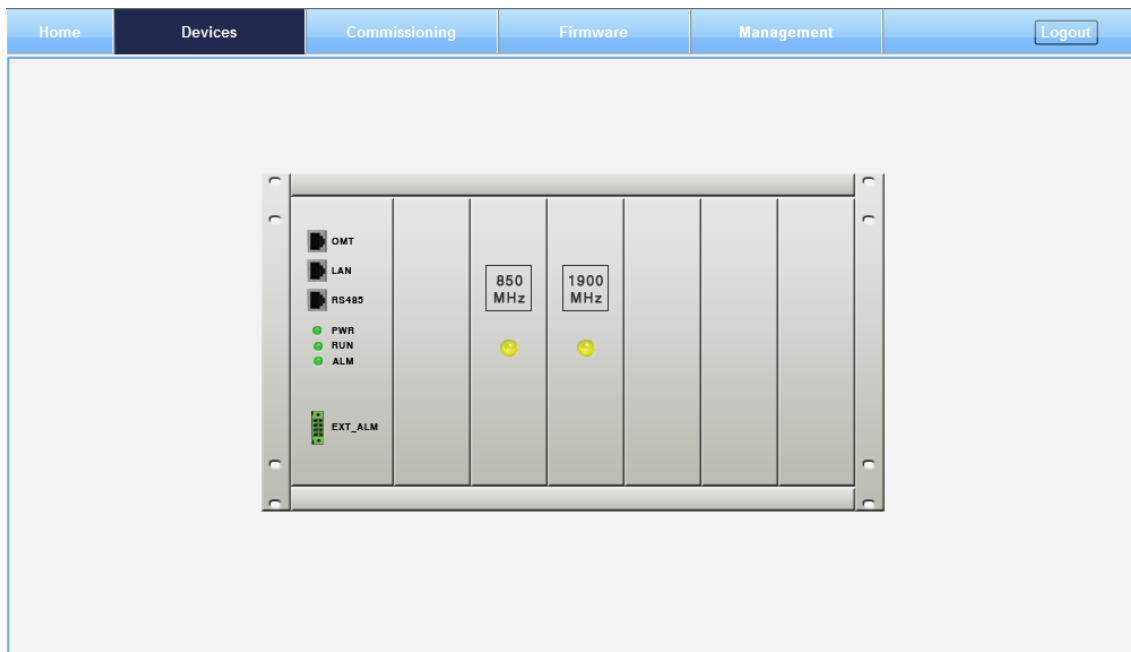

Figure 29: Web GUI Main Screen

On Comba Web GUI Home Screen, there are four Menu bars: **[Devices]**, **[Commissioning]**, **[Firmware]** and **[Management]**.

### 5.2.1 [DEVICES]

The [Devices] Screen shows the actual active modules of mBDA.



Figure 30: [Devices] Screen

**PMU Main Management Screen**

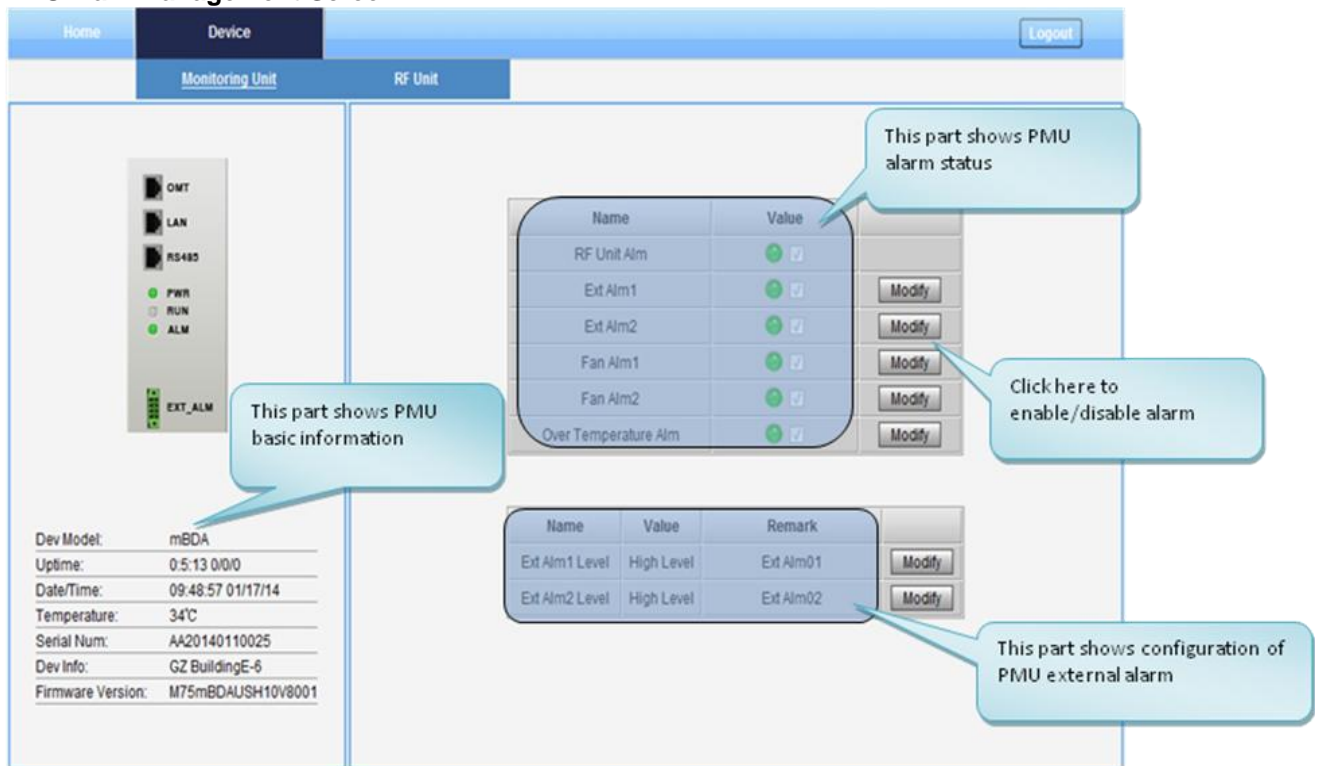

Figure 31: Power & Monitoring Unit

## RF Unit Management Screen

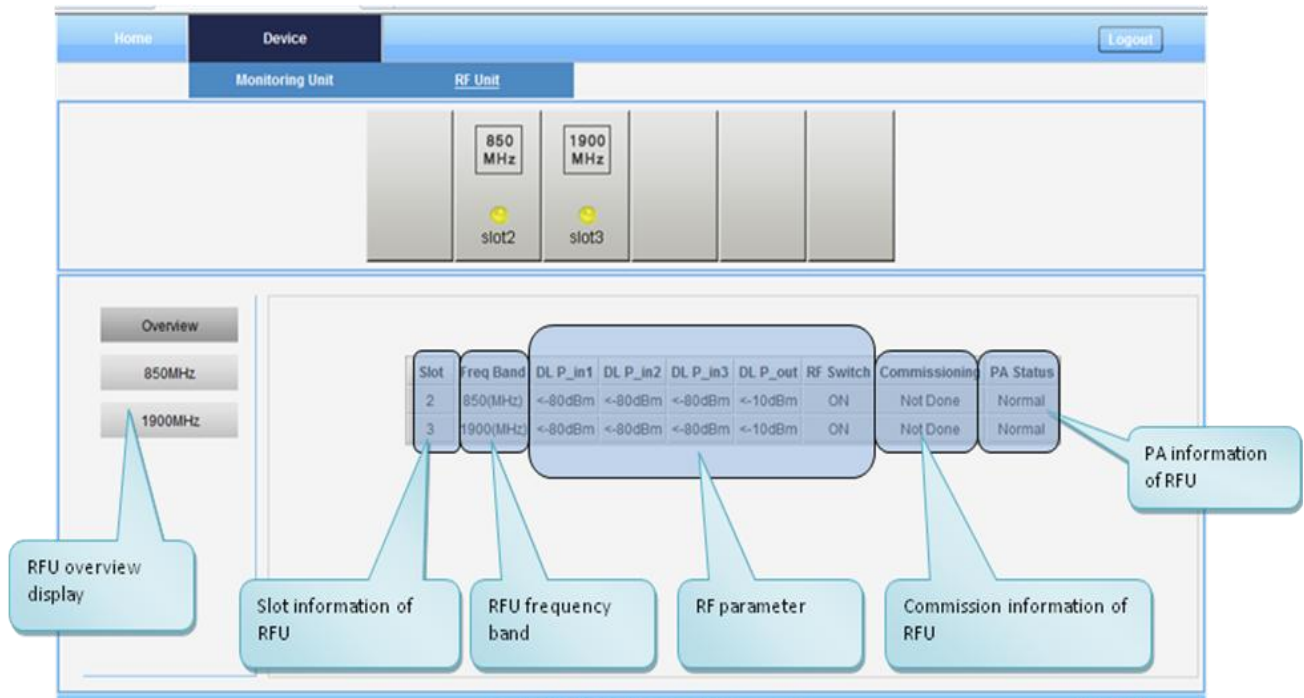

Figure 32: RF Unit

**NOTE:** There are three statuses for PA Service: **Normal**, **Recovery** and **Shutdown**. If PA output power or reflected power exceeds the threshold, software will trigger Recovery:

- It will reset PA and then re-detect the PA output power and reflected power, if they are normal, the PA Service Status will turn to **Normal**, if PA output power or reflected power is still over the threshold, PA Service Status will turn to **Recovery** again.
- If PA output power or reflected power is still over the threshold after six times of PA Recovery, PA Service status will be **Shutdown** which will need to be reset manually. Reset at Management > PA Reset.

The screenshot shows the 'RF Unit' configuration page. At the top, there are tabs for 'Home', 'Device', and 'Monitoring Unit', with 'RF Unit' selected. Below the tabs are buttons for '850 MHz' and '1900 MHz', each with a yellow plus icon and a label 'slot2' or 'slot3'. A sidebar on the left has buttons for 'Overview', '850MHz', and '1900MHz'. The main area contains two tables. The first table lists sub-bands with their respective network types, frequency ranges, and alarm settings. The second table lists various RF parameters and their current values.

Sub Band	Network	Freq Low	Freq High	DL P_in	Switch	UL ATT	DL ATT	Over DL P_in Alm
1	GSM	859MHz	870MHz	<-80dBm	ON	0dB	0dB	<span style="color: green;">●</span> <input type="checkbox"/>
2	GSM	880MHz	885MHz	<-80dBm	ON	3dB	3dB	<span style="color: green;">●</span> <input type="checkbox"/>
3	GSM	890MHz	894MHz	<-80dBm	ON	3dB	3dB	<span style="color: green;">●</span> <input type="checkbox"/>

Name	Value	
RF Switch	ON	<input type="checkbox"/> Modify
PLL Alm	<span style="color: green;">●</span>	<input type="checkbox"/> Modify
LNA Alm	<span style="color: green;">●</span>	<input type="checkbox"/> Modify
DL PA Alm	<span style="color: green;">●</span>	<input type="checkbox"/> Modify
VSWR Alm	<span style="color: green;">●</span>	<input type="checkbox"/> Modify
Protection Shut Alm	<span style="color: green;">●</span>	<input type="checkbox"/> Modify

Callouts in the image provide the following information:

- Click 850MHz to check relative band information
- Alarm information and configuration table of 850MHz RFU
- RF parameter setting table of 850MHz RFU

Figure 33: RF Unit Detail Information

### 5.2.2 [COMMISSIONING]

A work flow of the commissioning process is shown on [Commissioning] Screen. Click the [Start] button, the software will guide you through the commissioning step by step. For details, please refer to chapter 5.3.

The screenshot shows the 'Commissioning' screen. The top navigation bar includes 'Home', 'Devices', 'Commissioning', 'Firmware', and 'Management', with 'Commissioning' selected. A 'Logout' button is in the top right. The main content area features a 'Work Flow' diagram with five steps: 'Start', 'Site Info Setting', 'Isolation Detection', 'RF Setting', and 'Finish'. Below the diagram, there is a 'Tips' section with the text: 'Please click the "Start" button to startup the process.' At the bottom center, there is a 'Start' button.

Figure 34: [Commissioning] Screen

5.2.3 [FIRMWARE]

There are two functions on the [Firmware] bar: [upgrade] and [swap]. [Upgrade] is used to upgrade software, and [Swap] is to replace current firmware version to the previous one.

Follow steps shown in below figure to upgrade firmware.

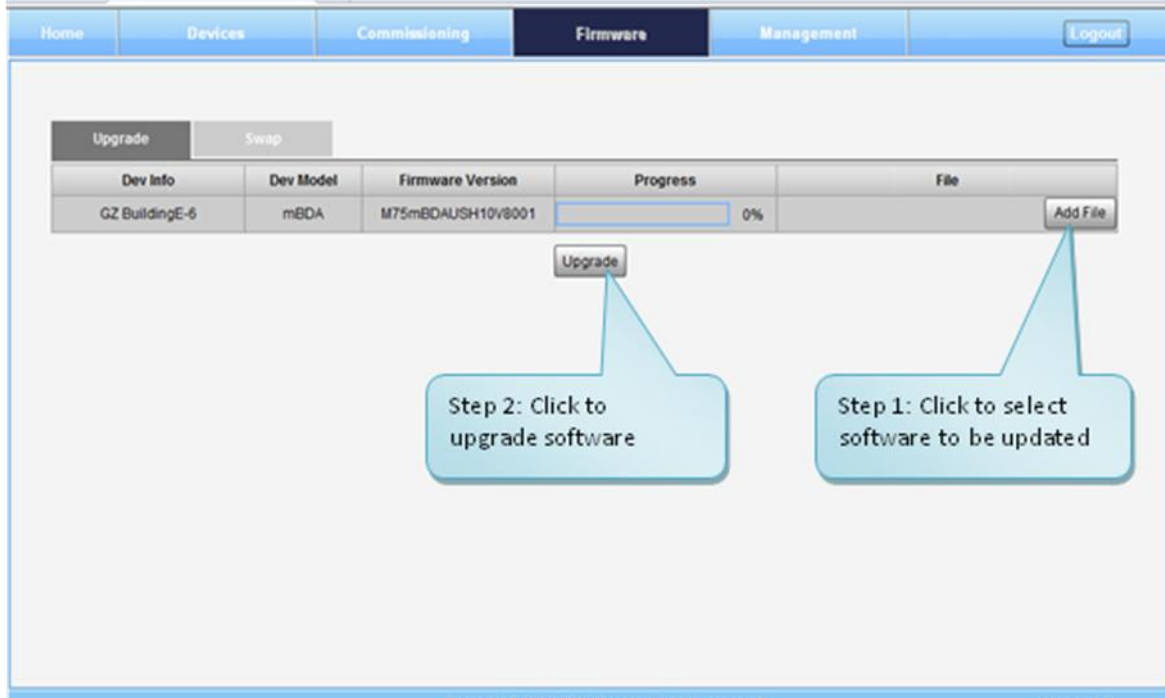

Figure 35: [Firmware] Screen – Upgrade

**Step 4:** After clicking  , a window will pop up and click .

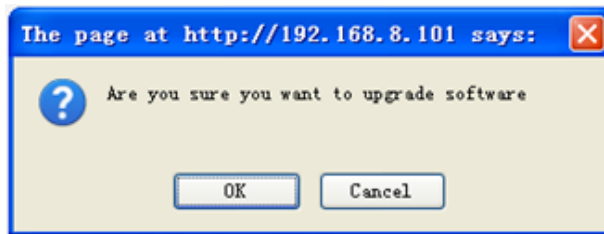

Figure 36: [Firmware] Screen – Pop-up Window 1

**Step 5:** Wait for 2~4 minutes while mBDA is being reset. Click  to continue.

**Step 6:** Clear browsing history and cookies from browser.

**NOTE:** For PMU software upgrade, users need to re-login Web GUI after reset is done.

Follow steps shown in below figure to Swap firmware.

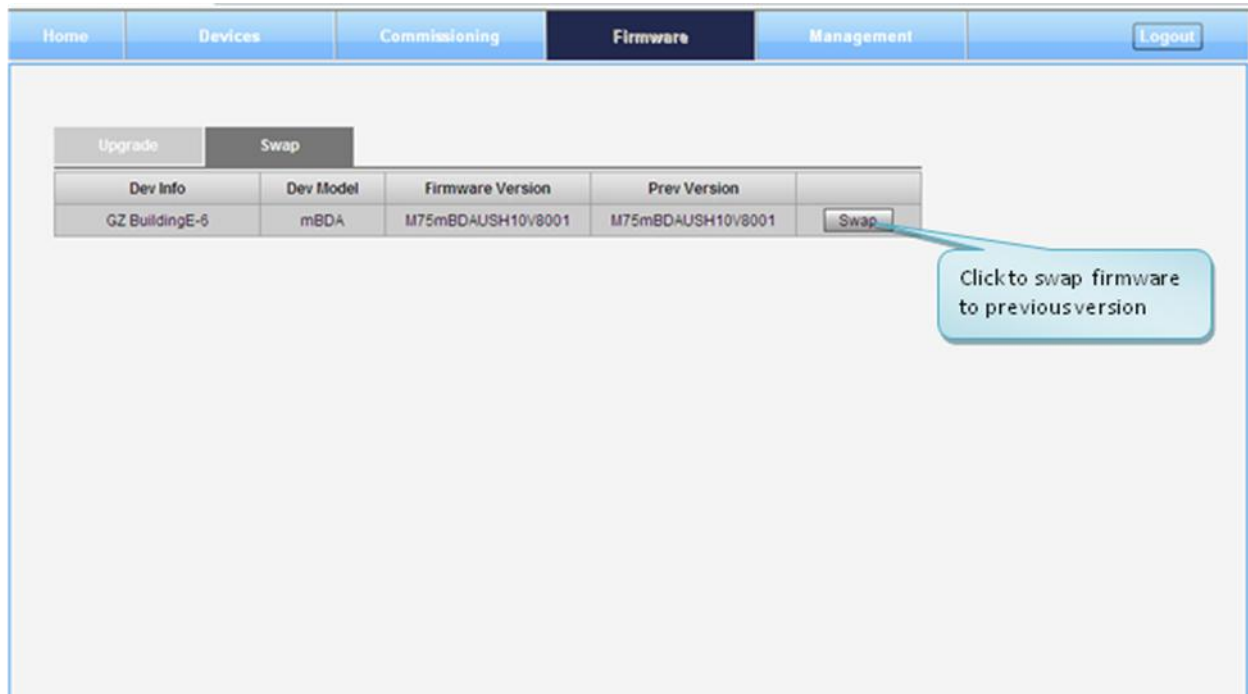

Figure 37: [Firmware] Screen - Swap

### 5.2.4 [MANAGEMENT]

Other parameters can be configured on [Management] Screen.

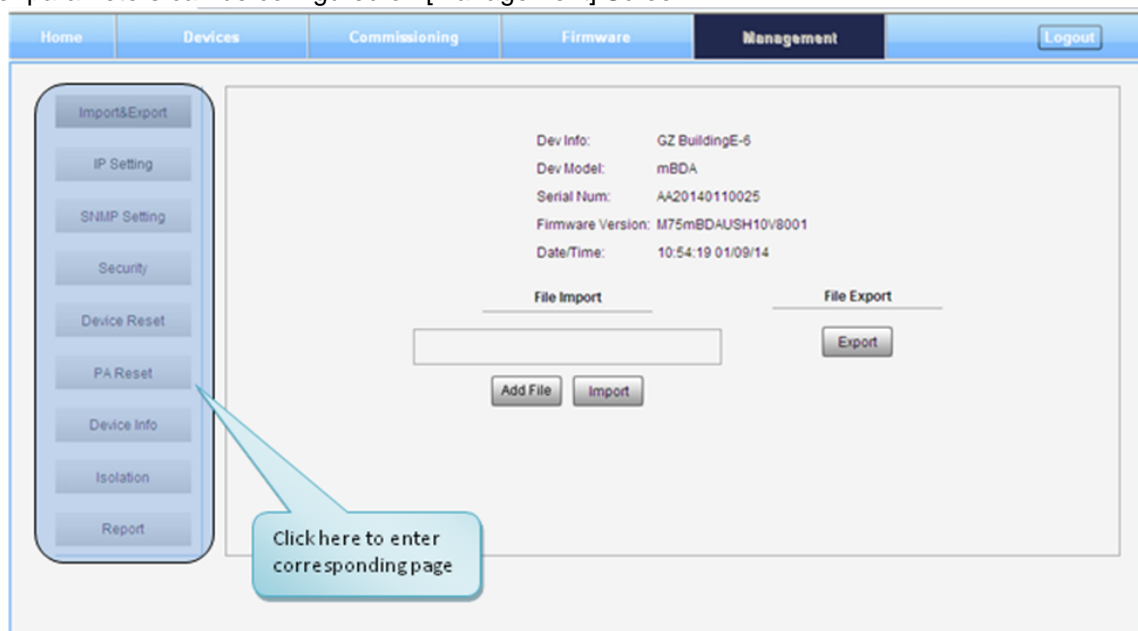

Figure 38: [Management] Screen

There are nine function bars list in the left side of the [Mangement] Screen. Below figures are the introduction of each function bar.

➤ **Inport&Export**

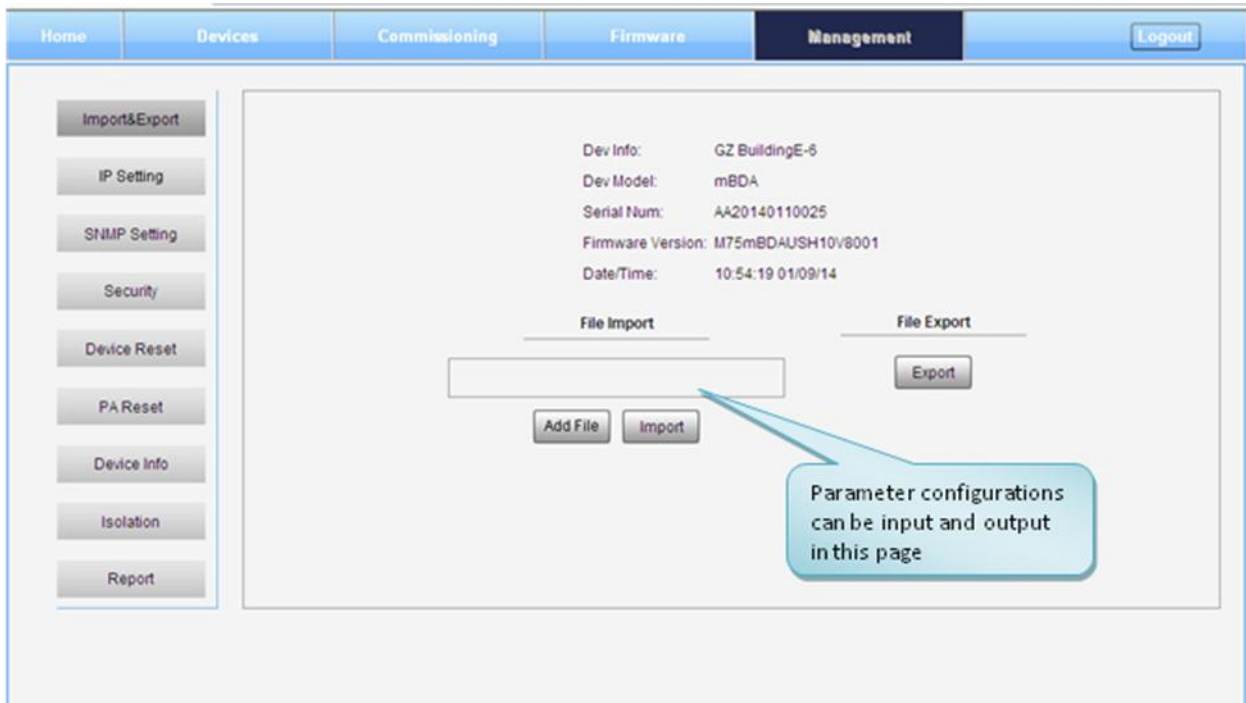

Figure 39: Management – Import&Export

The parameters that can be import/export as below: sub band, alarm enable, ATT value, RF switch, DL output power and so on.

Import and Export can help users quickly configure mBDA parameters. For example, if one mBDA finished configuration, users can export its parameters and save as a file in PC, and then import this file to other mBDA to fast finish the device parameter setting.

➤ **IP Setting**



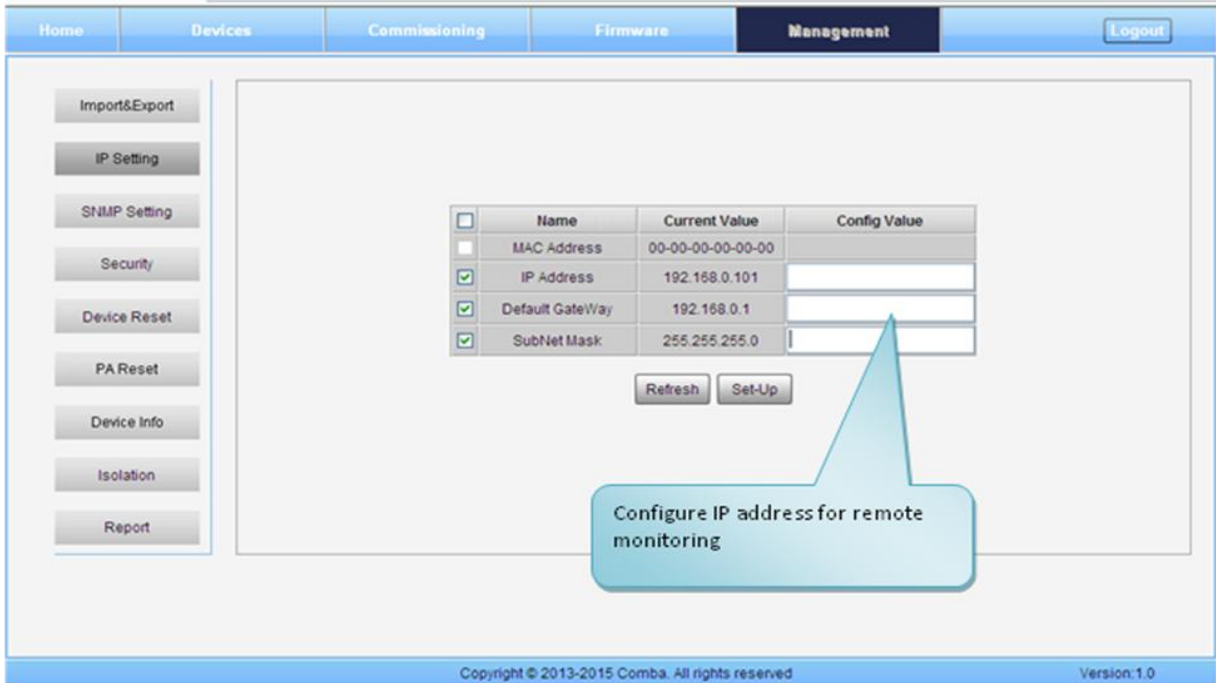

Figure 40: Management – IP Setting

Note: For remote monitoring, the IP Address must be set correctly according to the location IP of remote connection. If more than one equipment is connected to the public network through the same router, the router’s local IP **CANNOT** be set as 192.168.8.\*.

➤ **SNMP Setting**

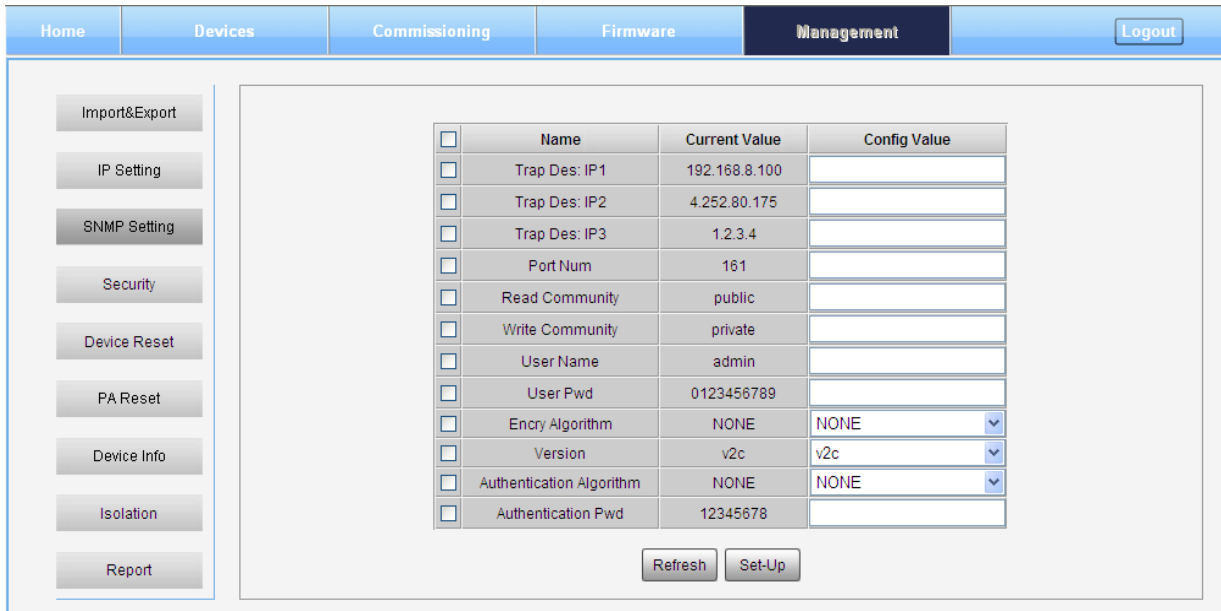

Figure 41: Management – SNMP Setting

➤ Security

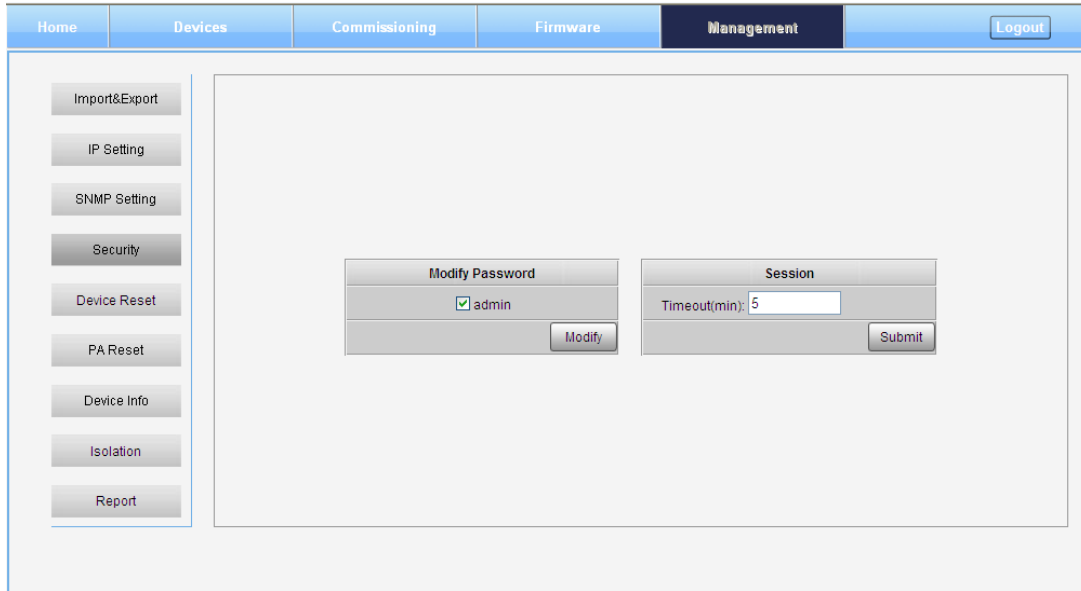

Figure 42: Management – Security

Click  , [Modify Password] window will pop-up.

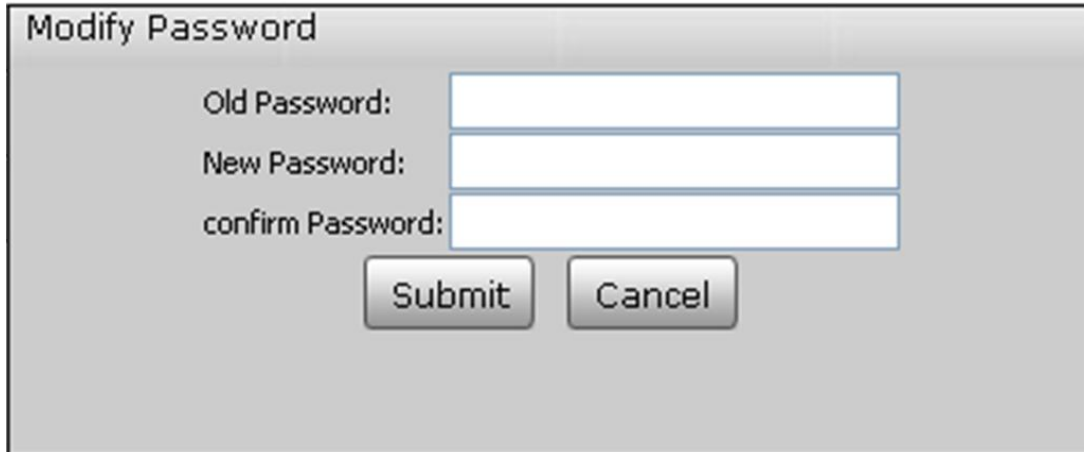

Figure 43: Modify Password

Note: Username cannot be modified.

➤ **Device Reset**

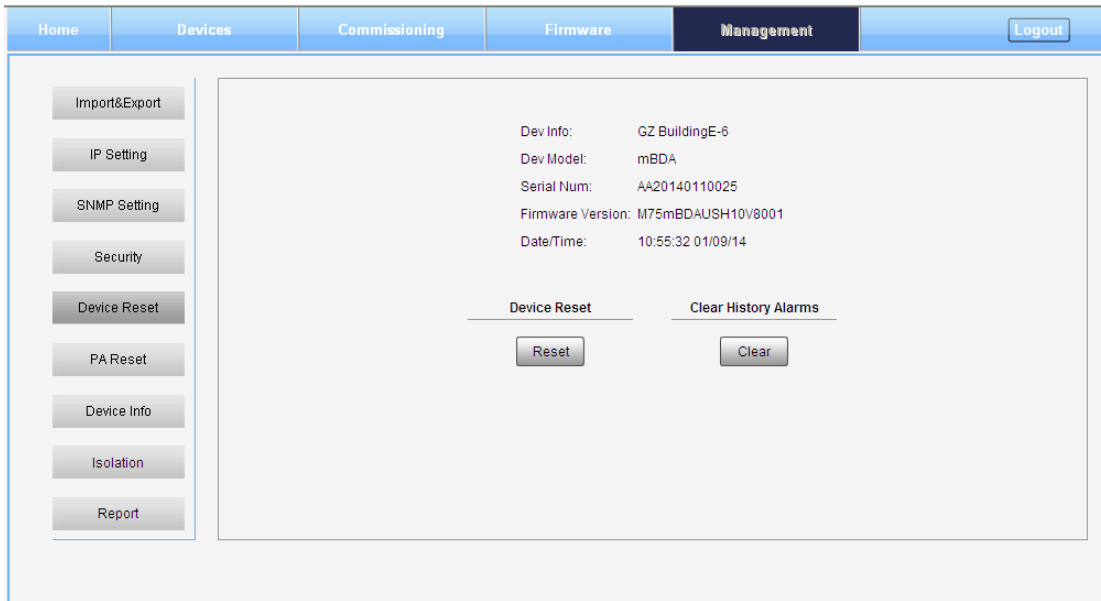

Figure 44: Management – Device Reset

Note: If users click  , all the parameter and alarm will set to factory default value. Device Reset process will last about 2~4 minutes. For PMU monitor reset, users need to re-login WEB GUI.

➤ **PA Reset**



Figure 45: Management – PA Reset

Note: PA will be turned off by software when PA output power or (VSWR) reflected power is exceed the threshold. Users need to reset PA after debugging.

➤ **Device Info**

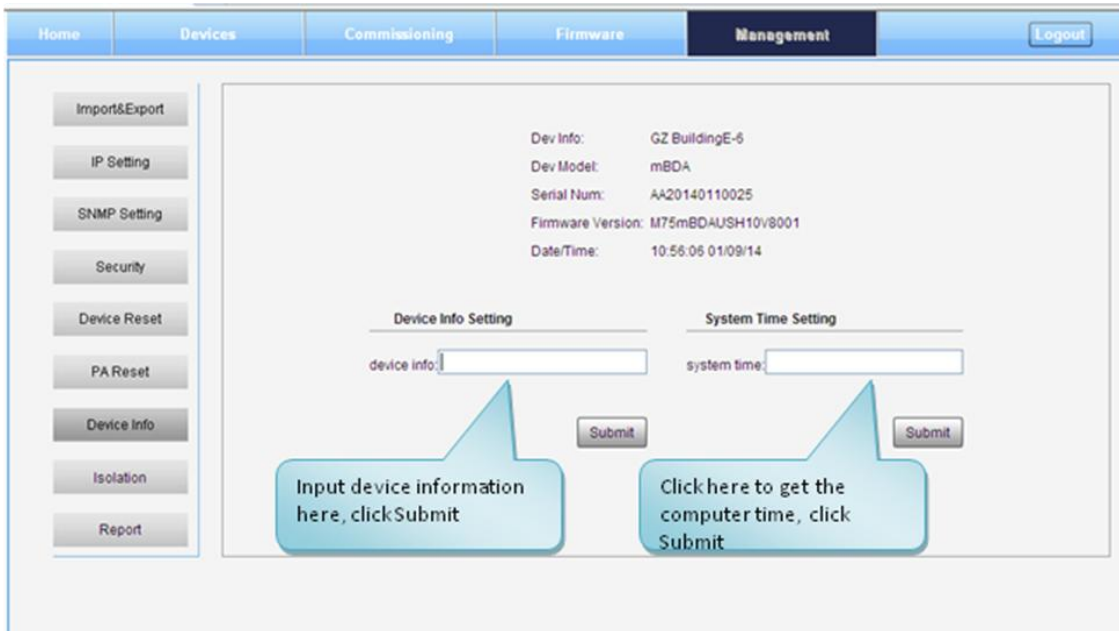

Figure 46: Management – Device Info

Note: Users can input maximum 30 bytes characters in Device Info.

➤ **Isolation**



Figure 47: Management – Isolation

Note: This Step is the same as step3 of [Commissioning]. Users can check isolation again by clicking Check button.

➤ Report

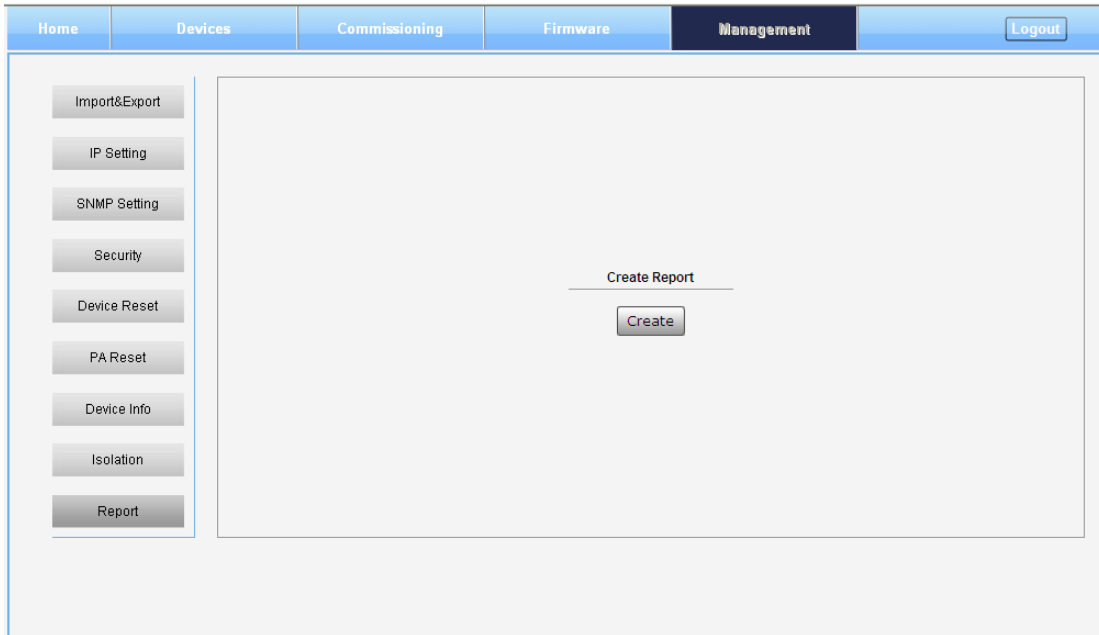

Figure 48: Management – Report

Note: Click Create to create report (The report can't create in IE browser.) and make sure the computer has installed PDF Reader software. If no, users will see nothing.

### 5.3 COMMISSIONING PROCEDURE

To complete the installation and commissioning, users need to follow the steps below.

**Step 1:** Click Menu bar [Commissioning] on home screen, a work flow will show up.

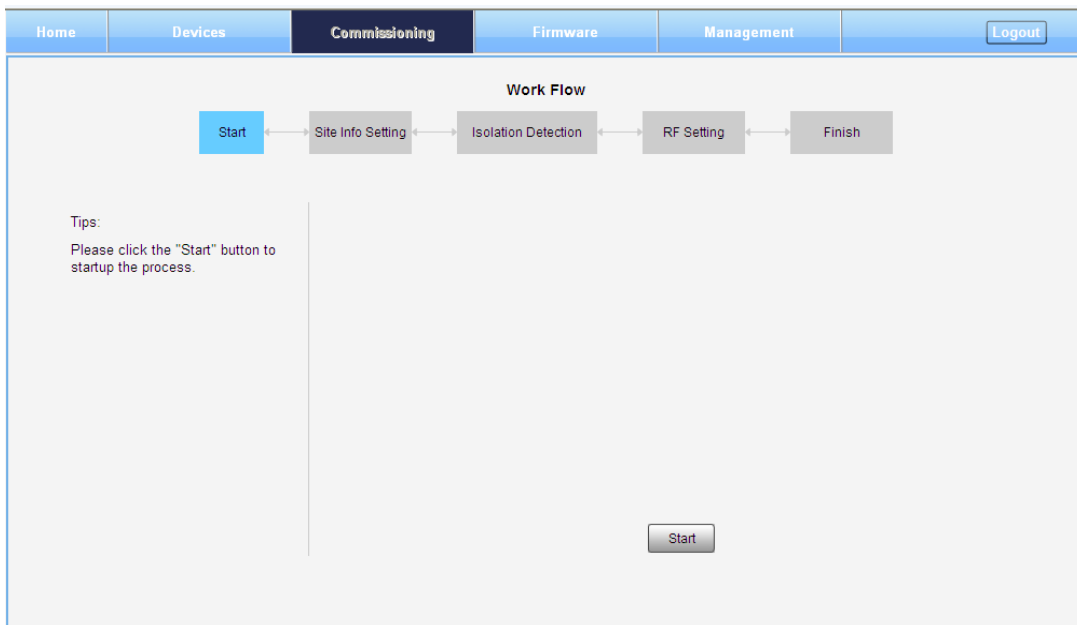

Figure 49: Commissioning Procedure - Start

**Step 2:** Click  to start the process.

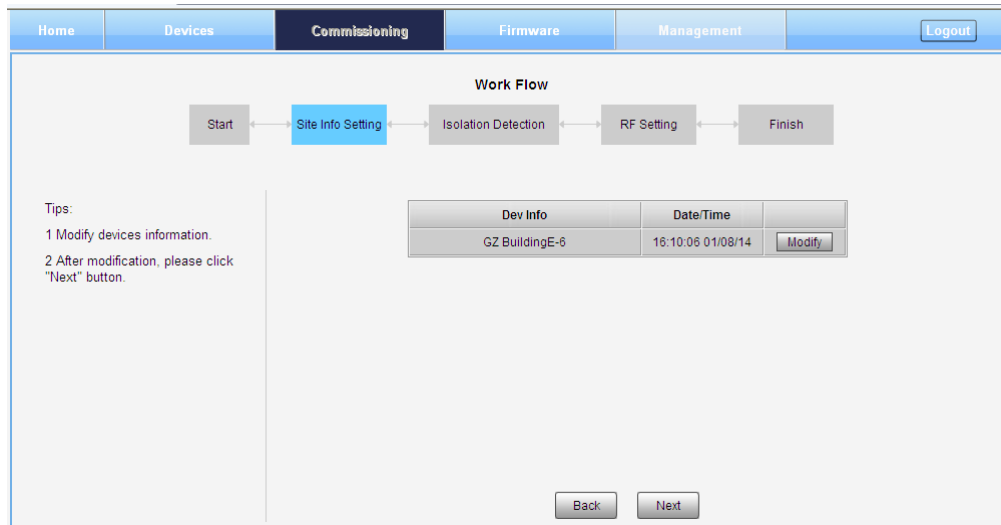

Figure 50: Commissioning Procedure – Site Info. Setting

**Step 3:** Click , users can set the site information.



The screenshot shows a 'Commissioning' dialog box. It has a table with three columns: 'Name', 'Current Value', and 'Config Value'. The first row is 'Dev Info' with 'GZ BuildingE-6' in the 'Current Value' column and an empty 'Config Value' column. The second row is 'Date/Time' with '10:32:04 01/09/14' in the 'Current Value' column and an empty 'Config Value' column. Below the table are 'Submit' and 'Cancel' buttons.

Figure 51: Dev Info & Date/Time

Dev Info mainly used to record device location and Date/Time provide a time reference. Click the Config Value of Date/Time, will update Date/time automatically.

**NOTE: Make sure the device is connected with appropriate donor and service antennas before proceeding to step 4.**

**Step 4:** Click  to enter to Isolation Detection Screen shown as Figure 52.

- ✓ Select a frequency band (RFU) that need to commission.
- ✓ Click  to start Isolation Detecting, then [Confirm] window will pop-up shown as Figure 53.
- ✓ Click  to continue. If isolation detection success, the process will go to RF Setting Screen shown as Figure 55. If failed, a Tips window will pop-up shown as Figure 54, users need to check whether the system isolation is very weak.

**NOTE:** At the end of first frequency band commissioning, user can start other frequency band commission.

The screenshot shows the 'Commissioning' tab selected in the top navigation bar. Below the navigation bar is a 'Work Flow' diagram with five steps: Start, Site Info Setting, Isolation Detecting (highlighted in blue), RF Setting, and Finish. Below the diagram, there is a 'Tips' section with the text: '1 Make sure to connect appropriate donor and service antennas.' To the right of the tips is a table with the following data:

	Slot	Freq Band(MHz)	RF Switch	Commissioning
<input type="radio"/>	2	850(MHz)	ON	Not Done
<input type="radio"/>	3	1900(MHz)	ON	Not Done

At the bottom of the main content area, there are 'Back' and 'Next' buttons.

Figure 52: Commissioning Procedure – Isolation Detective

The dialog box has a title bar 'Confirm'. The main text asks: 'Are you sure to connect appropriate donor and service antennas?'. At the bottom right, there are 'Ok' and 'Cancel' buttons.

Figure 53: Commissioning Procedure – Isolation Detective Confirm

The dialog box has a title bar 'Tips:'. The main text displays: 'Isolation detection failed'. At the bottom right, there is an 'Ok' button.

Figure 54: Commissioning Procedure –Isolation Detection Failed

**Work Flow**

Start → Site Info Setting → Isolation Detecting → **RF Setting** → Finish

Frequency Band: 850MHz (Slot:2, Isolation:120dB)

Sub Band	Network	Freq Low	Freq High	Switch	
1	GSM	869MHz	894MHz	ON	Modify
2	GSM	880MHz	885MHz	OFF	Modify
3	GSM	890MHz	894MHz	OFF	Modify

Back Next

**Tips:**  
 1 Click the text box to be configured, and fill the value of parameters, and then click "Next" button.  
 Note: for each RF module, the frequency width between sub bands with channel switch on cannot be overlapped.

Figure 55: Commissioning Procedure –Isolation Detection Finish

**Step 5:** RF Setting Screen for setting subband bandwidths and switches.



**Work Flow**

Start → Site Info Setting → Isolation Detecting → **RF Setting** → Finish

Frequency Band: 850MHz (Slot: 2, Isolation: 120dB)

Sub Band	Network	Freq Low	Freq High	Switch	
1	GSM	869MHz	894MHz	ON	Modify
2	GSM	880MHz	885MHz	ON	Modify
3	GSM	890MHz	894MHz	OFF	Modify

**Commissioning**

<input type="checkbox"/>	Name	Current Value	Config Value
<input type="checkbox"/>	Network	GSM	GSM(869-894MHz)
<input type="checkbox"/>	Freq Low	890MHz	
<input type="checkbox"/>	Freq High	894MHz	
<input checked="" type="checkbox"/>	Switch	OFF	ON

Submit Cancel

**Step 1:** Select a sub band to modify RF parameter.

**Step 2:** Configure RF parameter in this table

**Step 3:** Click submit to finish RF setting of selected sub band

**Tips:**  
 1 Click the text box to be configured, and fill the value of parameters, and then click "Next" button.  
 Note: for each RF module, the frequency width between sub bands with channel switch on cannot be overlapped.

Figure 56: Commissioning Procedure – Subband bandwidth and Switch Setting

**NOTE:** For each RF module, the 3 subband bandwidth setting should not be overlap each other, if yes, only 1 subband can be turn on, other overlap subband is forbidden to switch on by equipment.

**Step 6:** Click  to enter to DL output power setting after finishing subband bandwidths and switches setting.

**Work Flow**

Start → Site Info Setting → Isolation Detecting → **RF Setting** → Finish

Frequency Band: 850MHz (Slot: 2, Isolation: 120dB)

Sub Band	Network	Freq Low	Freq High	DL P_in	Switch	Target DL P_out(dBm)
1	GSM	869MHz	870MHz	<-80dBm	ON	30
2	GSM	880MHz	885MHz	<-80dBm	ON	28
3	GSM	890MHz	894MHz	<-80dBm	ON	20

Back Next

**Tips:**  
 1 Click the text box to be configured, and fill the value of parameters(Unit: dBm), and then click "Next" button.  
 Note: for each RF module, the total target output power of sub bands with channel switch on must not exceed the nominal downlink output power.

Figure 57: Commissioning Procedure – DL Output Power Setting Screen

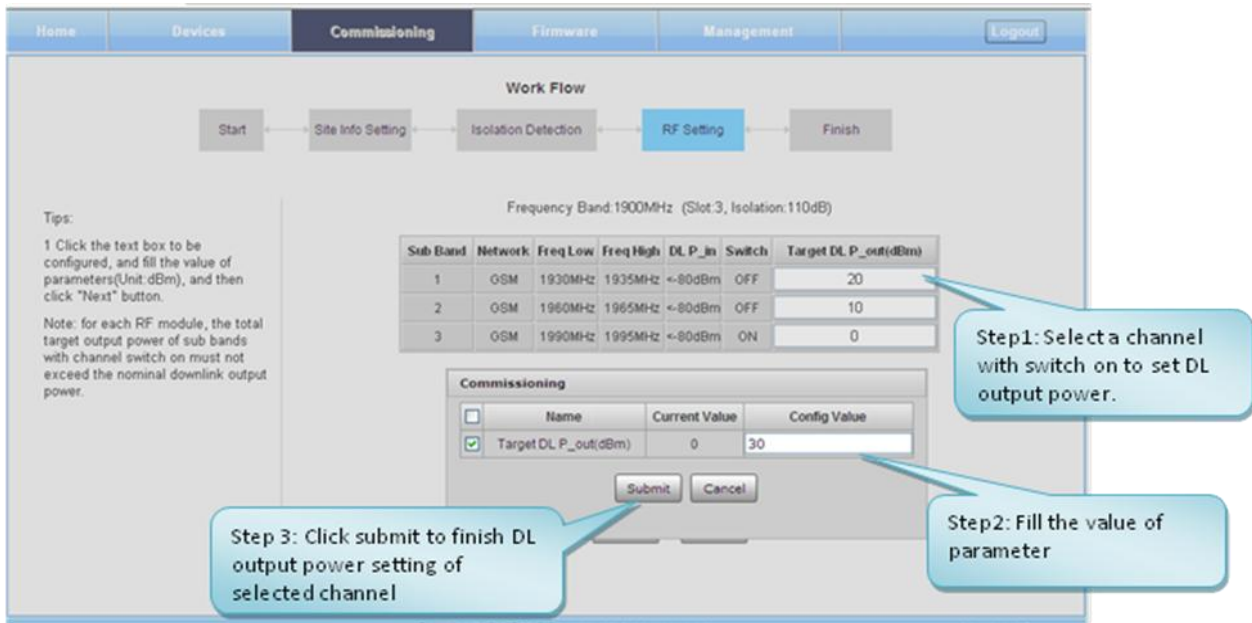

Figure 58: Commissioning Procedure – DL Output Power Setting

**NOTE:** For each RF module, the total target output power of all subbands which channel switch is on must not exceed the nominal downlink output power (27, 30, 33dBm); if yes, Tips window will pop-up shown as Figure 59. Finish the output power setting, click  button, go to Finish Screen shown as Figure 60.

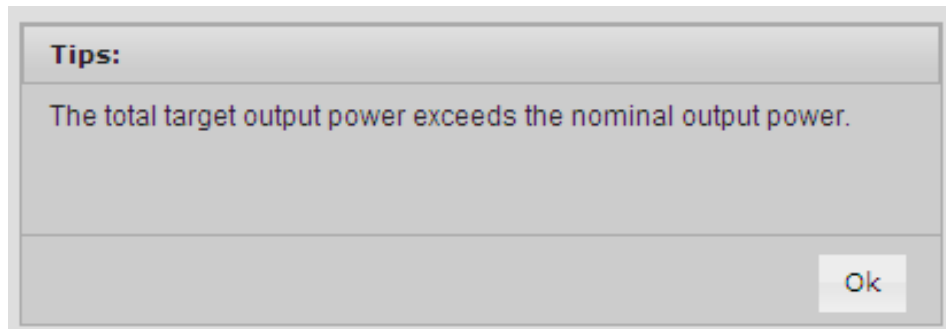

Figure 59: DL Output Power Over Exceed

**Step 7:** Click  to commission other RFUs parameters. Click  to finish the commissioning.

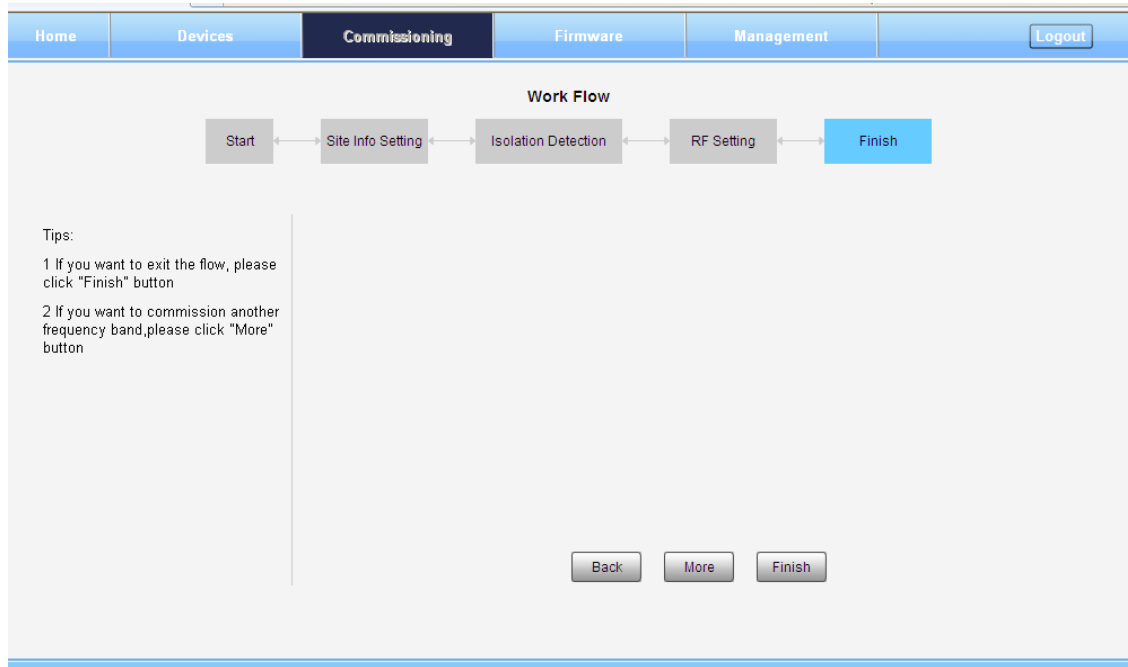

Figure 60: Commissioning Procedure – Finish

End of Section

## 6 MAINTENANCE

The mBDA is designed for trouble-free operation and generally does not need maintenance. Maintenance activities should only be carried out by trained personnel.

The equipment operation status can be observed remotely through OMC.

Periodic inspection of the repeater equipment(s) is recommended, the recommended tasks includes:

- Inspect and record operation status and output power of the repeater from OMC or OMT.
- Verify the direction and position of antennas. Re-align if necessary.
- Make sure the cable gland and sealing on the RF cable connectors are not damaged.
- Verify lightning and grounding protection is in good condition.

End of Section

## 7 APPENDICES

### 7.1 APPENDIX A: TOOLS FOR INSTALLATION AND MAINTENANCE

The following tools (not included in package) are required for installation or routine maintenance:

- Power Drill (for wall mount)
- Adjustable Wrench (0.31 inch~0.79 inch)
- Philips Screwdriver
- Allen wrench (M6)
- Signal generator support output power 10dBm.
- Site Master

## 7.2 APPENDIX B: RMA (RETURN MATERIAL AUTHORIZATION)



**Comba Telecom Ltd.**  
 611 East Wing, No. 8 Science Park West Avenue, Hong Kong Science Park, Tai Po, Hong Kong  
 Tel: +852 2636 6861 Fax: +852 2637 0966

**RMA Request Form**  
 Date: \_\_\_\_\_

From: \_\_\_\_\_  
 Address: \_\_\_\_\_  
 Tel: \_\_\_\_\_ Fax: \_\_\_\_\_  
 E-Mail: \_\_\_\_\_  
 ATTN: \_\_\_\_\_

**Product Information:**

Item	Model	Serial Number	Return Category	Qty	Problem Description
1					
2					
3					
4					
5					
6					
7					
8					
9					
10					

**Notes:**  
 1. For 'Return Category' column, please select from **A:** Return of Defective Product, **B:** Return of Trial Sample, or **C:** Return of New and Unused Product.  
 2. If **A** or **C** category of return product is chosen, please give short description of the problem or reason for returning.

**Transportation Information:**  
 Location of Product: \_\_\_\_\_  
 Transportation Method: \_\_\_\_\_  
 Shipping Forwarder: \_\_\_\_\_

**Note:** Location of Product must be stated, while 'Transportation Method' or 'Shipping Forwarder' can be left blank if not determined.

**Signature:**

\_\_\_\_\_

---

**For Comba Use (Only)**  
 Return Merchandise Authorization Number (RMA#): \_\_\_\_\_  
 Recommended Action: \_\_\_\_\_  
 Shipment and Handling Cost to be paid by: \_\_\_\_\_

Approved by: \_\_\_\_\_

Date: \_\_\_\_\_

End of Section

End of Document

FOR NAM OFFICE EMAIL, PLEASE INSERT: [support.us@comba-telecom.com](mailto:support.us@comba-telecom.com)



### North America Office

Comba Telecom Inc.

235 Charcot Ave, San Jose, CA 95131, USA

Tel: +1 866 802 7961

Fax: +1 408 526 0181

Email: [customer.nam@comba-telecom.com](mailto:customer.nam@comba-telecom.com)

### Corporate Headquarters

Comba Telecom Systems Holdings Ltd

611 East Wing, No.8 Science Park West Avenue, Hong Kong Science Park, Hong Kong

Tel: +852 2636 6861

Fax: +852 2637 0966 / +852 2116 6055

[www.comba-telecom.com](http://www.comba-telecom.com)