



Test Report

Product Name : HKW-100 CK Bluetooth Easy
Model No. : HKW-100
FCC ID. : PWX-HKW100

Applicant : BenQ Mobile GmbH & Co. OHG

Address : Haidenauplatz 1, 81667 Munich, Germany

Date of Receipt : June 06, 2006

Issued Date : June 20, 2006

Report No. : 066L061-RF-US-P0601

The Test Results relate only to the samples tested.

The test report shall not be reproduced except in full without the written approval of Quietek Corporation.

This report must not be used to claim product endorsement by NVLAP any agency of the U.S. Government

Test Report Certification

Issued Date: June 20, 2006

Report No.: 066L061-RF-US-P0601



Product Name : HKW-100 CK Bluetooth Easy
Applicant : BenQ Mobile GmbH & Co. OHG
Address : Haidenauplatz 1, 81667 Munich, Germany
Manufacturer : Darfon Eletronics (Suzhou) Co., Ltd.
Model No. : HKW-100
FCC ID. : PWX-HKW100
Rated Voltage : AC 120V/60Hz
Working Voltage : DC 12V
Trade Name : BenQ-Siemens
Applicable Standard : FCC CFR Title 47 Part 15 Subpart C: 2005
ANSI C63.4: 2003
CISPR 22: 2005
Test Result : Complied

The Test Results relate only to the samples tested.

The test report shall not be reproduced except in full without the written approval of Quietek Corporation.

This report must not be used to claim product endorsement by NVLAP any agency of the U.S. Government

Documented By :



(Alfreda Hsu)



Tested By :



(Tom Hsieh)

Approved By :



(George Chen)



TABLE OF CONTENTS

Description	Page
1. GENERAL INFORMATION	5
1.1. EUT Description	5
1.2. Operational Description	6
1.3. Test System Details	7
1.4. Configuration of Tested System	7
1.5. EUT Exercise Software	7
1.6. Test Facility	8
2. CONDUCTED EMISSION	9
2.1. Test Equipment	9
2.2. Test Setup	9
2.3. Limits	9
2.4. Test Procedure	10
2.5. Uncertainty	10
2.6. Test Result of Conducted Emission	11
3. PEAK POWER OUTPUT	12
3.1. Test Equipment	12
3.2. Test Setup	12
3.3. Limits	12
3.4. Uncertainty	12
3.5. Test Result of Peak Power Output	13
4. RADIATED EMISSION	14
4.1. Test Equipment	14
4.2. Test Setup	15
4.3. Limits	15
4.4. Test Procedure	16
4.5. Uncertainty	16
4.6. Test Result of Radiated Emission	17
5. BAND EDGE	21
5.1. Test Equipment	21
5.2. Test Setup	21
5.3. Limits	22
5.4. Test Procedure	22
5.5. Uncertainty	22
5.6. Test Result of Band Edge	23
6. CHANNEL NUMBER	27
6.1. Test Equipment	27
6.2. Test Setup	27
6.3. Limits	27
6.4. Uncertainty	27
6.5. Test Result of Channel Number	28
7. CHANNEL SEPARATION	29
7.1. Test Equipment	29
7.2. Test Setup	29
7.3. Limits	29
7.4. Uncertainty	29
7.5. Test Result of Channel Separation	30
8. DWELL TIME	31
8.1. Test Equipment	31
8.2. Test Setup	31
8.3. Limits	31
8.4. Uncertainty	31
8.5. Test Result of Dwell Time	32
9. OCCUPIED BANDWIDTH	34
9.1. Test Equipment	34
9.2. Test Setup	34
9.3. Limits	34
9.4. Uncertainty	34
9.5. Test Result of Occupied Bandwidth	35

10. EMI REDUCTION METHOD DURING COMPLIANCE TESTING38
Attachment 1: EUT Test Photographs
Attachment 2: EUT Detailed Photographs

1. GENERAL INFORMATION

1.1. EUT Description

Product Name : HKW-100 CK Bluetooth Easy
 Trade Name : BenQ-Siemens
 FCC ID. : PWX-HKW100
 Model No. : HKW-100
 Frequency Range : 2402-2480MHz
 Antenna Gain : Refer to the table “Antenna List”
 Channel Number : 79
 Type of Modulation : FHSS
 Antenna Type : Chip Antenna
 Channel Control : Auto

Antenna List

No.	Manufacturer	Part No.	Peak Gain
1	Walsin	RFANT5220110A0T	2.66dBi

Frequency of Each Channel:

Channel	Frequency	Channel	Frequency	Channel	Frequency	Channel	Frequency
Channel 00:	2402 MHz	Channel 20:	2422 MHz	Channel 40:	2442 MHz	Channel 60:	2462 MHz
Channel 01:	2403 MHz	Channel 21:	2423 MHz	Channel 41:	2443 MHz	Channel 61:	2463 MHz
Channel 02:	2404 MHz	Channel 22:	2424 MHz	Channel 42:	2444 MHz	Channel 62:	2464 MHz
Channel 03:	2405 MHz	Channel 23:	2425 MHz	Channel 43:	2445 MHz	Channel 63:	2465 MHz
Channel 04:	2406 MHz	Channel 24:	2426 MHz	Channel 44:	2446 MHz	Channel 64:	2466 MHz
Channel 05:	2407 MHz	Channel 25:	2427 MHz	Channel 45:	2447 MHz	Channel 65:	2467 MHz
Channel 06:	2408 MHz	Channel 26:	2428 MHz	Channel 46:	2448 MHz	Channel 66:	2468 MHz
Channel 07:	2409 MHz	Channel 27:	2429 MHz	Channel 47:	2449 MHz	Channel 67:	2469 MHz
Channel 08:	2410 MHz	Channel 28:	2430 MHz	Channel 48:	2450 MHz	Channel 68:	2470 MHz
Channel 09:	2411 MHz	Channel 29:	2431 MHz	Channel 49:	2451 MHz	Channel 69:	2471 MHz
Channel 10:	2412 MHz	Channel 30:	2432 MHz	Channel 50:	2452 MHz	Channel 70:	2472 MHz
Channel 11:	2413 MHz	Channel 31:	2433 MHz	Channel 51:	2453 MHz	Channel 71:	2473 MHz
Channel 12:	2414 MHz	Channel 32:	2434 MHz	Channel 52:	2454 MHz	Channel 72:	2474 MHz
Channel 13:	2415 MHz	Channel 33:	2435 MHz	Channel 53:	2455 MHz	Channel 73:	2475 MHz
Channel 14:	2416 MHz	Channel 34:	2436 MHz	Channel 54:	2456 MHz	Channel 74:	2476 MHz
Channel 15:	2417 MHz	Channel 35:	2437 MHz	Channel 55:	2457 MHz	Channel 75:	2477 MHz
Channel 16:	2418 MHz	Channel 36:	2438 MHz	Channel 56:	2458 MHz	Channel 76:	2478 MHz
Channel 17:	2419 MHz	Channel 37:	2439 MHz	Channel 57:	2459 MHz	Channel 77:	2479 MHz
Channel 18:	2420 MHz	Channel 38:	2440 MHz	Channel 58:	2460 MHz	Channel 78:	2480 MHz
Channel 19:	2421 MHz	Channel 39:	2441 MHz	Channel 59:	2461 MHz		

The system receivers have input bandwidths that match the hopping channel bandwidths of their corresponding transmitters and shift frequencies in synchronization with the transmitted signals

Frequency hopping spread spectrum systems are not required to employ all available hopping channels during each transmission. The transmitter is presented with a continuous data stream. In addition, a system employing short transmission bursts must comply with the definition of a frequency hopping system and must distribute its 79 channels and over the minimum number of hopping channels (75 channels).

The incorporation of intelligence within a frequency hopping spread spectrum system that permits the system to recognize other users within the spectrum band so that it individually and independently chooses and adapts its hopsets to avoid hopping on occupied channels is permitted. The coordination of frequency hopping systems in any other manner for the express purpose of avoiding the simultaneous occupancy of individual hopping frequencies by multiple transmitters is not permitted.

Note:

1. The EUT is HKW-100 CK Bluetooth Easy with a built-in 2.4GHz transceiver.
2. These tests were conducted on a sample of the equipment for the purpose of demonstrating compliance with Part 15 Subpart C Paragraph 15.247 for spread spectrum devices.
3. Regarding to the operating frequency range, the lowest, middle, and highest frequency were selected to perform the test.
4. This device is a composite device in accordance with Part 15 Subpart B regulations. The function for the receiver was measured and made the test report of the report number: 066L061-RF-US-P01V02, certified under Declaration of Conformity.
5. Quietek verified among construction and function in typical operation, then shown in this test report.
6. The radiation measurements are performed in X, Y, Z axis positioning. Only the worst case is shown in the report.

1.2. Operational Description

The EUT is HKW-100 CK Bluetooth Easy with a built-in 2.4GHz transceiver. The transmitted data are modulated by frequency hopping spread spectrum. The number of channels is 79 in 2402 – 2480MHz.

This device provides wireless technology that revolutionizes personal connectivity. It is the solution for the seamless integration of Bluetooth technology into personal computer enabling short-range wireless connections between desktop/laptop computers, Bluetooth-enabled peripherals, and portable handheld devices.

Test Mode:	Mode 1: Transmitter
------------	---------------------

1.3. Test System Details

The types for all equipment, plus descriptions of all cables used in the tested system (including inserted cards) are:

	Product	Manufacturer	Model No.	Serial No.	FCC ID	Power Cord
(1)	Battery	TRANE	12B50PE	N/A	DoC	N/A
(2)	Notebook P.C.	DELL	PP01L	96FFC A00	DoC	Non-Shielded, 1.8m

	Signal Cable Type	Signal cable Description
A.	DC Power Cable	Non-Shielded, 1.5m
B.	Remote Control Cable	Non-Shielded, 1.1m
C.	Printer Cable	Non-Shielded, 1.5m

1.4. Configuration of Tested System

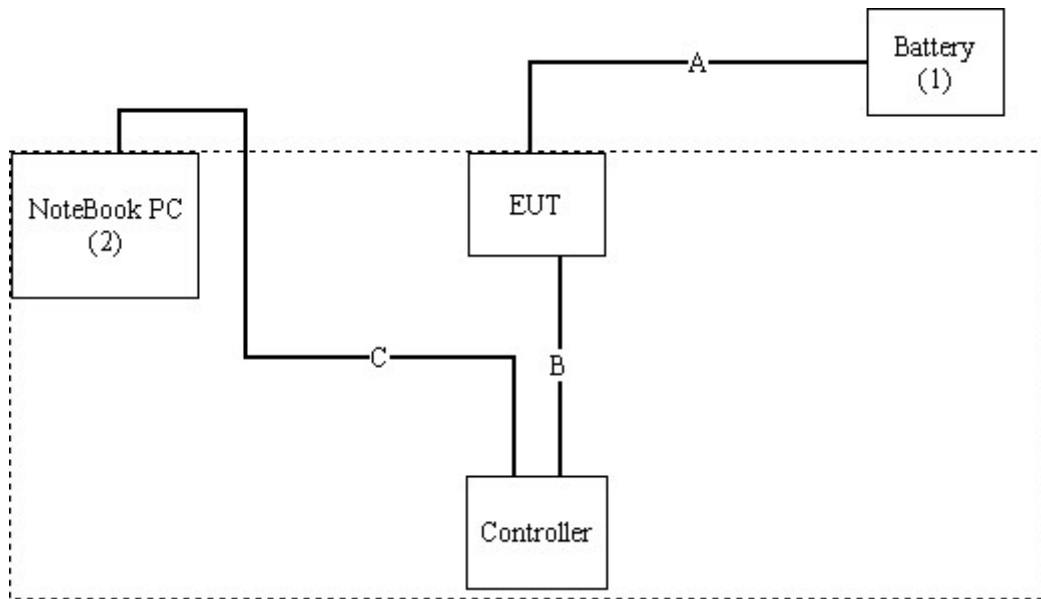

1.5. EUT Exercise Software

- (1) Setup the EUT as shown in section 1.4.
- (2) Install the CSR BlueSuite v1.9 on the notebook.
- (3) Execute the Bluetest program on the notebook.
- (4) Setup the test channel and the packet type=DH1.
- (5) Press OK to start the continuous transmission.
- (6) Verify that the EUT works properly.

1.6. Test Facility

Ambient conditions in the laboratory:

Items	Required (IEC 68-1)	Actual
Temperature (°C)	15-35	20-35
Humidity (%RH)	25-75	50-65
Barometric pressure (mbar)	860-1060	950-1000

Site Description: Federal Communications Commission
 FCC Engineering Laboratory
 7435 Oakland Mills Road
 Columbia, MD 21046
 Reference 31040/SIT1300F2



Accreditation on NVLAP
 NVLAP Lab Code: 200533-0



Site Name: Quietek Corporation

Site Address: No. 5-22, Ruei-Shu Valley, Ruei-Ping Tsuen,
 Lin-Kou Shiang, Taipei,
 Taiwan, R.O.C.
 TEL: 886-2-8601-3788 / FAX : 886-2-8601-3789
 E-Mail : service@quietek.com



2. Conducted Emission

2.1. Test Equipment

Item	Instrument	Manufacturer	Type No./Serial No	Last Cal.	Remark
1	Test Receiver	R & S	ESCS 30/825442/17	May, 2006	
2	L.I.S.N.	R & S	ESH3-Z5/825016/6	May, 2006	EUT
3	L.I.S.N.	Kyoritsu	KNW-407/8-1420-3	May, 2006	Peripherals
4	Pulse Limiter	R & S	ESH3-Z2	May, 2006	
5	No.1 Shielded Room				

Note: All equipments are calibrated every one year.

2.2. Test Setup

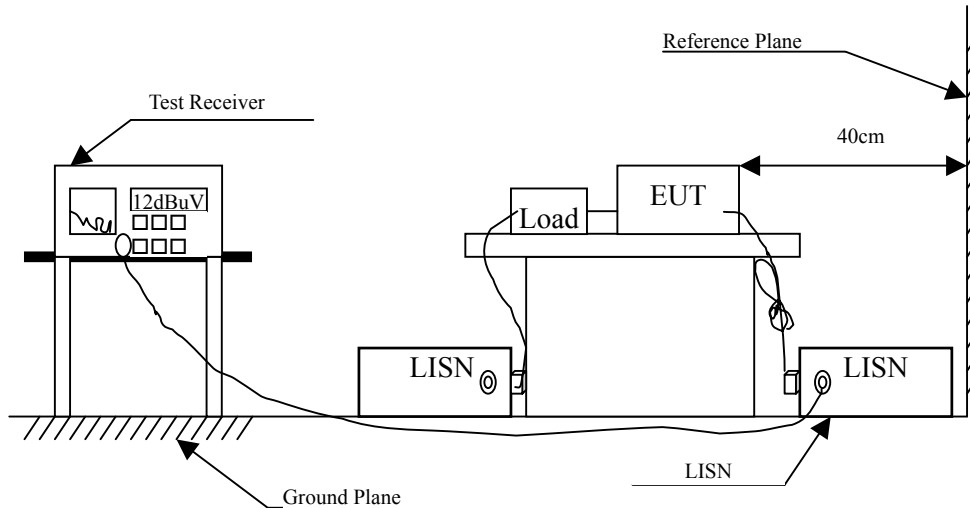

2.3. Limits

FCC Part 15 Subpart C Paragraph 15.207 (dBuV) Limit		
Frequency MHz	Limits	
	QP	AV
0.15 - 0.50	66-56	56-46
0.50-5.0	56	46
5.0 - 30	60	50

Remarks: In the above table, the tighter limit applies at the band edges.

2.4. Test Procedure

The EUT and simulators are connected to the main power through a line impedance stabilization network (L.I.S.N.). This provides a 50 ohm /50uH coupling impedance for the measuring equipment. The peripheral devices are also connected to the main power through a LISN that provides a 50ohm /50uH coupling impedance with 50ohm termination. (Please refer to the block diagram of the test setup and photographs.)

Both sides of A.C. line are checked for maximum conducted interference. In order to find the maximum emission, the relative positions of equipment and all the interface cables must be changed according to ANSI C63.4: 2003 on conducted measurement.

Conducted emissions were investigated over the frequency range from 0.15MHz to 30MHz using a receiver bandwidth of 9kHz.

2.5. Uncertainty

± 2.26 dB

2.6. Test Result of Conducted Emission

The EUT is powered by batteries. This test item is not performed

3. Peak Power Output

3.1. Test Equipment

The following test equipments are used during the radiated emission tests:

	Equipment	Manufacturer	Model No./Serial No.	Last Cal.
X	Spectrum Analyzer	Agilent	E4407B / US39440758	May, 2006

- Note:
1. All equipments are calibrated every one year.
 2. The test instruments marked “X” are used to measure the final test results.

3.2. Test Setup

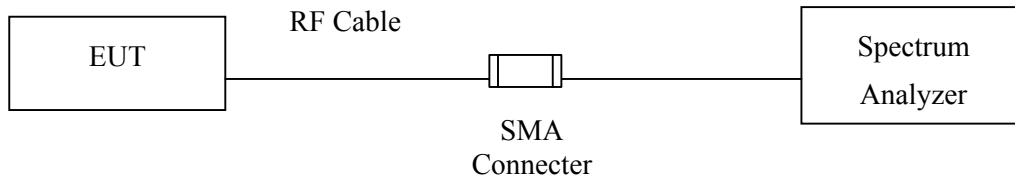

3.3. Limits

The maximum peak power shall be less 1Watt.

3.4. Uncertainty

± 1.27 dB

3.5. Test Result of Peak Power Output

Product : HKW-100 CK Bluetooth Easy
 Test Item : Peak Power Output
 Test Site : No.3 OATS
 Test Mode : Mode 1: Transmitter

Channel No.	Frequency (MHz)	Measurement	Required Limit	Result
Channel 00	2402.00	0.54dBm	1 Watt= 30 dBm	Pass
Channel 39	2441.00	0.16dBm	1 Watt= 30 dBm	Pass
Channel 78	2480.00	0.52dBm	1 Watt= 30 dBm	Pass

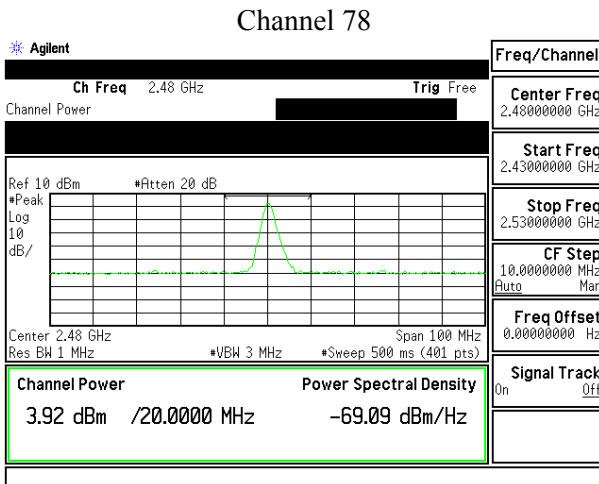
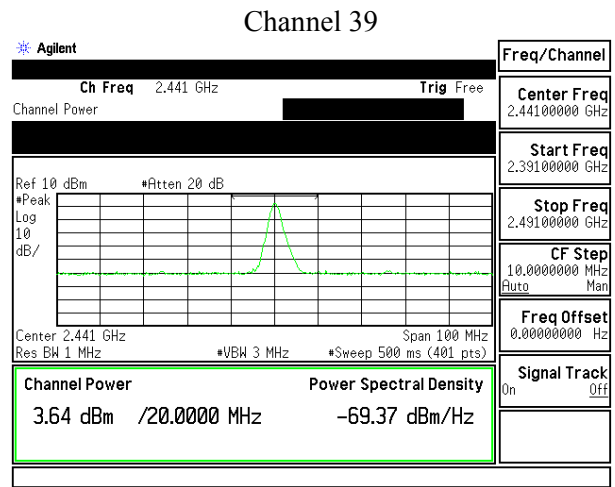
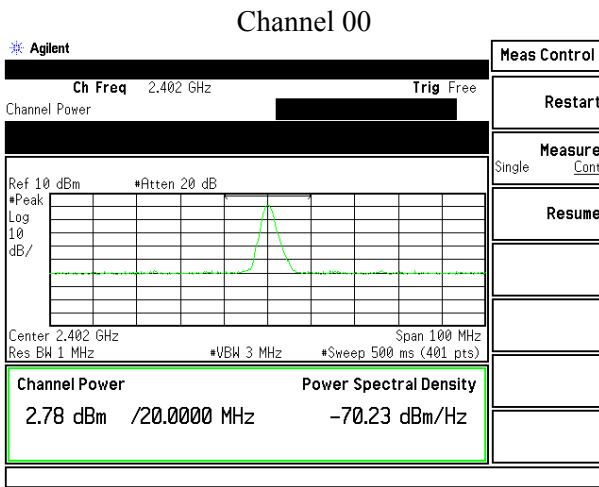

Note:

1. Spectrum Analyzer Setting (Peak Detector): RBW: 1MHz; VBW: 1MHz; Span: 100MHz .

4. Radiated Emission

4.1. Test Equipment

Test Site		Equipment	Manufacturer	Model No./Serial No.	Last Cal.
<input type="checkbox"/> Site # 1		Test Receiver	R & S	ESVS 10 / 834468/003	May, 2006
		Spectrum Analyzer	Advantest	R3162/ 00803480	May, 2006
		Pre-Amplifier	Advantest	BB525C/ 3307A01812	May, 2006
		Bilog Antenna	SCHAFFNER	CBL6112B / 2697	Sep., 2005
<input type="checkbox"/> Site # 2		Test Receiver	R & S	ESCS 30 / 836858 / 022	May, 2006
		Spectrum Analyzer	Advantest	R3162 / 100803466	May, 2006
		Pre-Amplifier	Advantest	BB525C/3307A01814	May, 2006
		Bilog Antenna	SCHAFFNER	CBL6112B / 2705	May, 2006
		Horn Antenna	ETS	3115 / 0005-6160	Sep., 2005
		Pre-Amplifier	QTK	QTK-AMP-01/ 0001	May, 2006
<input checked="" type="checkbox"/> Site # 3	X	Test Receiver	R & S	ESI 26 / 838786/004	May, 2006
	X	Spectrum Analyzer	Advantest	R3162 / 100803480	May, 2006
	X	Bilog Antenna	SCHAFFNER	CBL6112B / 2697	May, 2006
	X	Horn Antenna	Schwarzbeck	9120D / 305, 306	July, 2006
	X	Horn Antenna	Schwarzbeck	BBHA9170 / 208, 209	July, 2006
	X	Pre-Amplifier	QTK	QTK-AMP-03 / 0003	May, 2006
	X	Pre-Amplifier	HP	8449B / 3008A01123	July, 2006
	X	Pre-Amplifier	MITEQ	AMF-4D-180400-45-6P	May, 2006

Note: 1. All equipments are calibrated every one year.
 2. The test instruments marked "X" are used to measure the final test results.

4.2. Test Setup

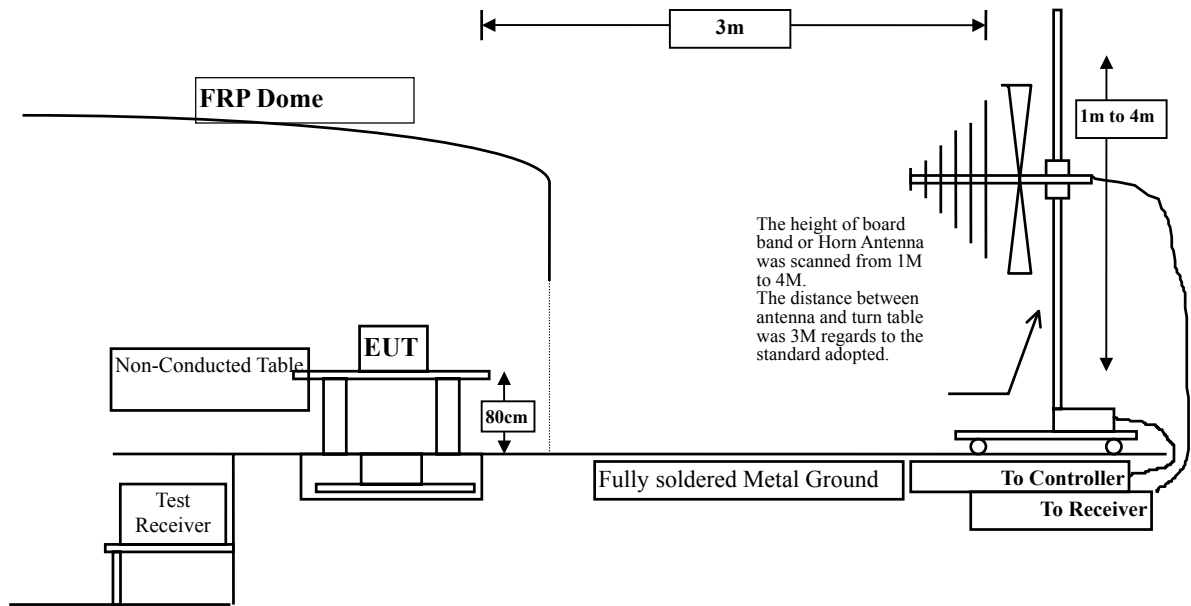

4.3. Limits

➤ General Radiated Emission Limits

Emissions radiated outside of the specified frequency bands, except for harmonics, shall be attenuated by at least 20dB below the level of the fundamental or to the general radiated emission limits in paragraph 15.209, whichever is the lesser attenuation.

FCC Part 15 Subpart C Paragraph 15.209 Limits		
Frequency MHz	uV/m @3m	dBuV/m@3m
30-88	100	40
88-216	150	43.5
216-960	200	46
Above 960	500	54

- Remarks:
1. RF Voltage (dBuV) = 20 log RF Voltage (uV)
 2. In the Above Table, the tighter limit applies at the band edges.
 3. Distance refers to the distance in meters between the measuring instrument antenna and the closed point of any part of the device or system.

4.4. Test Procedure

The EUT and its simulators are placed on a turn table which is 0.8 meter above ground. The turn table can rotate 360 degrees to determine the position of the maximum emission level.

The EUT was positioned such that the distance from antenna to the EUT was 3 meters.

The antenna can move up and down between 1 meter and 4 meters to find out the maximum emission level.

Both horizontal and vertical polarization of the antenna are set on measurement. In order to find the maximum emission, all of the interface cables must be manipulated according to ANSI C63.4: 2003 on radiated measurement.

The additional latch filter below 1GHz was used to measure the level of harmonics radiated emission during field strength of harmonics measurement.

The bandwidth below 1GHz setting on the field strength meter is 120 kHz, above 1GHz are 1 MHz.

The frequency range from 30MHz to 10th harmonics is checked.

4.5. Uncertainty

± 3.9 dB above 1GHz

± 3.8 dB below 1GHz

4.6. Test Result of Radiated Emission

Product : HKW-100 CK Bluetooth Easy
 Test Item : Harmonic Radiated Emission
 Test Site : No.3 OATS
 Test Mode : Mode 1: Transmitter (Channel 00)

Frequency MHz	Correct Factor dB	Reading Level dBuV	Measurement Level dBuV/m	Margin dB	Limit dBuV/m
Horizontal					
Peak Detector:					
4804.000	3.737	46.160	49.897	-24.103	74.000
7206.000	10.741	34.110	44.852	-29.148	74.000
9608.000	14.854	32.550	47.404	-26.596	74.000
Average Detector:					
--					
Vertical					
Peak Detector:					
4804.000	3.737	49.570	53.307	-20.693	74.000
7206.000	10.741	36.270	47.012	-26.988	74.000
9608.000	14.854	33.400	48.254	-25.746	74.000
Average Detector:					
--					

Note:

1. The reading levels below 1GHz and above 1GHz are quasi-peak values and peak/average values, respectively.
2. Receiver setting (Peak Detector) : RBW:1MHz; VBW:1MHz; Span:100MHz ◦
3. Receiver setting (AVG Detector) : RBW:1MHz; VBW:30Hz; Span:20MHz ◦
4. Emission Level = Reading Level + Correct Factor.
5. The average measurement was not performed when the peak measured data under the limit of average detection. If the readings given are average, peak measurement should also be supplied.

Product : HKW-100 CK Bluetooth Easy
 Test Item : Harmonic Radiated Emission
 Test Site : No.3 OATS
 Test Mode : Mode 1: Transmitter (Channel 39)

Frequency MHz	Correct Factor dB	Reading Level dBuV	Measurement Level dBuV/m	Margin dB	Limit dBuV/m
Horizontal					
Peak Detector:					
4882.000	3.932	47.010	50.942	-23.058	74.000
7323.000	11.633	33.100	44.732	-29.268	74.000
9764.000	13.740	34.190	47.931	-26.069	74.000
Average Detector:					
--					
Vertical					
Peak Detector:					
4882.000	3.932	50.810	54.742	-19.258	74.000
7323.000	11.633	34.720	46.352	-27.648	74.000
9764.000	13.740	34.800	48.541	-25.459	74.000
Average Detector:					
4882.000	3.932	40.900	44.832	-9.168	54.000

Note:

1. The reading levels below 1GHz and above 1GHz are quasi-peak values and peak/average values, respectively.
2. Receiver setting (Peak Detector) : RBW:1MHz; VBW:1MHz; Span:100MHz ◦
3. Receiver setting (AVG Detector) : RBW:1MHz; VBW:30Hz; Span:20MHz ◦
4. Emission Level = Reading Level + Correct Factor.
5. The average measurement was not performed when the peak measured data under the limit of average detection. If the readings given are average, peak measurement should also be supplied.

Product : HKW-100 CK Bluetooth Easy
 Test Item : Harmonic Radiated Emission
 Test Site : No.3 OATS
 Test Mode : Mode 1: Transmitter (Channel 78)

Frequency MHz	Correct Factor dB	Reading Level dBuV	Measurement Level dBuV/m	Margin dB	Limit dBuV/m
Horizontal					
Peak Detector:					
4960.000	4.151	47.290	51.440	-22.560	74.000
7440.000	12.067	34.470	46.537	-27.463	74.000
9920.000	13.472	32.890	46.362	-27.638	74.000
Average Detector:					
--					
Vertical					
Peak Detector:					
4960.000	4.151	51.960	56.110	-17.890	74.000
7440.000	12.067	35.280	47.347	-26.653	74.000
9920.000	13.472	33.610	47.082	-26.918	74.000
Average Detector:					
4960.000	4.151	31.900	36.050	-17.950	54.000

Note:

1. All Readings below 1GHz are Quasi-Peak, above are performed with peak and/or average measurements as necessary.
2. Receiver setting (Peak Detector) : RBW:1MHz; VBW:1MHz; Span:100MHz ◦
3. Receiver setting (AVG Detector) : RBW:1MHz; VBW:30Hz; Span:20MHz ◦
4. Emission Level = Reading Level + Correct Factor.
5. The average measurement was not performed when the peak measured data under the limit of average detection. If the readings given are average, peak measurement should also be supplied.

Product : HKW-100 CK Bluetooth Easy
 Test Item : General Radiated Emission
 Test Site : No.3 OATS
 Test Mode : Mode 1: Transmitter (Channel 39)

Frequency MHz	Correct Factor dB	Reading Level dBuV	Measurement Level dBuV/m	Margin dB	Limit dBuV/m
Horizontal					
42.100	12.480	17.100	29.580	-10.420	40.000
192.400	8.417	7.970	16.387	-27.113	43.500
287.100	12.445	10.700	23.145	-22.855	46.000
461.600	17.362	18.200	35.562	-10.438	46.000
590.100	18.781	7.410	26.191	-19.809	46.000
607.100	18.739	16.200	34.939	-11.061	46.000
Vertical					
42.100	11.217	20.100	31.317	-8.683	40.000
284.600	12.767	10.100	22.867	-23.133	46.000
500.400	17.038	16.100	33.138	-12.862	46.000
544.100	19.294	16.800	36.094	-9.906	46.000
595.100	20.415	8.100	28.515	-17.485	46.000
689.600	18.916	15.500	34.416	-11.584	46.000

Note:

1. The reading levels below 1GHz are quasi-peak values.
2. “ * ” means this data is the worst emission level.
3. Measurement Level = Reading Level + Correct Factor.
4. The radiated emissions below 1GHz of the lowest, middle, highest frequency are pretested. Only the worst case is shown on the report.

5. Band Edge

5.1. Test Equipment

	Equipment	Manufacturer	Model No./Serial No.	Last Cal.
X	Spectrum Analyzer	Advantest	R3272 / 72421194	May, 2006
X	Test Receiver	R & S	ESCS 30 / 825442/14	May, 2006
X	Spectrum Analyzer	Agilent	E4407B / US39440758	May, 2006
X	Pre-Amplifier	HP	8447D/3307A01812	May, 2006
X	Bilog Antenna	Chase	CBL6112B / 12452	Sep., 2005
X	Horn Antenna	EM	EM6917 / 103325	May, 2006

Note: 1. All equipments are calibrated every one year.
 2. The test equipments marked "X" are used to measure the final test results.

5.2. Test Setup

RF Radiated Measurement:

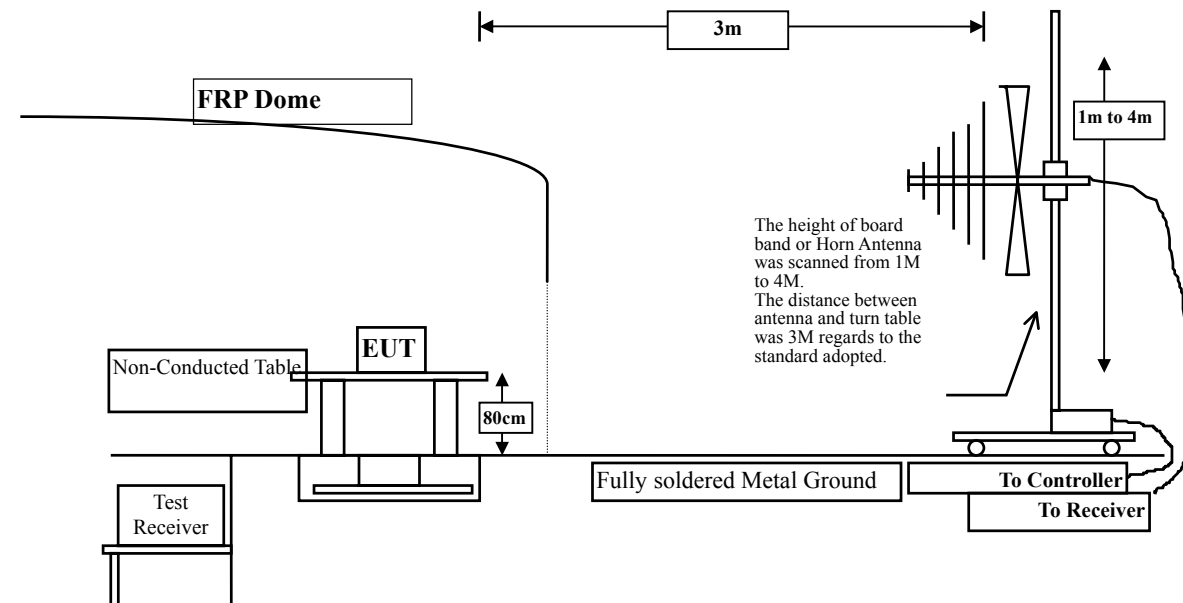

5.3. Limits

In any 100 kHz bandwidth outside the frequency band in which the spread spectrum intentional radiator is operating, the radio frequency power that is produced by the intentional radiator shall be at least 20 dB below that in the 100 kHz bandwidth within the band that contains the highest level of the desired power, based on either an RF conducted or a radiated measurement. Attenuation below the general limits specified in Section 15.209(a) is not required. In addition, radiated emissions which fall in the restricted bands, as defined in Section 15.205(a), must also comply with the radiated emission limits specified in Section 15.209(a) (see Section 15.205(c)).

5.4. Test Procedure

The EUT and its simulators are placed on a turn table which is 0.8 meter above ground. The turn table can rotate 360 degrees to determine the position of the maximum emission level. The EUT was positioned such that the distance from antenna to the EUT was 3 meters.

The antenna can move up and down between 1 meter and 4 meters to find out the maximum emission level.

Both horizontal and vertical polarization of the antenna are set on measurement. In order to find the maximum emission, all of the interface cables must be manipulated according to ANSI C63.4:2003 on radiated measurement.

The bandwidth below 1GHz setting on the field strength meter is 120 kHz, above 1GHz are 1 MHz.

5.5. Uncertainty

± 3.9 dB above 1GHz

± 3.8 dB below 1GHz

5.6. Test Result of Band Edge

Product : HKW-100 CK Bluetooth Easy
 Test Item : Band Edge
 Test Site : No.3 OATS
 Test Mode : Mode 1: Transmitter (Channel 00)

RF Radiated Measurement:

Channel No.	Frequency (MHz)	Required Limit (dBc)	Result
00	<2400	>20	Pass

RF Radiated Measurement (Horizontal):

Channel No.	Frequency (MHz)	Correct Factor (dB)	Reading Level (dBuV)	Emission Level (dBuV/m)	Peak Limit (dBuV/m)	Average Limit (dBuV/m)	Result
00 (Peak)	2483.219	-2.276	42.123	39.847	74.00	54.00	Pass
00 (Average)	--	--	--	--	74.00	54.00	Pass

Figure Channel 00: (Horizontal)

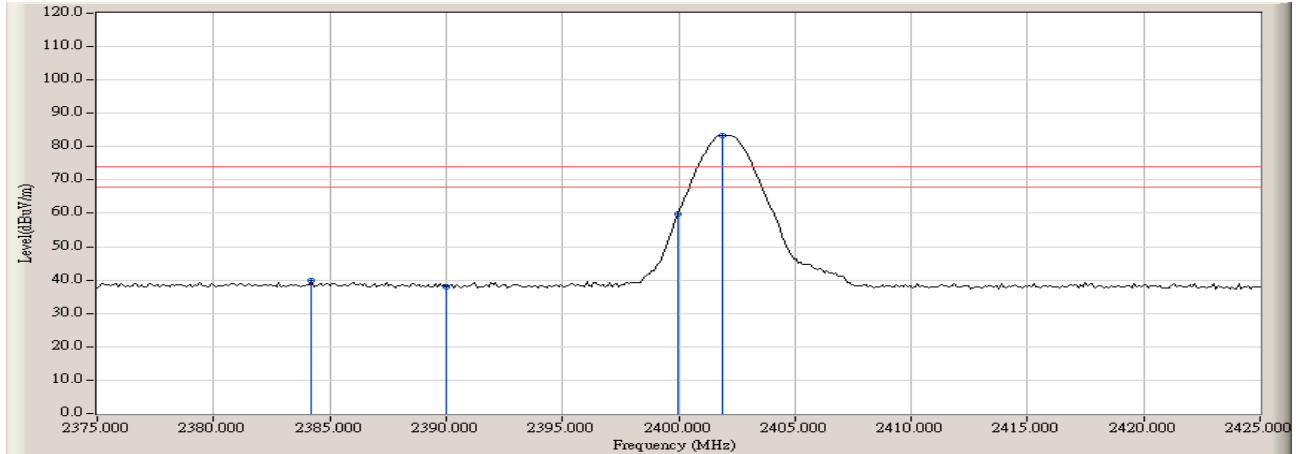

Note:

RBW=1MHz, VBW=1MHz, Sweep Time=500ms.

Product : HKW-100 CK Bluetooth Easy
 Test Item : Band Edge
 Test Site : No.3 OATS
 Test Mode : Mode 1: Transmitter (Channel 00)

RF Radiated Measurement:

Channel No.	Frequency (MHz)	Required Limit (dBc)	Result
00	<2400	>20	Pass

RF Radiated Measurement (Vertical):

Channel No.	Frequency (MHz)	Correct Factor (dB)	Reading Level (dBuV)	Emission Level (dBuV/m)	Peak Limit (dBuV/m)	Average Limit (dBuV/m)	Result
00 (Peak)	2380.511	-2.288	42.030	39.742	74.00	54.00	Pass
00 (Average)	--	--	--	--	74.00	54.00	Pass

Figure Channel 00: (Vertical)

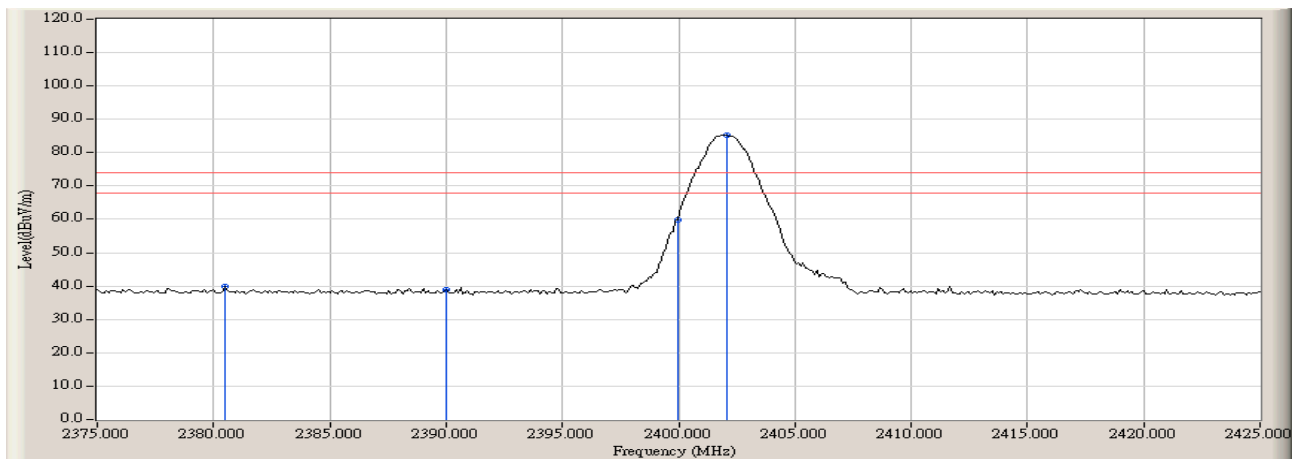

Note:

RBW=1MHz, VBW=1MHz, Sweep Time=500ms.

Product : HKW-100 CK Bluetooth Easy
 Test Item : Band Edge
 Test Site : No.3 OATS
 Test Mode : Mode 1: Transmitter (Channel 78)

RF Radiated Measurement:

Channel No.	Frequency (MHz)	Required Limit (dBc)	Result
78	>2483.5	>20	Pass

RF Radiated Measurement (Horizontal):

Channel No.	Frequency (MHz)	Correct Factor (dB)	Reading Level (dBuV)	Emission Level (dBuV/m)	Peak Limit (dBuV/m)	Average Limit (dBuV/m)	Result
00 (Peak)	2483.851	-1.894	48.861	46.967	74.00	54.00	Pass
00 (Average)	--	--	--	--	74.00	54.00	Pass

Figure Channel 78: (Horizontal)

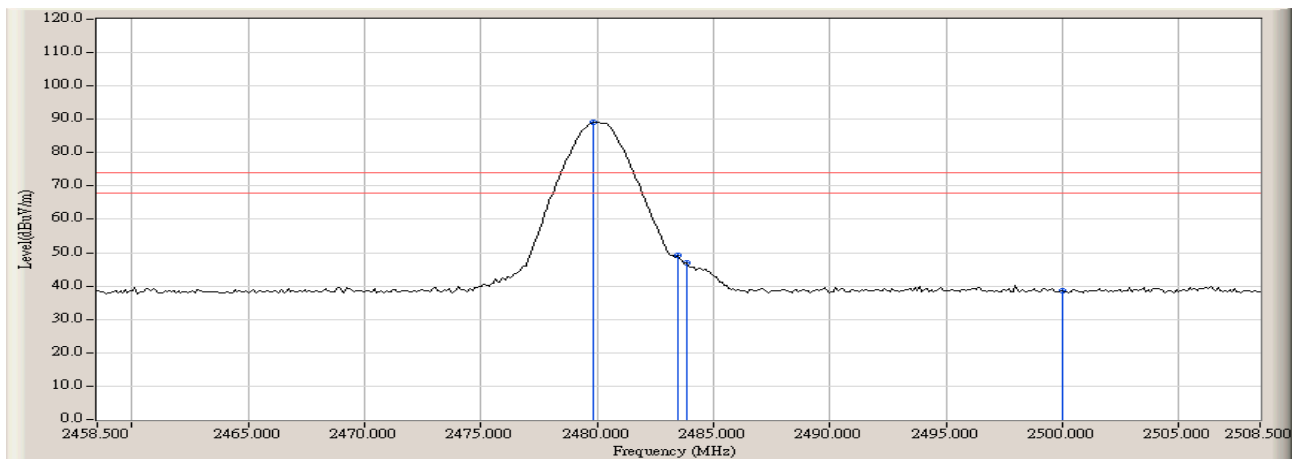

Note:

RBW=1MHz, VBW=1MHz, Sweep Time=500ms.

Product : HKW-100 CK Bluetooth Easy
 Test Item : Band Edge
 Test Site : No.3 OATS
 Test Mode : Mode 1: Transmitter (Channel 78)

RF Radiated Measurement:

Channel No.	Frequency (MHz)	Required Limit (dBc)	Result
78	>2483.5	>20	Pass

RF Radiated Measurement (Vertical):

Channel No.	Frequency (MHz)	Correct Factor (dB)	Reading Level (dBuV)	Emission Level (dBuV/m)	Peak Limit (dBuV/m)	Average Limit (dBuV/m)	Result
00 (Peak)	2483.750	-1.895	50.421	48.527	74.00	54.00	Pass
00 (Average)	--	--	--	--	74.00	54.00	Pass

Figure Channel 78: (Vertical)

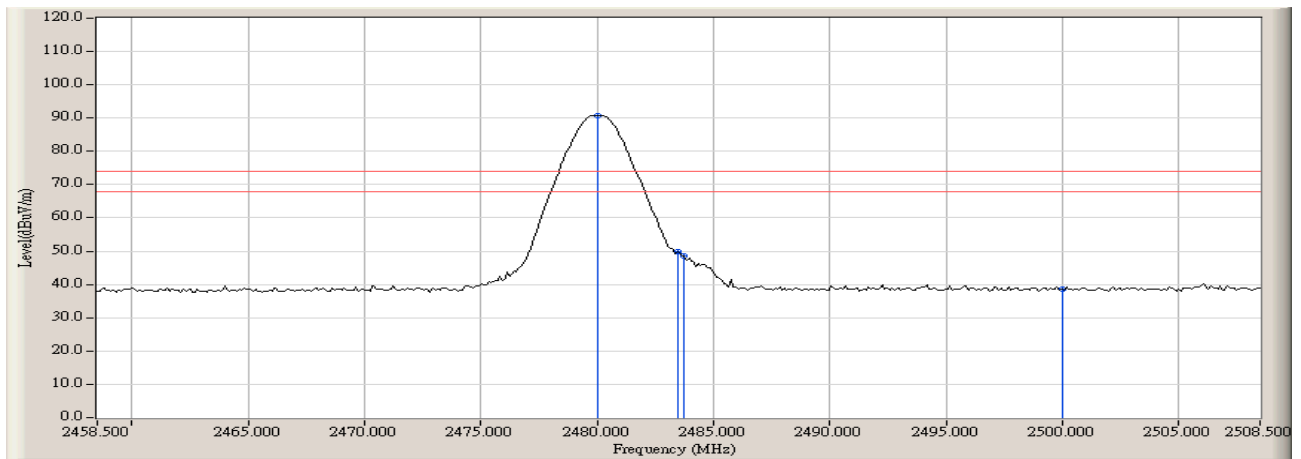

Note:

RBW=1MHz, VBW=1MHz, Sweep Time=500ms.

Note: The average measurement was not performed when the peak measured data under the limit of average detection. If the readings given are average, peak measurement should also be supplied.

6. Channel Number

6.1. Test Equipment

The following test equipments are used during the radiated emission tests:

	Equipment	Manufacturer	Model No./Serial No.	Last Cal.
X	Spectrum Analyzer	Agilent	E4407B / US39440758	May, 2006

Note: 1. All equipments are calibrated every one year.
 2. The test instruments marked “X” are used to measure the final test results.

6.2. Test Setup

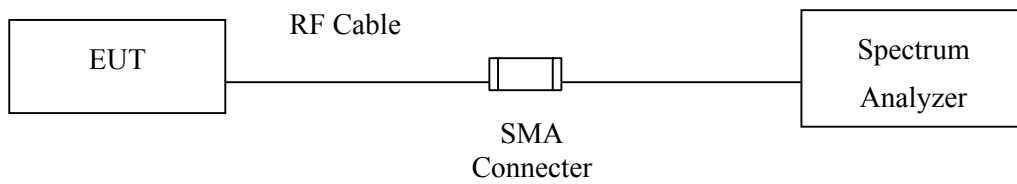

6.3. Limits

Frequency hopping systems operating in the 2400-2483.5 MHz bands shall use at least 75 hopping frequencies.

6.4. Uncertainty

N/A

6.5. Test Result of Channel Number

Product : HKW-100 CK Bluetooth Easy
 Test Item : Channel Number
 Test Site : No.3 OATS
 Test Mode : Mode 1: Transmitter

Frequency Range (MHz)	Measurement (Hopping Channel)	Required Limit (Hopping Channel)	Result
2402 ~ 2480	79	>75	Pass

2402-2417MHz

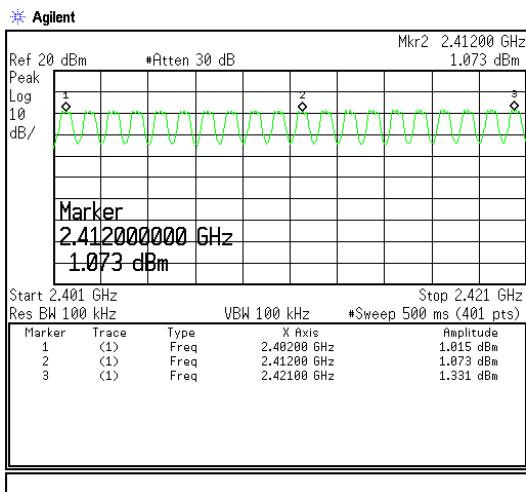

Marker
Select Marker
Marker Trace
Readout, Frequency
Function, Off
Marker Table
Marker All Off
More 2 of 2

2418-2437MHz

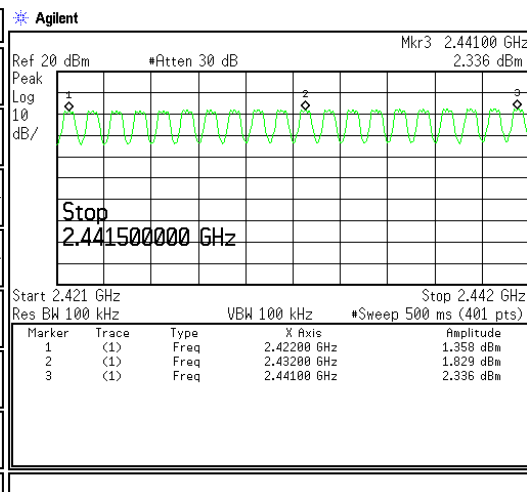

Freq/Channel
Center Freq
Start Freq
Stop Freq
CF Step
Freq Offset
Signal Track

2438-2457MHz

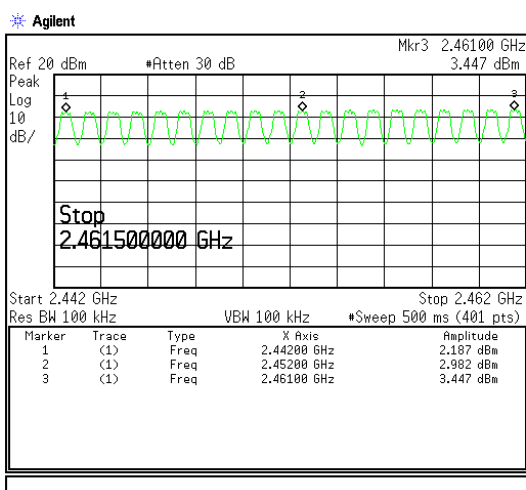

Freq/Channel
Center Freq
Start Freq
Stop Freq
CF Step
Freq Offset
Signal Track

2458-2480MHz

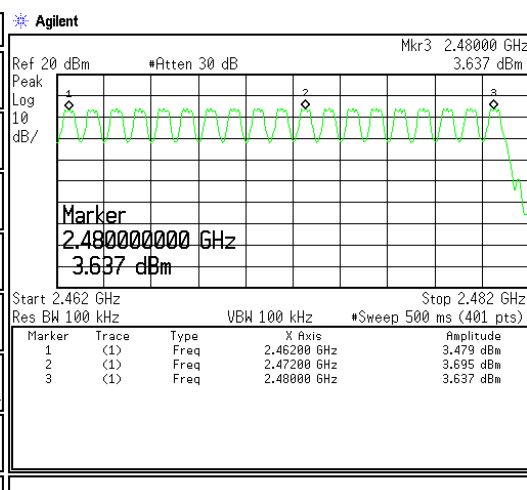

Marker
Select Marker
Normal
Delta
Delta Pair (Tracking Ref)
Span Pair
Off
More 1 of 2

7. Channel Separation

7.1. Test Equipment

The following test equipments are used during the radiated emission tests:

	Equipment	Manufacturer	Model No./Serial No.	Last Cal.
X	Spectrum Analyzer	Agilent	E4407B / US39440758	May, 2006

Note: 1. All equipments are calibrated every one year.
 2. The test instruments marked “X” are used to measure the final test results.

7.2. Test Setup

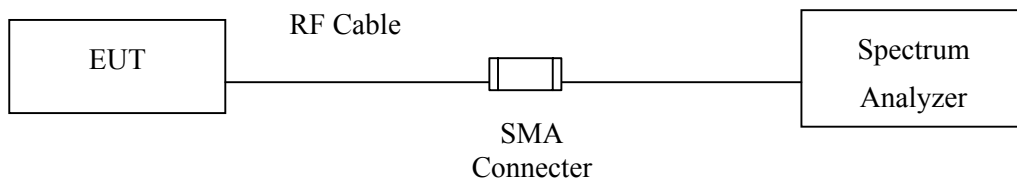

7.3. Limits

Frequency hopping systems shall have hopping channel carrier frequencies separated by a minimum of 25 kHz or the 20 dB bandwidth of the hopping channel, whichever is greater.

7.4. Uncertainty

± 150Hz

7.5. Test Result of Channel Separation

Product : HKW-100 CK Bluetooth Easy
 Test Item : Channel Separation
 Test Site : No.3 OATS
 Test Mode : Mode 1: Transmitter

Frequency (MHz)	Measurement Level (MHz)	Required Limit	Result
2402	1.00	>25 kHz or 2/3 * 20 dB BW	Pass
2441	1.00	>25 kHz or 2/3 * 20 dB BW	Pass
2480	1.00	>25 kHz or 2/3 * 20 dB BW	Pass

Channel 00 2402MHz

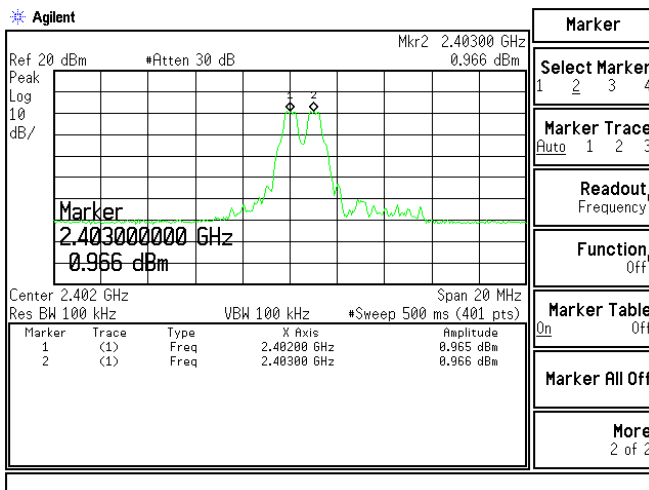

Channel 39 2441MHz

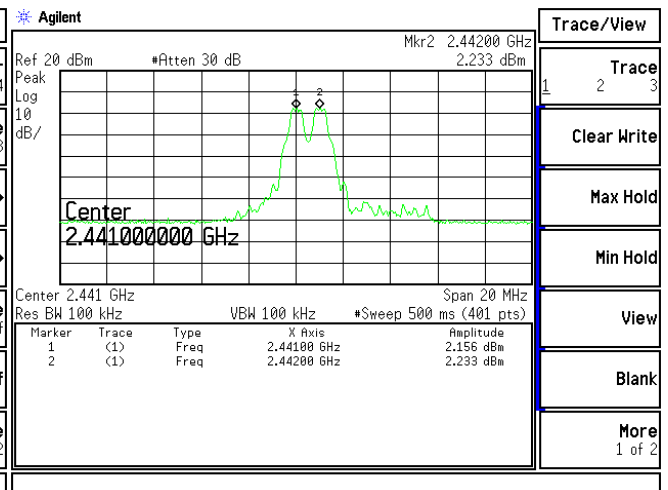

Channel 78 2480 MHz

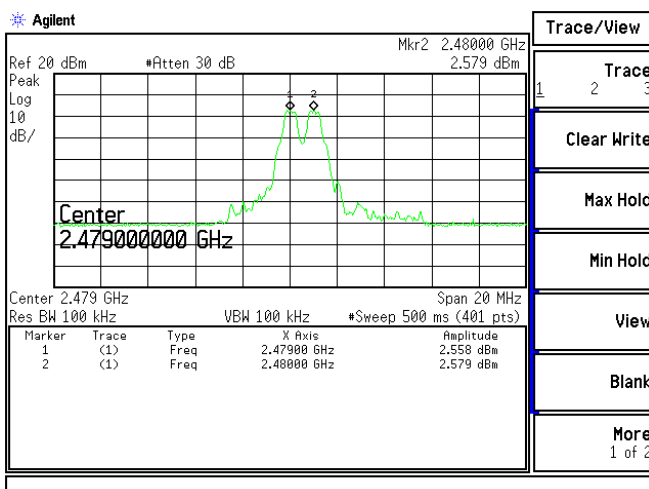

8. Dwell Time

8.1. Test Equipment

The following test equipments are used during the radiated emission tests:

	Equipment	Manufacturer	Model No./Serial No.	Last Cal.
X	Spectrum Analyzer	Agilent	E4407B / US39440758	May, 2006

Note: 1. All equipments are calibrated every one year.
 2. The test instruments marked “X” are used to measure the final test results.

8.2. Test Setup

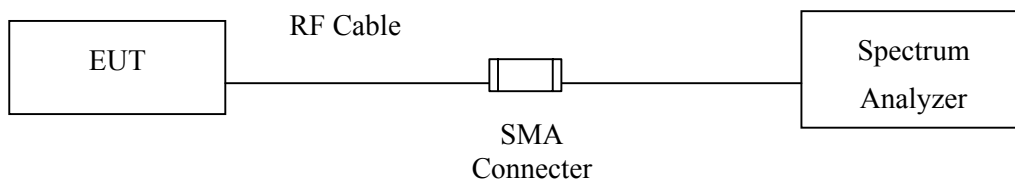

8.3. Limits

The dwell time shall be the average time of occupancy on any frequency shall not be greater than 0.4 seconds within a 30 second period.

8.4. Uncertainty

± 25msec

8.5. Test Result of Dwell Time

Product : HKW-100 CK Bluetooth Easy
 Test Item : Dwell Time
 Test Site : No.3 OATS
 Test Mode : Mode 1: Transmitter (Channel 00,39,78 –DH1)

Channel (MHz)	Measurement Level (ms)	Required Limit (sec.)	Result
CH 00 2402	128	< 0.4	Pass
CH 39 2441	128	< 0.4	Pass
CH 78 2480	128	< 0.4	Pass

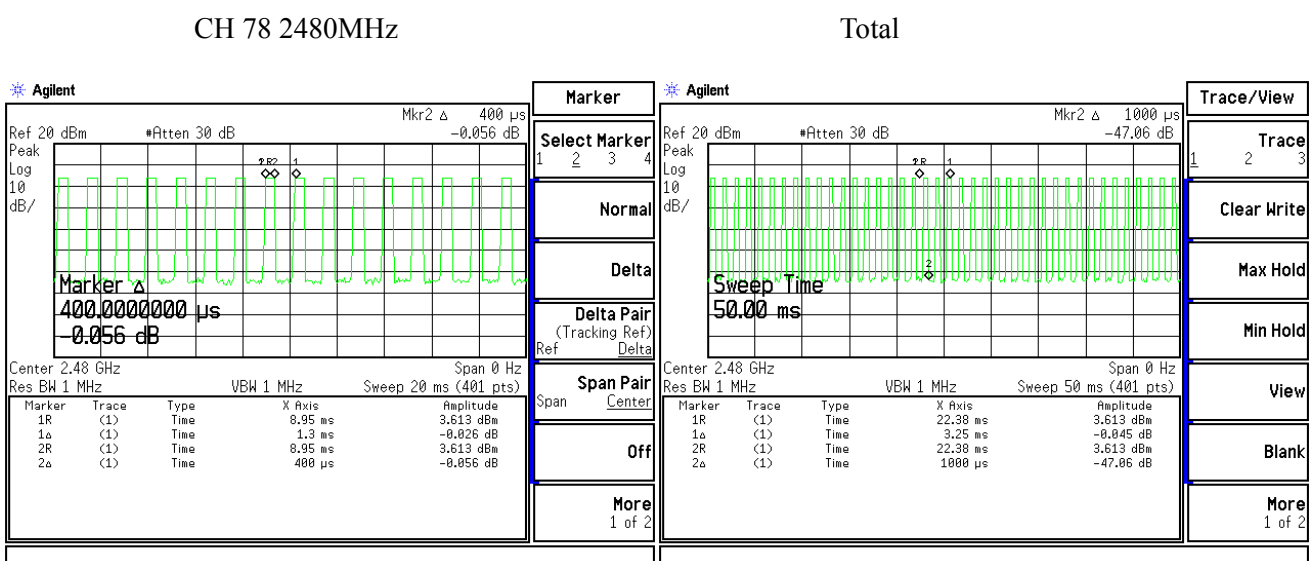
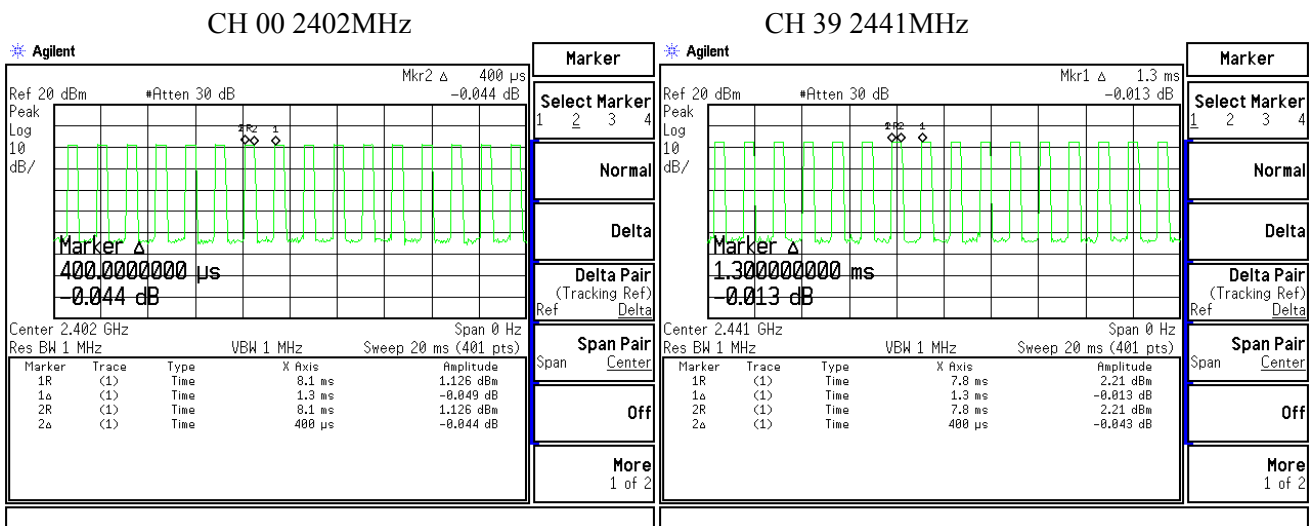

Note: Dwell time = time slot length * hop rate / number of hopping channels * period

Occupancy Time of Frequency Hopping System

Test Time Period: $0.4 * 79 = 31.6\text{sec}$, Hopping Times Within 1sec: $40/50\text{msec} = 0.8 \text{ hops/msec}$

A) 2402MHz The Maximum Occupancy Time Within 31.6sec: $400 \mu\text{s} * 800 / 79 * 31.6 = 128\text{msec}$ ◦

B) 2441MHz The Maximum Occupancy Time Within 31.6sec: $400 \mu\text{s} * 800 / 79 * 31.6 = 128\text{msec}$ ◦

C) 2480MHz The Maximum Occupancy Time Within 31.6sec: $400 \mu\text{s} * 800 / 79 * 31.6 = 128\text{msec}$ ◦

Test Result: The Average Occupancy Time of Each Highest , Middle and Lowest Channel Is Less Than 0.4sec , And Corresponds to The Standard ◦

PS: (1) From Bluetooth Specification , It Hops 1600 Times in 1sec ◦ The Average Occupancy Time of Each 79 Channels is $1600/79$ Times , Therefore , We Calculate The Maximum Occupancy Time (worse cars) As Below:

A) 2402Mhz The Occupancy Time of Each Pulse is 0.4msec , The Maximum Occupancy Time within 31.6sec is $0.4\text{msec} * 1640/79 * 31.6 = 289.056\text{msec}$

B) 2441MHz The Occupancy Time of Each Pulse is 0.4msec , The Maximum Occupancy Time within 31.6sec is $0.4\text{msec} * 1640/79 * 31.6 = 289.056\text{msec}$

C) 2480MHz The Occupancy Time of Each Pulse is 0.4msec , The Maximum Occupancy Time within 31.6sec is $0.4\text{msec} * 1640/79 * 31.6 = 289.056\text{msec}$

Test Result: The Maximum Occupancy Time of Each Highest , Middle and Lowest Channel Is Less Than 0.4sec , And Corresponds to The Standard ◦

9. Occupied Bandwidth

9.1. Test Equipment

The following test equipments are used during the radiated emission tests:

	Equipment	Manufacturer	Model No./Serial No.	Last Cal.
X	Spectrum Analyzer	Agilent	E4407B / US39440758	May, 2006

- Note:
1. All equipments are calibrated every one year.
 2. The test instruments marked “X” are used to measure the final test results.

9.2. Test Setup

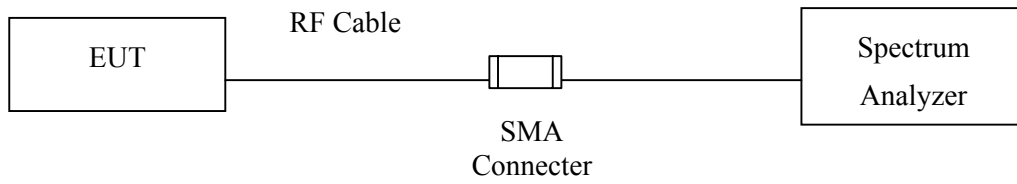

9.3. Limits

N/A

9.4. Uncertainty

± 150Hz

9.5. Test Result of Occupied Bandwidth

Product : HKW-100 CK Bluetooth Easy
 Test Item : Occupied Bandwidth Data
 Test Site : No.3 OATS
 Test Mode : Mode 1: Transmitter (2402MHz)

Channel No.	Frequency (MHz)	Measurement Level (kHz)	Required Limit (kHz)	Result
00	2402	1247	--	Pass

Figure Channel 00:

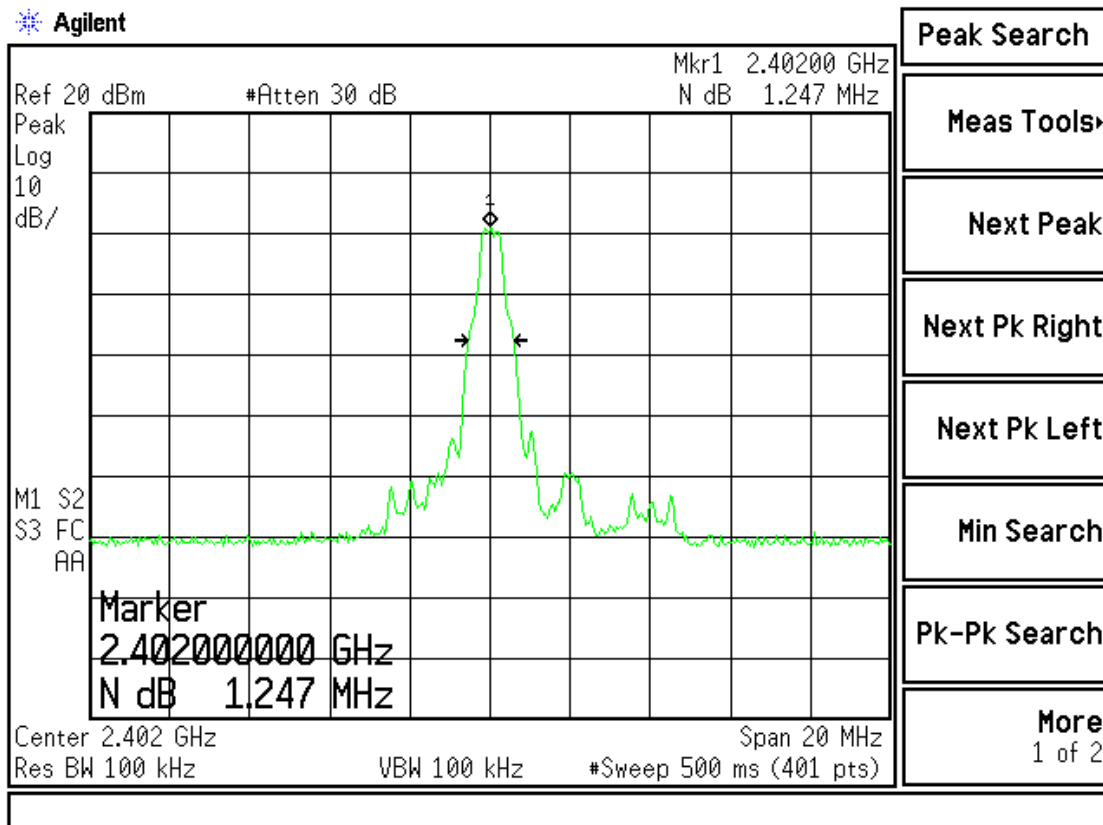

Product : HKW-100 CK Bluetooth Easy
 Test Item : Occupied Bandwidth Data
 Test Site : No.3 OATS
 Test Mode : Mode 1: Transmitter (2441MHz)

Channel No.	Frequency (MHz)	Measurement Level (kHz)	Required Limit (kHz)	Result
39	2441	1247	--	Pass

Figure Channel 39:

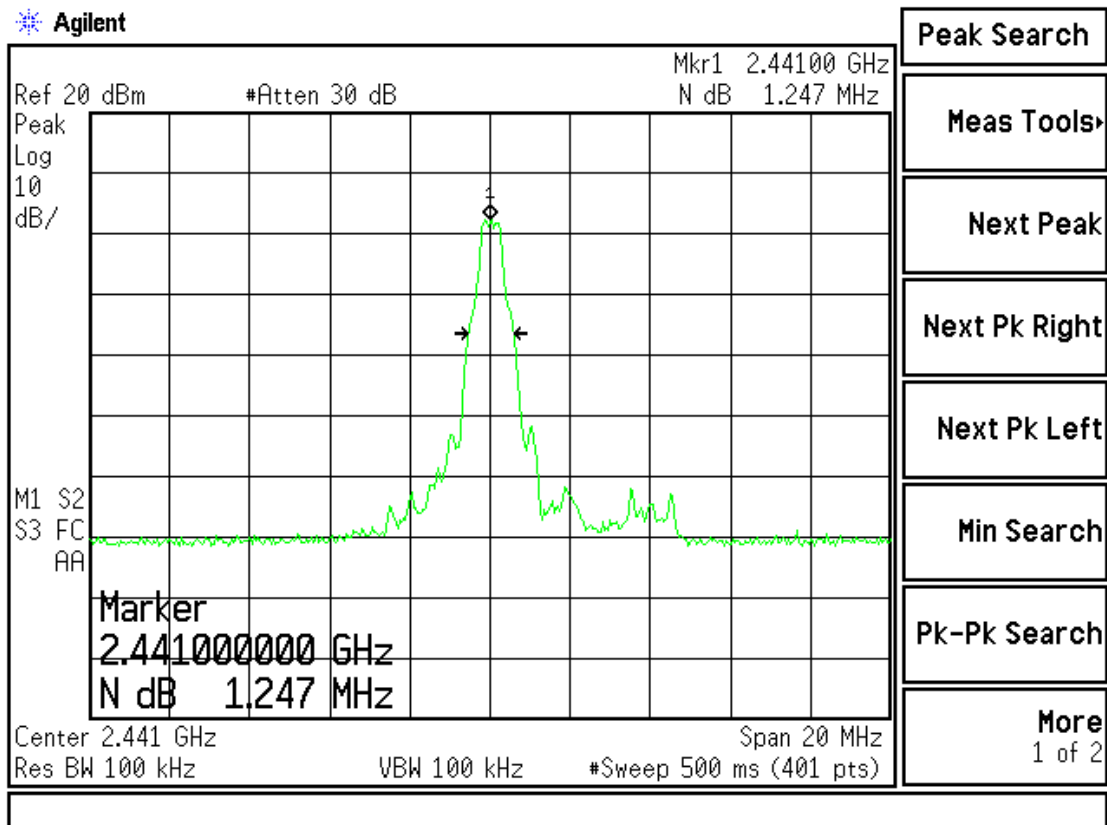

Product : HKW-100 CK Bluetooth Easy
 Test Item : Occupied Bandwidth Data
 Test Site : No.3 OATS
 Test Mode : Mode 1: Transmitter (2480MHz)

Channel No.	Frequency (MHz)	Measurement Level (kHz)	Required Limit (kHz)	Result
78	2480	1247	--	Pass

Figure Channel 78:

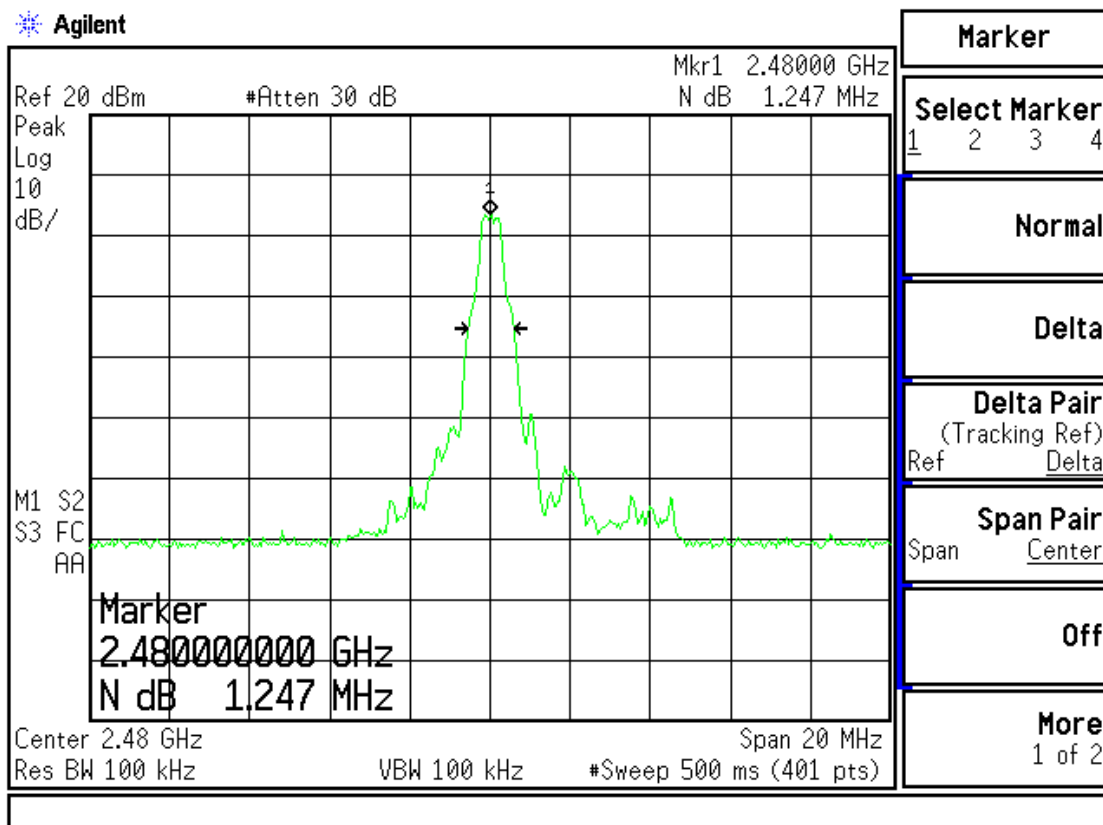

10. EMI Reduction Method During Compliance Testing

No modification was made during testing.

Attachment 1: EUT Test Photographs

Attachment 1: EUT Test Setup Photographs

Front View of Radiated Test



Back View of Radiated Test



Front View of Radiated Test (Horn)



Back View of Radiated Test (Horn)



Attachment 2: EUT Detailed Photographs

Attachment 2 : EUT Detailed Photographs

(1) EUT Photo



(2) EUT Photo



(3) EUT Photo



(4) EUT Photo



(5) EUT Photo

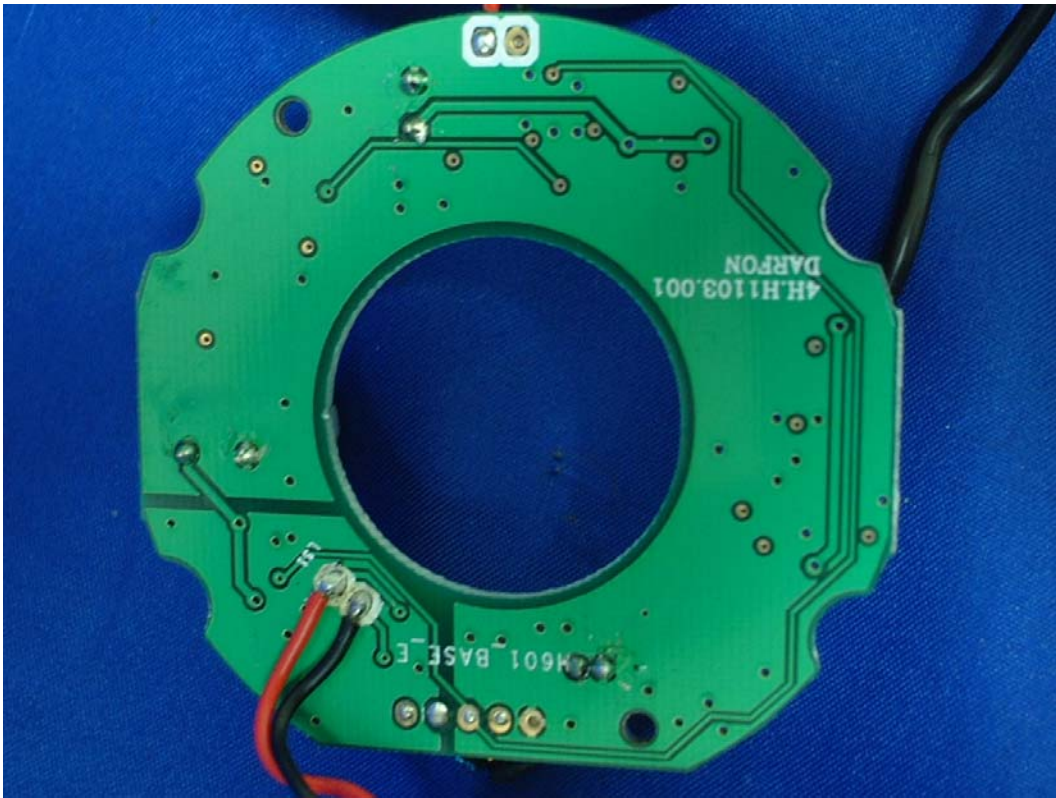

(6) EUT Photo

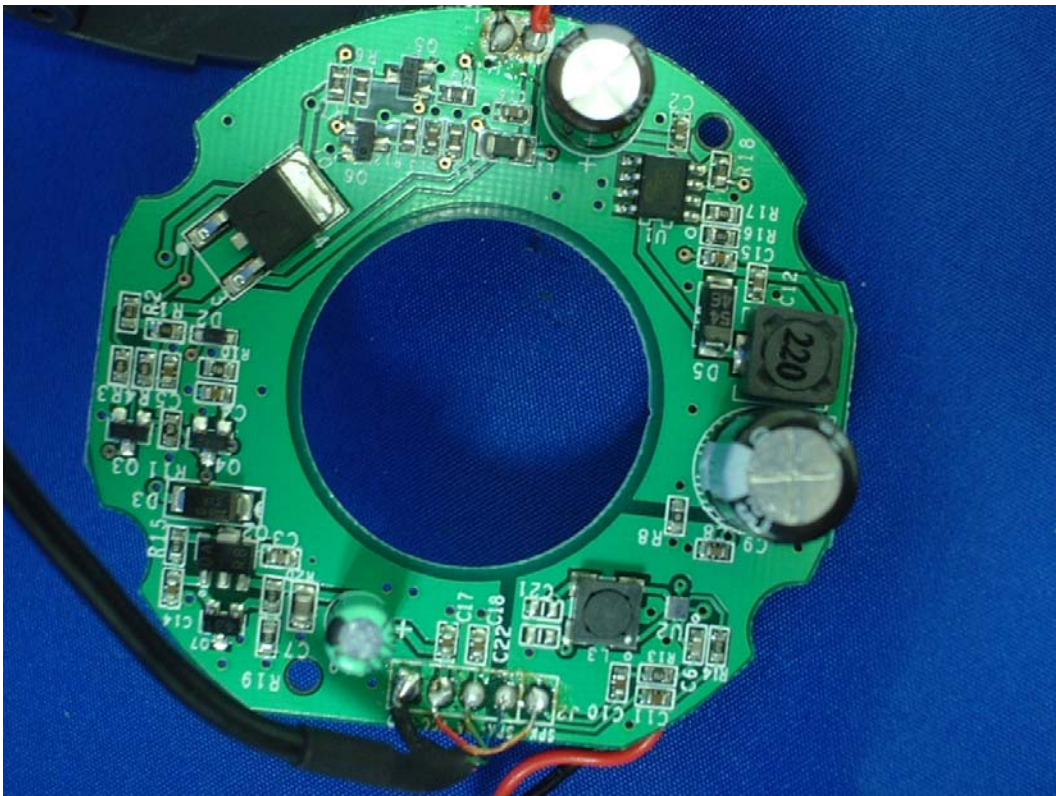

(7) EUT Photo



(8) EUT Photo

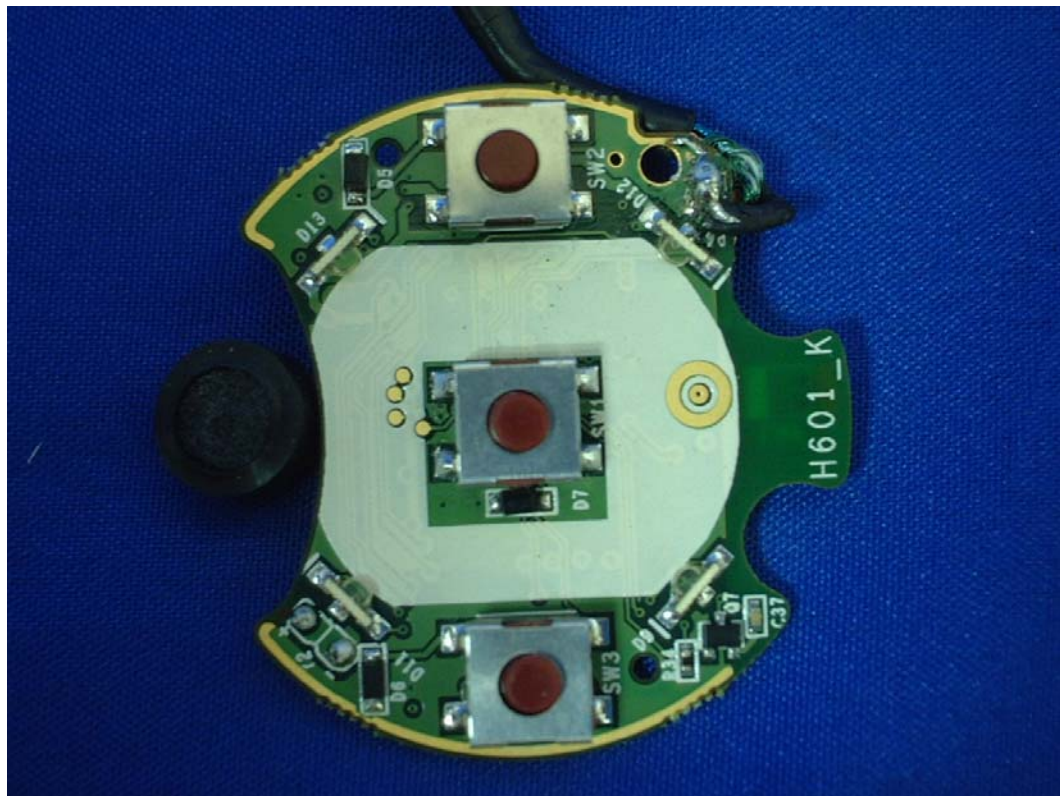

(9) EUT Photo

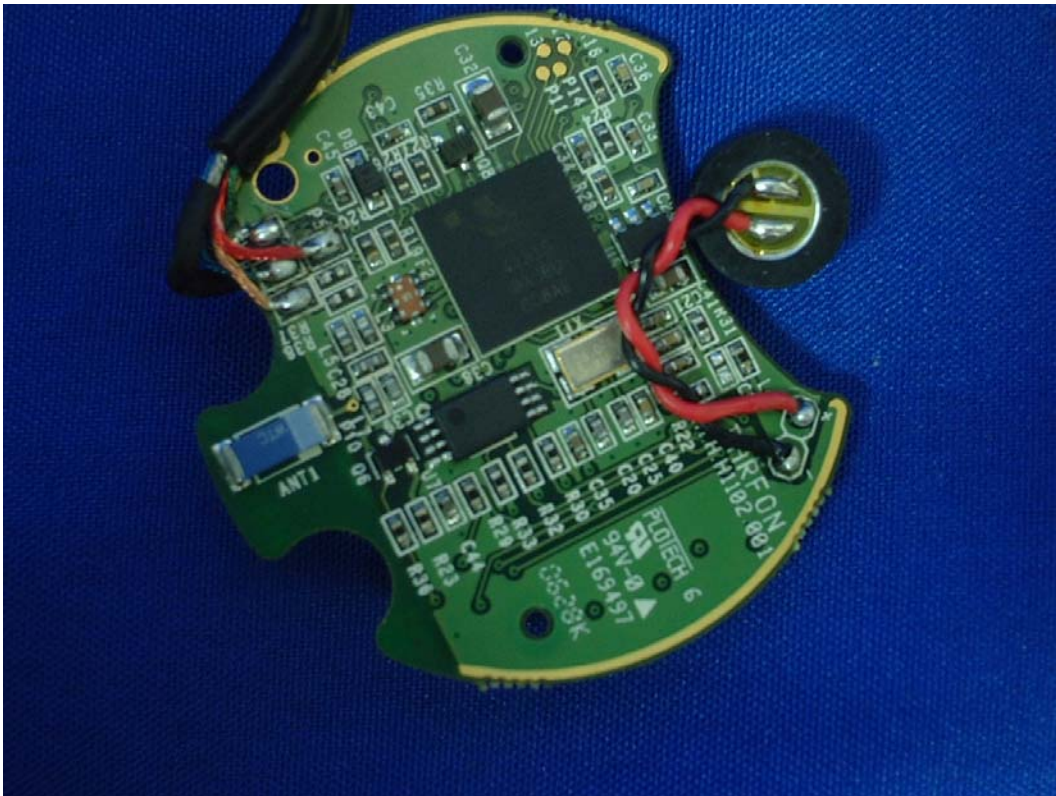

(10) EUT Photo

