

1 Package Contents / 包装内容 / 包装内容

Kindly ensure the product's contents upon unpacking; please refer to this quick start guide regarding the product's specifications and important notices. The items described below are the standard packaging.

打开包装确认产品包装内容,并详细阅读此手册,认识产品规格特性与注意事项。产品包装内容与数量依产品别而略有不同,实际内容以产品包装物为准。

打開包裝確認產品包裝內容,並請詳細閱讀此手冊,認識產品規格特性與注意事項。產品包裝內容與數量依產品別而略有不同,實際內容以產品包裝物為準。

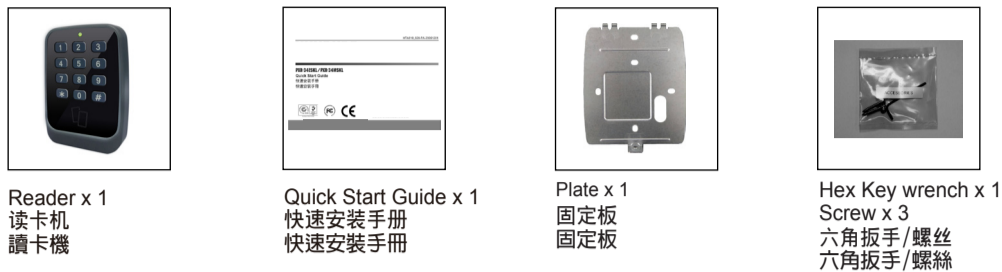

2 Physical Dimension / 外观尺寸 / 外觀尺寸

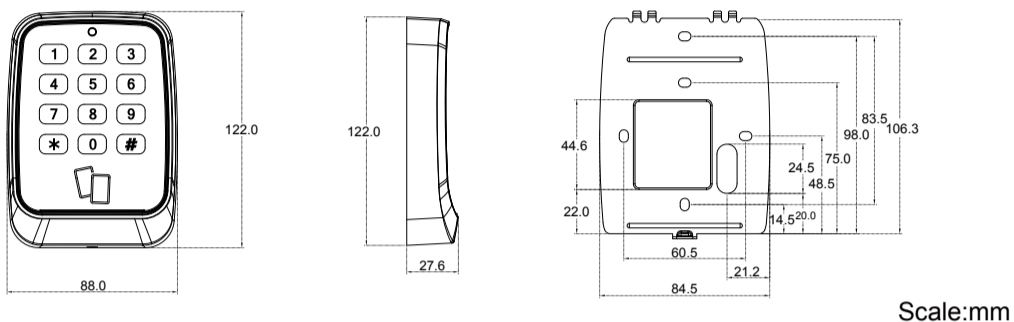

3 Installation / 安装 / 安裝

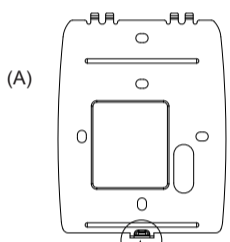

- Kindly refer to the "[4] wiring connections" wiring connections for the NODE ID settings before the hardware installation. Do not over tighten the back plate screws during installation to prevent distortion.
- (A) Mount the back plate onto the wall or other desired location.
- (B) Connect the wires in accordance with the wiring instruction below.
- (C) Make sure the back plate and the reader upper cover guides are aligned.
- (D) Install the reader upper cover to the back plate.
- (E) Using the hex key wrench, fasten the screw onto the bottom of the reader.

Warning / 安全警告 / 安全警語:
Please pay attention to two sides to avoid your hands getting injured while installing or removing the device.
拆裝時請注意兩端,以免受傷
拆裝時請注意兩端,以免受傷

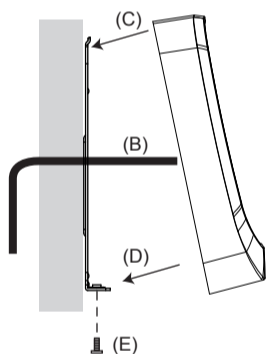

- 安裝前請先參考 "[4] 接線" 設定讀卡機 NODE ID 號。安裝讀卡機固定板時,請勿用力過大以避免造成彎曲變形。
- (A) 將安裝固定板固定在牆上或其他位置。
- (B) 依照接線說明將線接上,並將各接線端子插上。
- (C) 讀卡機上方對準固定板卡榫。
- (D) 將讀卡機往固定板方向密合。
- (E) 使用六角扳手將螺絲由下方將底部密合鎖上。

4 Wiring Connections / 接线 / 接線

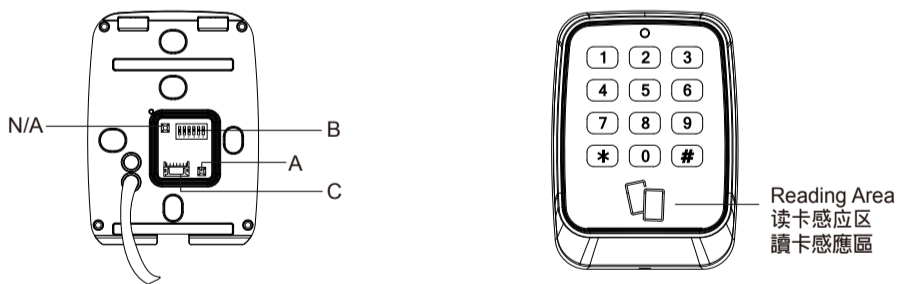

Before mounting the reader onto desired location. Please set the NODE ID (DIP Switch, binary number system). The position of the components varies according to the reader's model. Kindly take note of the components during setup.

調整讀卡機 NODE ID 請打開後蓋的螺絲,零件位置如後圖示意。

零件位置依照機型別而有所不同,請依實際零件編號做識別。

調整讀卡機 NODE ID 請打開後蓋的螺絲,零件位置如後圖示意。

零件位置依照機型別而有所不同,請依實際零件編號做識別。

A Case Sensor / 防拆除Sensor / 防拆除Sensor	
NODE ID Settings, refer to the chart below. 讀卡機 NODE ID, 請依照下表做配置 讀卡機 NODE ID, 請依照下表做配置	
Node ID	Configuration / 开关位址 / 開關位址
0	000000
1	100000
2	010000
3	110000
4	001000
5	101000
6	011000
7	111000
8	000100
9	100100
10	010100
11	110100
12	001100
13	101100
14	011100
15	111100

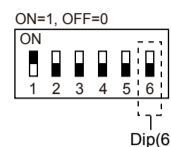

- Dip(6) is card format selection. ON is for reading the document, and OFF is for reading the serial number.
- Dip(6) 是卡片格式選擇。ON 為讀取文檔, OFF 為讀取序號。
- Dip(6) 是卡片格式選擇。ON 為讀取文檔, OFF 為讀取序號。

Pin	Color	Wiegand	RS-485
1	Red / 紅 / 紅	DC+12V IN	DC+12V IN
2	Black / 黑 / 黑	Ground	Ground
3	Yellow / 黃 / 黃	-	RS-485+
4	Deep Blue / 深藍 / 深藍	-	RS-485-
5	Gray / 灰 / 灰	-	-
6	Pink / 粉紅 / 粉紅	-	-
7	White & Black / 白黑 / 白黑	Ground	-
8	Orange / 橙 / 橙	-	-
9	Brown / 棕 / 棕	Green LED Control	-
10	Purple / 紫 / 紫	Beep Control	-
11	White / 白 / 白	Case Sensor GND (To Controller GND)	-
12	Green / 綠 / 綠	Case Sensor (To Controller Case Sensor)	-
13	Red & Black / 紅黑 / 紅黑	* W0	-
14	Light Blue / 淺藍 / 淺藍	* W1	-

*Do not use the same set of twisted pairs. 不可使用同一組雙絞線。不可使用同一組雙絞線。

Note:

- Kindly use minimum 22AWG double-shielded aluminum mylar foil twisted pair cable for the connection between the reader and the controller.
- In order to reduce long distance noise, The isolated net of transmission cable should connect to both ends of device ground.
- The distance between two readers should be over 30cm to prevent radio frequency interference from each other.
- Mounting the device around metal could affect read range. Metal of any type around the device should be avoided while mounting.
- The distance between the reader and the controller should not exceed 30 meters.
- For optimum read range, kindly use DC Linear power adaptor for the reader's power supply.
- In order to ensure the reader's normal operation, input voltage should be between 12V±10%.
- If the reader is installed in an open area or highly humid environment, it is recommended to protect the reader with an external shielding cover.
- RS-485 communication Baud rate is 9600.

备注:

- 讀卡機與控制器之間請使用22AWG以上的雙隔離網箔麥拉對絞傳輸線。
- 為了減低遠距離雜訊, 傳輸線的隔離網地應接兩端裝置的地。
- 建議兩個讀卡機之間的距離最少30公分以上。
- 避免安裝在金屬物週邊, 以免影響感應距離。
- 讀卡機與控制器的距離建議不要超過30米。
- 供應讀卡機之電源, 建議使用非交換式的線性直流電源, 以確保得到最佳的感應距離。
- 為確保讀卡機的正常運作, 輸入電源請確保在12V±10%之間。
- 如安裝在露天或高濕度易滲水的環境, 建議另行加裝防水罩。
- RS-485 通訊Baud rate 為9600。

備註:

- 讀卡機與控制器之間請使用22AWG以上的雙隔離網箔麥拉對絞傳輸線。
- 為了減低遠距離雜訊, 傳輸線的隔離網地應接兩端裝置的地。
- 建議兩個讀卡機之間的距離最少30公分以上。
- 避免安裝在金屬物週邊, 以免影響感應距離。
- 讀卡機與控制器的距離建議不要超過30米。
- 供應讀卡機之電源, 建議使用非交換式的線性直流電源, 以確保得到最佳的感應距離。
- 為確保讀卡機的正常運作, 輸入電源請確保在12V±10%之間。
- 如安裝在露天或高濕度易滲水的環境, 建議另行加裝防水罩。
- RS-485 通訊Baud rate 為9600。

One Year Limited Warranty / 产品保固证明书 / 產品保固證明書

We warrants this product against defect in material or workmanship for 1 year from the date of purchase. If such a defect is discovered within this warranty limitation, contact your direct vendor for repair or replacement of your unit. When returning the product, you must ship the product in its original packaging or packaging that gives an equal degree of protection. This warranty becomes invalid if the factory-supplied serial number has been removed or altered on the product. This warranty does not cover cosmetic damage or damage due to acts of God, accident, misuse, abuse, negligence or modification of any part of the product. This warranty does not cover damage due to improper operation or maintenance, connection to improper equipment, or attempted repair by anyone other than We. In no event shall We liability exceed the price paid for the product from direct, indirect, special, incidental, or consequential, damages resulting from the use of the product, its accompanying software, or its documentation. We makes no warranty or representation expressed, implied, or statutory, with respect to its products, contents of use of this documentation and all accompanying software, and specially disclaims its quality, performance, merchantability or fitness for any particular purpose. We reserves the right to revise or update its product, software or documentation without obligation to notify any individual or entity.

我們保固此產品於購買日起一年之內因為材料上或是生產製造中所產生的缺陷, 所造成的外觀上, 或是功能上的缺陷及故障問題。若是您在此保固期限之內發現此類問題, 請聯絡本公司的服務人員, 退回此產品, 我們將替您免費維修或是更換產品。當您退回此產品時, 請依照原始的包裝方式包裝此產品, 或是給予同等等級的包裝保護: 若是我們收到此產品時, 產品上沒有出廠時的序號標籤, 或是產品已經拆開或與出廠時有任何不同, 這個保固將變得無效。

此保固不包含天然的, 以及人為的破壞或改變, 或是意外事故、不正常操作、誤用、濫用等外在因素所造成的損壞。此保固不包含不當的操作或保養, 不當的連結至其他設備, 或是由本公司以外的人員企圖修復此產品。起因為使用這種產品, 在間接、特別、次要因素, 或者隨之發生, 造成伴隨著軟件或其他文檔的損害, 本公司的責任在任何情況下都不應超過此產品的售價。關於產品的軟件和文檔編制的全部內容, 本公司並沒有表示保證或法定它的性能、暢銷性, 或者適用於任何特別的目的。本公司保留權利修正或者不斷改進它的產品, 軟件或者文檔編制無義務通知任何個人或者購買者。

我們保固此產品於購買日起一年之內因為材料上或是生產製造中所產生的缺陷, 所造成的外觀上, 或是功能上的缺陷及故障問題。若是您在此保固期限之內發現此類問題, 請聯絡本公司的服務人員, 退回此產品, 我們將替您免費維修或是更換產品。當您退回此產品時, 請依照原始的包裝方式包裝此產品, 或是給予同等等級的包裝保護: 若是我們收到此產品時, 產品上沒有出廠時的序號標籤, 或是產品已經拆開或與出廠時有任何不同, 這個保固將變得無效。

此保固不包含天然的, 以及人為的破壞或改變, 或是意外事故、不正常操作、誤用、濫用等外在因素所造成的損壞。此保固不包含不當的操作或保養, 不當的連結至其他設備, 或是由本公司以外的人員企圖修復此產品。起因為使用這種產品, 在間接、特別、次要因素, 或者隨之發生, 造成伴隨著軟件或其他文檔的損害, 本公司的責任在任何情況下都不應超過此產品的售價。關於產品的軟件和文檔編制的全部內容, 本公司並沒有表示保證或法定它的性能、暢銷性, 或者適用於任何特別的目的。本公司保留權利修正或者不斷改進它的產品, 軟件或者文檔編制無義務通知任何個人或者購買者。

Model / 型号 / 型號	Serial no. / 序号 / 序號	Date of Purchase / 购买日期 / 購買日期	Reseller stamp / 经销商 / 經銷商

Warranty will be valid only after filling out this form and stamped or signed by reseller!
此保固書必須填寫各項內容, 並且蓋有經銷商印鑑始為有效。
此保固書必須填寫各項內容, 並且蓋有經銷商印鑑始為有效。



RS-485/WIEGAND PROXIMITY READER
GV-RKV1355

Quick Start Guide

快速安装手册

快速安装手册

Ver. 1.0

5 Testing / 测试 / 測試

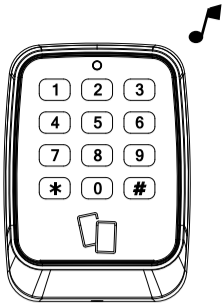

When the power is on, the reader's red LED and the reader will beep concurrently.
打开电源亮红色灯,同时听到“哔”声提示
打開電源亮紅色燈,同時聽到“嗶”聲提示



Place the card provided near the reader.
The reader will beep concurrently.
將卡片靠近讀卡機,同時聽到“嗶”聲提示。
將卡片靠近讀卡機,同時聽到“嗶”聲提示。

Federal Communication Commission Interference Statement

This equipment has been tested and found to comply with the limits for a Class B digital device, pursuant to Part 15 of the FCC Rules. These limits are designed to provide reasonable protection against harmful interference in a residential installation.

This equipment generates, uses and can radiate radio frequency energy and, if not installed and used in accordance with the instructions, may cause harmful interference to radio communications. However, there is no guarantee that interference will not occur in a particular installation. If this equipment does cause harmful interference to radio or television reception, which can be determined by turning the equipment off and on, the user is encouraged to try to correct the interference by one of the following measures:

- . Reorient or relocate the receiving antenna.
- . Increase the separation between the equipment and receiver.
- . Connect the equipment into an outlet on a circuit different from that to which the receiver is connected.
- . Consult the dealer or an experienced radio/TV technician for help.

FCC Caution: To assure continued compliance, any changes or modifications not expressly approved by the party responsible for compliance could void the user's authority to operate this equipment. (Example - use only shielded interface cables when connecting to computer or peripheral devices)

This device complies with Part 15 of the FCC Rules. Operation is subject to the following two conditions:

- (1) This device may not cause harmful interference, and
- (2) This device must accept any interference received, including interference that may cause undesired operation.