



Test Report

Prepared for: Wilson Electronics, Inc.

Model: 460005

Description: Dual Band In-Building Signal Booster

FCC ID: PWO460005

To

FCC Part 20

Date of Issue: January 27, 2014

On the behalf of the applicant:

Wilson Electronics, Inc.
3301 E Deseret Drive
St. George, UT 84790

To the attention of:

Pat Cook, Sr. Electrical Engineer
Ph: (435) 673-5021
Email: pcook@infowest.com

Prepared By
Compliance Testing, LLC
3356 N San Marcos Pl, Suite 107
Chandler, AZ 85225-7176
(866) 311-3268 phone / (480) 926-3598 fax
www.compliancetesting.com
Project No: p1350025

Mike Graffeo
Project Test Engineer

This report may not be reproduced, except in full, without written permission from Compliance Testing
All results contained herein relate only to the sample tested



Test Report Revision History

Revision	Date	Revised By	Reason for Revision
1.0	9/27/2013	Mike Graffeo	Original Document
2.0	10/24/2013	Mike Graffeo	Retest 800 MHz band for new power and gain
3.0	11/6/2013	Amanda Reed	Corrected model description; added firmware and software information
4.0	12/2/2013	Mike Graffeo	Re-took plot on page 55, which fixed RWB for 1850- 1910 GSM UL input, Occupied bandwidth.
5.0	1/27/2013	John Erhard	Update test summary table removing provider specific references



Table of Contents

<u>Description</u>	<u>Page</u>
Standard Test Conditions and Engineering Practices	5
Test Result Summary	6
Authorized Frequency Band	7
Maximum Power and Gain	10
Intermodulation	12
Out-of-Band Emissions	15
Conducted Spurious Emissions	31
Noise Limits	38
Uplink Inactivity	46
Variable Gain	48
Occupied Bandwidth	52
Oscillation Detection	65
Radiated Spurious	73
Test Equipment Utilized	75



ILAC / A2LA

Compliance Testing, LLC, has been accredited in accordance with the recognized International Standard ISO/IEC 17025:2005. This accreditation demonstrates technical competence for a defined scope and the operation of a laboratory quality management system (refer joint ISO-ILAC-IAF Communiqué dated January 2009)

The tests results contained within this test report all fall within our scope of accreditation, unless noted below.

Please refer to <http://www.compliancetesting.com/labscope.html> for current scope of accreditation.

Testing Certificate Number: **2152.01**



FCC OATS Reg, #933597

IC Reg. #2044A-1

Non-accredited tests contained in this report:

N/A



Test and Measurement Data

Subpart
2.1033(c)(14):

All tests and measurement data shown were performed in accordance with FCC Rules and Regulations, Part 2, Sub-part J and the following individual Parts: 20.21 in conjunction with latest version of KDB 935210.

Standard Test Conditions and Engineering Practices

Except as noted herein, the following conditions and procedures were observed during the testing.

In accordance with ANSI/C63.4-2009, and unless otherwise indicated in the specific measurement results, the ambient temperature of the actual EUT was maintained within the range of 10° to 40°C (50° to 104°F) unless the particular equipment requirements specify testing over a different temperature range. Also, unless otherwise indicated, the humidity levels were in the range of 10% to 90% relative humidity.

Environmental Conditions		
Temp (°C)	Humidity (%)	Pressure (mbar)
24.9 – 31.0	33.5 – 63.0	985.5 - 943.0

Measurement results, unless otherwise noted, are worst-case measurements.

EUT Description

Model: 460005

Description: Dual Band In-Building Signal Booster

Firmware: A460007A

Software: 460007A

Additional Information:

The EUT is a bi-directional amplifier for the boosting of cellular phone signals and data communication devices. The following frequency bands and emission types are utilized.

Frequency Band (MHz)		
Uplink	824 - 849	1850 - 1910
Downlink	869 - 894	1930 - 1990

Emission Designators					
CDMA	HSPA	LTE	EVDO	EDGE	GSM
F9W	F9W	G7D	F9W	G7W	GXW

EUT Operation during Tests

The EUT was in a normal operating condition.



Test Result Summary

Specification	Test Name	Pass, Fail, N/A	Comments
20.21(e)(3)	Authorized Frequency Band	Pass	
20.21(e)(8)(i)(B) 20.21(e)(8)(i)(C) 20.21(e)(8)(i)(D)	Maximum Power and Gain	Pass	
20.21(e)(8)(i)(F)	Intermodulation	Pass	
20.21(e)(8)(i)(E)	Out-of-Band Emissions	Pass	
2.1051	Conducted Spurious Emissions	Pass	
20.21(e)(8)(i)(A)	Noise Limits	Pass	
20.21(e)(8)(i)(I)	Uplink Inactivity	Pass	
21(e)(8)(i)(C)	Variable Gain	Pass	
2.1049	Occupied Bandwidth	Pass	
20.21(e)(8)(ii)(A)	Oscillation Detection	Pass	
2.1053	Radiated Spurious	Pass	
20.21(e)(8)(i)(B)	Spectrum Block Filtering	N/A	This only applies to devices utilizing spectrum block filtering, in this case it is not applicable



Authorized Frequency Band

Name of Test: Authorized Frequency Band

Engineer: Mike Graffeo

Test Equipment Utilized: i00331 and i00405

Test Date: 9/19/13

Test Procedure

The EUT was connected to a spectrum analyzer through an attenuator with the losses being input into the spectrum analyzer as a combination of reference level offset and correction factor as necessary to ensure accurate readings were obtained. A signal generator was utilized to produce a CW input signal tuned to the center channel of the operational band. The RF input level was increased to a point just prior to the AGC being in control of the power. The Signal generator was set to sweep across 2X the operational band of the EUT while the spectrum analyzer was set to MAX HOLD. Two markers were placed at the edges of the operational band and a third marker was placed at the highest point within the band no closer than 2.5 MHz from the band edge.

Test Setup

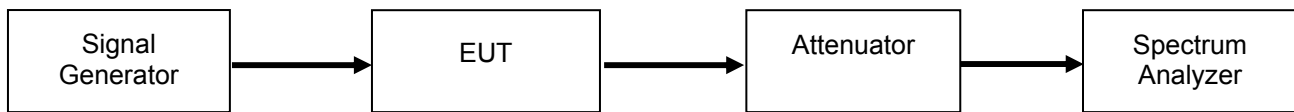



824 - 849 MHz Band

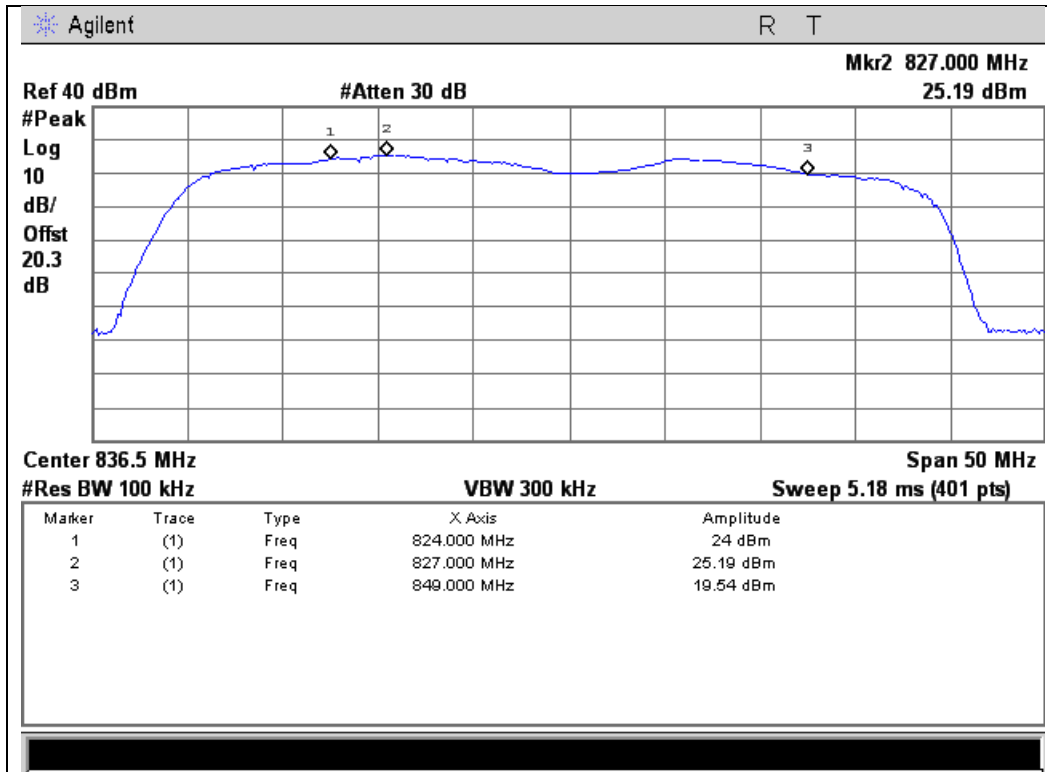

1850 - 1910 MHz Band

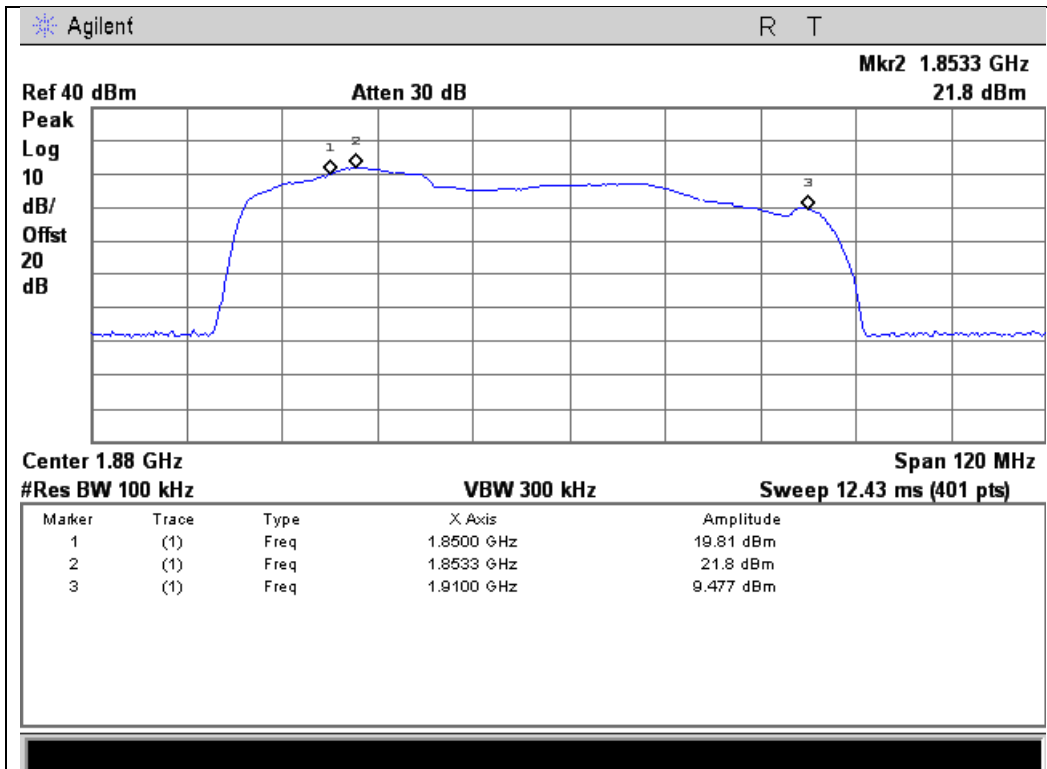



Downlink Test Results
869 - 894 MHz Band

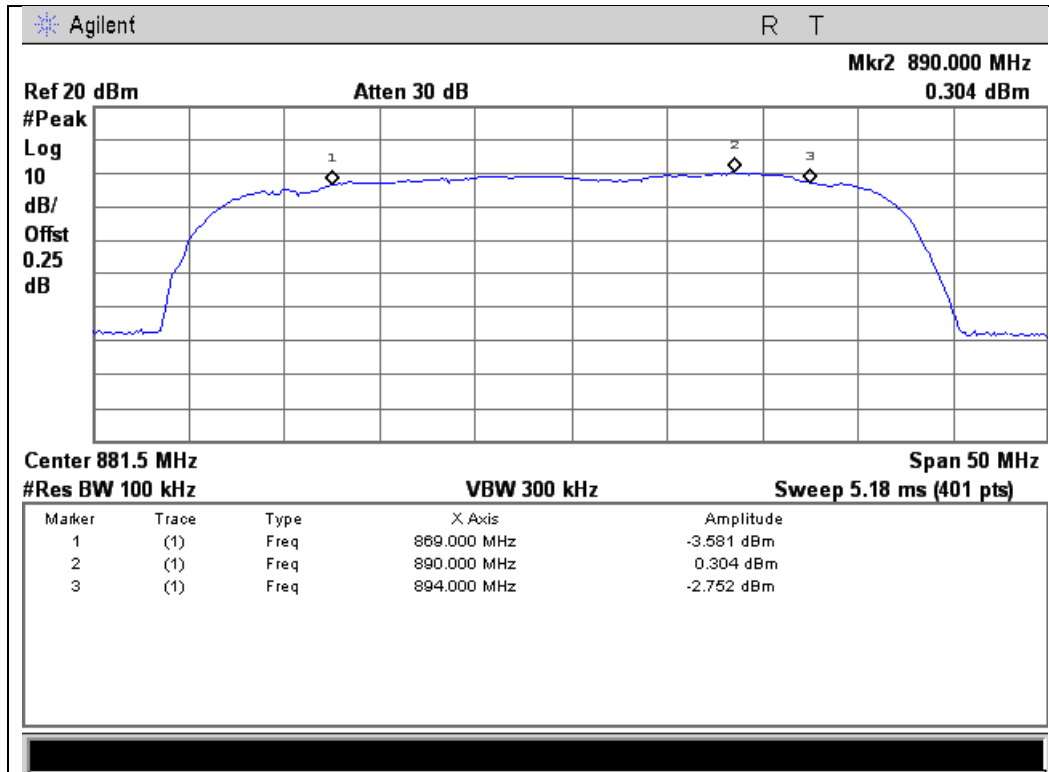

1930 - 1990 MHz Band

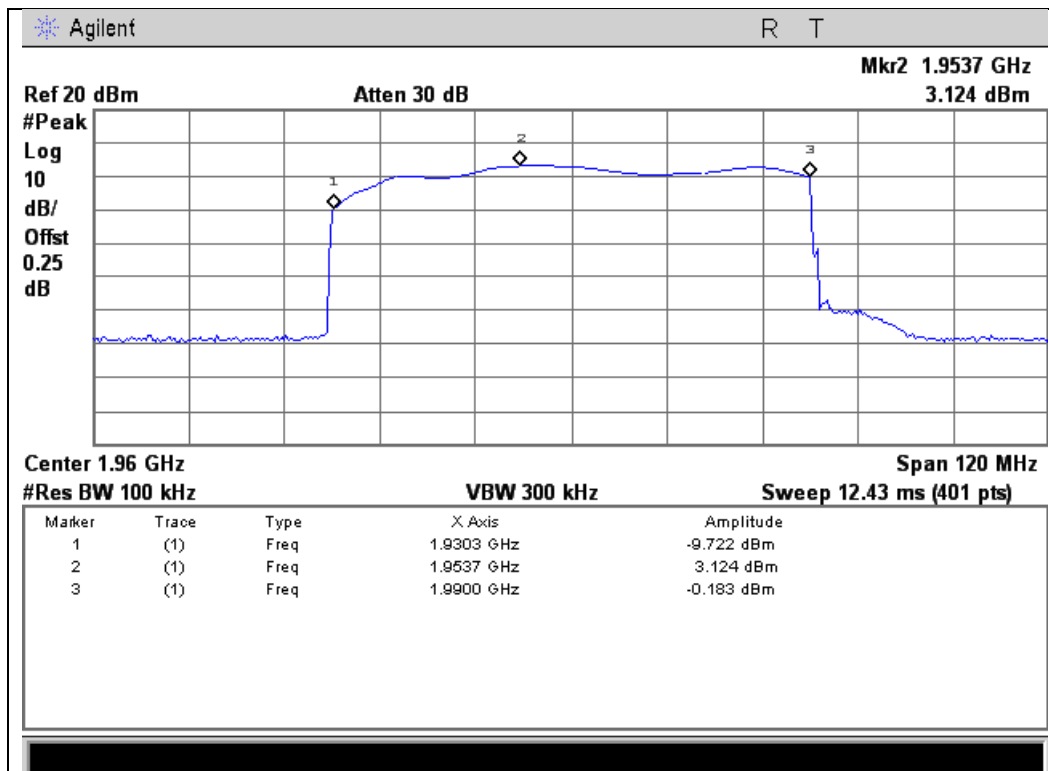



Maximum Power and Gain

Name of Test: Maximum Power and Gain
Test Equipment Utilized: i00331, i00405, i00412

Engineer: Mike Graffeo
Test Date: 9/19/13

Test Procedure

The EUT was connected to a spectrum analyzer through an attenuator with the losses being input into the spectrum analyzer as a combination of reference level offset and correction factor as necessary to ensure accurate readings were obtained. The spectrum analyzer and signal generator were tuned to the frequency with the highest power level in the band as determined by the Authorized Frequency Band test. The RF input level was increased to a point just prior to the AGC being in control of the power with both a 570 μS 12.5% duty-cycle pulsed CW and 4.1 MHz AWGN modulation. The maximum power was measured and verified to meet the minimum and maximum levels allowed and the maximum gain was computed from these values. The uplink and downlink gain under each condition was verified to be within 9 dB of each other.

The following formulas are used for calculating the limits.

Note – The Downlink gain is calculated based on the paired Uplink center frequency.

$$\text{Maximum Gain Limit (dB)} = 6.5 \text{ dB} + 20\text{Log}(\text{Frequency})$$

Note - Frequency is the uplink mid-band frequency of the supported spectrum bands in MHz.

Test Setup

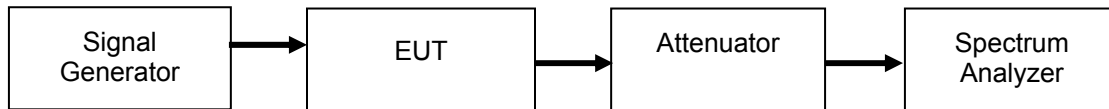

Uplink Power Test Results

Frequency Band (MHz)	Input Level (dBm)	Output Power (dBm)	Lower Limit (dBm)	Upper Limit (dBm)	Result
824 - 849 MHz Pulsed CW	-32.3	24.9	17	30	Pass
824 - 849 MHz AWGN	-37.0	22.5	17	30	Pass
1850 - 1910 MHz Pulsed CW	-41.0	22.5	17	30	Pass
1850 - 1910 MHz AWGN	-46.7	19.2	17	30	Pass



Downlink Power Test Results

Frequency Band (MHz)	Input Level (dBm)	Output Power (dBm)	Upper Limit (dBm)	Result
869 - 894 MHz Pulsed CW	-50.4	-2.2	17	Pass
869 - 894 MHz AWGN	-63.4	-3.0	17	Pass
1930 - 1990 MHz Pulsed CW	-60.6	-2.3	17	Pass
1930 - 1990 MHz AWGN	-68.8	-2.1	17	Pass

Uplink and Downlink Gain Test Results

Modulation	Uplink Frequency (MHz)	Downlink Frequency (MHz)	Uplink Gain (dB)	Uplink Limit (dB)	Downlink Gain (dB)	Downlink Limit (dB)	Delta (dB)	Limit (dB)	Margin (dB)
Pulsed CW	827	890	57.2	65	48.2	65	8.9	9	-0.03
AWGN	827	890	59.5	65	60.4	65	0.9	9	-8.1
Pulsed CW	1853	1953	63.5	72	58.3	72	5.2	9	-3.7
AWGN	1853	1953	65.9	72	66.7	72	0.8	9	-8.2



Intermodulation

Name of Test: Intermodulation

Engineer: Mike Graffeo

Test Equipment Utilized: i00331, i00405, i00412

Test Date: 9/19/13

Test Procedure

The EUT was connected to a spectrum analyzer through an attenuator. Two signal generators were utilized to produce two CW signals 600 kHz apart and centered in the operational band. Attenuator and cable insertion loss correction factors were input to either the signal generator or the spectrum analyzer as required to ensure accurate measurements were recorded. The input power was set at the maximum allowable power and the intermodulation products were measured to ensure they were less than -19 dBm in a 3 kHz RBW. The uplink and downlink intermodulation products were plotted with the levels being listed in the summary tables.

Test Setup

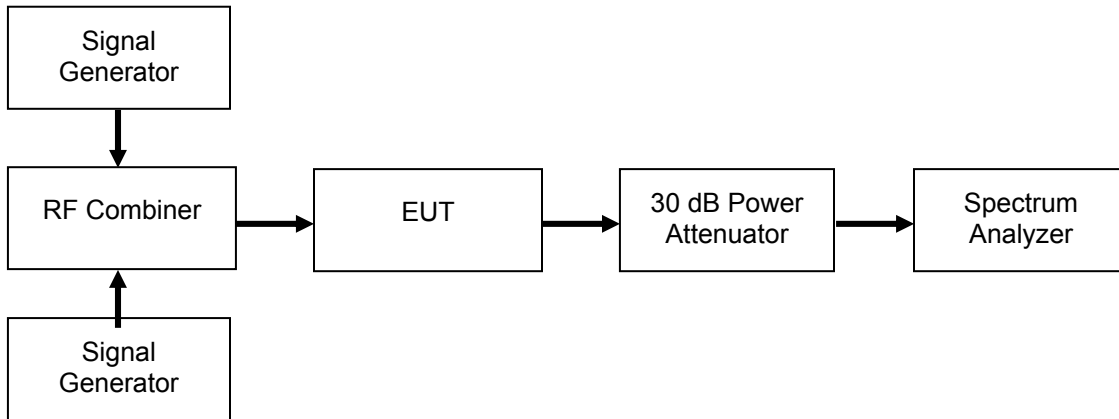

Uplink Test Results

Frequency Band (MHz)	Intermodulation Level (dBm)	Limit (dBm)	Result
824 - 849 MHz	-20.65	-19	Pass
1850 - 1910 MHz	-26.29	-19	Pass

Downlink Test Results

Frequency Band (MHz)	Intermodulation Level (dBm)	Limit (dBm)	Result
869 - 894 MHz	-72.89	-19	Pass
1930 - 1990 MHz	-59.79	-19	Pass



Uplink Test Results 824 - 849 MHz Band

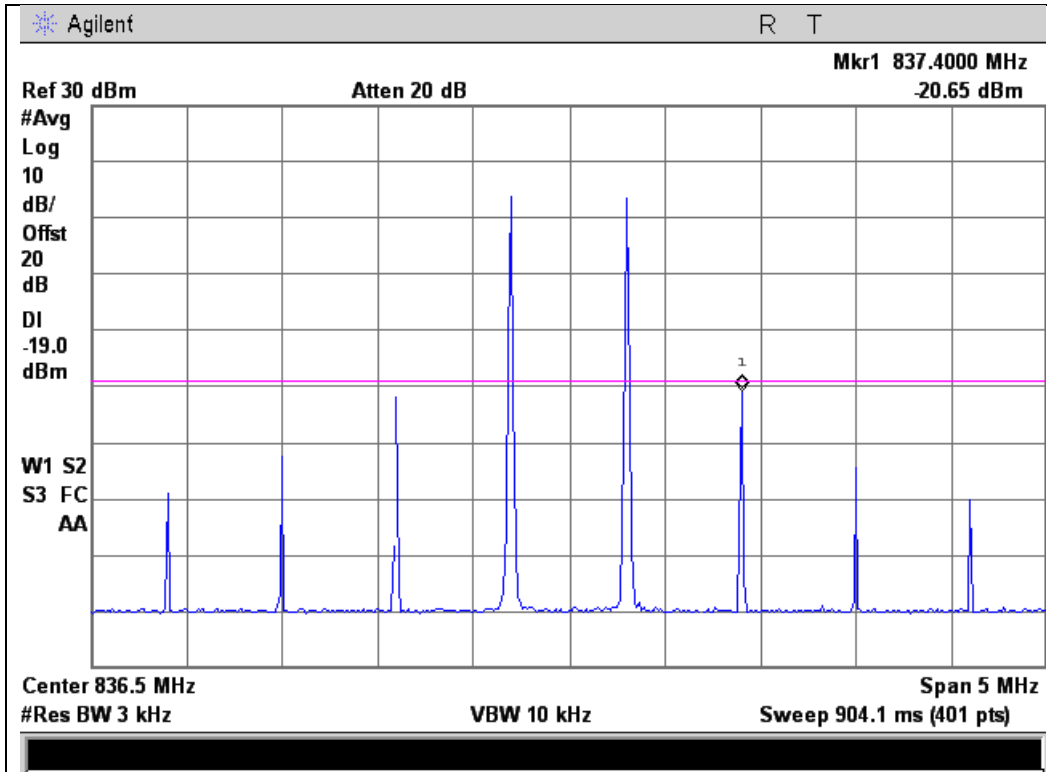

1850 - 1910 MHz Band

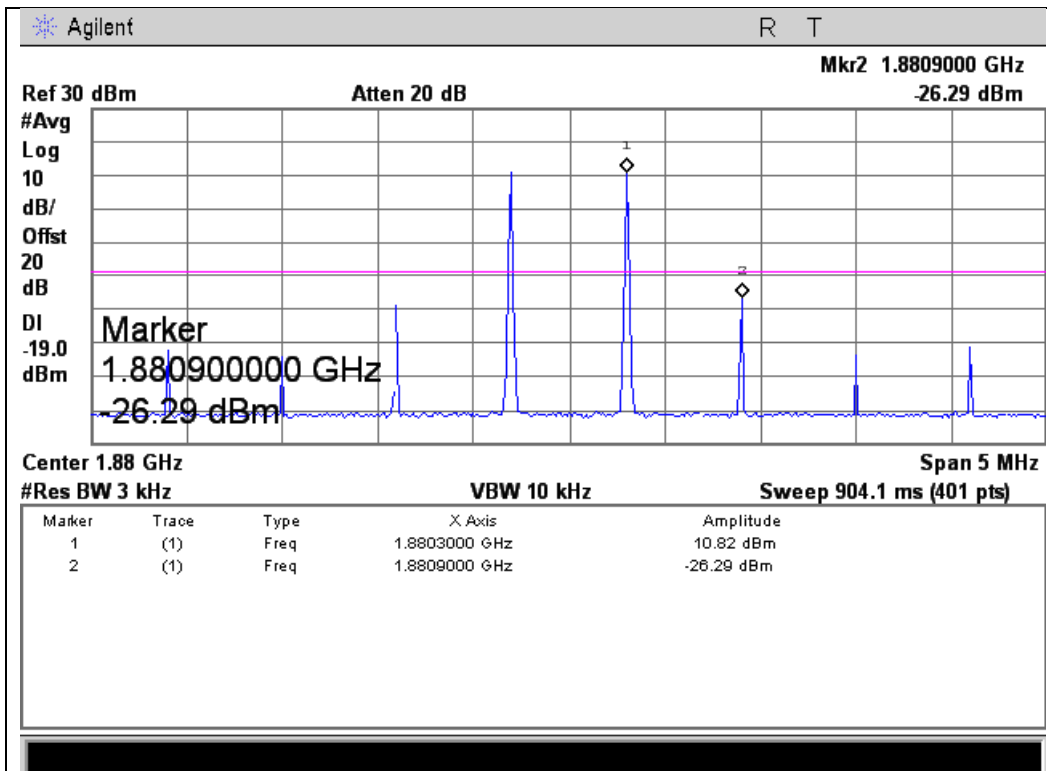



Downlink Test Results
869 - 894 MHz Band

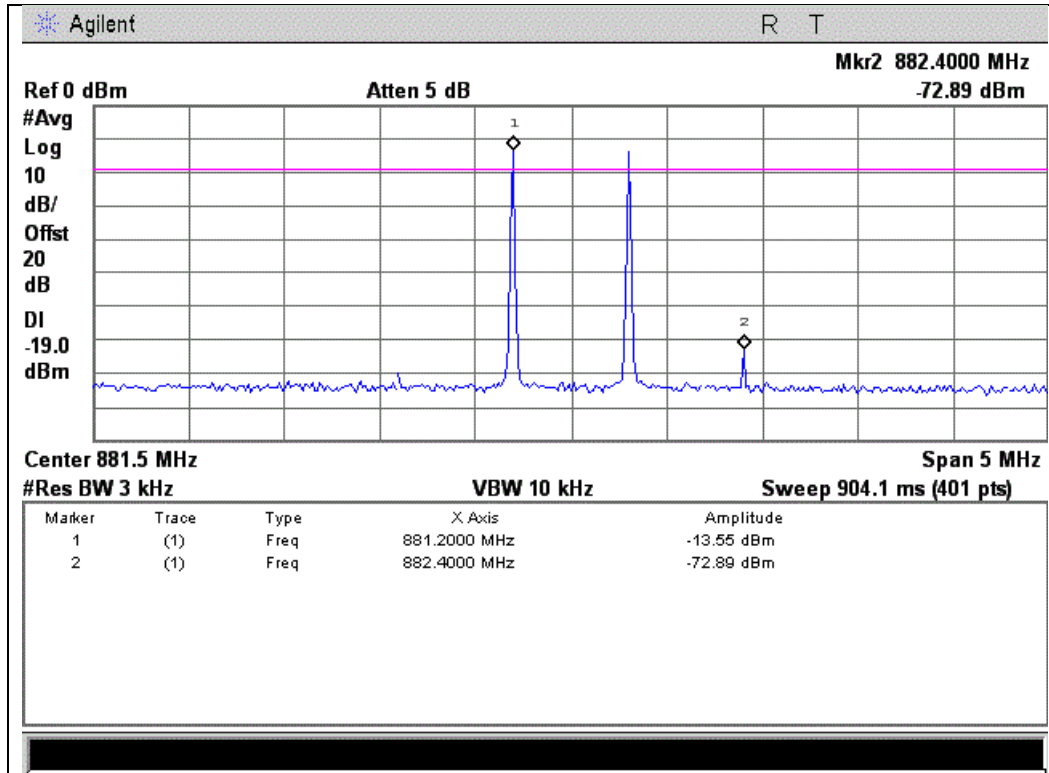

1930 - 1990 MHz Band

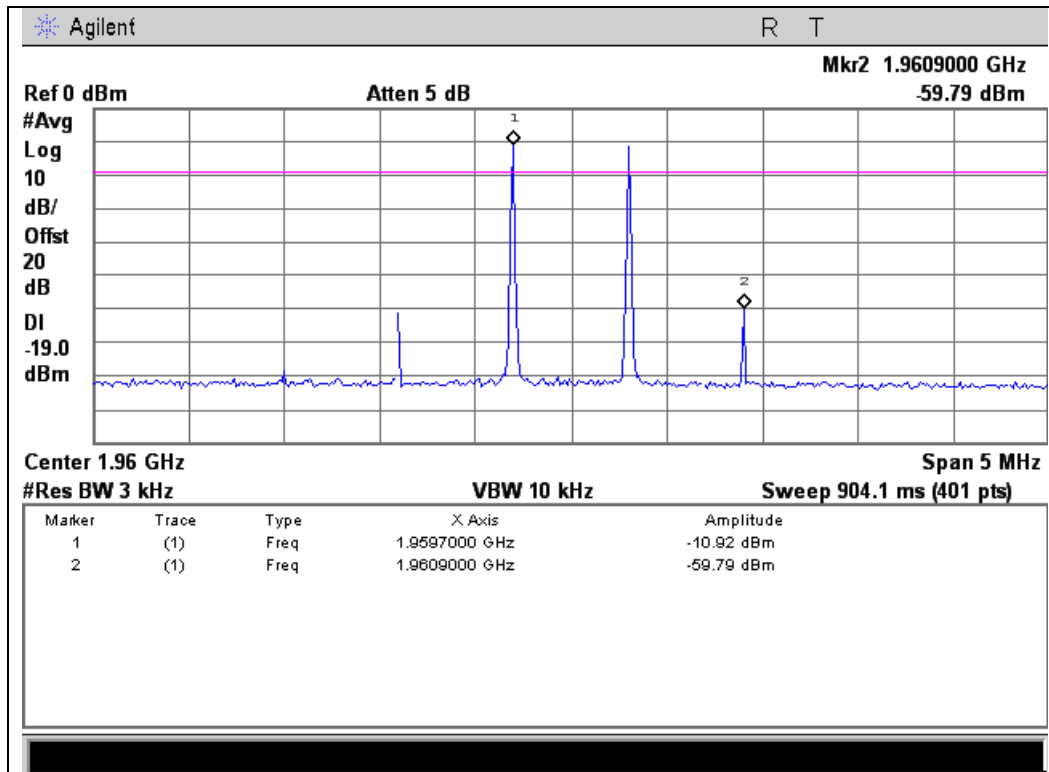



Out-of-Band Emissions

Name of Test: Out-of-Band Emissions
Test Equipment Utilized: i00331 and i00405

Engineer: Mike Graffeo
Test Date: 9/19/13

Test Procedure

The EUT was connected to a spectrum analyzer through an attenuator with the losses being input into the spectrum analyzer as a combination of reference level offset and correction factor as necessary to ensure accurate readings were obtained. A signal generator was utilized to produce the following signals; GSM, CDMA, and WCDMA tuned to the lowest allowable upper and lower channel within the EUT operational band for each respective modulation type. The RF input level was increased to a point just prior to the AGC being in control of the power. For each modulation type the Out of Band Emissions was measured ensuring they met the requirements.

The following formulas are used for calculating the limits.

Out-of-Band Emissions Limit = $6 + (43 + 10\log P)$

Test Setup





GSM Uplink Test Results

Frequency Band (MHz)	Band Edge	Measured Level (dBm)	Limit (dBm)	Result
824 - 849	Lower	-33.51	-19	Pass
824 - 849	Upper	-30.96	-19	Pass
1850 - 1910	Lower	-33.01	-19	Pass
1850 - 1910	Upper	-38.56	-19	Pass

CDMA Uplink Test Results

Frequency Band (MHz)	Band Edge	Measured Level (dBm)	Limit (dBm)	Result
824 - 849	Lower	-27.40	-19	Pass
824 - 849	Upper	-36.41	-19	Pass
1850 - 1910	Lower	-46.85	-19	Pass
1850 - 1910	Upper	-42.58	-19	Pass



WCDMA Uplink Test Results

Frequency Band (MHz)	Band Edge	Measured Level (dBm)	Limit (dBm)	Result
824 - 849	Lower	-35.60	-19	Pass
824 - 849	Upper	-30.14	-19	Pass
1850 - 1910	Lower	-45.13	-19	Pass
1850 - 1910	Upper	-43.6	-19	Pass

GSM Downlink Test Results

Frequency Band (MHz)	Band Edge	Measured Level (dBm)	Limit (dBm)	Result
869 - 894	Lower	-57.40	-19	Pass
869 - 894	Upper	-58.26	-19	Pass
1930 - 1990	Lower	-59.50	-19	Pass
1930 - 1990	Upper	-50.89	-19	Pass



CDMA Downlink Test Results

Frequency Band (MHz)	Band Edge	Measured Level (dBm)	Limit (dBm)	Result
869 - 894	Lower	-64.97	-19	Pass
869 - 894	Upper	-62.97	-19	Pass
1930 - 1990	Lower	-65.56	-19	Pass
1930 - 1990	Upper	-62.48	-19	Pass

WCDMA Downlink Test Results

Frequency Band (MHz)	Band Edge	Measured Level (dBm)	Limit (dBm)	Result
869 - 894	Lower	-58.71	-19	Pass
869 - 894	Upper	-56.88	-19	Pass
1930 - 1990	Lower	-59.85	-19	Pass
1930 - 1990	Upper	-79.46	-19	Pass



GSM Uplink Test Plots 824 - 849 MHz Band

Lower Band Edge

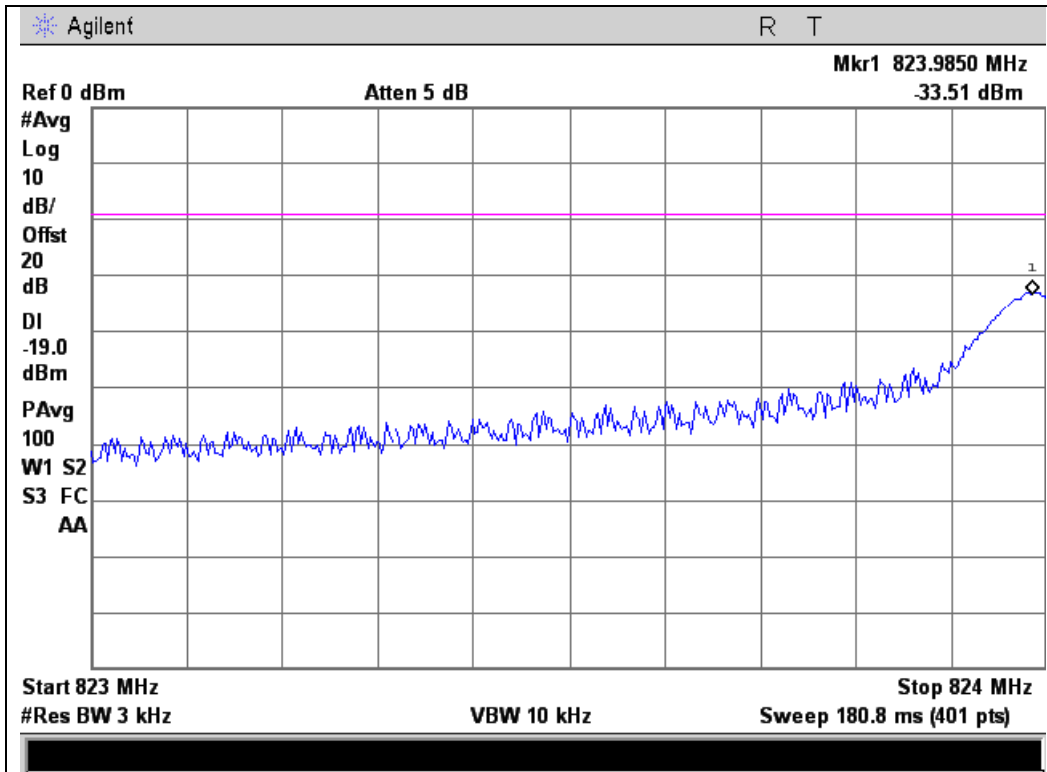

Upper Band Edge

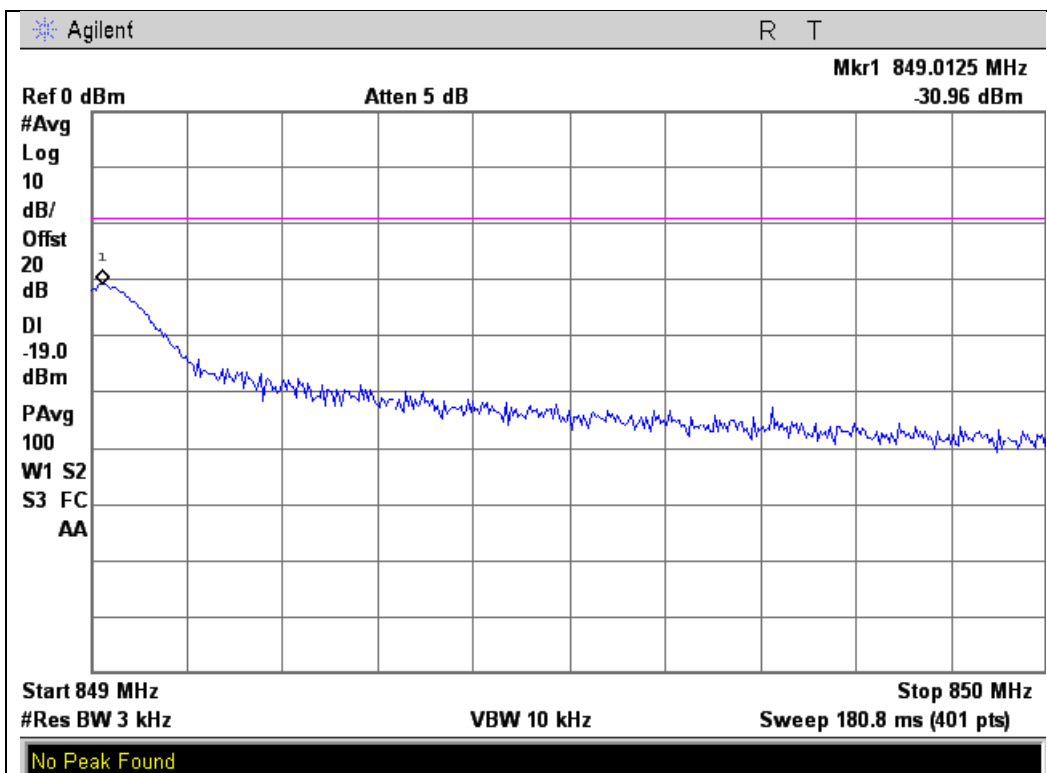



1850 - 1910 MHz Band

Lower Band Edge

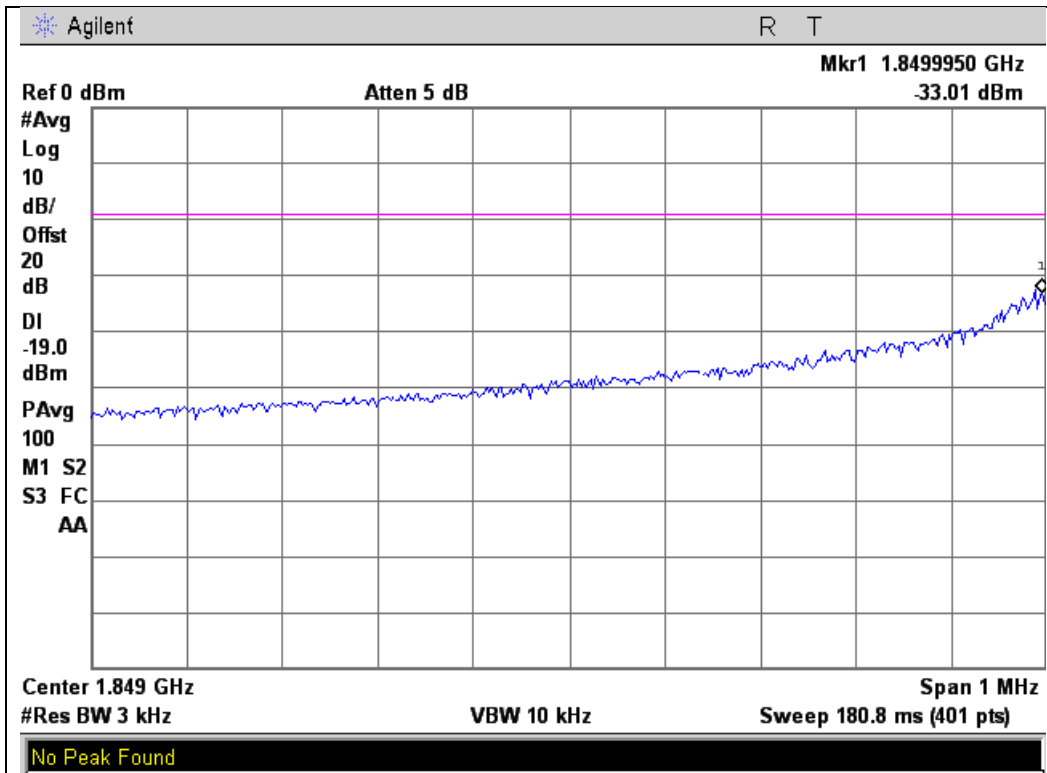

Upper Band Edge

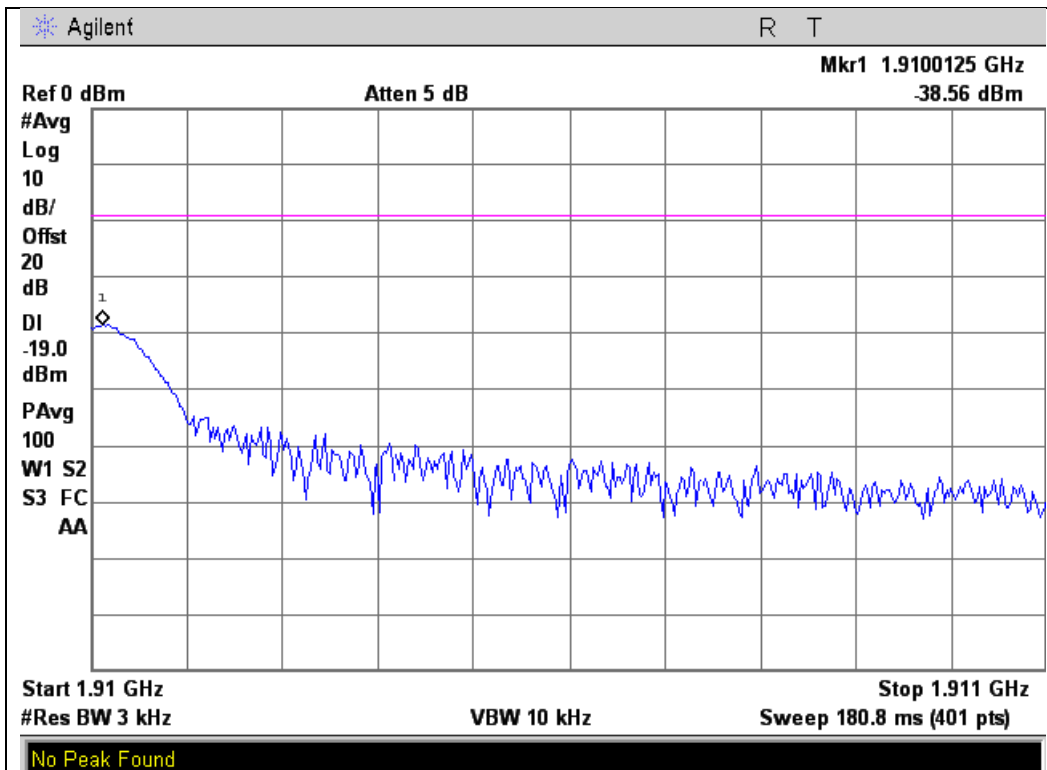



CDMA Uplink Test Plots 824 - 849 MHz Band

Lower Band Edge

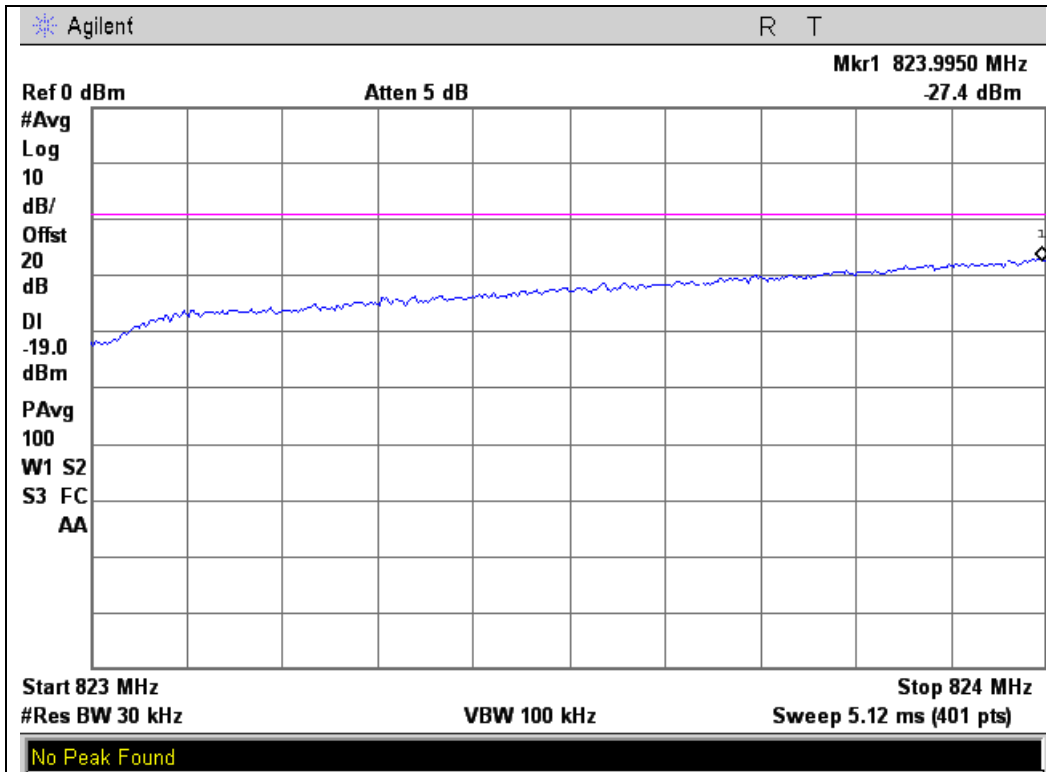

Upper Band Edge

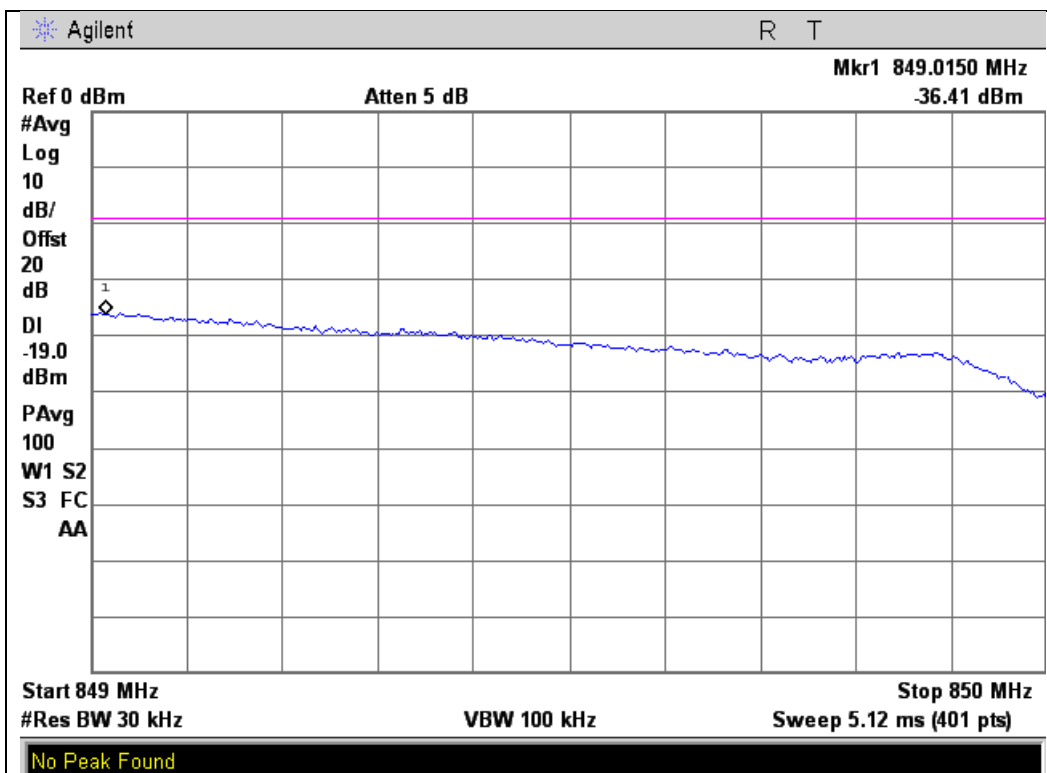



1850 - 1910 MHz Band

Lower Band Edge

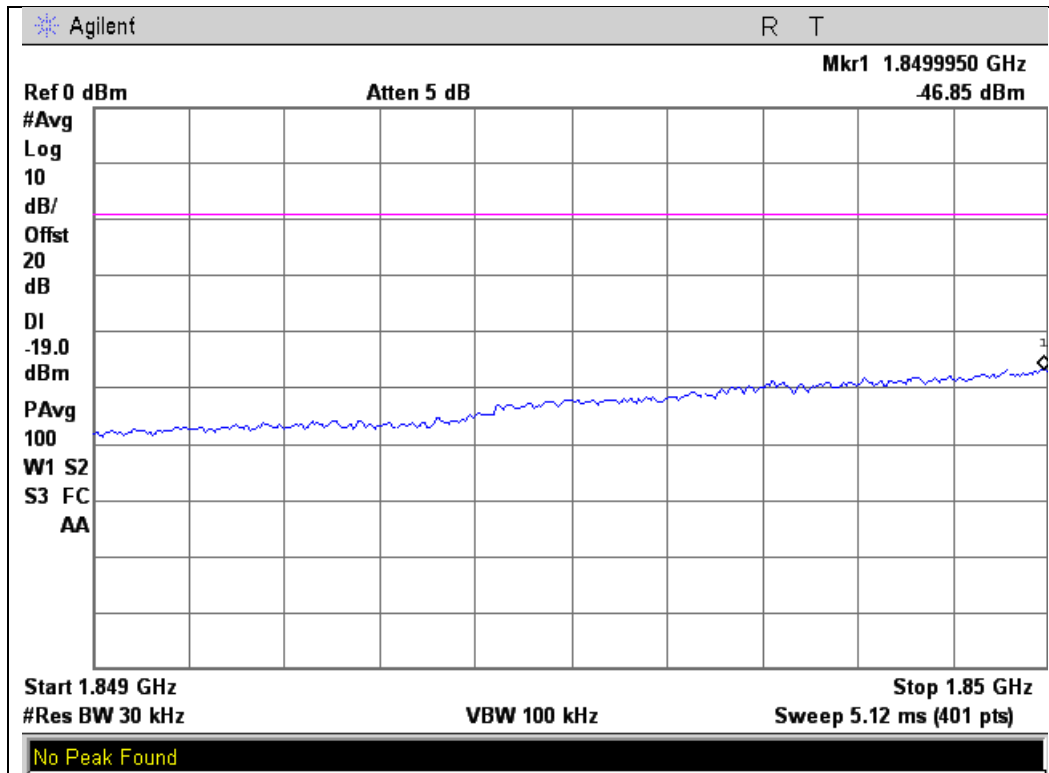

Upper Band Edge

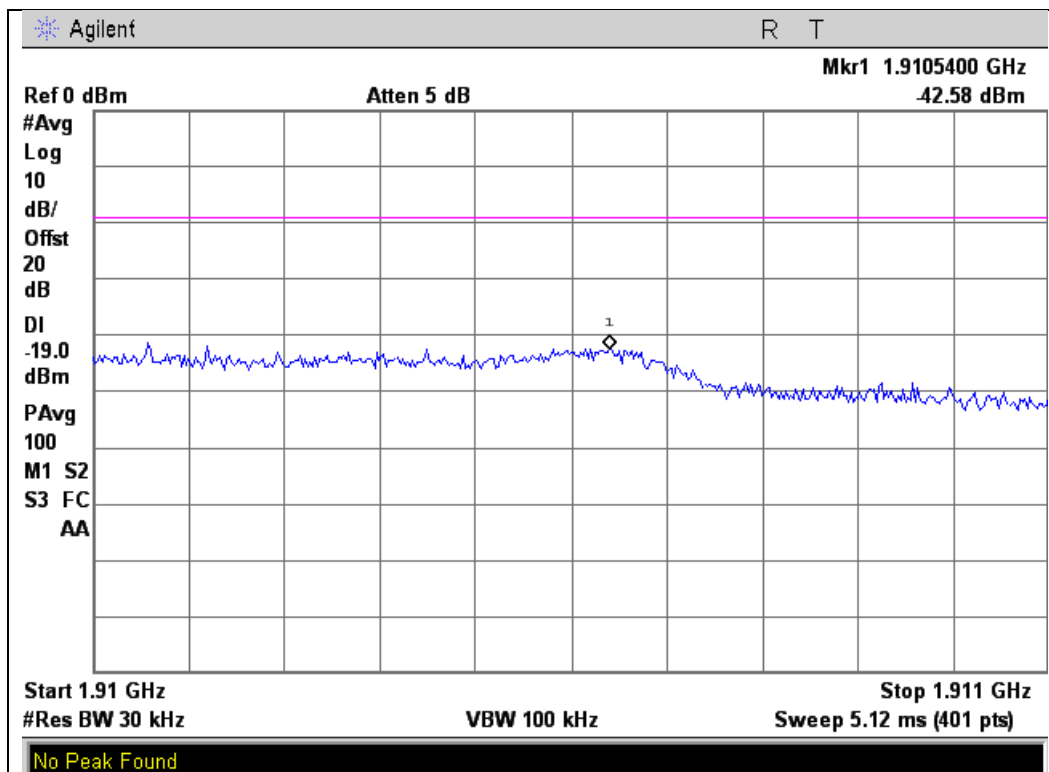



WCDMA Uplink Test Plots 824 - 849 MHz Band

Lower Band Edge

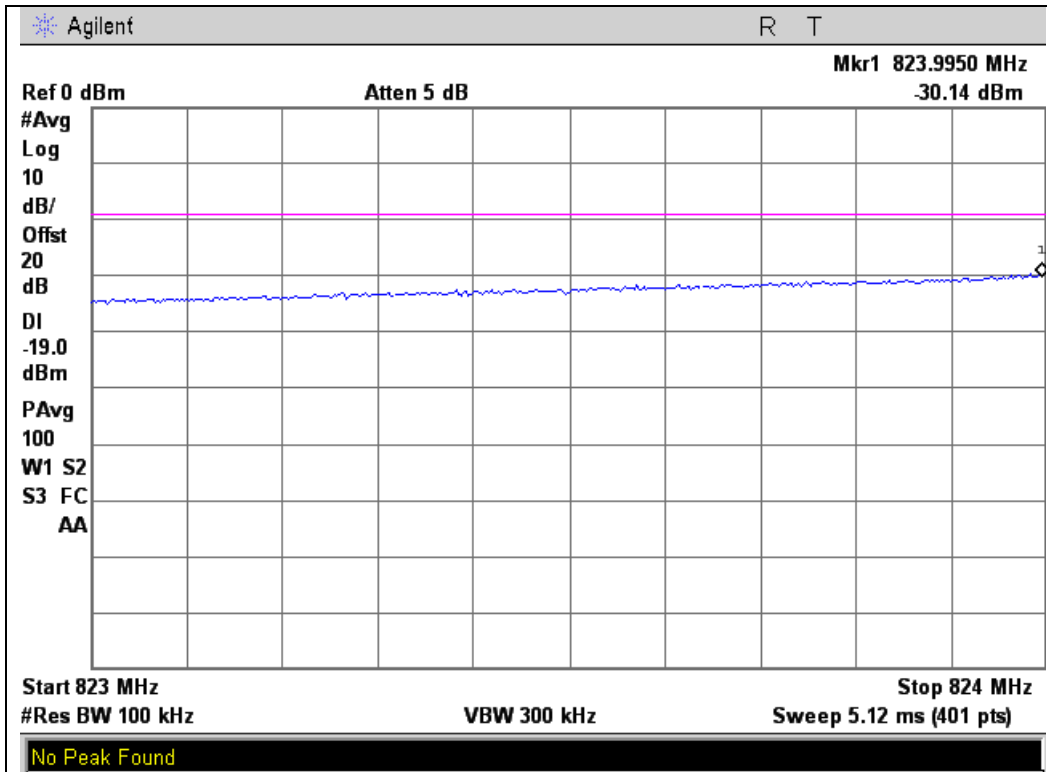

Upper Band Edge

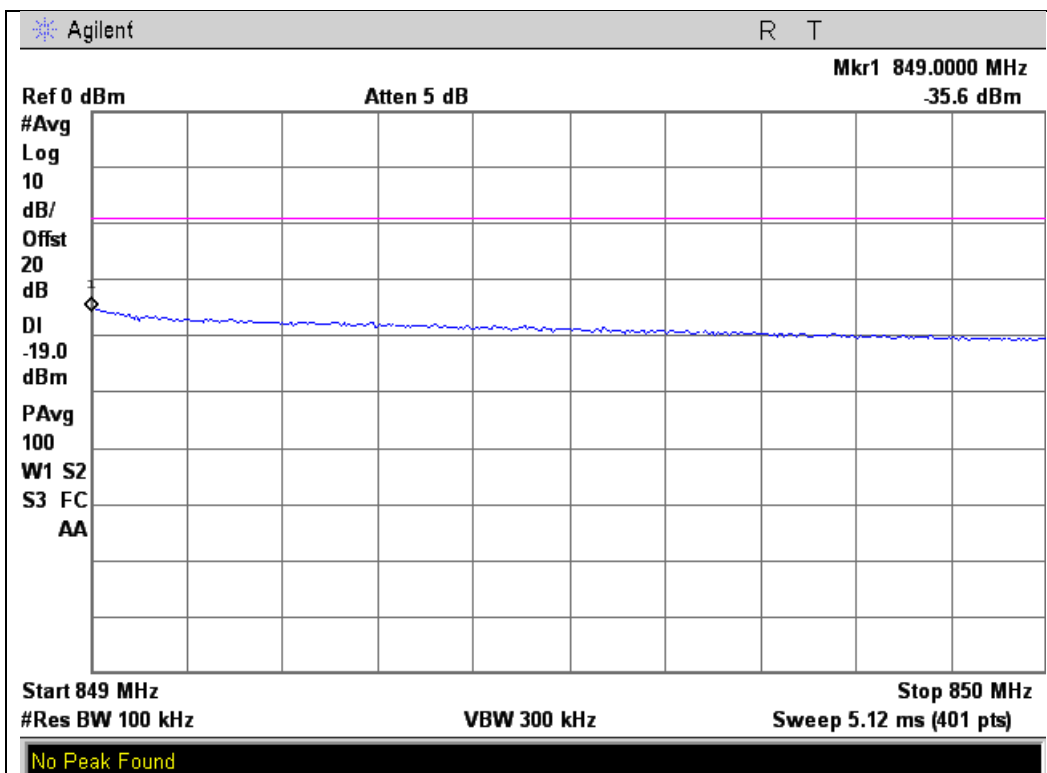



1850 - 1910 MHz Band

Lower Band Edge

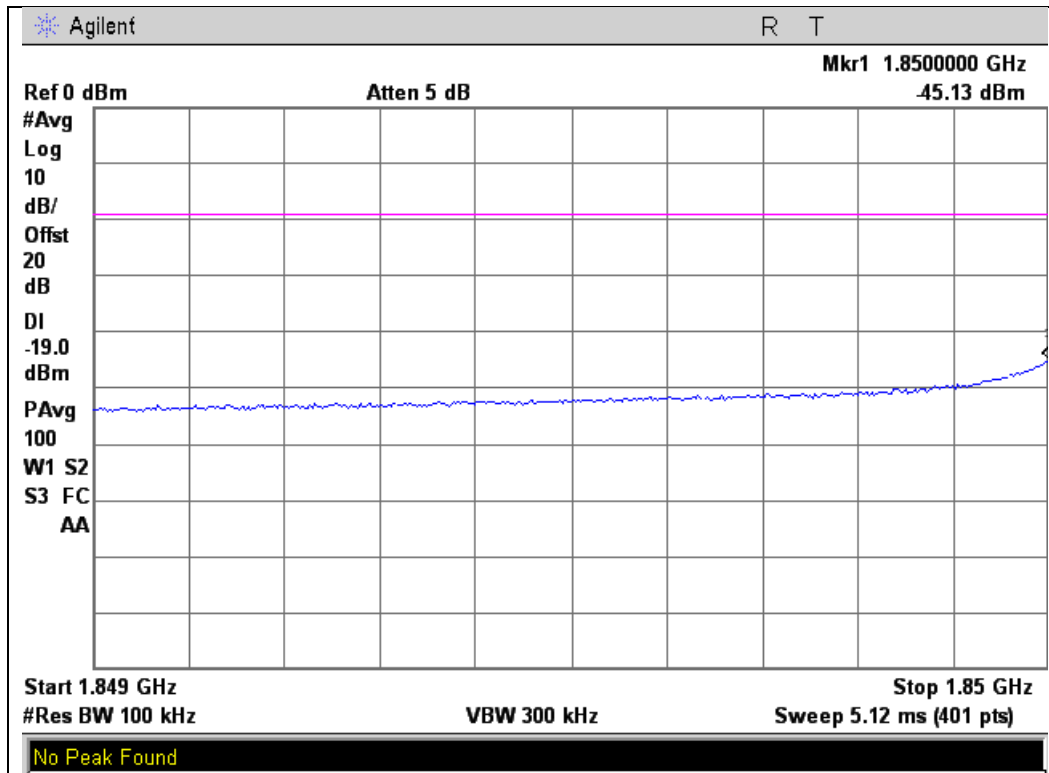

Upper Band Edge

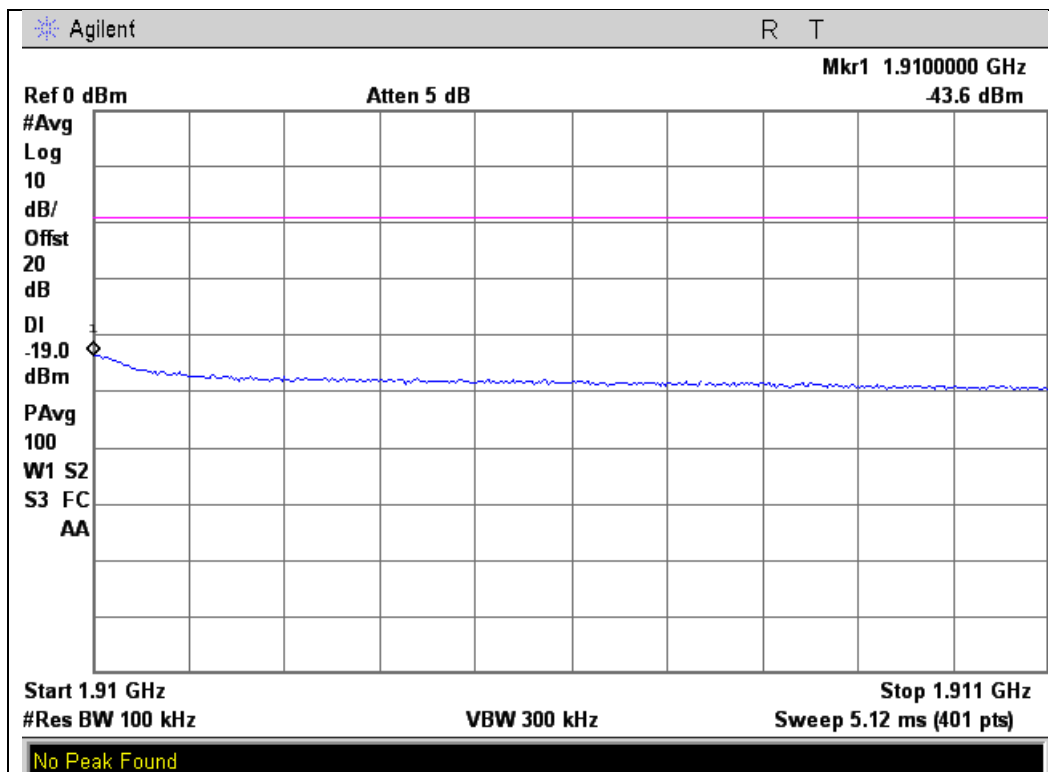



GSM Downlink Test Plots 869 - 894 MHz Band

Lower Band Edge

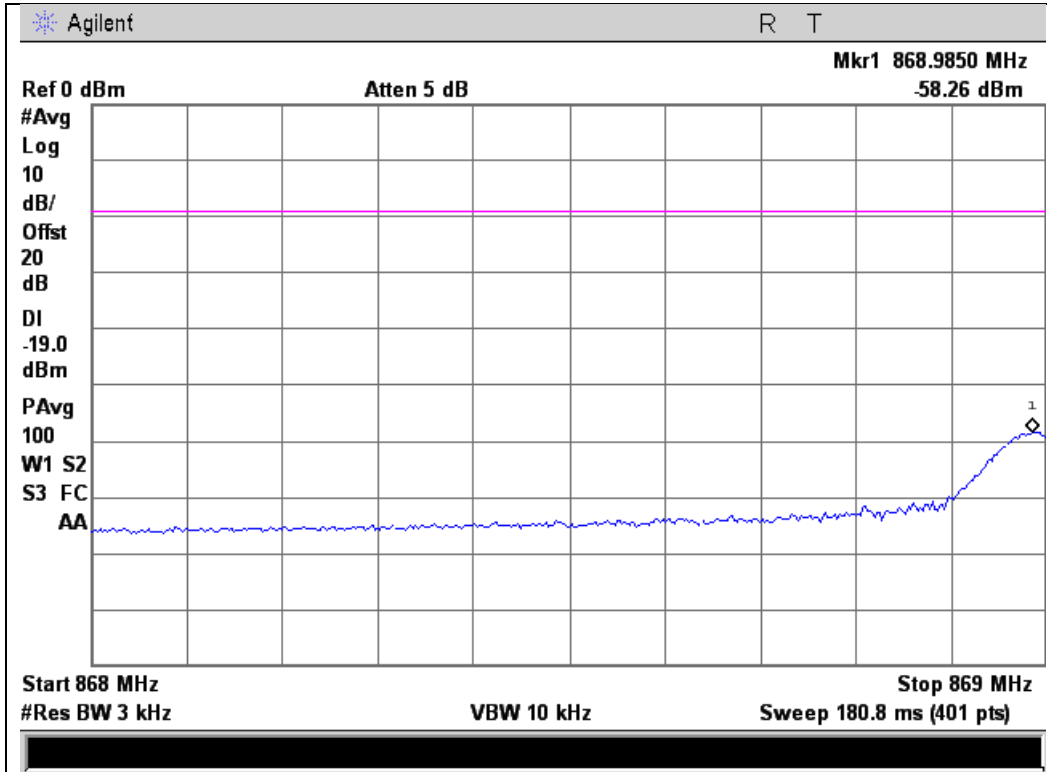

Upper Band Edge

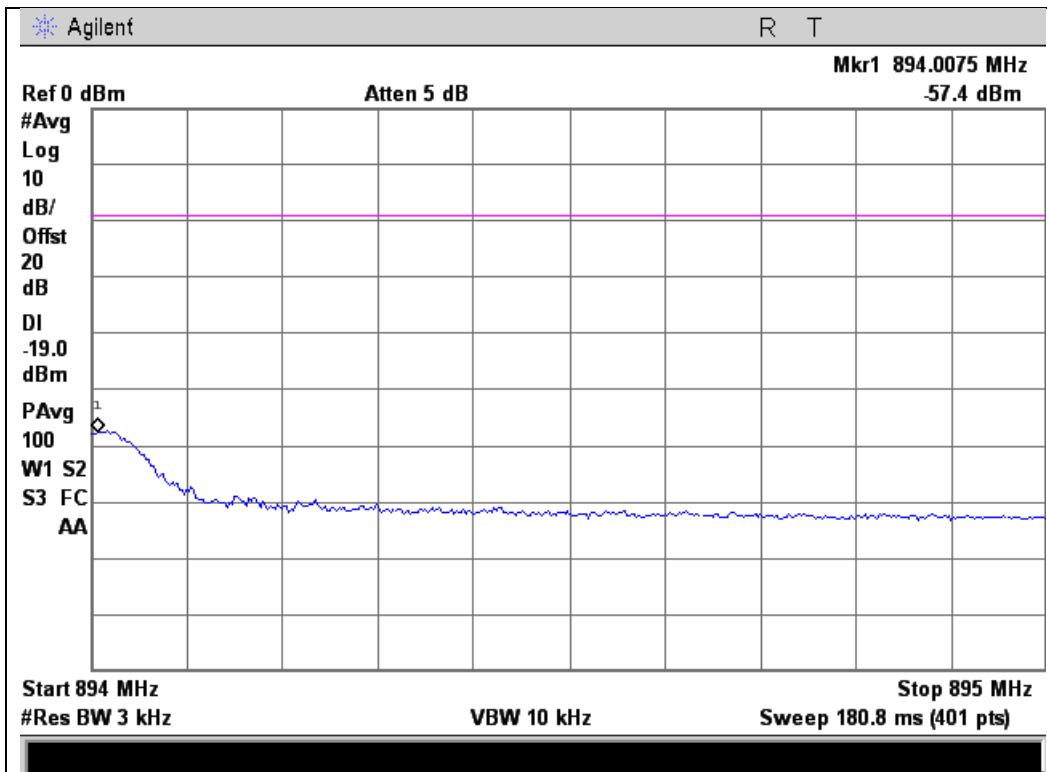



1930 - 1990 MHz Band

Lower Band Edge

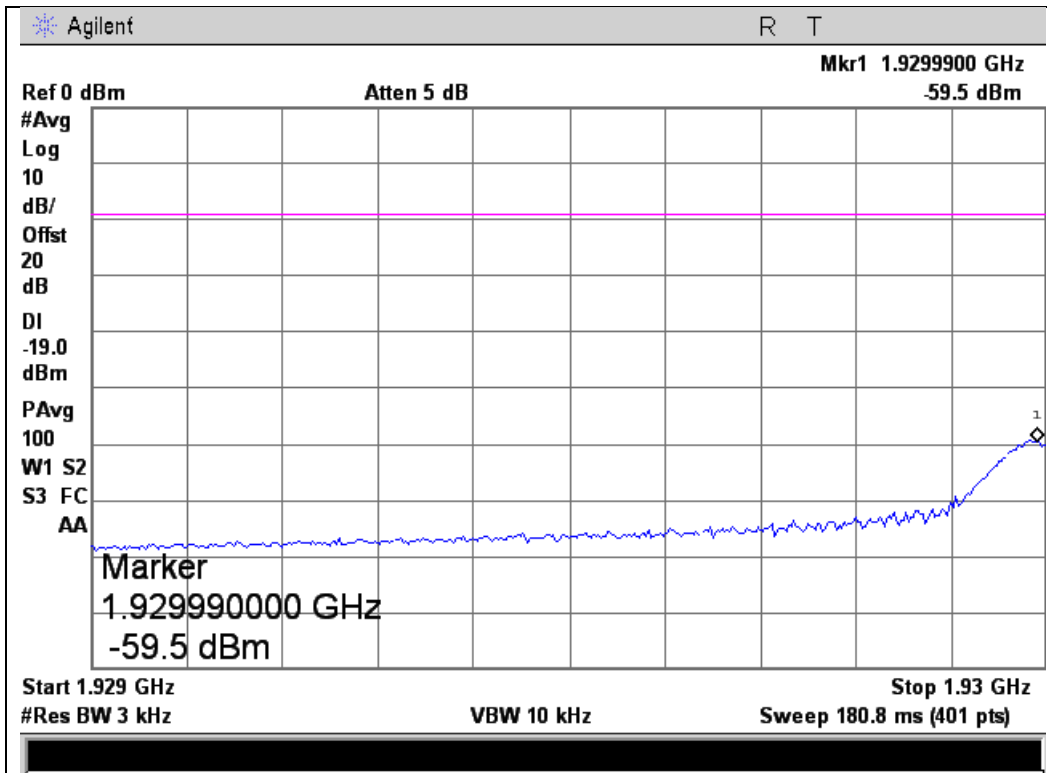

Upper Band Edge

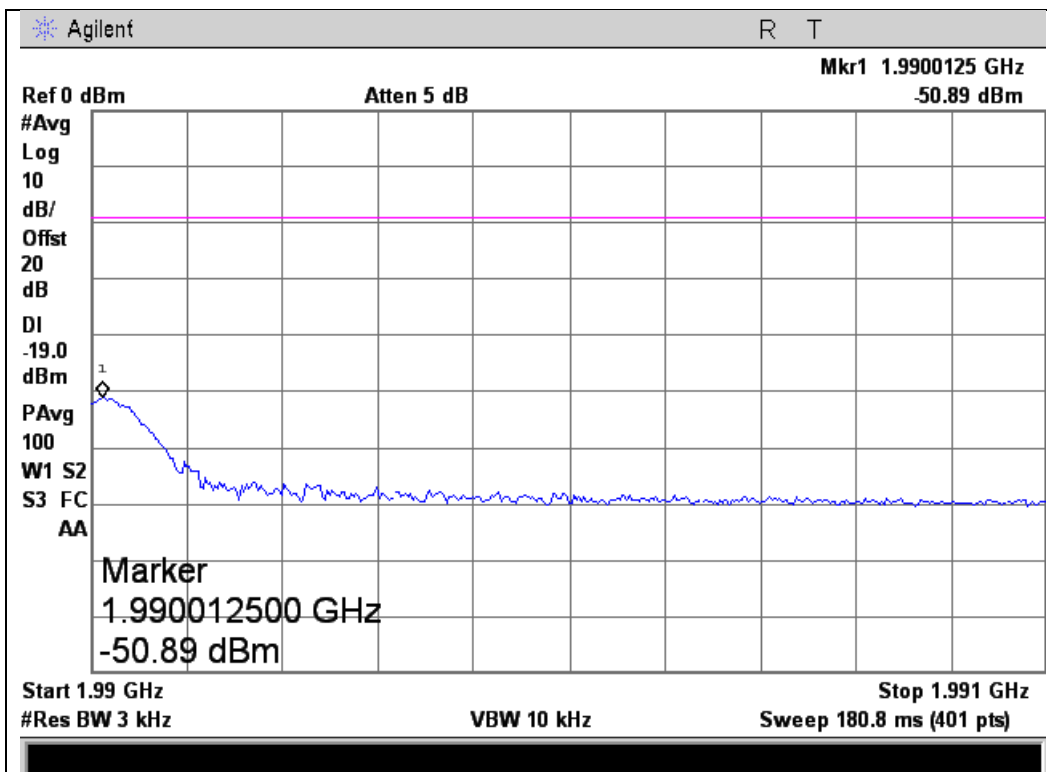



CDMA Downlink Test Plots 869 - 894 MHz Band

Lower Band Edge

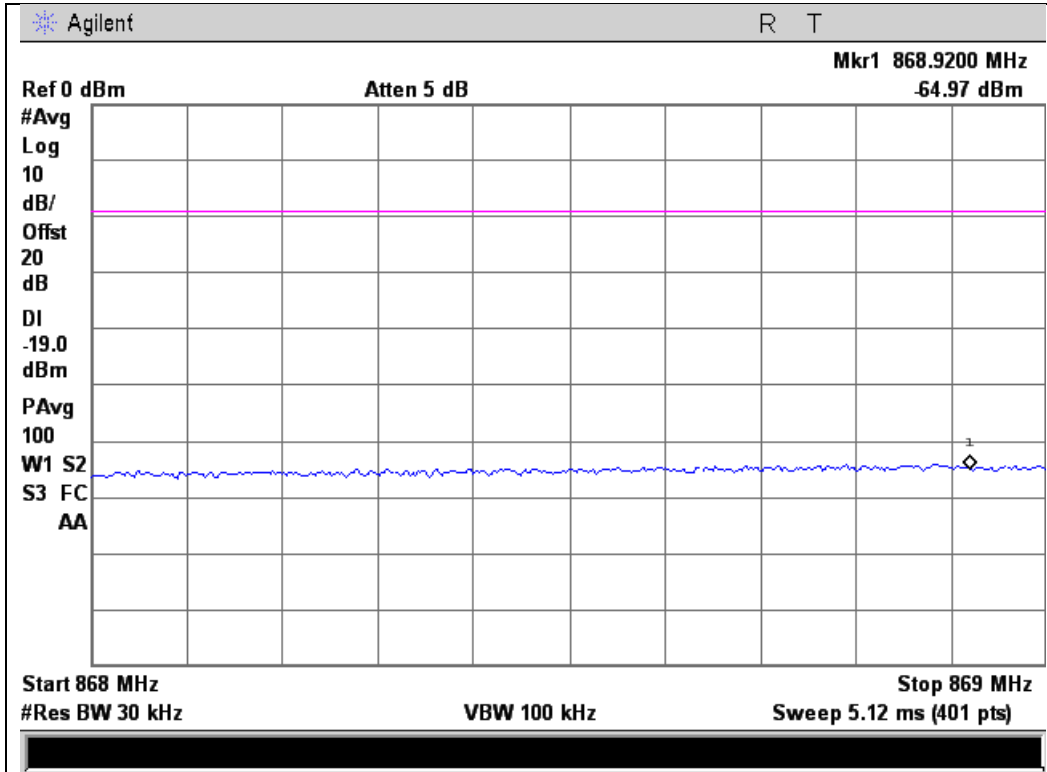

Upper Band Edge

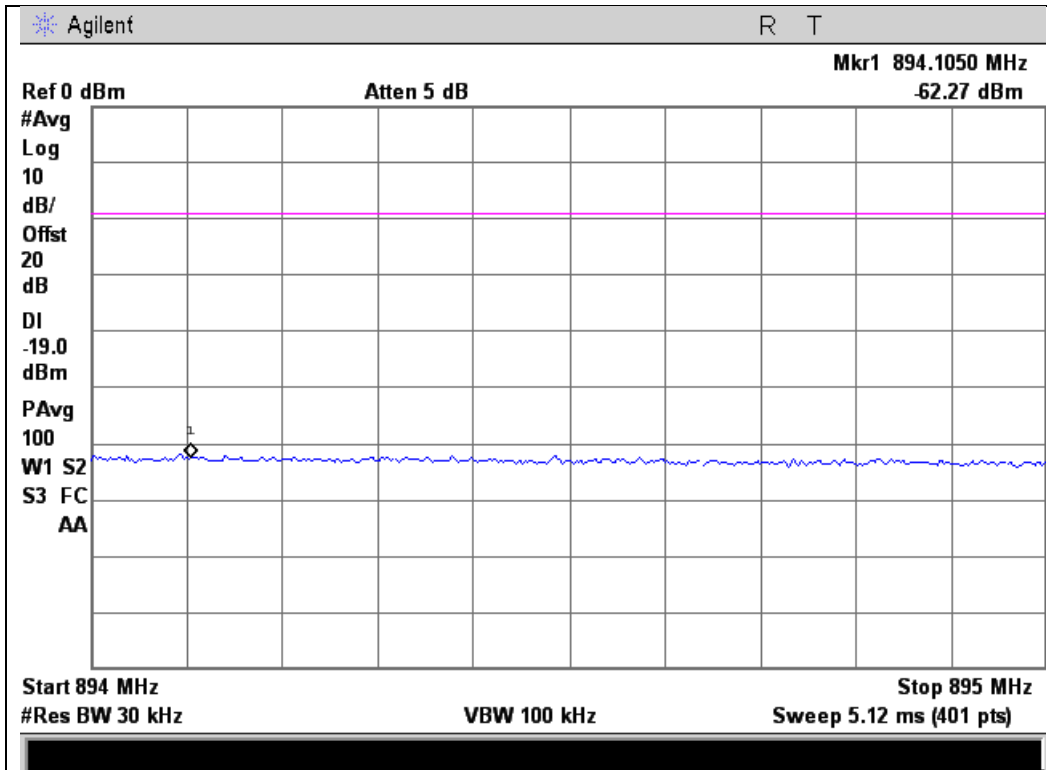



1930 - 1990 MHz Band

Lower Band Edge

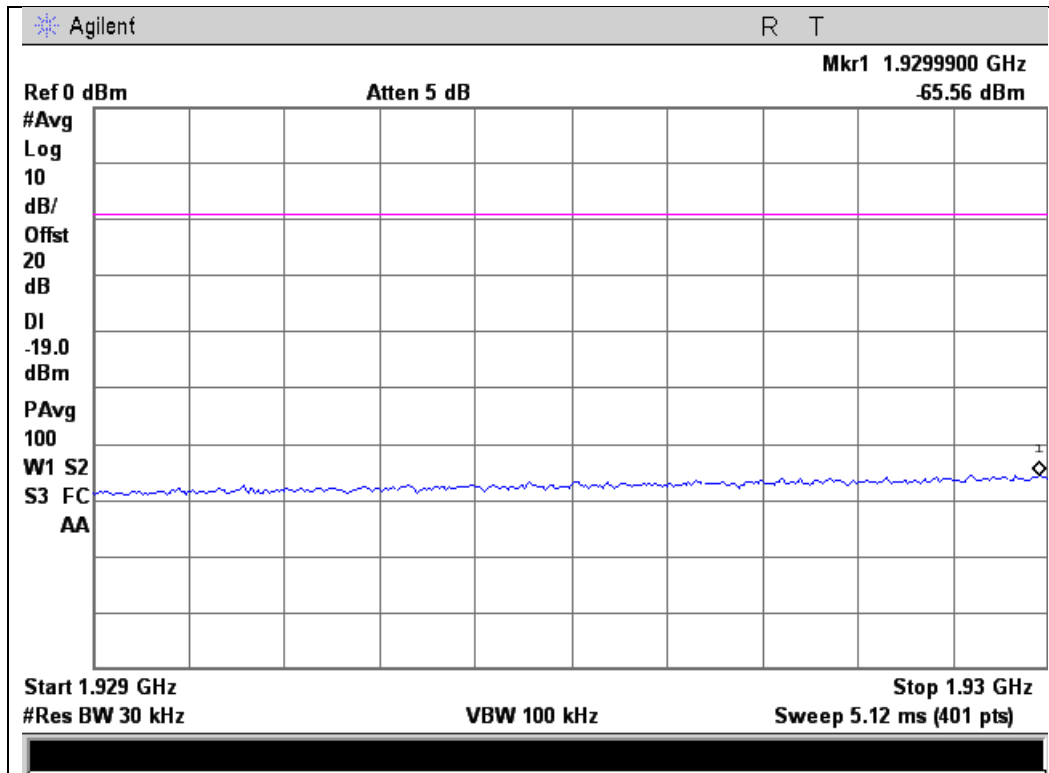

Upper Band Edge

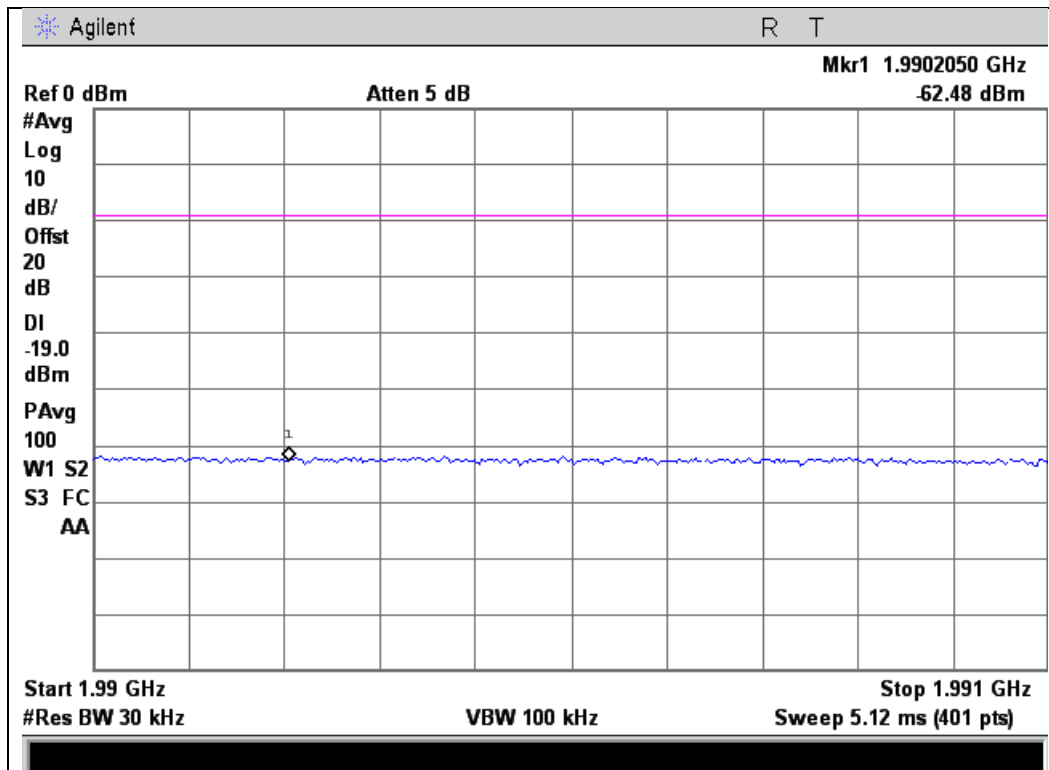



WCDMA Downlink Test Plots 869 - 894 MHz Band

Lower Band Edge

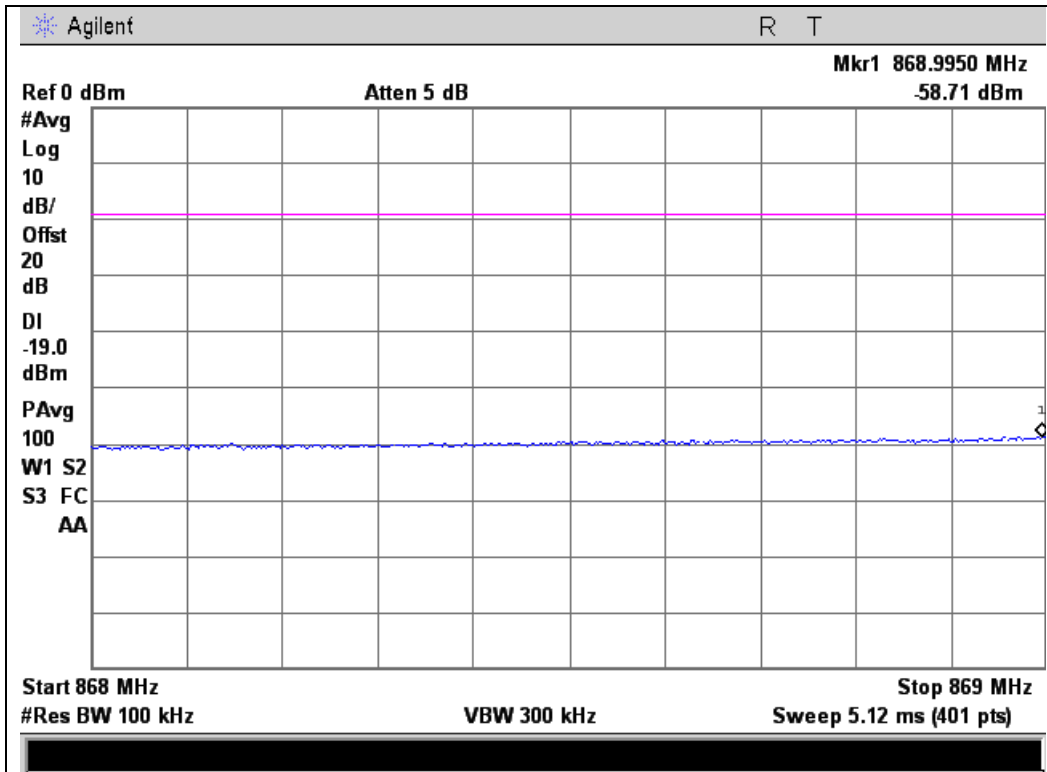

Upper Band Edge

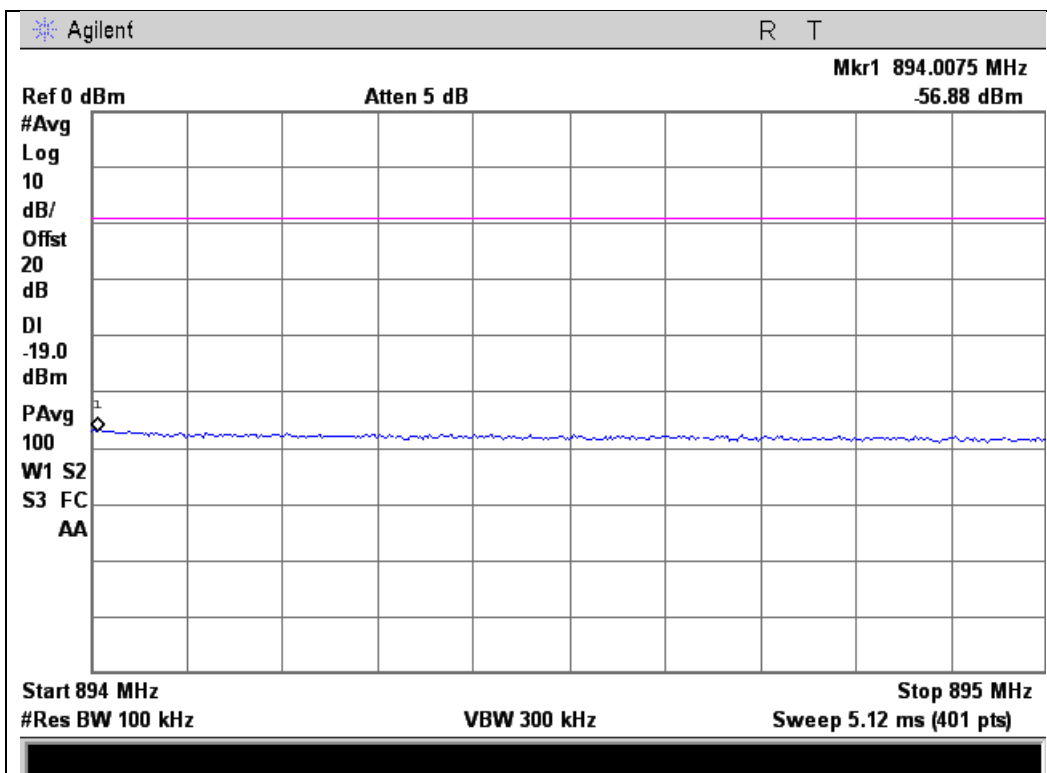



1930 - 1990 MHz Band

Lower Band Edge

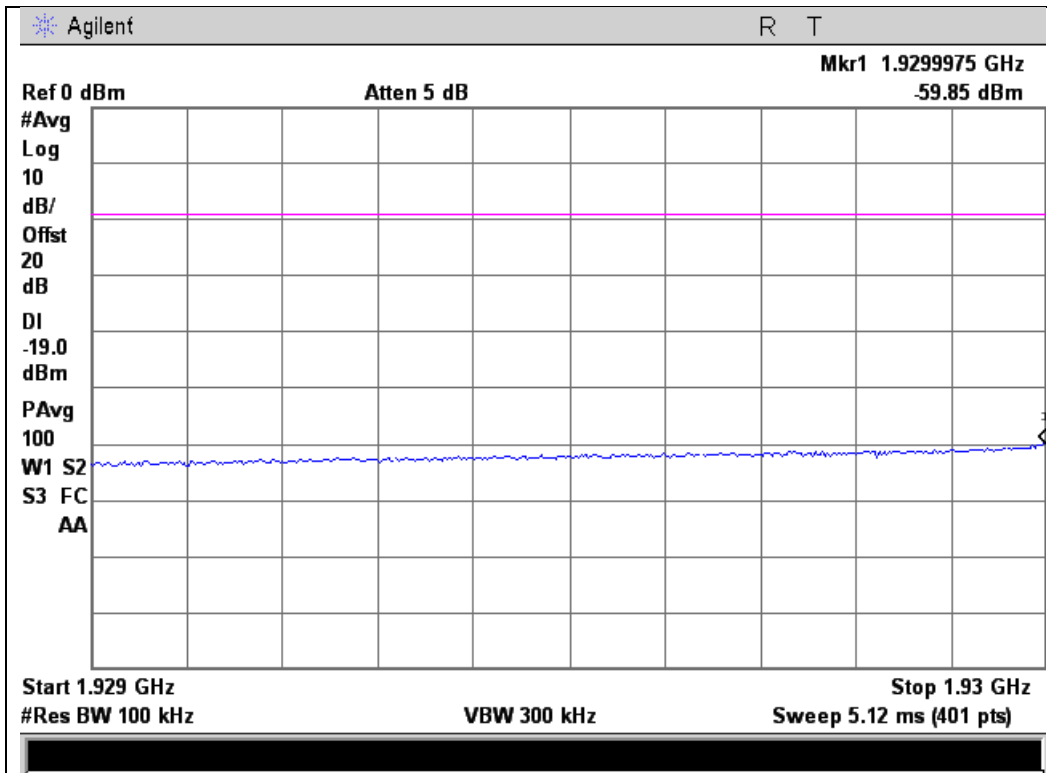

Upper Band Edge

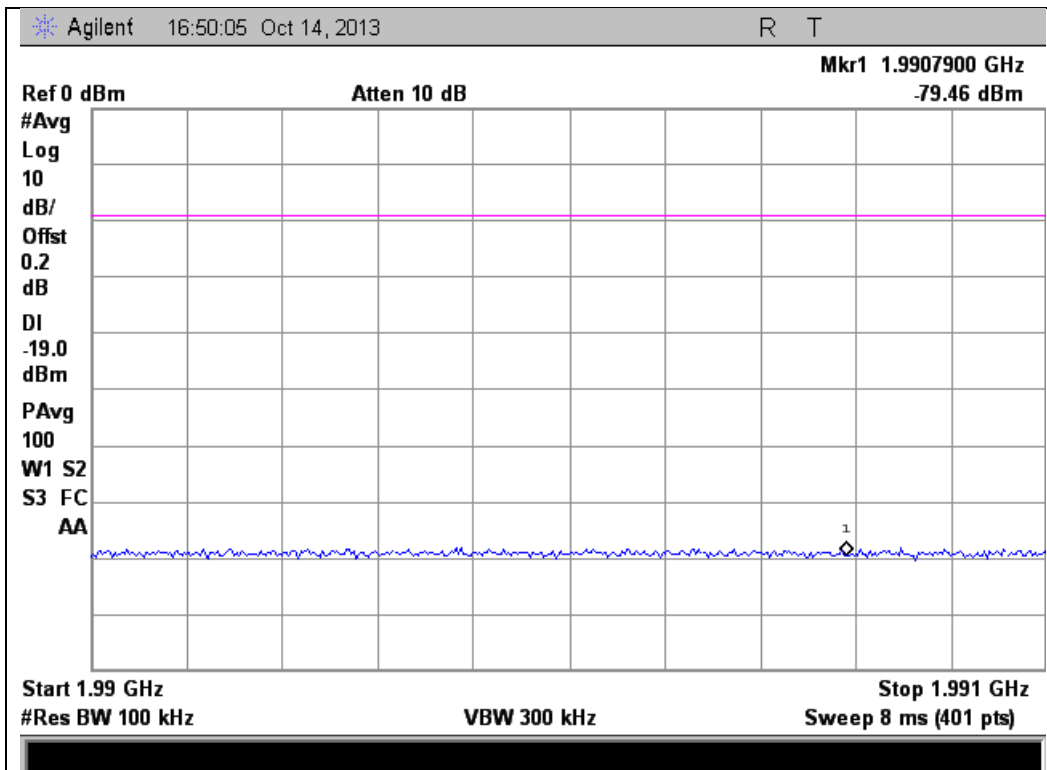



Conducted Spurious Emissions

Name of Test: Conducted Spurious Emissions

Engineer: Mike Graffeo

Test Equipment Utilized: i00331 and i00405

Test Date: 9/19/13

Test Procedure

The EUT was connected to a spectrum analyzer through an attenuator with the losses being input into the spectrum analyzer as a combination of reference level offset and correction factor as necessary to ensure accurate readings were obtained. A signal generator was utilized to produce a 4.1 MHz AWGN signal operating at the maximum allowable power. The conducted spurious emissions from 30 MHz to 10 times the highest tunable frequency for each operational band was measured excluding the band defined by the Out of band emissions test. The emissions were plotted and the highest level was recorded in the summary table.

The following formulas are used for calculating the limits.

Conducted Spurious Emissions Limit = $43 + 10\log(P)$ dB

Test Setup

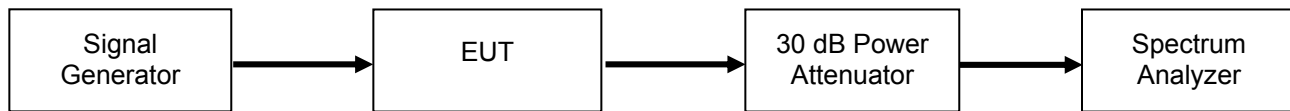

Uplink Test Results

Frequency Band (MHz)	Measured Frequency (MHz)	Measured Level (dBm)	Limit (dBm)	Result
824 - 849	1858	-33.89	-13	Pass
1850 - 1910	843.4	-28.43	-13	Pass

Downlink Test Results

Frequency Band (MHz)	Measured Frequency (MHz)	Measured Level (dBm)	Limit (dBm)	Result
869 - 894	1957	-33.61	-13	Pass
1930 - 1990	887.1	-39.02	-13	Pass



Uplink Test Plots 824 - 849 MHz Band 30MHz – 823 MHz

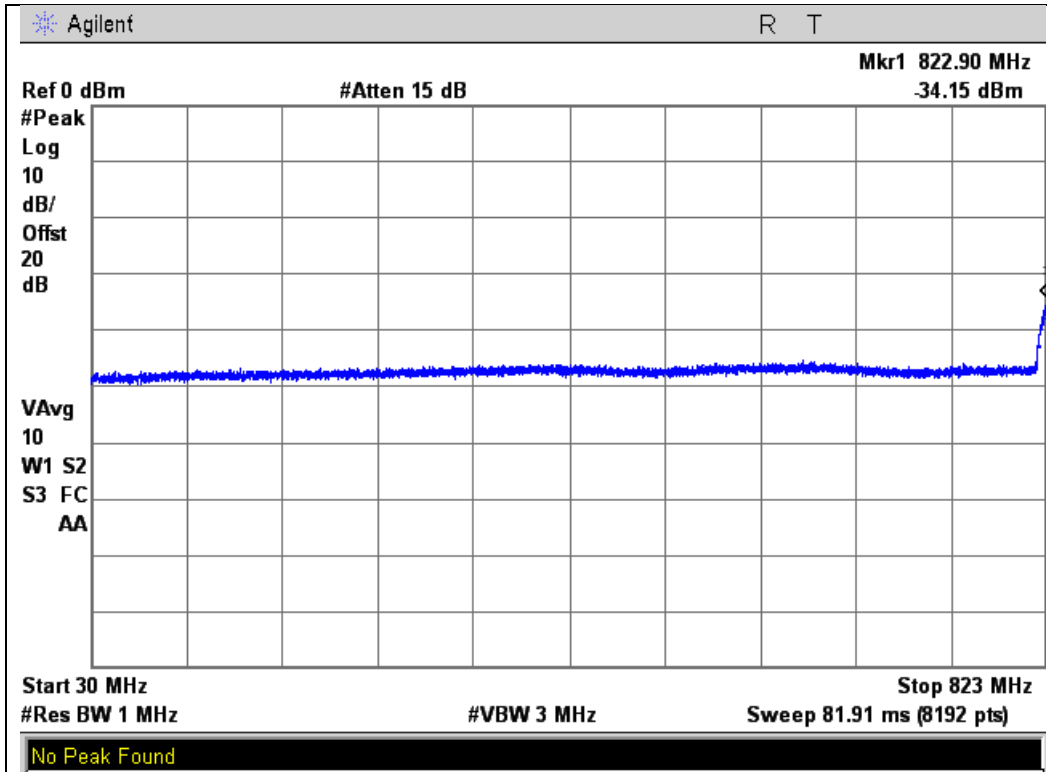

824 - 849 MHz Band 850 MHz – 8.49 GHz

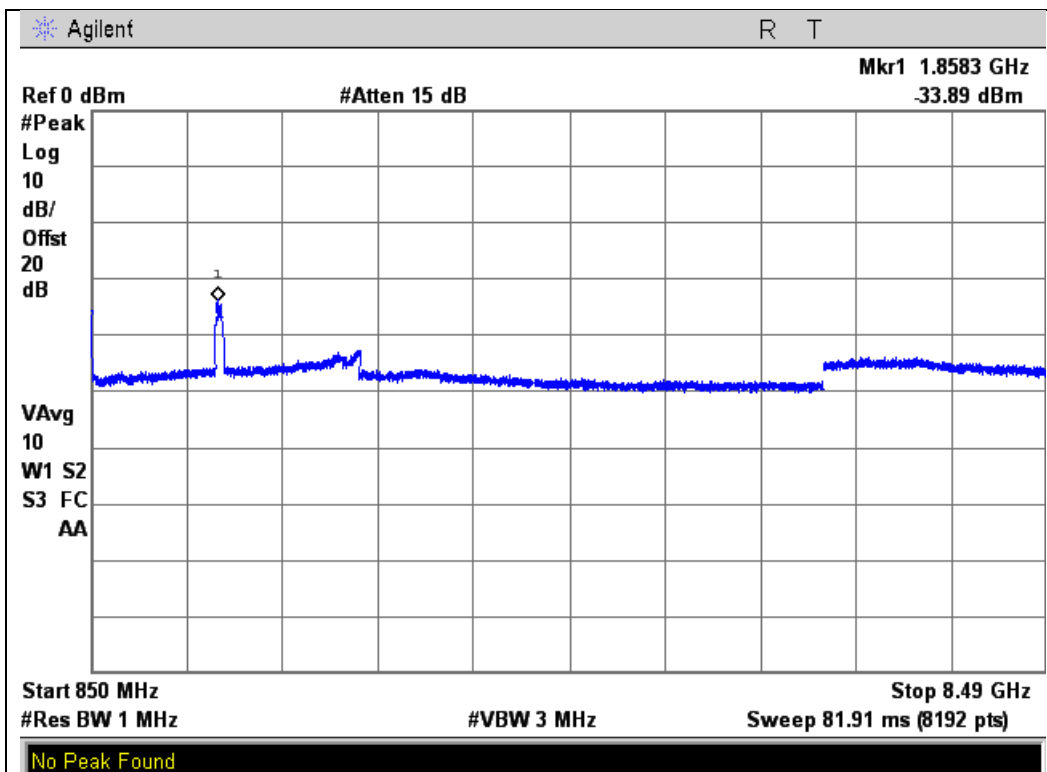



Uplink Test Plots
1850 - 1910 MHz Band
30MHz – 1.849 GHz

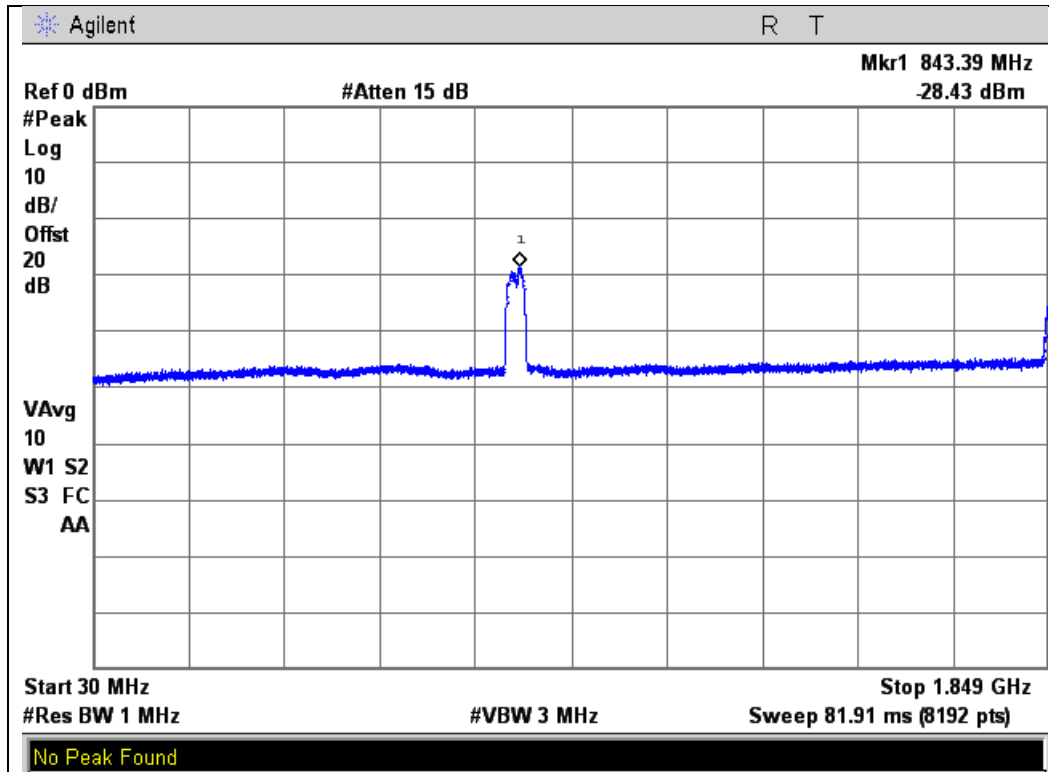

1850 - 1910 MHz Band
1.911 GHz – 8.0 GHz

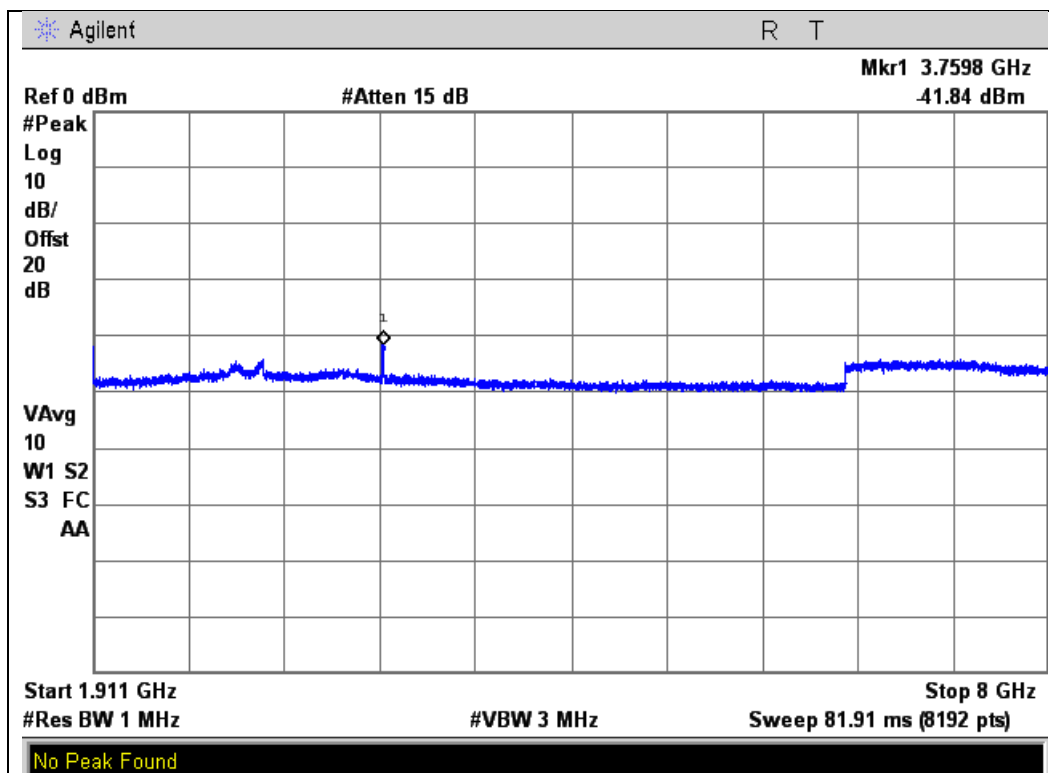



Uplink Test Plots 1850 - 1910 MHz Band 8.0 GHz – 16.0 GHz

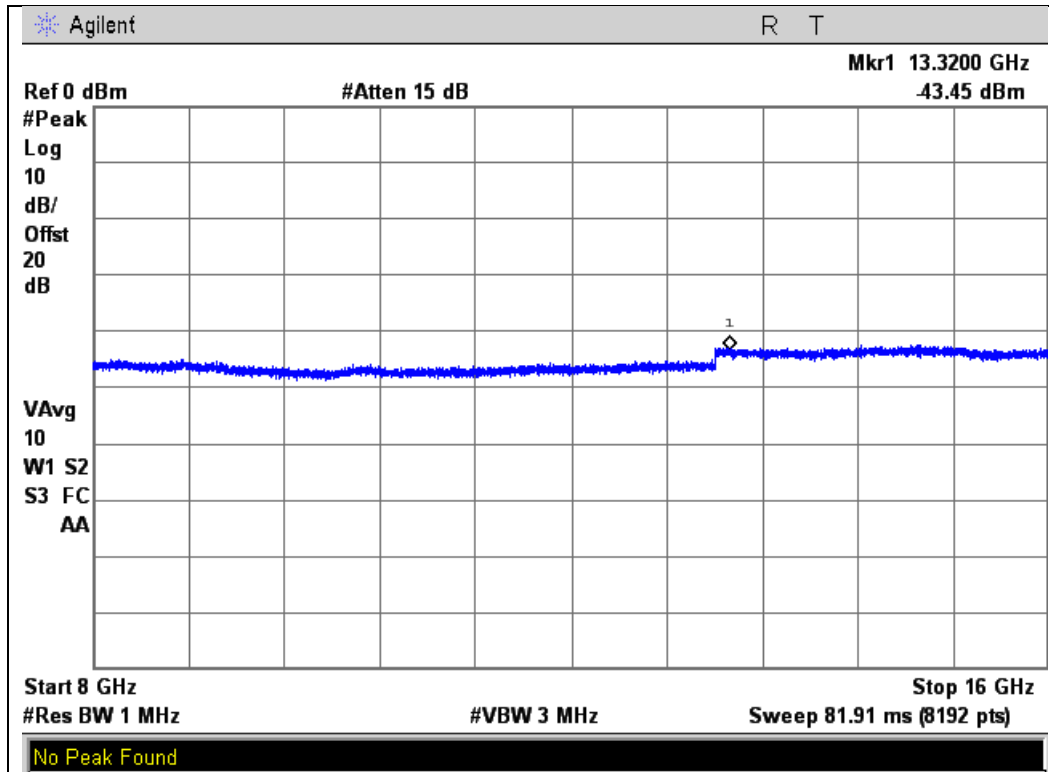

1850 - 1910 MHz Band 16.0 GHz – 24.0 GHz

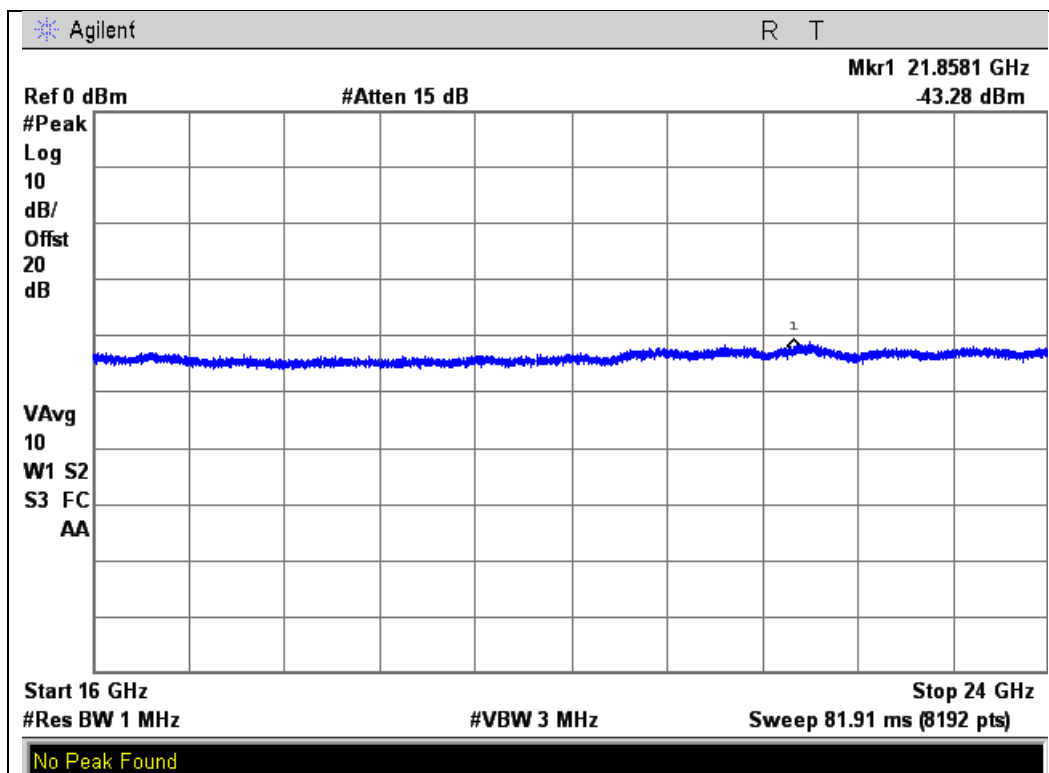



Downlink Test Plots
869 – 894 MHz Band
30MHz – 868 MHz

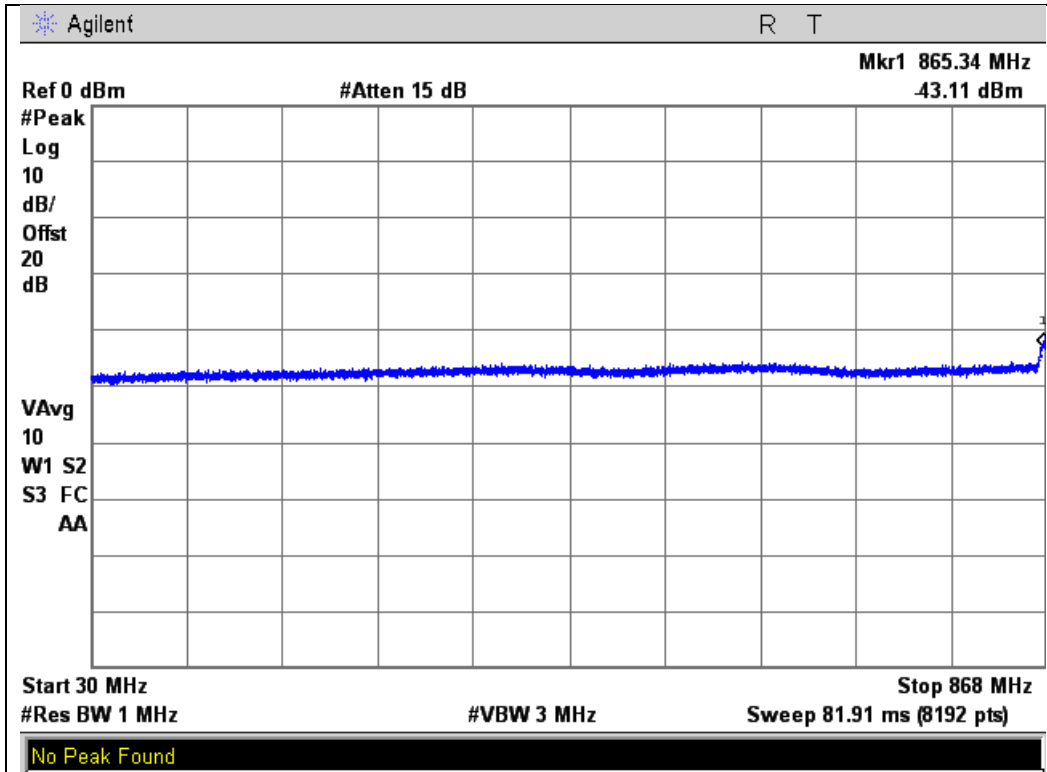

869 – 894 MHz Band
895 MHz – 8.94 GHz

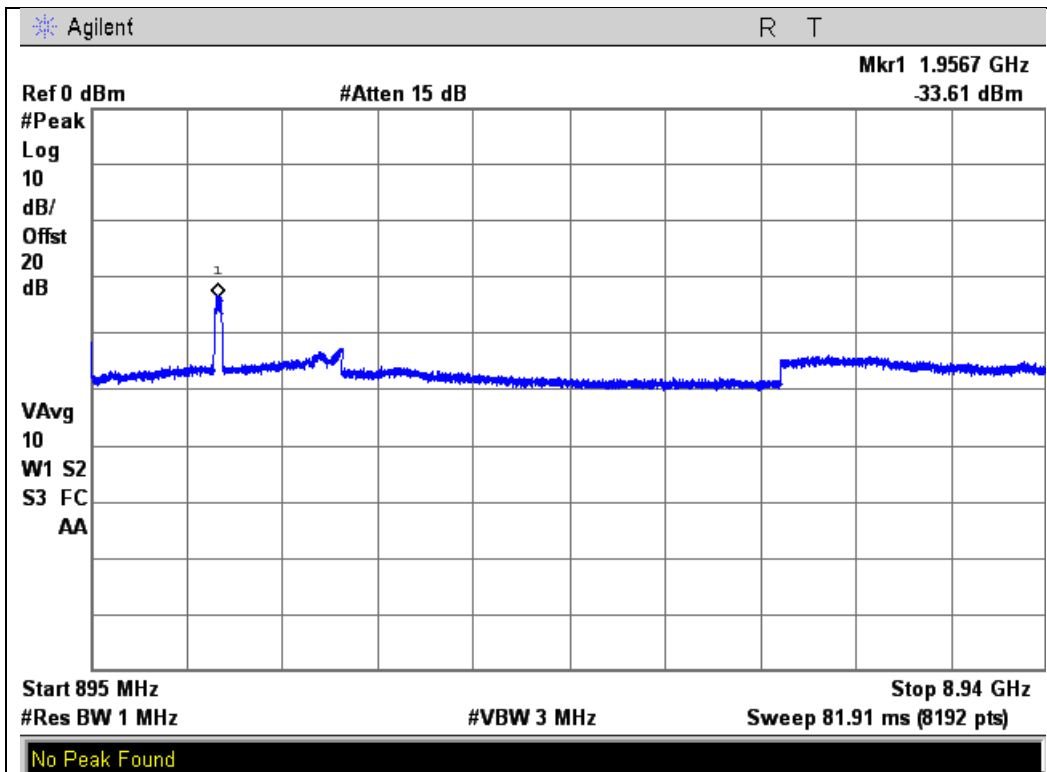



Downlink Test Plots
1930 - 1990 MHz Band
30MHz – 1.929 GHz

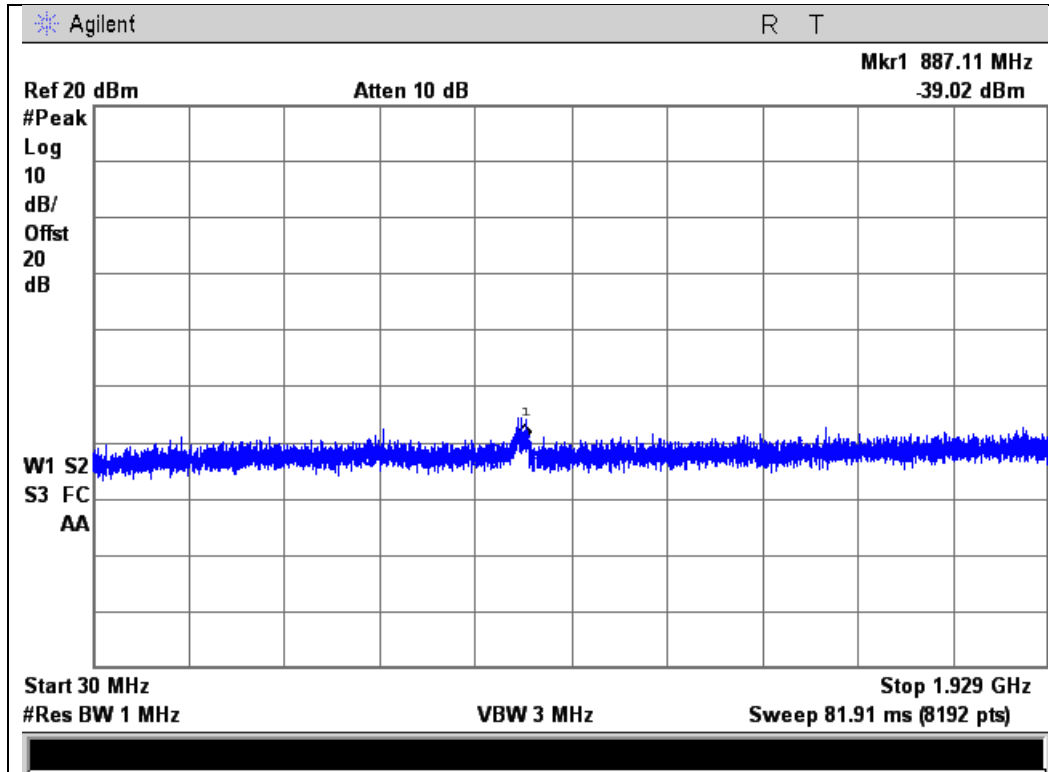

1930 - 1990 MHz Band
1.991 GHz – 8.0 GHz

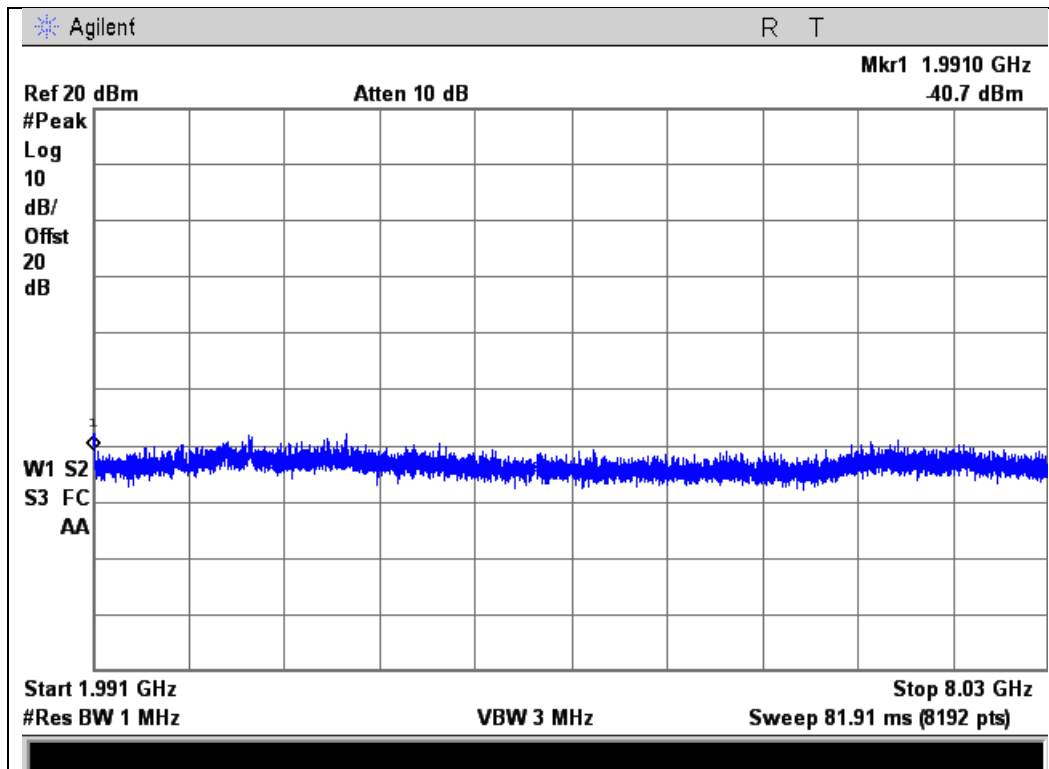



1930 - 1990 MHz Band
8.0 GHz – 16.0 GHz

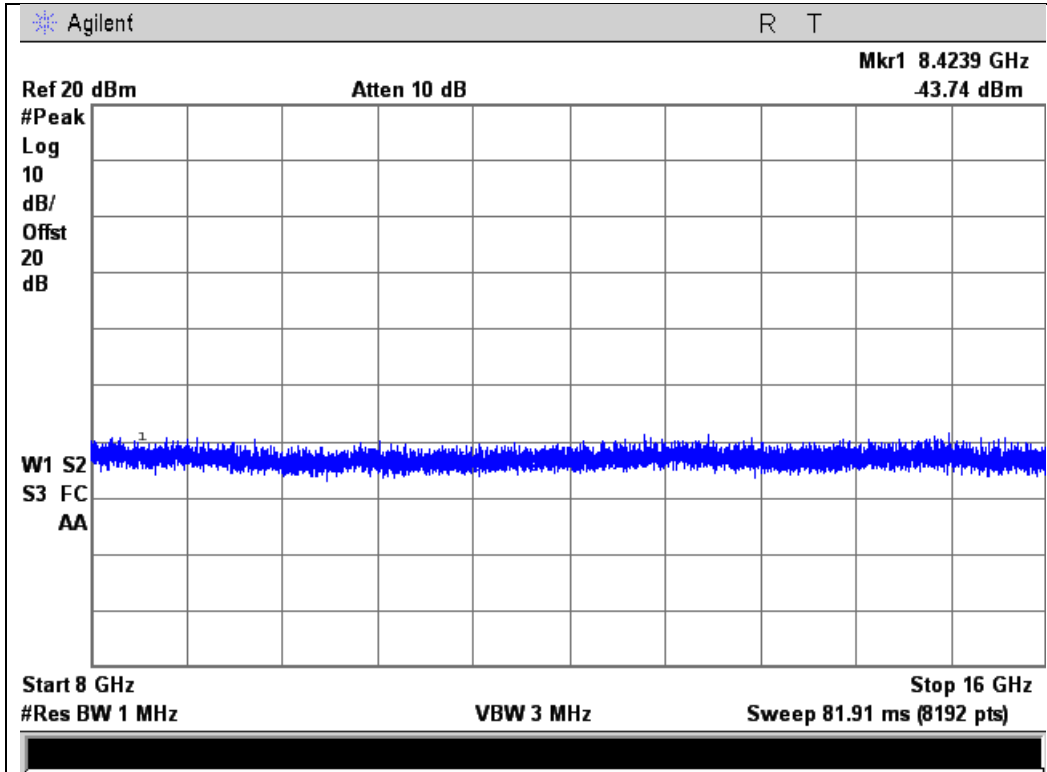

1930 - 1990 MHz Band
16.0 GHz – 24.0 GHz

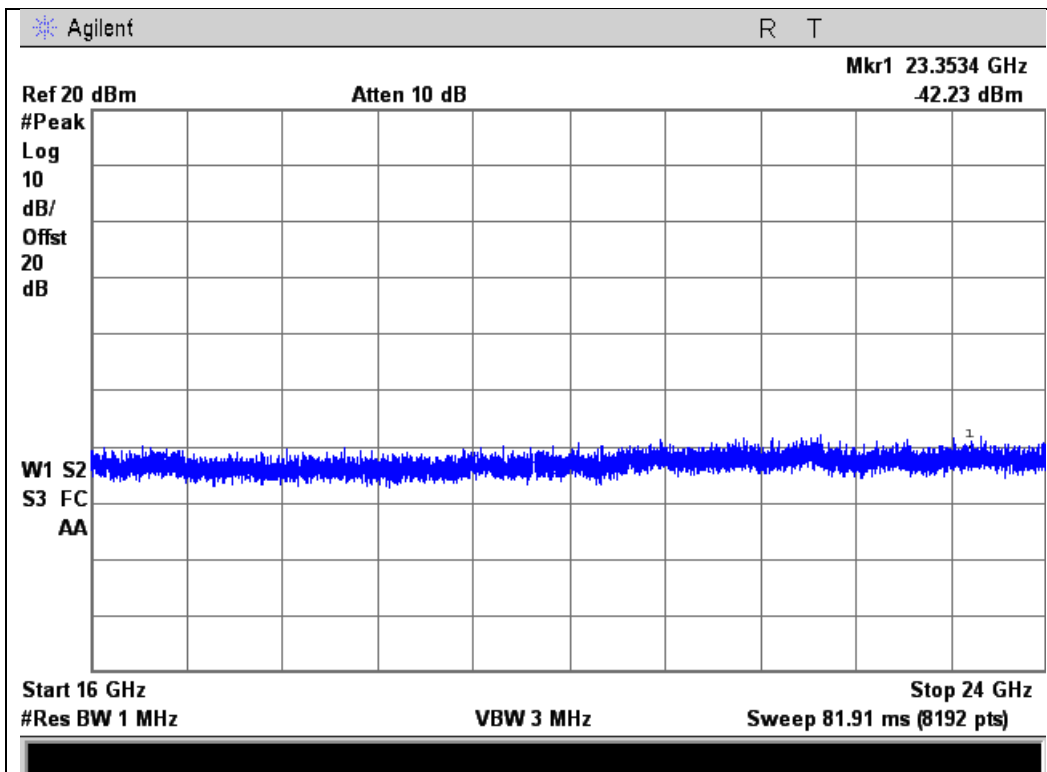



Noise Limits

Name of Test: Noise Limits
Test Equipment Utilized: i00331, i00405, i00412

Engineer: Mike Graffeo
Test Date: 9/24/13

Test Procedure

The EUT was connected to a spectrum analyzer through an attenuator with the losses being input into the spectrum analyzer as a combination of reference level offset and correction factor as necessary to ensure accurate readings were obtained. A series of three tests are performed to measure the maximum uplink and downlink noise and the variable noise for the uplink and downlink in the presence of a downlink signal. The detailed procedures from KDB 935210 D03 Wideband Consumer Signal Booster Measurement Guidance DR04-41516c were followed.

The following formulas are used for calculating the limits. Note – Downlink noise is calculated with the CF of the associated uplink band.

$$\text{Noise Power} = -102.5 + \text{LOG}_{10}(\text{Band Center Frequency}) * 20$$

$$\text{Variable Noise} = -103 \text{ dBm/MHz-RSSI}$$

Test Setup

Maximum Noise Limit



Variable Uplink Noise Power and Timing

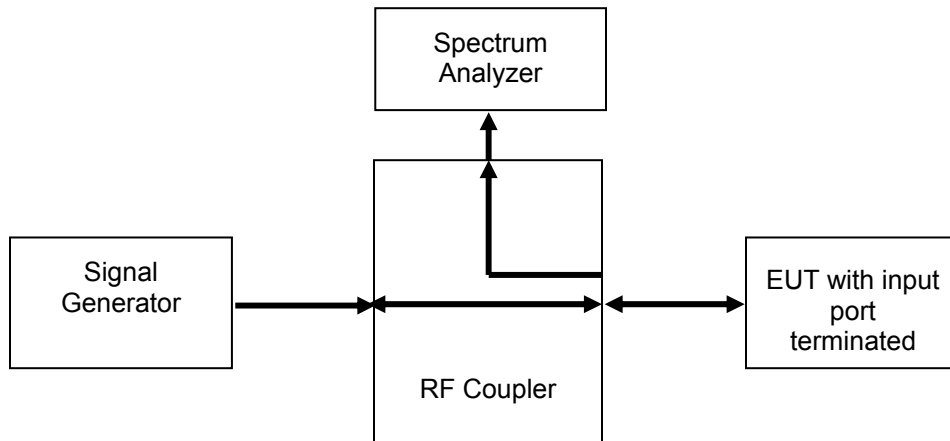

Variable Downlink Noise Power





Maximum Uplink Noise Limit Test Results

Frequency Band (MHz)	Measured Noise (dBm)	Limit (dBm)	Margin (dB)	Result
824 - 849	-45.29	-44.1	-1.2	Pass
1850 - 1910	-37.75	-37.0	-0.7	Pass

Maximum Downlink Noise Limit Test Results

Frequency Band (MHz)	Measured Noise (dBm)	Limit (dBm)	Margin (dB)	Result
869 - 894	-45.63	-44.1	-1.5	Pass
1930 - 1990	-39.96	-37.0	-2.9	Pass

Uplink Noise Timing Test Results

Frequency Band (MHz)	Measured Timing (Seconds)	Limit (Seconds)	Result
824 - 849	0.08	3.0	Pass
1850 - 1910	0.10	3.0	Pass



Variable Uplink Noise Power Test Results

824 - 849 MHz

RSSI (dBm)	Noise Limit (dBm)	Measured Noise (dBm)	Margin (dB)
-55.0	-48.0	-48.4	-0.4
-52.0	-51.0	-51.4	-0.4
-51.0	-52.0	-52.4	-0.4
-50.0	-53.0	-53.4	-0.4
-58.0	-45.0	-45.3	-0.3
-53.0	-50.0	-50.1	-0.1

1850 - 1910 MHz

RSSI (dBm)	Noise Limit (dBm)	Measured Noise (dBm)	Margin (dB)
-46.0	-57.0	-57.2	-0.2
-63.0	-40.0	-40.1	-0.1
-62.0	-41.0	-41.1	-0.1
-59.0	-44.0	-44.1	-0.1
-58.0	-45.0	-45.1	-0.1
-43.0	-60.0	-60.1	-0.1



Variable Downlink Noise Power Test Results

869 - 894 MHz

RSSI (dBm)	Noise Limit (dBm)	Measured Noise (dBm)	Margin (dB)
-40.0	-63.0	-63.3	-0.3
-39.0	-64.0	-64.3	-0.3
-58.0	-45.0	-45.2	-0.2
-56.0	-47.0	-47.1	-0.1
-43.0	-60.0	-60.1	-0.1
-40.0	-63.0	-63.3	-0.3

1930 - 1990 MHz

RSSI (dBm)	Noise Limit (dBm)	Measured Noise (dBm)	Margin (dB)
-60.0	-43.0	-43.5	-0.5
-44.0	-59.0	-59.5	-0.5
-43.0	-60.0	-60.5	-0.5
-42.0	-61.0	-61.5	-0.5
-61.0	-42.0	-42.4	-0.4
-50.0	-53.0	-53.2	-0.2



Maximum Uplink Noise Test Plots

824 - 849 MHz Band

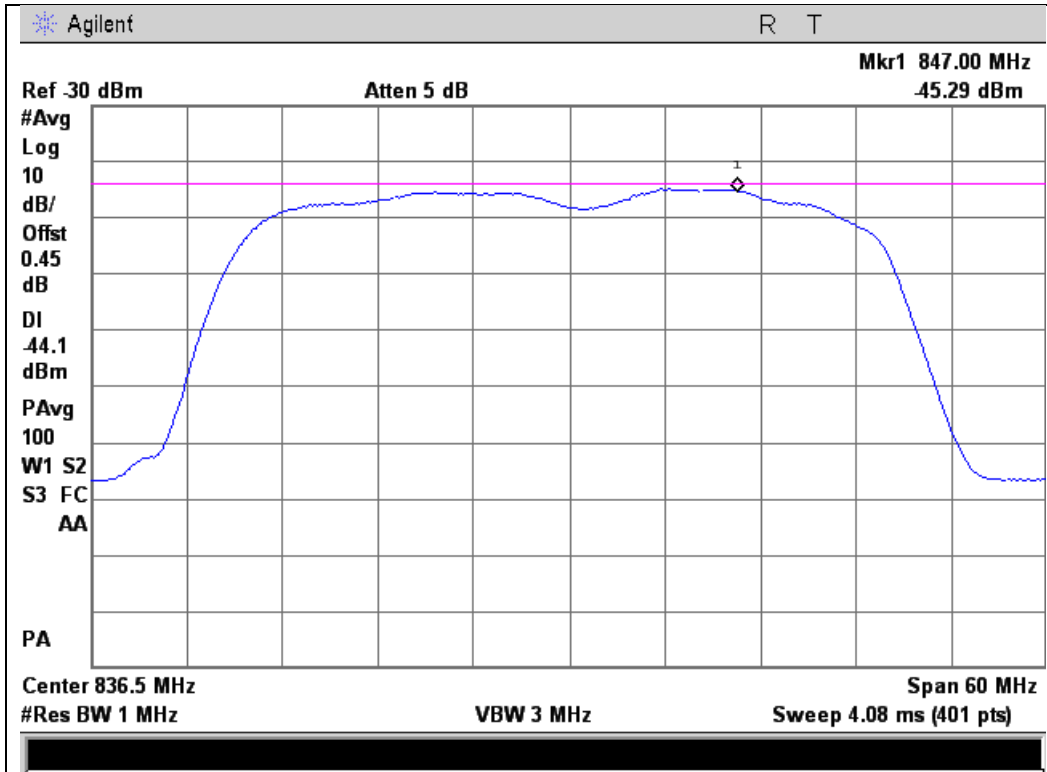

1850 - 1910 MHz Band

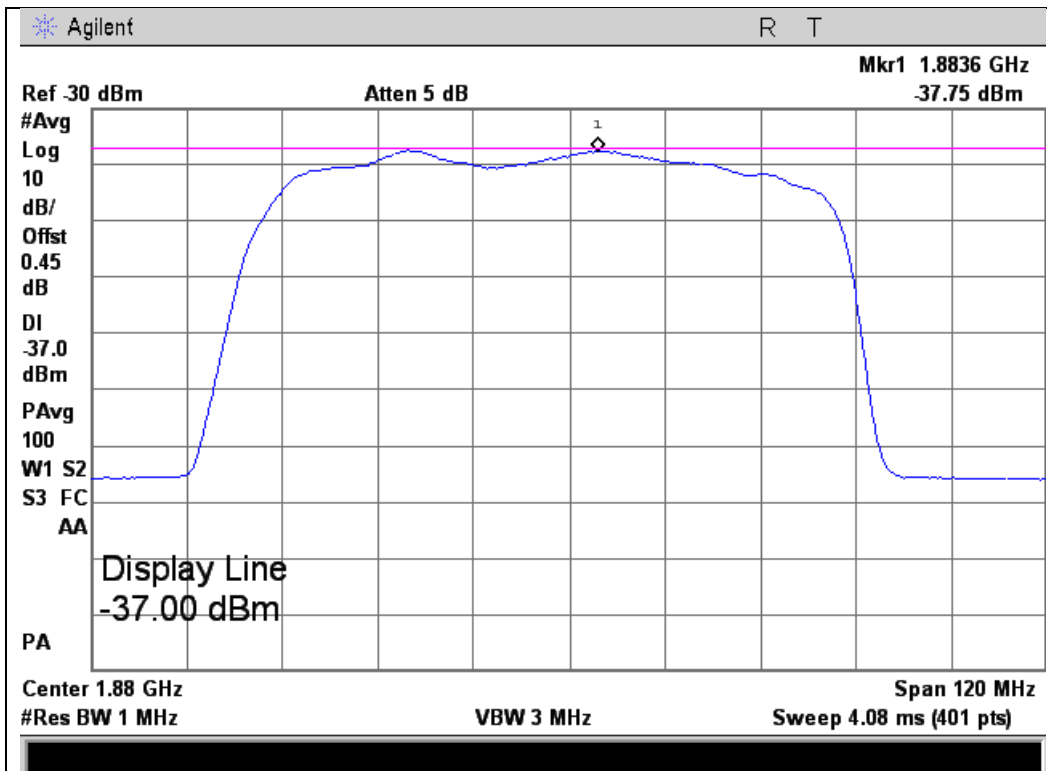



Maximum Downlink Noise Test Plots

869 - 894 MHz Band

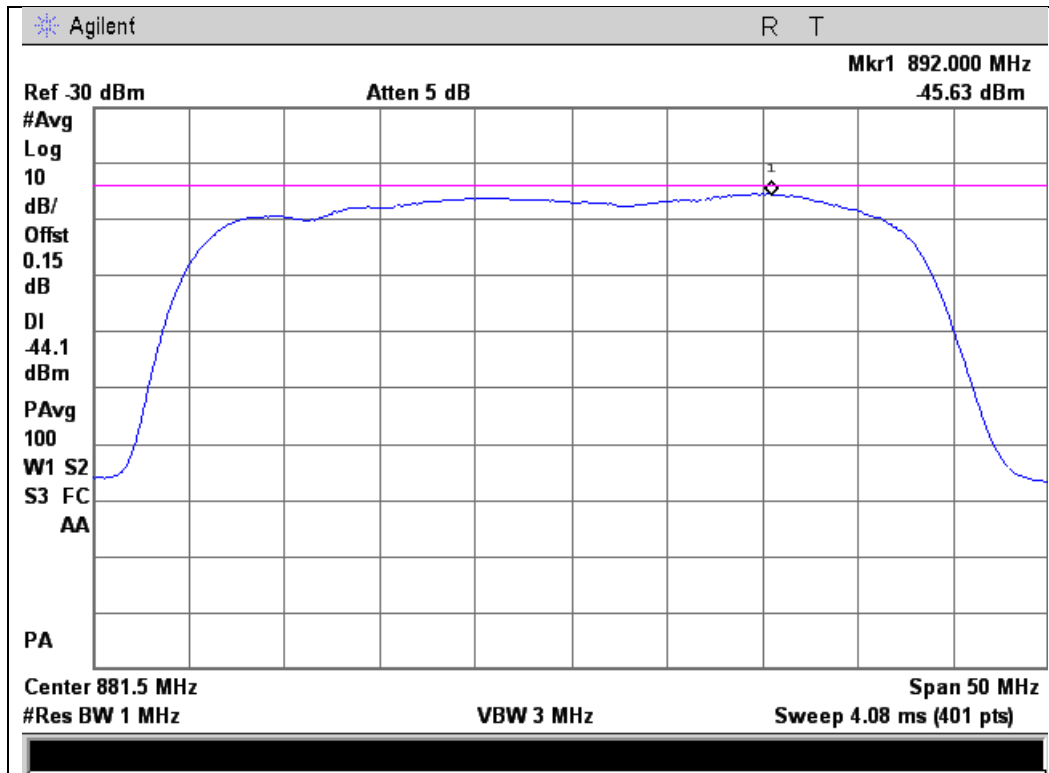



1930 - 1990 MHz Band

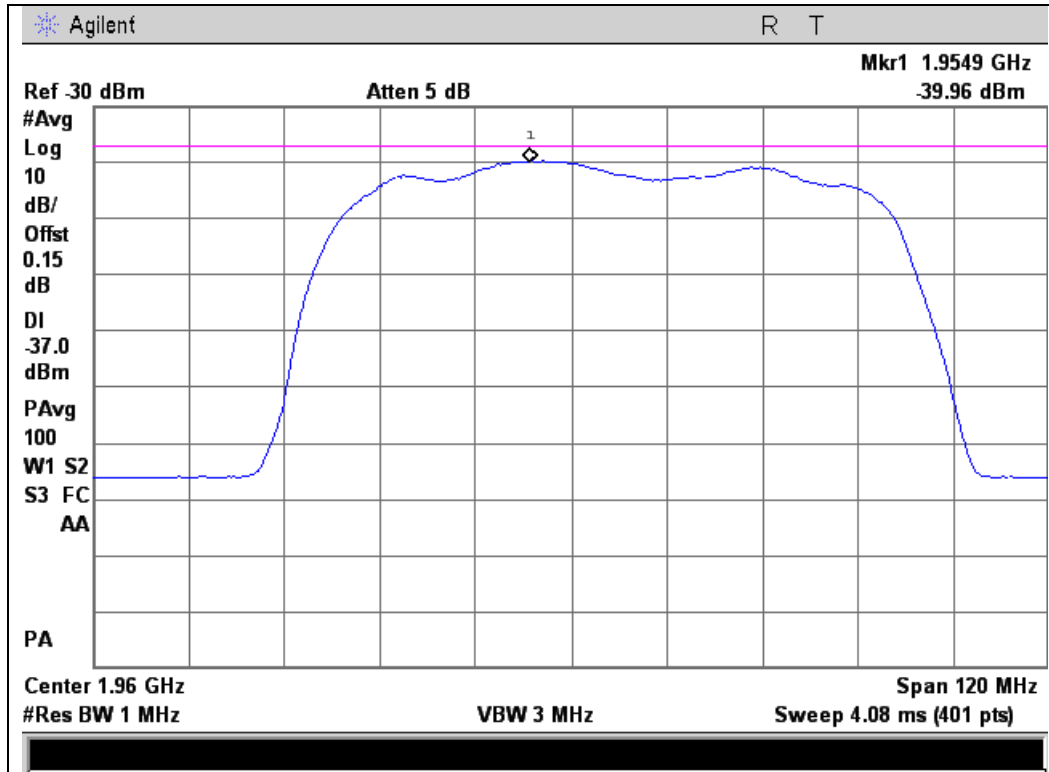



Uplink Noise Timing Test Plots

824 - 849 MHz Band

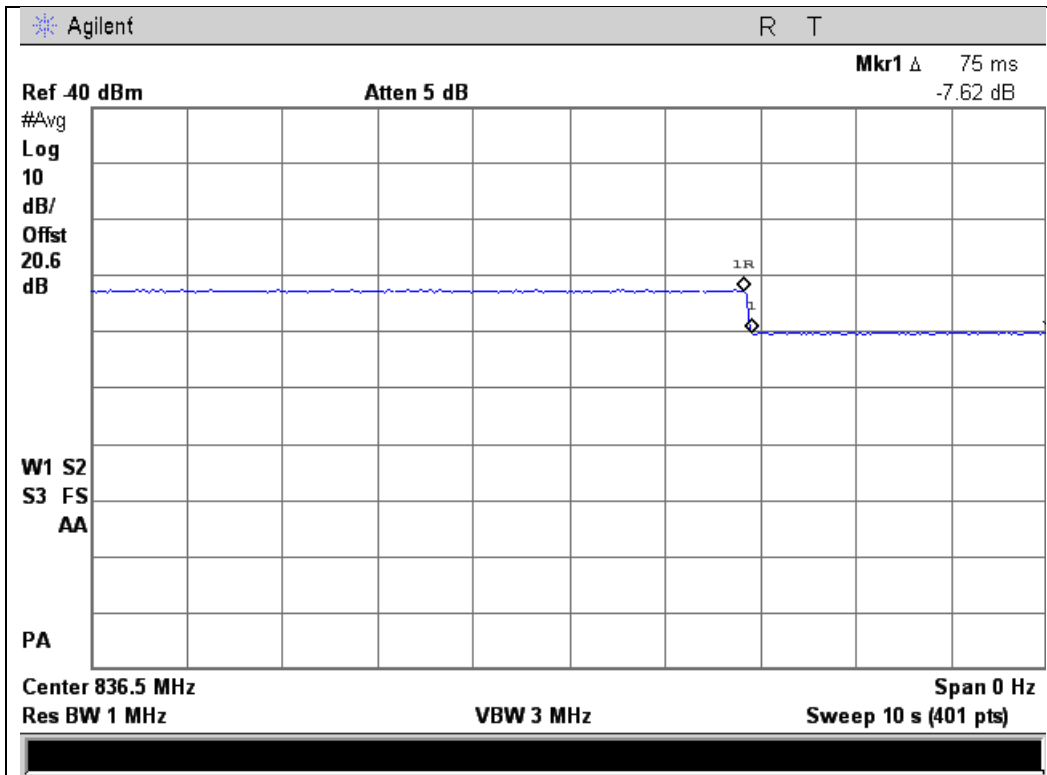

1850 - 1910 MHz Band

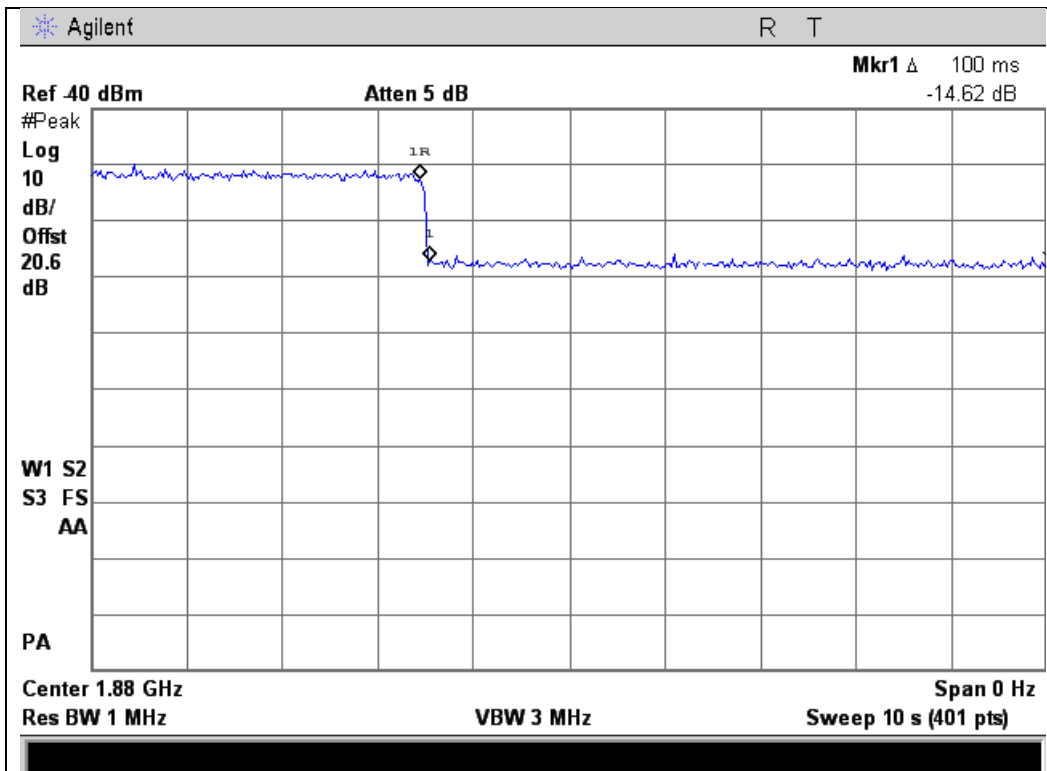



Uplink Inactivity

Name of Test: Uplink Inactivity

Engineer: Mike Graffeo

Test Equipment Utilized: i00331

Test Date: 9/20/13

Test Procedure

The EUT was connected directly to a spectrum analyzer set to operate in the center of the EUT operational uplink band. The span was set to 0 Hz with a sweep time of 330 seconds and MAX HOLD operation. The EUT was powered on and the time for the uplink to return to an inactive state was measured using the DELTA MARKER method was utilized to ensure it was less than 300 seconds. The noise level after the return to an inactive state was less than 70 dBm/MHz.

Test Setup



Uplink Test Results

Frequency Band (MHz)	Measured Time (Seconds)	Limit (Seconds)	Result
824 - 849	297.8	300	Pass
1850 - 1910	298.6	300	Pass



Uplink Inactivity Test Results

824 - 849 MHz

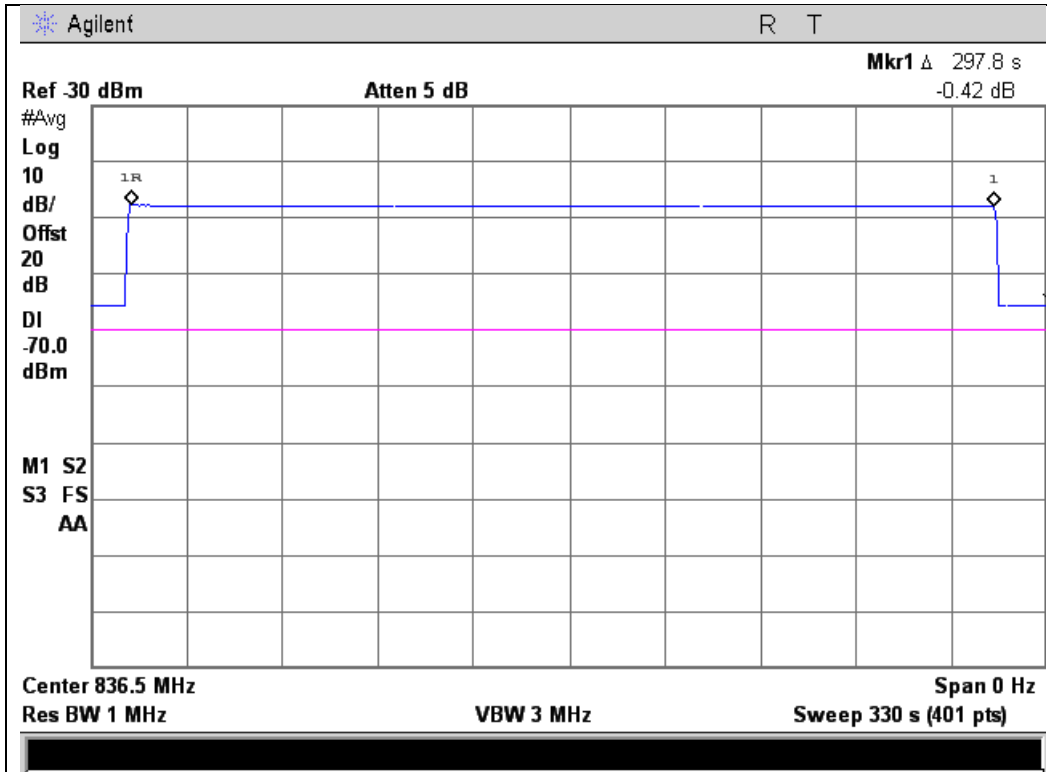

1850 - 1915 MHz

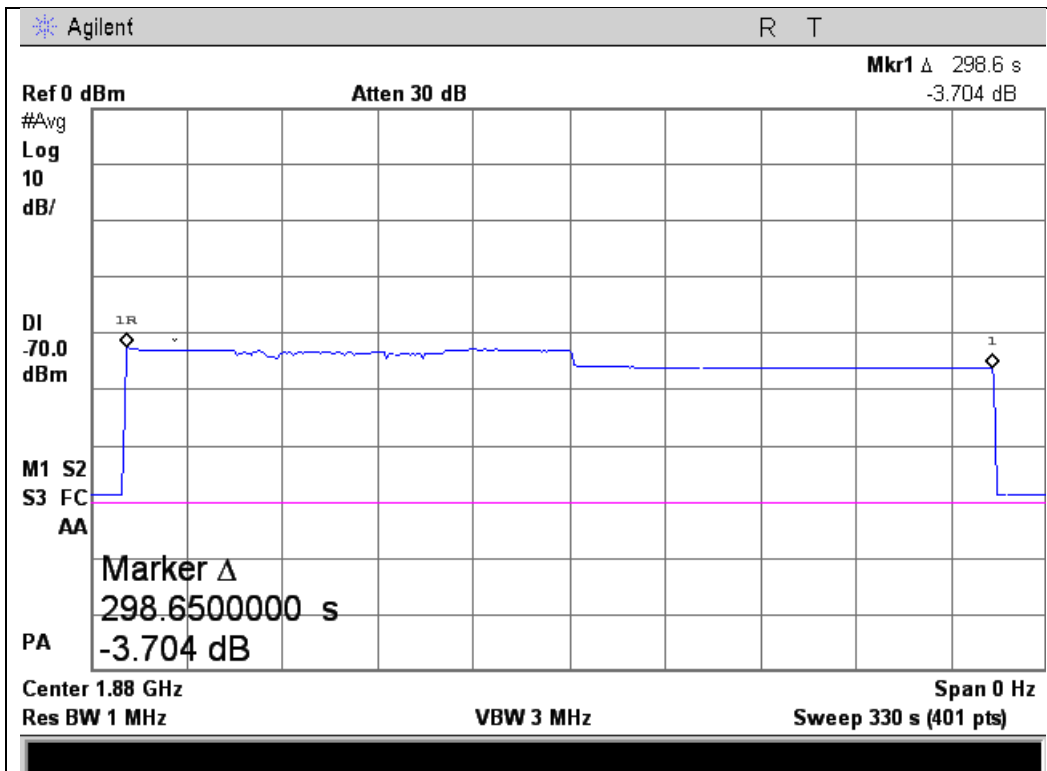



Variable Gain

Name of Test: Variable Gain
Test Equipment Utilized: i00331, i00405, i00412

Engineer: Mike Graffeo
Test Date: 9/24/13

Test Procedure

The EUT was connected to a spectrum analyzer through an attenuator with the losses being input into the spectrum analyzer as a combination of reference level offset and correction factor as necessary to ensure accurate readings were obtained. The uplink gain in the presence of a downlink signal was measured for each operational uplink band using the detailed procedures from KDB 935210 D03 Wideband Consumer Signal Booster Measurement Guidance DR04-41516.

The following formula is used for calculating the limits.
Variable Gain = -34 dB - RSSI +MSCL

Gain timing was verified by decreasing to a specific level and verifying the EUT responded with in 1sec.

Test Setup

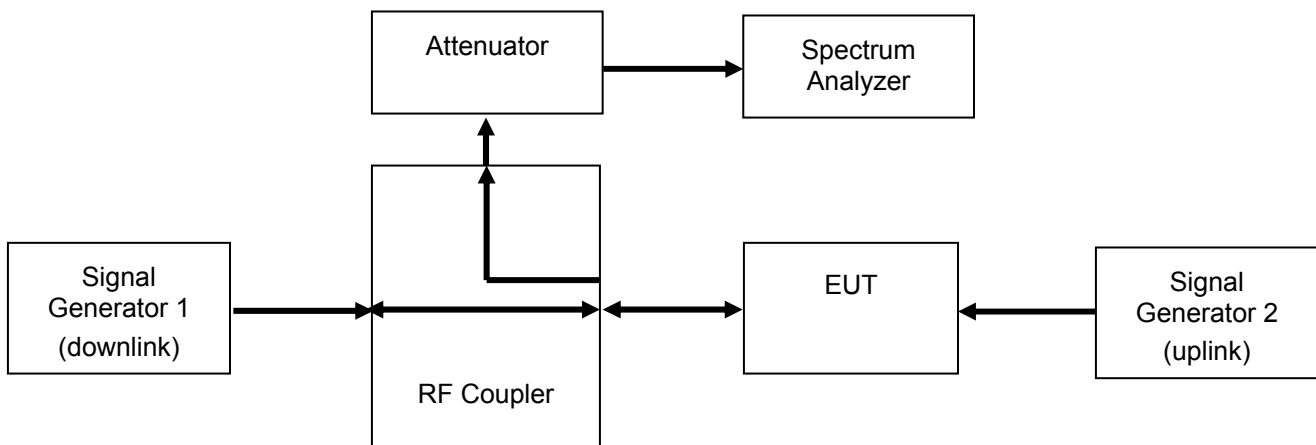



Uplink Test Results

824 - 849 MHz

RSSI (dBm)	Gain Limit (dBm)	P(in) (dBm)	P(out) (dBm)	Gain (dB)	Margin (dB)
-54.0	56.3	-37.3	16.5	53.8	-2.5
-43.0	45.3	-37.3	5.7	43.0	-2.3
-47.0	49.3	-37.3	10.0	47.3	-2.0
-45.0	47.3	-37.3	8.1	45.4	-1.9
-46.0	48.3	-37.3	9.6	46.9	-1.4
-44.0	46.3	-37.3	7.6	44.9	-1.4

1850 - 1915 MHz

RSSI (dBm)	Gain Limit (dBm)	P(in) (dBm)	P(out) (dBm)	Gain (dB)	Margin (dB)
-57.0	64.2	-46.0	10.8	56.8	-7.4
-52.0	59.2	-46.0	5.8	51.8	-7.4
-56.0	63.2	-46.0	9.9	55.9	-7.3
-60.0	67.2	-46.0	13.9	59.9	-7.3
-62.0	69.2	-46.0	16.0	62.0	-7.2
-51.0	58.2	-46.0	5.0	51.0	-7.2



Variable Uplink Gain Timing Test Results

Frequency Band (MHz)	Measured Timing (Seconds)	Limit (Seconds)	Result
824 - 849	0.110	1.0	Pass
1850 - 1910	0.350	1.0	Pass



Variable Uplink Gain Timing

824 - 849 MHz

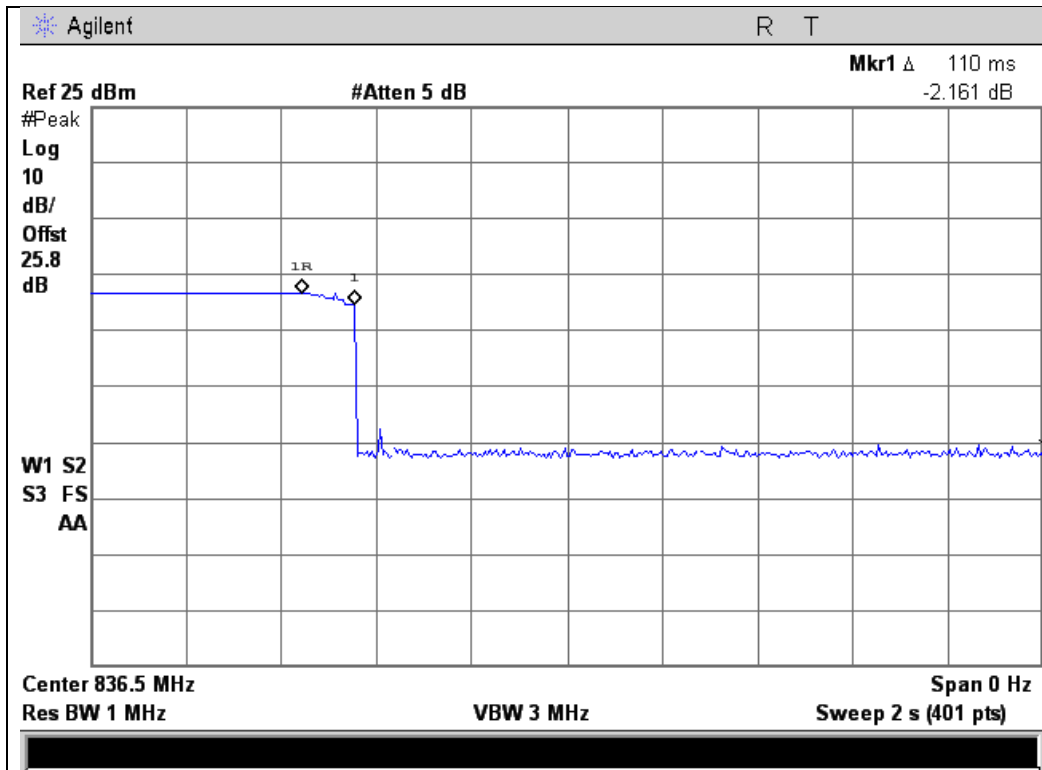

1850 - 1910 MHz

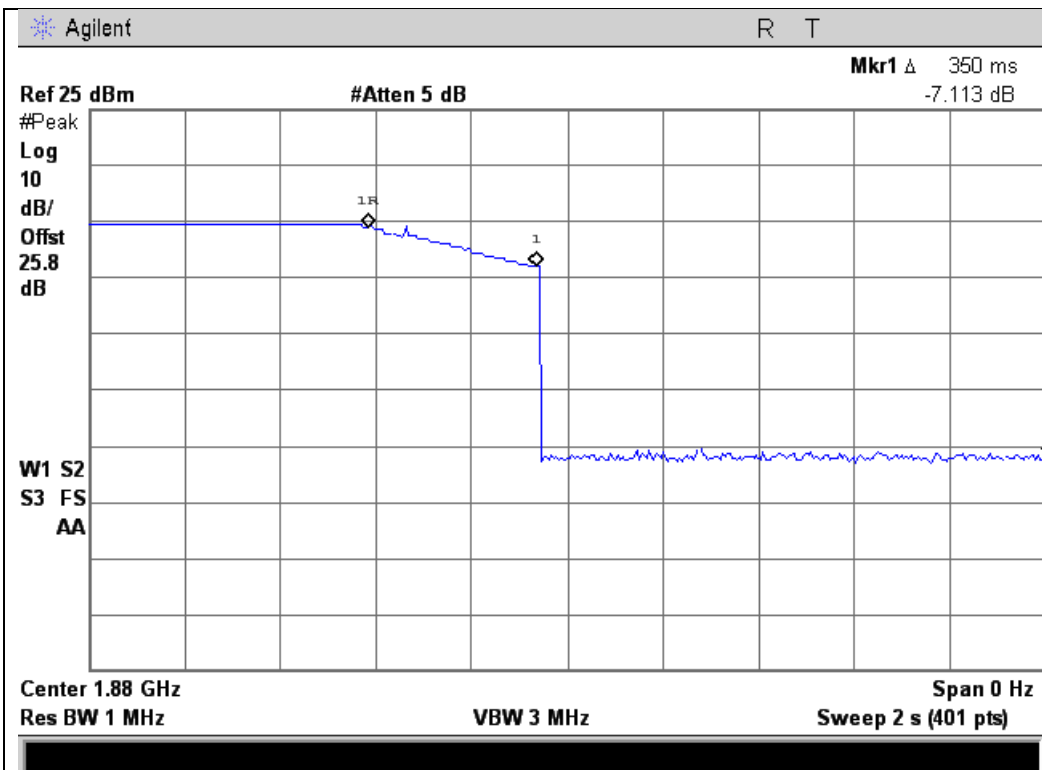



Occupied Bandwidth

Name of Test: Occupied Bandwidth

Engineer: Mike Graffeo

Test Equipment Utilized: i00331 and i00405

Test Date: 9/20/13

Test Procedure

The EUT was connected to a spectrum analyzer through an attenuator with the losses being input into the spectrum analyzer as a combination of reference level offset and correction factor as necessary to ensure accurate readings were obtained. A signal generator was utilized to produce the following signals; GSM, CDMA, and WCDMA tuned to the center channel of each the EUT operational uplink and downlink band with the RF level set a point just prior to the AGC being in control of the power. For each modulation type the input and output signal was measured and plotted to ensure that the signals were similar.

Test Setup

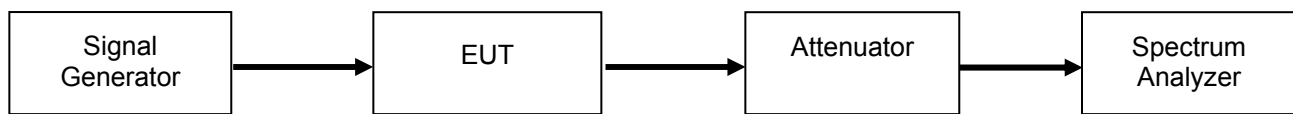



GSM Uplink Test Plots

824 - 849 MHz Band

Input

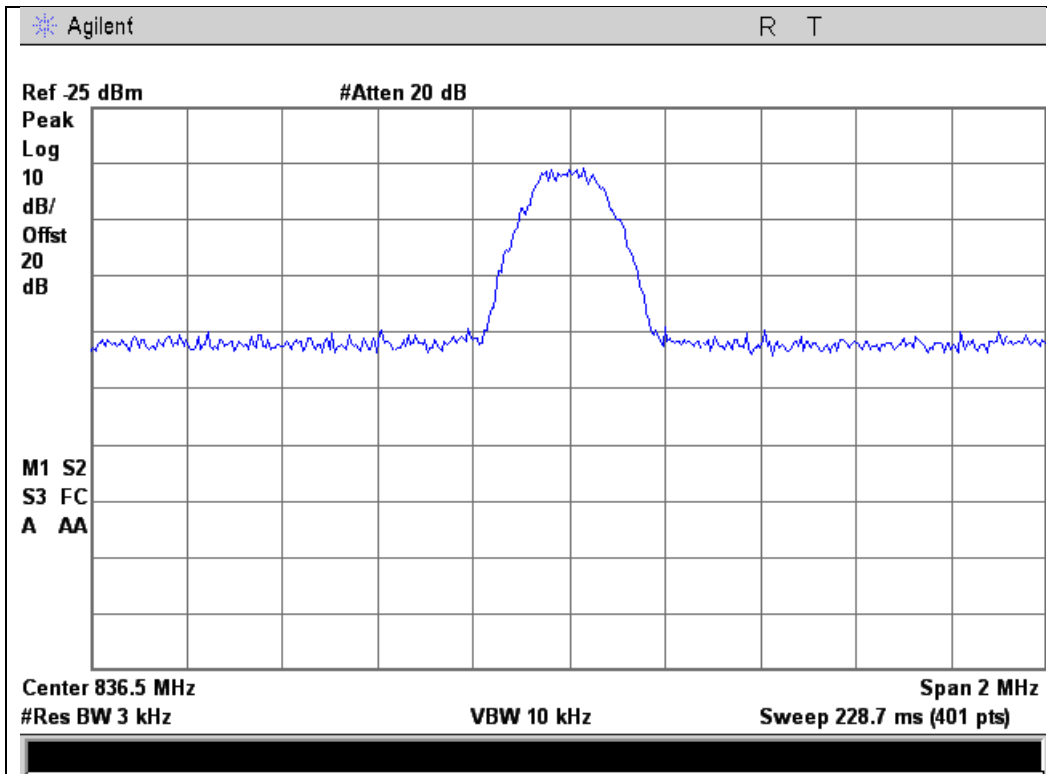

Output

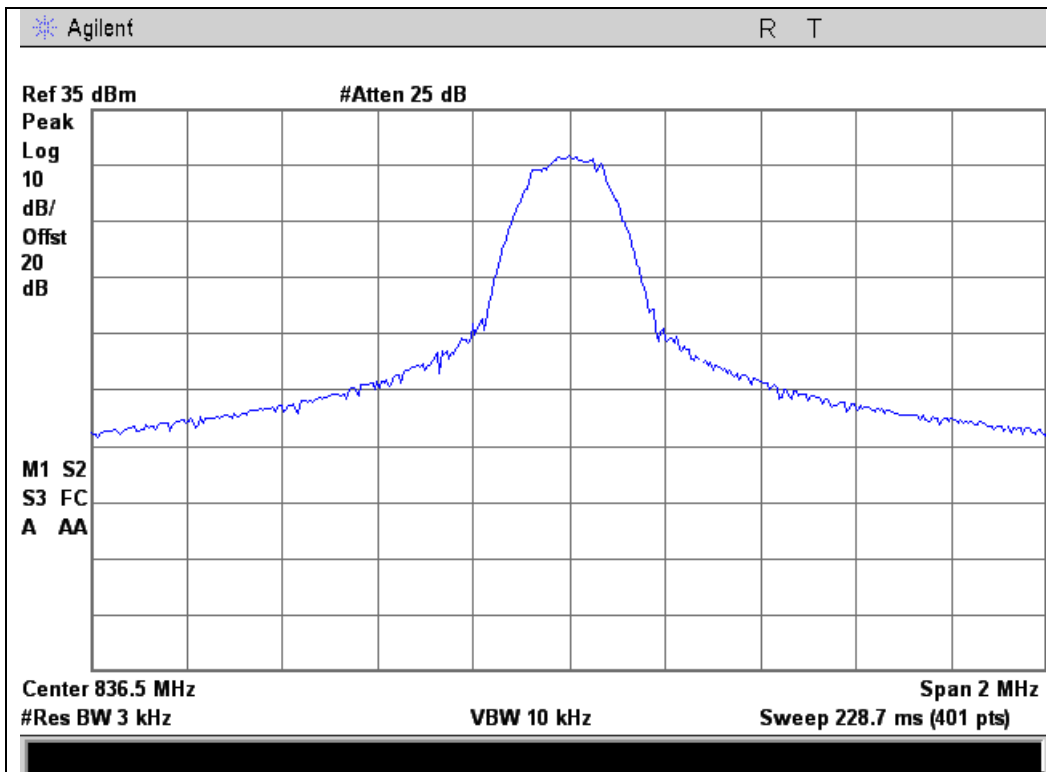



1850 - 1910 MHz Band

Input

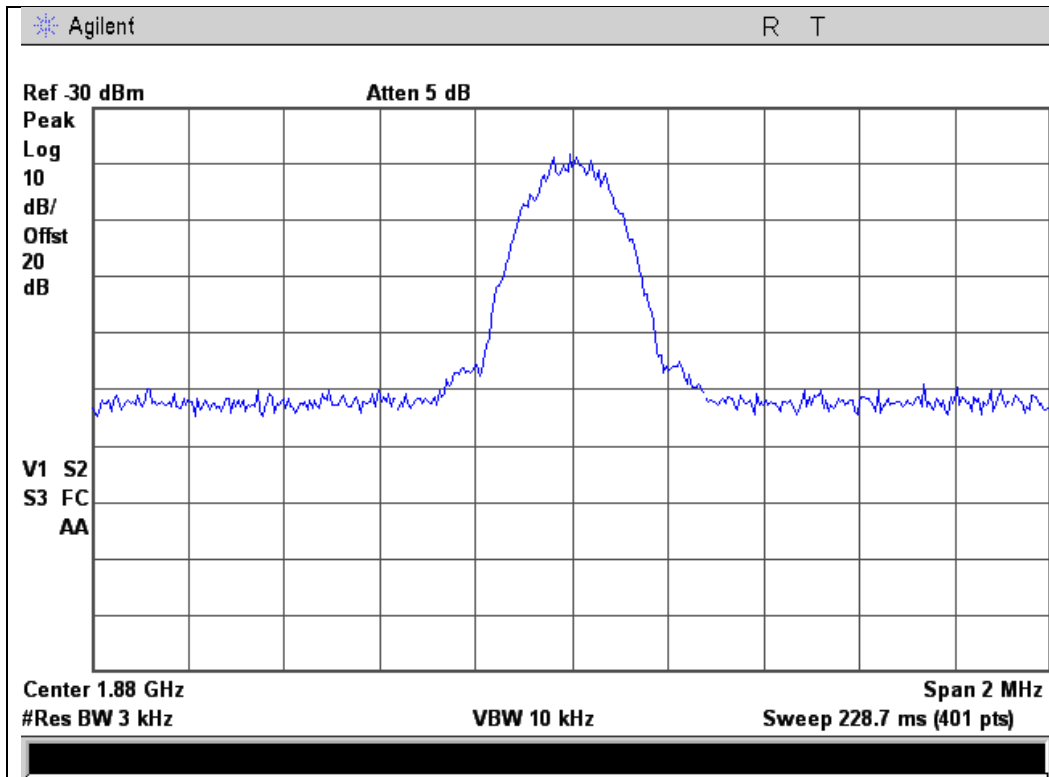

Output

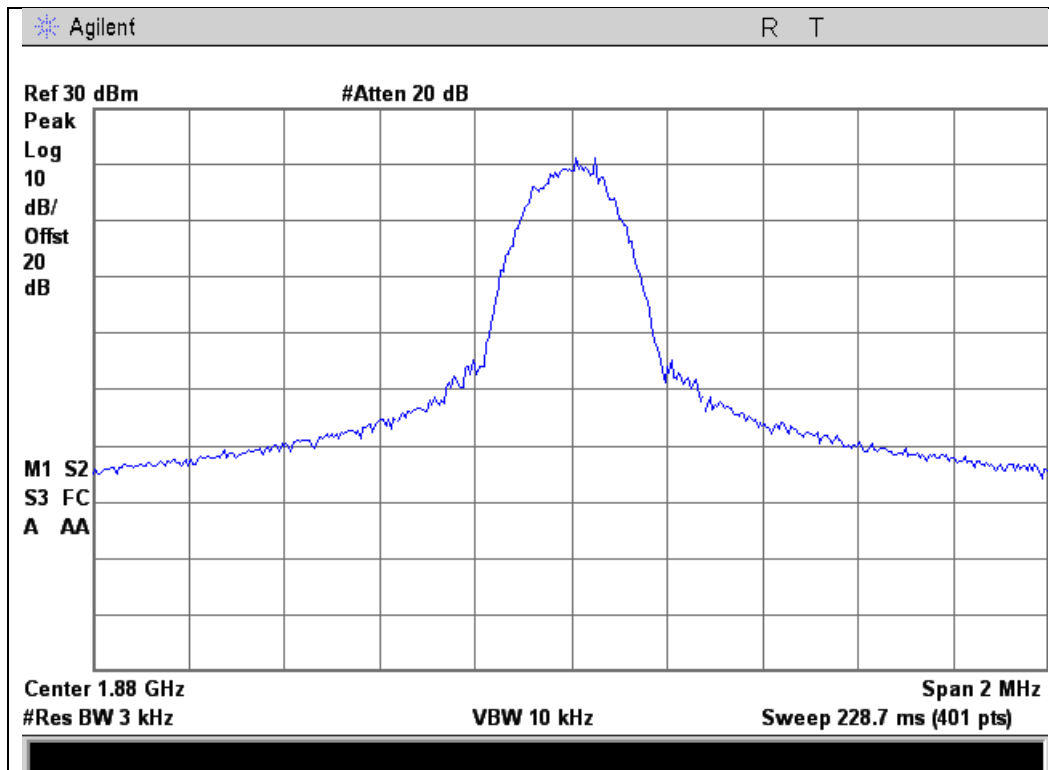



GSM Downlink Test Plots

869 - 894 MHz Band

Input

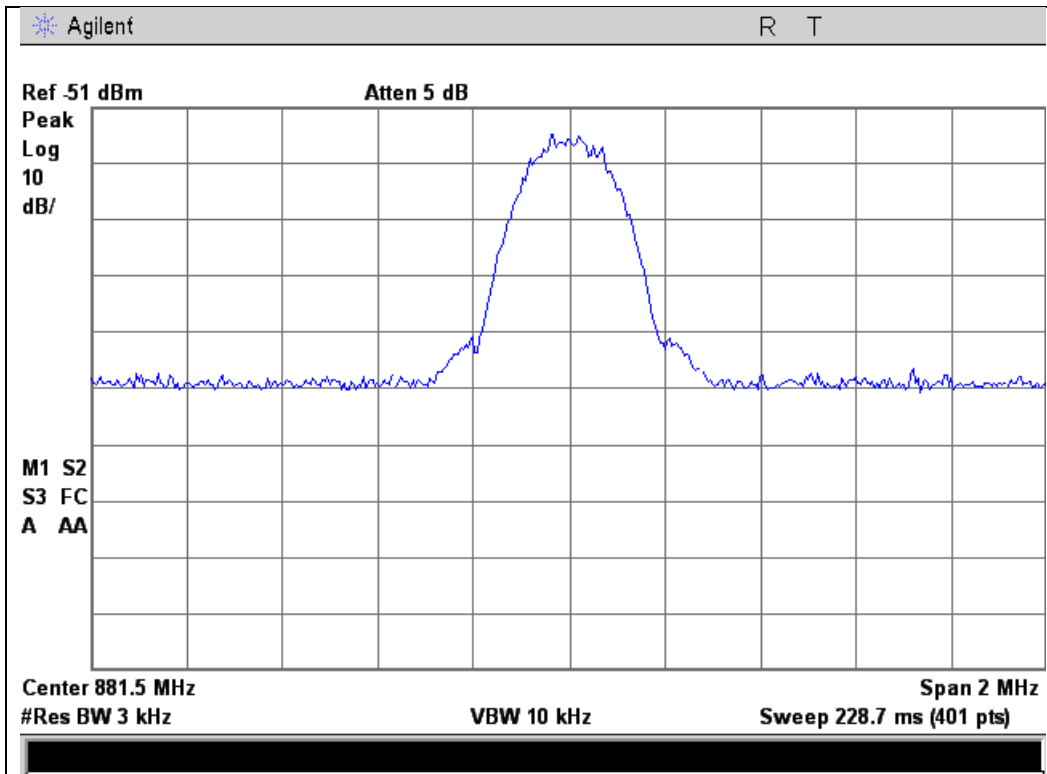

Output

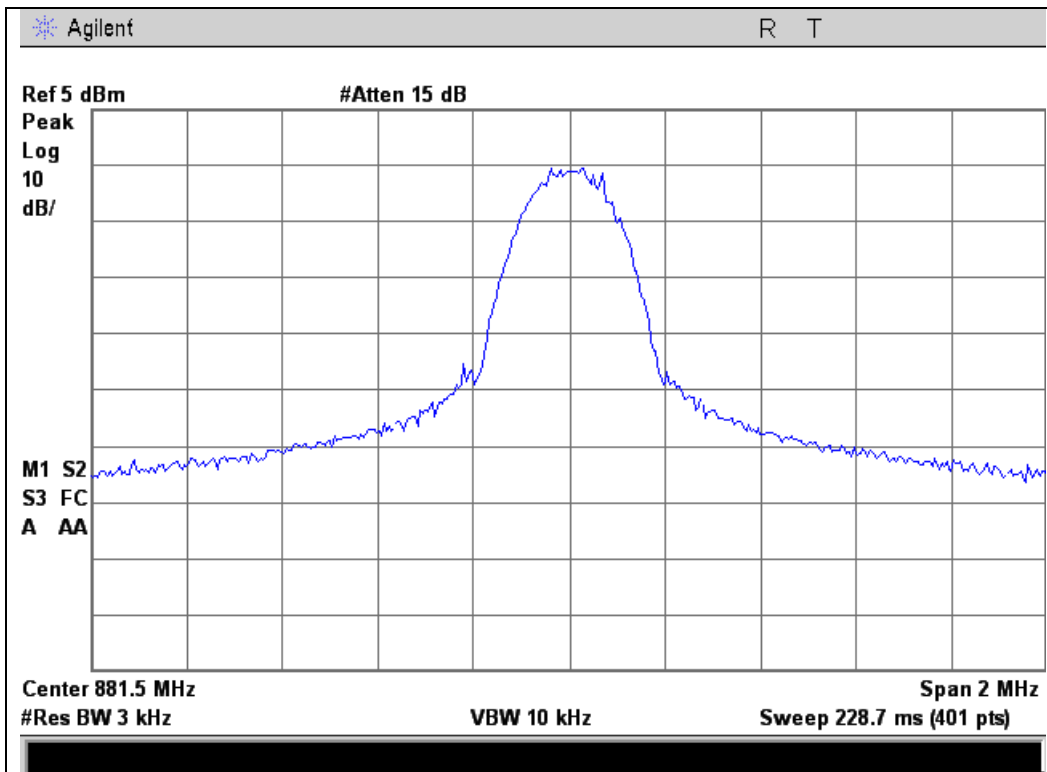



1930 - 1990 MHz Band

Input

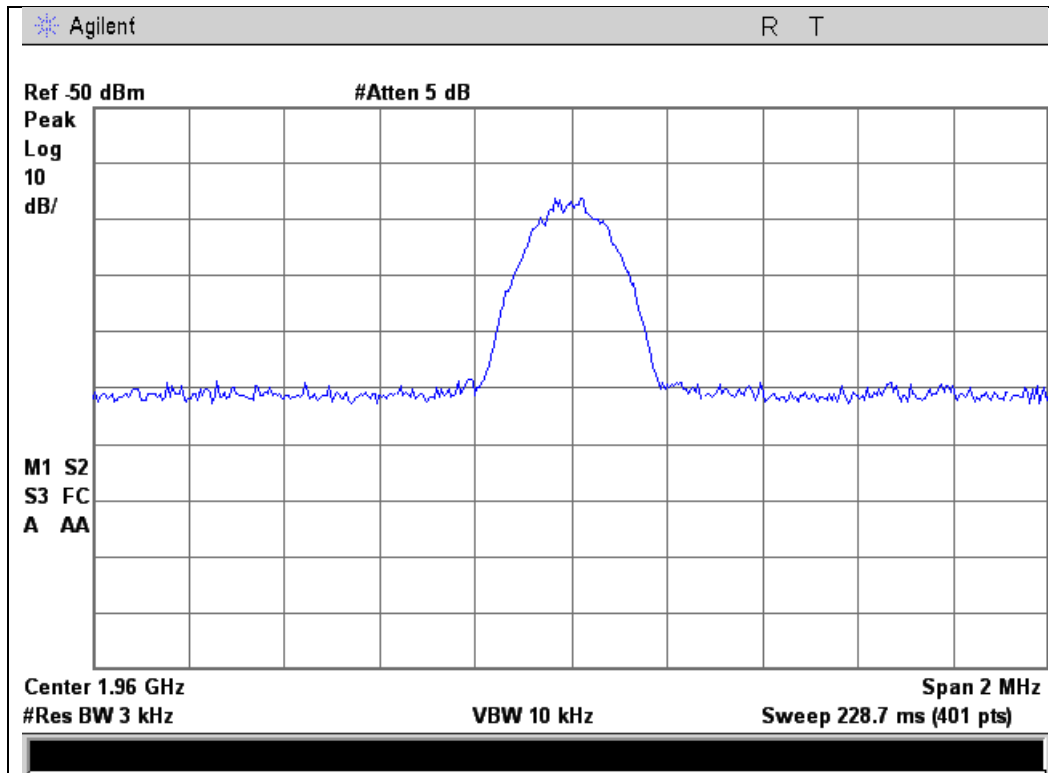

Output

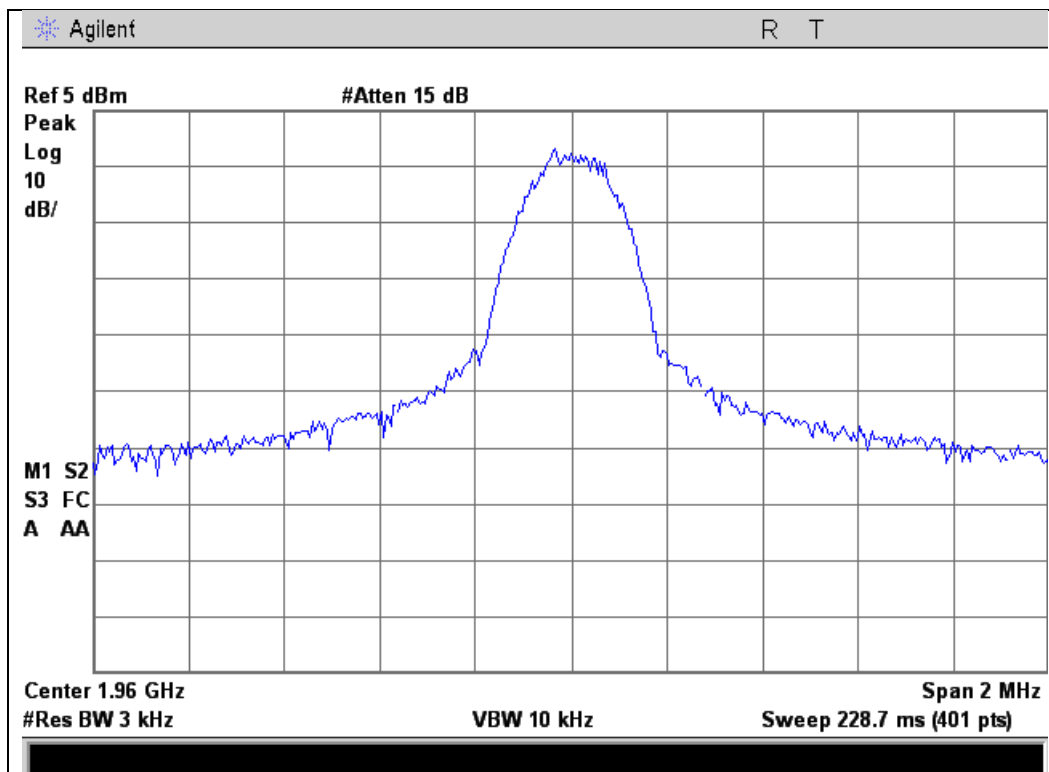



CDMA Uplink Test Plots

824 - 849 MHz Band

Input

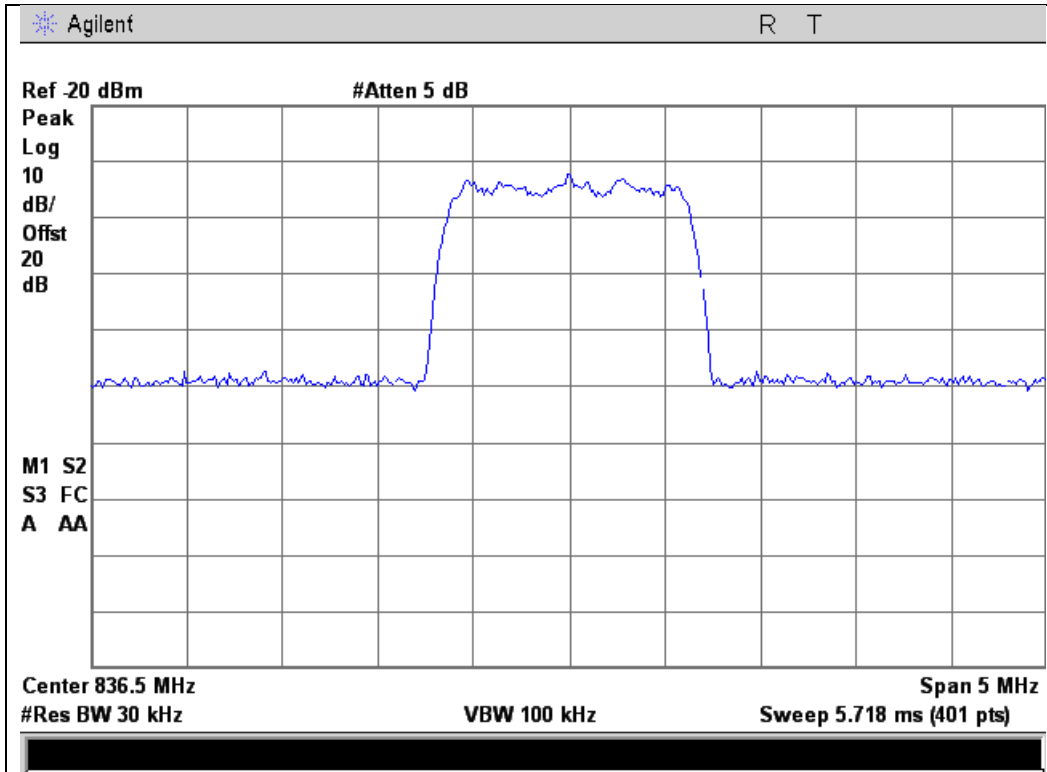

Output

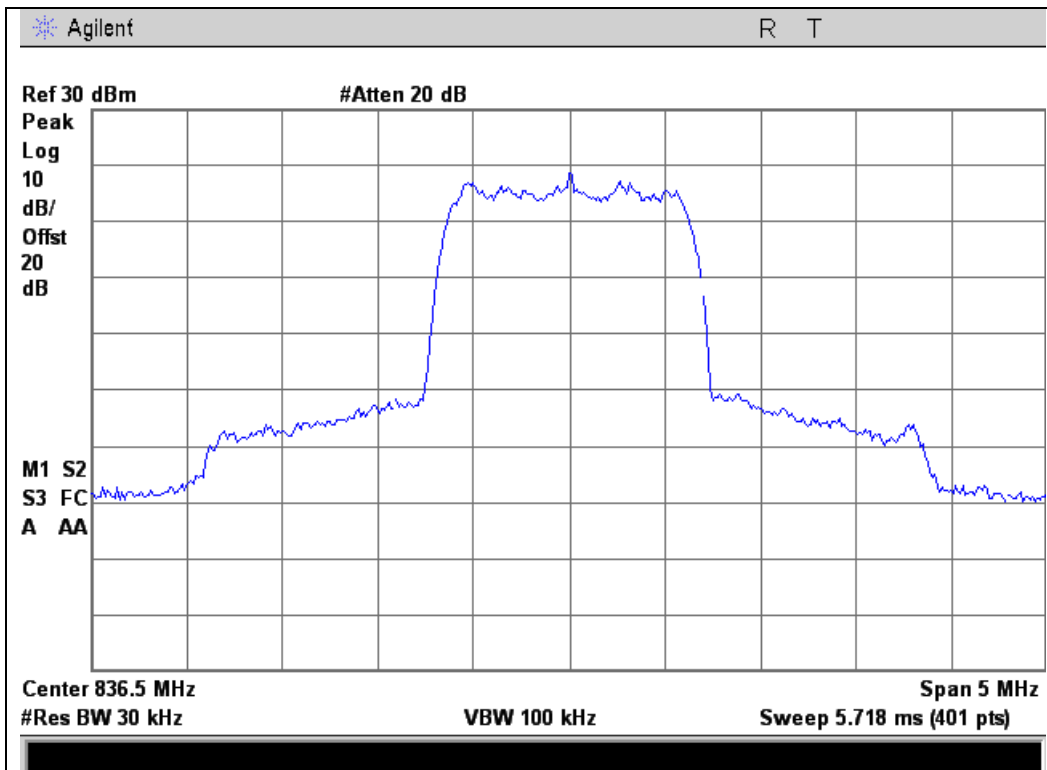



1850 - 1910 MHz Band

Input

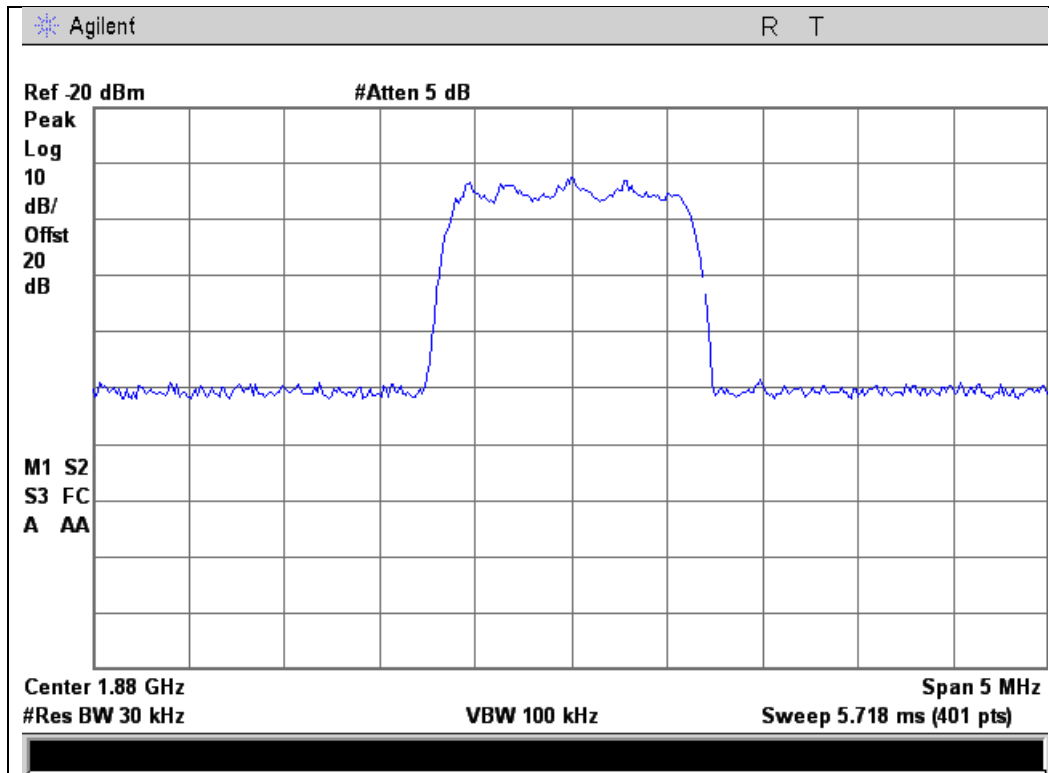

Output

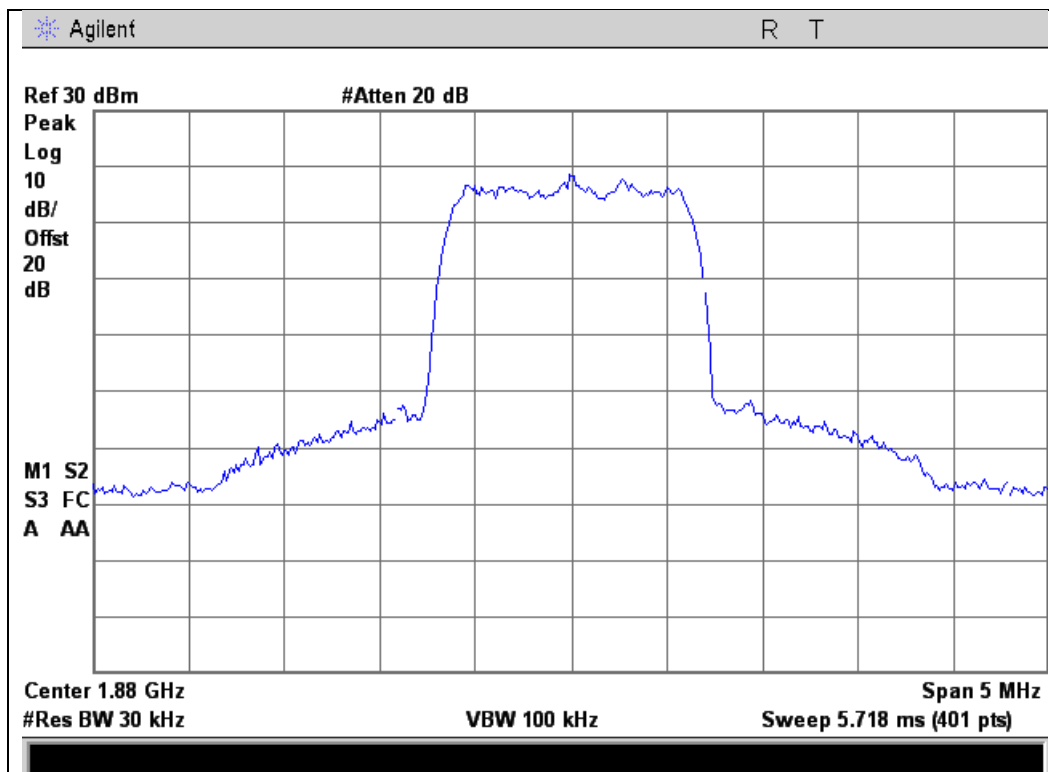



CDMA Downlink Test Plots

869 - 894 MHz Band

Input

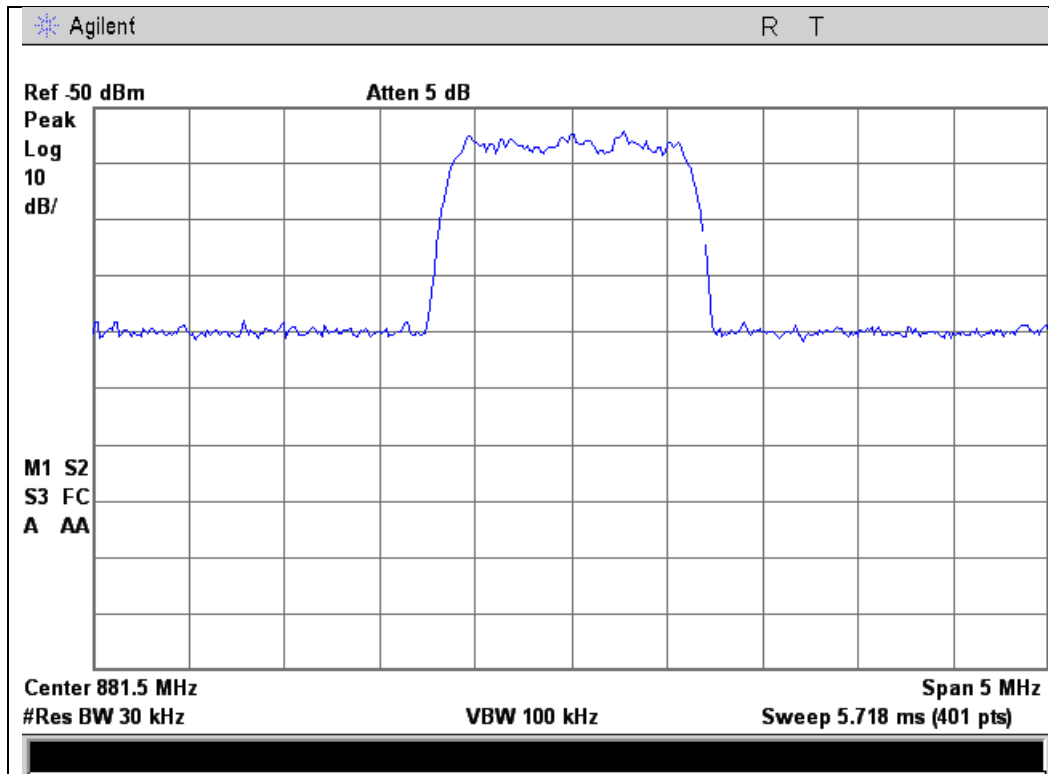

Output

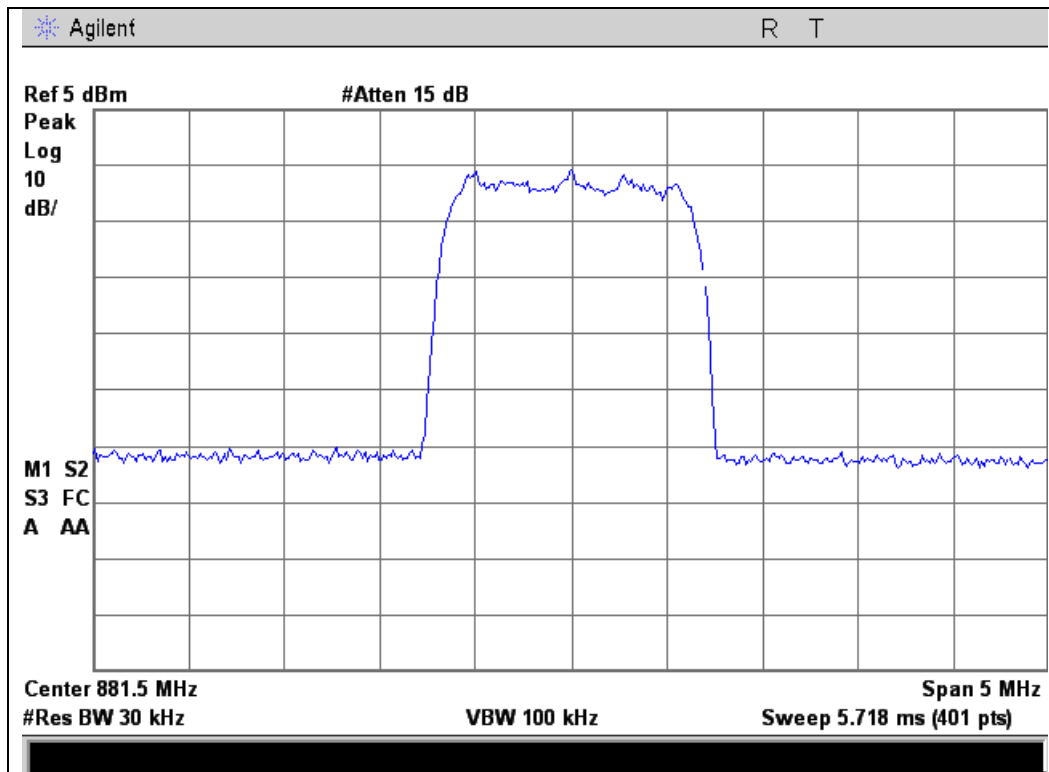



1930 - 1990 MHz Band

Input

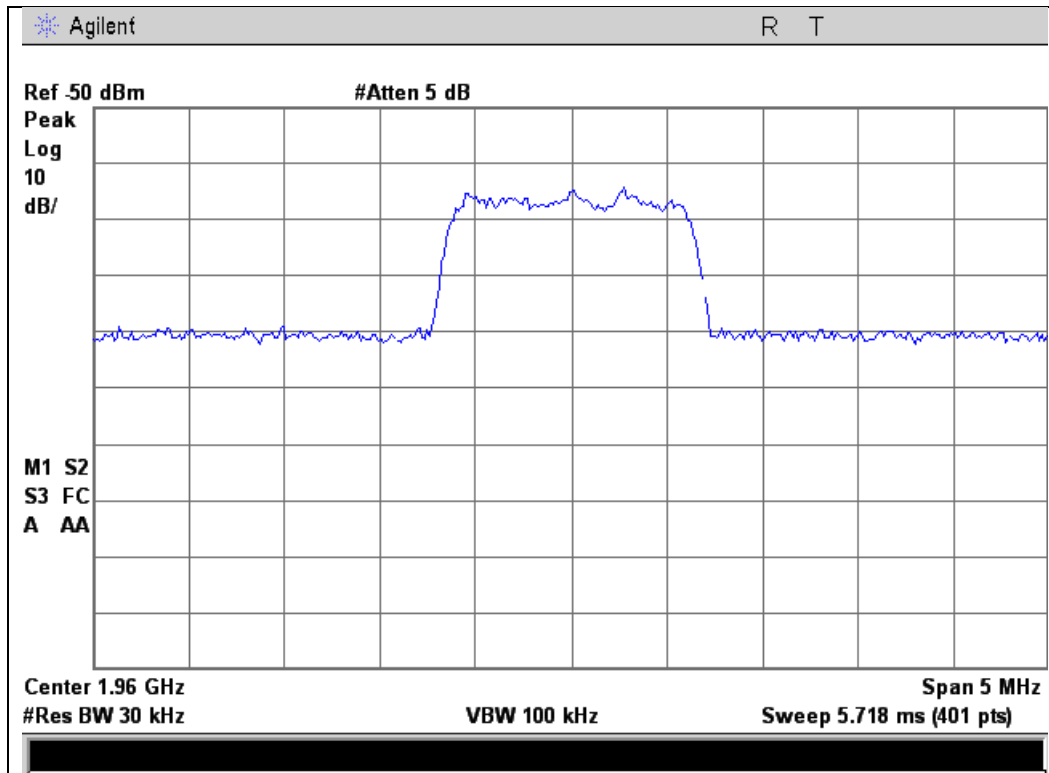

Output

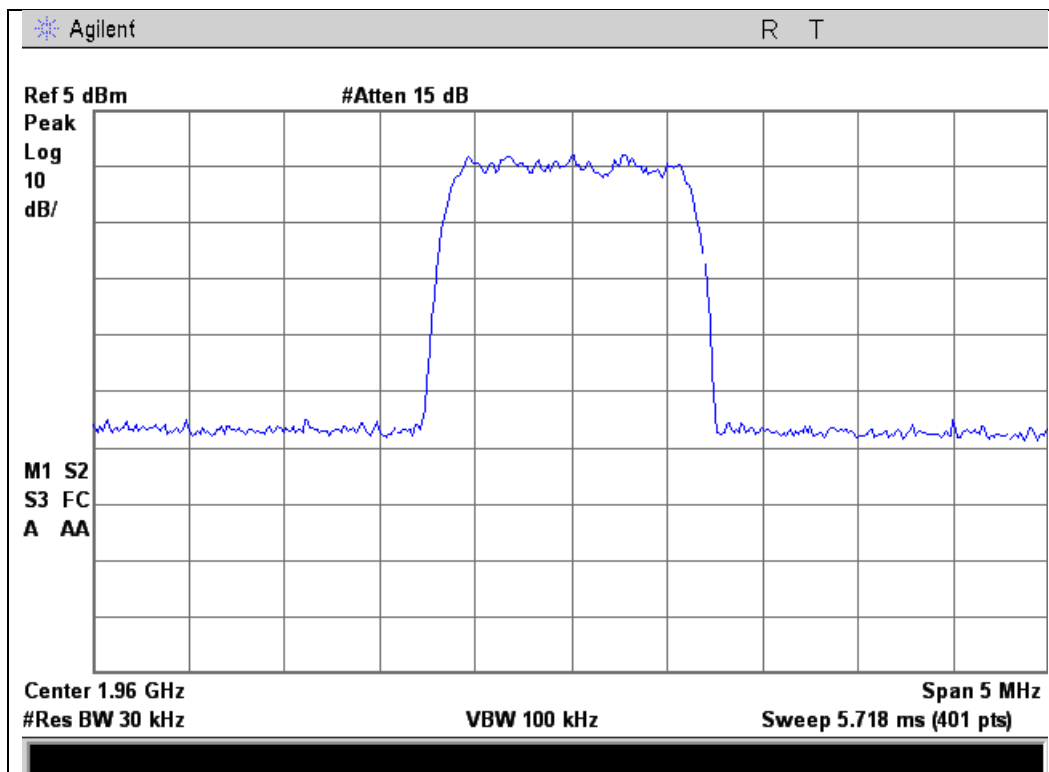



WCDMA Uplink Test Plots

824 - 849 MHz Band

Input

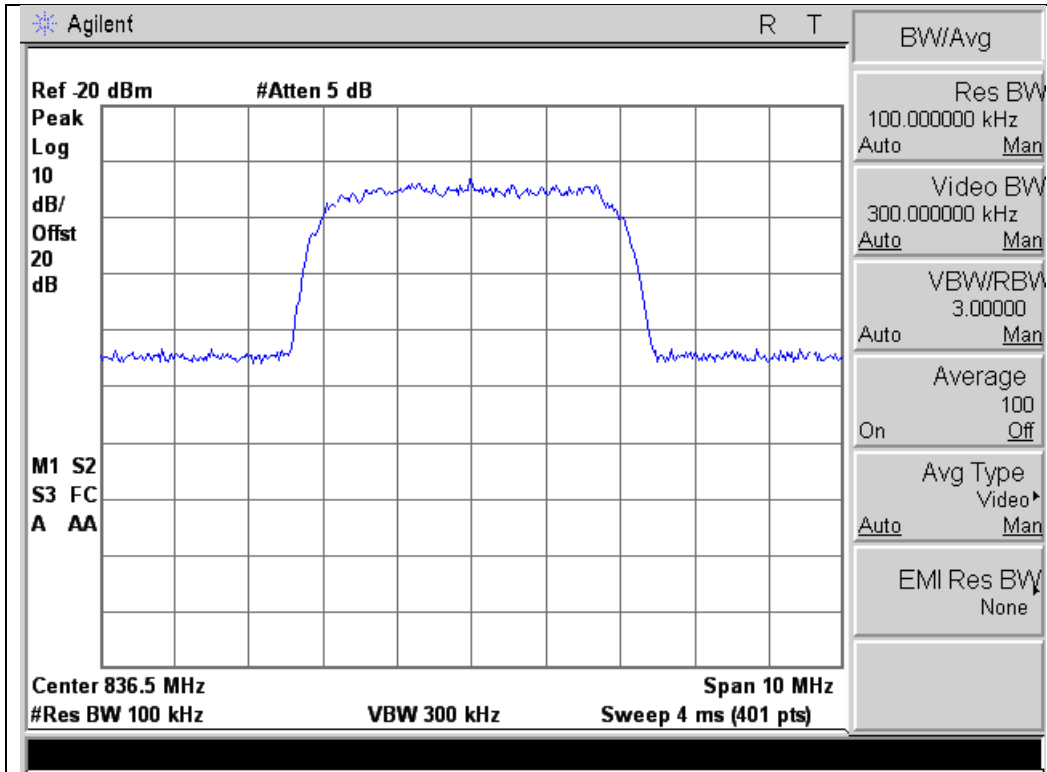

Output

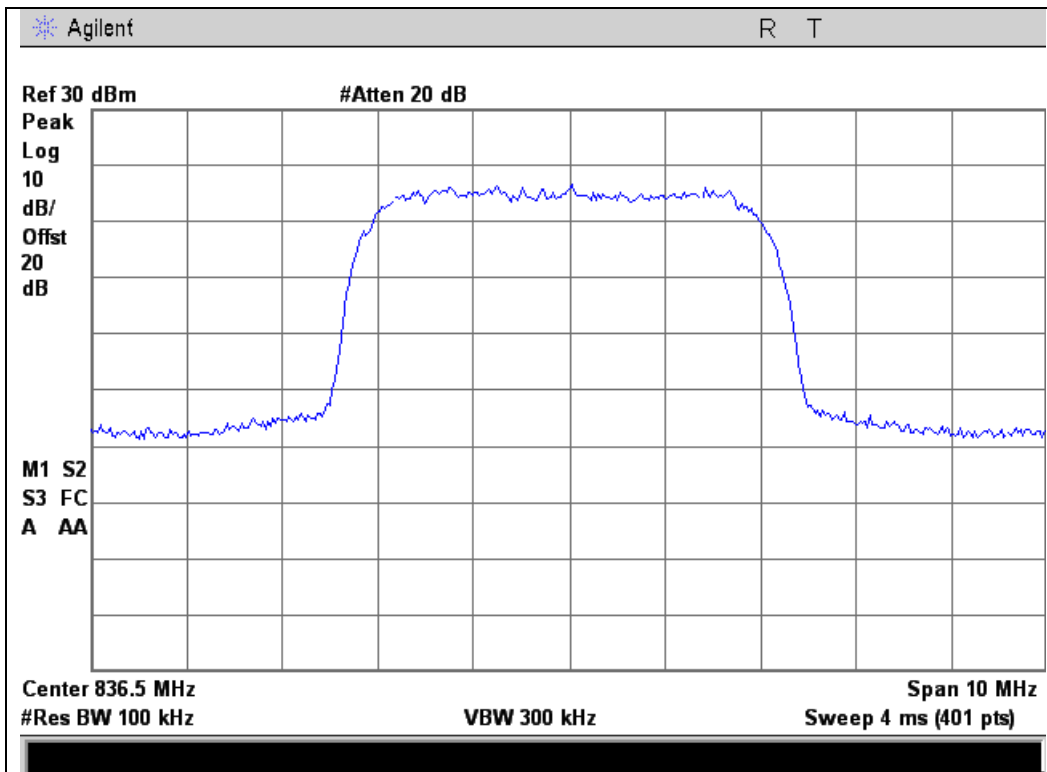



1850 - 1910 MHz Band

Input

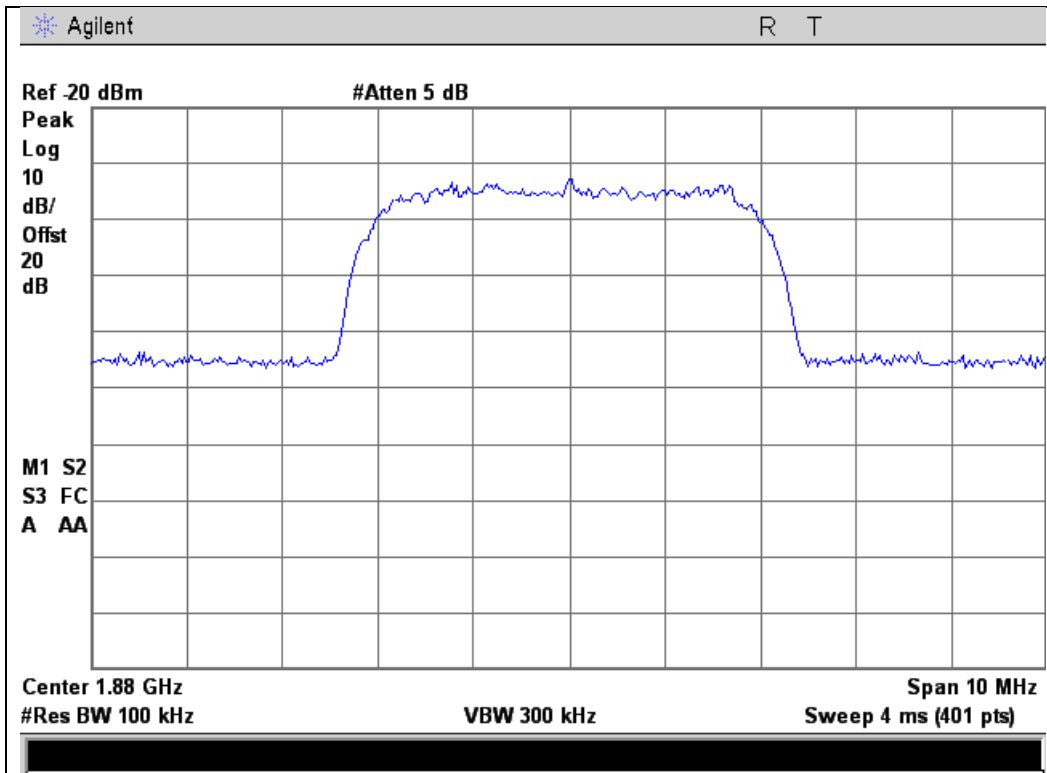

Output

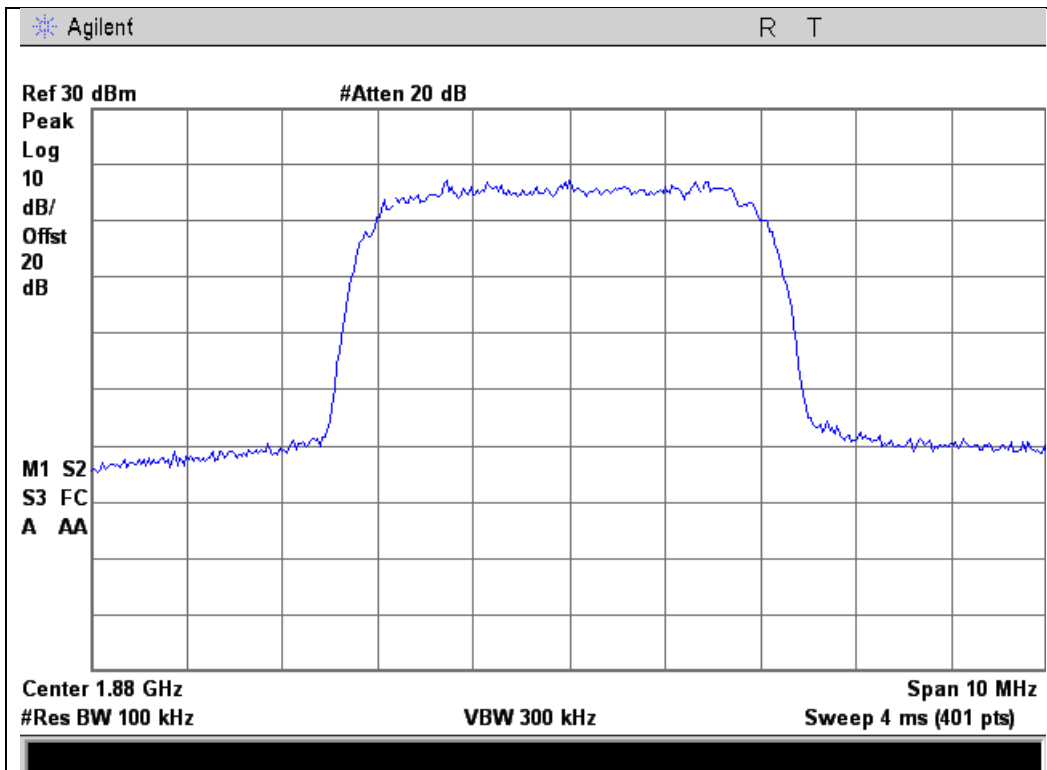



WCDMA Downlink Test Plots

869 - 894 MHz Band

Input

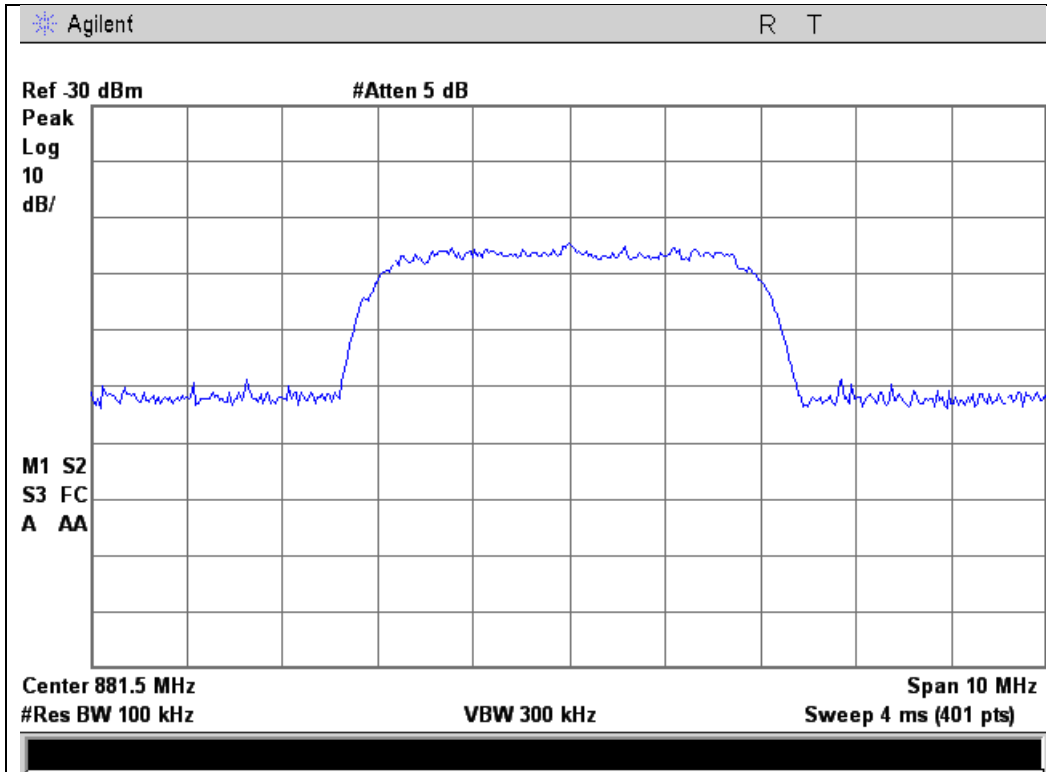

Output

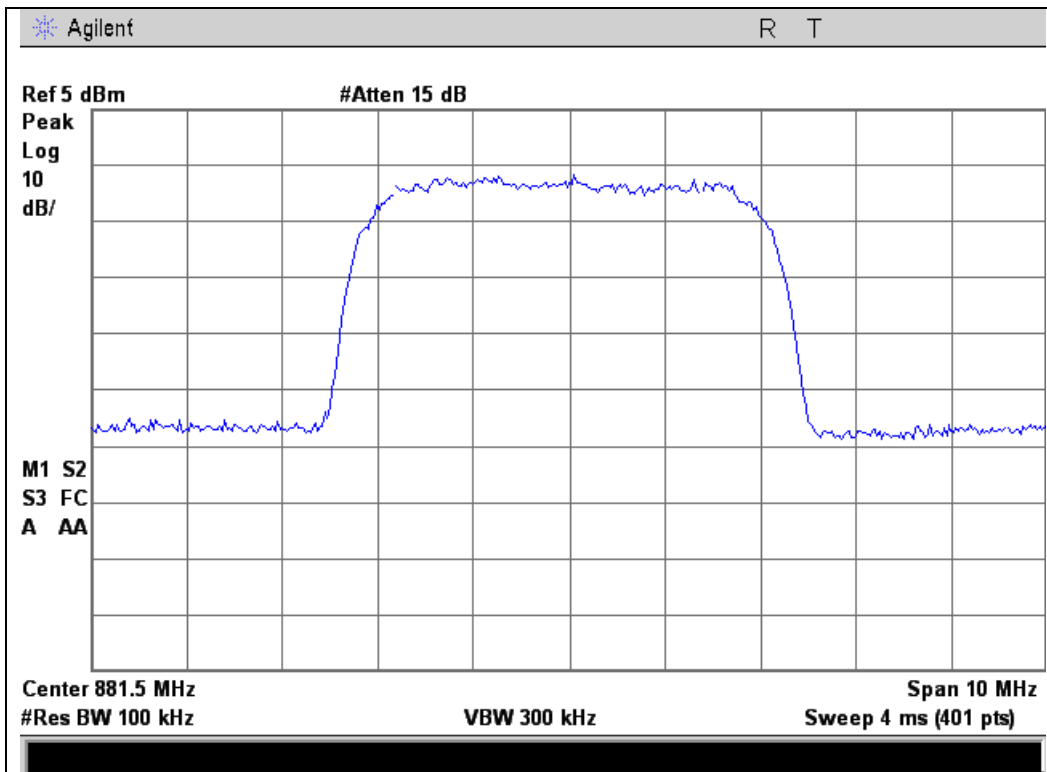



1930 - 1990 MHz Band

Input

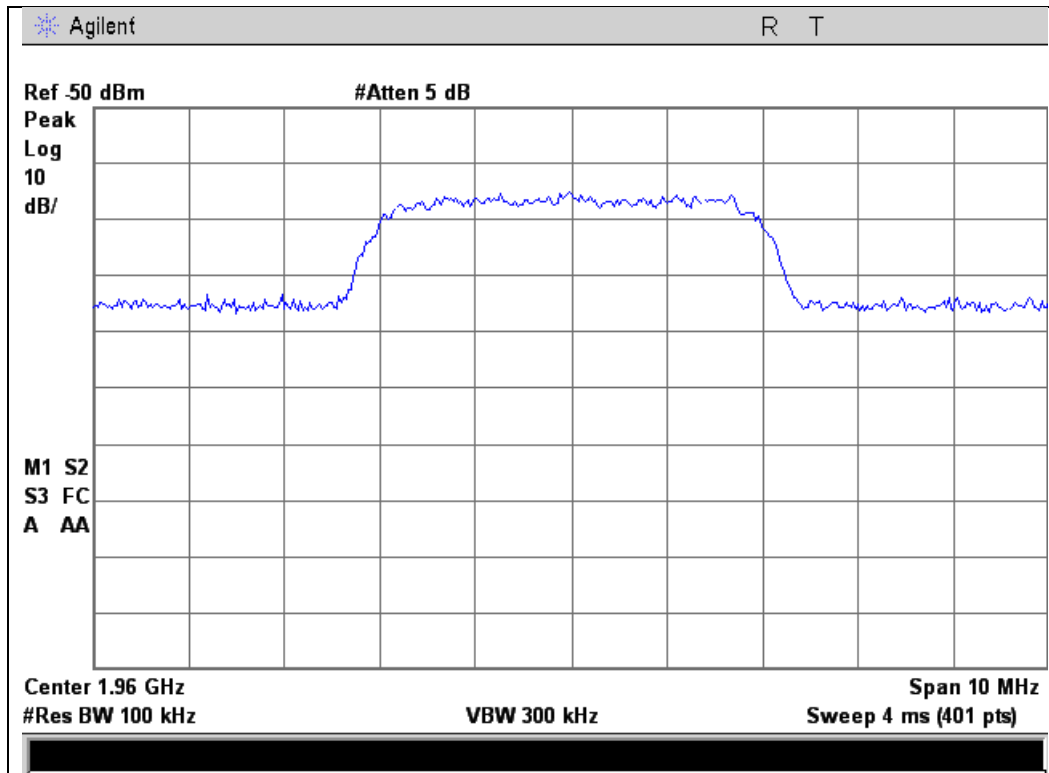

Output

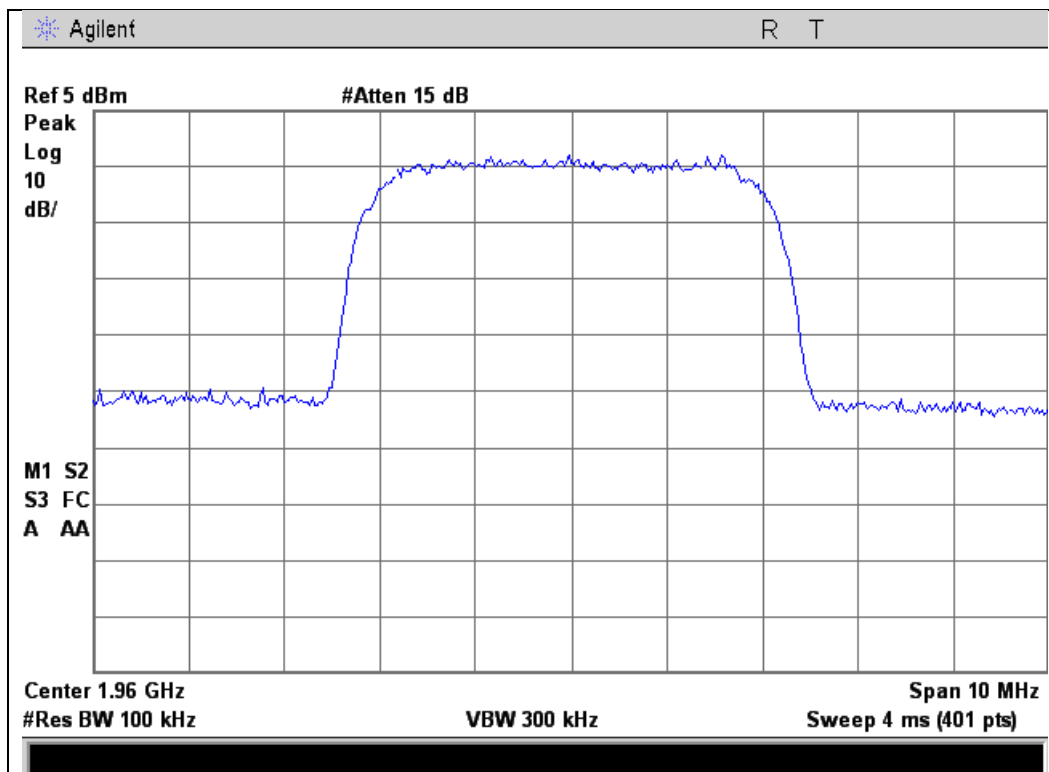



Oscillation Detection

Name of Test: Oscillation Detection
Test Equipment Utilized: i00331, i00405, i00412

Engineer: Mike Graffeo
Test Date: 9/20/13

Test Procedure

The EUT was connected to a spectrum analyzer set for 0 Hz operation. The EUT uplink and downlink were fed back upon each other through a selectable band pass filter and variable attenuator. The EUT uplink and downlink were tested to ensure that the presence of oscillation was detected and that the EUT output turned off within 300 mS for the Uplink and 1 second for the Downlink and remained off for 1 minute. A EUT with test software was utilized to ensure that the EUT only had a maximum of 5 attempts at restart from oscillation before permanently shutting off.

Test Setup

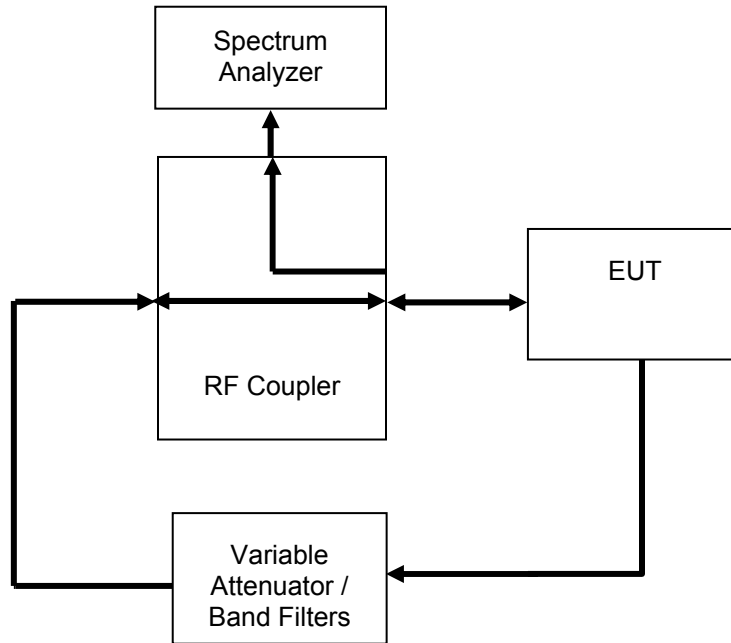

Uplink Detection Time Test Results

Frequency Band (MHz)	Measured Time (mS)	Limit (mS)	Result
824 - 849	22.5	300	Pass
1850 - 1910	22.0	300	Pass

Downlink Detection Time Test Results

Frequency Band (MHz)	Measured Time (mS)	Limit (S)	Result
869 - 894	34.5	1	Pass
1930 - 1990	36.8	1	Pass



Uplink Restart Time Test Results

Frequency Band (MHz)	Measured Time (S)	Limit (S)	Result
824 - 849	64.3	≥60	Pass
1850 - 1910	64.8	≥60	Pass

Downlink Restart Time Test Results

Frequency Band (MHz)	Measured Time (mS)	Limit (mS)	Result
869 - 894	64.8	≥60	Pass
1930 - 1990	64.8	≥60	Pass

Uplink Restart Count Test Results

Frequency Band (MHz)	Restarts	Limit	Result
824 - 849	4	≤5	Pass
1850 - 1910	4	≤5	Pass

Downlink Restart Count Test Results

Frequency Band (MHz)	Restarts	Limit	Result
869 - 894	5	≤5	Pass
1930 - 1990	5	≤5	Pass



Uplink Detection Time Test Results

824 - 849 MHz Band

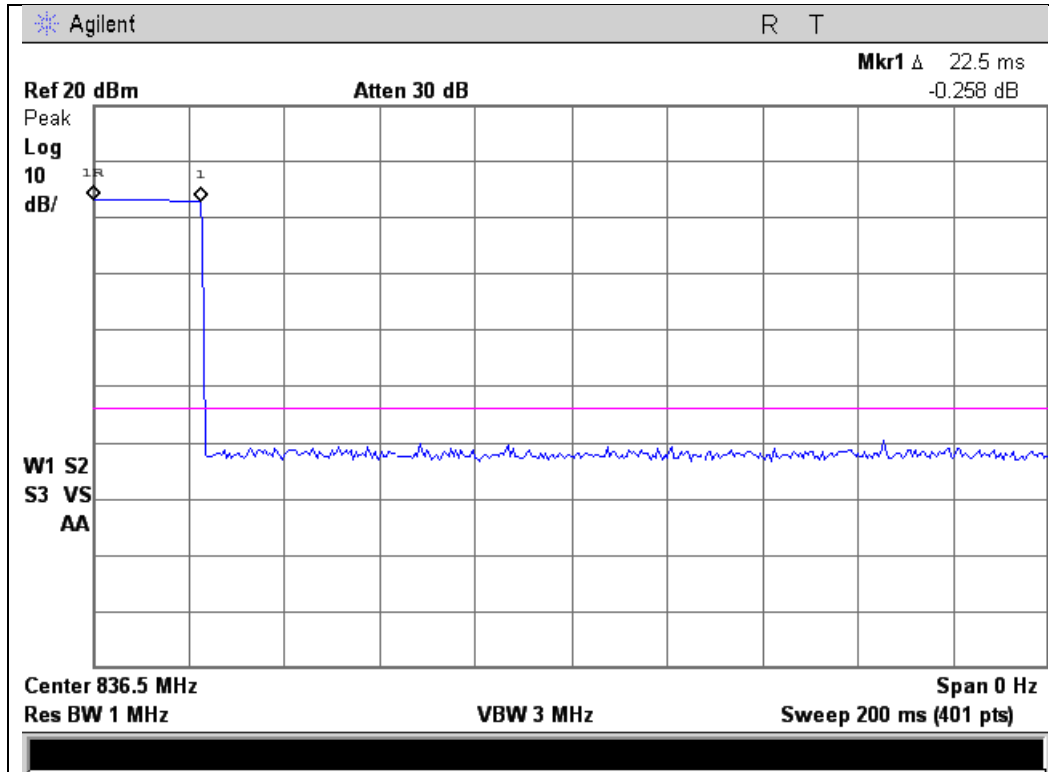

1850 - 1910 MHz Band

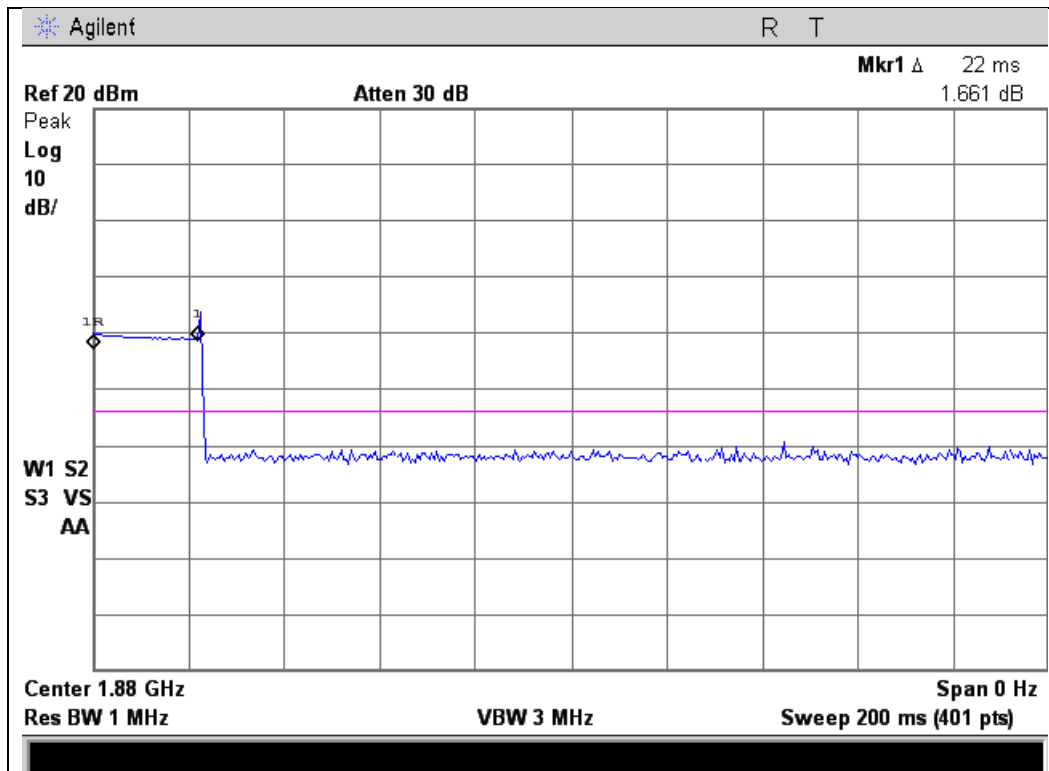



Uplink Restart Time Test Results

824 - 849 MHz Band

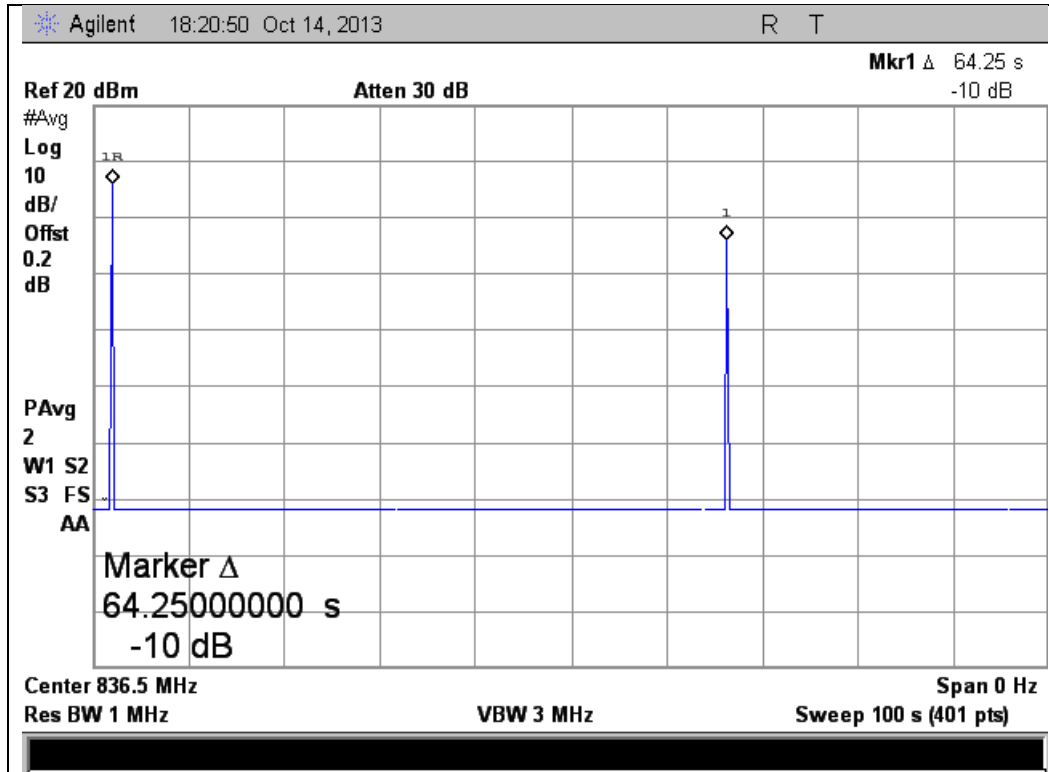

1850 - 1910 MHz Band

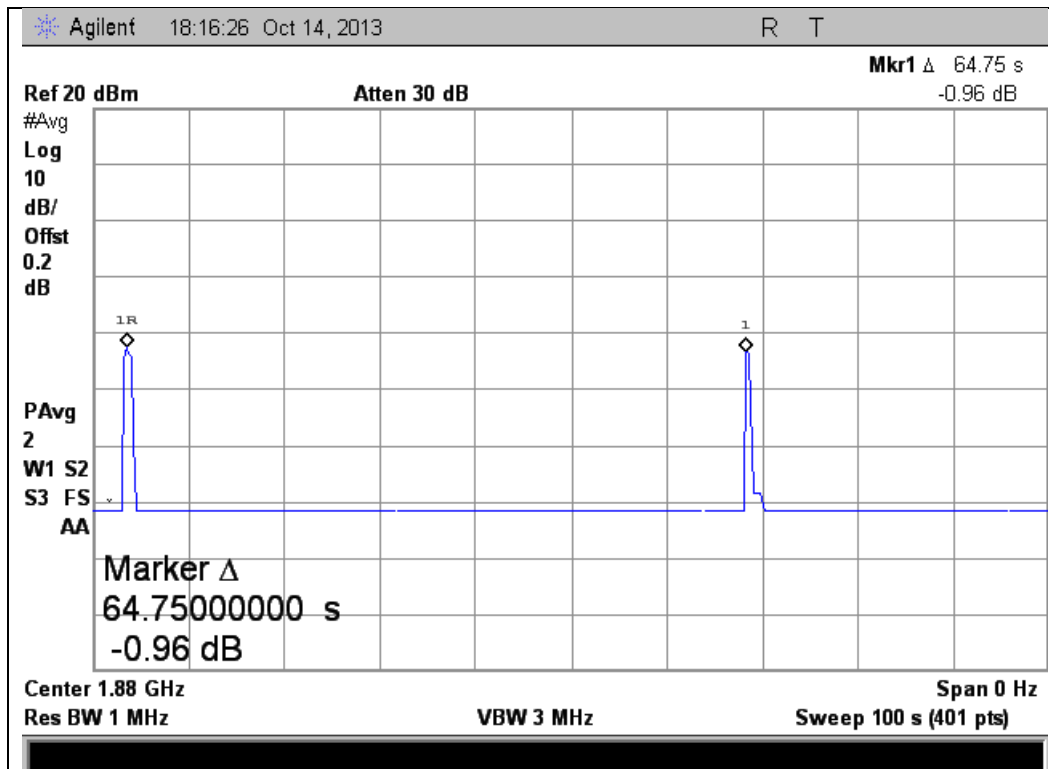



Uplink Restart Count Test Results

824 - 849 MHz Band

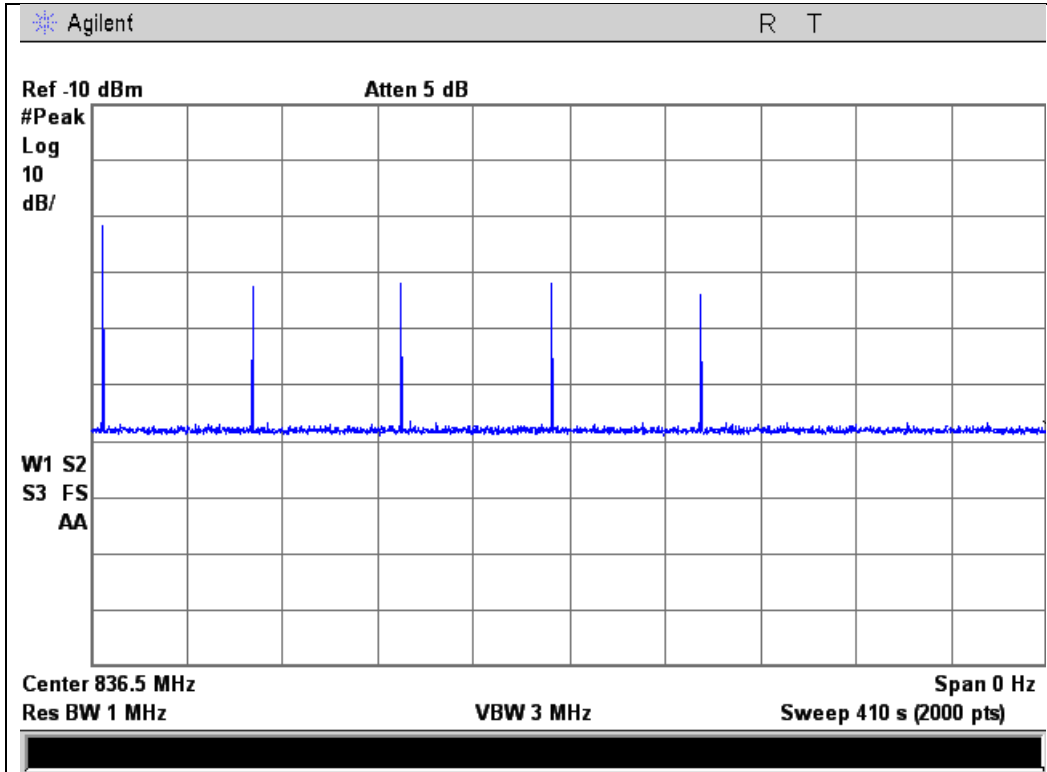

1850 - 1910 MHz Band

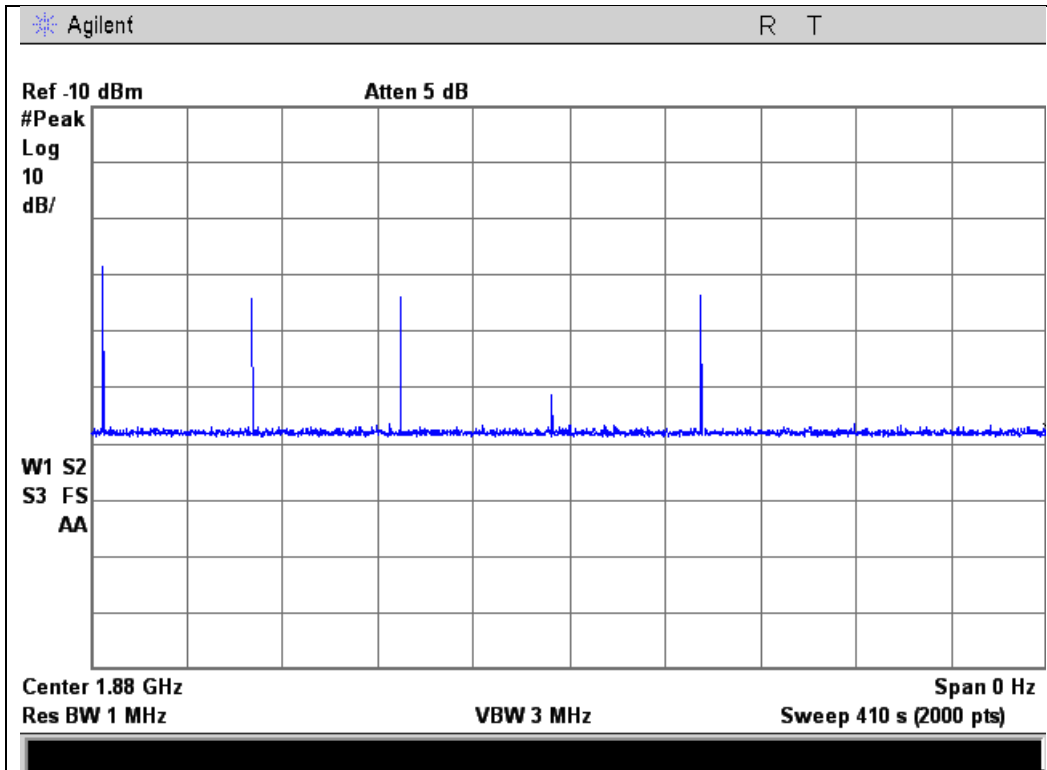



Downlink Detection Time Test Results

869 - 894 MHz Band

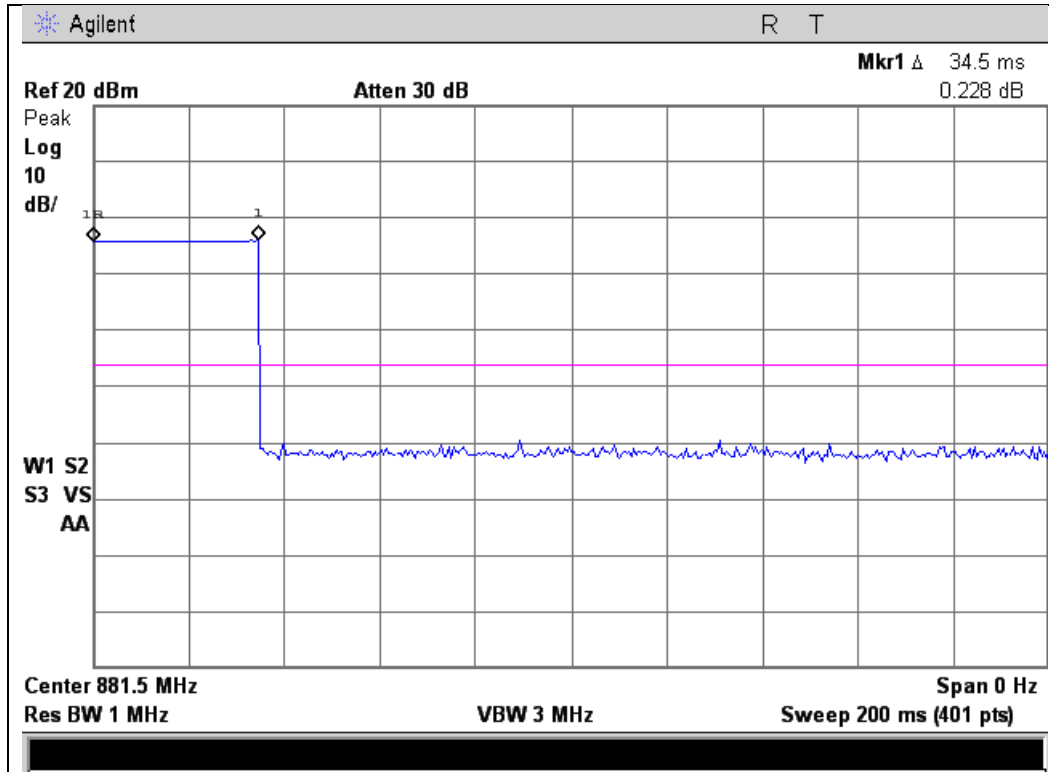

1930 - 1990 MHz Band

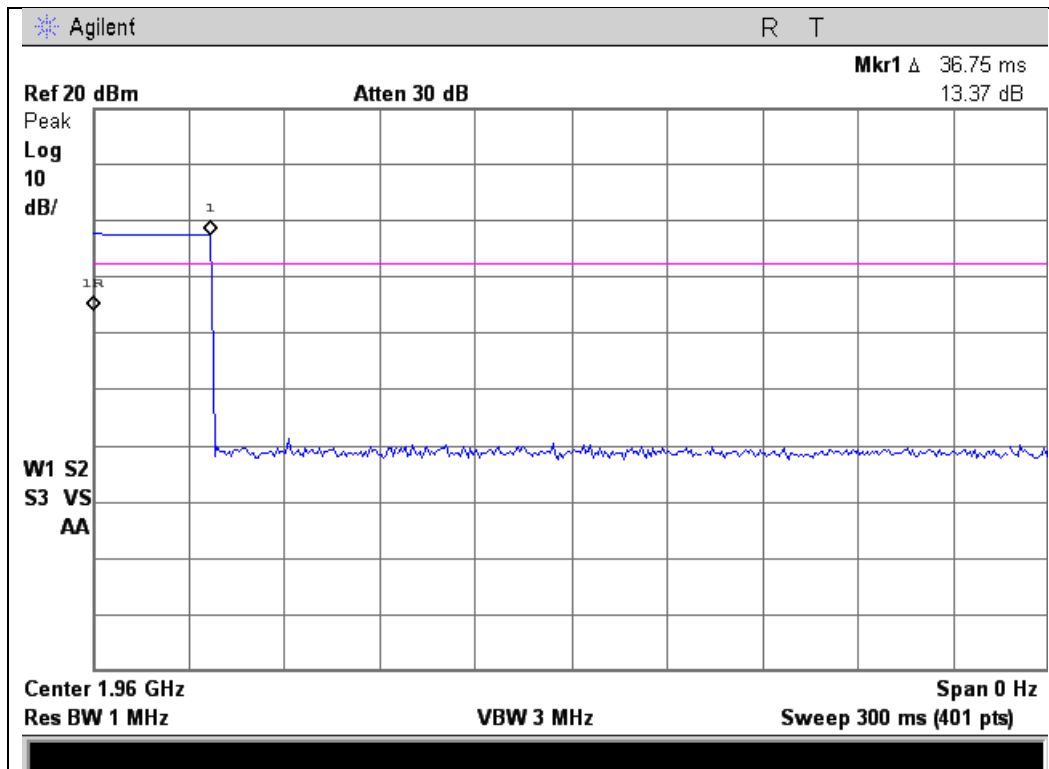



Downlink Restart Time Test Results

869 - 894 MHz Band

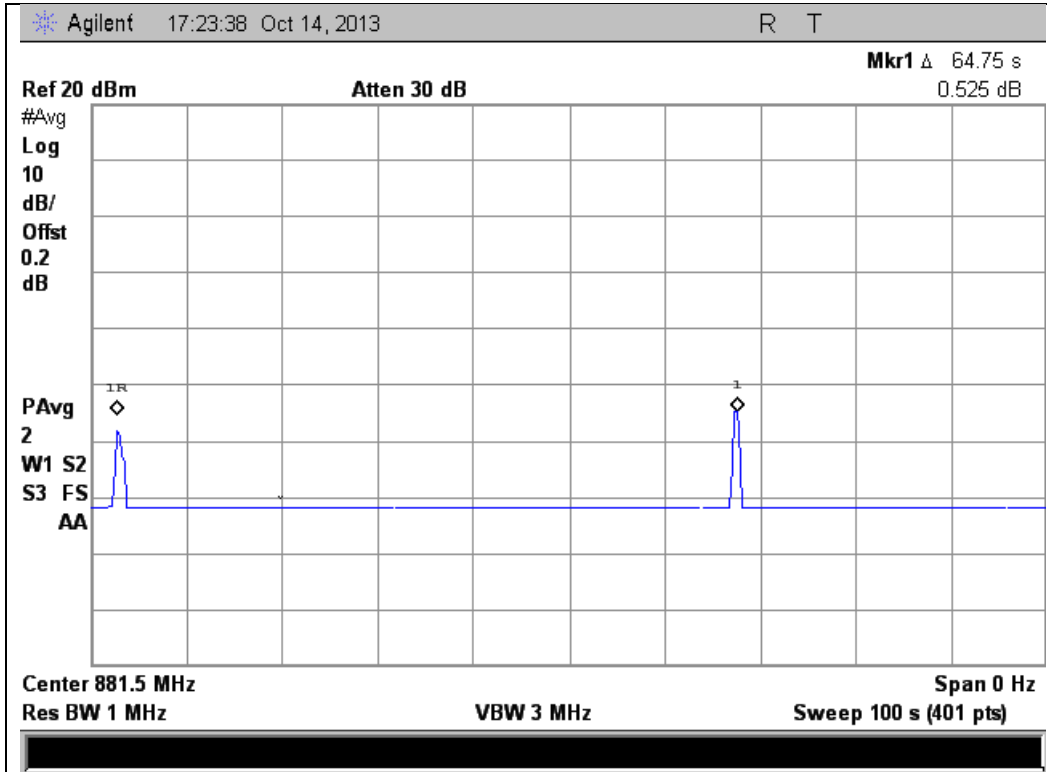

1930 - 1990 MHz Band

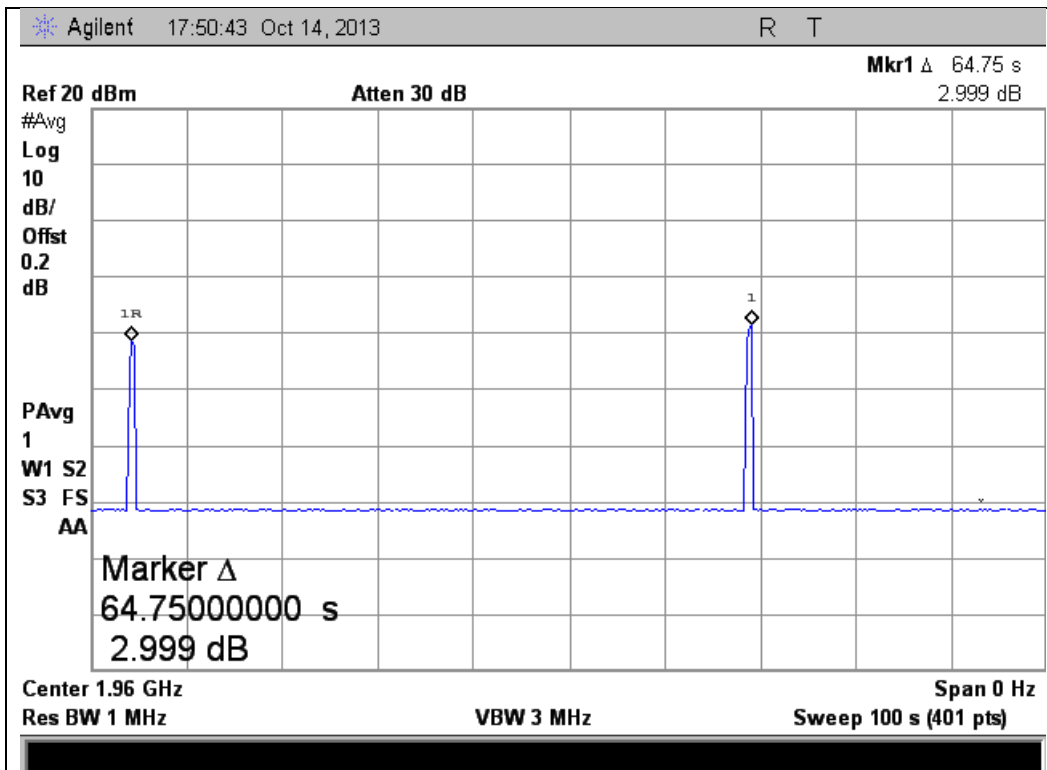



Downlink Restart Count Test Results

869 - 894 MHz Band

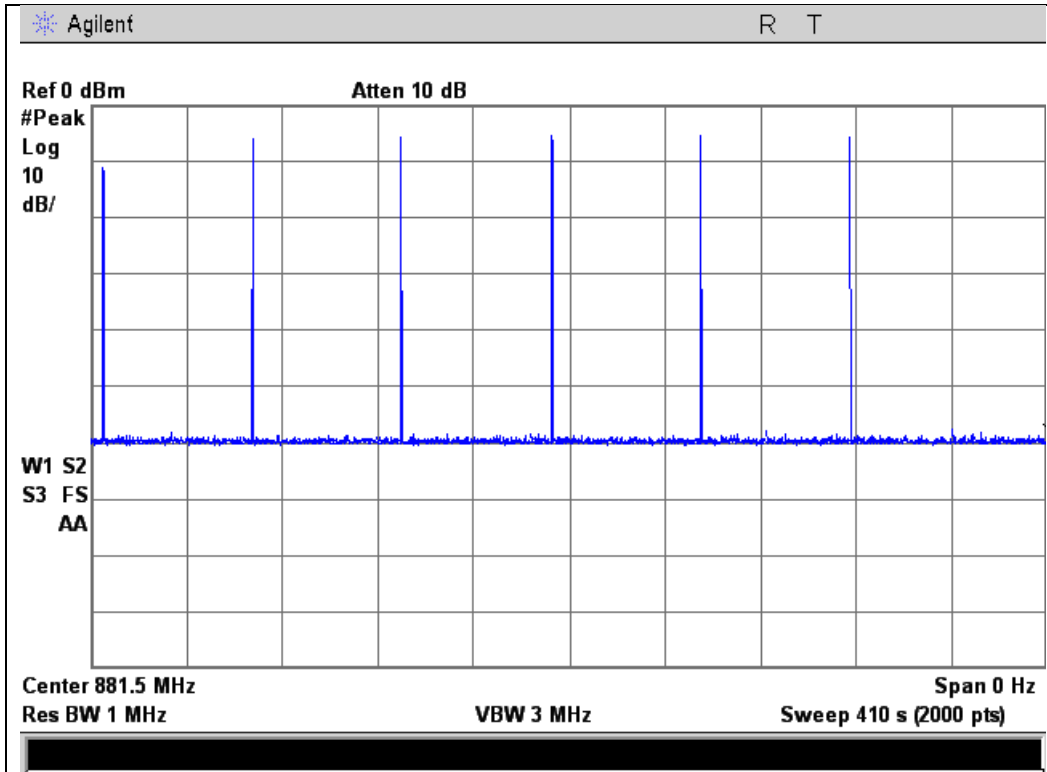

1930 - 1990 MHz Band

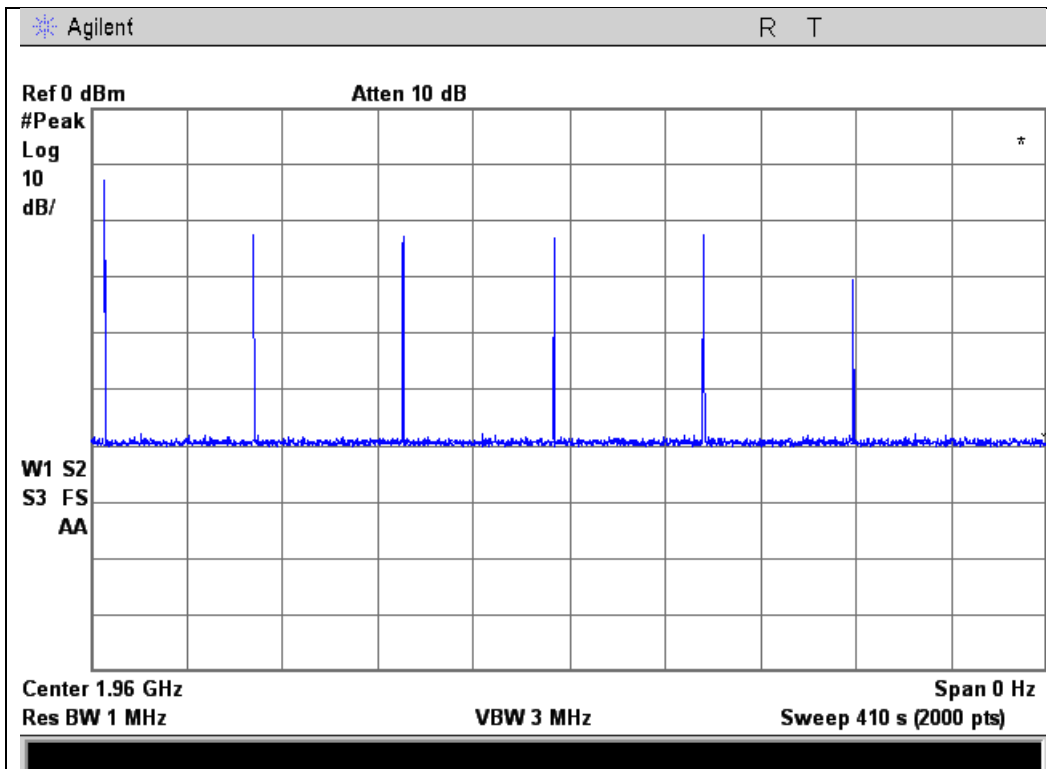



Radiated Spurious

Name of Test: Radiated Spurious **Engineer:** Mike Graffeo
Test Equipment Utilized: i00405, i00334, i00271, i00331 **Test Date:** 10/1/13

Test Procedure

The EUT was tested in an Open Area Test Site (OATS) set 3m from the receiving antenna. A spectrum analyzer was used to verify that the EUT met the requirements for Radiated Emissions. The EUT was tested by rotating it 360 degrees with the antennas in both the vertical and horizontal orientation while raised from 1 to 4 meters to ensure the signal levels were maximized. All cable and antenna correction factors were input into the spectrum analyzer ensuring an accurate measurement in ERP/EIRP with the resultant power in dBm. A signal generator was used to provide a CW signal centered in each operational uplink and downlink band. The EUT output was terminated into a 50 Ohm non-radiating load.

The following formulas are used for calculating the limits.

Radiated Spurious Emissions Limit = $43 + 10\log(P)$ dB

Test Setup

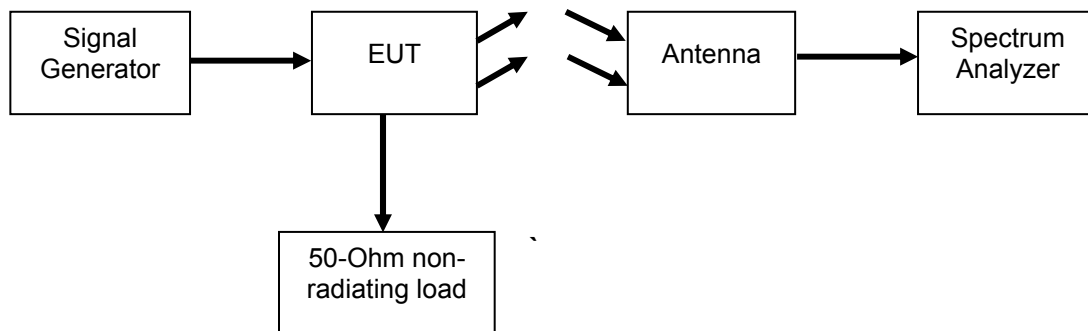



Uplink Test Results

824 - 849 MHz Band 836.5 MHz Tuned Frequency

Measured Frequency (MHz)	Measured Level (dBm)	Limit (dBm)	Result
1673	-68.76	-13	Pass
2509.5	-63.18	-13	Pass
3346	-49.80	-13	Pass

1850 - 1910 MHz Band 1880 MHz Tuned Frequency

Measured Frequency (MHz)	Measured Level (dBm)	Limit (dBm)	Result
3760	-52.62	-13	Pass
5640	-46.87	-13	Pass
7520	-39.61	-13	Pass

Downlink Test Results

869 - 894 MHz Band 881.5 MHz Tuned Frequency

Measured Frequency (MHz)	Measured Level (dBm)	Limit (dBm)	Result
1763	-72.40	-13	Pass
2644.5	-65.14	-13	Pass
3526	-50.29	-13	Pass

1930 - 1990 MHz Band 1960 MHz Tuned Frequency

Measured Frequency (MHz)	Measured Level (dBm)	Limit (dBm)	Result
3920	-47.37	-13	Pass
5880	-46.04	-13	Pass
7840	-39.22	-13	Pass

No other emissions were detected. All emissions were lower than -13 dBm.
All emissions were system noise floor.



Test Equipment Utilized

Description	Manufacturer	Model Number	CT Asset #	Last Cal Date	Cal Due Date
Horn Antenna	EMCO	3115	i00103	12/11/12	12/11/14
Humidity / Temp Meter	Newport	IBTHX-W-5	i00282	12/4/12	12/4/13
Voltmeter	Fluke	75III	i00320	2/1/13	2/1/14
Spectrum Analyzer	Agilent	E4407B	i00331	4/23/13	4/23/14
Non-radiating load	Termaline	8201	i00334	Verified on:8/2/13	
Power Supply (for EUT)	HP	6654A	i00350	Verified on:9/15/13	
Vector Signal Generator	Agilent	E4438C	i00348	1/4/13	1/4/14
EMI Analyzer	Agilent	E7405A	i00379	11/21/12	11/21/13
Signal Generator	Rohde & Schwarz	SMU200A	i00405	10/26/12	10/26/13
RF Directional Coupler	Meca	CS06-1.500V	i00412	Verified on: 8/1/13	

In addition to the above listed equipment standard RF connectors and cables were utilized in the testing of the described equipment. Prior to testing these components were tested to verify proper operation.

END OF TEST REPORT