



849 NW STATE ROAD 45  
NEWBERRY, FL 32669 USA  
PH: 888.472.2424 OR 352.472.5500  
FAX: 352.472.2030  
EMAIL: [TEI@TIMCOENGR.COM](mailto:TEI@TIMCOENGR.COM)  
[HTTP://WWW.TIMCOENGR.COM](http://WWW.TIMCOENGR.COM)

## FCC PART 22H AND PART 24E TEST REPORT

Applicant	Wilson Electronics, Inc.
Address	3301 E. Deseret Drive St. George, Utah 84790 USA
FCC ID	PWO271201SA
IC Label	IC: 4627A-271201SA
Model Number	271201
Product Description	Wireless Dual-Band Cellular/PCS Amplifier
Date Sample Received	August 7, 2008
Date Tested	August 28, 2008
Tested By	Nam Nguyen
Approved By	Mario de Aranzeta
Report No.	886XAUT8TestReport.pdf
Test Results	<input checked="" type="checkbox"/> PASS <input type="checkbox"/> FAIL

THE ATTACHED REPORT SHALL NOT BE REPRODUCED EXCEPT IN FULL  
WITHOUT THE WRITTEN APPROVAL OF TIMCO ENGINEERING, INC.



Certificate # 0955-01



**TABLE OF CONTENTS**

ATTESTATION STATEMENT ..... 4

REPORT SUMMARY ..... 5

TEST ENVIRONMENT ..... 5

TEST SETUP ..... 5

DEVICE UNDER TEST INFORMATION ..... 6

EQUIPMENT LIST ..... 7

TEST PROCEDURE ..... 8

RF POWER OUTPUT ..... 11

    Test Data Table 1 – Output Power – CDMA 1900 – Uplink/Downlink ..... 11

    Test Data Table 2 – Output Power – EDGE 1900 – Uplink/Downlink ..... 11

    Test Data Table 3 – Output Power – GSM 1900 – Uplink/Downlink ..... 11

    Test Data Table 5 – Output Power – CDMA 800 – Uplink/Downlink ..... 12

    Test Data Table 6 – Output Power – EDGE 800 – Uplink/Downlink ..... 12

    Test Data Table 7 – Output Power – GSM 800 – Uplink/Downlink ..... 12

    Test Data Table 8 – Output Power – AMPS 800 – Uplink/Downlink..... 12

INPUT/OUTPUT MODULATED AMPLITUDE COMPARISON AND BAND-EDGES COMPLIANCE ..... 13

    Test Data Table 10 – CDMA 1900 – Uplink/Downlink ..... 14

        Figure 1: CDMA – In vs. Out 1851.25MHz..... 14

        Figure 2: CDMA – In vs. Out 1908.75MHz..... 15

        Figure 3: CDMA – In vs. Out 1931.25MHz..... 16

        Figure 4: CDMA – In vs. Out 1988.75MHz..... 17

    Test Data Table 11 – EDGE 1900 – Uplink/Downlink ..... 18

        Figure 5: EDGE – In vs. Out 1850.20MHz ..... 18

        Figure 6: EDGE – In vs. Out 1909.80MHz ..... 19

        Figure 7: EDGE – In vs. Out 1930.20MHz ..... 20

        Figure 8: EDGE – In vs. Out 1989.80MHz ..... 21

    Test Data Table 12 –GSM 1900 – Uplink/Downlink ..... 22

        Figure 9: GSM – In vs. Out 1850.20MHz ..... 22

        Figure 10: GSM – In vs. Out 1909.80MHz ..... 23

        Figure 11: GSM – In vs. Out 1930.20MHz ..... 24

        Figure 12: GSM – In vs. Out 1989.80MHz ..... 25

    Test Data Table 13 – CDMA 800 – Uplink/Downlink..... 26

        Figure 13: CDMA – In vs. Out 825.25MHz..... 26

        Figure 14: CDMA – In vs. Out 847.75 MHz..... 27

        Figure 15: CDMA – In vs. Out 870.25 MHz..... 28

        Figure 16: CDMA – In vs. Out 892.75 MHz..... 29

    Test Data Table 14 – EDGE 800 – Uplink/Downlink ..... 30

        Figure 17: EDGE – In vs. Out 824.20 MHz ..... 30

        Figure 18: EDGE – In vs. Out 848.80 MHz ..... 31

        Figure 19: EDGE – In vs. Out 869.20 MHz ..... 32

        Figure 20: EDGE – In vs. Out 893.80 MHz ..... 33

Test Data Table 15 – GSM 800 – Uplink/Downlink.....	34
Figure 21: GSM – In vs. Out 824.2 MHz .....	34
Figure 22: GSM – In vs. Out 848.8 MHz .....	35
Figure 23: GSM – In vs. Out 869.2MHz .....	36
Figure 24: GSM – In vs. Out 893.8MHz .....	37
Test Data Table 16 – AMPS 800 – Uplink/Downlink.....	38
Figure 25: AMPS – In vs. Out 824.20 MHz.....	38
Figure 26: AMPS – In vs. Out 848.80 MHz.....	39
Figure 27: AMPS – In vs. Out 869.20 MHz.....	40
Figure 28: AMPS – In vs. Out 893.80 MHz.....	41
<b>INTERMODULATION PRODUCT SPURIOUS EMISSIONS.....</b>	<b>42</b>
Figure 29: CDMA 3 tones intermodulation - (1850 – 1910) MHz. ....	43
Figure 30: CDMA 3 tones intermodulation - (1930 – 1990) MHz. ....	44
Figure 31: CDMA 3 tones intermodulation - (824 – 849) MHz. ....	45
Figure 32: CDMA 3 tones intermodulation - (869 – 894) MHz. ....	46
Figure 33: GSM 3 tones intermodulation - (1850 – 1910) MHz.....	47
Figure 34: GSM 3 tones intermodulation - (1930 – 1990) MHz.....	48
Figure 35: GSM 3 tones intermodulation - (824 – 849) MHz.....	49
Figure 36: GSM 3 tones intermodulation - (869 – 894) MHz.....	50
<b>SPURIOUS EMISSIONS AT ANTENNA TERMINALS.....</b>	<b>51</b>
Test Data Table 17 – Conducted Emissions – CDMA 1900 – Uplink.....	51
Test Data Table 18 – Conducted Emissions – CDMA 1900 – Downlink.....	51
Test Data Table 19 – Conducted Emissions – GSM 1900 - Uplink .....	52
Test Data Table 20 – Conducted Emissions – GSM 1900 - Downlink .....	52
Test Data Table 21 – Conducted Emissions – CDMA 800 - Uplink.....	52
Test Data Table 22 – Conducted Emissions – CDMA 800 - Downlink.....	53
Test Data Table 23 – Conducted Emissions – GSM 800 – Uplink.....	53
Test Data Table 24 – Conducted Emissions – GSM 800 - Downlink.....	53
Test Data Table 25 – Conducted Emissions – AMPS 800 - Uplink .....	54
Test Data Table 26 – Conducted Emissions – AMPS 800 – Downlink .....	54
<b>OUT OF BAND REJECTION: FREQUENCY RESPONSE .....</b>	<b>55</b>
Figure 37. Amplifier frequency response (1850 – 1910) MHz band .....	55
Figure 38. Amplifier frequency response (1930 – 1990) MHz band .....	56
Figure 39. Amplifier frequency response (824 – 849) MHz band .....	57
Figure 40. amplifier frequency response (969 – 894) MHz band .....	58
<b>FIELD STRENGTH OF SPURIOUS EMISSIONS.....</b>	<b>59</b>
Test Data Table 27 – Radiated Emissions - CW .....	59
Test Data Table 28 – Radiated Emissions - CW .....	60
Test Data Table 29 – Radiated Emissions - CW .....	60
Test Data Table 30 – Radiated Emissions – CW .....	61
Test Data Table 31 – Radiated Emissions – 30 ~ 1000 MHz.....	61



## ATTESTATION STATEMENT



Certificate # 0955-01

This equipment has been tested in accordance with the standards identified in this test report. To the best of my knowledge and belief, these tests were performed using the measurement procedures described in this report. All instrumentation and accessories used to test products for compliance to the indicated standards are calibrated regularly in accordance with ISO 17025 requirements.

I attest that the necessary measurements were made, under my supervision, at TIMCO ENGINEERING, INC. located at 849 N.W. State Road 45, Newberry, Florida 32669.

Authorized Signatory Name: Mario de Aranzeta

Signature: On File

Function: Engineer

Date: 1/2/2009

Test technician name: Nam Nguyen

Date: 1/2/2009

## REPORT SUMMARY

Disclaimer	The test results relate only to the items tested.
Report Purpose	To demonstrate the unit comply with FCC Part 22H and Pt 24 and Industry Canada RS-131 requirements for a PCS/Cellular amplifier.
Applicable Rule Part(s)	Pt 22, Pt 24, Pt 15.109, RSS-131, ICES-003, ANSI C63.4: 2003, ANSI/TIA-603-C: 2004
Related Test Report	886BUT8TestReport.pdf (RSS-131)

## TEST ENVIRONMENT

Test Facilities	All required tests were performed by Timco Engineering Inc. that is located at 849 NW State Road 45 Newberry, FL 32669.
Test Conditions	Temperature: 26°C Relative Humidity: 50%

## TEST SETUP

Deviation to the rules	There was no deviation from the test standards.
Modification to the DUT	No modification was made to the DUT.
Test Exercise (e.g. software description, test signal, etc.)	The DUT was placed in continuous transmit mode of operation.
Supporting Test Equipment	<p>Manufacturer: Agilent</p> <p>Description: Dual-mode baseband generator (arbitrary waveform and real time I/Q) 250 kHz to 6 GHz</p> <p>Model Number: E4438C</p> <p>Cal Date: 01/31/06</p> <p>Cal Due Date: 01/31/08</p>

## DEVICE UNDER TEST INFORMATION

Manufactured by	Willson Electronics
DUT Description	PCS/Cellular Smart Amplifier
FCC ID	PWO271201SA
IC Label	IC: 4726A-271201SA
Model Name	271201
Operating Frequency	Uplink 824 – 849 MHz Downlink 869 – 894 MHz Uplink 1850 – 1910 MHz Downlink 1930 – 1990 MHz
Maximum Output and Input Power Rating per manufacturer spec	Uplink: 2.30 Watt Downlink: 0.016 Watt
Emission Designators	F9W (CDMA), GXW (GSM), F1D(AMPS), GXW (EDGE)
Modulation(s)	CDMA, GSM, EDGE, FM, HSPA, EVDO
User Power Range & Control	There are NO user power controls
Test Item	Production
DC Voltage and Current into final amplifier	Power Into Final Amplifier (uplink) Vcc = 6 VDC, 1.2 A Power Input (downlink) Vcc= 6Vdc, 0.67A
Type of Equipment	Fixed and Mobile
Antenna Connector	Fixed Applications: N-Type Mobile Applications: FME

## EQUIPMENT LIST

Device	Manufacturer	Model	Serial Number	Cal/Char Date	Due Date
3/10-Meter OATS	TEI	N/A	N/A	Listed 3/27/07	3/26/10
3-Meter OATS	TEI	N/A	N/A	Listed 1/11/06	1/10/09
Biconnical Antenna	Eaton	94455-1	1057	CAL 12/12/07	12/12/09
Biconnical Antenna	Eaton	94455-1	1096	CAL 8/17/06	8/17/08
Biconnical Antenna	Electro-Metrics	BIA-25	1171	CAL 4/29/07	4/29/09
Blue Tower Quasi-Peak Adapter	HP	85650A	2811A01279	CAL 4/13/07	4/13/09
Blue Tower RF Preselector	HP	85685A	2926A00983	CAL 9/5/07	9/5/09
Blue Tower Spectrum Analyzer	HP	8568B	2928A04729 2848A18049	CAL 4/13/07	4/13/09
LISN	Electro-Metrics	ANS-25/2	2604	CAL 8/27/06	8/27/08
LISN	Electro-Metrics	EM-7820	2682	CAL 4/28/07	4/28/09
Log-Periodic Antenna	Eaton	96005	1243	CAL 12/14/07	12/14/09
Passive Loop Antenna	EMC Test Systems	EMCO 6512	9706-1211	CHAR 7/10/06	7/10/08

## TEST PROCEDURE

### RF Power Output

RF power is measured by connecting a 50-ohm, resistive wattmeter to the RF output connector. With a nominal voltage and the amplifier properly adjusted the RF output measures.

RF Output Power Test Setup Diagram

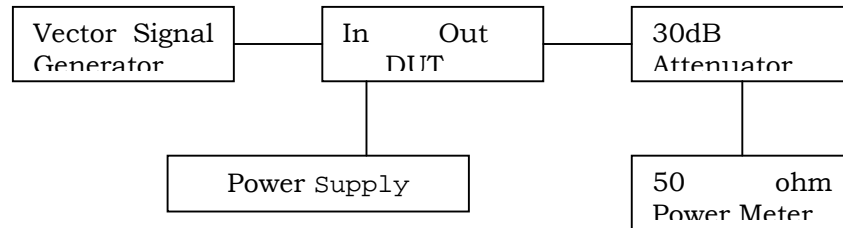

### Input/Output Modulated Amplitude Comparison And Band-Edges Compliance

On the following plot, the reference level was calibrated using a resolution bandwidth wider than the emission bandwidth. First the gain was measured for the maximum output power. Then for each frequency and type of modulation, an attenuation equals to the gain of the amplifier was added on the measurement side of the amplifier, as to overlay the input versus output modulated envelope.

Test Setup Diagram

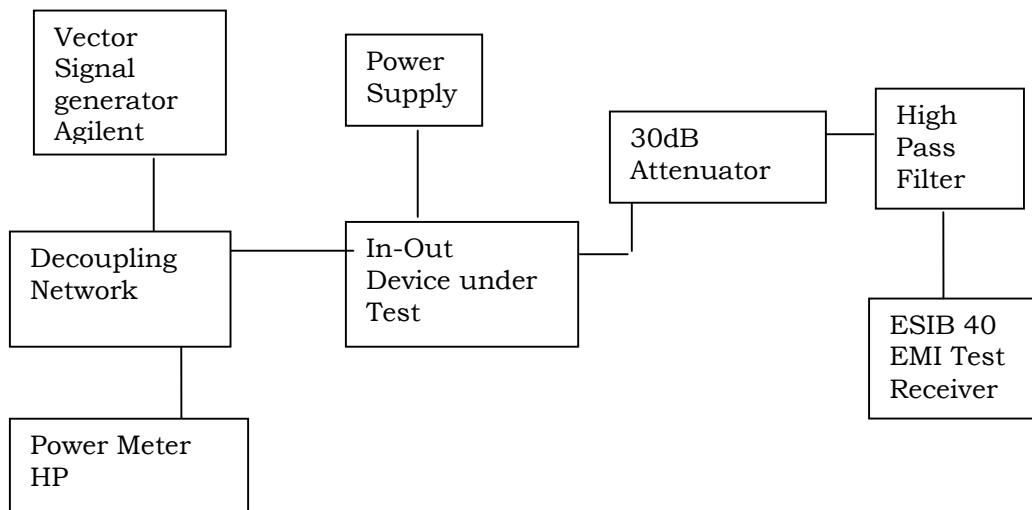

[Continued]



**Intermodulation Product Spurious Emissions**

The procedure used was ANSI/TIA-603-C: 2004. The spectrum was scanned from 9kHz to at least the tenth harmonic of the fundamental using a HP model 8566B spectrum analyzer.

The modulation type was tested using the two-tone / three tone test method. The input power to the amplifier was set at maximum drive level by combining the two tones. The two tones were chosen in such a way (1) the third order intermodulation product frequencies are located within the pass band of the DUT and (2) they produce the worst-case emissions out of band.

Setup Diagram

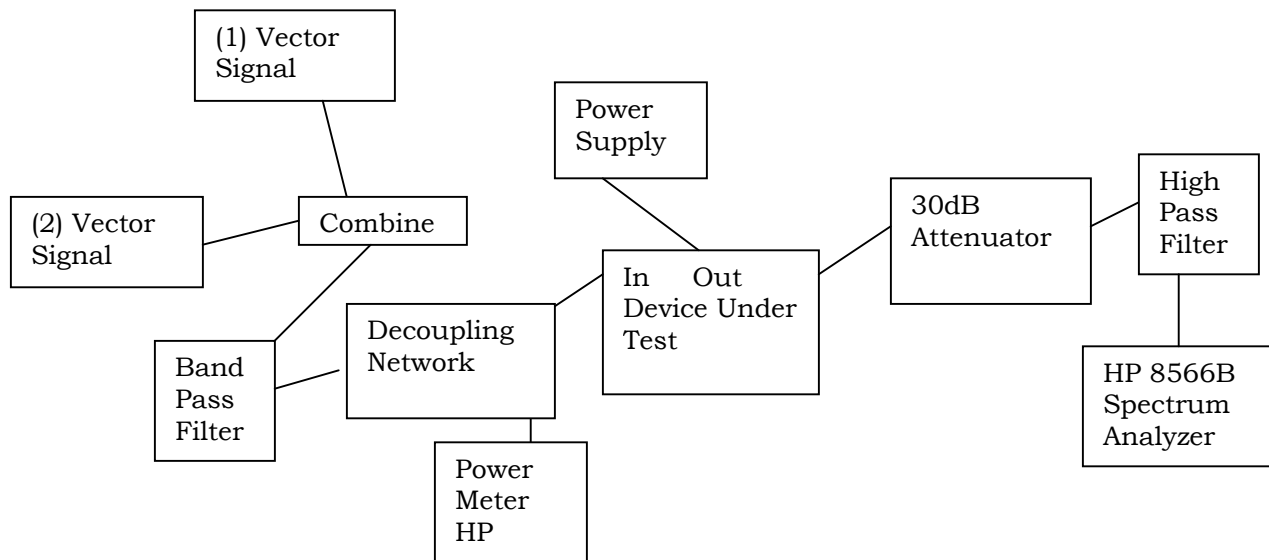

**Spurious Emissions at Antenna Terminals**

The procedure used was ANSI/TIA-603-C: 2004. The spectrum was scanned from 9kHz to at least the tenth harmonic of the fundamental using a HP model 8566B spectrum analyzer.

Data on the following page shows the level of conducted spurious responses. For analog modulation, the carrier was modulated 100% using a 2500 Hz tone. For digital modulation, the carrier is modulated to its maximum extent. The spectrum was scanned from 9kHz to at least the 10th harmonic of the fundamental. The measurements were made in accordance with standard ANSI/TIA-603-C: 2004. The maximum input power was set for each test.

[Continued]

Conducted Spurious Emissions Test Setup Diagram

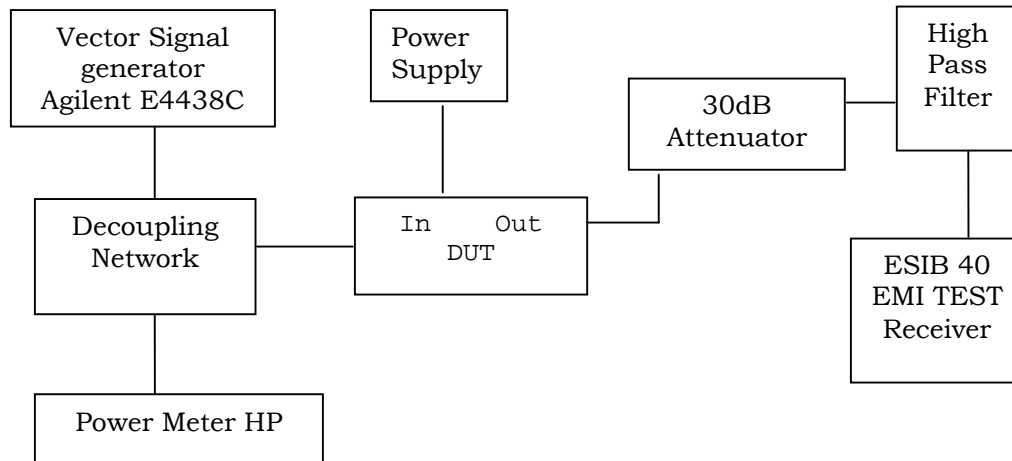

**Radiated Spurious Emissions**

The spectrum was scanned from 30 MHz to at least the tenth harmonic of the fundamental. The CW signal was used to perform this test. This test was conducted per ANSI/TIA-603-C: 2004 using the substitution method.

Radiated Spurious Emissions Test Setup Diagram

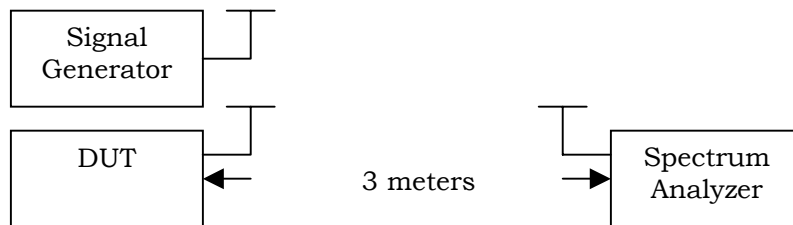

Equipment placed 80 cm above ground on a rotating table platform.

**RF POWER OUTPUT**

**Rule Part(s) No.:** Pt 2.1046(a)

**Requirements:** Pt 2.1046(a)

**Test Result:** As the following table indicates. Notes: the maximum power output value was obtained with CDMA modulation at 836.5MHz and 1960MHz.

Test Data Table 1 – Output Power – CDMA 1900 – Uplink/Downlink

Tuned Frequency (MHz)	Power Input (dBm)	Power Output (dBm)	Power Output (mW)	Tuned Frequency (MHz)	Power Input (dBm)	Power Output (dBm)	Power Output (mW)
1851.25	-18	33.41	2193	1931.25	-41	10.62	12
1880.00	-18	33.61	2296	1960.00	-41	11.98	16
1908.75	-18	30.22	1052	1988.75	-41	10.58	11

Test Data Table 2 – Output Power – EDGE 1900 – Uplink/Downlink

Tuned Frequency (MHz)	Power Input (dBm)	Power Output (dBm)	Power Output (mW)	Tuned Frequency (MHz)	Power Input (dBm)	Power Output (dBm)	Power Output (mW)
1850.20	-17	28.81	760	1930.20	-37	8.13	7
1880.00	-17	28.34	682	1960.00	-37	9.15	8
1909.80	-17	25.38	345	1989.80	-37	8.72	7

Test Data Table 3 – Output Power – GSM 1900 – Uplink/Downlink

Tuned Frequency (MHz)	Power Input (dBm)	Power Output (dBm)	Power Output (mW)	Tuned Frequency (MHz)	Power Input (dBm)	Power Output (dBm)	Power Output (mW)
1850.20	-18	27.69	587	1930.20	-36	8.94	8
1880.00	-18	27.62	578	1960.00	-36	10.35	11
1909.80	-18	25.05	320	1989.80	-36	8.82	8

[Continued]

Test Data Table 5 – Output Power – CDMA 800 – Uplink/Downlink

Tuned Frequency (MHz)	Power Input (dBm)	Power Output (dBm)	Power Output (mW)
825.25	-19	34.04	2535
836.50	-19	34.5	2818
847.75	-19	33.22	2099

Tuned Frequency (MHz)	Power Input (dBm)	Power Output (dBm)	Power Output (mW)
870.25	-44	10.29	11
881.50	-44	11.26	13
892.75	-44	11.19	13

Test Data Table 6 – Output Power – EDGE 800 – Uplink/Downlink

Tuned Frequency (MHz)	Power Input (dBm)	Power Output (dBm)	Power Output (mW)
824.20	-18	29.06	805
836.50	-18	29.69	931
848.80	-18	28.19	659

Tuned Frequency (MHz)	Power Input (dBm)	Power Output (dBm)	Power Output (mW)
869.20	-38	8.09	6
881.50	-38	8.79	8
893.80	-38	8.72	7

Test Data Table 7 – Output Power – GSM 800 – Uplink/Downlink

Tuned Frequency (MHz)	Power Input (dBm)	Power Output (dBm)	Power Output (mW)
824.20	-18	29.94	986
836.50	-18	30.12	1028
848.80	-18	29.57	906

Tuned Frequency (MHz)	Power Input (dBm)	Power Output (dBm)	Power Output (mW)
869.20	-39	7.85	6
881.50	-39	9.30	9
893.80	-39	8.80	8

Test Data Table 8 – Output Power – AMPS 800 – Uplink/Downlink

Tuned Frequency (MHz)	Power Input (dBm)	Power Output (dBm)	Power Output (mW)
824.20	-14	31.07	1279
836.50	-14	31.79	1510
848.80	-14	30.3	1072

Tuned Frequency (MHz)	Power Input (dBm)	Power Output (dBm)	Power Output (mW)
869.20	-39	7.55	6
881.50	-39	9.08	8
893.80	-39	7.86	6

## **INPUT/OUTPUT MODULATED AMPLITUDE COMPARISON AND BAND-EDGES COMPLIANCE**

**Rule Parts No.:** Pt 2.1049, Pt 2.1051, 22H, 24E

**Requirements:** The power of any emission outside of the authorized operating frequency ranges must be attenuated below the transmitting power (P) by a factor of at least  $43 + 10 \log(P)$  dB.

**Test Data:** The DUT appears to meet the requirements.

Bandedge compliance: Measurements were performed in accordance with Part 24.238

The Reference level on the following plots was calibrated using a 3MHz RBW=VBW.

Compensating for RBW (1%) using  $10 \log(12.5/3) = 6.2$  dB we get the following amplitudes at the bandedge:

Test Data Table 10 – CDMA 1900 – Uplink/Downlink

Channel (MHz)	Bandedge Frequency (MHz)	Amplitude bandedge (dBm)	Limit (dBm)	Margin (dB)
1851.25	1849.91	-24.72	-13	11.72
1908.75	1910.04	-25.09	-13	12.09
1931.25	1929.90	-62.87	-13	49.87
1988.75	1990.03	-63.7	-13	50.7

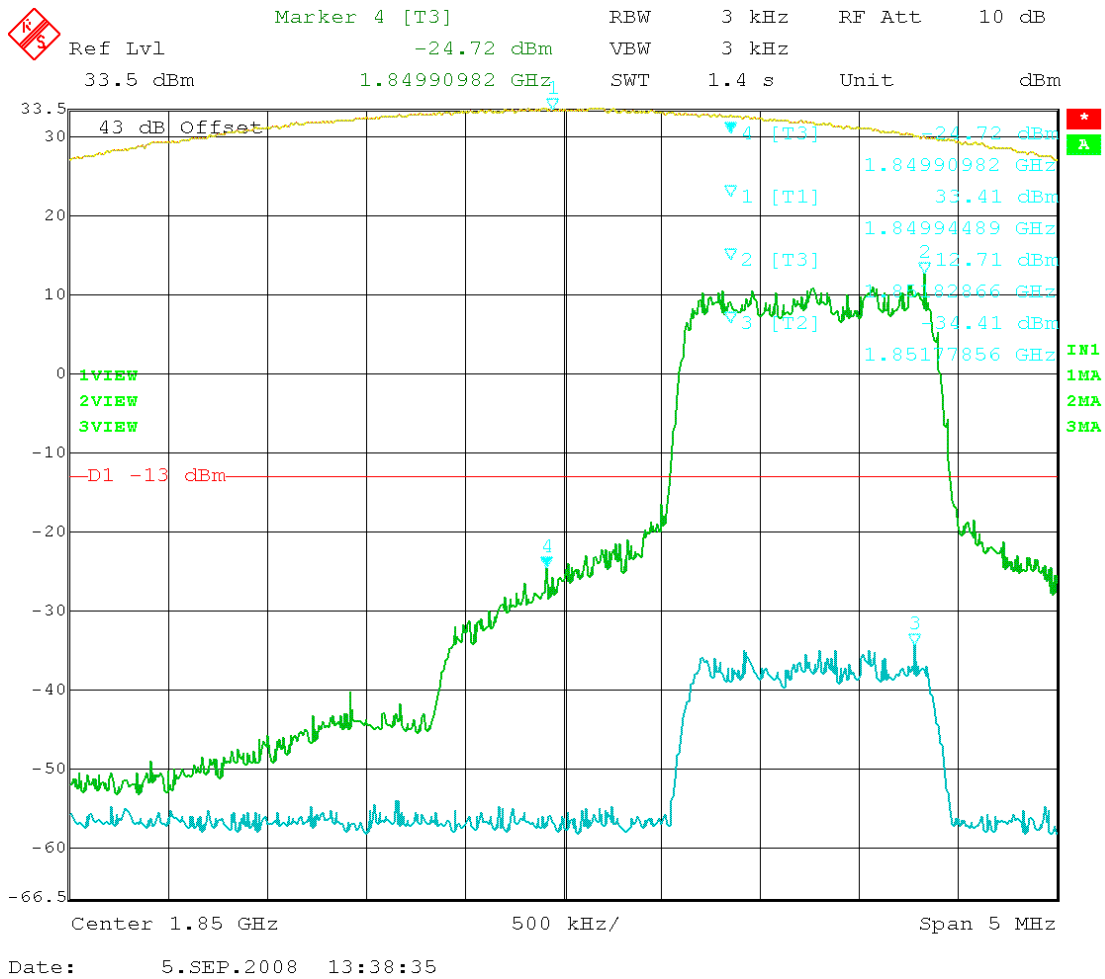
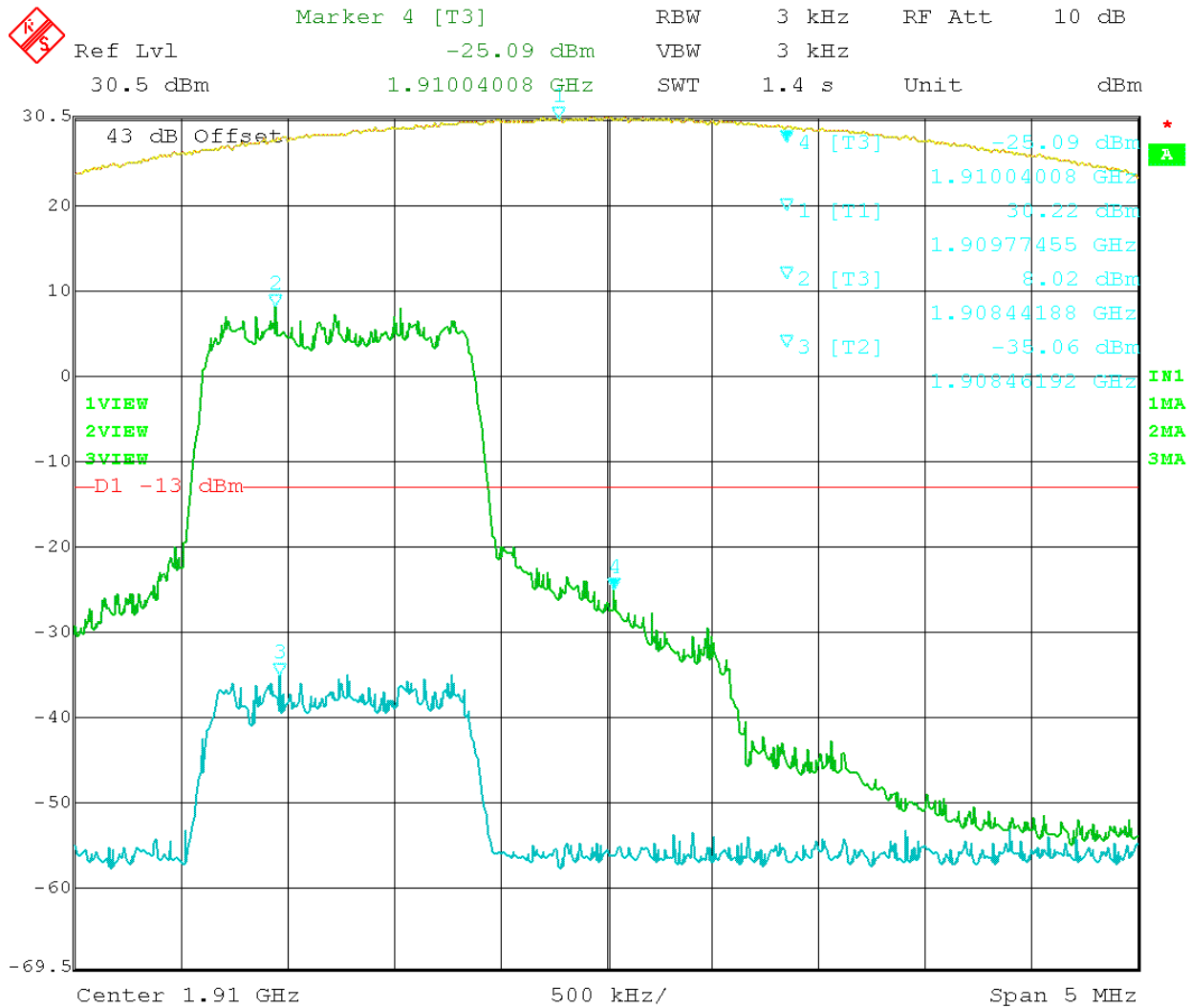
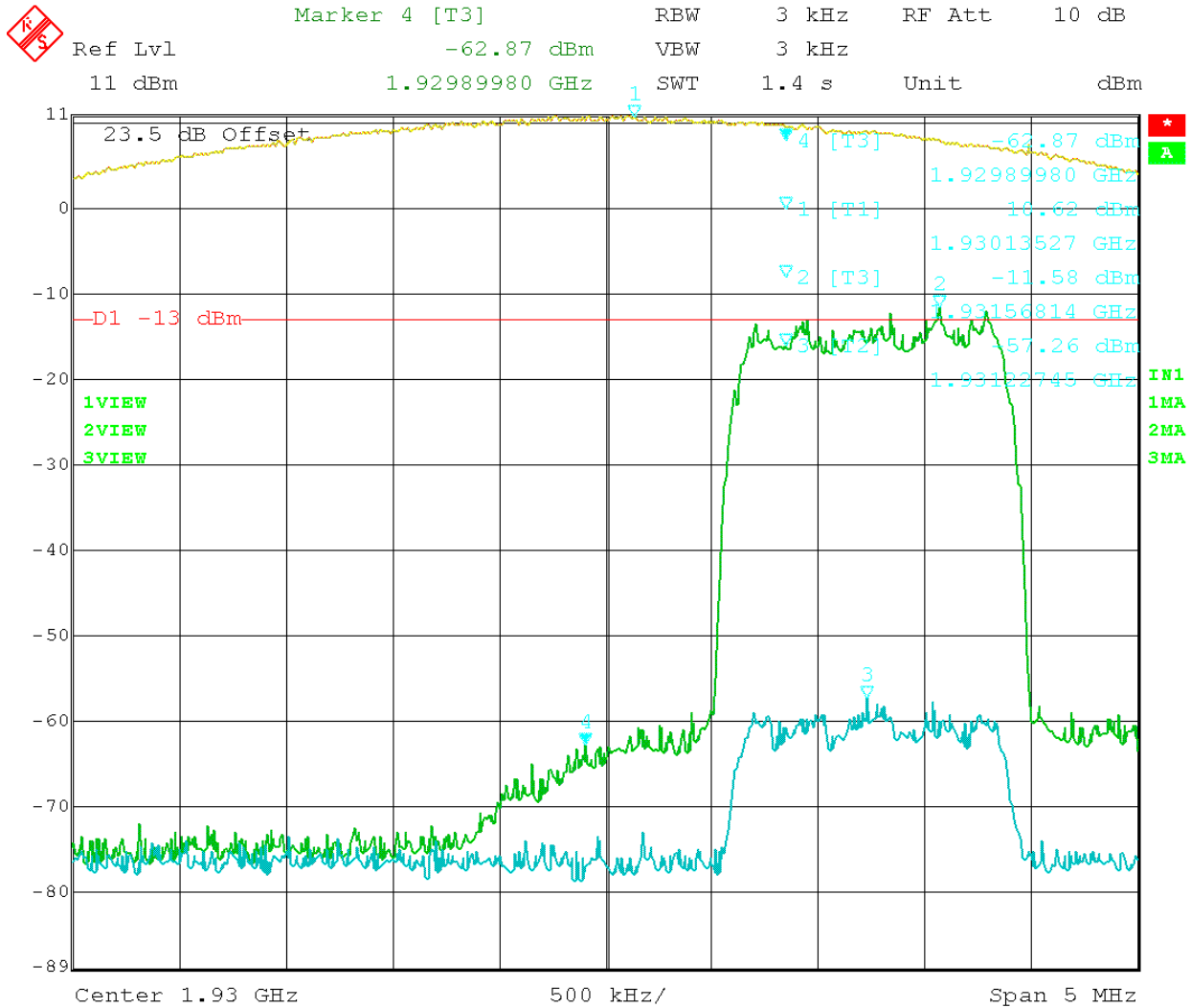

Figure 1: CDMA – In vs. Out 1851.25MHz



Date: 5.SEP.2008 13:47:05

Figure 2: CDMA – In vs. Out 1908.75MHz



Date: 5.SEP.2008 14:12:27

Figure 3: CDMA – In vs. Out 1931.25MHz



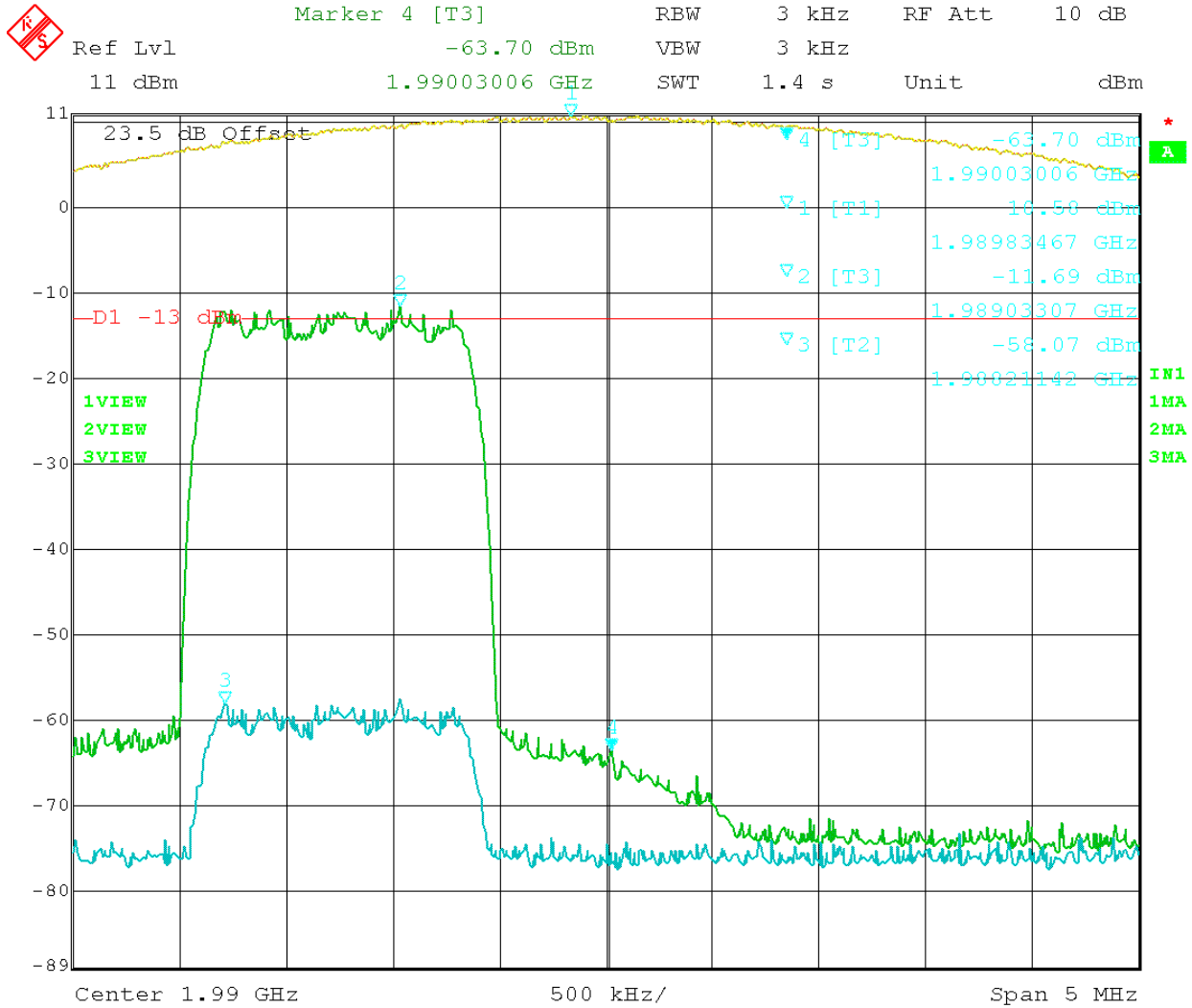

Date: 5.SEP.2008 14:31:56

Figure 4: CDMA – In vs. Out 1988.75MHz

Test Data Table 11 – EDGE 1900 – Uplink/Downlink

Channel (MHz)	Band-edge Frequency (MHz)	Amplitude level at the band-edge (dBm)	Limit (dBm)	Margin (dB)
1850.2	1849.99	-14.73	-13	1.73
1909.8	1910.01	-21.64	-13	8.64
1930.2	1929.98	-41.69	-13	28.69
1989.8	1990.02	-43.28	-13	30.28

The Reference level on the following plots was calibrated using a 3MHz RBW=VBW.

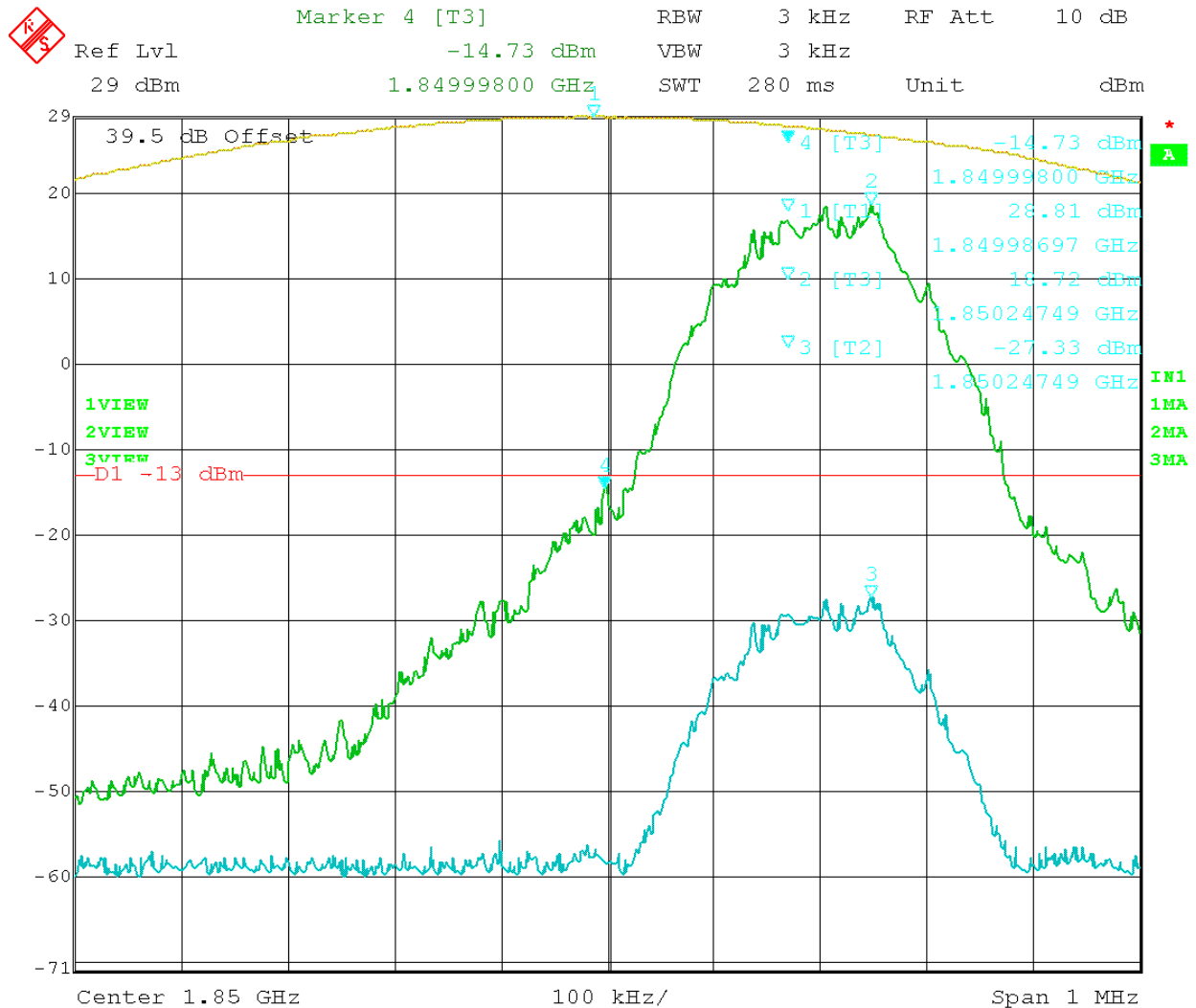

Date: 5.SEP.2008 10:26:54

Figure 5: EDGE – In vs. Out 1850.20MHz

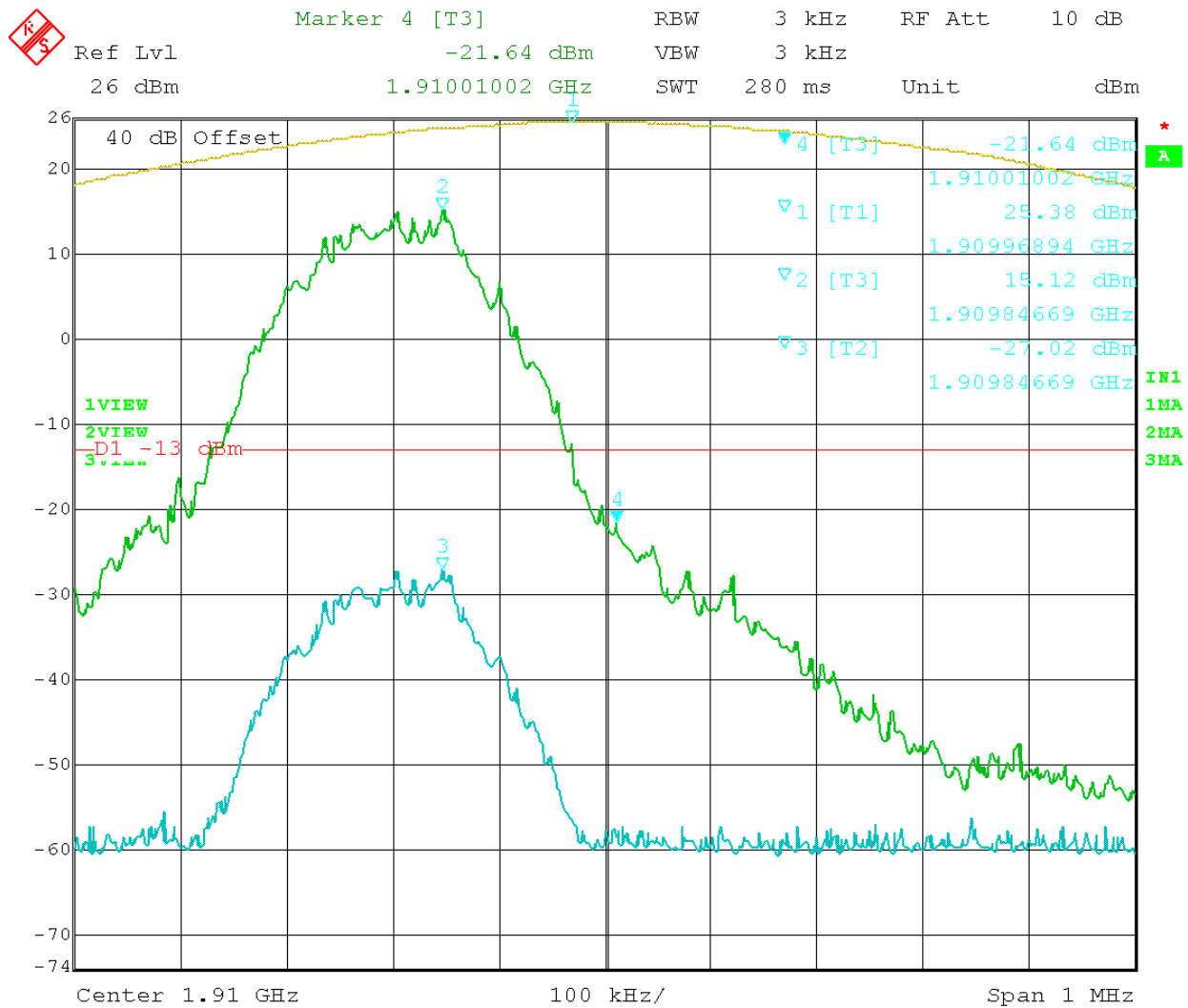

Date: 5.SEP.2008 10:38:41

Figure 6: EDGE - In vs. Out 1909.80MHz

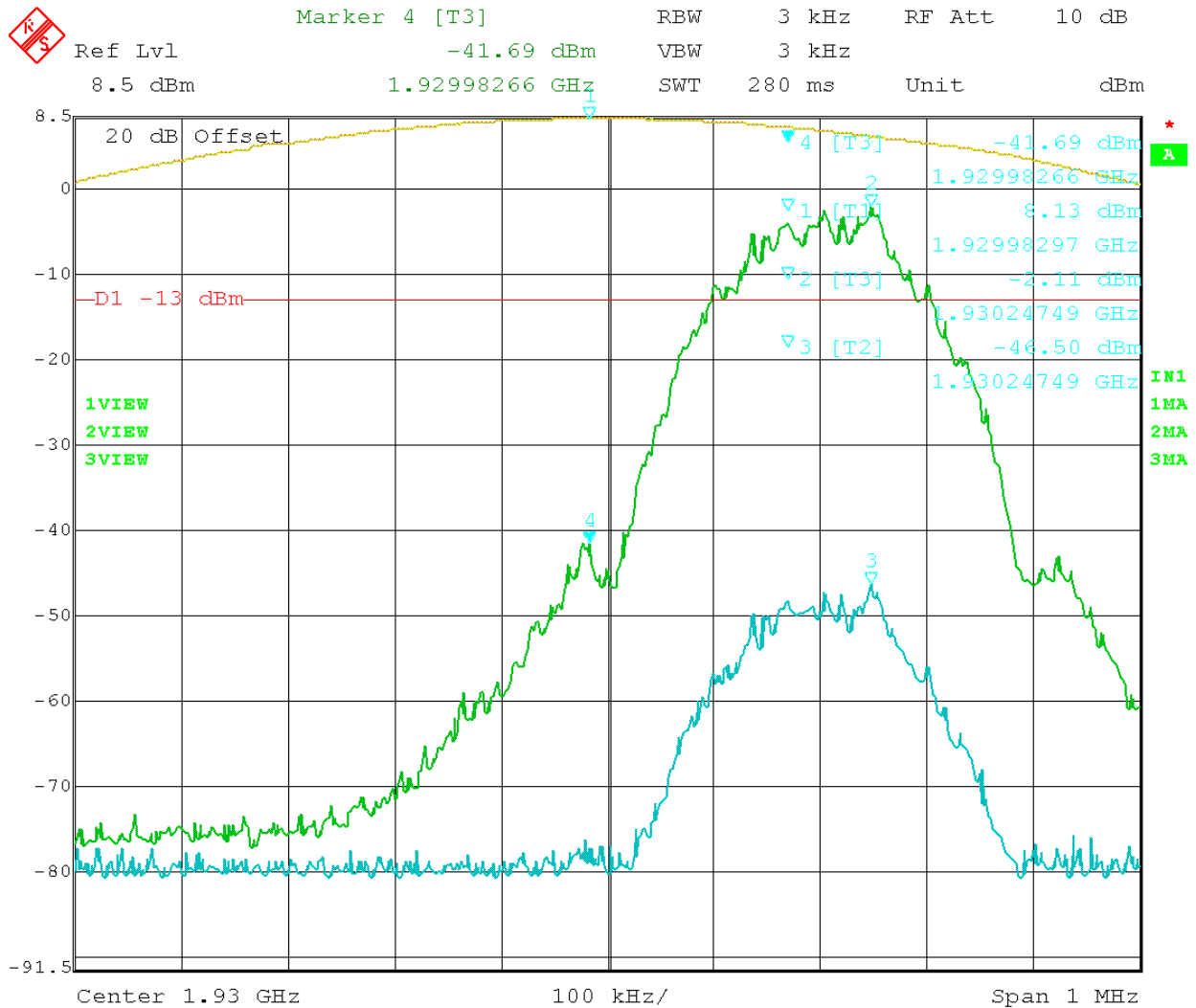
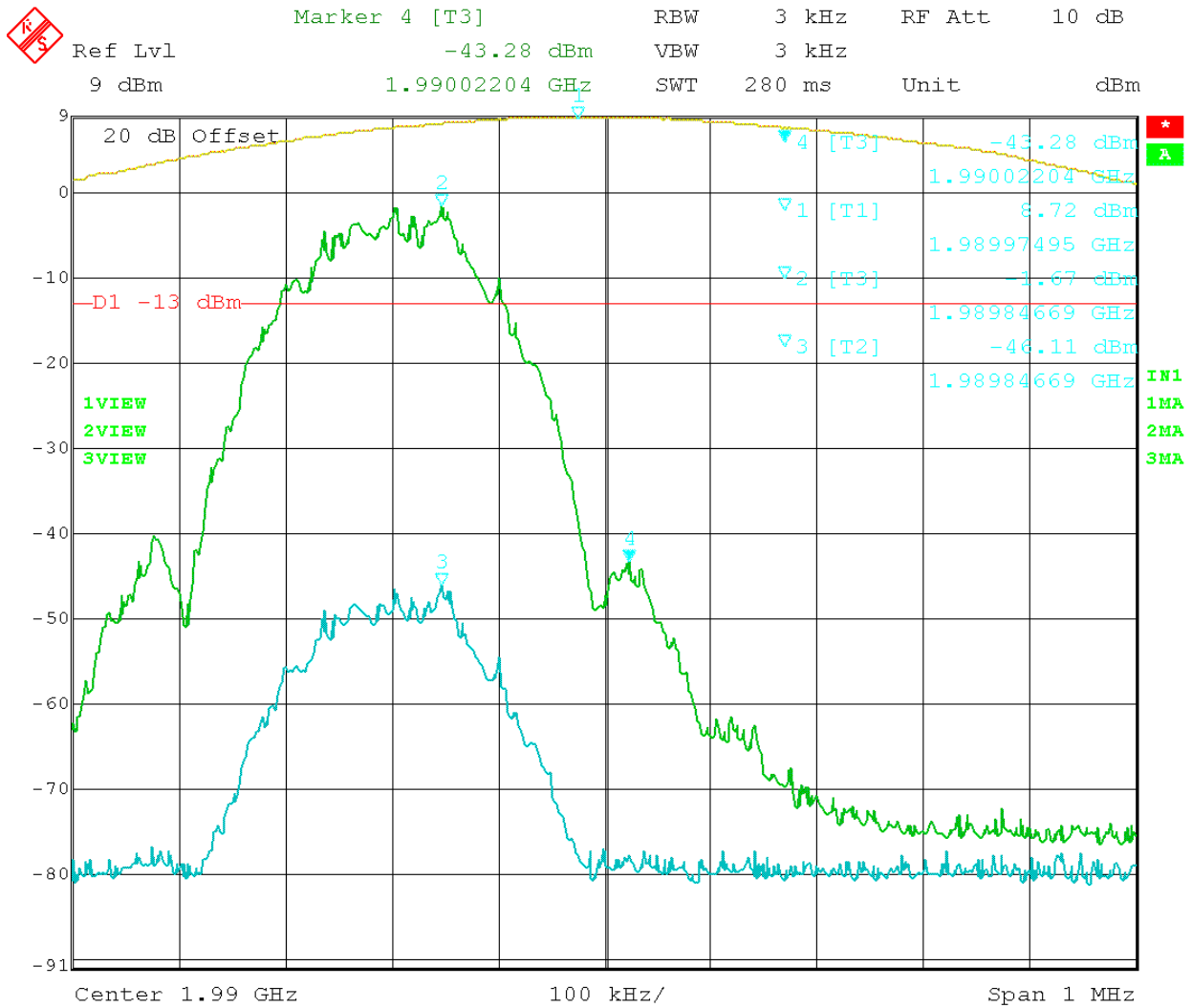

Figure 7: EDGE – In vs. Out 1930.20MHz



Date: 5.SEP.2008 16:44:24

Figure 8: EDGE – In vs. Out 1989.80MHz

Test Data Table 12 –GSM 1900 – Uplink/Downlink

Channel (MHz)	Band-edge Frequency (MHz)	Amplitude level at the band-edge (dBm)	Limit (dBm)	Margin (dB)
1850.2	1849.98	-17.3	-13	4.3
1909.8	1910.02	-21.02	-13	8.02
1930.2	1929.98	-36.37	-13	23.37
1989.8	1990.02	-37.4	-13	24.4

The Reference level on the following plots was calibrated using a 3MHz RBW=VBW.

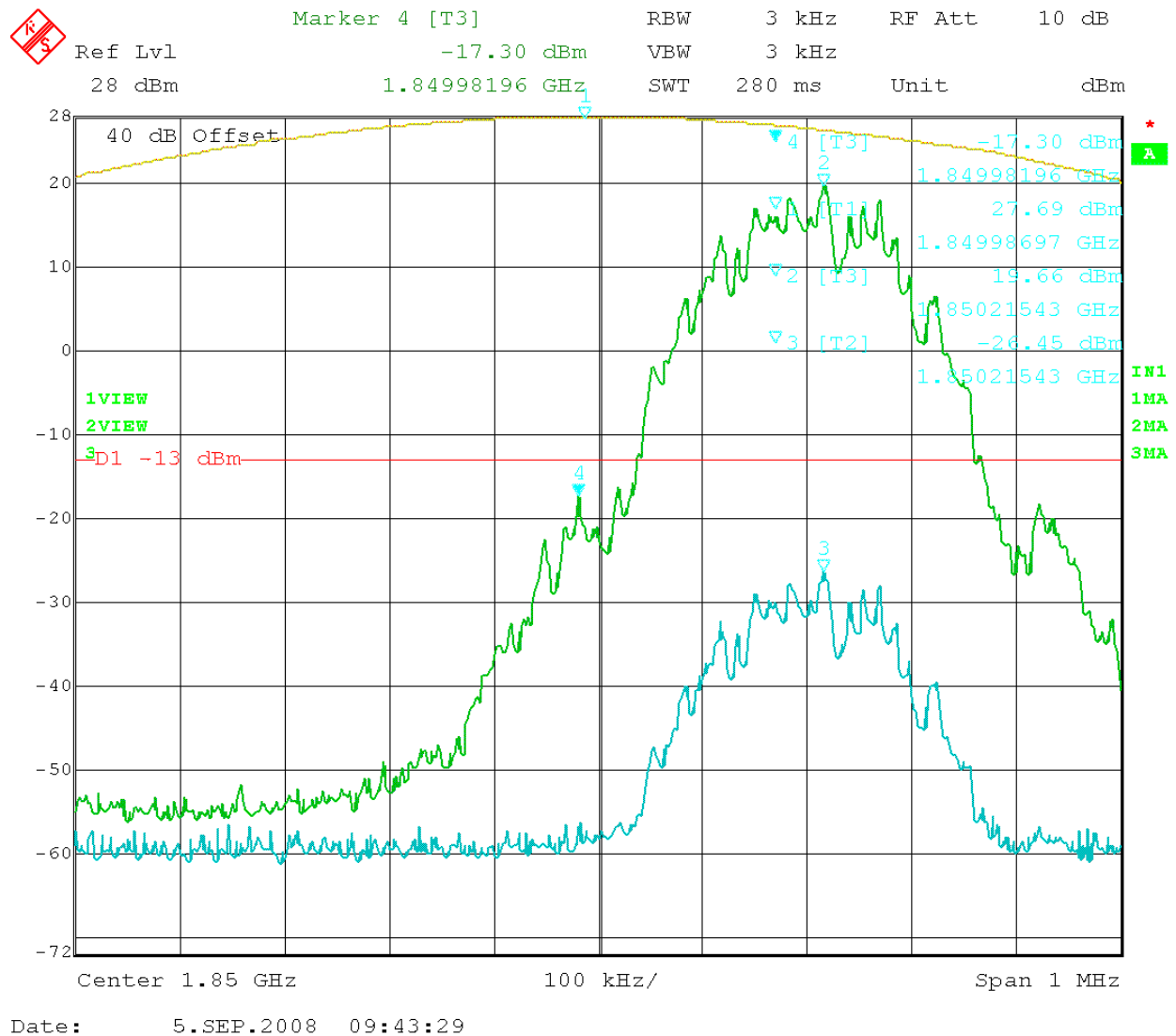
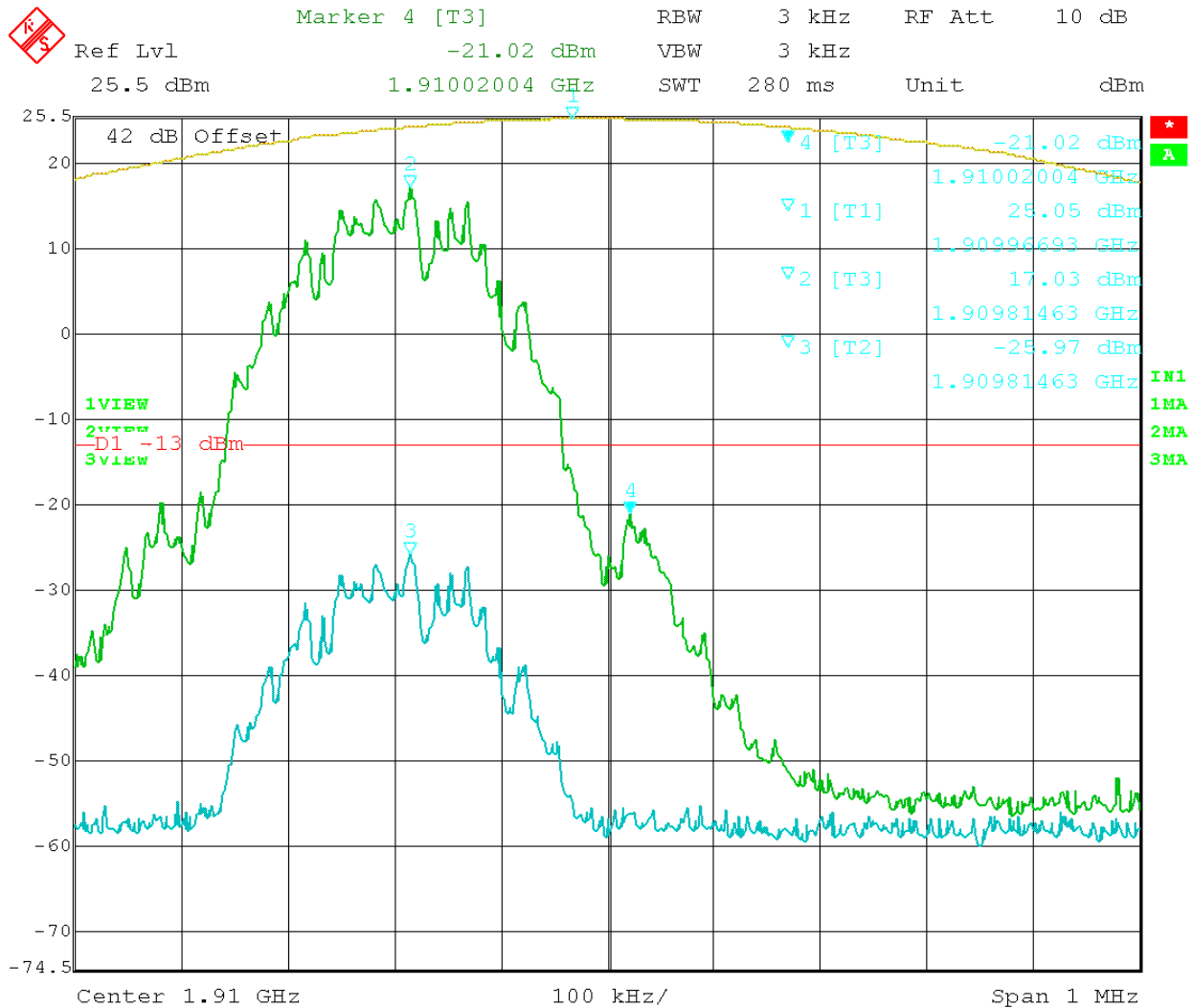
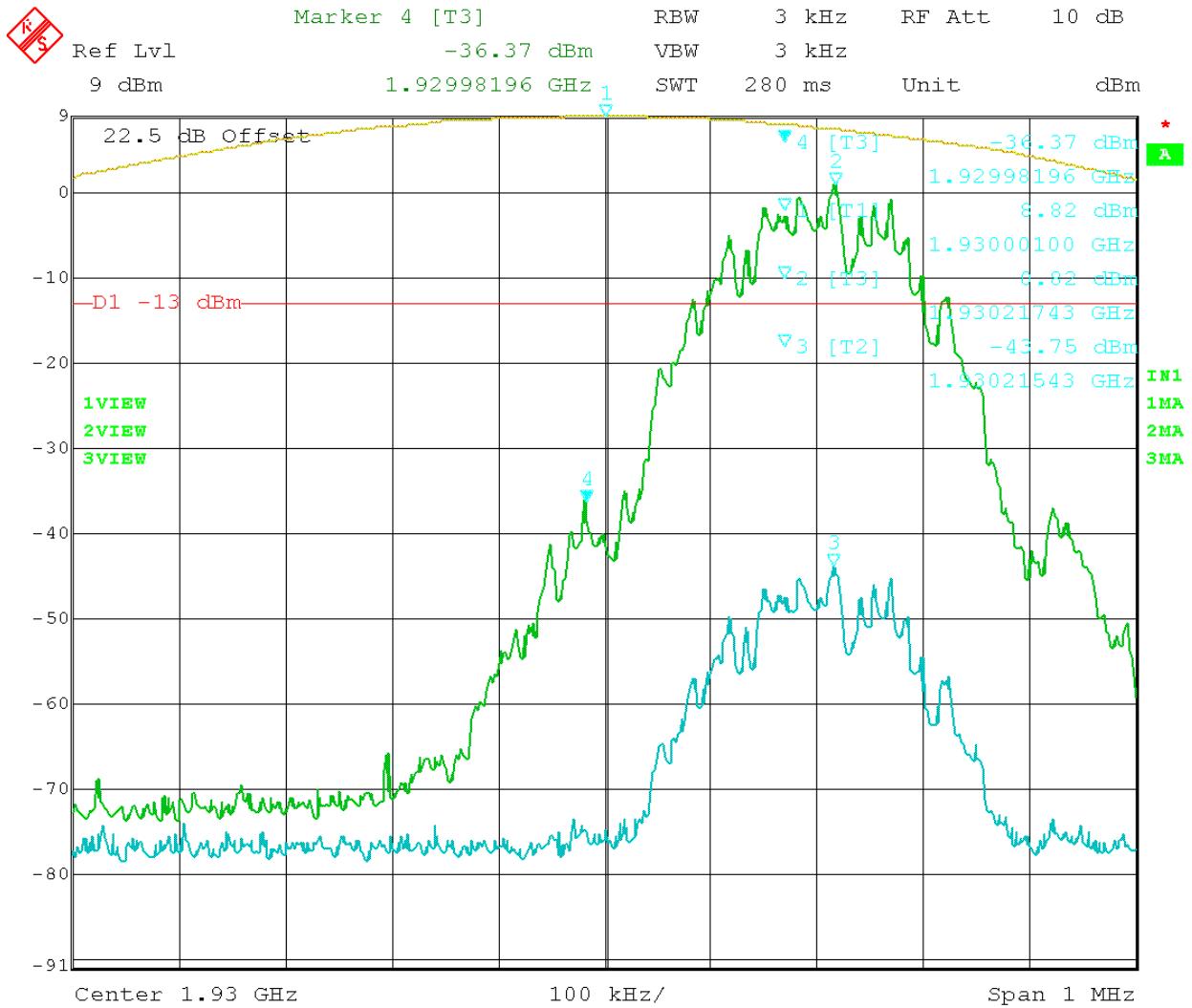

Figure 9: GSM – In vs. Out 1850.20MHz



Date: 5.SEP.2008 09:53:48

Figure 10: GSM – In vs. Out 1909.80MHz



Date: 5.SEP.2008 16:13:26

Figure 11: GSM – In vs. Out 1930.20MHz



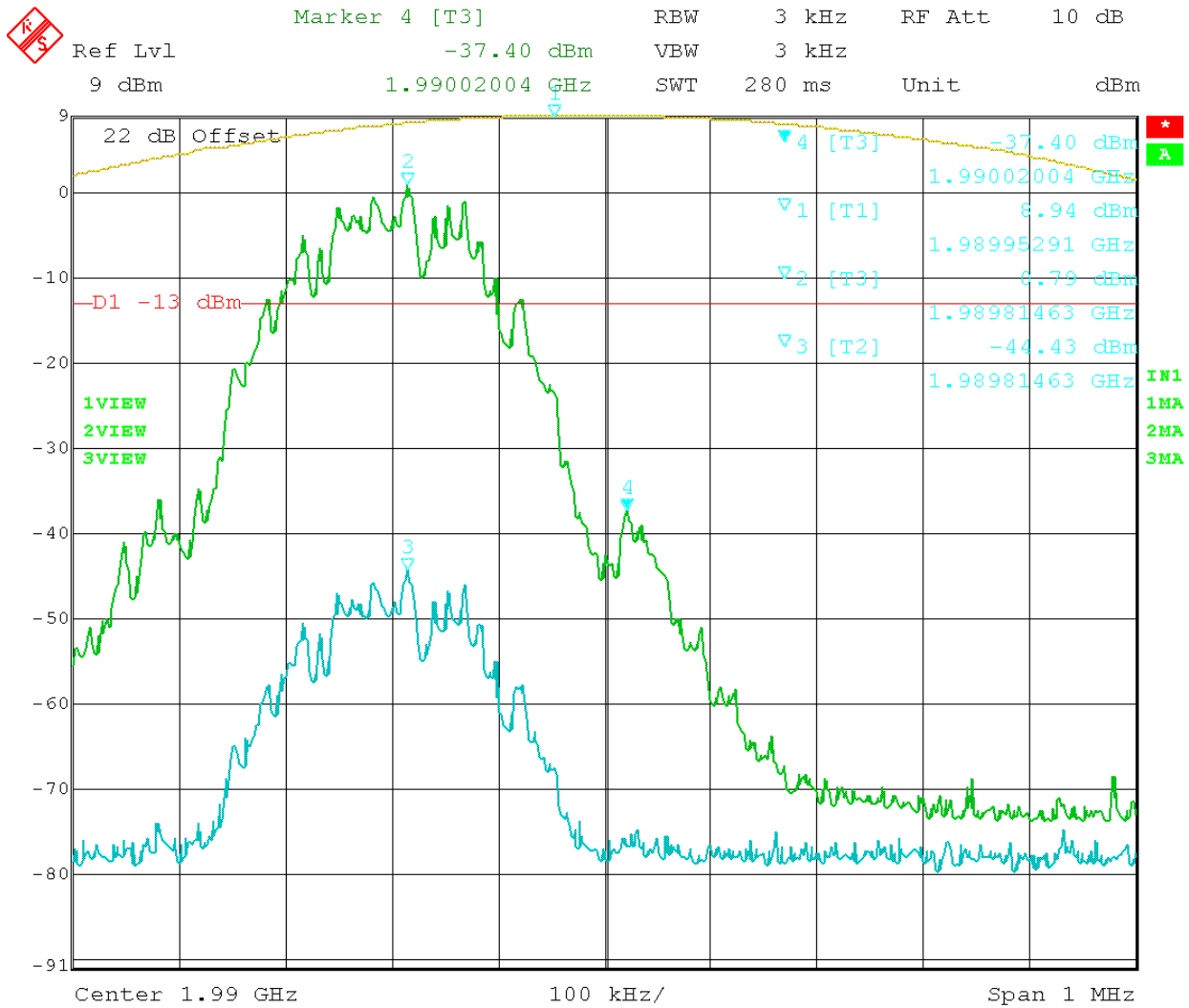

Date: 5.SEP.2008 16:03:47

Figure 12: GSM – In vs. Out 1989.80MHz

Compensating for RBW (1%) using  $10 \log(12.5/3) = 6.2$  dB we get the following amplitudes at the bandedge:

Test Data Table 13 – CDMA 800 – Uplink/Downlink

Channel (MHz)	Bandedge Frequency (MHz)	Amplitude level at the band-edge (dBm)	Limit (dBm)	Margin (dB)
825.25	823.92	-34.77	-13	21.77
847.75	849.07	-29.78	-13	16.78
870.25	868.92	-60.98	-13	47.98
892.75	894.03	-58.39	-13	45.39

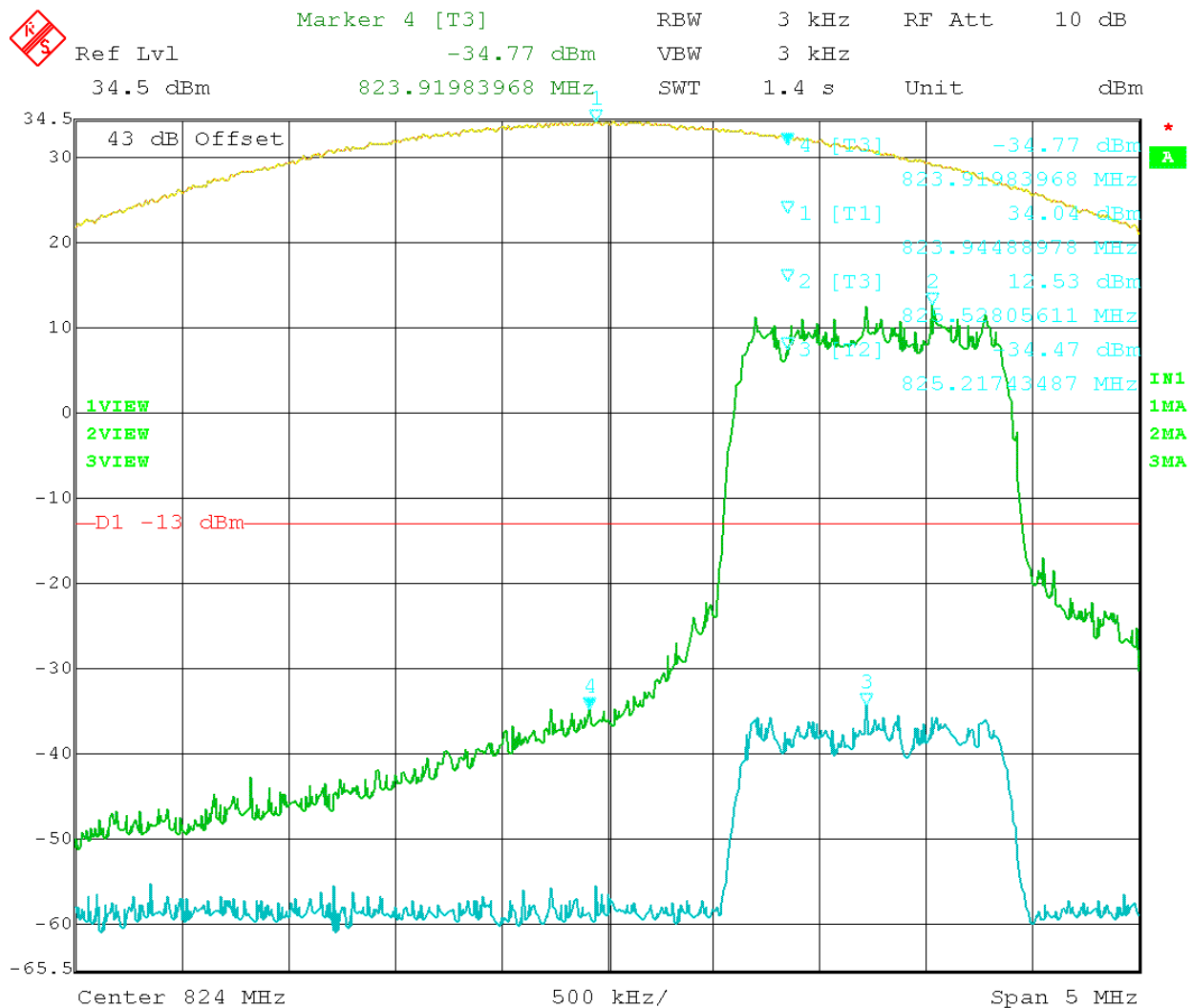

Date: 5.SEP.2008 11:33:58

Figure 13: CDMA – In vs. Out 825.25MHz

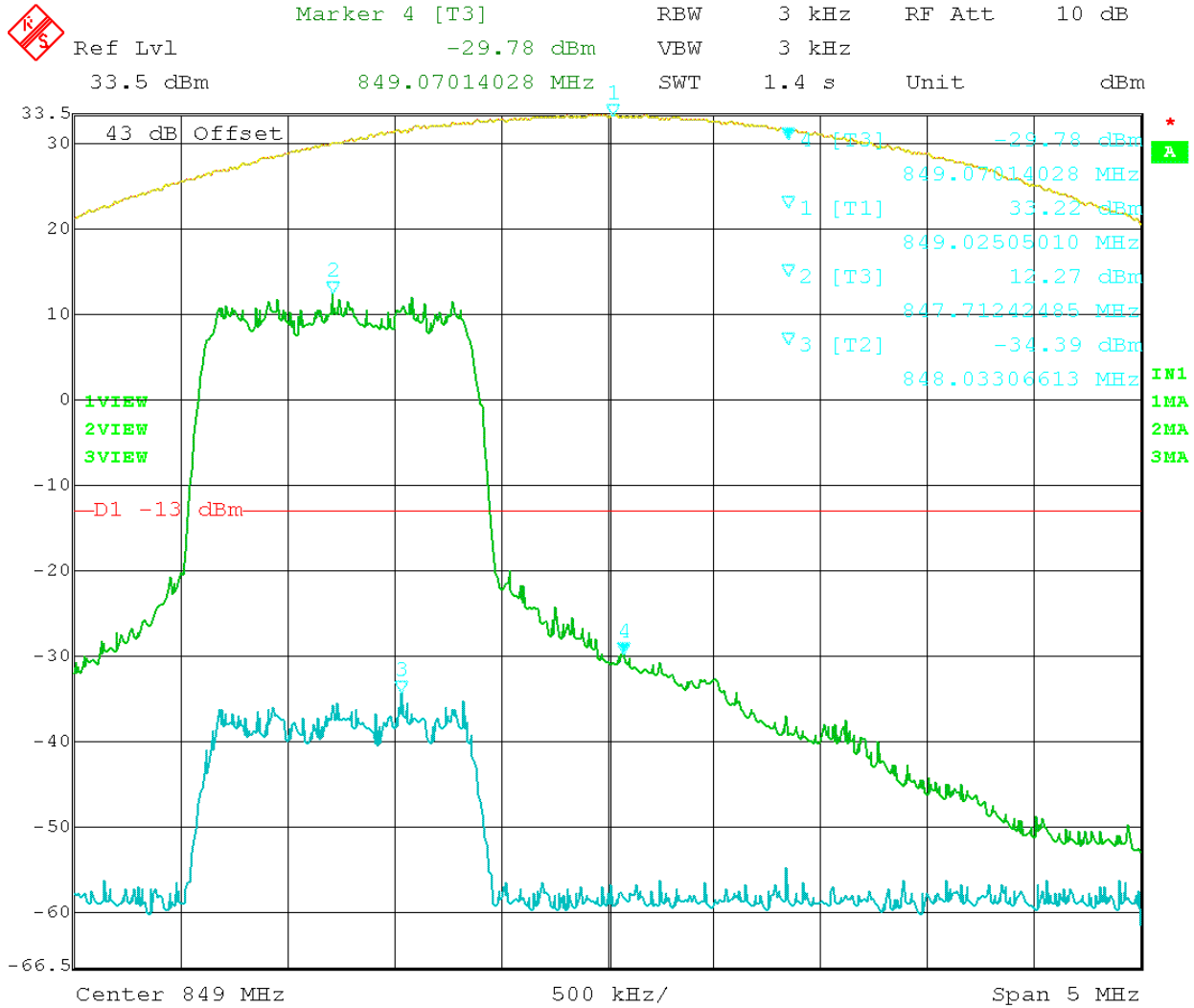

Date: 5.SEP.2008 11:23:52

Figure 14: CDMA – In vs. Out 847.75 MHz

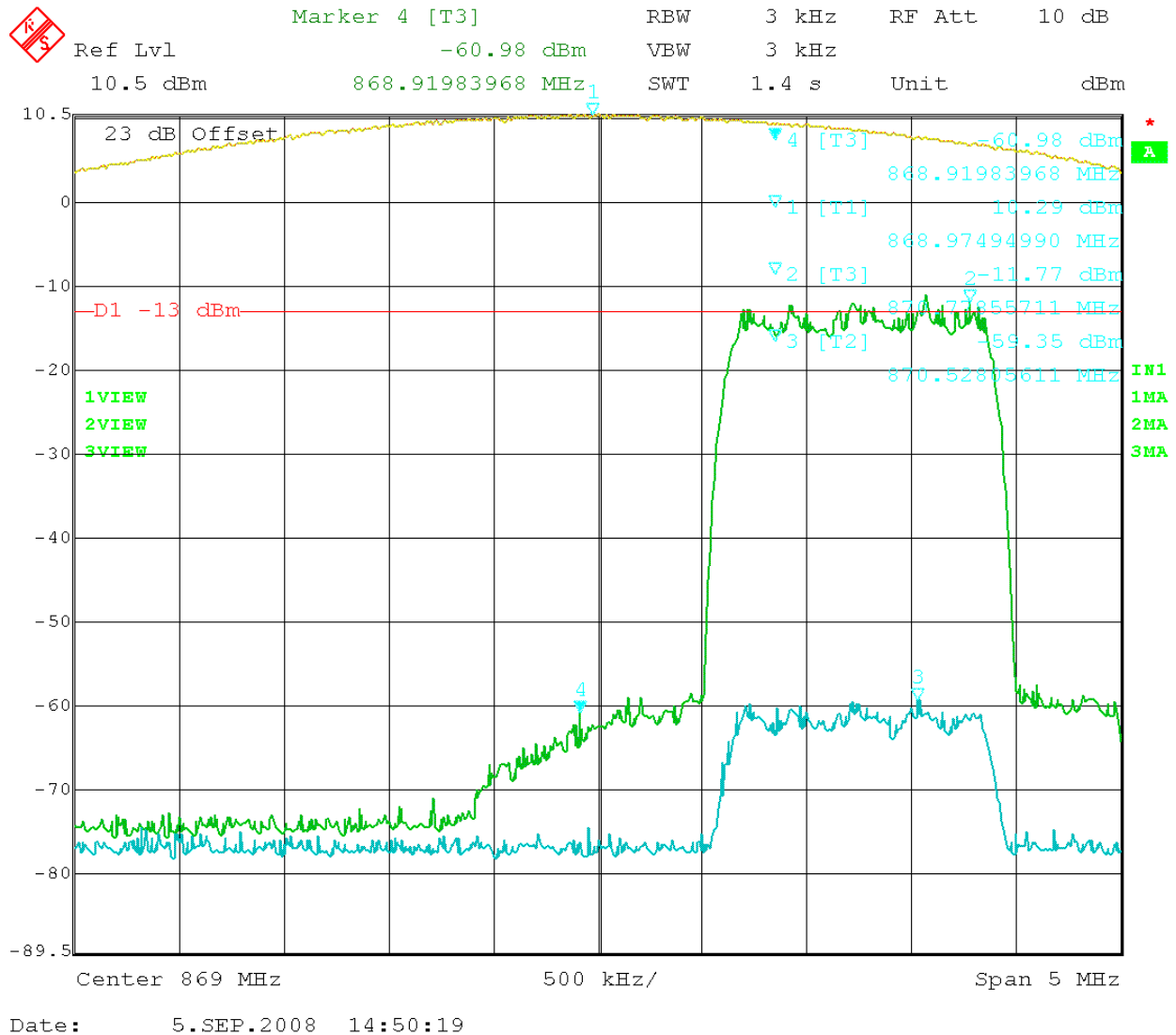

Figure 15: CDMA – In vs. Out 870.25 MHz

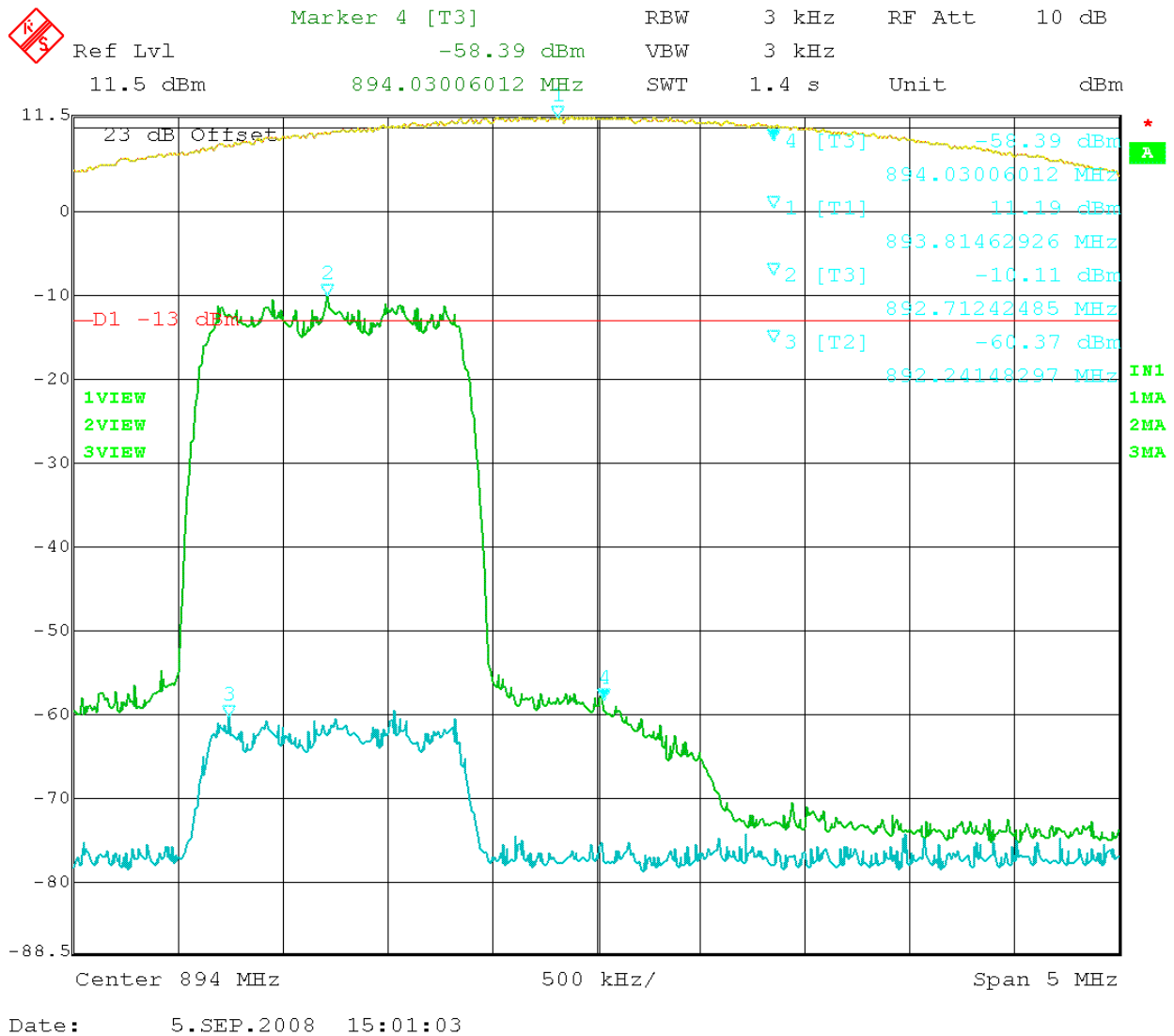
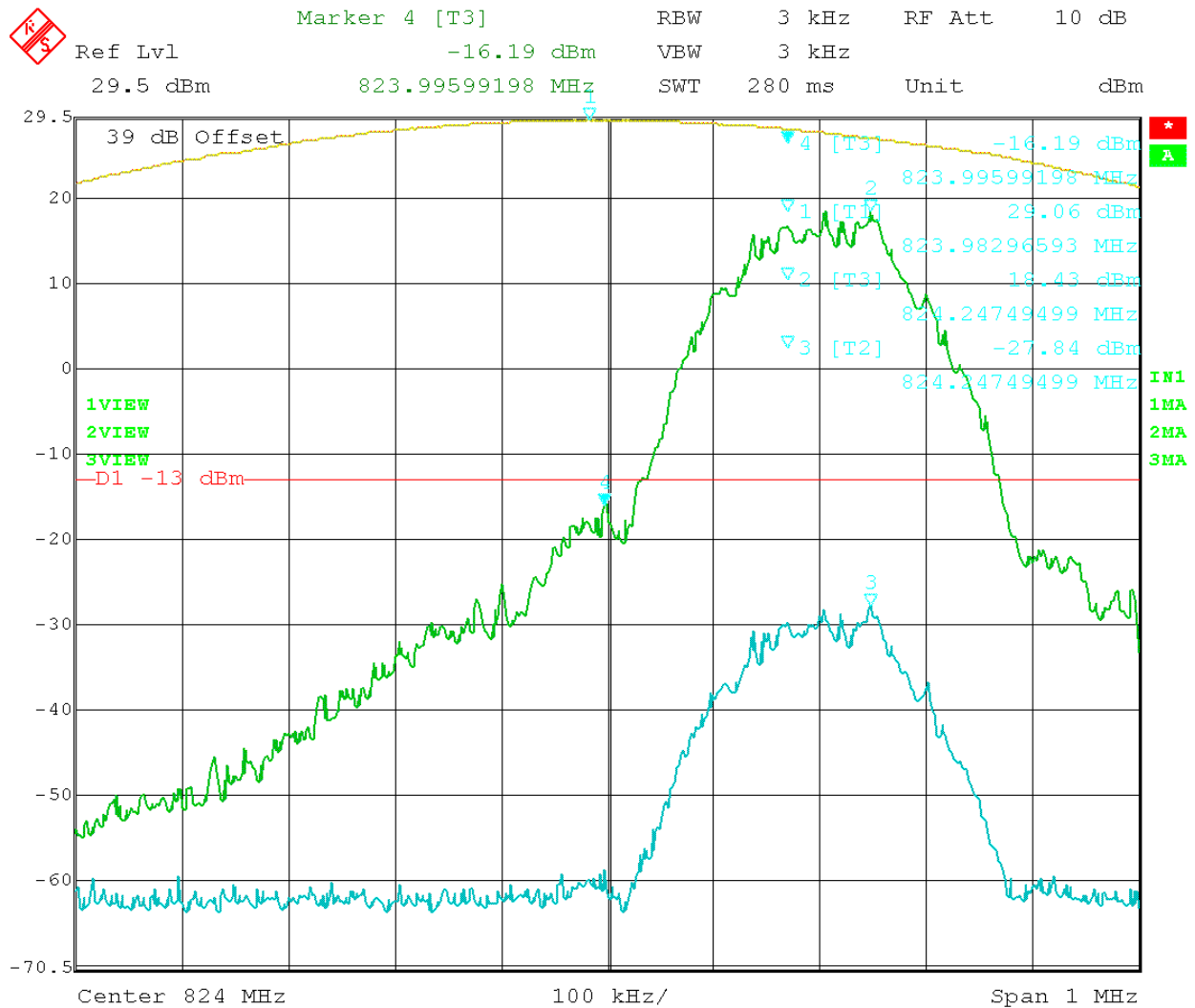

Figure 16: CDMA - In vs. Out 892.75 MHz

Test Data Table 14 – EDGE 800 – Uplink/Downlink

Channel (MHz)	Band-edge Frequency (MHz)	Amplitude level at the band-edge (dBm)	Limit (dBm)	Margin (dB)
824.2	823.99	-16.19	-13	3.19
848.8	849.01	-23.3	-13	10.3
869.2	868.98	-42.08	-13	29.08
893.8	894.01	-38.98	-13	



Date: 5.SEP.2008 10:57:55

Figure 17: EDGE – In vs. Out 824.20 MHz

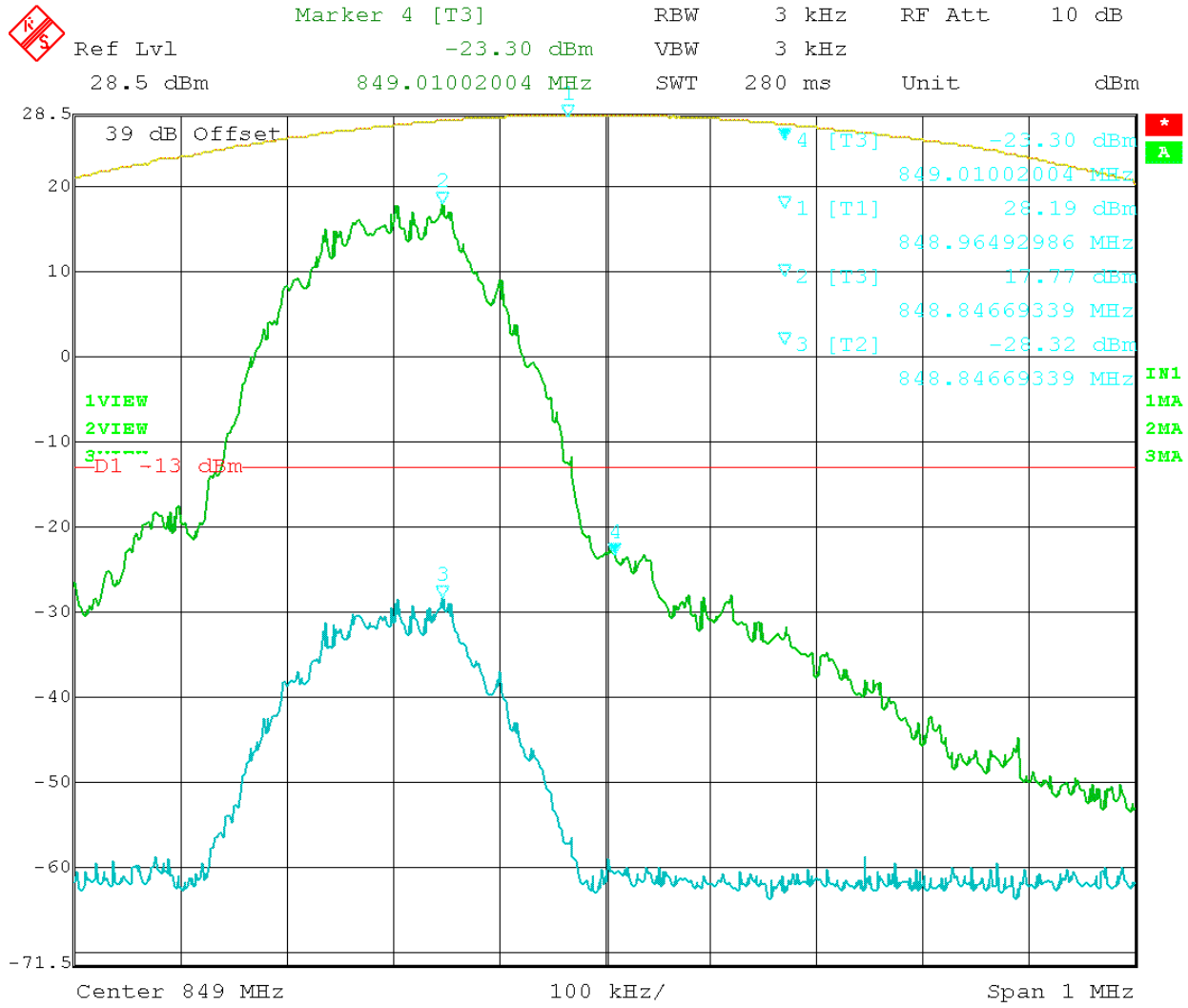

Date: 5.SEP.2008 11:07:18

Figure 18: EDGE - In vs. Out 848.80 MHz

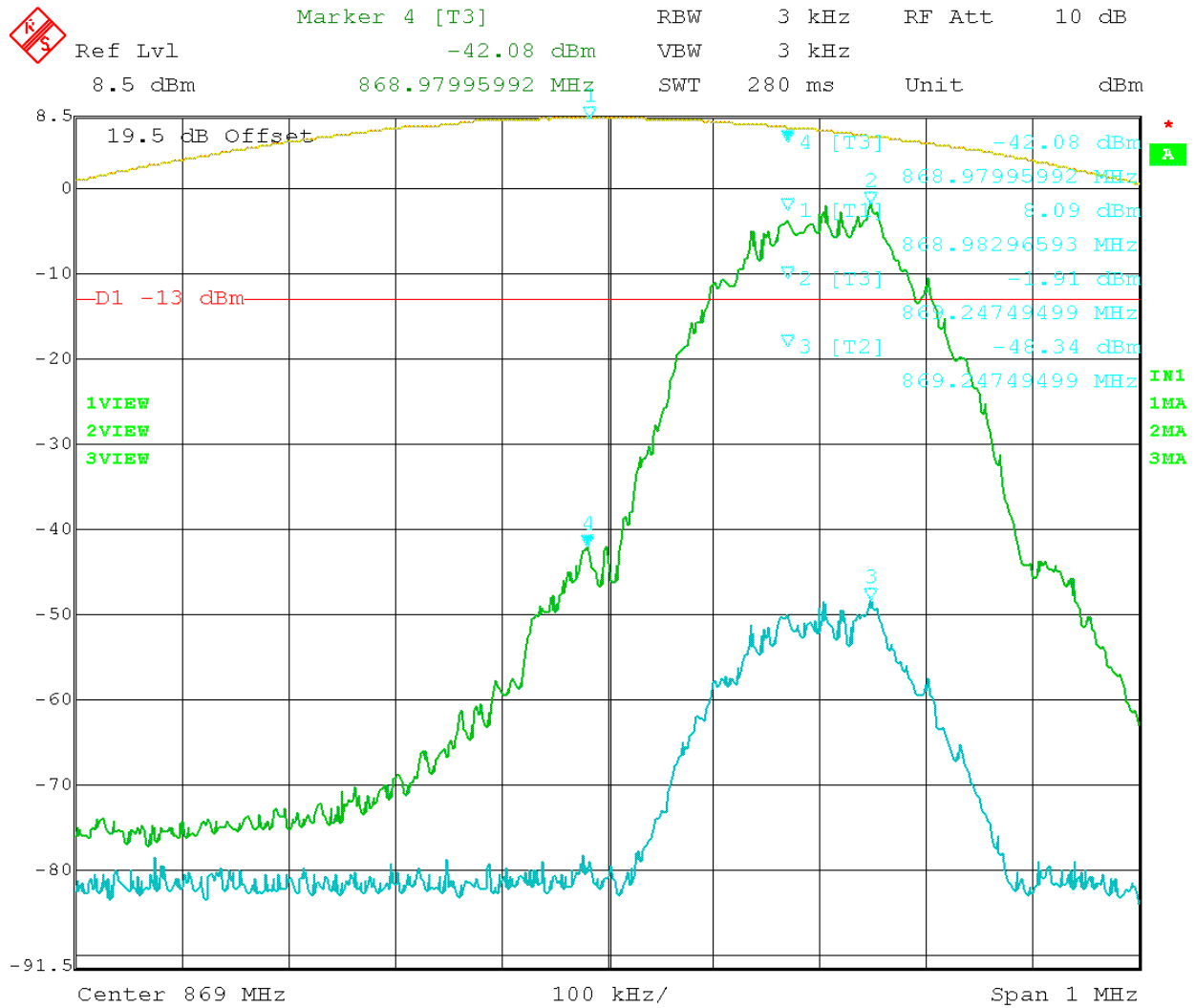

Date: 8.SEP.2008 09:20:06

Figure 19: EDGE – In vs. Out 869.20 MHz



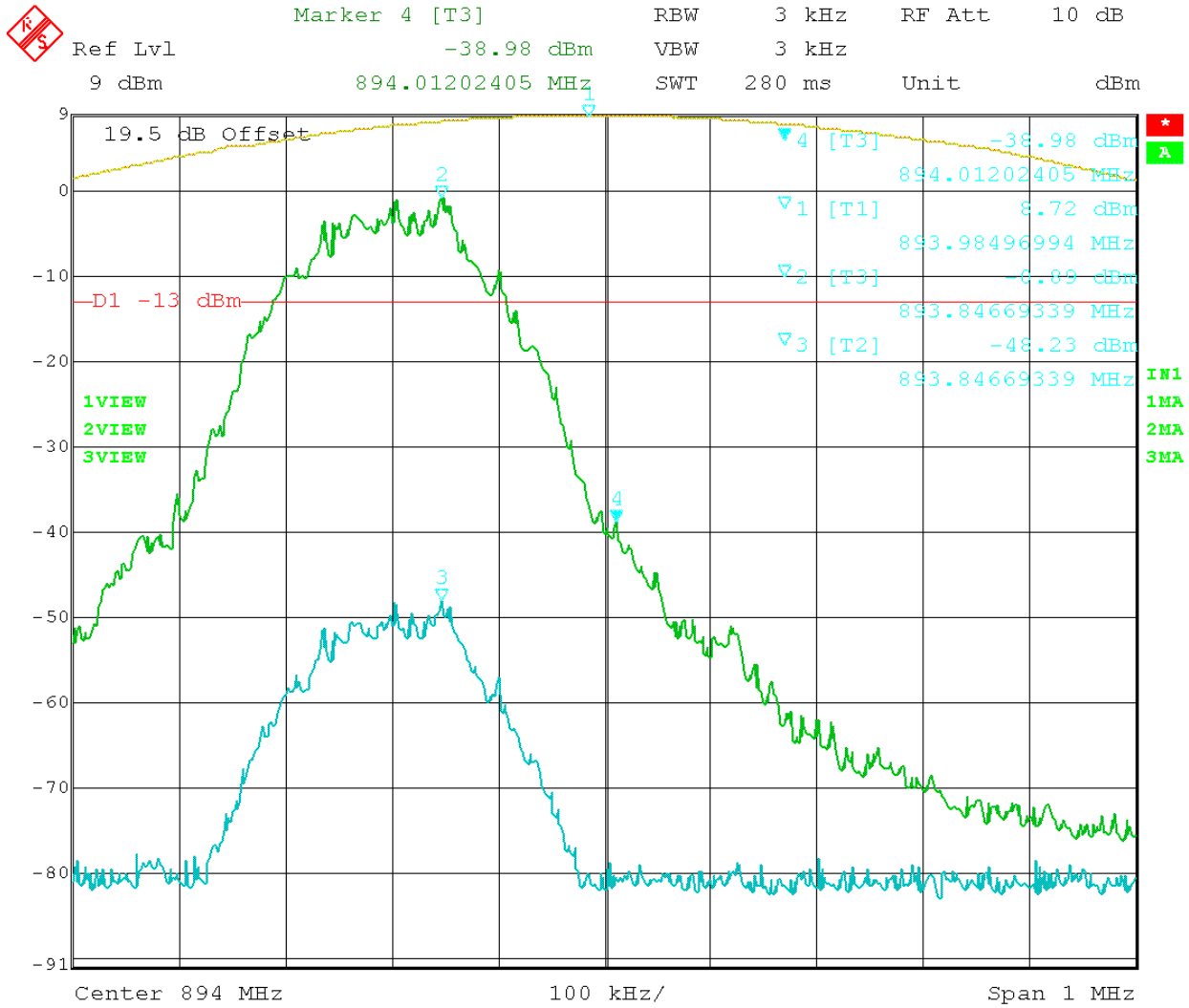

Date: 8.SEP.2008 09:33:14

Figure 20: EDGE - In vs. Out 893.80 MHz

Test Data Table 15 – GSM 800 – Uplink/Downlink

Channel (MHz)	Band-edge Frequency (MHz)	Amplitude level at the band-edge (dBm)	Limit (dBm)	Margin (dB)
824.2	823.98	-15.13	-13	2.13
848.8	849.02	-16.81	-13	3.81
869.2	868.98	-37.73	-13	24.73
893.8	894.02	-37.55	-13	24.55

The Reference level on the following plots was calibrated using a 3MHz RBW=VBW.

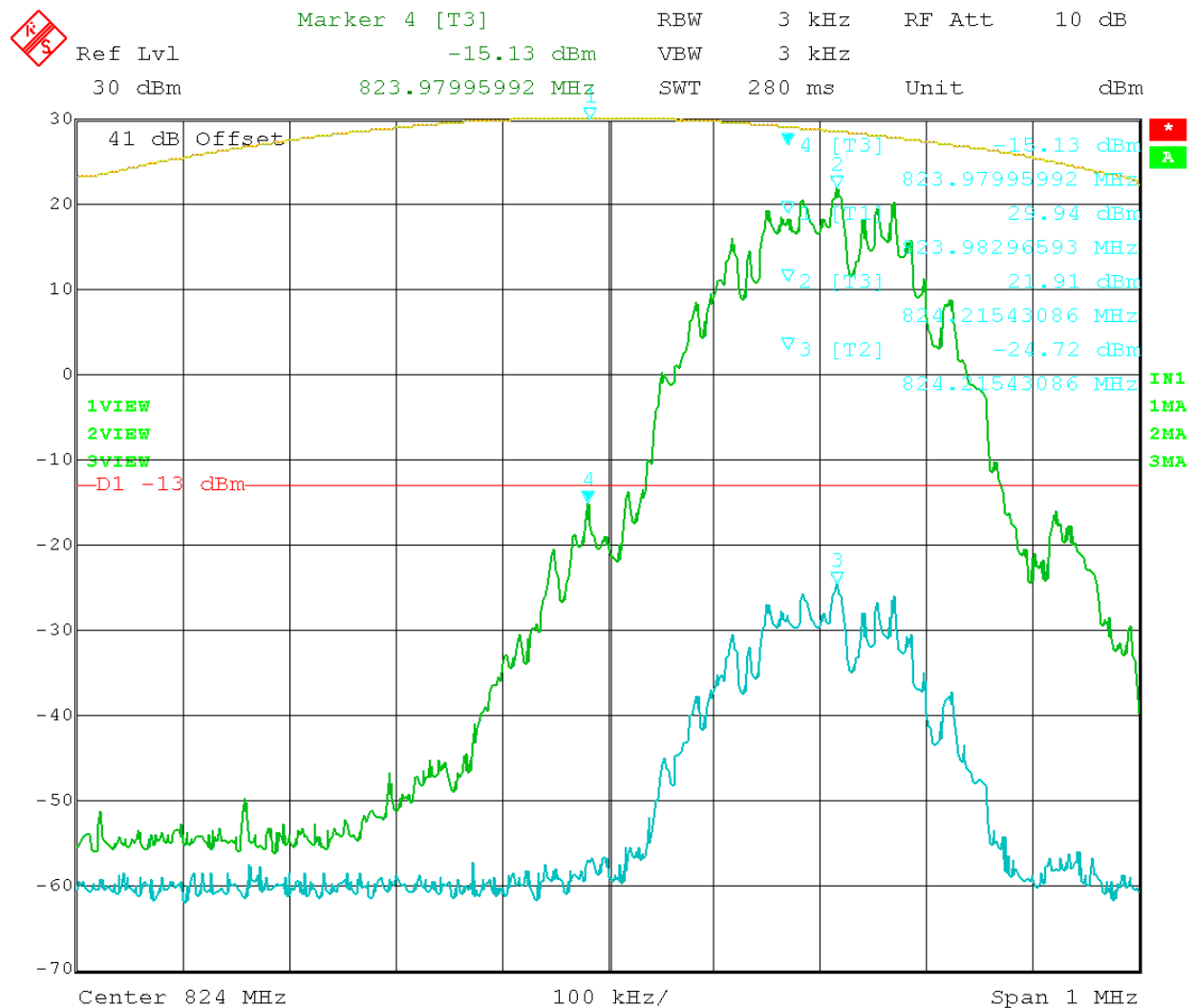

Date: 5.SEP.2008 09:16:25

Figure 21: GSM – In vs. Out 824.2 MHz



Ref Lvl 30 dBm  
 Marker 4 [T3] 849.02204409 MHz  
 RBW 3 kHz  
 RF Att 10 dB  
 VBW 3 kHz  
 SWT 280 ms  
 Unit dBm

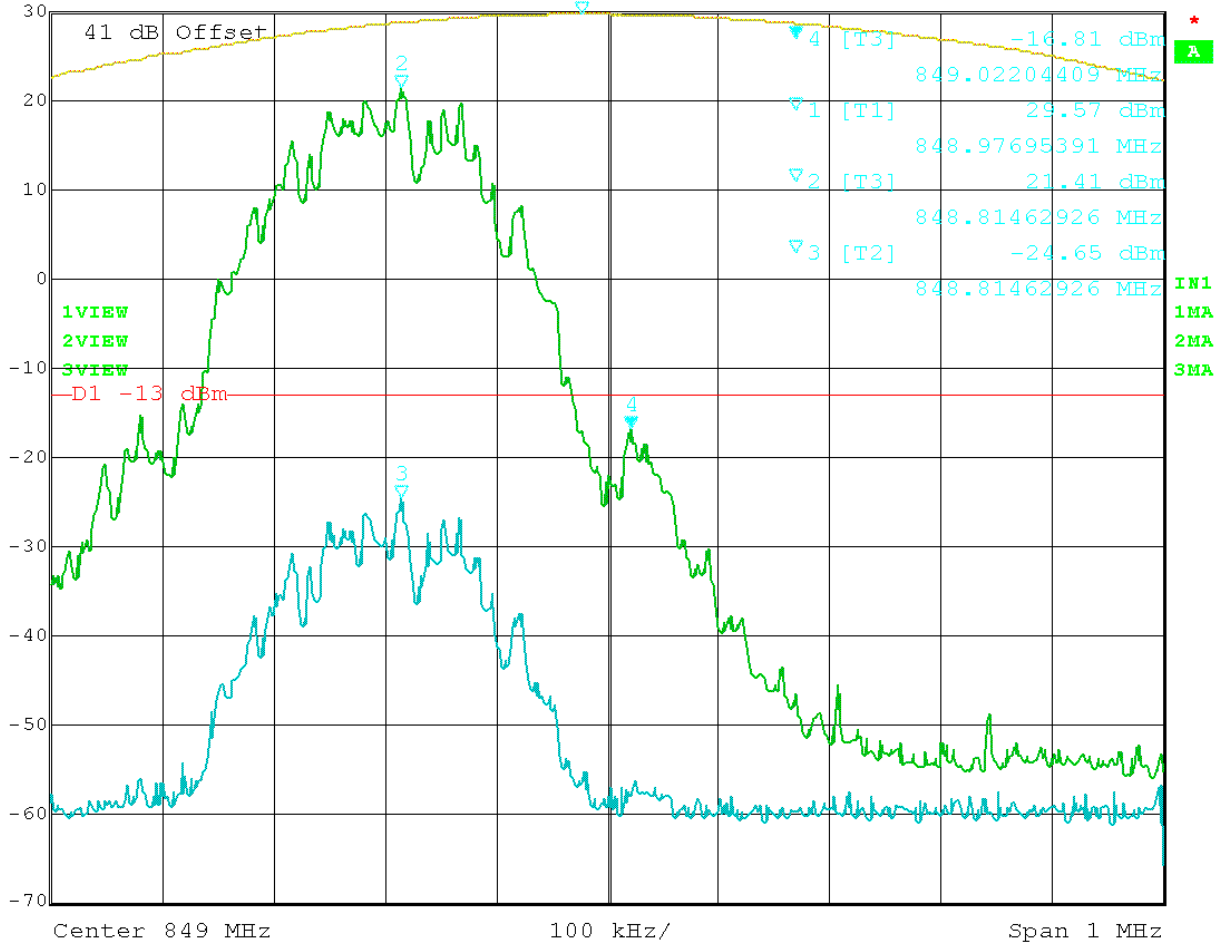

Date: 5.SEP.2008 09:27:40

Figure 22: GSM – In vs. Out 848.8 MHz

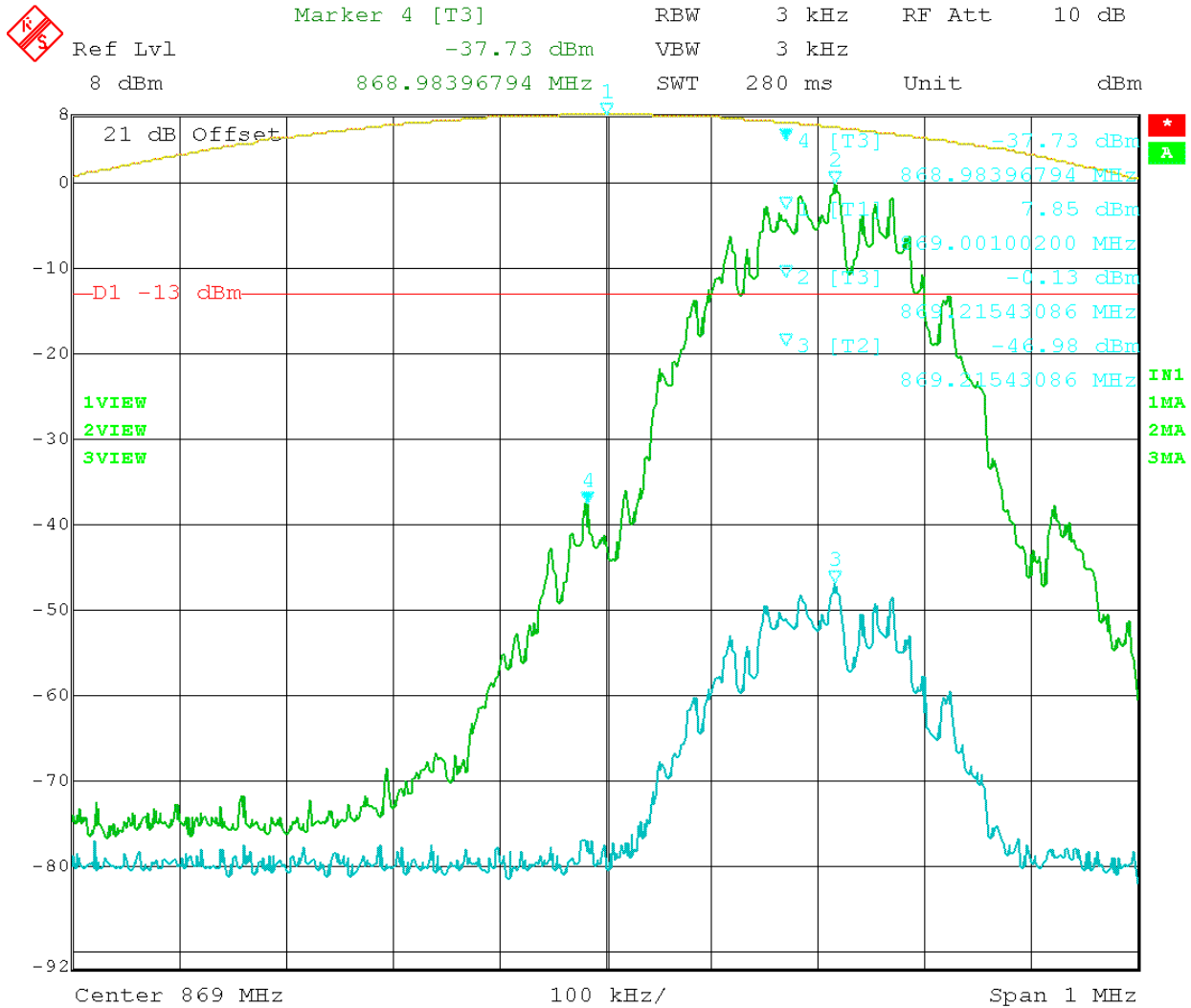

Date: 5.SEP.2008 15:46:41

Figure 23: GSM – In vs. Out 869.2MHz

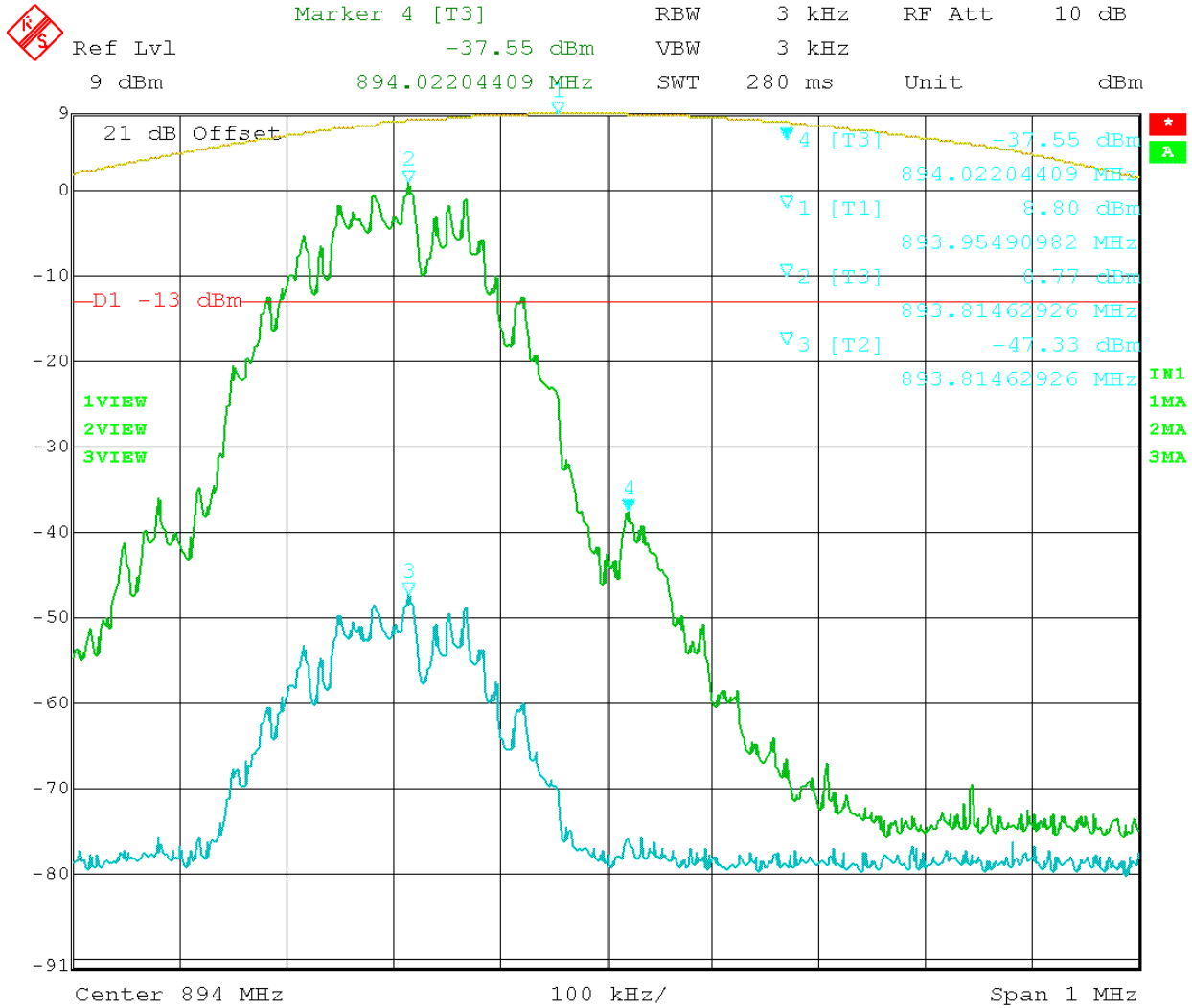

Date: 5.SEP.2008 15:34:02

Figure 24: GSM – In vs. Out 893.8MHz

Test Data Table 16 – AMPS 800 – Uplink/Downlink

Channel (MHz)	Band-edge Frequency (MHz)	Amplitude level at the band-edge (dBm)	Limit (dBm)	Margin (dB)
824.2	823.99	-47.30	-13	34.30
848.8	849.02	-46.70	-13	33.70
869.2	868.97	-70.72	-13	57.72
893.8	894.04	-70.32	-13	57.32

The Reference level on the following plots was calibrated using a 3MHz RBW=VBW.

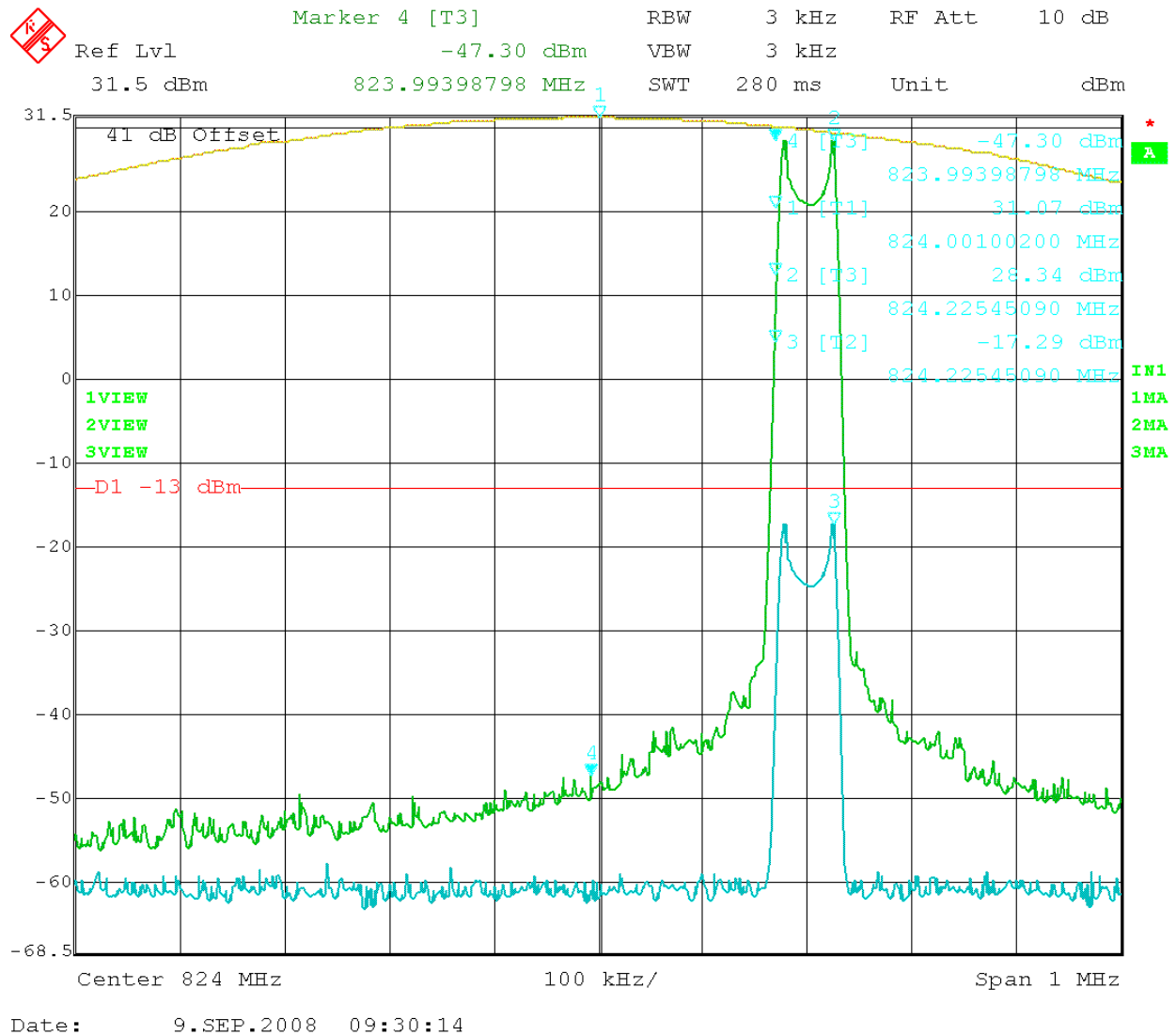
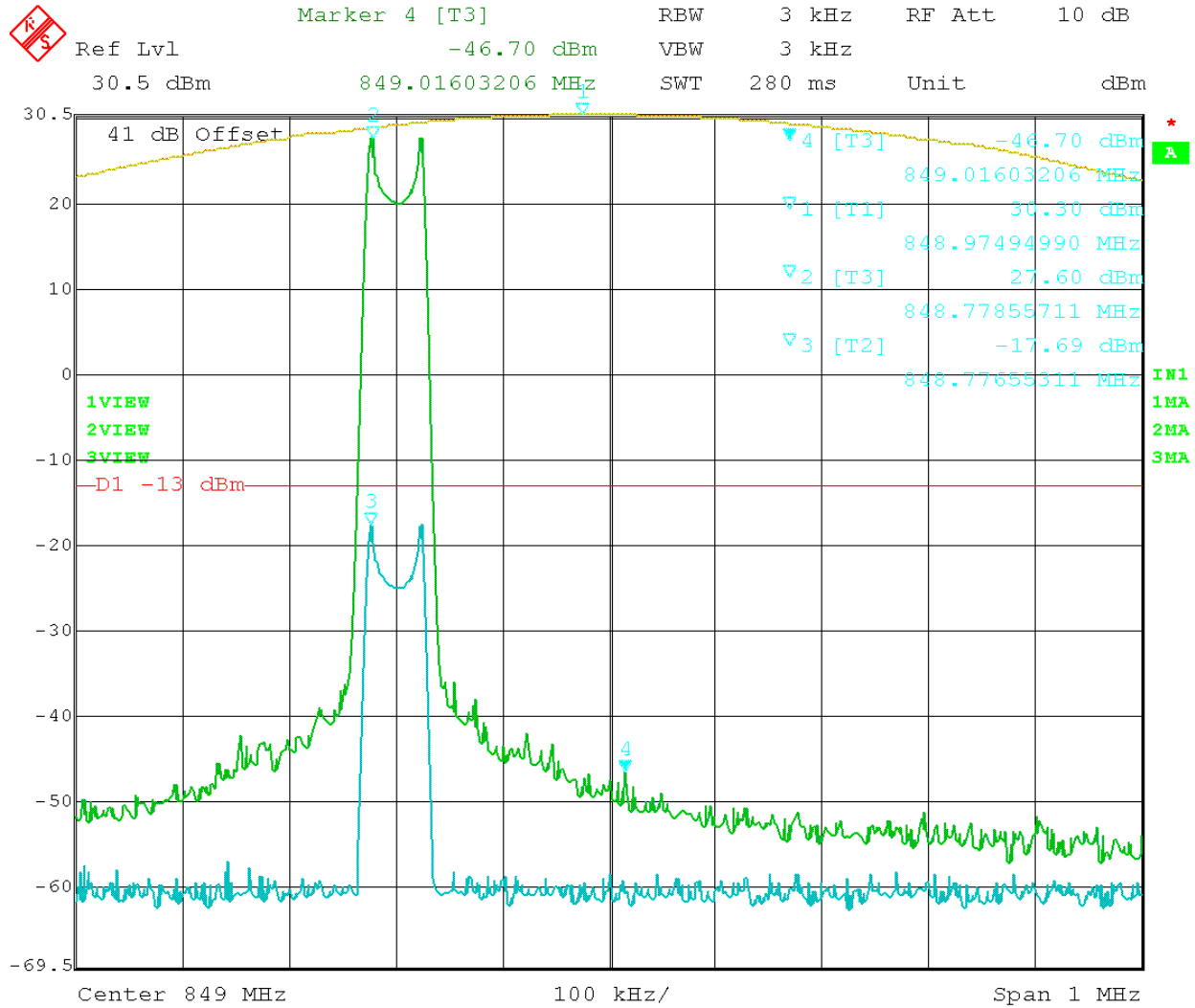
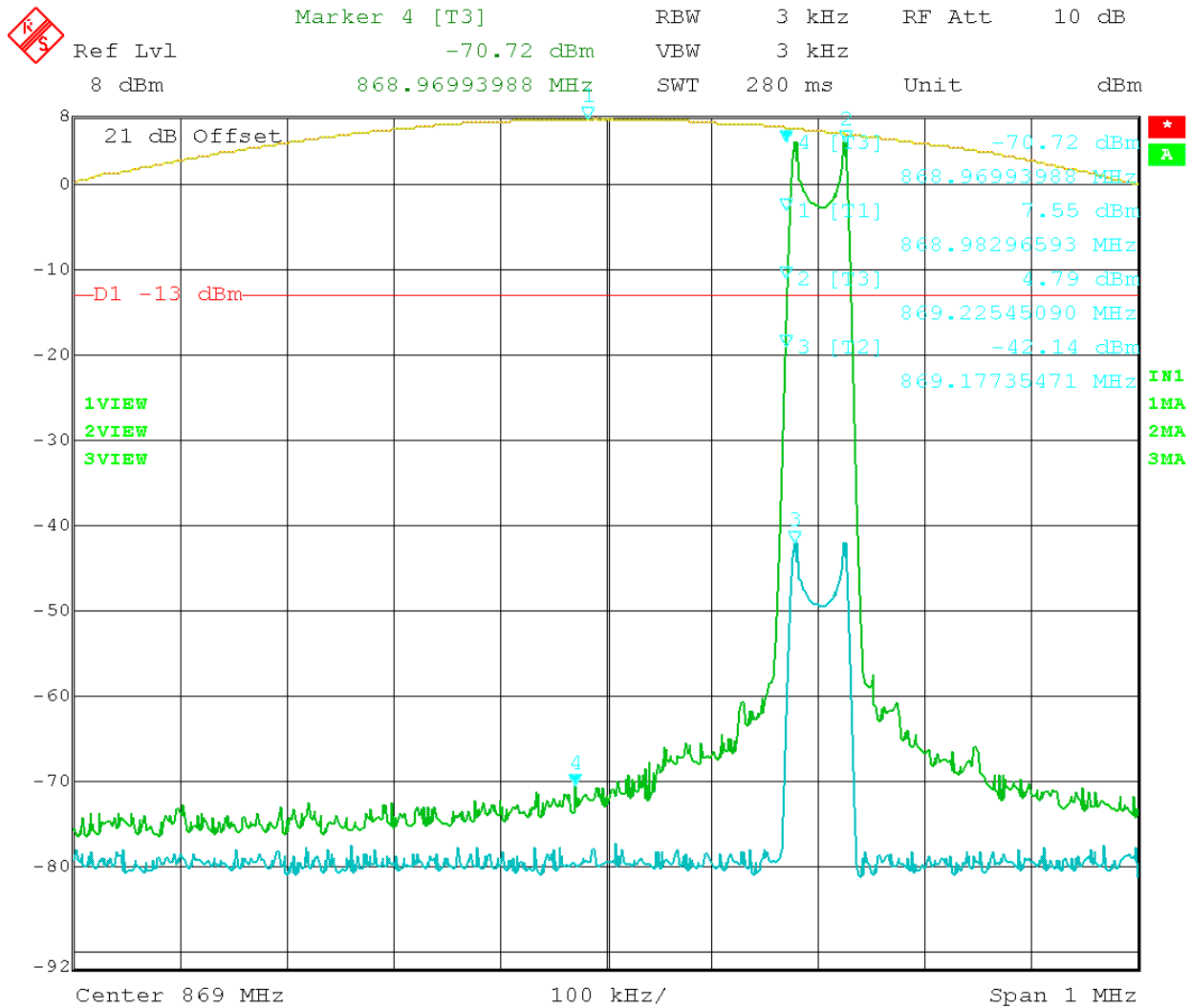

Figure 25: AMPS – In vs. Out 824.20 MHz



Date: 9.SEP.2008 09:23:24

Figure 26: AMPS – In vs. Out 848.80 MHz



Date: 9.SEP.2008 09:49:57

Figure 27: AMPS – In vs. Out 869.20 MHz



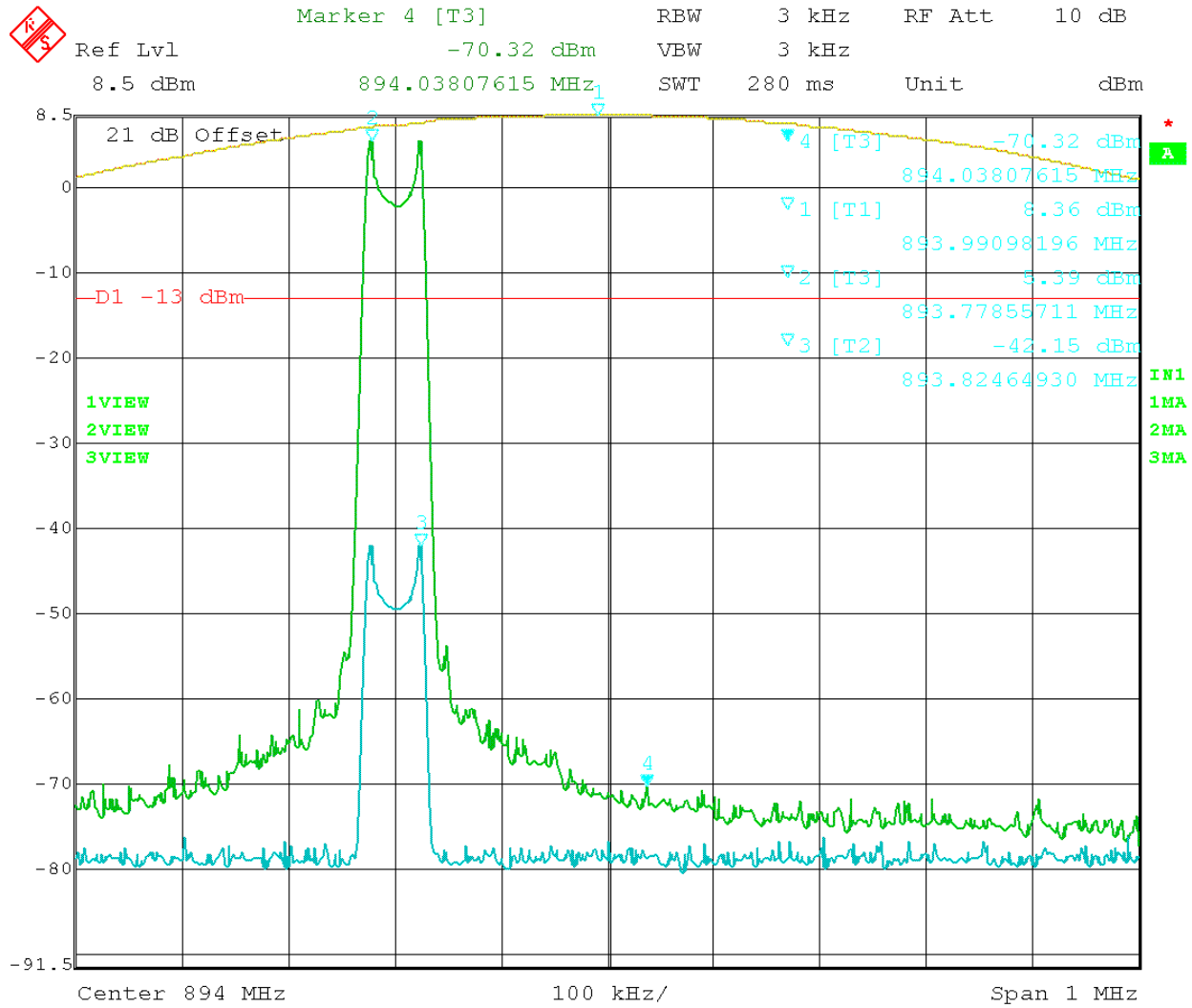

Date: 9.SEP.2008 09:57:43

Figure 28: AMPS – In vs. Out 893.80 MHz

## **INTERMODULATION PRODUCT SPURIOUS EMISSIONS**

Rule Parts No.: Pt 2.1051

**Requirements:** Emissions must be  $43 + 10 \log (P_o)$  dB below the mean power output of the transmitter or below the  $-13\text{dBm}$

All the modulation types were tested using the three tone test method. A CW signal was use instead of GSM, EDGE, and F1D modulations. EDGE and GSM provided the same test results and only GSM data are presented in this report. The input power to the amplifier was set at maximum drive level by combining the three tones. The three tones were chosen in such a way (1)the third order intermodulation product frequencies are located within the pass band of the DUT and (2) they produce the worst-case emissions out of band.

**Test Data:** The DUT appears to meet the requirements.

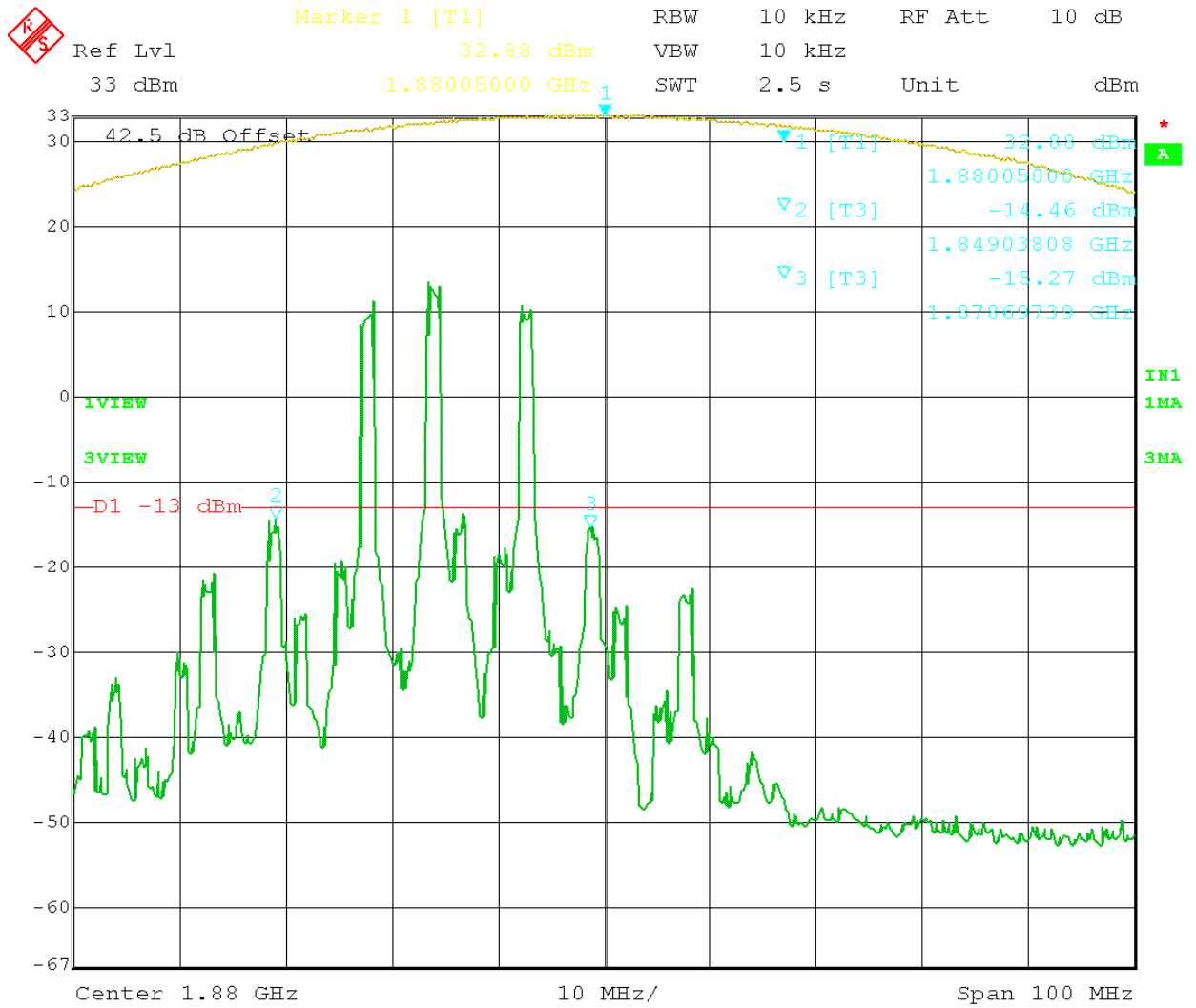

Date: 8.SEP.2008 14:09:44

Figure 29: CDMA 3 tones intermodulation - (1850 – 1910) MHz.

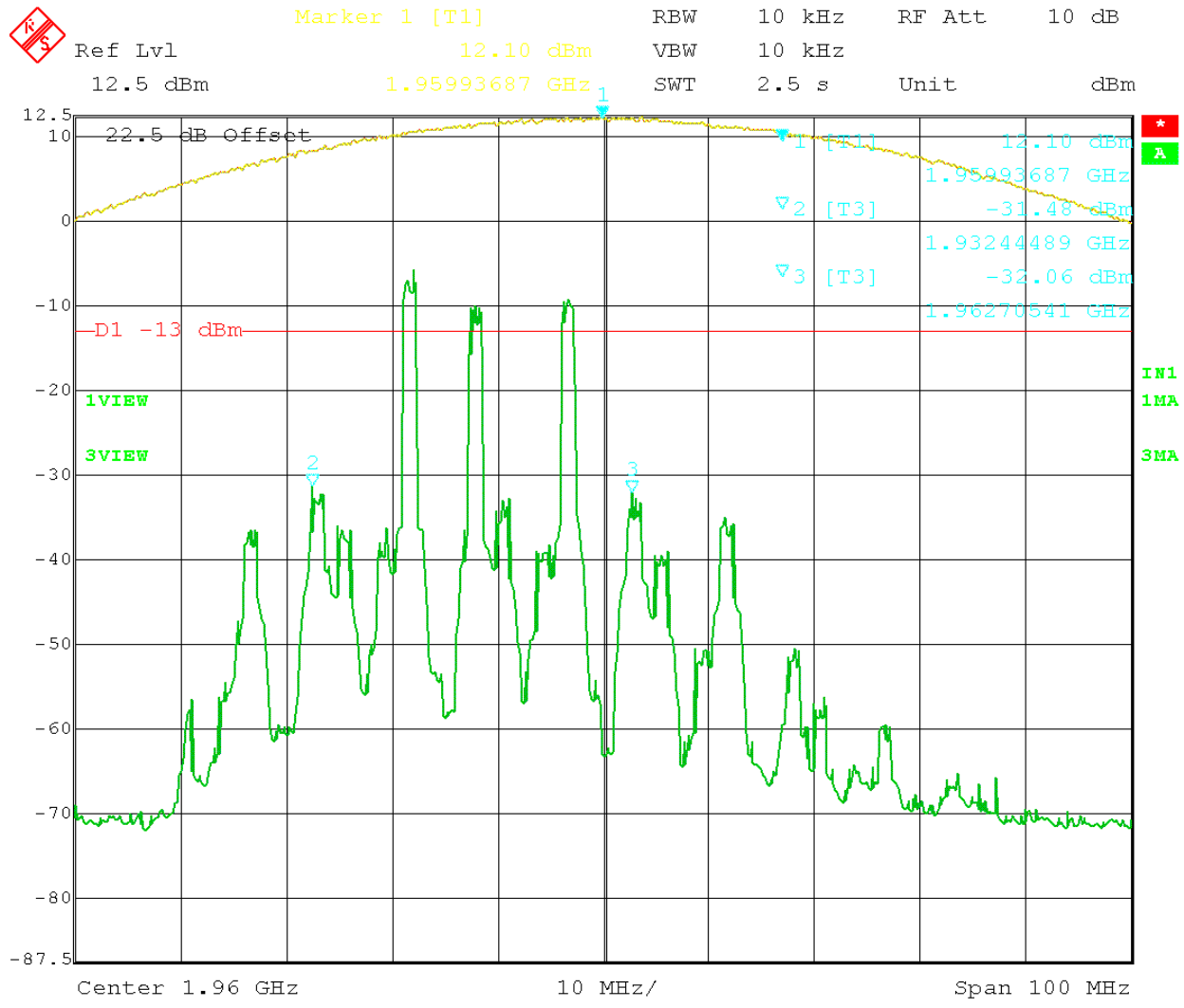

Date: 8.SEP.2008 14:37:07

Figure 30: CDMA 3 tones intermodulation - (1930 – 1990) MHz.

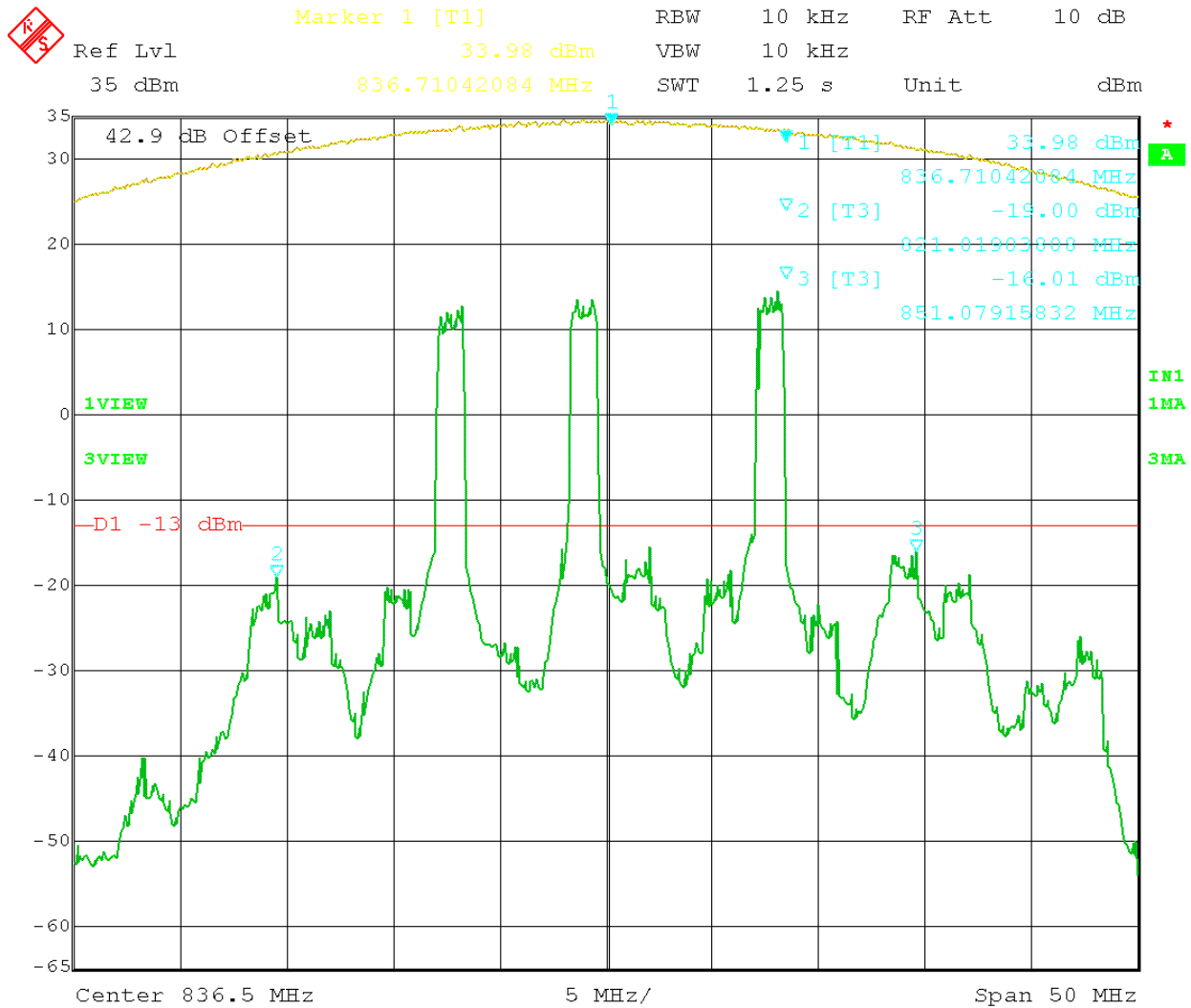

Date: 8.SEP.2008 13:47:46

Figure 31: CDMA 3 tones intermodulation – (824 – 849) MHz.

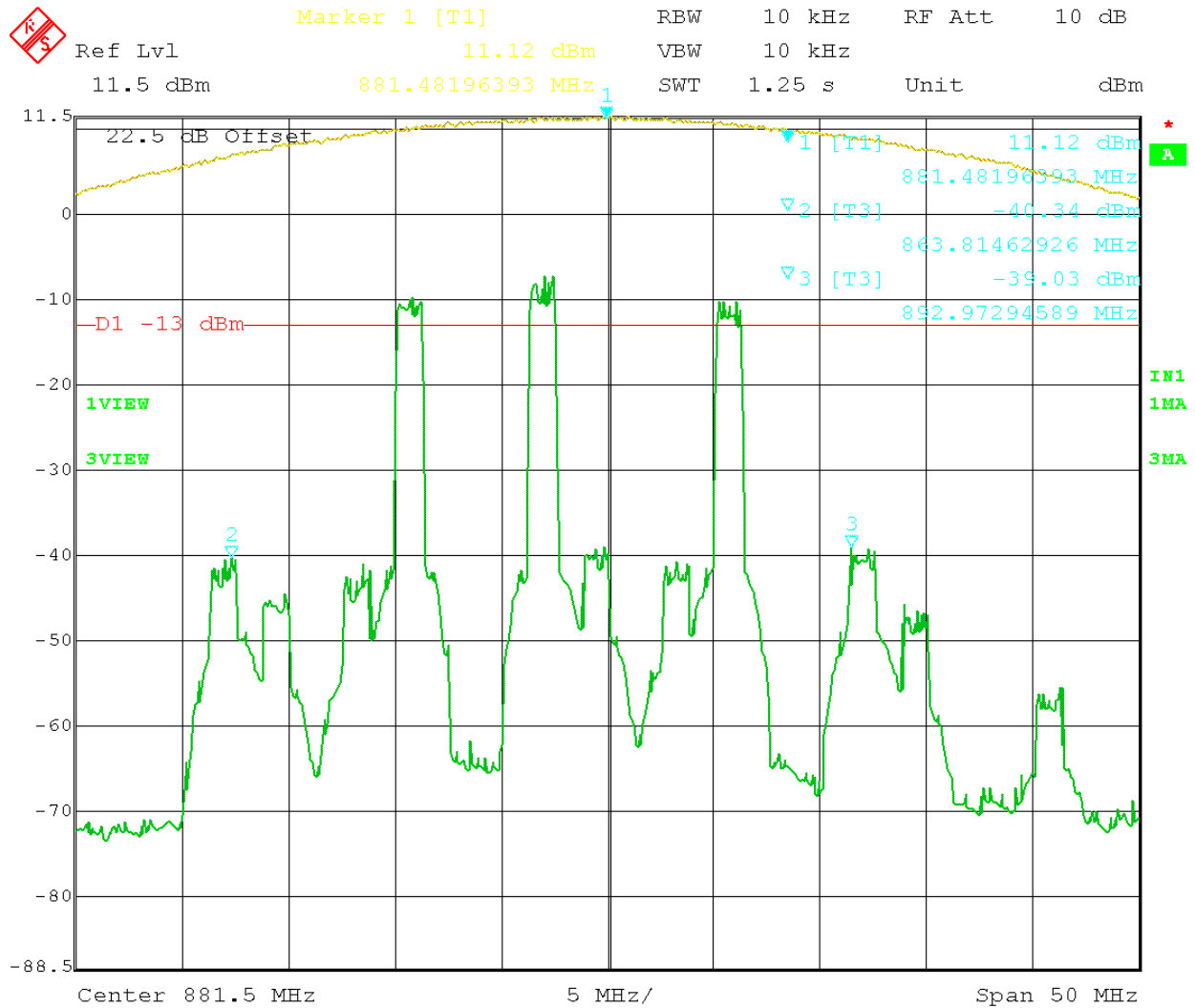

Date: 8.SEP.2008 14:29:09

Figure 32: CDMA 3 tones intermodulation - (869 – 894) MHz.

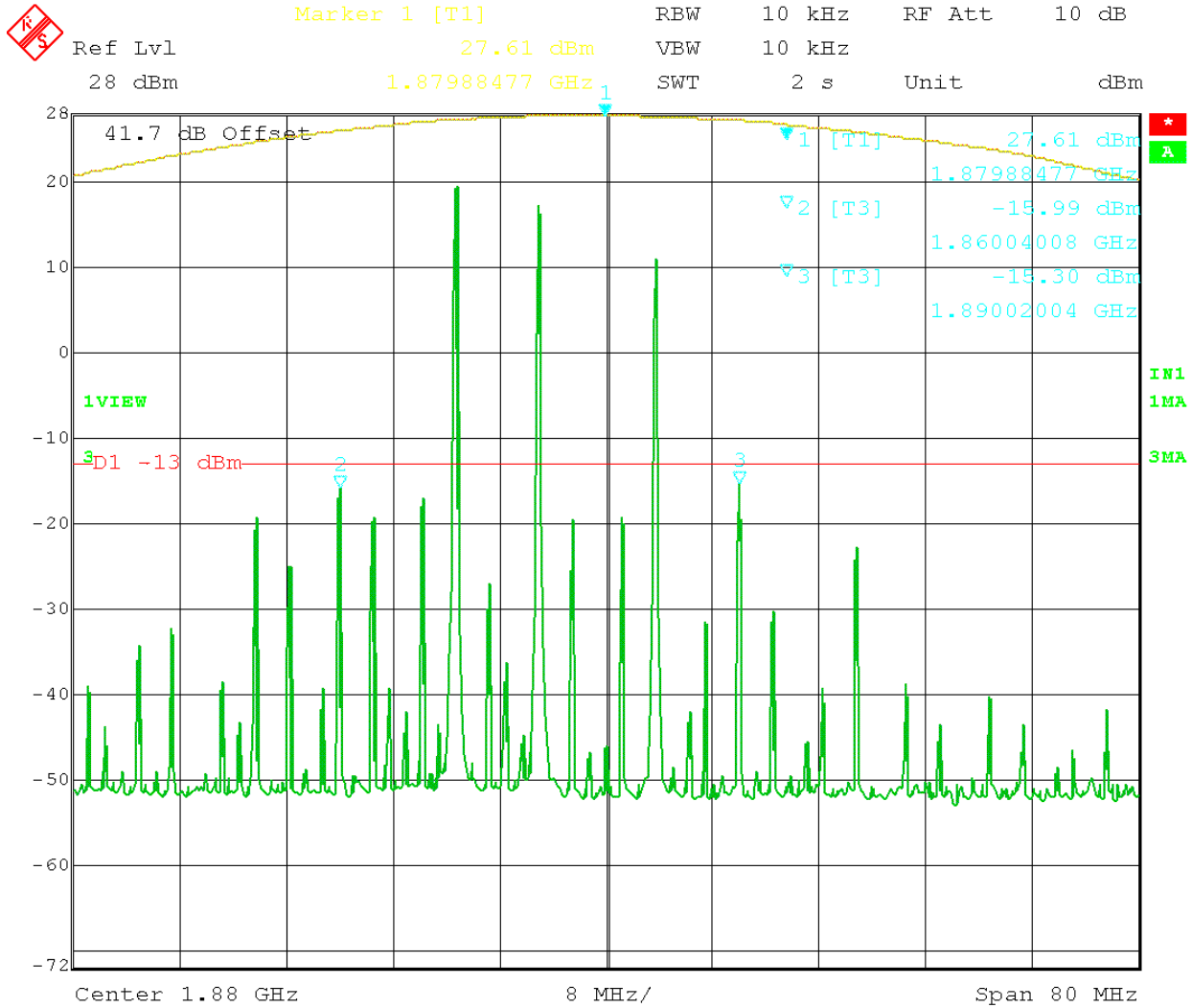

Date: 9.SEP.2008 13:39:27

Figure 33: GSM 3 tones intermodulation - (1850 – 1910) MHz

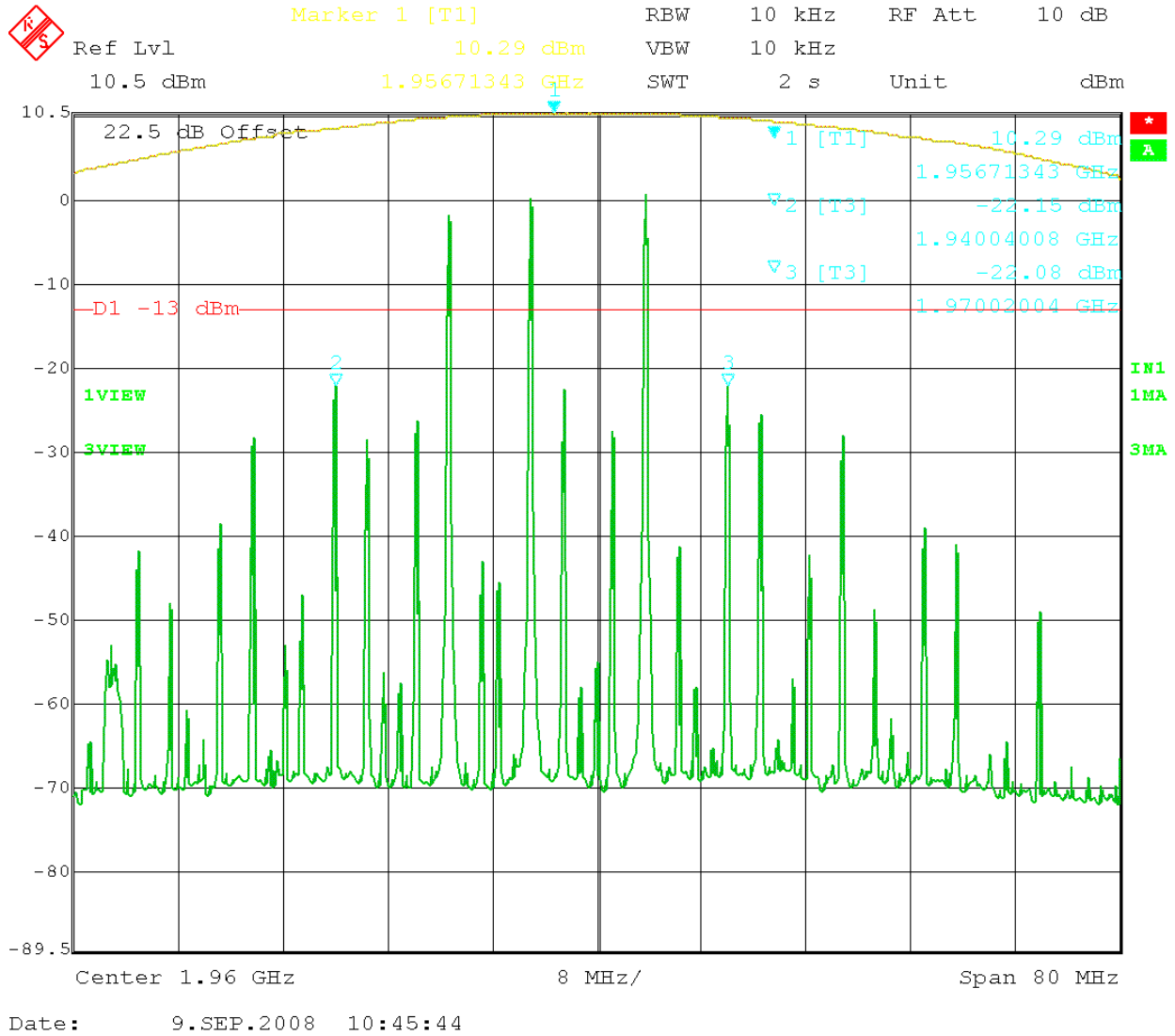
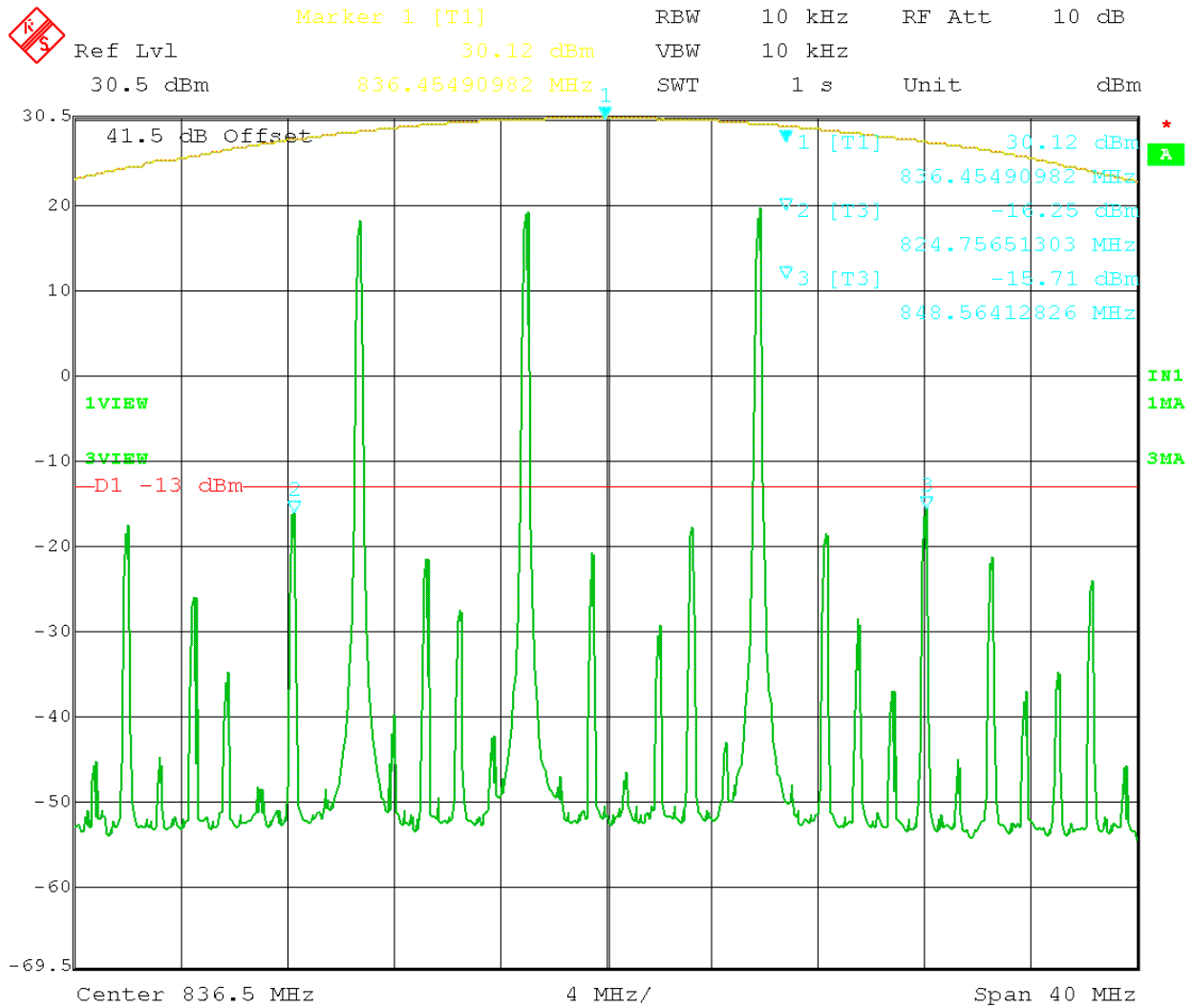

Figure 34: GSM 3 tones intermodulation - (1930 – 1990) MHz





Date: 9.SEP.2008 13:56:55

Figure 35: GSM 3 tones intermodulation - (824 – 849) MHz

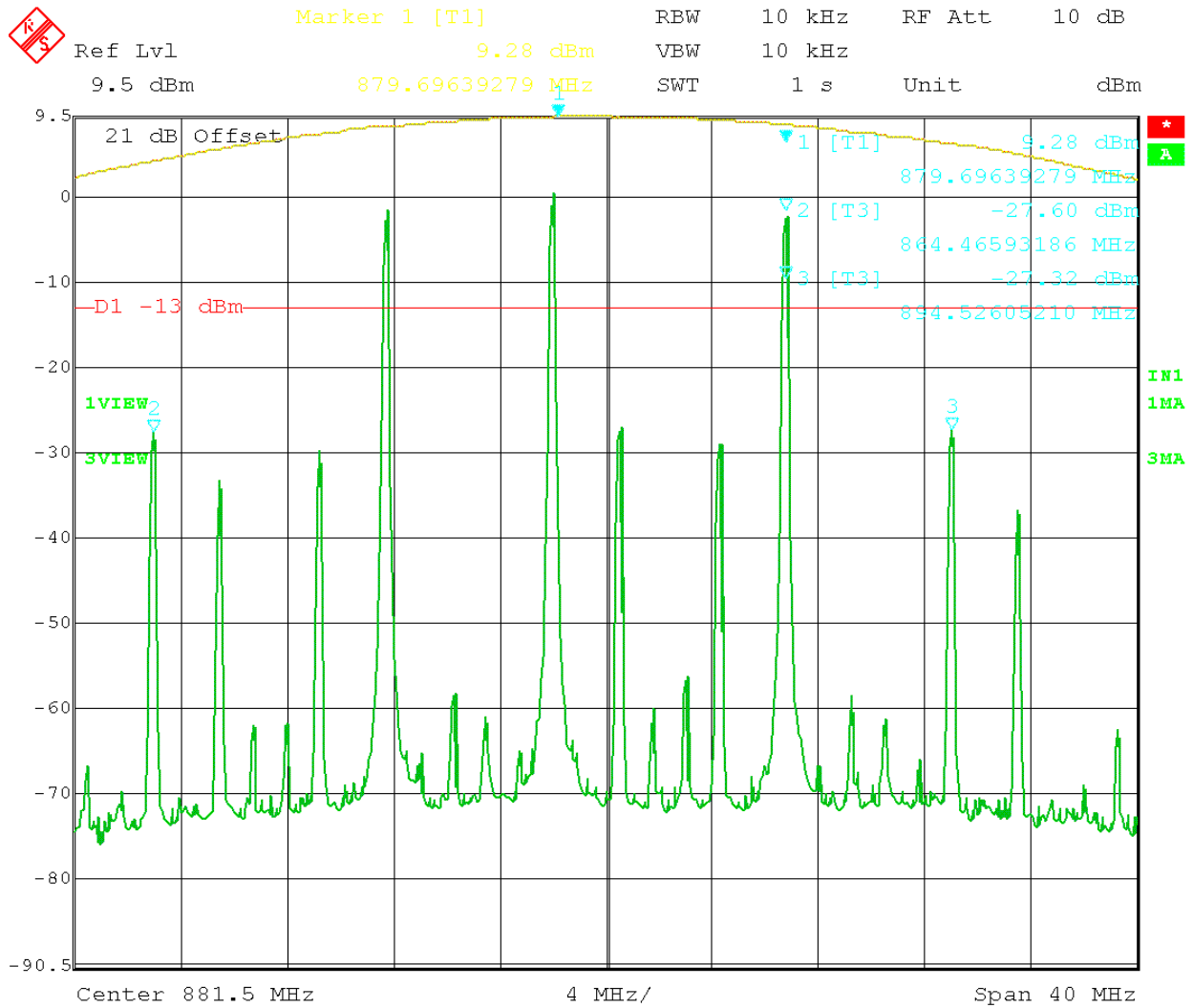

Date: 9.SEP.2008 10:38:25

Figure 36: GSM 3 tones intermodulation - (869 – 894) MHz

## SPURIOUS EMISSIONS AT ANTENNA TERMINALS

**Rule Parts No.:** Pt 2.1051

**Requirements:** Emissions must be  $43 + 10\log(P_o)$  dB below the mean power output of the transmitter:

$$1850 - 1910 \text{ MHz: } 43 + 10\log(1.00) = 43 \text{ dBc}$$

$$1930 - 1990: 43 + 10\log(0.03) = 28 \text{ dBc}$$

**Test Result:** The DUT appears to meet the requirements.

Test Data Table 17 – Conducted Emissions – CDMA 1900 – Uplink

Emission Frequency MHz	dB Below Carrier (dBc)	Emission Frequency MHz	dB Below Carrier (dBc)	Emission Frequency MHz	dB Below Carrier (dBc)
1851.25	0	1880.00	0	1908.75	0
3702.50	58.17	3760.00	49.80	3817.50	49.06
5553.75	80.22	5640.00	77.29	5726.25	76.05
7405.00	82.2	7520.00	82.51	7635.00	80.56
9256.25	83.6	9400.00	83.51	9543.75	81.58
11107.50	>62.0	11280.00	>62.0	11452.50	>62.0
12958.75	>62.0	13160.00	>62.0	13361.25	>62.0
14810.00	>62.0	15040.00	>62.0	15270.00	>62.0
16661.25	>62.0	16920.00	>62.0	17178.75	>62.0
18512.50	>62.0	18800.00	>62.0	19087.50	>62.0

Test Data Table 18 – Conducted Emissions – CDMA 1900 – Downlink

Emission Frequency MHz	dB Below Carrier (dBc)	Emission Frequency MHz	dB Below Carrier (dBc)	Emission Frequency MHz	DB Below Carrier (dBc)
1931.25	0	1960.00	0	1988.75	0
3862.50	45.06	3920.00	49.86	3977.50	52.49
5793.75	59.77	5880.00	60.7	5966.25	59.09
7725.00	60.45	7840.00	61.04	7955.00	60.04
9656.25	>60.0	9800.00	>60.0	9943.75	>60.0
11587.50	>60.0	11760.00	>60.0	11932.50	>60.0
13518.75	>60.0	13720.00	>60.0	13921.25	>60.0
15450.00	>60.0	15680.00	>60.0	15910.00	>60.0
17381.25	>60.0	17640.00	>60.0	17898.75	>60.0
19312.50	>60.0	19600.00	>60.0	19887.50	>60.0

Test Data Table 19 – Conducted Emissions – GSM 1900 - Uplink

Emission Frequency MHz	dB Below Carrier (dBc)	Emission Frequency MHz	dB Below Carrier (dBc)	Emission Frequency MHz	dB Below Carrier (dBc)
1850.20	0	1880.00	0	1909.80	0
3700.40	64.01	3760.00	59.93	3819.60	49.46
5550.60	83.91	5640.00	79.81	5729.40	77.24
7400.80	85.33	7520.00	84.29	7639.20	82.24
9251.00	86.76	9400.00	85.48	9549.00	82.46
11101.20	>58.0	11280.00	>58.0	11458.80	>58.0
12951.40	>58.0	13160.00	>58.0	13368.60	>58.0
14801.60	>58.0	15040.00	>58.0	15278.40	>58.0
16651.80	>58.0	16920.00	>58.0	17188.20	>58.0
18502.00	>58.0	18800.00	>58.0	19098.00	>58.0

Test Data Table 20 – Conducted Emissions – GSM 1900 - Downlink

Emission Frequency MHz	dB Below Carrier (dBc)	Emission Frequency MHz	dB Below Carrier (dBc)	Emission Frequency MHz	dB Below Carrier (dBc)
1930.20	0	1960.00	0	1989.80	0
3860.40	47.32	3920.00	49.37	3979.60	55.79
5790.60	63.65	5880.00	64.02	5969.40	64.22
7720.80	64.93	7840.00	65.73	7959.20	64.49
9651.00	>56.0	9800.00	>56.0	9949.00	>56.0
11581.20	>56.0	11760.00	>56.0	11938.80	>56.0
13511.40	>56.0	13720.00	>56.0	13928.60	>56.0
15441.60	>56.0	15680.00	>56.0	15918.40	>56.0
17371.80	>56.0	17640.00	>56.0	17908.20	>56.0
19302.00	>56.0	19600.00	>56.0	19898.00	>56.0

Test Data Table 21 – Conducted Emissions – CDMA 800 - Uplink

Emission Frequency MHz	dB Below Carrier (dBc)	Emission Frequency MHz	dB Below Carrier (dBc)	Emission Frequency MHz	dB Below Carrier (dBc)
825.25	0	836.50	0	847.75	0
1650.50	69.7	1673.00	70.85	1695.50	68.8
2475.75	52.37	2509.50	53.29	2543.25	55.62
3301.00	81.94	3346.00	81.86	3391.00	82.99
4126.25	77.24	4182.50	82.88	4238.75	83.42
4951.50	85.58	5019.00	78.62	5086.50	85.67
5776.75	85.16	5855.50	82.53	5934.25	83.48
6602.00	83.23	6692.00	82.23	6782.00	81.89
7427.25	85.84	7528.50	84.54	7629.75	82.56
8252.50	86.12	8365.00	85.98	8477.50	84.78

Test Data Table 22 – Conducted Emissions – CDMA 800 - Downlink

Emission Frequency MHz	dB Below Carrier (dBc)	Emission Frequency MHz	dB Below Carrier (dBc)	Emission Frequency MHz	dB Below Carrier (dBc)
870.25	0	881.50	0	892.75	0
1740.50	65.82	1763.00	66.3	1785.50	64.73
2610.75	65.54	2644.50	62.3	2678.25	65.15
3481.00	65.22	3526.00	64.46	3571.00	65.02
4351.25	>60.0	4407.50	64.11	4463.75	65.43
5221.50	>60.0	5289.00	>60.0	5356.50	>60.0
6091.75	>60.0	6170.50	>60.0	6249.25	>60.0
6962.00	>60.0	7052.00	>60.0	7142.00	>60.0
7832.25	>60.0	7933.50	>60.0	8034.75	>60.0
8702.50	>60.0	8815.00	>60.0	8927.50	>60.0

Test Data Table 23 – Conducted Emissions – GSM 800 – Uplink

Emission Frequency MHz	dB Below Carrier (dBc)	Emission Frequency MHz	dB Below Carrier (dBc)	Emission Frequency MHz	dB Below Carrier (dBc)
824.20	0	836.50	0	848.80	0
1648.40	74.37	1673.00	71.83	1697.60	73.04
2472.60	56.15	2509.50	57.51	2546.40	61.46
3296.80	80.87	3346.00	80.45	3395.20	83.02
4121.00	80.86	4182.50	85.48	4244.00	84.02
4945.20	85.29	5019.00	82.26	5092.80	87.36
5769.40	85.84	5855.50	85.25	5941.60	85.01
6593.60	84.2	6692.00	83.76	6790.40	83.43
7417.80	85.28	7528.50	85.93	7639.20	85.12
8242.00	86.39	8365.00	86.99	8488.00	86.5

Test Data Table 24 – Conducted Emissions – GSM 800 - Downlink

Emission Frequency MHz	dB Below Carrier (dBc)	Emission Frequency MHz	dB Below Carrier (dBc)	Emission Frequency MHz	dB Below Carrier (dBc)
869.20	0	881.50	0	893.80	0
1738.40	67.41	1763.00	68.79	1787.60	67.74
2607.60	67.22	2644.50	67.42	2681.40	67.77
3476.80	66.96	3526.00	68.77	3575.20	68.99
4346.00	>56.0	4407.50	>56.0	4469.00	>56.0
5215.20	>56.0	5289.00	>56.0	5362.80	>56.0
6084.40	>56.0	6170.50	>56.0	6256.60	>56.0
6953.60	>56.0	7052.00	>56.0	7150.40	>56.0
7822.80	>56.0	7933.50	>56.0	8044.20	>56.0
8692.00	>56.0	8815.00	>56.0	8938.00	>56.0

Test Data Table 25 – Conducted Emissions – AMPS 800 - Uplink

Emission Frequency MHz	dB Below Carrier (dBc)	Emission Frequency MHz	dB Below Carrier (dBc)	Emission Frequency MHz	dB Below Carrier (dBc)
824.20	0	836.50	0	848.80	0
1648.40	69.1	1673.00	67.75	1697.60	69.77
2472.60	52.63	2509.50	54.28	2546.40	57.79
3296.80	81.32	3346.00	83	3395.20	83.33
4121.00	78.21	4182.50	82.3	4244.00	80.73
4945.20	85.46	5019.00	79.91	5092.80	86.47
5769.40	85.47	5855.50	82.72	5941.60	82.99
6593.60	80.6	6692.00	80.16	6790.40	82.57
7417.80	84.48	7528.50	84.09	7639.20	83.76
8242.00	86.2	8365.00	87.65	8488.00	87.17

Test Data Table 26 – Conducted Emissions – AMPS 800 – Downlink

Emission Frequency MHz	dB Below Carrier (dBc)	Emission Frequency MHz	dB Below Carrier (dBc)	Emission Frequency MHz	dB Below Carrier (dBc)
869.20	0	881.50	0	893.80	0
1738.40	57.82	1763.00	59.21	1787.60	58.03
2607.60	57.5	2644.50	57.16	2681.40	58.59
3476.80	57.31	3526.00	59.3	3575.20	57.56
4346.00	>56.0	4407.50	>56.0	4469.00	>56.0
5215.20	>56.0	5289.00	>56.0	5362.80	>56.0
6084.40	>56.0	6170.50	>56.0	6256.60	>56.0
6953.60	>56.0	7052.00	>56.0	7150.40	>56.0
7822.80	>56.0	7933.50	>56.0	8044.20	>56.0
8692.00	>56.0	8815.00	>56.0	8938.00	>56.0

### OUT OF BAND REJECTION: FREQUENCY RESPONSE

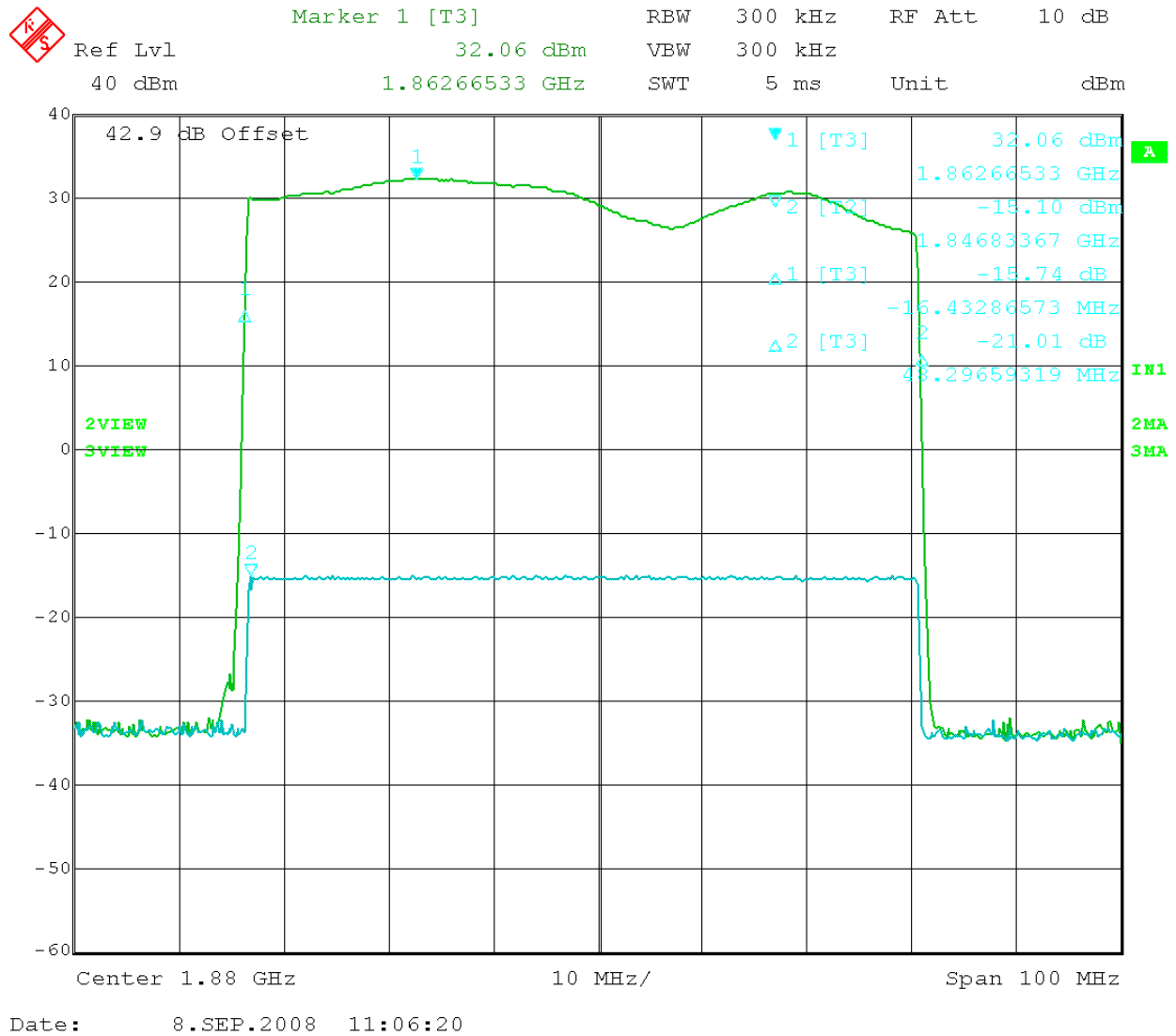
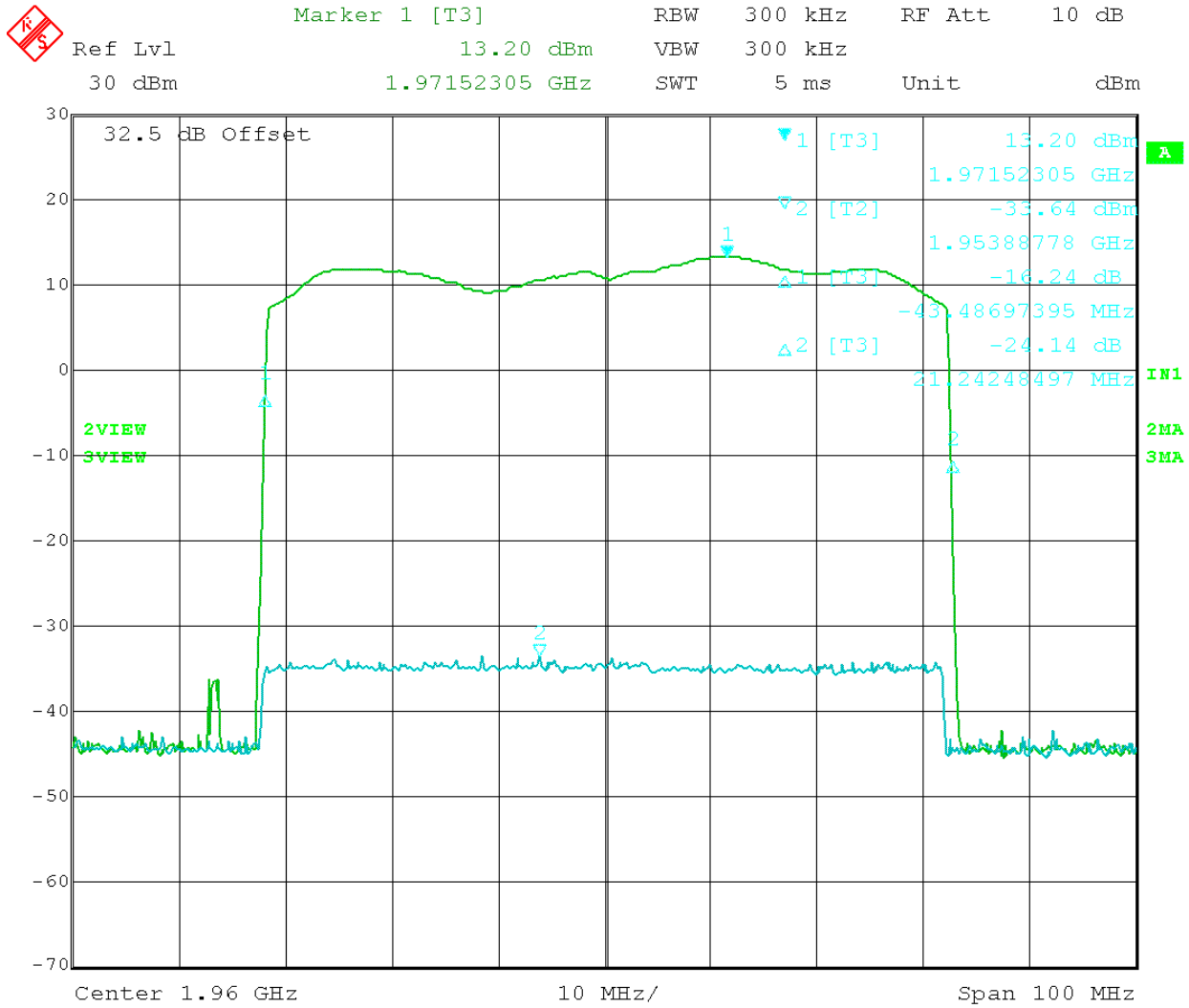

Figure 37. Amplifier frequency response (1850 – 1910) MHz band



Date: 8.SEP.2008 10:08:24

Figure 38. Amplifier frequency response (1930 – 1990) MHz band



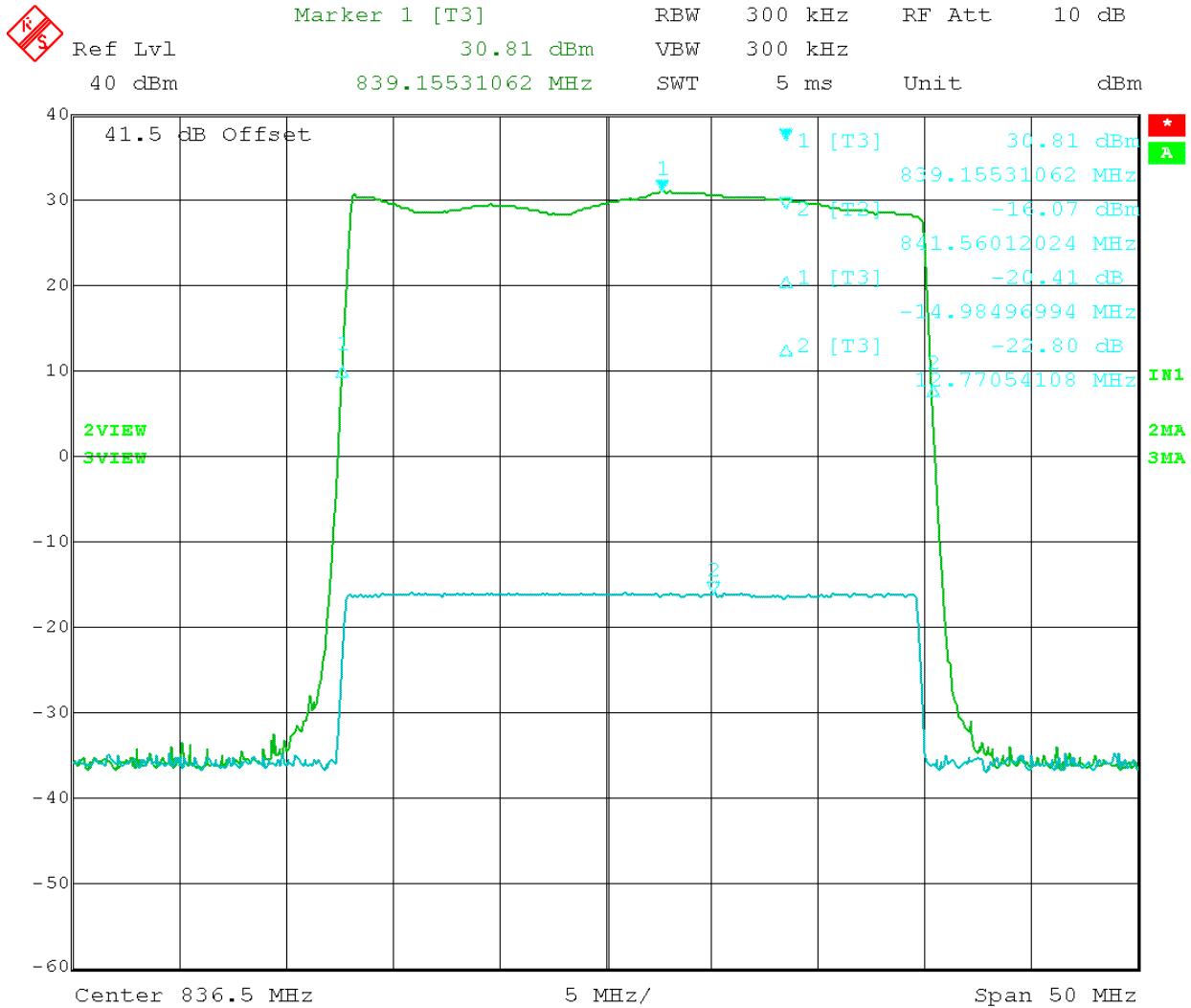
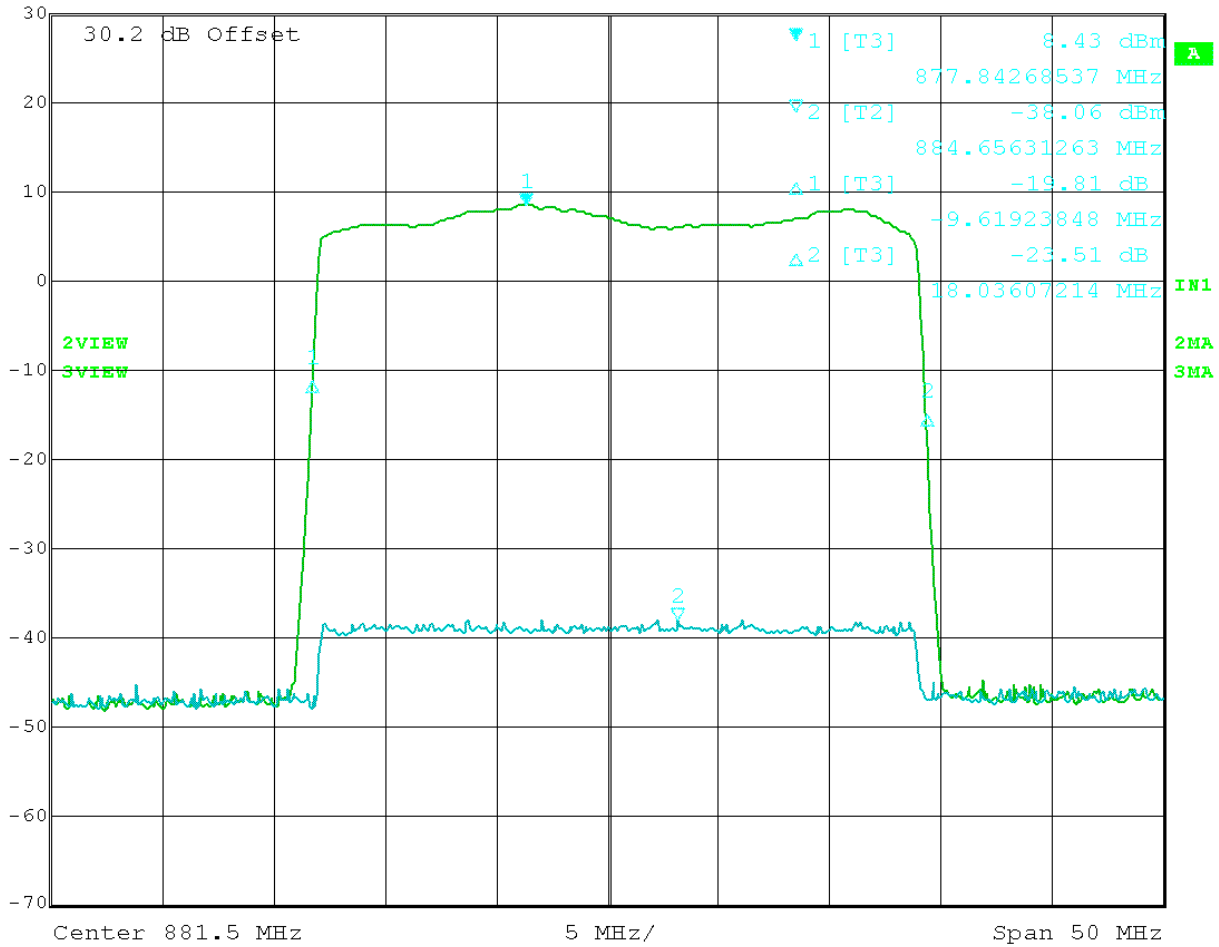

Figure 39. Amplifier frequency response (824 – 849) MHz band



Marker 1 [T3] RBW 300 kHz RF Att 10 dB  
 Ref Lvl 8.43 dBm VBW 300 kHz  
 30 dBm 877.84268537 MHz SWT 5 ms Unit dBm



Date: 8.SEP.2008 10:21:22

Figure 40. amplifier frequency response (969 – 894) MHz band

## FIELD STRENGTH OF SPURIOUS EMISSIONS

**Rule Parts No.:** Pt 2.1053

**Requirements:** Emissions must be  $43 + 10\log(P_o)$  dB below the mean power output of the amplifier:

$$43 + 10\log(1.00) = 43 \text{ dB}$$

$$43 + 10\log(0.032) = 28 \text{ dB}$$

**Test Result:** The test data indicates the DUT meets the requirements

Test Data Table 27 – Radiated Emissions - CW

Emission Frequency (MHz)	Ant. Polarity (V/H)	Corrected DUT Signal Reading	Coax Loss (dB)	Substitution Antenna (dBd)	dB Below Carrier (dBc)
1880.00			0	0	0
3760.00	V	-55.40	1.43	7.55	79.28
5640.00	V	-59.80	1.75	8.55	83.00
7520.00	V	-57.30	2.06	8.69	80.67
9400.00	V/H	*	*	*	*
11280.00	V/H	*	*	*	*
13160.00	V/H	*	*	*	*
15040.00	V/H	*	*	*	*
16920.00	V/H	*	*	*	*
18800.00	V/H	*	*	*	*

[Continued]

Test Data Table 28 – Radiated Emissions - CW

Emission Frequency (MHz)	Ant. Polarity (V/H)	Corrected DUT Signal Reading	Coax Loss (dB)	Substitution Antenna (dBd)	dB Below Carrier (dBc)
836.50			0	0	0
1673.00	V	-48.00	1.10	5.13	73.97
2509.50	V	-52.20	1.25	7.00	76.45
3346.00	V	-54.20	1.40	7.55	78.05
4182.50	V	-59.80	1.55	8.32	83.03
5019.00	V	-57.30	1.70	8.20	80.80
5855.50	V	-54.70	1.85	8.89	77.67
6692.00	V	-58.90	2.00	7.82	83.08
7528.50	V	-57.40	2.16	7.52	82.04
8365.00	V	-55.80	2.31	8.65	79.46

Notes: \*No other emissions were found up to the 10<sup>th</sup> harmonics - NOISE FLOOR

Test Data Table 29 – Radiated Emissions - CW

Emission Frequency (MHz)	Ant. Polarity (V/H)	Corrected DUT Signal Reading	Coax Loss (dB)	Substitution Antenna (dBd)	dB Below Carrier (dBc)
1960.00			0	0	0
3920.00	V	-55.40	1.46	7.55	79.28
5880.00	V	-59.80	1.79	8.88	83.00
7840.00	V	-57.30	2.06	8.69	80.67
9800.00	V/H	*	*	*	*
11760.00	V/H	*	*	*	*
13720.00	V/H	*	*	*	*
15680.00	V/H	*	*	*	*
17640.00	V/H	*	*	*	*
19600.00	V/H	*	*	*	*

[Continued]

Test Data Table 30 – Radiated Emissions – CW

Emission Frequency (MHz)	Ant. Polarity (V/H)	Corrected DUT Signal Reading	Coax Loss (dB)	Substitution Antenna (dBd)	dB Below Carrier (dBc)
881.50			0	0	0
1763.00	V	-65.20	1.10	5.13	76.17
2644.50	V	-61.70	1.25	7.00	70.95
3526.00	V	-60.10	1.40	7.55	68.95
4407.50	V	*	*	*	*
5289.00	V	*	*	*	*
6170.50	V	*	*	*	*
7052.00	V	*	*	*	*
7933.50	V	*	*	*	*
8815.00	V	*	*	*	*

Notes: \*No other emissions were found up to the 10<sup>th</sup> harmonics - NOISE FLOOR

Test Data Table 31 – Radiated Emissions – 30 ~ 1000 MHz

Emission Frequency MHz	Meter Reading dBuV	Ant. Polarity H/V	Coax Loss dB	Correction Factor dB	Field Strength dBuV/m	Margin dB
33.90	14.3	V	0.42	10.65	25.37	14.63
43.60	16.1	H	0.47	10.80	27.37	12.63
43.80	27.2	V	0.47	10.20	37.87	2.13
47.30	28.9	V	0.49	10.53	39.92	0.08
47.70	15.3	H	0.49	10.85	26.64	13.36
55.20	21.6	V	0.52	11.08	33.20	6.80
55.80	10.3	H	0.52	10.98	21.80	18.20
61.80	15.9	V	0.54	10.03	26.47	13.53
63.70	9.0	H	0.55	10.16	19.71	20.29
88.70	14.7	V	0.62	8.81	24.13	19.37
91.50	11.3	H	0.63	8.49	20.42	23.08
106.50	13.1	V	0.66	12.76	26.52	16.98
107.90	10.4	H	0.66	12.41	23.47	20.03
157.20	8.0	H	0.73	13.73	22.46	21.04
188.30	6.7	H	0.85	17.16	24.71	18.79
201.80	5.4	H	0.90	12.06	18.36	25.14
205.60	6.6	V	0.91	11.70	19.21	24.29
343.20	4.8	V	1.14	14.60	20.54	25.46
381.50	4.5	H	1.18	15.46	21.14	24.86
419.60	6.8	H	1.22	16.20	24.22	21.78
448.20	5.8	V	1.25	16.55	23.60	22.40