

APPLICATION CERTIFICATION FCC Part 15C
On Behalf of
HONG KONG NATURAL SOUND ELECTRONICS LIMITED

MID
Model No.: PC4311BXB, Trio Stealth Mini, Trio MINI

FCC ID: PWK-PC4311BXB

Prepared for : HONG KONG NATURAL SOUND ELECTRONICS
LIMITED
Address : FLAT/RM M 4/F CONTINENTAL MANSION 300
KING' S ROAD HONG KONG
Prepared by : ACCURATE TECHNOLOGY CO., LTD
Address : F1, Bldg. A, Chan Yuan New Material Port, Keyuan
Rd. Science & Industry Park, Nan Shan, Shenzhen,
Guangdong P.R. China

Tel: (0755) 26503290
Fax: (0755) 26503396

Report Number : ATE20141486
Date of Test : July 30, 2014 - Aug 06, 2014
Date of Report : Aug 06, 2014

TABLE OF CONTENTS

Description	Page
Test Report Certification	
1. GENERAL INFORMATION	5
1.1. Description of Device (EUT).....	5
1.2. Carrier Frequency of Channels.....	6
1.3. Special Accessory and Auxiliary Equipment	6
1.4. Description of Test Facility	7
1.5. Measurement Uncertainty.....	7
2. MEASURING DEVICE AND TEST EQUIPMENT	8
3. OPERATION OF EUT DURING TESTING	9
3.1. Operating Mode.....	9
3.2. Configuration and peripherals	9
4. TEST PROCEDURES AND RESULTS	10
5. POWER LINE CONDUCTED MEASUREMENT	11
5.1. Block Diagram of Test Setup.....	11
5.2. Power Line Conducted Emission Measurement Limits.....	11
5.3. Configuration of EUT on Measurement	11
5.4. Operating Condition of EUT	11
5.5. Test Procedure	12
5.6. Power Line Conducted Emission Measurement Results	13
6. 6DB BANDWIDTH MEASUREMENT	16
6.1. Block Diagram of Test Setup.....	16
6.2. The Requirement For Section 15.247(a)(2).....	16
6.3. EUT Configuration on Measurement	16
6.4. Operating Condition of EUT	16
6.5. Test Procedure	17
6.6. Test Result	17
7. MAXIMUM PEAK OUTPUT POWER	19
7.1. Block Diagram of Test Setup.....	19
7.2. The Requirement For Section 15.247(b)(3).....	19
7.3. EUT Configuration on Measurement	19
7.4. Operating Condition of EUT	19
7.5. Test Procedure	20
7.6. Test Result	20
8. POWER SPECTRAL DENSITY MEASUREMENT.....	22
8.1. Block Diagram of Test Setup.....	22
8.2. The Requirement For Section 15.247(e).....	22
8.3. EUT Configuration on Measurement	22
8.4. Operating Condition of EUT	22
8.5. Test Procedure	22
8.6. Test Result	23
9. BAND EDGE COMPLIANCE TEST	25
9.1. Block Diagram of Test Setup.....	25
9.2. The Requirement For Section 15.247(d)	25
9.3. EUT Configuration on Measurement	25
9.4. Operating Condition of EUT	25

9.5.	Test Procedure	25
9.6.	Test Result	26
10.	RADIATED SPURIOUS EMISSION TEST	32
10.1.	Block Diagram of Test Setup.....	32
10.2.	The Limit For Section 15.247(d).....	33
10.3.	Restricted bands of operation	33
10.4.	Configuration of EUT on Measurement	34
10.5.	Operating Condition of EUT	34
10.6.	Test Procedure	34
10.7.	The Field Strength of Radiation Emission Measurement Results	35
11.	CONDUCTED SPURIOUS EMISSION COMPLIANCE TEST	48
11.1.	Block Diagram of Test Setup.....	48
11.2.	The Requirement of Section 15.247(d).....	48
11.3.	EUT Configuration on Measurement	48
11.4.	Operating Condition of EUT	48
11.5.	Test Procedure	49
11.6.	Test Result	49
12.	ANTENNA REQUIREMENT.....	51
12.1.	The Requirement	51
12.2.	Antenna Construction	51

Test Report Certification

Applicant : HONG KONG NATURAL SOUND ELECTRONICS LIMITED
Manufacturer : Natural Sound Electronics (Shenzhen) Co., Ltd.
EUT Description : MID
(A) MODEL NO.: PC4311BXB, Trio Stealth Mini, Trio MINI
(B) Trade Name.: /
(C) POWER SUPPLY: DC 3.7V (Powered by battery)

Measurement Procedure Used:

FCC Rules and Regulations Part 15 Subpart C Section 15.247
ANSI C63.4: 2009

The EUT was tested according to DTS test procedure of Jun 05, 2014 KDB558074 D01 DTS Meas Guidance v03r02 for compliance to FCC 47CFR 15.247 requirements

The device described above is tested by ACCURATE TECHNOLOGY CO. LTD to determine the maximum emission levels emanating from the device. The maximum emission levels are compared to the FCC Part 15 Subpart C Section 15.247 limits. The measurement results are contained in this test report and ACCURATE TECHNOLOGY CO. LTD is assumed full responsibility for the accuracy and completeness of these measurements. Also, this report shows that the Equipment Under Test (EUT) is to be technically compliant with the FCC requirements.

This report applies to above tested sample only. This report shall not be reproduced in part without written approval of ACCURATE TECHNOLOGY CO. LTD.

Date of Test : July 30, 2014-Aug 06, 2014

Prepared by : 
(Tim.zhang, Engineer)

Approved & Authorized Signer : 
(Sean Liu, Manager)

1. GENERAL INFORMATION

1.1. Description of Device (EUT)

EUT	:	MID
Model Number	:	PC4311BXB, Trio Stealth Mini, Trio MINI
Bluetooth version	:	Bluetooth V4.0 LE
Frequency Range	:	2402MHz-2480MHz
Number of Channels	:	40
Type of Antenna	:	Integral Antenna
Antenna gain	:	0dBi
Power Supply	:	DC 3.7V (Powered by Battery)
Modulation mode	:	GFSK
Applicant	:	HONG KONG NATURAL SOUND ELECTRONICS LIMITED
Address	:	FLAT/RM M 4/F CONTINENTAL MANSION 300 KING'S ROAD HONG KONG
Manufacturer	:	Natural Sound Electronics (Shenzhen) Co., Ltd.
Address	:	4th Building, Xinyuan Industrial Zone, Gushu Village, Bao'an District, Shenzhen, China
Date of sample received	:	July 31, 2014
Date of Test	:	July 31, 2014-Aug 06, 2014

1.2.Carrier Frequency of Channels

Channel	Frequency (MHz)	Channel	Frequency (MHz)	Channel	Frequency (MHz)	Channe 1	Frequency (MHz)
0	2402	10	2422	20	2442	30	2462
1	2404	11	2424	21	2444	31	2464
2	2406	12	2426	22	2446	32	2466
3	2408	13	2428	23	2448	33	2468
4	2410	14	2430	24	2450	34	2470
5	2412	15	2432	25	2452	35	2472
6	2414	16	2434	26	2454	36	2474
7	2416	17	2436	27	2456	37	2476
8	2418	18	2438	28	2458	38	2478
9	2420	19	2440	29	2460	39	2480

1.3.Special Accessory and Auxiliary Equipment

N/A

1.4. Description of Test Facility

EMC Lab : Accredited by TUV Rheinland Shenzhen

Listed by FCC
The Registration Number is 752051

Listed by Industry Canada
The Registration Number is 5077A-2

Accredited by China National Accreditation Committee
for Laboratories
The Certificate Registration Number is L3193

Name of Firm : ACCURATE TECHNOLOGY CO. LTD
Site Location : F1, Bldg. A, Changyuan New Material Port, Keyuan Rd.
Science & Industry Park, Nanshan, Shenzhen, Guangdong
P.R. China

1.5. Measurement Uncertainty

Conducted Emission Expanded Uncertainty = 2.23dB, k=2

Radiated emission expanded uncertainty = 3.08dB, k=2
(9kHz-30MHz)

Radiated emission expanded uncertainty = 4.42dB, k=2
(30MHz-1000MHz)

Radiated emission expanded uncertainty = 4.06dB, k=2
(Above 1GHz)

2. MEASURING DEVICE AND TEST EQUIPMENT

Table 1: List of Test and Measurement Equipment

Kind of equipment	Manufacturer	Type	S/N	Calibrated dates	Calibrated until
EMI Test Receiver	Rohde&Schwarz	ESCS30	100307	Jan. 11, 2014	Jan. 10, 2015
EMI Test Receiver	Rohde&Schwarz	ESPI3	101526/003	Jan. 11, 2014	Jan. 10, 2015
Spectrum Analyzer	Agilent	E7405A	MY45115511	Jan. 11, 2014	Jan. 10, 2015
Pre-Amplifier	Rohde&Schwarz	CBLU118354 0-01	3791	Jan. 11, 2014	Jan. 10, 2015
Loop Antenna	Schwarzbeck	FMZB1516	1516131	Jan. 15, 2014	Jan. 14, 2015
Bilog Antenna	Schwarzbeck	VULB9163	9163-323	Jan. 15, 2014	Jan. 14, 2015
Horn Antenna	Schwarzbeck	BBHA9120D	9120D-655	Jan. 15, 2014	Jan. 14, 2015
Horn Antenna	Schwarzbeck	BBHA9170	9170-359	Jan. 15, 2014	Jan. 14, 2015
LISN	Rohde&Schwarz	ESH3-Z5	100305	Jan. 11, 2014	Jan. 10, 2015
LISN	Schwarzbeck	NSLK8126	8126431	Jan. 11, 2014	Jan. 10, 2015
Highpass Filter	Wainwright Instruments	WHKX3.6/18 G-10SS	N/A	Jan. 11, 2014	Jan. 10, 2015
Band Reject Filter	Wainwright Instruments	WRCG2400/2 485-2375/2510 -60/11SS	N/A	Jan. 11, 2014	Jan. 10, 2015

3. OPERATION OF EUT DURING TESTING

3.1. Operating Mode

The mode is used: **BLE Transmitting mode**

Low Channel: 2402MHz

Middle Channel: 2440MHz

High Channel: 2480MHz

3.2. Configuration and peripherals

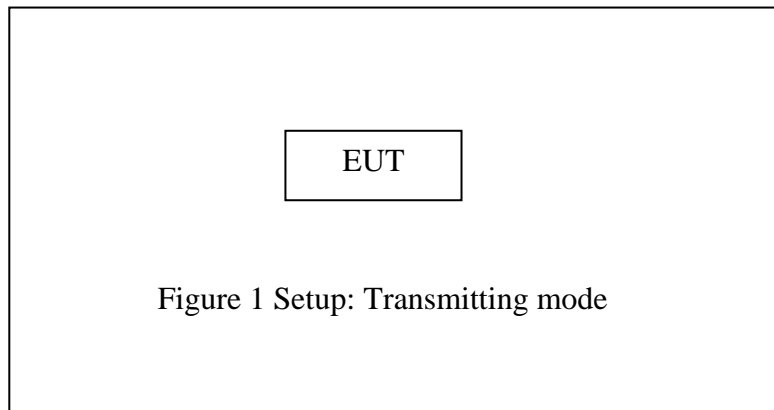

4. TEST PROCEDURES AND RESULTS

FCC Rules	Description of Test	Result
Section 15.207	Power Line Conducted Emission	Compliant
Section 15.247(a)(2)	6dB Bandwidth Test	Compliant
Section 15.247(e)	Power Spectral Density Test	Compliant
Section 15.247(b)(3)	Maximum Peak Output Power Test	Compliant
Section 15.247(d)	Band Edge Compliance Test	Compliant
Section 15.247(d) Section 15.209	Radiated Spurious Emission Test	Compliant
Section 15.247(d)	Conducted Spurious Emission Test	Compliant
Section 15.203	Antenna Requirement	Compliant

5. POWER LINE CONDUCTED MEASUREMENT

5.1. Block Diagram of Test Setup

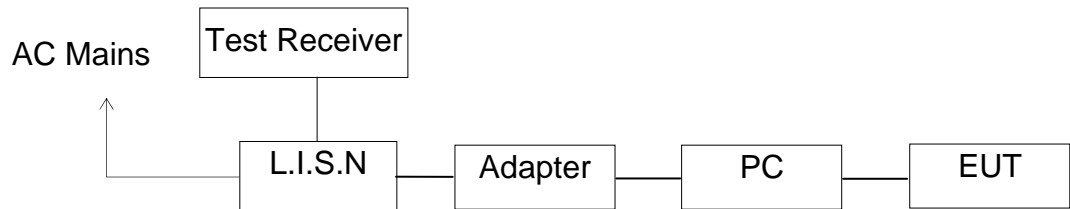

(EUT: MID)

5.2. Power Line Conducted Emission Measurement Limits

Frequency (MHz)	Limit dB(μV)	
	Quasi-peak Level	Average Level
0.15 - 0.50	66.0 – 56.0 *	56.0 – 46.0 *
0.50 - 5.00	56.0	46.0
5.00 - 30.00	60.0	50.0

NOTE1: The lower limit shall apply at the transition frequencies.
 NOTE2: The limit decreases linearly with the logarithm of the frequency in the range 0.15MHz to 0.50MHz.

5.3. Configuration of EUT on Measurement

The following equipments are installed on Power Line Conducted Emission Measurement to meet the commission requirement and operating regulations in a manner, which tends to maximize its emission characteristics in a normal application.

5.4. Operating Condition of EUT

- 5.4.1. Setup the EUT and simulator as shown as Section 5.1.
- 5.4.2. Turn on the power of all equipment.
- 5.4.3. Let the EUT work in test mode and measure it.

5.5. Test Procedure

The EUT is put on the plane 0.8m high above the ground by insulating support and is connected to the power mains through a line impedance stabilization network (L.I.S.N.). This provides a 50ohm coupling impedance for the EUT system. Please refer the block diagram of the test setup and photographs. Both sides of AC lines are checked to find out the maximum conducted emission. In order to find the maximum emission levels, the relative positions of equipment and all of the interface cables shall be changed according to ANSI C63.4: 2009 on Conducted Emission Measurement.

The bandwidth of test receiver (R & S ESCS30) is set at 9kHz.

The frequency range from 150kHz to 30MHz is checked.

5.6.Power Line Conducted Emission Measurement Results

PASS.

The frequency range from 150kHz to 30MHz is checked.

Test mode : Charging&BT communicating								
MEASUREMENT RESULT: "NS-B001_fin"								
8/2/2014 8:56AM								
Frequency	Level	Transd	Limit	Margin	Detector	Line	PE	
MHz	dBµV	dB	dBµV	dB				
0.155493	52.00	10.5	66	13.7	QP	L1	GND	
2.611759	32.50	11.0	56	23.5	QP	L1	GND	
5.141510	29.10	11.2	60	30.9	QP	L1	GND	
MEASUREMENT RESULT: "NS-B001_fin2"								
8/2/2014 8:56AM								
Frequency	Level	Transd	Limit	Margin	Detector	Line	PE	
MHz	dBµV	dB	dBµV	dB				
0.533451	24.30	10.7	46	21.7	AV	L1	GND	
2.812152	30.20	11.0	46	15.8	AV	L1	GND	
5.182765	22.00	11.2	50	28.0	AV	L1	GND	
MEASUREMENT RESULT: "NS-B002_fin"								
8/2/2014 9:00AM								
Frequency	Level	Transd	Limit	Margin	Detector	Line	PE	
MHz	dBµV	dB	dBµV	dB				
0.153947	46.80	10.5	66	19.0	QP	N	GND	
2.979907	29.20	11.1	56	26.8	QP	N	GND	
5.224352	23.90	11.2	60	36.1	QP	N	GND	
MEASUREMENT RESULT: "NS-B002_fin2"								
8/2/2014 9:00AM								
Frequency	Level	Transd	Limit	Margin	Detector	Line	PE	
MHz	dBµV	dB	dBµV	dB				
0.154873	33.10	10.5	56	22.6	AV	N	GND	
2.834716	29.40	11.0	46	16.6	AV	N	GND	
6.191398	24.90	11.2	50	25.1	AV	N	GND	

Emissions attenuated more than 20 dB below the permissible value are not reported.

The spectral diagrams are attached as below.

ACCURATE TECHNOLOGY CO., LTD

CONDUCTED EMISSION STANDARD FCC PART 15 B

EUT: MID M/N:PC4311BXB
 Manufacturer: Natural Sound
 Operating Condition: BT/Charging
 Test Site: 1#Shielding Room
 Operator: Alen
 Test Specification: L 120V/60Hz
 Comment: Report No.:ATE20141486
 Start of Test: 8/2/2014 / 8:52:44AM

SCAN TABLE: "V 150K-30MHz fin"

Short Description: _SUB_STD_VTERM2 1.70
 Start Stop Step Detector Meas. IF Transducer
 Frequency Frequency Width Time Bandw.
 150.0 kHz 30.0 MHz 4.5 kHz QuasiPeak 1.0 s 9 kHz NSLK8126 2008
 Average

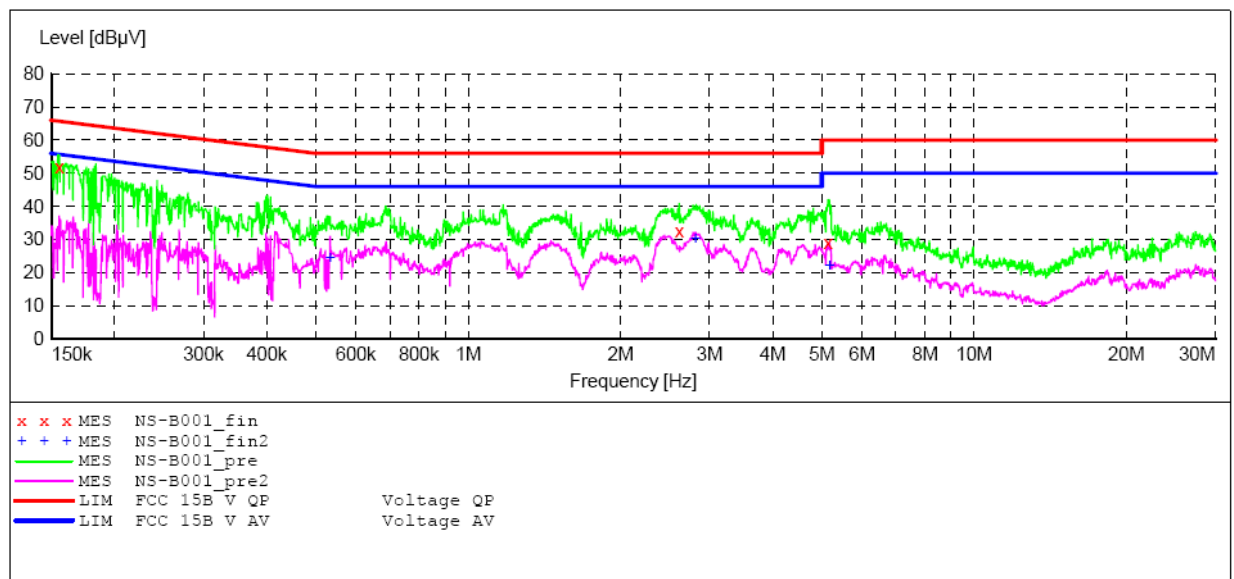

MEASUREMENT RESULT: "NS-B001_fin"

8/2/2014 8:56AM

Frequency MHz	Level dBµV	Transd dB	Limit dBµV	Margin dB	Detector	Line	PE
0.155493	52.00	10.5	66	13.7	QP	L1	GND
2.611759	32.50	11.0	56	23.5	QP	L1	GND
5.141510	29.10	11.2	60	30.9	QP	L1	GND

MEASUREMENT RESULT: "NS-B001_fin2"

8/2/2014 8:56AM

Frequency MHz	Level dBµV	Transd dB	Limit dBµV	Margin dB	Detector	Line	PE
0.533451	24.30	10.7	46	21.7	AV	L1	GND
2.812152	30.20	11.0	46	15.8	AV	L1	GND
5.182765	22.00	11.2	50	28.0	AV	L1	GND

ACCURATE TECHNOLOGY CO., LTD

CONDUCTED EMISSION STANDARD FCC PART 15 B

EUT: MID M/N:PC4311BXB
 Manufacturer: Natural Sound
 Operating Condition: BT/Charging
 Test Site: 1#Shielding Room
 Operator: Alen
 Test Specification: N 120V/60Hz
 Comment: Report No.:ATE20141486
 Start of Test: 8/2/2014 / 8:57:13AM

SCAN TABLE: "V 150K-30MHz fin"

Start Frequency	Stop Frequency	Step Width	Detector	Meas. Time	IF Bandw.	Transducer
150.0 kHz	30.0 MHz	4.5 kHz	QuasiPeak	1.0 s	9 kHz	NSLK8126 2008
Average						

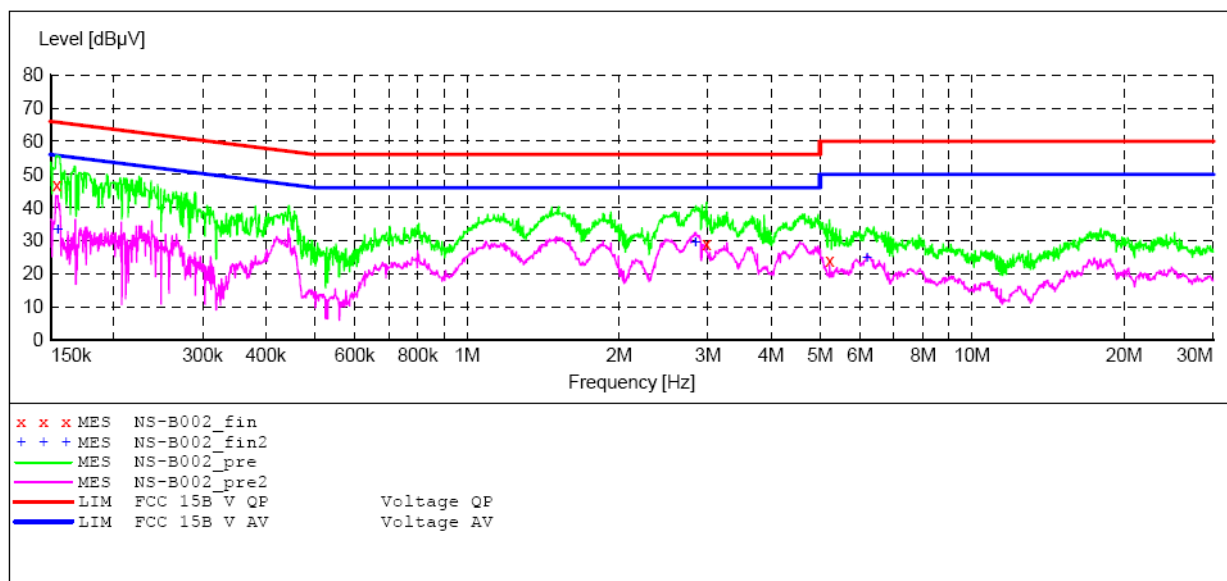

MEASUREMENT RESULT: "NS-B002_fin"

8/2/2014 9:00AM

Frequency MHz	Level dBuV	Transd dB	Limit dBuV	Margin dB	Detector	Line	PE
0.153947	46.80	10.5	66	19.0	QP	N	GND
2.979907	29.20	11.1	56	26.8	QP	N	GND
5.224352	23.90	11.2	60	36.1	QP	N	GND

MEASUREMENT RESULT: "NS-B002_fin2"

8/2/2014 9:00AM

Frequency MHz	Level dBuV	Transd dB	Limit dBuV	Margin dB	Detector	Line	PE
0.154873	33.10	10.5	56	22.6	AV	N	GND
2.834716	29.40	11.0	46	16.6	AV	N	GND
6.191398	24.90	11.2	50	25.1	AV	N	GND

6. 6DB BANDWIDTH MEASUREMENT

6.1. Block Diagram of Test Setup

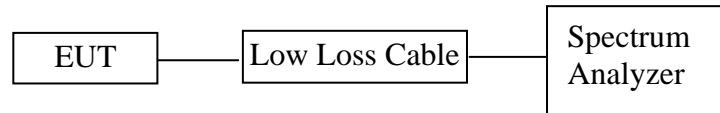

(EUT: MID)

6.2. The Requirement For Section 15.247(a)(2)

Section 15.247(a)(2): Systems using digital modulation techniques may operate in the 902-928MHz, 2400-2483.5MHz, and 5725-5850MHz bands. The minimum 6 dB bandwidth shall be at least 500 kHz.

6.3. EUT Configuration on Measurement

The equipment is installed on the emission measurement to meet the commission requirements and operating regulations in a manner which tends to maximize its emission characteristics in normal application.

6.4. Operating Condition of EUT

6.4.1. Setup the EUT and simulator as shown as Section 5.1.

6.4.2. Turn on the power of all equipment.

6.4.3. Let the EUT work in TX modes measure it. The transmit frequency are 2402-2480 MHz. We select 2402MHz, 2440MHz, and 2480MHz TX frequency to transmit.

6.5. Test Procedure

6.5.1. The transmitter output was connected to the spectrum analyzer through a low loss cable.

6.5.2. Set RBW of spectrum analyzer to 100 kHz and VBW to 300 kHz.

6.5.3. The 6dB bandwidth is defined as the total spectrum the power of which is higher than peak power minus 6dB.

6.6. Test Result

Channel	Frequency (MHz)	6 dB Bandwidth (MHz)	Minimum Limit(MHz)	PASS/FAIL
0	2402	0.618	0.5	PASS
19	2440	0.618	0.5	PASS
39	2480	0.618	0.5	PASS

The spectrum analyzer plots are attached as below.

channel 0

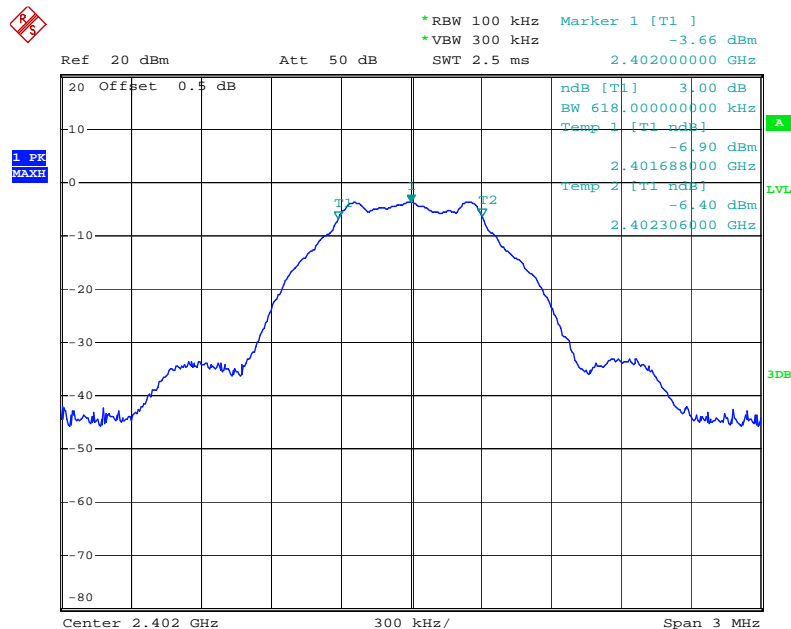

Date: 03.AUG.2014 14:20:31

channel 19

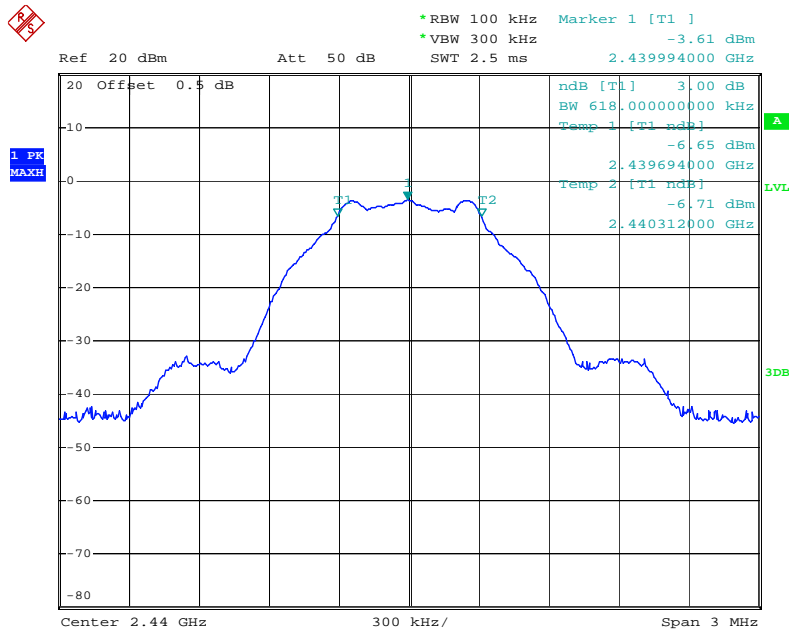

Date: 03.AUG.2014 14:20:01

channel 39

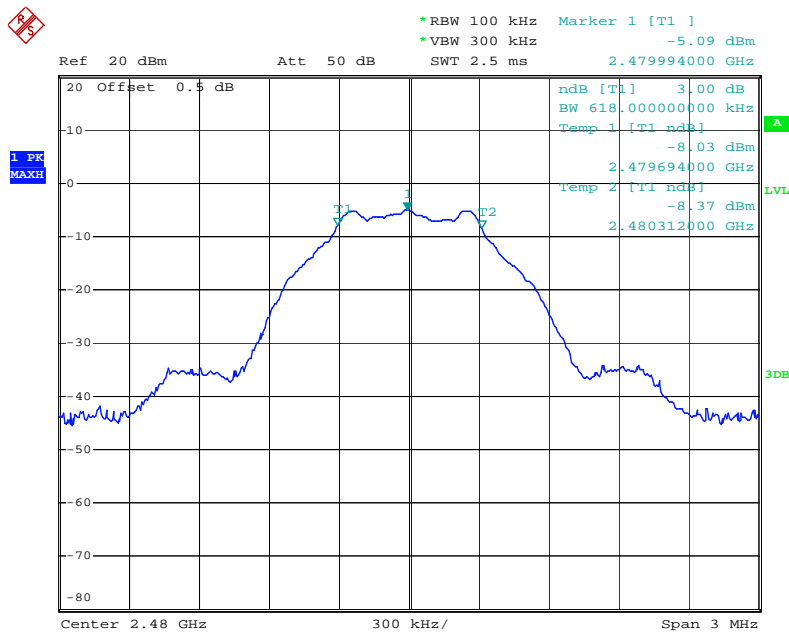

Date: 03.AUG.2014 14:19:28

7. MAXIMUM PEAK OUTPUT POWER

7.1. Block Diagram of Test Setup

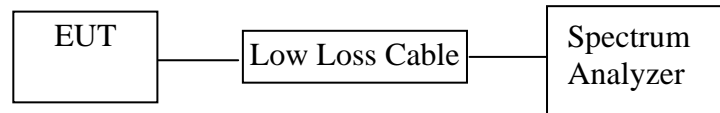

(EUT: MID)

7.2. The Requirement For Section 15.247(b)(3)

Section 15.247(b)(3): For systems using digital modulation in the 902-928MHz, 2400-2483.5MHz, and 5725-5850MHz bands: 1 Watt.

7.3. EUT Configuration on Measurement

The equipment are installed on the emission Measurement to meet the commission requirements and operating regulations in a manner which tends to maximize its emission characteristics in normal application.

7.4. Operating Condition of EUT

7.4.1. Setup the EUT and simulator as shown as Section 6.1.

7.4.2. Turn on the power of all equipment.

7.4.3. Let the EUT work in TX modes measure it. The transmit frequency are 2402-2480 MHz. We select 2402MHz, 2440MHz, and 2480MHz TX frequency to transmit.

7.5. Test Procedure

This procedure shall be used when the measurement instrument has available a resolution bandwidth that is greater than the DTS bandwidth.

The transmitter output was connected to the spectrum analyzer through a low loss cable.

- a) Set the RBW \geq DTS bandwidth.
- b) Set VBW $\geq 3 \times$ RBW.
- c) Set span $\geq 3 \times$ RBW
- d) Sweep time = auto couple.
- e) Detector = peak.
- f) Trace mode = max hold.
- g) Allow trace to fully stabilize.
- h) Use peak marker function to determine the peak amplitude level.

7.6. Test Result

Channel	Frequency (MHz)	Peak Power Output (dBm)	Peak Power Limit (dBm)	Pass / Fail
0	2402	-3.50	30	PASS
19	2440	-2.09	30	PASS
39	2480	-3.92	30	PASS

The spectrum analyzer plots are attached as below.

channel 0

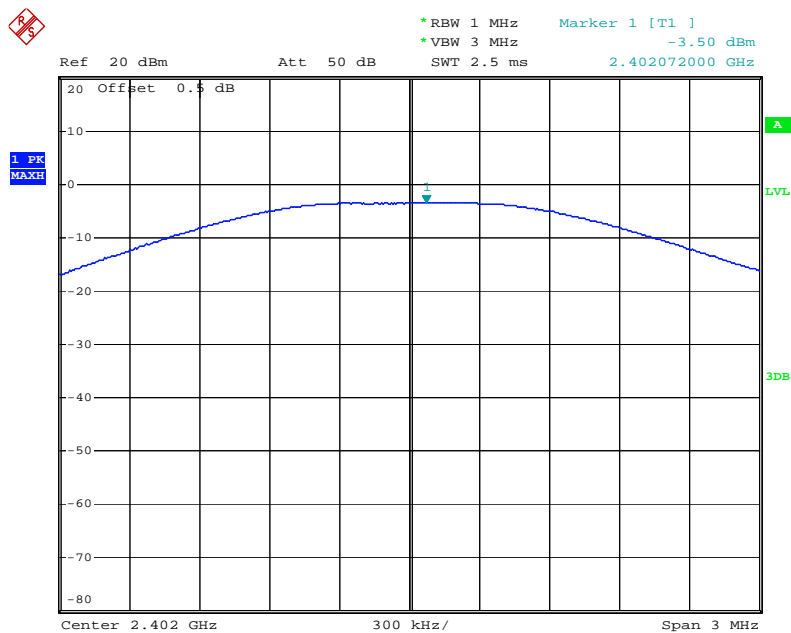

Date: 03.AUG.2014 14:16:39

channel 19

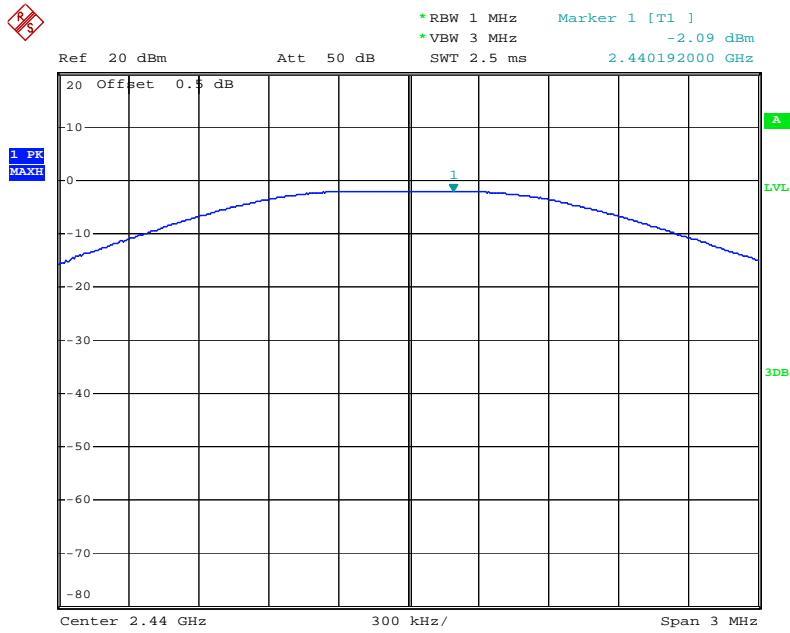

Date: 03.AUG.2014 14:17:33

channel 39

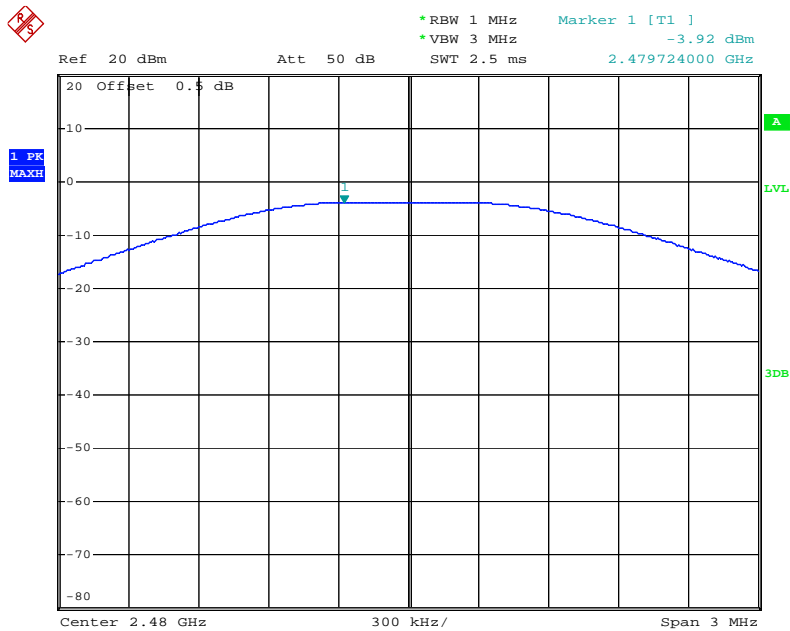

Date: 03.AUG.2014 14:18:07

8. POWER SPECTRAL DENSITY MEASUREMENT

8.1. Block Diagram of Test Setup

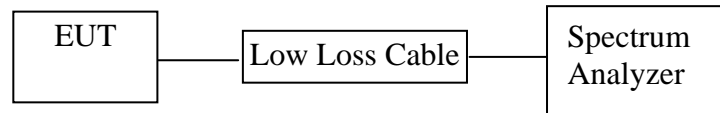

(EUT: MID)

8.2. The Requirement For Section 15.247(e)

Section 15.247(e): For digitally modulated systems, the power spectral density conducted from the intentional radiator to the antenna shall not be greater than 8 dBm in any 3 kHz band during any time interval of continuous transmission.

8.3. EUT Configuration on Measurement

The equipment is installed on the emission Measurement to meet the commission requirements and operating regulations in a manner which tends to maximize its emission characteristics in normal application.

8.4. Operating Condition of EUT

8.4.1. Setup the EUT and simulator as shown as Section 8.1.

8.4.2. Turn on the power of all equipment.

8.4.3. Let the EUT work in TX modes measure it. The transmit frequency are 2402-2480. We select 2402MHz, 2440MHz, and 2480MHz TX frequency to transmit.

8.5. Test Procedure

8.5.1. The EUT was tested according to DTS test procedure of Jun 05, 2014 KDB558074 D01 DTS Meas Guidance v03r02 for compliance to FCC 47CFR 15.247 requirements.

8.5.2. The transmitter output was connected to the spectrum analyzer through a low loss cable.

8.5.3. Measurement Procedure PKPSD:

This procedure must be used if maximum peak conducted output power was used to demonstrate compliance to the fundamental output power limit, and is optional if the maximum (average) conducted output power was used to demonstrate

compliance.

1. Set analyzer center frequency to DTS channel center frequency.
2. Set the span to 1.5 times the DTS channel bandwidth.
3. Set the RBW to: $3 \text{ kHz} \leq \text{RBW} \leq 100 \text{ kHz}$.
4. Set the VBW $\geq 3 \times \text{RBW}$.
5. Detector = peak.
6. Sweep time = auto couple.
7. Trace mode = max hold.
8. Allow trace to fully stabilize.
9. Use the peak marker function to determine the maximum amplitude level.
10. If measured value exceeds limit, reduce RBW (no less than 3 kHz) and repeat.

8.5.4.Measurement the maximum power spectral density.

8.6.Test Result

CHANNEL NUMBER	FREQUENCY (MHz)	PSD (dBm/3KHz)	LIMIT (dBm/3KHz)	PASS/FAIL
0	2402	-18.22	8	PASS
19	2440	-18.26	8	PASS
39	2480	-19.65	8	PASS

The spectrum analyzer plots are attached as below.

channel 0

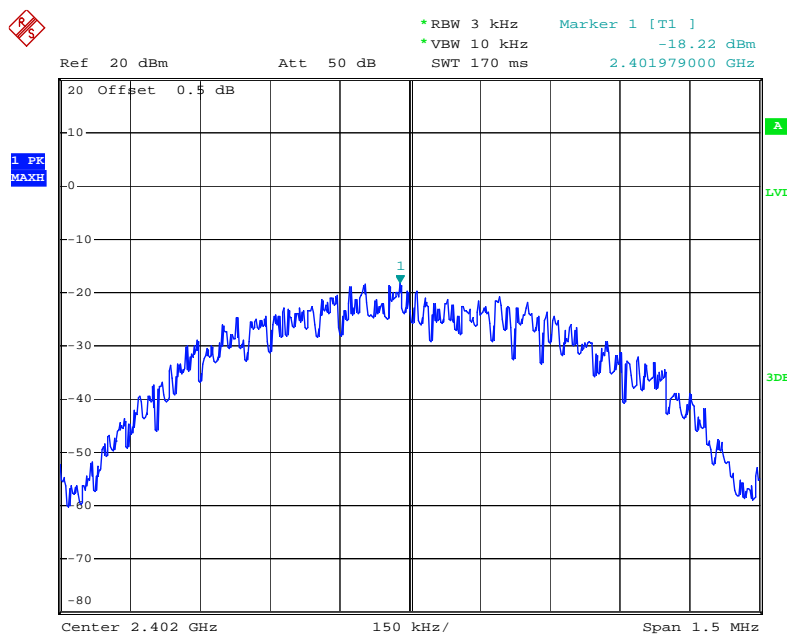

Date: 03.AUG.2014 14:21:12

channel 19

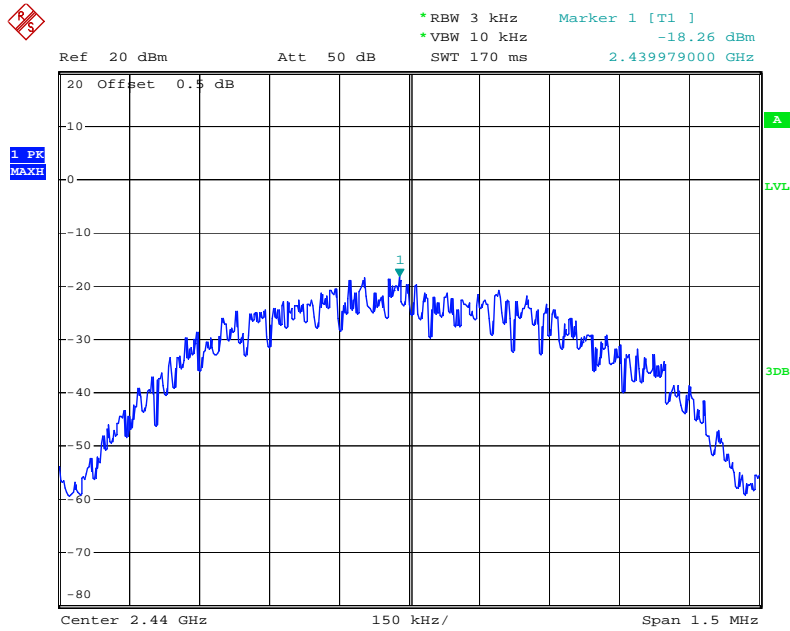

Date: 03.AUG.2014 14:21:40

channel 39

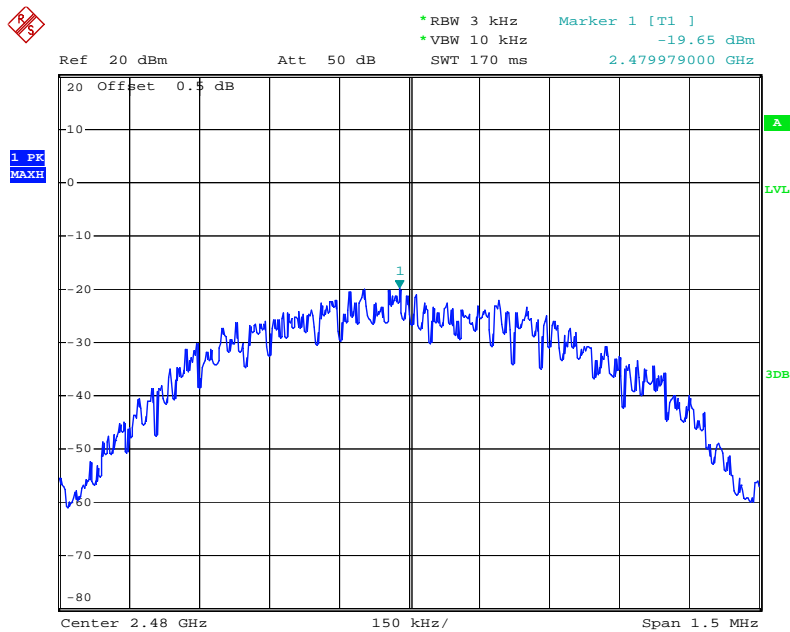

Date: 03.AUG.2014 14:22:00

9. BAND EDGE COMPLIANCE TEST

9.1. Block Diagram of Test Setup

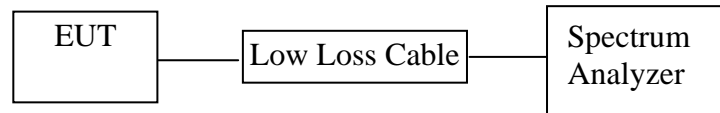

(EUT: MID)

9.2. The Requirement For Section 15.247(d)

Section 15.247(d): In any 100 kHz bandwidth outside the frequency band in which the spread spectrum or digitally modulated intentional radiator is operating, the radio frequency power that is produced by the intentional radiator shall be at least 20 dB below that in the 100 kHz bandwidth within the band that contains the highest level of the desired power, based on either an RF conducted or a radiated measurement, provided the transmitter demonstrates compliance with the peak conducted power limits. If the transmitter complies with the conducted power limits based on the use of RMS averaging over a time interval, as permitted under paragraph (b)(3) of this section, the attenuation required under this paragraph shall be 30 dB instead of 20 dB. Attenuation below the general limits specified in Section 15.209(a) is not required. In addition, radiated emissions which fall in the restricted bands, as defined in Section 15.205(a), must also comply with the radiated emission limits specified in Section 15.209(a).

9.3. EUT Configuration on Measurement

The equipment is installed on the emission Measurement to meet the commission requirements and operating regulations in a manner which tends to maximize its emission characteristics in normal application.

9.4. Operating Condition of EUT

9.4.1. Setup the EUT and simulator as shown as Section 9.1.

9.4.2. Turn on the power of all equipment.

9.4.3. Let the EUT work in TX modes measure it. The transmit frequency are 2402-2480 MHz. We select 2402MHz, 2480MHz TX frequency to transmit.

9.5. Test Procedure

Conducted Band Edge:

9.5.1. The transmitter output was connected to the spectrum analyzer via a low loss cable.

9.5.2. Set RBW of spectrum analyzer to 100 kHz and VBW to 300 kHz.

Radiate Band Edge:

9.5.3. The EUT is placed on a turntable, which is 0.8m above the ground plane and worked at highest radiated power.

9.5.4. The turntable was rotated for 360 degrees to determine the position of maximum emission level.

9.5.5. EUT is set 3m away from the receiving antenna, which is varied from 1m to 4m to find out the highest emission.

9.5.6. Set the spectrum analyzer in the following setting in order to capture the lower and upper band-edges of the emission:

RBW=1MHz, VBW=3MHz

9.5.7. The band edges was measured and recorded.

9.6. Test Result

Pass

Channel	Frequency	Delta peak to band emission	Limit(dBc)
0	2352.20MHz	38.33	20
39	2498.08MHz	37.54	20

channel 0

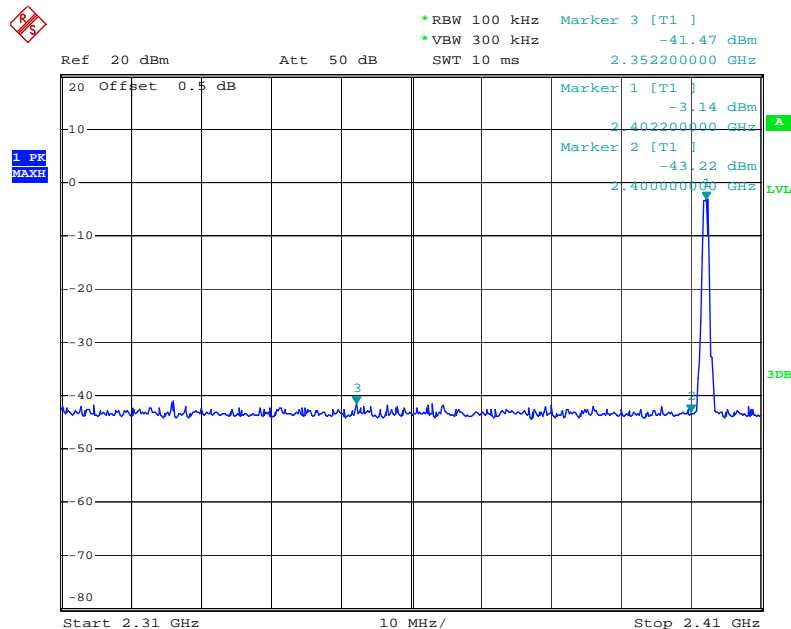

Date: 03.AUG.2014 14:25:38

channel 39

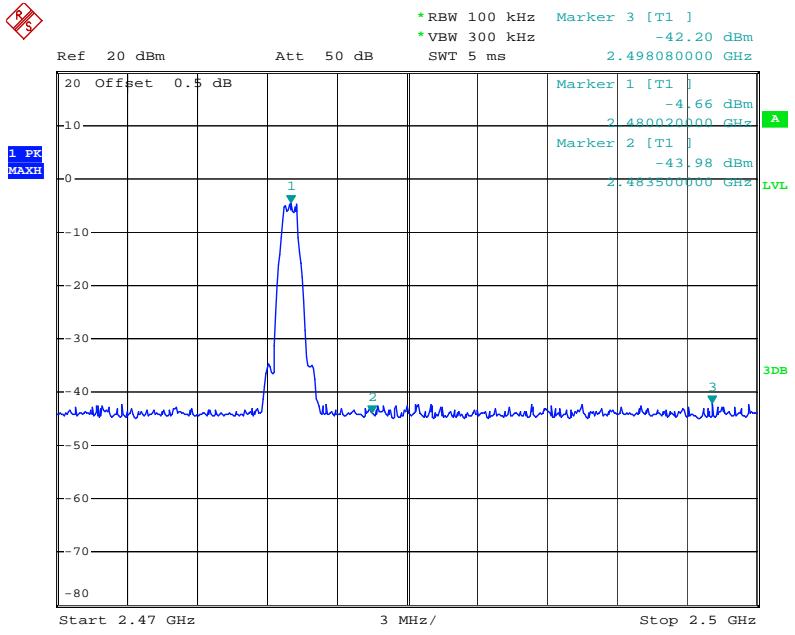

Date: 03.AUG.2014 14:23:08

Radiated Band Edge Result

ACCURATE TECHNOLOGY CO., LTD.

 F1,Bldg,A,Changyuan New Material Port Keyuan Rd,
 Science & Industry Park,Nanshan Shenzhen,P.R.China

Site: 1# Chamber

Tel:+86-0755-26503290

Fax:+86-0755-26503396

Job No.: alen #3604

Standard: FCC PK

Test item: Radiation Test

Temp.(C)/Hum.(%) 25 C / 55 %

EUT: MID

Mode: TX 2402MHz

Model: PC4311BxB

Manufacturer: Natural Sound

Polarization: Horizontal

Power Source: DC 3.7V

Date: 14/08/05/

Time: 9/53/59

Engineer Signature:

Distance: 3m

Note: Report No:ATE20141486

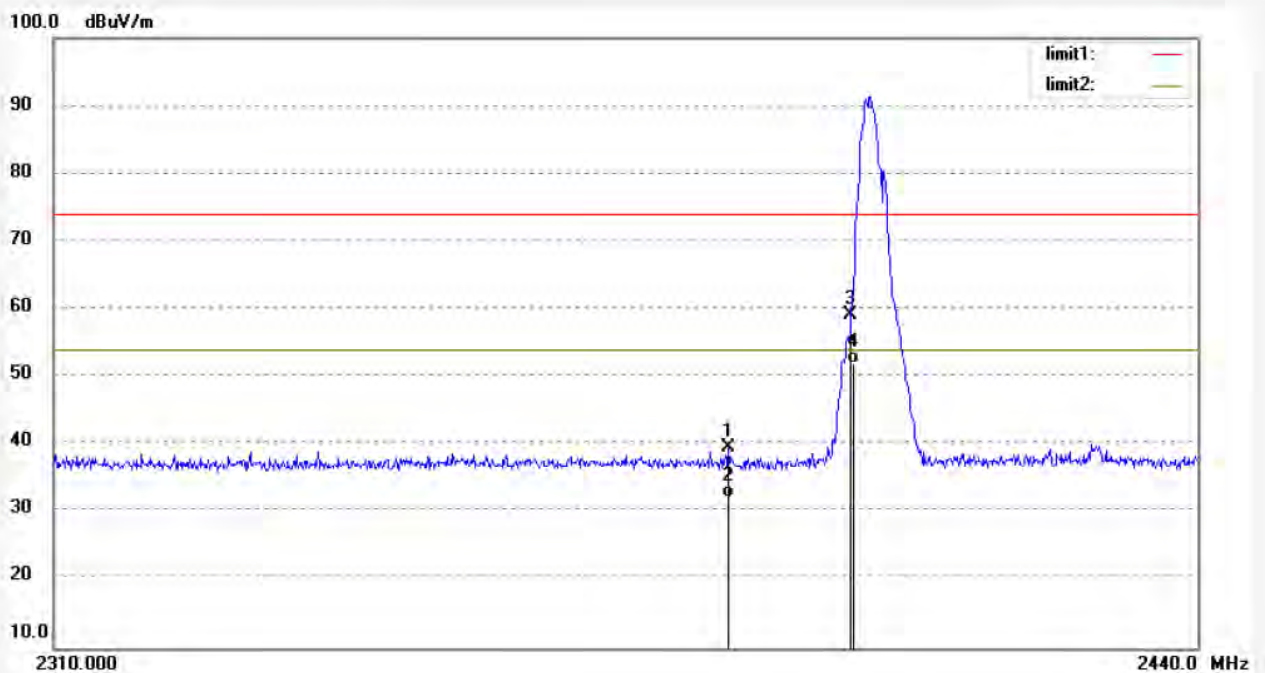

No.	Freq. (MHz)	Reading (dBuV/m)	Factor (dB)	Result (dBuV/m)	Limit (dBuV/m)	Margin (dB)	Detector	Height (cm)	Degree (deg.)	Remark
1	2385.920	46.35	-6.80	39.55	74.00	-34.45	peak			
2	2385.920	38.86	-6.80	32.06	54.00	-21.94	AVG			
3	2399.960	65.85	-6.76	59.09	74.00	-14.91	peak			
4	2399.960	58.68	-6.76	51.92	54.00	-2.08	AVG			

Job No.: alen #3605	Polarization: Vertical
Standard: FCC PK	Power Source: DC 3.7V
Test item: Radiation Test	Date: 14/08/05/
Temp.(C)/Hum.(%) 25 C / 55 %	Time: 9/55/03
EUT: MID	Engineer Signature:
Mode: TX 2402MHz	Distance: 3m
Model: PC4311BXB	
Manufacturer: Natural Sound	

Note: Report No:ATE20141486

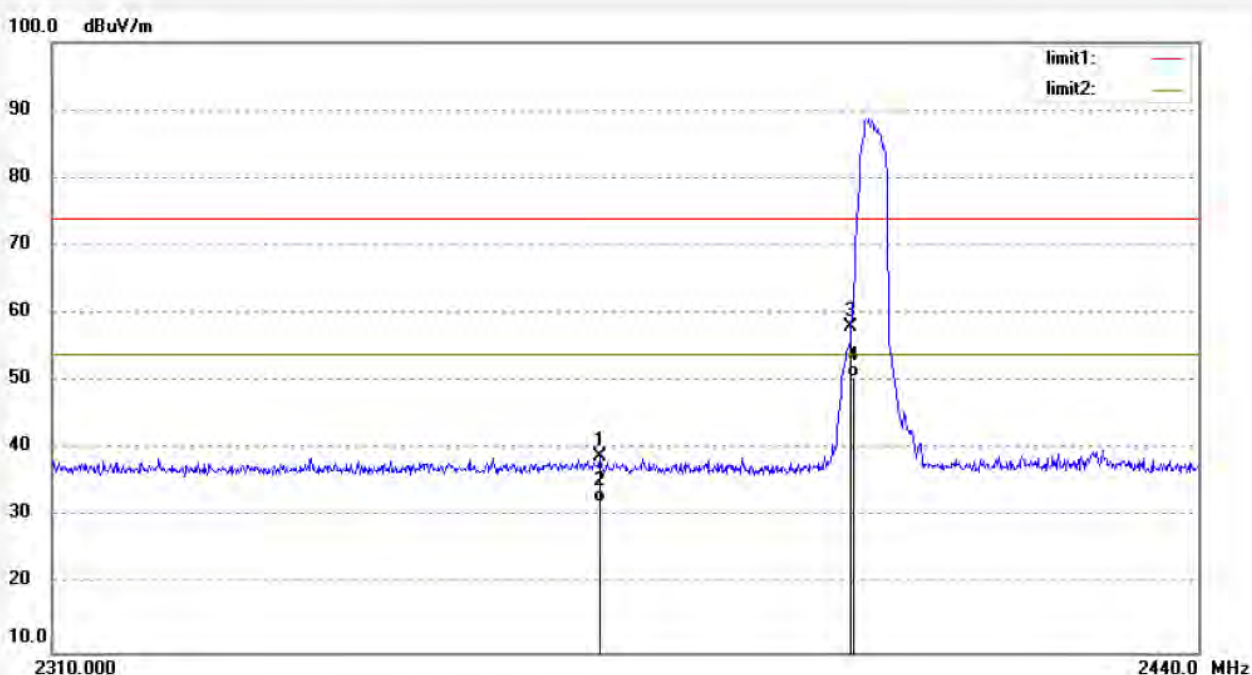

No.	Freq. (MHz)	Reading (dBuV/m)	Factor (dB)	Result (dBuV/m)	Limit (dBuV/m)	Margin (dB)	Detector	Height (cm)	Degree (deg.)	Remark
1	2371.360	45.78	-6.82	38.96	74.00	-35.04	peak			
2	2371.360	38.89	-6.82	32.07	54.00	-21.93	AVG			
3	2399.960	64.76	-6.76	58.00	74.00	-16.00	peak			
4	2399.960	57.35	-6.76	50.59	54.00	-3.41	AVG			

Job No.: alen #3602	Polarization: Horizontal
Standard: FCC PK	Power Source: DC 3.7V
Test item: Radiation Test	Date: 14/08/05/
Temp.(C)/Hum.(%) 25 C / 55 %	Time: 9/50/41
EUT: MID	Engineer Signature:
Mode: TX 2480MHz	Distance: 3m
Model: PC4311BXB	
Manufacturer: Natural Sound	

Note: Report No:ATE20141486

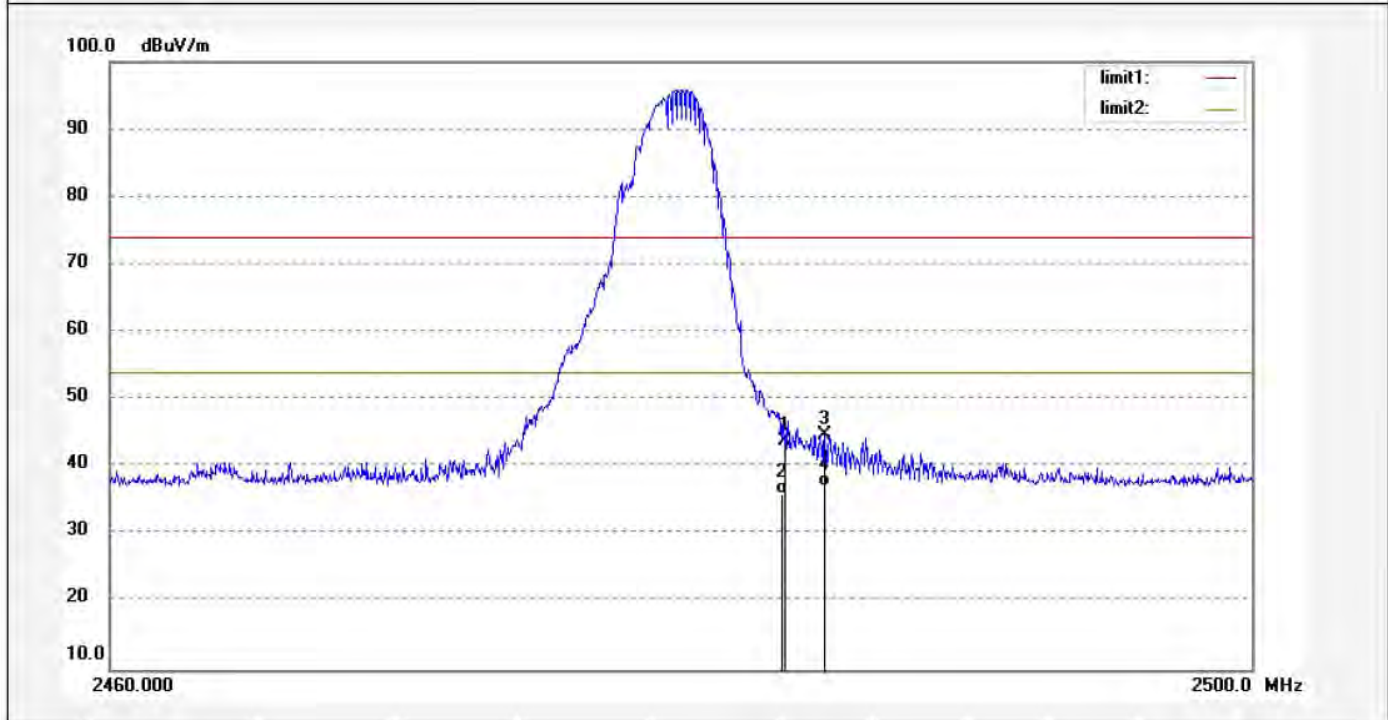

No.	Freq. (MHz)	Reading (dBuV/m)	Factor (dB)	Result (dBuV/m)	Limit (dBuV/m)	Margin (dB)	Detector	Height (cm)	Degree (deg.)	Remark
1	2483.600	50.35	-6.54	43.81	74.00	-30.19	peak			
2	2483.600	42.45	-6.54	35.91	54.00	-18.09	AVG			
3	2485.000	51.35	-6.54	44.81	74.00	-29.19	peak			
4	2485.000	43.57	-6.54	37.03	54.00	-16.97	AVG			

Job No.: alen #3603	Polarization: Vertical
Standard: FCC PK	Power Source: DC 3.7V
Test item: Radiation Test	Date: 14/08/05/
Temp.(C)/Hum.(%) 25 C / 55 %	Time: 9/52/11
EUT: MID	Engineer Signature:
Mode: TX 2480MHz	Distance: 3m
Model: PC4311BXB	
Manufacturer: Natural Sound	

Note: Report No:ATE20141486

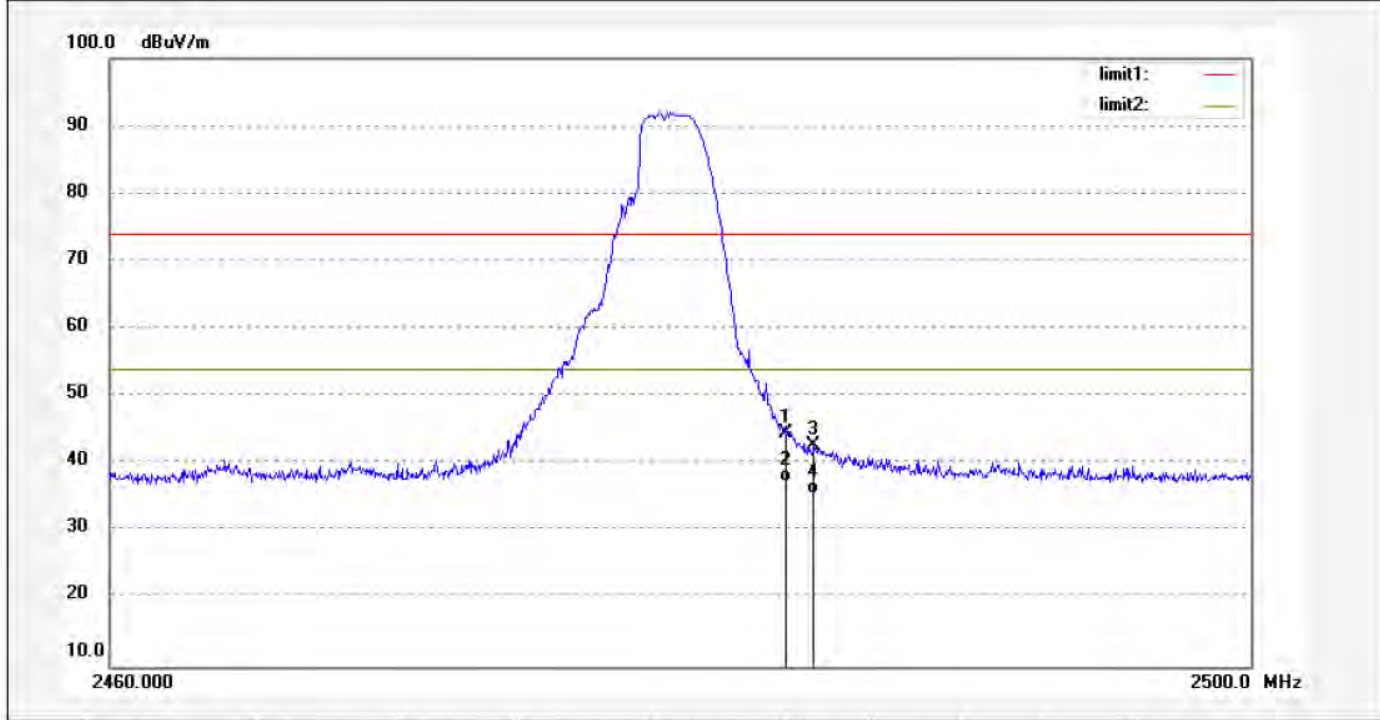

No.	Freq. (MHz)	Reading (dBuV/m)	Factor (dB)	Result (dBuV/m)	Limit (dBuV/m)	Margin (dB)	Detector	Height (cm)	Degree (deg.)	Remark
1	2483.600	51.06	-6.54	44.52	74.00	-29.48	peak			
2	2483.600	43.89	-6.54	37.35	54.00	-16.65	AVG			
3	2484.640	49.17	-6.54	42.63	74.00	-31.37	peak			
4	2484.640	42.01	-6.54	35.47	54.00	-18.53	AVG			

Note:

1. Emissions attenuated more than 20 dB below the permissible value are not reported.
2. The field strength is calculated by adding the antenna factor, high pass filter loss(if used) and cable loss, and subtracting the amplifier gain(if any)from the measured reading. The basic equation calculation is as follows:
Result = Reading + Corrected Factor
3. Display the measurement of peak values.

10. RADIATED SPURIOUS EMISSION TEST

10.1. Block Diagram of Test Setup

Radiated Emission Test Set-Up

Frequency range 9KHz – 30MHz

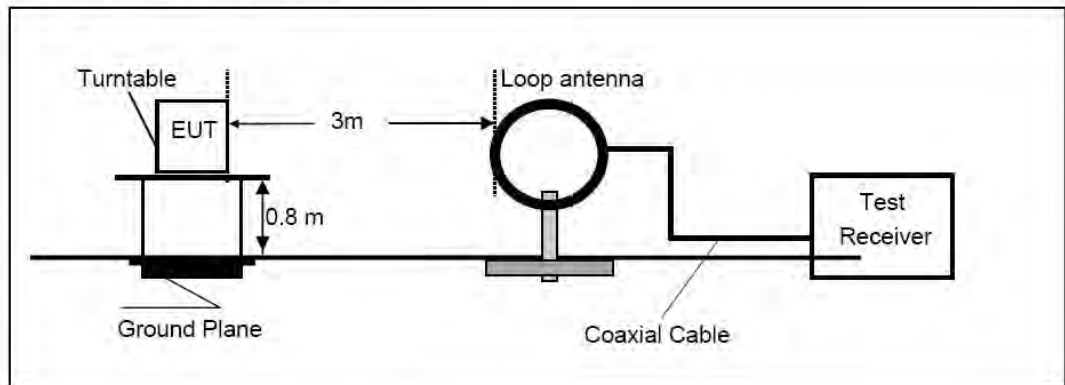

Frequency range 30MHz – 1000MHz

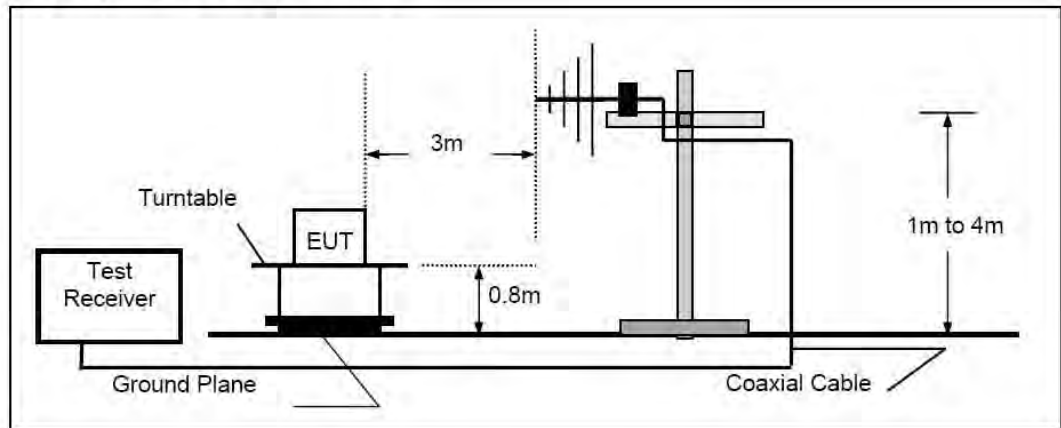

Frequency range above 1GHz-25GHz

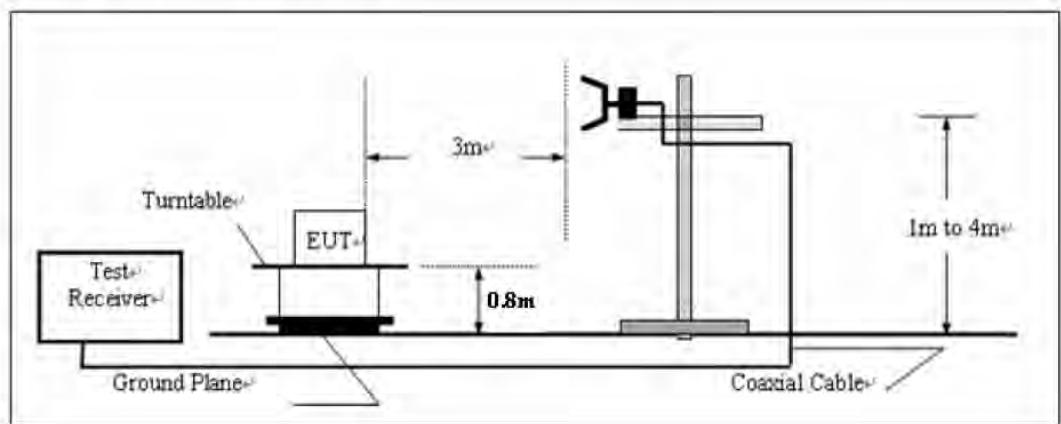

10.2.The Limit For Section 15.247(d)

Section 15.247(d): In any 100 kHz bandwidth outside the frequency band in which the spread spectrum or digitally modulated intentional radiator is operating, the radio frequency power that is produced by the intentional radiator shall be at least 20 dB below that in the 100 kHz bandwidth within the band that contains the highest level of the desired power, based on either an RF conducted or a radiated measurement, provided the transmitter demonstrates compliance with the peak conducted power limits. If the transmitter complies with the conducted power limits based on the use of RMS averaging over a time interval, as permitted under paragraph (b)(3) of this section, the attenuation required under this paragraph shall be 30 dB instead of 20 dB. Attenuation below the general limits specified in Section 15.209(a) is not required. In addition, radiated emissions which fall in the restricted bands, as defined in Section 15.205(a), must also comply with the radiated emission limits specified in Section 15.209(a).

10.3.Restricted bands of operation

10.3.1.FCC Part 15.205 Restricted bands of operation

(a) Except as shown in paragraph (d) of this section, Only spurious emissions are permitted in any of the frequency bands listed below:

MHz	MHz	MHz	GHz
0.090-0.110	16.42-16.423	399.9-410	4.5-5.15
¹ 0.495-0.505	16.69475-16.69525	608-614	5.35-5.46
2.1735-2.1905	16.80425-16.80475	960-1240	7.25-7.75
4.125-4.128	25.5-25.67	1300-1427	8.025-8.5
4.17725-4.17775	37.5-38.25	1435-1626.5	9.0-9.2
4.20725-4.20775	73-74.6	1645.5-1646.5	9.3-9.5
6.215-6.218	74.8-75.2	1660-1710	10.6-12.7
6.26775-6.26825	108-121.94	1718.8-1722.2	13.25-13.4
6.31175-6.31225	123-138	2200-2300	14.47-14.5
8.291-8.294	149.9-150.05	2310-2390	15.35-16.2
8.362-8.366	156.52475-156.52525	2483.5-2500	17.7-21.4
8.37625-8.38675	156.7-156.9	2690-2900	22.01-23.12
8.41425-8.41475	162.0125-167.17	3260-3267	23.6-24.0
12.29-12.293	167.72-173.2	3332-3339	31.2-31.8
12.51975-12.52025	240-285	3345.8-3358	36.43-36.5
12.57675-12.57725	322-335.4	3600-4400	(²)
13.36-13.41			

¹Until February 1, 1999, this restricted band shall be 0.490-0.510

²Above 38.6

(b) Except as provided in paragraphs (d) and (e), the field strength of emission appearing within these frequency bands shall not exceed the limits shown in Section 15.209. At frequencies equal to or less than 1000MHz, Compliance with the limits in Section 15.209 shall be demonstrated using measurement instrumentation employing a CISPR quasi-peak detector. Above 1000MHz, compliance with the emission limits in Section 15.209 shall be demonstrated based on the average value of the measured emissions. The provisions in Section 15.35 apply to these measurements.

10.4. Configuration of EUT on Measurement

The equipment is installed on Radiated Emission Measurement to meet the commission requirements and operating regulations in a manner which tends to maximize its emission characteristics in normal application.

10.5. Operating Condition of EUT

10.5.1. Setup the EUT and simulator as shown as Section 10.1.

10.5.2. Turn on the power of all equipment.

10.5.3. Let the EUT work in TX modes measure it. The transmit frequency are 2402-2480 MHz. We select 2402MHz, 2440MHz, and 2480MHz TX frequency to transmit.

10.6. Test Procedure

The EUT and its simulators are placed on a turntable, which is 0.8 meter high above ground. The turntable can rotate 360 degrees to determine the position of the maximum emission level. EUT is set 3.0 meters away from the receiving antenna, which is mounted on an antenna tower. The antenna can be moved up and down between 1.0 meter and 4 meters to find out the maximum emission level. Broadband antenna (calibrated bilog antenna) is used as receiving antenna. Both horizontal and vertical polarizations of the antenna are set on measurement. In order to find the maximum emission levels, all of the interface cables must be manipulated according to ANSI C63.4: 2009 on radiated emission measurement. The EUT was tested in 3 orthogonal planes.

The final measurement in band 9-90 kHz, 110-490 kHz and above 1000MHz is performed with Average detector. Except those frequency bands mention above, the final measurement for frequencies below 1000MHz is performed with Quasi Peak detector. When average radiated emissions measurements are specified there is also a limit on the peak emissions level which is 20 dB above the applicable maximum permitted average emission limit

During the radiated emission test, the spectrum analyzer was set with the following configurations:

Frequency band(MHz)	Detector	RBW(KHz)	VBW(KHz)
30-1000	QP	120	300
Above 1000	Peak	1000	3000
	Average	1000	0.01

10.7. The Field Strength of Radiation Emission Measurement Results

PASS.

Note: 1. Emissions attenuated more than 20 dB below the permissible value are not reported.

2. The EUT is tested radiation emission at Low, Middle, High channel in three axes. The worst emissions are reported in all channels. The fundamental radiated emissions were reduced by Band Reject Filter in the attached plots.

3. The radiation emissions from 18-25GHz are not reported, because the test values lower than the limits of 20dB.

Below 1GHz

ACCURATE TECHNOLOGY CO., LTD.

 F1,Bldg,A,Changyuan New Material Port Keyuan Rd,
 Science & Industry Park,Nanshan Shenzhen,P.R.China

 Site: 1# Chamber
 Tel:+86-0755-26503290
 Fax:+86-0755-26503396

 Job No.: alen #4815
 Standard: FCC Class B 3M Radiated
 Test item: Radiation Test
 Temp.(C)/Hum.(%) 25 C / 55 %
 EUT: MID
 Mode: TX 2402MHz
 Model: PC4311BXB
 Manufacturer: Natural Sound

 Polarization: Horizontal
 Power Source: DC 3.7V
 Date: 2014/08/01
 Time: 16:50:31
 Engineer Signature:
 Distance: 3m

Note: Report No:ATE20141486

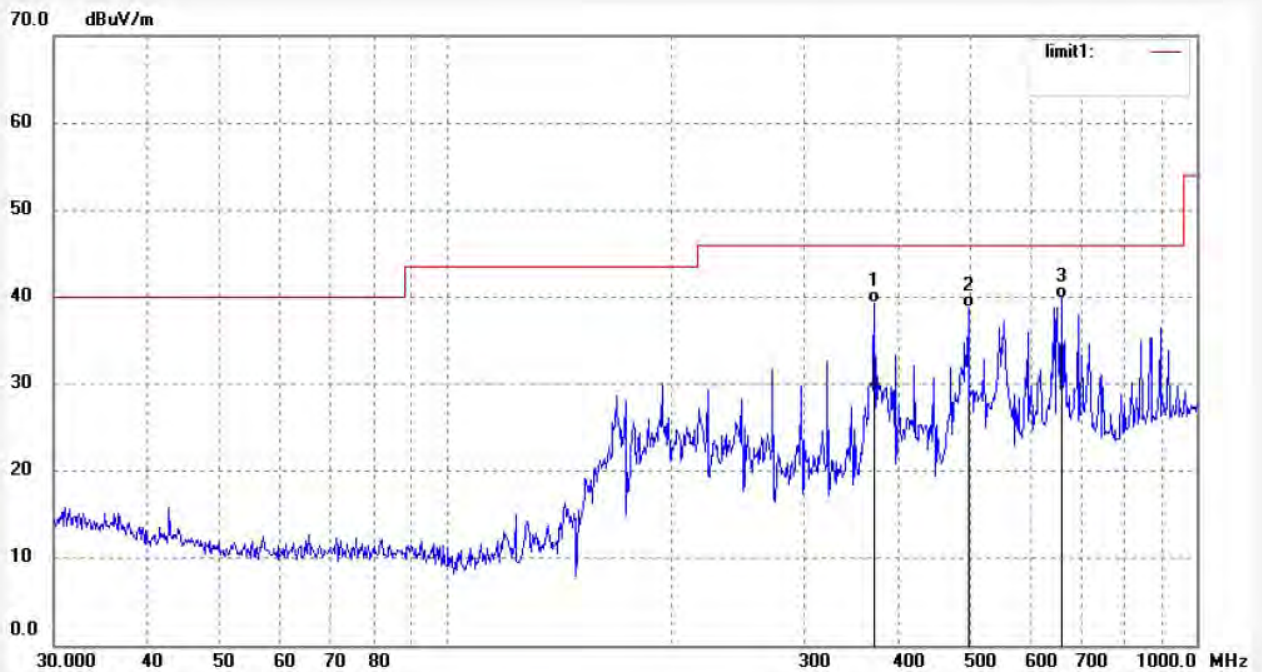

No.	Freq. (MHz)	Reading (dBuV/m)	Factor (dB)	Result (dBuV/m)	Limit (dBuV/m)	Margin (dB)	Detector	Height (cm)	Degree (deg.)	Remark
1	372.0045	48.00	-8.77	39.23	46.00	-6.77	QP			
2	495.9343	46.18	-7.35	38.83	46.00	-7.17	QP			
3	661.1504	44.18	-4.35	39.83	46.00	-6.17	QP			

Job No.: alen #4814	Polarization: Vertical
Standard: FCC Class B 3M Radiated	Power Source: DC 3.7V
Test item: Radiation Test	Date: 2014/08/01
Temp.(C)/Hum.(%) 25 C / 55 %	Time: 16:45:25
EUT: MID	Engineer Signature:
Mode: TX 2402MHz	Distance: 3m
Model: PC4311BXB	
Manufacturer: Natural Sound	

Note: Report No:ATE20141486

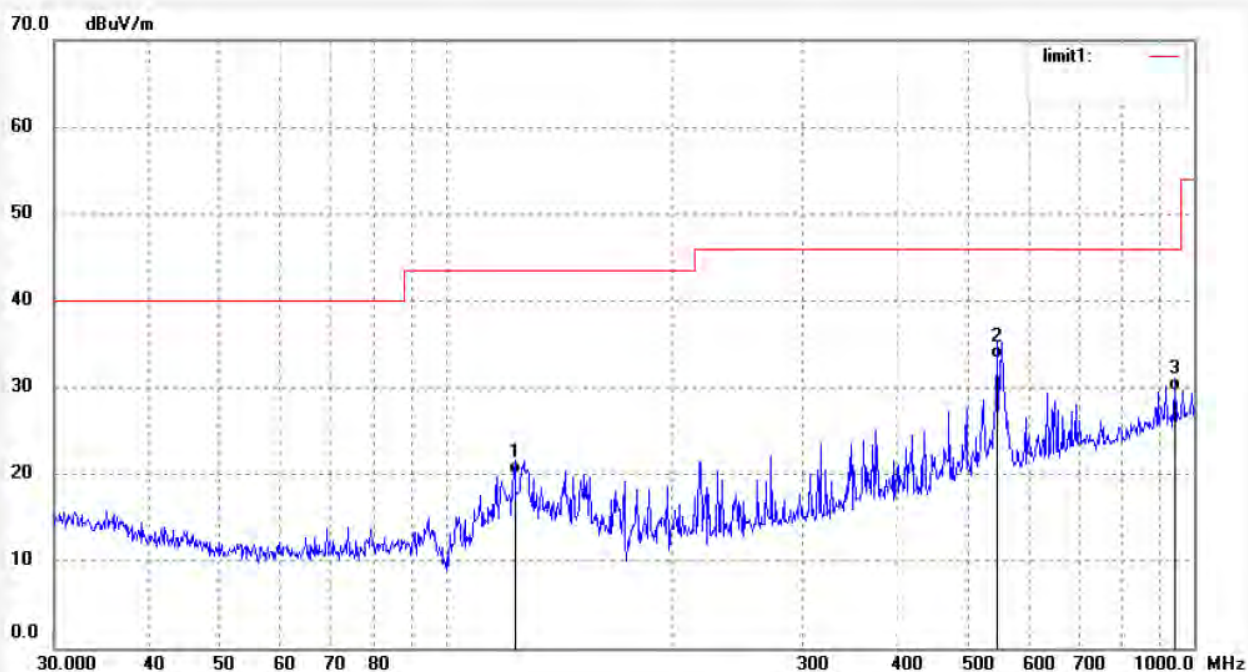

No.	Freq. (MHz)	Reading (dBuV/m)	Factor (dB)	Result (dBuV/m)	Limit (dBuV/m)	Margin (dB)	Detector	Height (cm)	Degree (deg.)	Remark
1	123.6984	35.98	-15.97	20.01	43.50	-23.49	QP			
2	545.1825	39.68	-6.41	33.27	46.00	-12.73	QP			
3	942.1304	29.78	-0.08	29.70	46.00	-16.30	QP			

Job No.: alen #4816

Standard: FCC Class B 3M Radiated

Test item: Radiation Test

Temp.(C)/Hum.(%) 25 C / 55 %

EUT: MID

Mode: TX 2440MHz

Model: PC4311BXB

Manufacturer: Natural Sound

Polarization: Horizontal

Power Source: DC 3.7V

Date: 2014/08/01

Time: 16:51:52

Engineer Signature:

Distance: 3m

Note: Report No:ATE20141486

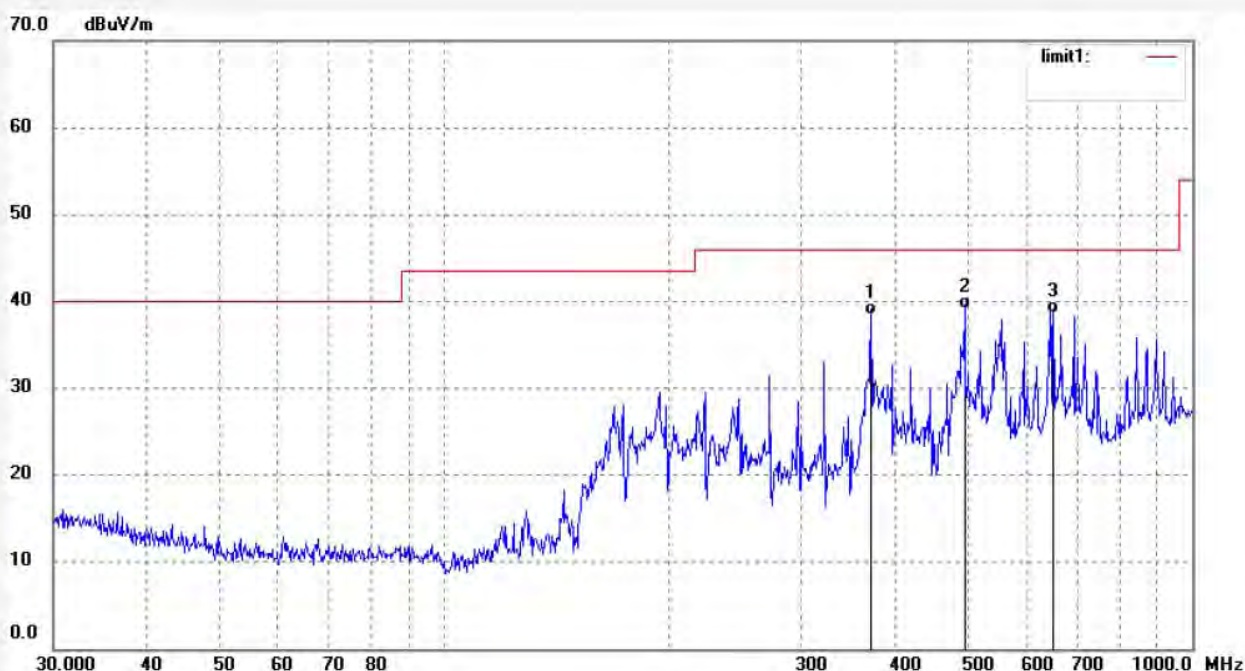

No.	Freq. (MHz)	Reading (dBuV/m)	Factor (dB)	Result (dBuV/m)	Limit (dBuV/m)	Margin (dB)	Detector	Height (cm)	Degree (deg.)	Remark
1	372.0045	47.23	-8.77	38.46	46.00	-7.54	QP			
2	495.9343	46.52	-7.35	39.17	46.00	-6.83	QP			
3	651.9416	43.12	-4.53	38.59	46.00	-7.41	QP			

Job No.: alen #4817
 Standard: FCC Class B 3M Radiated
 Test item: Radiation Test
 Temp.(C)/Hum.(%) 25 C / 55 %
 EUT: MID
 Mode: TX 2440MHz
 Model: PC4311BxB
 Manufacturer: Natural Sound

Polarization: Vertical
 Power Source: DC 3.7V
 Date: 2014/08/01
 Time: 16:53:18
 Engineer Signature:
 Distance: 3m

Note: Report No:ATE20141486

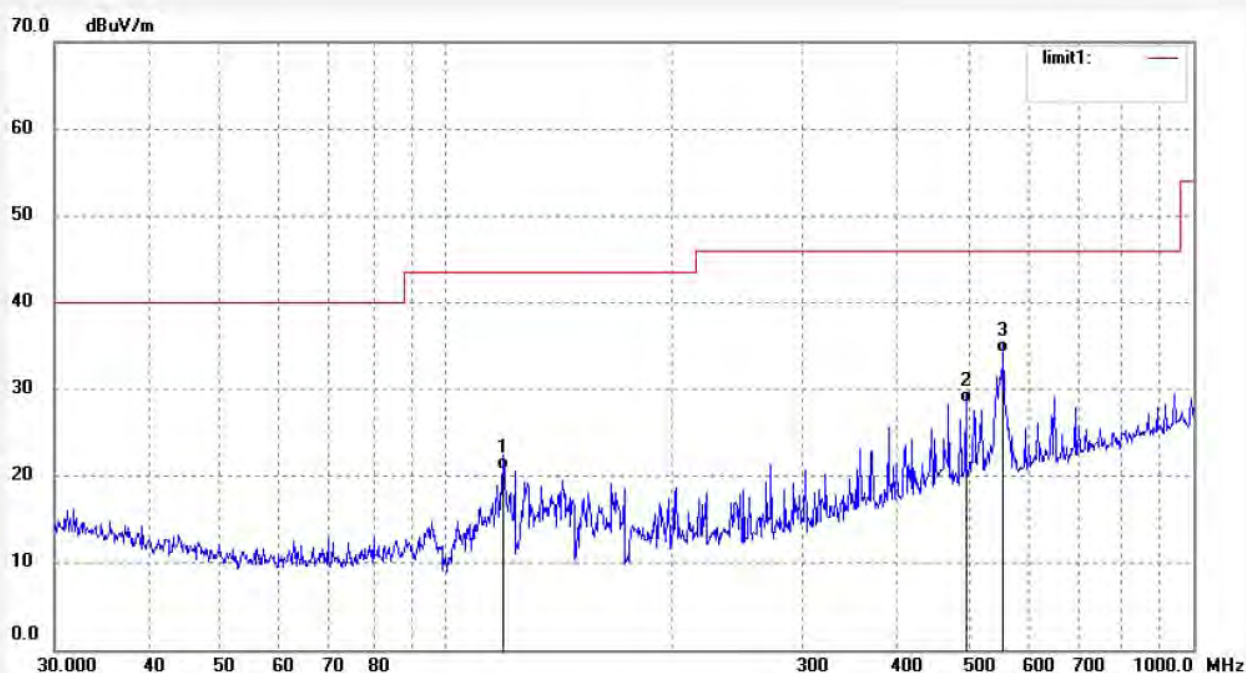

No.	Freq. (MHz)	Reading (dBuV/m)	Factor (dB)	Result (dBuV/m)	Limit (dBuV/m)	Margin (dB)	Detector	Height (cm)	Degree (deg.)	Remark
1	119.4360	36.58	-15.76	20.82	43.50	-22.68	QP			
2	495.9343	35.87	-7.35	28.52	46.00	-17.48	QP			
3	556.7744	40.35	-6.18	34.17	46.00	-11.83	QP			

Job No.: alen #4819
 Standard: FCC Class B 3M Radiated
 Test item: Radiation Test
 Temp.(C)/Hum.(%) 25 C / 55 %
 EUT: MID
 Mode: TX 2480MHz
 Model: PC4311BXB
 Manufacturer: Natural Sound

Polarization: Horizontal
 Power Source: DC 3.7V
 Date: 2014/08/01
 Time: 16:56:17
 Engineer Signature:
 Distance: 3m

Note: Report No:ATE20141486

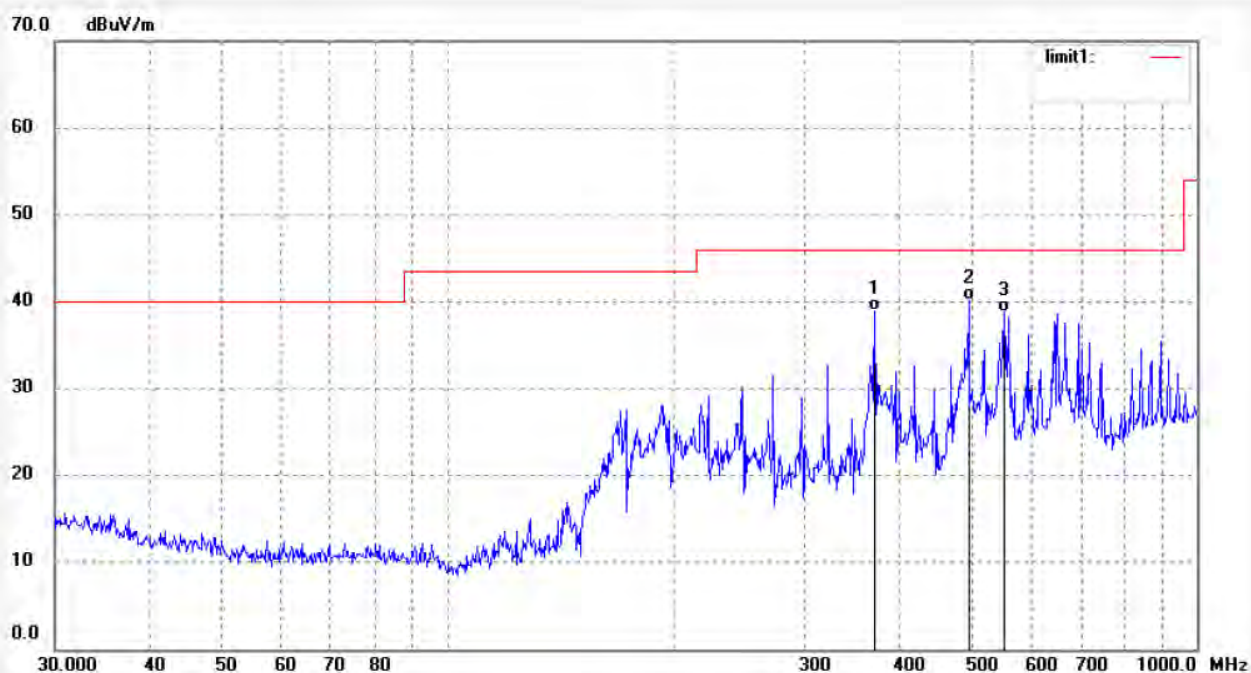

No.	Freq. (MHz)	Reading (dBuV/m)	Factor (dB)	Result (dBuV/m)	Limit (dBuV/m)	Margin (dB)	Detector	Height (cm)	Degree (deg.)	Remark
1	372.0045	47.77	-8.77	39.00	46.00	-7.00	QP			
2	495.9343	47.49	-7.35	40.14	46.00	-5.86	QP			
3	552.8832	44.94	-6.25	38.69	46.00	-7.31	QP			



ACCURATE TECHNOLOGY CO., LTD.

F1,Bldg,A,Changyuan New Material Port Keyuan Rd,
Science & Industry Park,Nanshan Shenzhen,P.R.China

Site: 1# Chamber

Tel:+86-0755-26503290

Fax:+86-0755-26503396

Job No.: alen #4818	Polarization: Vertical
Standard: FCC Class B 3M Radiated	Power Source: DC 3.7V
Test item: Radiation Test	Date: 2014/08/01
Temp.(C)/Hum.(%) 25 C / 55 %	Time: 16:54:49
EUT: MID	Engineer Signature:
Mode: TX 2480MHz	Distance: 3m
Model: PC4311BxB	
Manufacturer: Natural Sound	

Note: Report No:ATE20141486

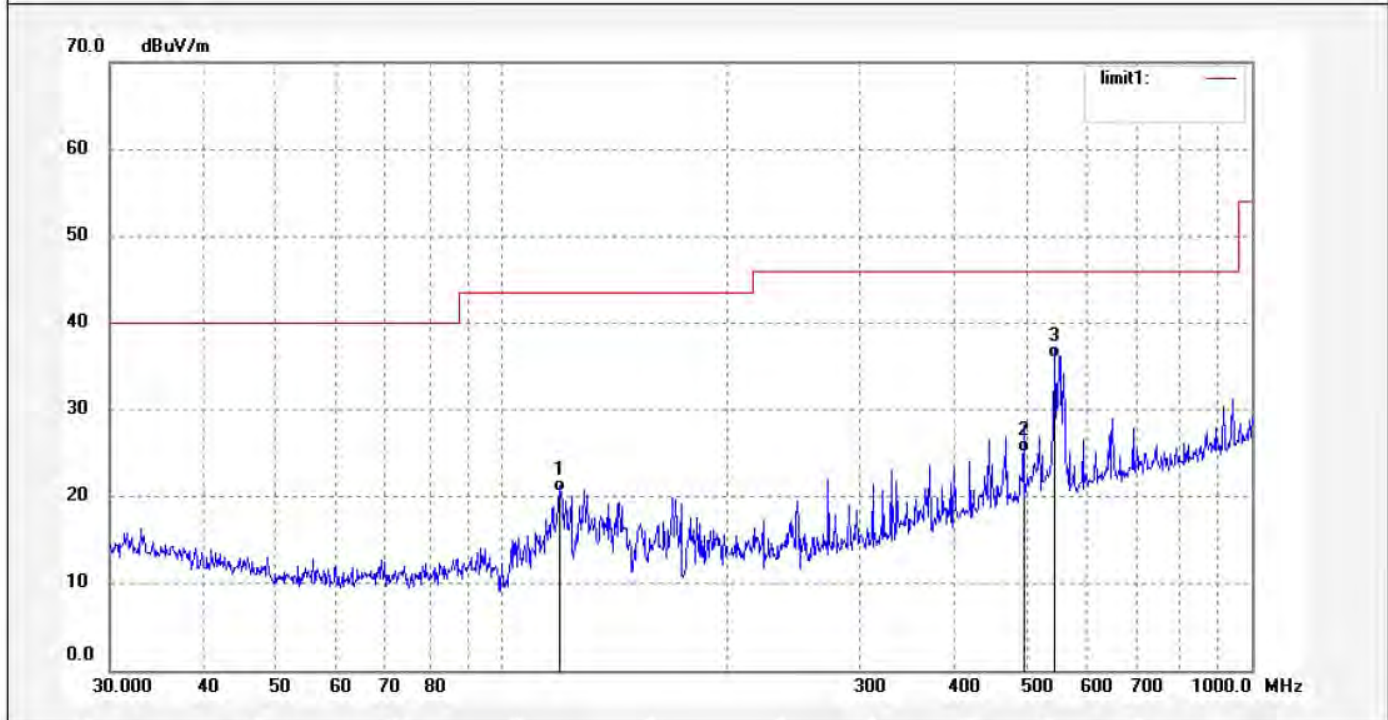

No.	Freq. (MHz)	Reading (dBuV/m)	Factor (dB)	Result (dBuV/m)	Limit (dBuV/m)	Margin (dB)	Detector	Height (cm)	Degree (deg.)	Remark
1	119.4360	36.32	-15.76	20.56	43.50	-22.94	QP			
2	495.9343	32.41	-7.35	25.06	46.00	-20.94	QP			
3	545.1825	42.32	-6.41	35.91	46.00	-10.09	QP			

Above 1GHz



ACCURATE TECHNOLOGY CO., LTD.

F1,Bldg,A,Changyuan New Material Port Keyuan Rd,
Science & Industry Park,Nanshan Shenzhen,P.R.China

Site: 1# Chamber

Tel:+86-0755-26503290

Fax:+86-0755-26503396

Job No.: alen #3597
Standard: FCC Class B 3M Radiated
Test item: Radiation Test
Temp.(C)/Hum.(%) 25 C / 55 %
EUT: MID
Mode: TX 2402MHz
Model: PC4311BXB
Manufacturer: Natural Sound

Polarization: Horizontal
Power Source: DC 3.7V
Date: 14/08/05/
Time: 9/39/04
Engineer Signature:
Distance: 3m

Note: Report No:ATE20141486

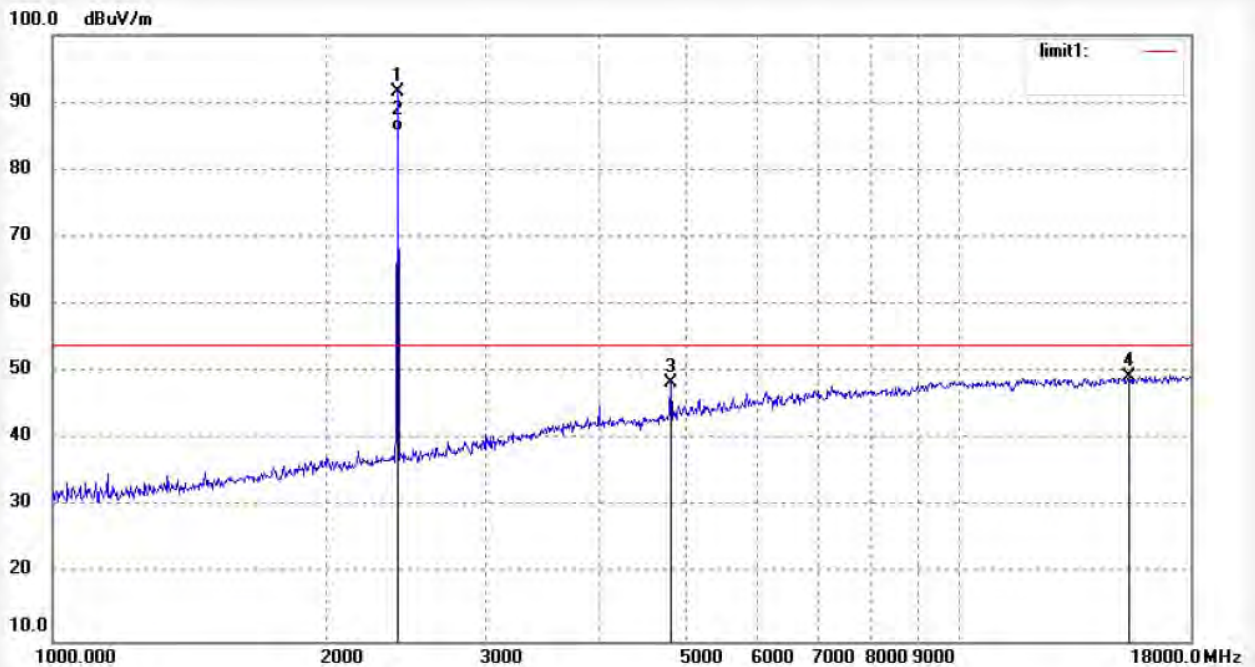

No.	Freq. (MHz)	Reading (dBuV/m)	Factor (dB)	Result (dBuV/m)	Limit (dBuV/m)	Margin (dB)	Detector	Height (cm)	Degree (deg.)	Remark
1	2401.753	98.29	-6.76	91.53						
2	2401.753	92.45	-6.76	85.69						
3	4804.110	50.01	-1.59	48.42	74.00	-25.58	peak			
4	15398.832	37.81	11.38	49.19	74.00	-24.81	peak			

Job No.: alen #3596
 Standard: FCC Class B 3M Radiated
 Test item: Radiation Test
 Temp.(C)/Hum.(%) 25 C / 55 %
 EUT: MID
 Mode: TX 2402MHz
 Model: PC4311BXB
 Manufacturer: Natural Sound

Polarization: Vertical
 Power Source: DC 3.7V
 Date: 14/08/05/
 Time: 9/37/17
 Engineer Signature:
 Distance: 3m

Note: Report No:ATE20141486

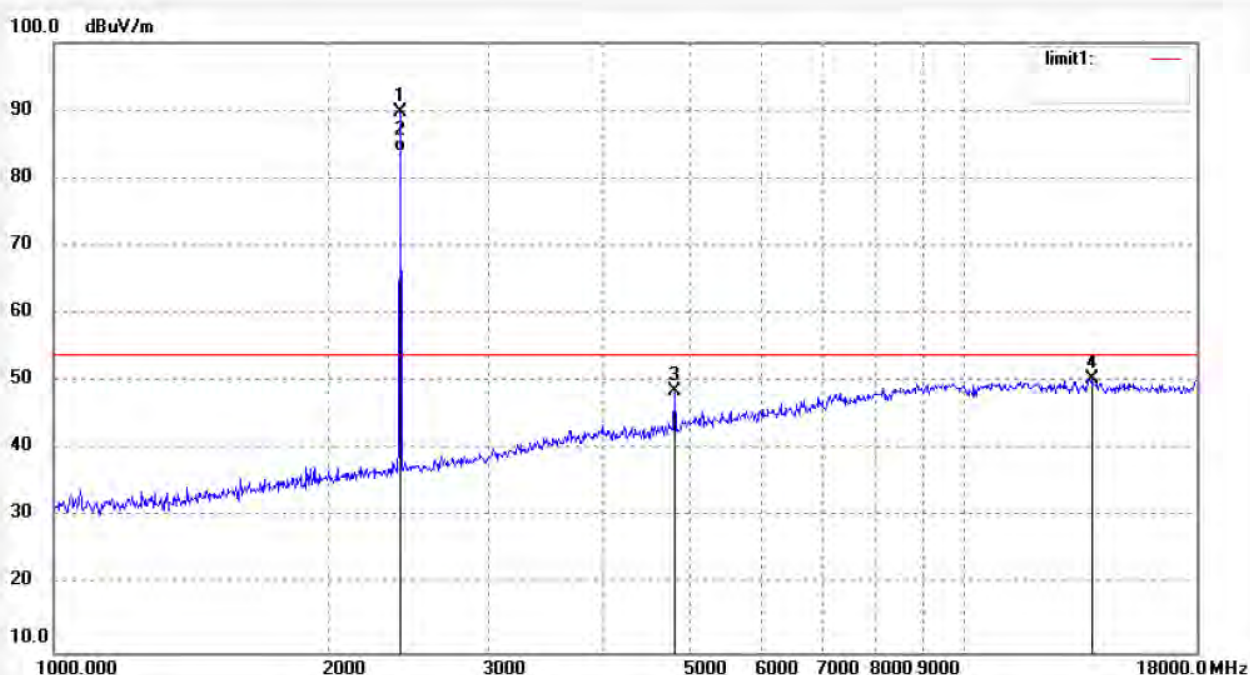

No.	Freq. (MHz)	Reading (dBuV/m)	Factor (dB)	Result (dBuV/m)	Limit (dBuV/m)	Margin (dB)	Detector	Height (cm)	Degree (deg.)	Remark
1	2401.753	96.53	-6.76	89.77						
2	2401.753	90.78	-6.76	84.02						
3	4804.110	50.14	-1.59	48.55	74.00	-25.45	peak			
4	13797.088	40.50	9.87	50.37	74.00	-23.63	peak			



ACCURATE TECHNOLOGY CO., LTD.

F1,Bldg.A,Changyuan New Material Port Keyuan Rd,
Science & Industry Park,Nanshan Shenzhen,P.R.China

Site: 1# Chamber
Tel:+86-0755-26503290
Fax:+86-0755-26503396

Job No.: alen #3598	Polarization: Horizontal
Standard: FCC Class B 3M Radiated	Power Source: DC 3.7V
Test item: Radiation Test	Date: 14/08/05/
Temp.(C)/Hum.(%) 25 C / 55 %	Time: 9/42/01
EUT: MID	Engineer Signature:
Mode: TX 2440MHz	Distance: 3m
Model: PC4311BXB	
Manufacturer: Natural Soundl	

Note: Report No:ATE20141486

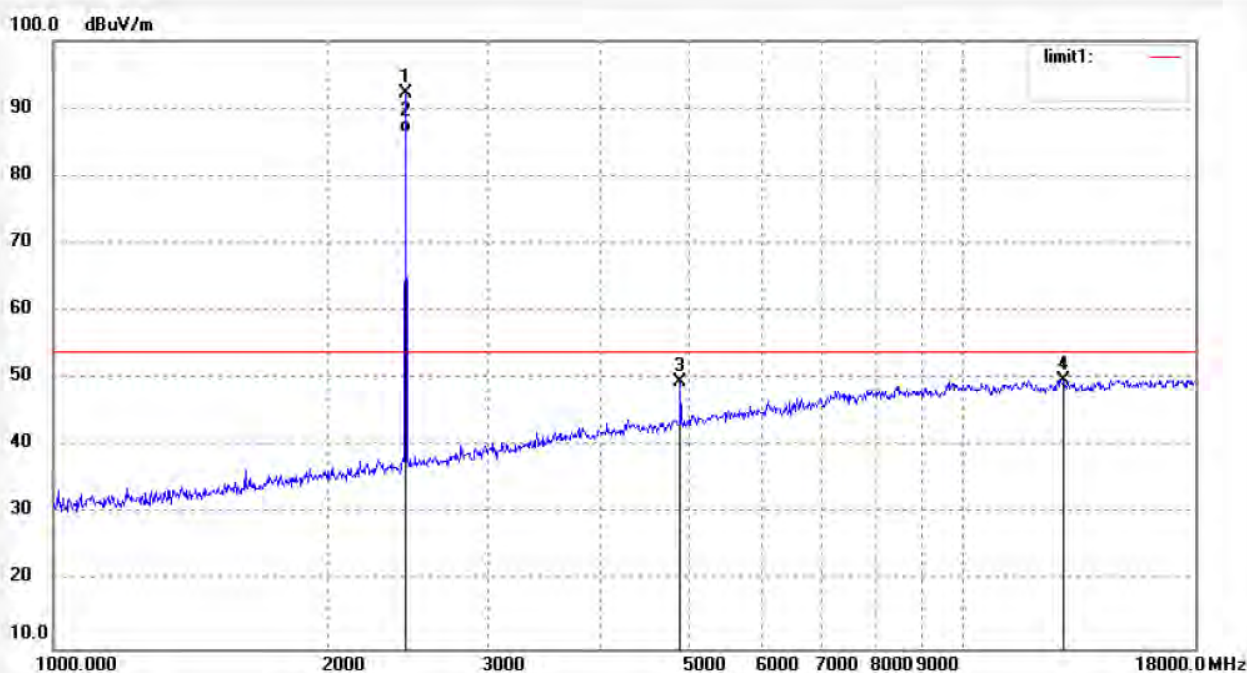

No.	Freq. (MHz)	Reading (dBuV/m)	Factor (dB)	Result (dBuV/m)	Limit (dBuV/m)	Margin (dB)	Detector	Height (cm)	Degree (deg.)	Remark
1	2440.051	98.80	-6.64	92.16						
2	2440.051	92.96	-6.64	86.32						
3	4880.151	50.83	-1.33	49.50	74.00	-24.50	peak			
4	12909.701	41.96	7.76	49.72	74.00	-24.28	peak			

Job No.: alen #3599
 Standard: FCC Class B 3M Radiated
 Test item: Radiation Test
 Temp.(C)/Hum.(%) 25 C / 55 %
 EUT: MID
 Mode: TX 2440MHz
 Model: PC4311BXB
 Manufacturer: Natural Sound

Polarization: Vertical
 Power Source: DC 3.7V
 Date: 14/08/05/
 Time: 9/43/39
 Engineer Signature:
 Distance: 3m

Note: Report No:ATE20141486

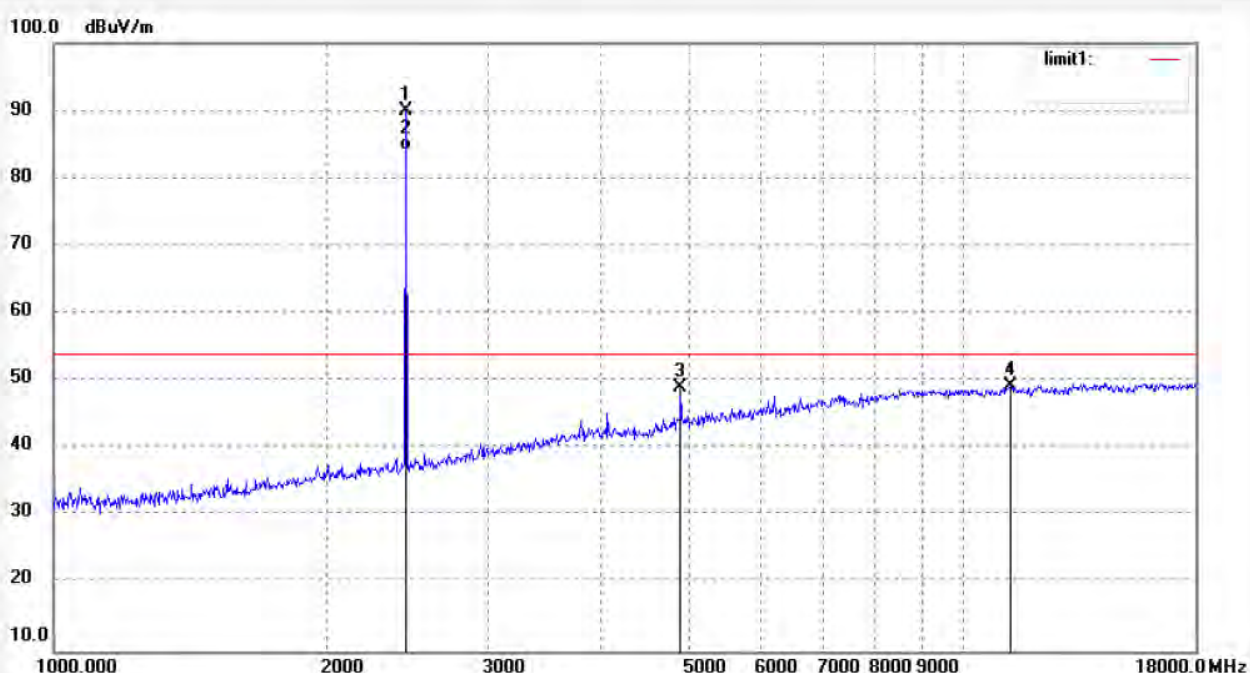

No.	Freq. (MHz)	Reading (dBuV/m)	Factor (dB)	Result (dBuV/m)	Limit (dBuV/m)	Margin (dB)	Detector	Height (cm)	Degree (deg.)	Remark
1	2440.051	96.72	-6.64	90.08						
2	2440.051	90.89	-6.64	84.25						
3	4880.151	50.43	-1.33	49.10	74.00	-24.90	peak			
4	11269.856	43.38	5.80	49.18	74.00	-24.82	peak			

Job No.: alen #3601	Polarization: Horizontal
Standard: FCC Class B 3M Radiated	Power Source: DC 3.7V
Test item: Radiation Test	Date: 14/08/05/
Temp.(C)/Hum.(%) 25 C / 55 %	Time: 9/47/56
EUT: MID	Engineer Signature:
Mode: TX 2480MHz	Distance: 3m
Model: PC4311BXB	
Manufacturer: Natural Sound	

Note: Report No:ATE20141486

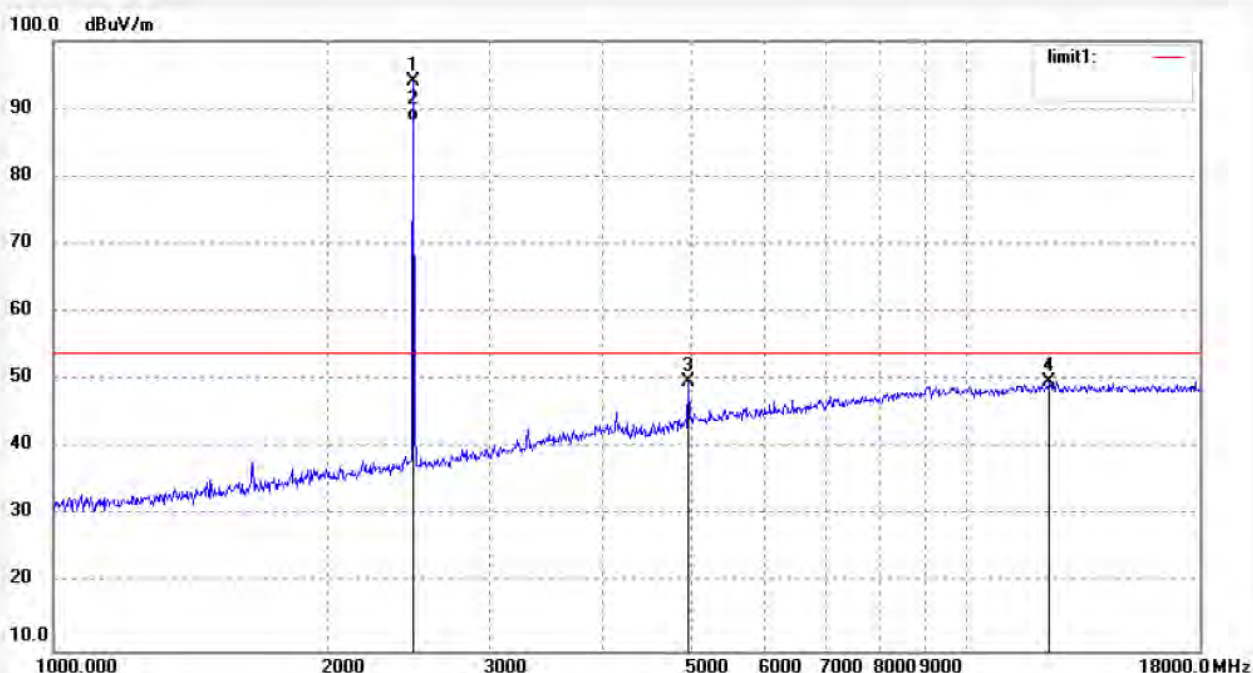

No.	Freq. (MHz)	Reading (dBuV/m)	Factor (dB)	Result (dBuV/m)	Limit (dBuV/m)	Margin (dB)	Detector	Height (cm)	Degree (deg.)	Remark
1	2479.910	100.60	-6.56	94.04						
2	2479.910	94.65	-6.56	88.09						
3	4959.307	50.87	-1.12	49.75	74.00	-24.25	peak			
4	12326.274	42.87	6.93	49.80	74.00	-24.20	peak			



ACCURATE TECHNOLOGY CO., LTD.

F1,Bldg,A,Changyuan New Material Port Keyuan Rd,
Science & Industry Park,Nanshan Shenzhen,P.R.China

Site: 1# Chamber
Tel:+86-0755-26503290
Fax:+86-0755-26503396

Job No.: alen #3600
Standard: FCC Class B 3M Radiated
Test item: Radiation Test
Temp.(C)/Hum.(%) 25 C / 55 %
EUT: MID
Mode: TX 2480MHz
Model: PC4311BxB
Manufacturer: Natural Sound

Polarization: Vertical
Power Source: DC 3.7V
Date: 14/08/05/
Time: 9/46/14
Engineer Signature:
Distance: 3m

Note: Report No:ATE20141486

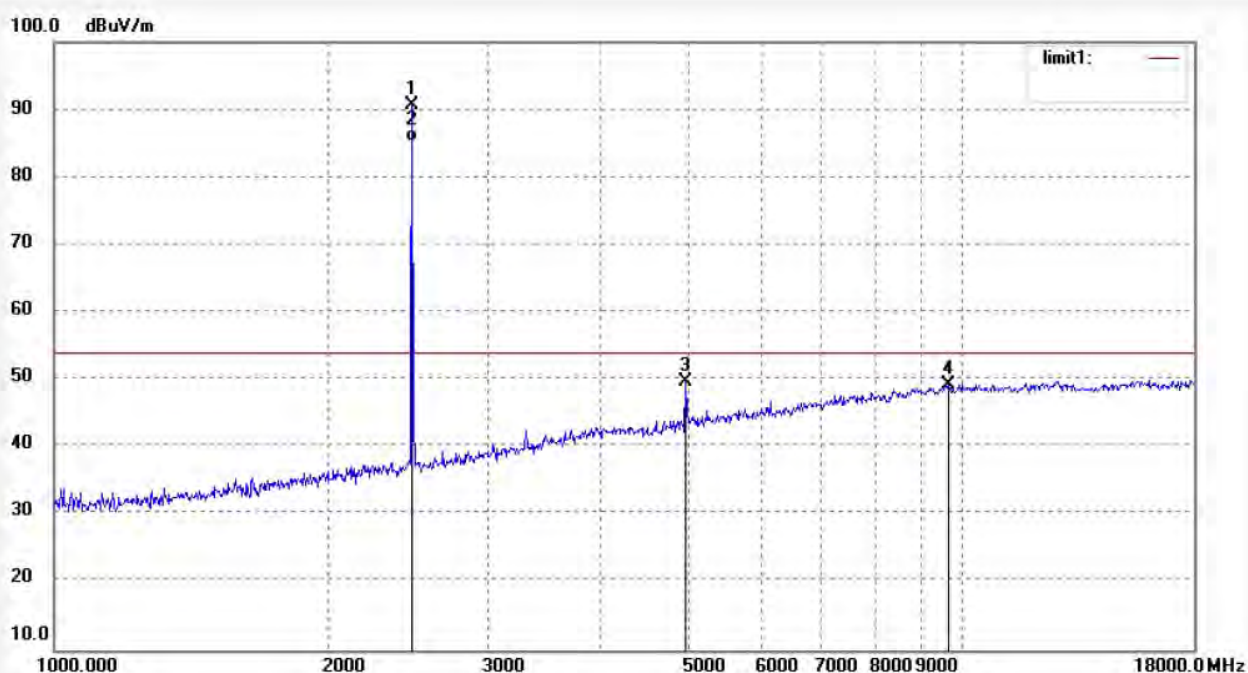

No.	Freq. (MHz)	Reading (dBuV/m)	Factor (dB)	Result (dBuV/m)	Limit (dBuV/m)	Margin (dB)	Detector	Height (cm)	Degree (deg.)	Remark
1	2479.910	97.23	-6.56	90.67						
2	2479.910	91.74	-6.56	85.18						
3	4959.307	50.87	-1.12	49.75	74.00	-24.25	peak			
4	9669.164	44.24	4.97	49.21	574.00	-24.79	peak			

11. CONDUCTED SPURIOUS EMISSION COMPLIANCE TEST

11.1. Block Diagram of Test Setup

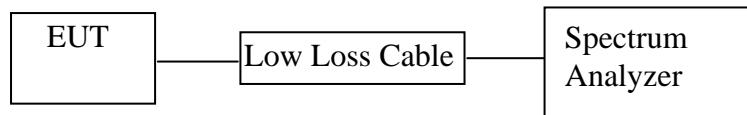

(EUT: MID)

11.2. The Requirement of Section 15.247(d)

Section 15.247(d): In any 100 kHz bandwidth outside the frequency band in which the spread spectrum or digitally modulated intentional radiator is operating, the radio frequency power that is produced by the intentional radiator shall be at least 20 dB below that in the 100 kHz bandwidth within the band that contains the highest level of the desired power, based on either an RF conducted or a radiated measurement, provided the transmitter demonstrates compliance with the peak conducted power limits. If the transmitter complies with the conducted power limits based on the use of RMS averaging over a time interval, as permitted under paragraph (b)(3) of this section, the attenuation required under this paragraph shall be 30 dB instead of 20 dB. Attenuation below the general limits specified in Section 15.209(a) is not required. In addition, radiated emissions which fall in the restricted bands, as defined in Section 15.205(a), must also comply with the radiated emission limits specified in Section 15.209(a).

11.3. EUT Configuration on Measurement

The equipment is installed on the emission measurement to meet the commission requirements and operating regulations in a manner which tends to maximize its emission characteristics in normal application.

11.4. Operating Condition of EUT

11.4.1. Setup the EUT and simulator as shown as Section 11.1.

11.4.2. Turn on the power of all equipment.

11.4.3. Let the EUT work in TX modes measure it. The transmit frequency are 2402-2480 MHz. We select 2402MHz, 2440MHz, and 2480MHz TX frequency to transmit.

11.5. Test Procedure

11.5.1. The transmitter output was connected to the spectrum analyzer via a low loss cable.

11.5.2. Set RBW of spectrum analyzer to 100kHz and VBW to 300kHz

11.5.3. The Conducted Spurious Emission was measured and recorded.

11.6. Test Result

Pass.

The spectrum analyzer plots are attached as below.

BLE Channel Low 2402MHz

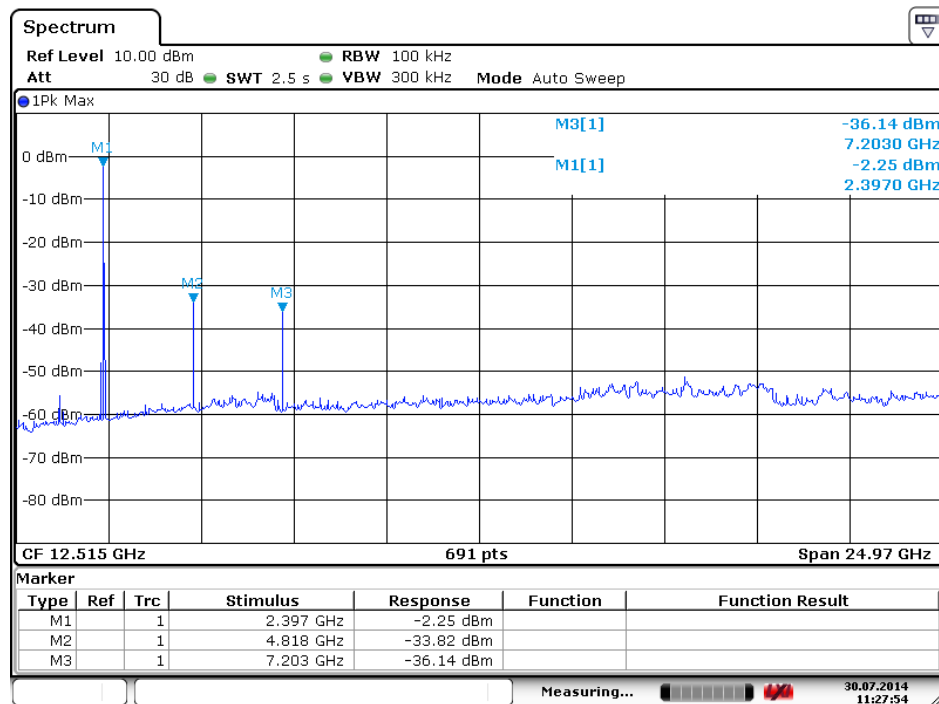

Date: 30.JUL.2014 11:27:54

BLE Channel Middle 2440MHz

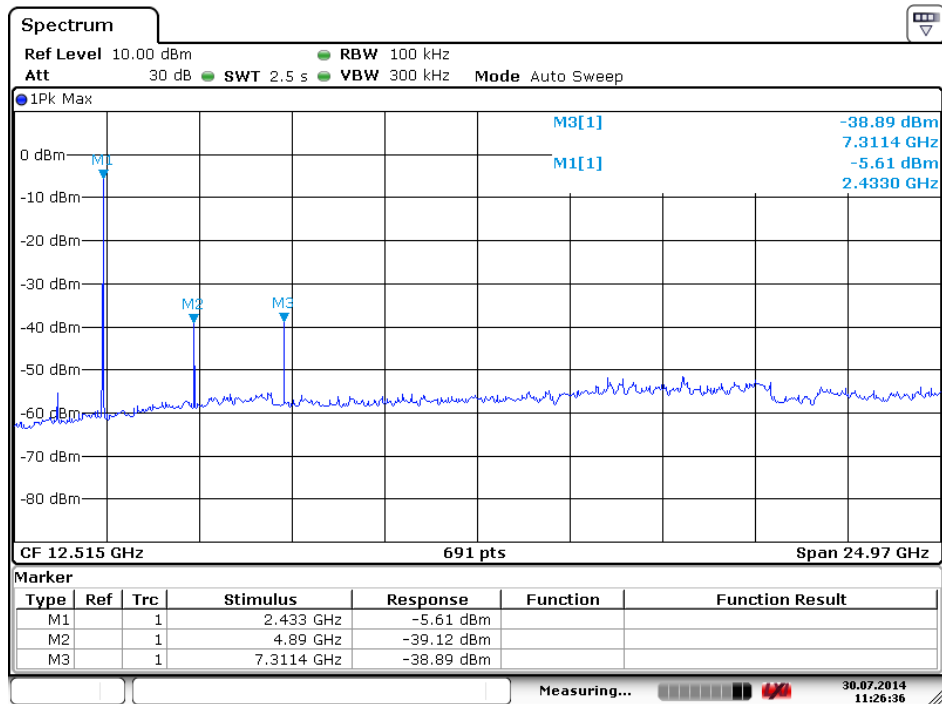

Date: 30.JUL.2014 11:26:36

BLE Channel High 2480MHz

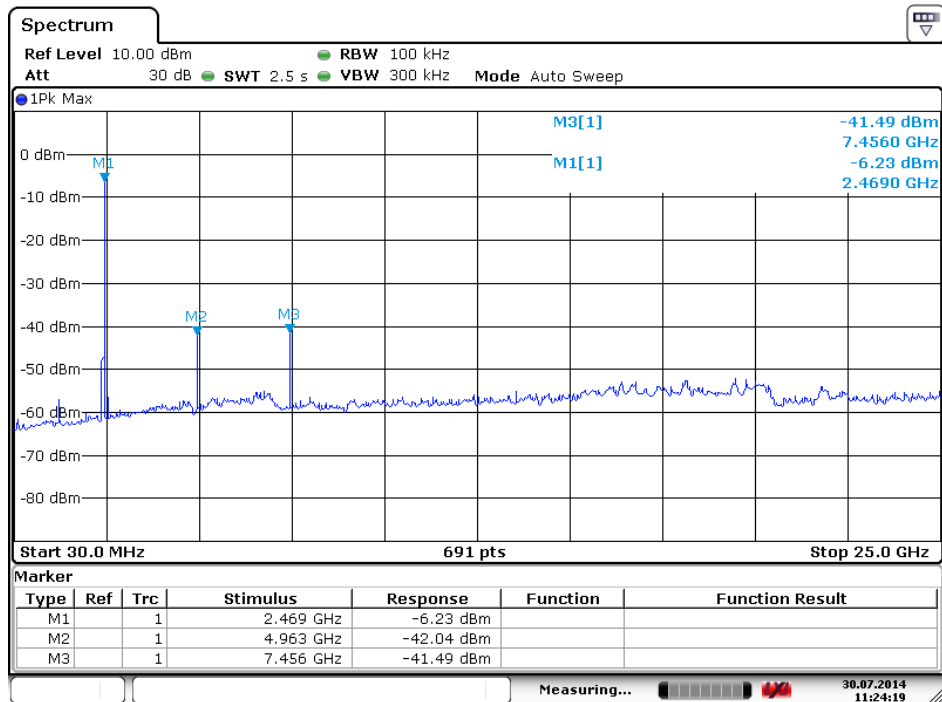

Date: 30.JUL.2014 11:24:19

12. ANTENNA REQUIREMENT

12.1. The Requirement

According to Section 15.203, an intentional radiator shall be designed to ensure that no antenna other than that furnished by the responsible party shall be used with the device.

12.2. Antenna Construction

Device is equipped with unique antenna, which isn't displaced by other antenna. Therefore, the equipment complies with the antenna requirement of Section 15.203.

Antenna

