

FCC Test Report

Part 15 subpart C

Client Information:

Applicant: HONG KONG NATURAL SOUND ELECTRONICS LIMITED
Applicant add.: FLAT/ RM M 4/F CONTINENTAL MANSION 300 KING'S ROAD HONG KONG

Product Information:

EUT Name: Tablet PC
Model No.: PC1028ITC, Trio Windows 10.1 OD(**Details refer to page 4**)
Brand Name: Trio
FCC ID: PWK-PC1028ITC

Standards: FCC PART 15 Subpart C: 2016 section 15.247

Prepared By:

Dongguan Yaxu (AiT) Technology Limited

Add. : No.22, Jinqianling Third Street, Jitigang, Huangjiang,
Dongguan, Guangdong, China

Date of Receipt: Jan. 18, 2016

Date of Test: Jan. 19~ Mar. 01, 2016

Date of Issue: Mar. 02, 2016

Test Result: Pass

This device described above has been tested by Dongguan Yaxu(AiT) Technology Limited, and the test results show that the equipment under test (EUT) is in compliance with the FCC requirements. And it is applicable only to the tested sample identified in the report.

*This test report must not be used by the client to claim product endorsement by any agency of the U.S. government.

Reviewed by: Seal-Chen

Approved by: Jin

1 Contents

	Page
COVER PAGE	
1 CONTENTS	2
2 VERSION	3
3 TEST SUMMARY	4
3.1 COMPLIANCE WITH FCC PART 15 SUBPART C	4
3.2 MEASUREMENT UNCERTAINTY	5
3.3 TEST LOCATION	5
4 TEST FACILITY	6
4.1 DEVIATION FROM STANDARD	6
4.2 ABNORMALITIES FROM STANDARD CONDITIONS	6
5 GENERAL INFORMATION	7
5.1 GENERAL DESCRIPTION OF EUT	7
5.2 EUT PERIPHERAL LIST	9
5.3 TEST PERIPHERAL LIST	9
6 EQUIPMENTS LIST FOR ALL TEST ITEMS	10
7 TEST RESULT	11
7.1 DESCRIPTION OF TEST CONDITIONS	11
7.2 ANTENNA REQUIREMENT	12
7.3 CONDUCTION EMISSIONS MEASUREMENT	13
7.4 RADIATED EMISSIONS MEASUREMENT	17
7.5 6 DB BANDWIDTH	48
7.6 MAXIMUM PEAK OUTPUT POWER	55
7.7 PEAK POWER SPECTRAL DENSITY	57
7.8 BAND EDGES REQUIREMENT	65
7.9 CONDUCTED SPURIOUS EMISSIONS	70
8 PHOTOGRAPHS	89
8.1 RADIATED SPURIOUS EMISSION TEST SETUP	89
8.2 CONDUCTED EMISSION TEST SETUP	90
9 APPENDIX-PHOTOGRAPHS OF EUT CONSTRUCTIONAL DETAILS	91

2 Version

Revision Record				
Version	Chapter	Date	Modifier	Remark
00	--	Mar. 02, 2016	--	--

3 Test Summary

3.1 Compliance with FCC Part 15 subpart C

TEST	TEST REQUIREMENT	TEST METHOD	RESULT
Antenna Requirement	FCC PART 15 C section 15.247 (c) and Section 15.203	FCC PART 15 C section 15.247 (c) and Section 15.203	PASS
Conducted Emissions at Mains Terminals	FCC PART 15 C section 15.207	ANSI C63.10: Clause 6.2	PASS
Radiated Spurious Emission (30 MHz to 25 GHz)	FCC PART 15 C section 15.209 &15.247(d)	ANSI C63.10: Clause 6.4, 6.5 and 6.6	PASS
6 dB Bandwidth	FCC PART 15 C section 15.247 (a)(2)	ANSI C63.10: Clause 6.9.1	PASS
Maximum Peak Output Power	FCC PART 15 C section 15.247(b)(3)	FCC/KDB-558074 D01 vv03r04 Clause 9.1.2	PASS
Peak Power Spectral Density	FCC PART 15 C section 15.247(e)	ANSI C63.10: Clause 6.11.2.3	PASS
Band Edges Measurement	FCC PART 15 C section 15.247 (d) &15.205	FCC/KDB-558074 D01 vv03r04 Clause 13.3.1	PASS
Conducted Spurious Emission (30MHz to 25GHz)	FCC PART 15 C section 15.209 &15.247(d)	ANSI C63.10: Clause 6.7	PASS

Remark:

N/A: not applicable. Refer to the relative section for the details.

EUT: In this whole report EUT means Equipment Under Test.

Tx: In this whole report Tx (or tx) means Transmitter.

Rx: In this whole report Rx (or rx) means Receiver.

RF: In this whole report RF means Radio Frequency.

ANSI C63.10: the detail version is ANSI C63.10:2009 in the whole report.

The product support for Bluetooth mode and WiFi mode, this report is test for WiFi mode, for Bluetooth mode please refers to the report number E-F1601004-2

According to the confirmation from the applicant, since the electrical circuit design, layout, components used and internal wiring were identical for the all models, with only difference being the model name.

Therefore only one model **PC1028ITC** was tested in this report.

3.2 Measurement Uncertainty

All measurements involve certain levels of uncertainties, the following measurements uncertainty Levels have estimated based on standards, the maximum value of the uncertainty as below:

No.	Item	Uncertainty
1	Conducted Emission Test	1.20dB
2	Radiated Emission Test	3.30dB

3.3 Test Location

All tests were performed at:

Dongguan Yaxu (AiT) Technology Limited
No.22, Jinqianling Third Street, Jitigang, Huangjiang, Dongguan, Guangdong, China
Tel.: +86.769.82020499 Fax.: +86.769.82020495

4 Test Facility

The test facility is recognized, certified or accredited by the following organizations:

.CNAS- Registration No: L6177

Dongguan Yaxu (AiT) technology Limited is accredited to ISO/IEC 17025:2005 general Requirements for the competence of testing and calibration laboratories (CNAS-CL01 Accreditation Criteria for the competence of testing and calibration laboratories) on Apr. 18, 2013

.FCC- Registration No: 248337

The 3m Semi-Anechoic Chamber, 3m/10m Open Area Test Site and Shielding Room of Dongguan Yaxu (AiT) Technology Limited have been registered by Federal Communications Commission (FCC) on Aug.29, 2014.

.Industry Canada(IC)-Registration No: IC6819A

The 3m Semi-Anechoic Chamber and 3m/10m Open Area Test Site of Dongguan Yaxu (AiT) Technology Limited have been registered by Certification and Engineering Bureau of Industry Canada for radio equipment testing on Oct. 01, 2014.

4.1 Deviation from standard

None

4.2 Abnormalities from standard conditions

None

5 General Information

5.1 General Description of EUT

Manufacturer:	Natural Sound Electronics (Shenzhen) Co., Ltd.
Manufacturer Address:	4th building, Xinyuan industrial zone, Gushu village, Bao'an district, Shenzhen, China
EUT Name:	Tablet PC
Model No:	PC1028ITC
Brand Name:	Trio
Derivative model No.:	Trio Windows 10.1 OD
Operation frequency:	2412 MHz to 2462 MHz for 802.11b/g/n(HT20)
Number of Channels:	11 Channels for 802.11b/g/n(HT20)
Modulation Technology:	802.11b: CCK/QPSK/BPSK 802.11g/n: BPSK/QPSK/16QAM/64QAM
Transmit Data Rate:	802.11b :1/2/5.5/11 Mbps 802.11g :6/9/12/18/24/36/48/54 Mbps 802.11n(HT20): 6.5/13/19.5/26/39/52/58.8/65 Mbps
Channel Separation:	5 MHz
Antenna Type:	FPCB antenna
Antenna Gain:	maximum 2.0 dBi
H/W No.:	V2.1A
S/W No.:	V1.0
Power Supply Range:	DC 5V 2A from adapter, AC 120V/60Hz for adapter or DC 3.7V from battery
Power Cord:	0.8 m x 2 wires unscreened DC cable
Note:	
	1. For a more detailed features description, please refer to the manufacturer's specifications or the User's Manual.

EUT channels and frequencies list:

1. Test frequencies are lowest channel: 2412 MHz, middle channel: 2437 MHz and highest channel: 2462 MHz for 802.11b/g/n(HT20)

Channel	Frequency (MHz)	Channel	Frequency (MHz)
1	2412	7	2442
2	2417	8	2447
3	2422	9	2452
4	2427	10	2457
5	2432	11	2462
6	2437		

5.2 EUT Peripheral List

No	Equipment	Manufacturer	Model No.	Serial No.	Power cord	signal cable
1	N/A	N/A	N/A	N/A	N/A	N/A

5.3 Test Peripheral List

No	Equipment	Manufacturer	Model No.	Serial No.	Power cord	signal cable
1	Adapter	SHENZHEN KEYU POWER SUPPLY TECHNOLOGY CO.,LTD	KA23-0502000 USS	N/A	0.8m/unshield ed /detachable	N/A
	Keyboard	HONG KONG NATURAL SOUND ELECTRONICS LIMITED	N/A	N/A	N/A	Accessory equipment

6 Equipments List for All Test Items

No	Test Equipment	Manufacturer	Model No	Serial No	Cal. Date	Cal. Due Date
1	Spectrum Analyzer	ADVANTEST	R3182	150900201	2015.06.29	2016.06.28
2	EMI Measuring Receiver	R&S	ESR	101660	2015.06.29	2016.06.28
3	Low Noise Pre Amplifier	Tsj	MLA-10K01-B01-27	1205323	2015.06.29	2016.06.28
4	Low Noise Pre Amplifier	Tsj	MLA-0120-A02-34	2648A04738	2015.06.29	2016.06.28
5	TRILOG Super Broadband test Antenna	SCHWARZBECK	VULB9160	9160-3206	2015.06.29	2016.06.28
6	Broadband Horn Antenna	SCHWARZBECK	BBHA9120D	452	2015.06.29	2016.06.28
7	SHF-EHF Horn	SCHWARZBECK	BBHA9170	BBHA917036 7	2015.06.29	2016.06.28
8	50Ω Coaxial Switch	Anritsu	MP59B	6200264416	2015.06.29	2016.06.28
9	EMI Test Receiver	R&S	ESCI	100124	2015.06.29	2016.06.28
10	LISN	Kyoritsu	KNW-242	8-837-4	2015.06.29	2016.06.28
11	LISN	Kyoritsu	KNW-407	8-1789-3	2015.06.29	2016.06.28
12	50Ω Coaxial Switch	Anritsu	MP59B	6200264417	2015.06.29	2016.06.28
13	Loop Antenna	ETS	6512	00165355	2015.06.29	2016.06.28
14	Radiated Cable 1# (30MHz-1GHz)	FUJIKURA	5D-2W	01	2016.01.04	2017.01.03
15	Radiated Cable 2# (1GHz -25GHz)	FUJIKURA	10D2W	02	2016.01.04	2017.01.03
16	Conducted Cable 1#(9KHz-30MHz)	FUJIKURA	1D-2W	01	2016.01.04	2017.01.03
17	Power Meter	Anritsu	ML2495A	N/A	2015.06.29	2016.06.28
18	Power sensor	Anritsu	MA2411B	N/A	2015.06.29	2016.06.28
19	SMA Antenna connector	Dosin	Dosin-SMA	N/A	N/A	N/A

Note: The SMA antenna connector is soldered on the PCB board in order to perform conducted tests and this SMA antenna connector is listed in the equipment list.

7 Test Result

7.1 Description of Test conditions

- (1) EUT was tested in normal configuration (Please See following Block diagram)

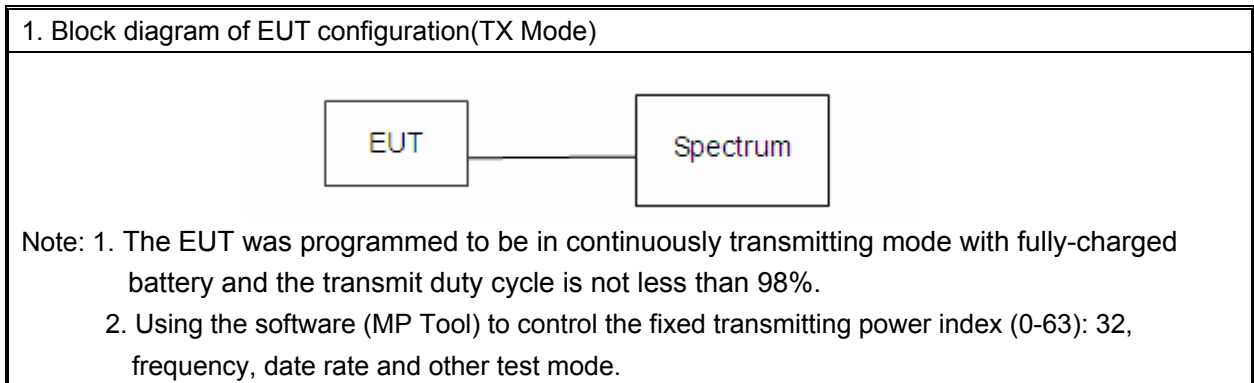

- (2) E.U.T. test conditions:

15.31(e): For intentional radiators, measurements of the variation of the input power or the radiated signal level of the fundamental frequency component of the emission, as appropriate, shall be performed with the supply voltage varied between 85% and 115% of the nominal rated supply voltage. For battery operated equipment, the equipment tests shall be performed using a new battery.

15.32: Power supplies and CPU boards used with personal computers and for which separate authorizations are required to be obtained shall be tested as follows: Testing shall be in accordance with the procedures specified in Section 15.31 of this part.

- (3) Test frequencies:

According to the 15.31(m) Measurements on intentional radiators or receivers, other than TV broadcast receivers, shall be performed and. If required reported for each band in which the device can be operated with the device operating at the number of frequencies in each band specified in the following table:

Frequency range over which device operates	Number of frequencies	Location in the range of operation
1 MHz or less	1	Middle
1 to 10 MHz	2	1 near top and 1 near bottom
More than 10 MHz	3	1 near top, 1 near middle and 1 near bottom

- (4) Frequency range of radiated measurements:

According to the 15.33, the test range will be up to the tenth harmonic of the highest fundamental frequency.

- (5) Pre-test the EUT in all transmitting mode at the lowest, middle and highest channel with different data rate and conducted to determine the worst-case mode, only the worst-case results are recorded in this report.

7.2 Antenna Requirement

7.2.1 Standard requirement

15.203 requirement: For intentional device, according to 15.203: an intentional radiator shall be designed to ensure that no antenna other than that furnished by the responsible party shall be used with the device.

15.247(c) (1)(i) requirement: (i) Systems operating in the 2400-2483.5 MHz band that is used exclusively for fixed. Point-to-point operations may employ transmitting antennas with directional gain greater than 6dBi provided the maximum conducted output power of the intentional radiator is reduced by 1 dB for every 3 dB that the directional gain of the antenna exceeds 6dBi.

7.2.2 EUT Antenna

The antenna is FPCB antenna and no consideration of replacement. Antenna gain is maximum 2.0 dBi from 2.4GHz to 2.5GHz.

7.3 Conduction Emissions Measurement

Test Requirement: FCC Part 15 C section 15.207
Test Method: ANSI C63.10: Clause 6.2
Frequency Range: 150 kHz to 30 MHz
Detector: Peak for pre-scan (9kHz Resolution Bandwidth)
Test Limit

Limits for conducted disturbance at the mains ports of class B

Frequency Range (MHz)	Class B Limit (dBuV)	
	Quasi-peak	Average
0.15 to 0.50	66 to 56	56 to 46
0.50 to 5	56	46
5 to 30	60	50

NOTE 1 The limit decreases linearly with the logarithm of the frequency in the range 0,15 MHz to 0,50 MHz.

EUT Operation: Test in normal operating mode. For intentional radiators, measurements of the variation of the input power or the radiated signal level of the fundamental frequency component of the emission, as appropriate, shall be performed with the supply voltage varied between 85% and 115% of the nominal rated supply voltage.
Pre-Scan has been conducted to determine the worst-case mode from all possible combinations between available modulations, data rates and antenna ports (if EUT with antenna diversity architecture).

Test procedure

1. The mains terminal disturbance voltage test was conducted in a shielded room.
2. The EUT was connected to AC power source through a LISN 1 (Line Impedance Stabilization Network) which provides a 50Ω/50μH + 5Ω linear impedance. The power cables of all other units of the EUT were connected to a second LISN 2, which was bonded to the ground reference plane in the same way as the LISN 1 for the unit being measured. A multiple socket outlet strip was used to connect multiple power cables to a single LISN provided the rating of the LISN was not exceeded.
3. The tabletop EUT was placed upon a non-metallic table 0.8m above the ground reference plane. And for floor-standing arrangement, the EUT was placed on the horizontal ground reference plane, but separated from metallic contact with the ground reference plane by 0.1m of insulation.
4. The test was performed with a vertical ground reference plane. The rear of the EUT shall be 0,4 m from the vertical ground reference plane. The vertical ground reference plane was bonded to the horizontal ground reference plane. The LISN 1 was placed 0,8 m from the boundary of the unit under test and bonded to a ground reference plane for LISNs mounted on top of the ground reference plane. This distance was between the closest points of the LISN 1 and the EUT. All other units of the EUT and associated equipment was at least 0,8 m from the LISN 2.

Test setup

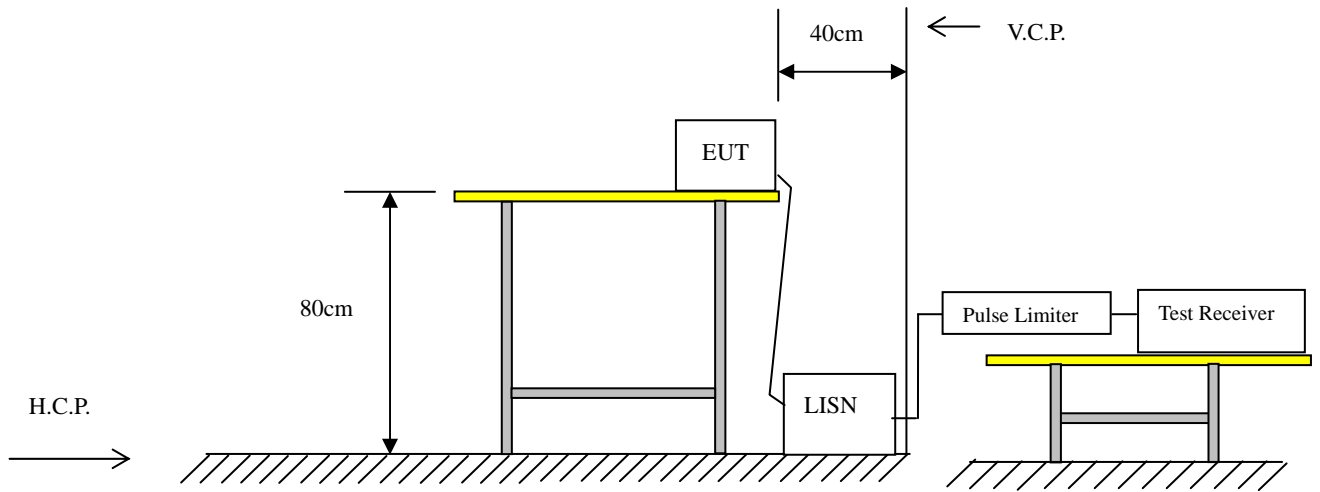

7.3.1 Test results

EUT:	Tablet PC	Model Name. :	PC1028ITC
Temperature:	26 °C	Relative Humidity:	54%
Pressure:	1010hPa	Test Date :	2016-02-23
Test Mode:	TX 802.11b (11Mbps) CH1 (worst case)	Phase :	Line
Test Voltage :	DC 5V from adapter, AC 120V/60Hz for adapter		

Frequency (MHz)	Meter Reading (dBμV)	Factor(dB)	Emission Level (dBμV)	Limits (dBμV)	Over (dB)	Detector
0.1660	42.40	11.61	54.01	65.15	-11.14	Quasi-Peak
0.1660	28.04	11.61	39.65	55.15	-15.50	Average
0.4620	30.85	10.05	40.90	46.66	-5.76	Quasi-Peak
0.5020	38.72	10.01	48.73	56.00	-7.27	Average
1.6380	26.19	9.97	36.16	46.00	-9.84	Quasi-Peak
1.7220	36.45	9.97	46.42	56.00	-9.58	Average

Remark: Factor = LISN factor + Cable Loss + Pulse limiter factor.

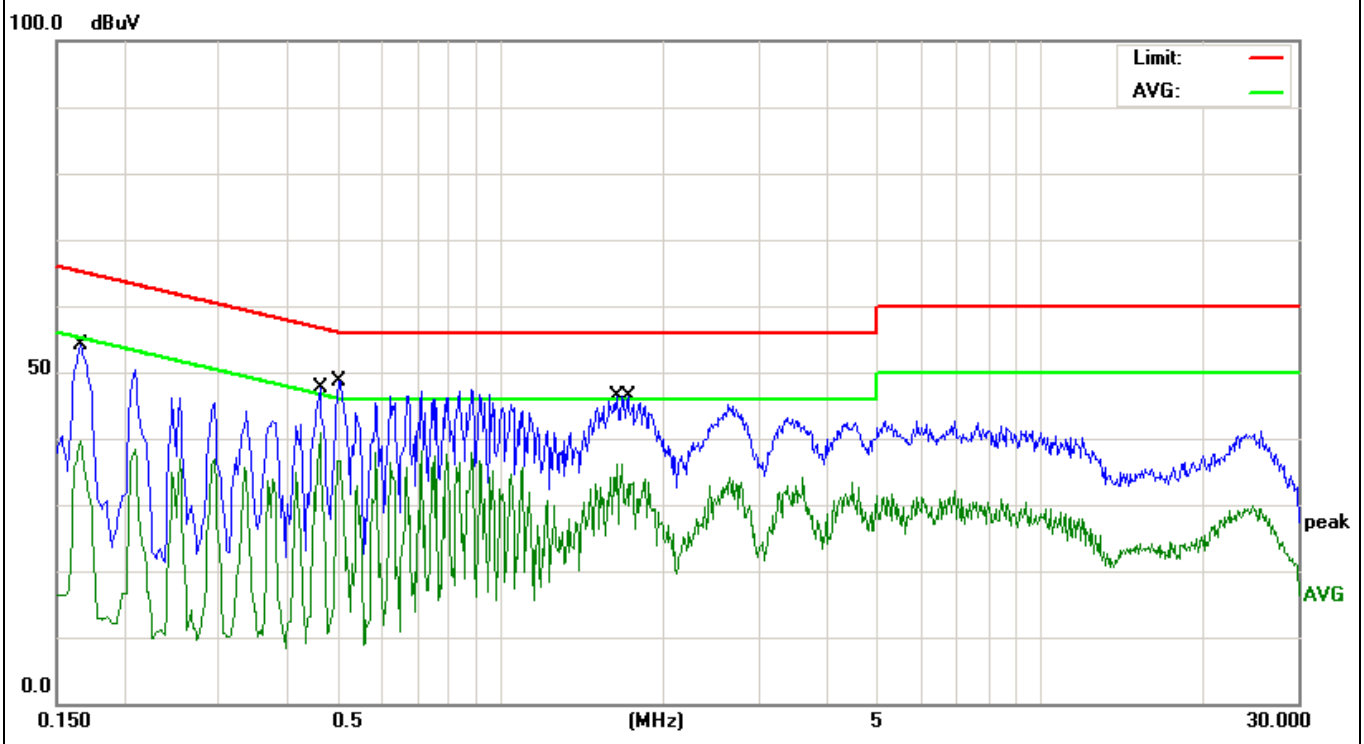

EUT:	Tablet PC	Model Name. :	PC1028ITC
Temperature:	26 °C	Relative Humidity:	54%
Pressure:	1010hPa	Test Date :	2016-02-23
Test Mode:	TX 802.11b (11Mbps) CH1 (worst case)	Phase :	Neutral
Test Voltage :	DC 5V from adapter, AC 120V/60Hz for adapter		

Frequency (MHz)	Meter Reading (dBμV)	Factor(dB)	Emission Level (dBμV)	Limits (dBμV)	Over (dB)	Detector
0.1620	24.58	11.68	36.26	55.36	-19.10	Quasi-Peak
0.1700	41.32	11.55	52.87	64.96	-12.09	Average
0.4620	28.49	10.05	38.54	46.66	-8.12	Quasi-Peak
0.5060	37.60	10.01	47.61	56.00	-8.39	Average
1.6380	24.34	9.97	34.31	46.00	-11.69	Quasi-Peak
1.7500	33.99	9.97	43.96	56.00	-12.04	Average

Remark: Factor = LISN factor + Cable Loss + Pulse limiter factor.

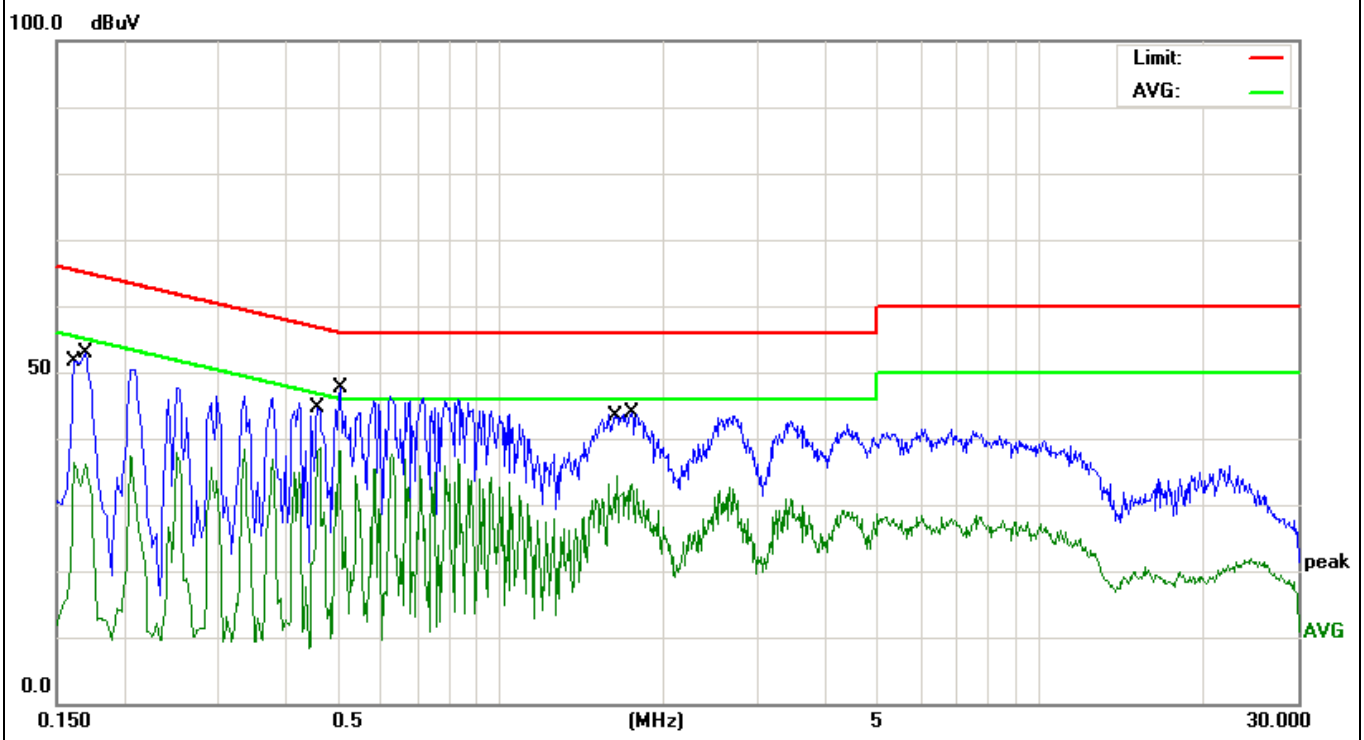

7.4 Radiated Emissions Measurement

Test Requirement:	FCC Part 15 C section 15.247 (d) In any 100 kHz bandwidth outside the frequency band in which the spread spectrum or digitally modulated intentional radiator is operating. The radio frequency power that is produced by the intentional radiator shall be at least 20 dB below that in the 100 kHz bandwidth within the band that contains the highest level of the desired power, based on either an RF conducted or a radiated measurement, and provided the transmitter demonstrates compliance with the peak conducted power limits.
Test Method:	ANSI C63.10: Clause 6.4, 6.5 and 6.6
Test Status:	Pre-Scan has been conducted to determine the worst-case mode from all possible combinations between available modulations, data rates and antenna ports (if EUT with antenna diversity architecture). Following channel(s) was (were) selected for the final test as listed below. Pre-test the EUT under 2 modes: power-supplied by using the AC adapter and power-supplied by using internal battery. After pre-testing, we found the worst case is the test mode of EUT power-supplied by using internal battery.
Detector:	For PK value: RBW = 1 MHz for $f \geq 1$ GHz, 100 kHz for $f < 1$ GHz VBW \geq RBW Sweep = auto Detector function = peak Trace = max hold For AV value: RBW = 1 MHz for $f \geq 1$ GHz, 100 kHz for $f < 1$ GHz VBW = 10Hz Sweep = auto Detector function = peak Trace = max hold
15.209 Limit:	40.0 dB μ V/m between 30MHz & 88MHz 43.5 dB μ V/m between 88MHz & 216MHz 46.0 dB μ V/m between 216MHz & 960MHz 54.0 dB μ V/m above 960MHz

Test Configuration:

1) 9 kHz to 30 MHz emissions:

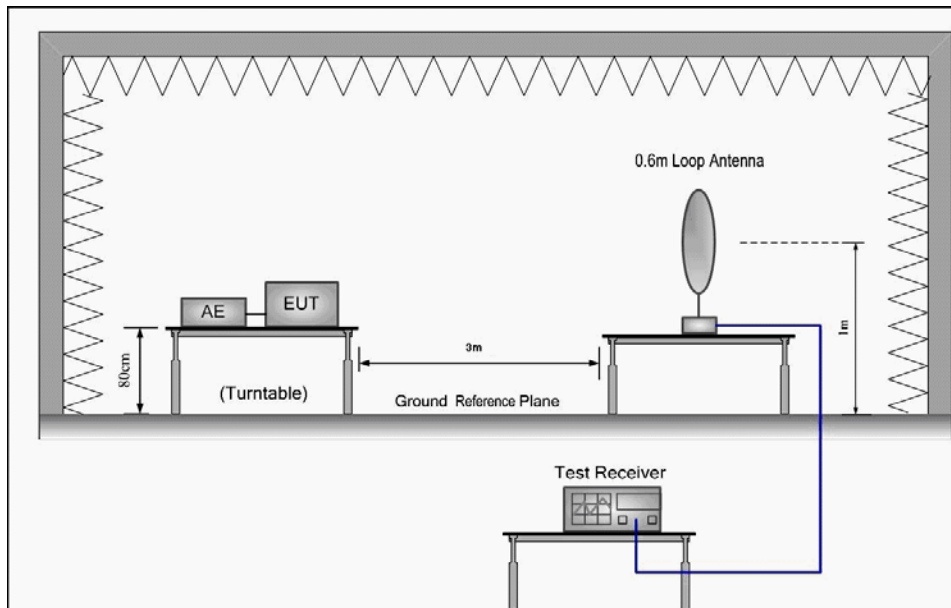

2) 30 MHz to 1 GHz emissions:

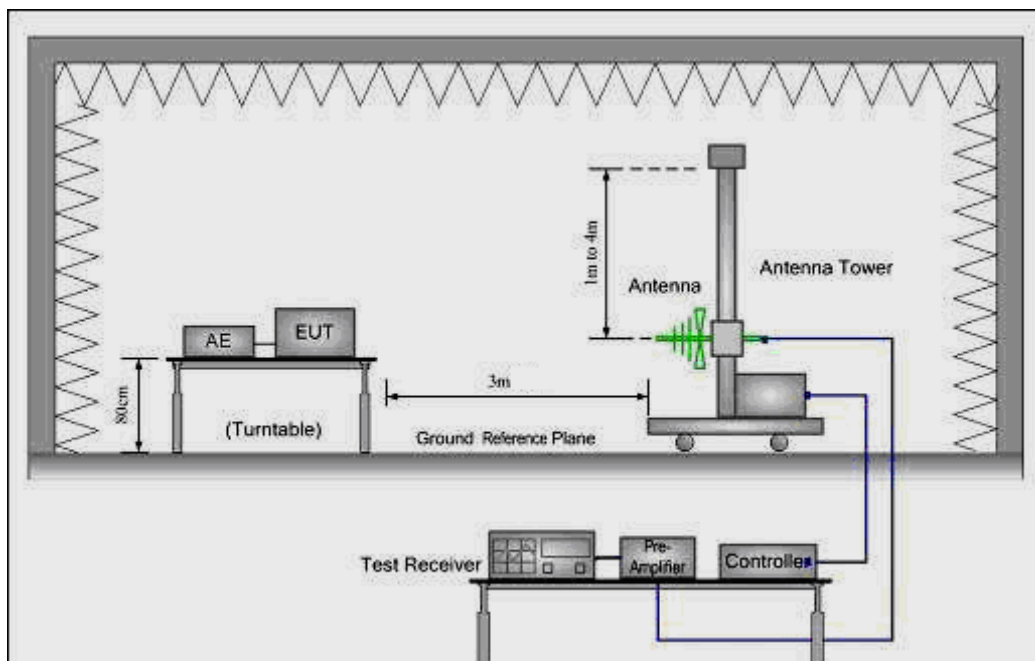

3) 1 GHz to 40 GHz emissions:

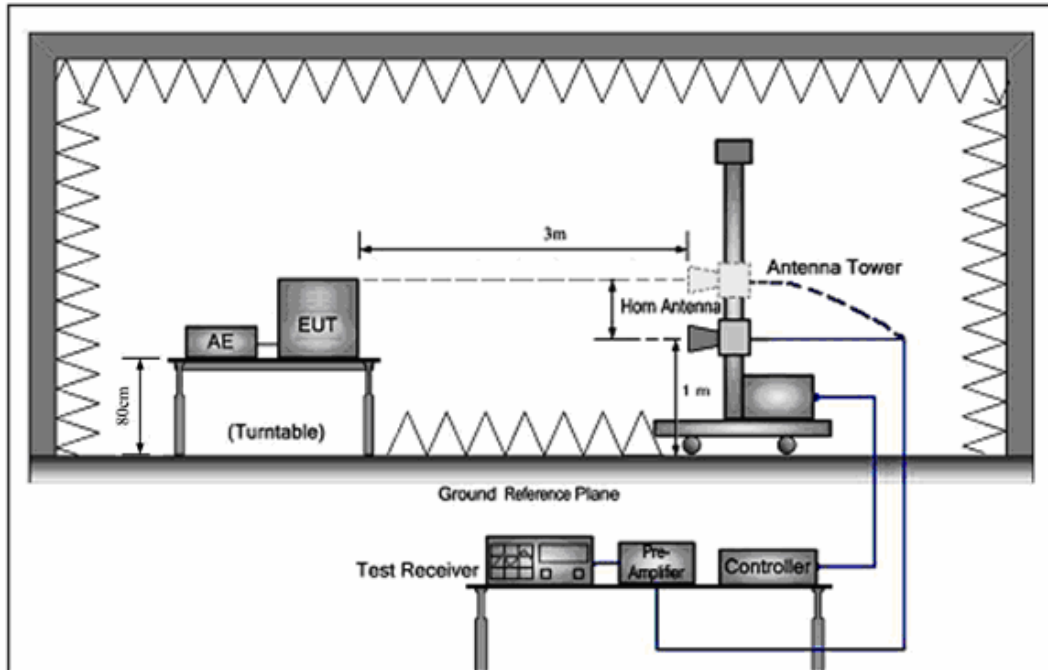

Test procedure:

Test site with RF absorbing material covering the ground plane that met the site validation criterion called out in CISPR 16-1-4:2007 was used to perform radiated emission test above 1 GHz.

The receiver was scanned from 30MHz to 25GHz. When an emission was found, the table was rotated to produce the maximum signal strength. An initial pre-scan was performed for in peak detection mode using the receiver. The EUT was measured for both the Horizontal and Vertical polarities and performed a pre-test three orthogonal planes. For intentional radiators, measurements of the variation of the input power or the radiated signal level of the fundamental frequency component of the emission, as appropriate, shall be performed with the supply voltage varied between 85% and 115% of the nominal rated supply voltage. The worst case emissions were reported.

From 30MHz to 1GHz, read the Quasi-Peak field strength of the emissions with receiver QP detector RBW=120KHz.

Above 1GHz, read the Peak field strength and Average field strength.

Read the Peak field strength through RBW=1MHz,VBW=3MHz in spectrum analyzer setting;

Read the Average field strength through RBW=1MHz,VBW=10Hz in spectrum analyzer setting;

For measurement at frequency above 1GHz

Place the measurement antenna away from each area of the EUT determined to be a source of emissions at the specified measurement distance, while keeping the measurement antenna aimed at the source of emissions at each frequency of significant emissions, with polarization oriented for maximum response. The measurement antenna may have to be higher or lower than the EUT, depending on the radiation pattern of the emission and staying aimed at the emission source for receiving the maximum signal. The final measurement antenna elevation shall be that which maximizes the emissions. The measurement antenna elevation for maximum emissions shall be restricted to a range of heights of from 1 m to 4 m above the ground or reference ground plane.

While maintaining all of the other instrument settings. This peak level, once corrected, must comply with the limit specified in Section 15.209. If the dwell time per channel of the hopping signal is less than 100 ms, then the average field strength reading obtained with the 10 Hz VBW may be further adjusted by a "duty cycle correction factor", derived from $20\log(\text{dwell time}/100 \text{ ms})$, in an effort to demonstrate compliance with the 15.209 limit.

The radiation measurements are performed in X, Y, Z axis positioning. And found the Y axis positioning which it is worse case, only the test worst case mode is recorded in the report.

7.4.1 Test Result

7.4.1.1 Radiated Emissions Test Data Below 30MHz

EUT:	Tablet PC	Model Name :	PC1028ITC
Temperature:	25 °C	Test Data	2016-02-23
Pressure:	1005 hPa	Relative Humidity:	60%
Test Mode :	TX	Test Voltage :	DC 3.7V from battery
Measurement Distance	3 m	Frenqucy Range	9KHz to 30MHz
RBW/VBW	9KHz~150KHz/RB 200Hz for QP, 150KHz~30MHz/RB 9KHz for QP		

No emission found between lowest internal used/generated frequencies to 30MHz.

7.4.1.2 Radiated Emissions Test Data 30MHz-1000MHz

EUT:	Tablet PC	Model Name :	PC1028ITC
Temperature:	25 °C	Test Data	2016-02-23
Pressure:	1010 hPa	Relative Humidity:	60%
Test Mode :	TX:802.11b 2.412 GHz(worst-case)	Test Voltage :	DC 3.7V from battery
Measurement Distance	3 m	Frenqucy Range	30MHz to 1GHz
RBW/VBW	100KHz / 300KHz for spectrum, RBW=120KHz for receiver.		

Test at Channel 1 (2.412 GHz) in transmitting status

30 MHz~1 GHz Spurious Emissions .Quasi-Peak Measurement

Vertical:

Peak scan

Level (dBμV/m)

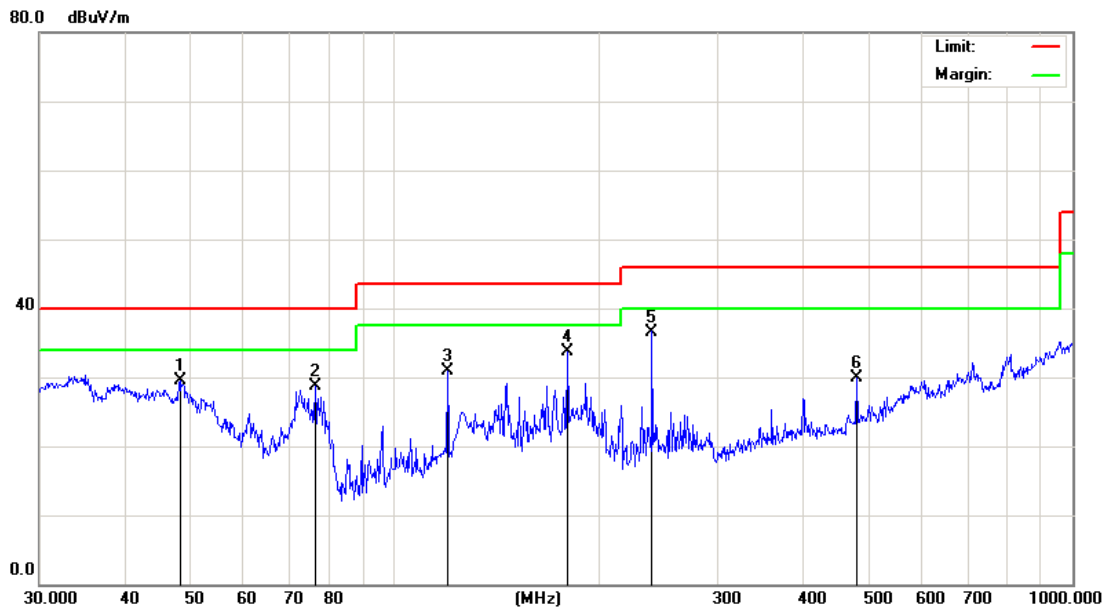

Quasi-peak measurement

No.	Mk.	Freq. MHz	Reading Level dBuV	Correct Factor dB	Measure- ment dBuV/m	Limit dBuV/m	Over dB	Detector
1		48.5016	47.99	-18.43	29.56	40.00	-10.44	QP
2		76.5121	47.80	-19.17	28.63	40.00	-11.37	QP
3		119.8555	45.77	-14.87	30.90	43.50	-12.60	QP
4		180.0165	48.27	-14.60	33.67	43.50	-9.83	QP
5	*	239.9874	48.24	-11.64	36.60	46.00	-9.40	QP
6		480.5276	35.80	-5.90	29.90	46.00	-16.10	QP

Horizontal:

Peak scan

Level (dB μ V/m)

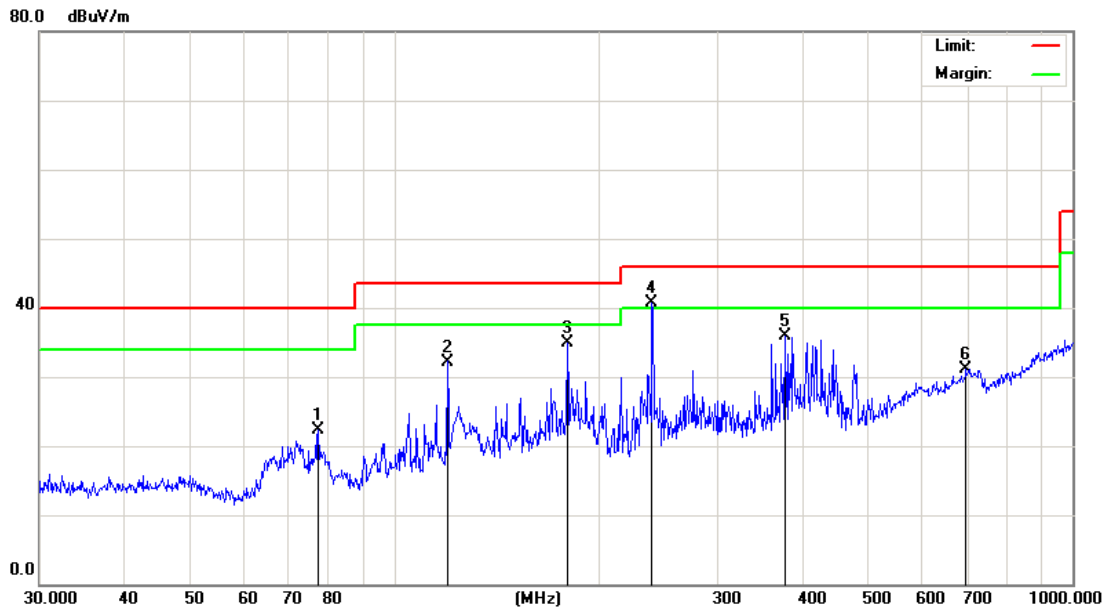

Quasi-peak measurement

No.	Mk.	Freq. MHz	Reading Level dB μ V	Correct Factor dB	Measure- ment dB μ V/m	Limit dB μ V/m	Over dB	Detector
1		77.3212	41.10	-18.85	22.25	40.00	-17.75	QP
2		119.8555	47.10	-14.90	32.20	43.50	-11.30	QP
3		180.0165	46.59	-11.59	35.00	43.50	-8.50	QP
4	*	239.9874	52.39	-11.64	40.75	46.00	-5.25	QP
5		377.2590	43.45	-7.55	35.90	46.00	-10.10	QP
6		696.8567	30.96	0.24	31.20	46.00	-14.80	QP

EUT:	Tablet PC	Model Name :	PC1028ITC
Temperature:	25 °C	Test Data	2016-02-23
Pressure:	1010 hPa	Relative Humidity:	60%
Test Mode :	TX:802.11b 2.437 GHz(worst-case)	Test Voltage :	DC 3.7V from battery
Measurement Distance	3 m	Frenqucy Range	30MHz to 1GHz
RBW/VBW	100KHz / 300KHz for spectrum, RBW=120KHz for receiver.		

Test at Channel 6 (2.437 GHz) in transmitting status

30 MHz~1 GHz Spurious Emissions .Quasi-Peak Measurement

Vertical:

Peak scan

Level (dBμV/m)

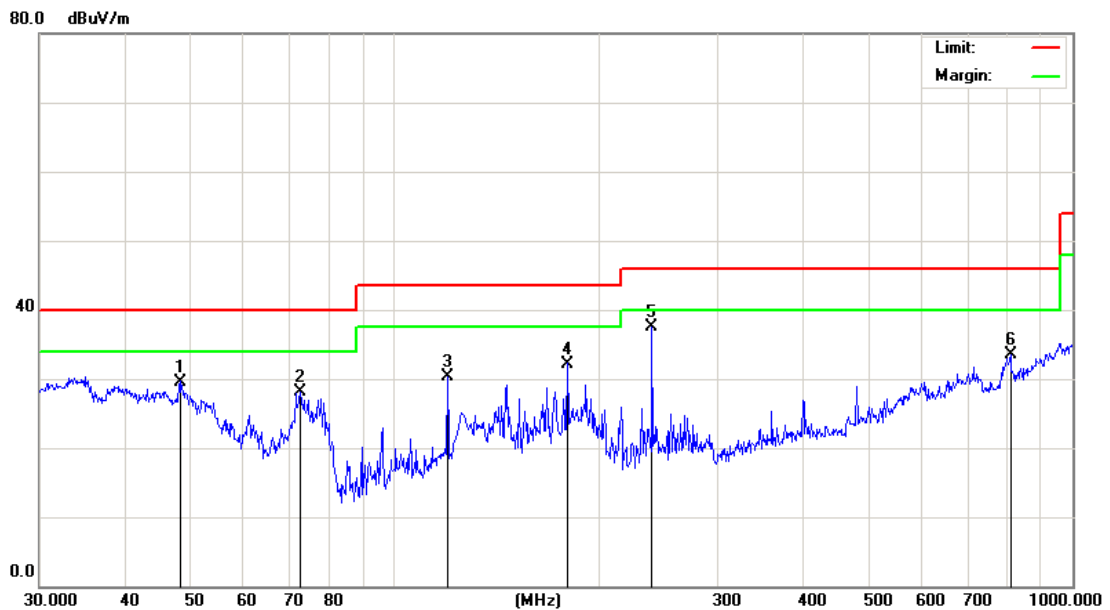

Quasi-peak measurement

No. Mk.	Freq. MHz	Reading Level dBuV	Correct Factor dB	Measure- ment dBuV/m	Limit dBuV/m	Over dB	Detector
1	48.5016	48.03	-18.43	29.60	40.00	-10.40	QP
2	72.8465	47.19	-19.11	28.08	40.00	-11.92	QP
3	119.8555	45.27	-14.87	30.40	43.50	-13.10	QP
4	180.0165	46.80	-14.60	32.20	43.50	-11.30	QP
5 *	239.9874	49.14	-11.64	37.50	46.00	-8.50	QP
6	810.2653	31.54	1.89	33.43	46.00	-12.57	QP

Horizontal:

Peak scan

Level (dB μ V/m)

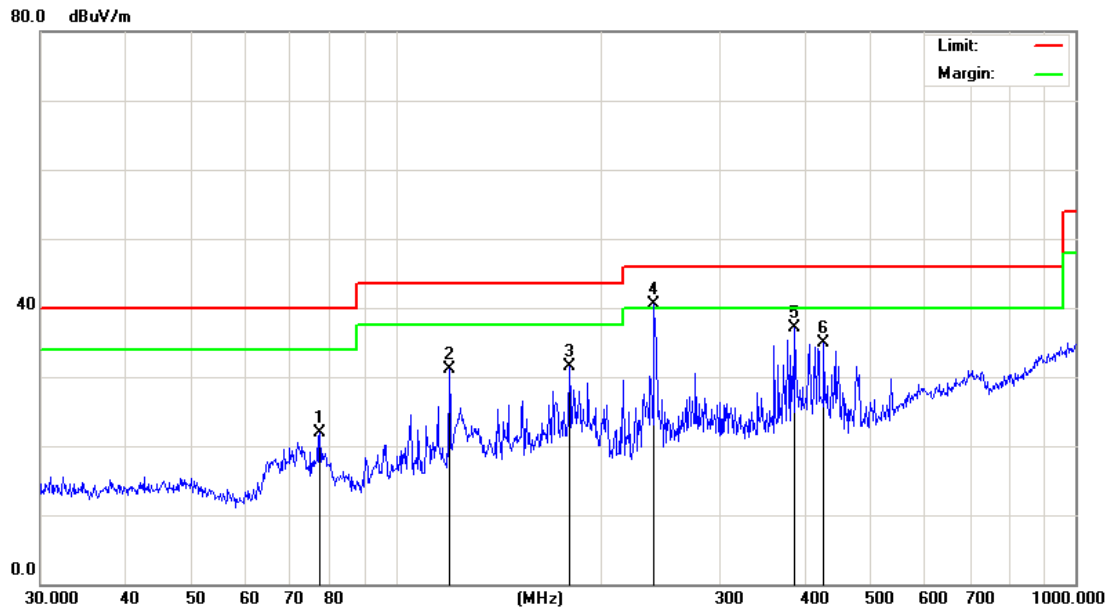

Quasi-peak measurement

No.	Mk.	Freq. MHz	Reading Level dB μ V	Correct Factor dB	Measure- ment dB μ V/m	Limit dB μ V/m	Over dB	Detector
1		77.3212	40.82	-18.85	21.97	40.00	-18.03	QP
2		119.8555	46.00	-14.90	31.10	43.50	-12.40	QP
3		180.0165	43.09	-11.59	31.50	43.50	-12.00	QP
4	*	239.9874	52.10	-11.64	40.46	46.00	-5.54	QP
5		386.6338	44.50	-7.40	37.10	46.00	-8.90	QP
6		426.5210	41.56	-6.58	34.98	46.00	-11.02	QP

EUT:	Tablet PC	Model Name :	PC1028ITC
Temperature:	25 °C	Test Data	2016-02-23
Pressure:	1010 hPa	Relative Humidity:	60%
Test Mode :	TX:802.11b 2.462 GHz(worst-case)	Test Voltage :	DC 3.7V from battery
Measurement Distance	3 m	Frenqucy Range	30MHz to 1GHz
RBW/VBW	100KHz / 300KHz for spectrum, RBW=120KHz for receiver.		

Test at Channel 11 (2.462 GHz) in transmitting status

30 MHz~1 GHz Spurious Emissions .Quasi-Peak Measurement

Vertical:

Peak scan

Level (dBμV/m)

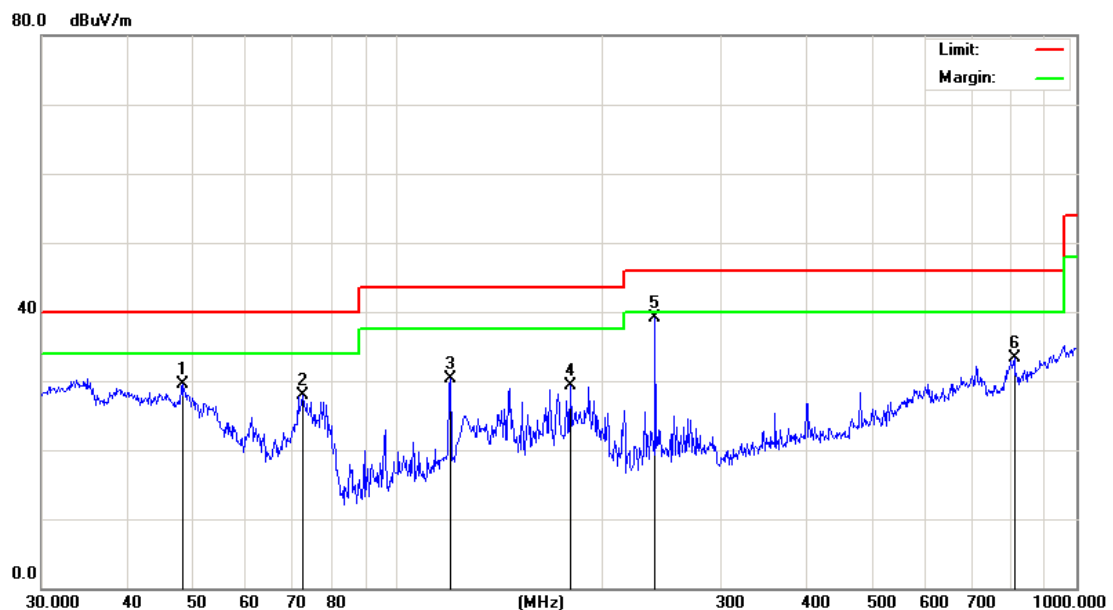

Quasi-peak measurement

No. Mk.	Freq. MHz	Reading Level dBμV	Correct Factor dB	Measure- ment dBμV/m	Limit dBμV/m	Over dB	Detector
1	48.5016	47.94	-18.43	29.51	40.00	-10.49	QP
2	72.8465	47.10	-19.11	27.99	40.00	-12.01	QP
3	119.8555	45.27	-14.87	30.40	43.50	-13.10	QP
4	180.0165	44.00	-14.60	29.40	43.50	-14.10	QP
5 *	239.9874	50.74	-11.64	39.10	46.00	-6.90	QP
6	810.2653	31.45	1.89	33.34	46.00	-12.66	QP

Horizontal:

Peak scan

Level (dB μ V/m)

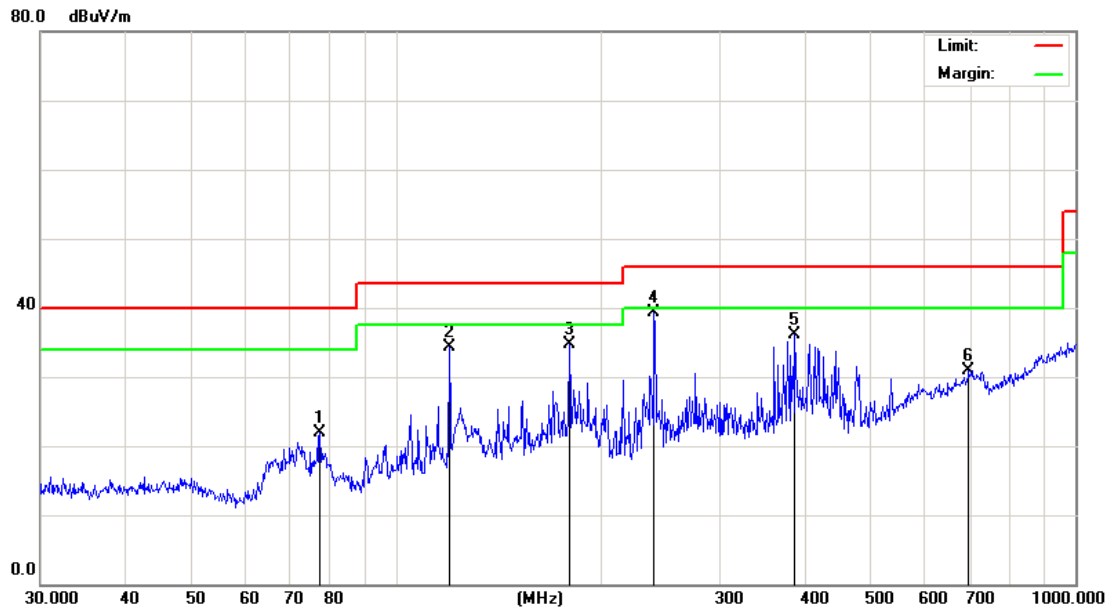

Quasi-peak measurement

No.	Mk.	Freq. MHz	Reading Level dBuV	Correct Factor dB	Measure- ment dBuV/m	Limit dBuV/m	Over dB	Detector
1		77.3212	40.80	-18.85	21.95	40.00	-18.05	QP
2		119.8555	49.30	-14.90	34.40	43.50	-9.10	QP
3		180.0165	46.29	-11.59	34.70	43.50	-8.80	QP
4	*	239.9874	51.04	-11.64	39.40	46.00	-6.60	QP
5		386.6338	43.50	-7.40	36.10	46.00	-9.90	QP
6		696.8567	30.66	0.24	30.90	46.00	-15.10	QP

7.4.1.3 Radiated Emissions Test Data above 1GHz

802.11b mode with 11Mbps data rate

EUT:	Tablet PC	Model Name :	PC1028ITC
Temperature:	25 °C	Test Data	2016-02-23
Pressure:	1010 hPa	Relative Humidity:	60%
Test Mode :	TX:802.11b 2.412 GHz	Test Voltage :	DC 3.7V from battery
Measurement Distance	3 m	Frenqucy Range	1GHz to 25GHz
RBW/VBW	Spurious emission: 1MHz/3MHz for Peak, 1MHz/10Hz for Average. non-restricted band: 100KHz/300KHz for Peak.		

1~25 GHz Harmonics & Spurious Emissions. Peak & Average Measurement

(a) Antenna polarization: Horizontal

Frequency (MHz)	Reading Level (dBuV)	Correct Factor (dB)	Measure Level (dBuV/m)	Limit (dBuV/m)	Margin (dB)	Detector Type
4824.000	56.31	5.08	61.39	74.00	-12.61	PEAK
4824.000	41.26	5.08	46.34	54.00	-7.66	AVERAGE
7236.000	47.69	7.16	54.85	74.00	-19.15	PEAK
7236.000	36.27	7.16	43.43	54.00	-10.57	AVERAGE

(b) Antenna polarization: Vertical

Frequency (MHz)	Reading Level (dBuV)	Correct Factor (dB)	Measure Level (dBuV/m)	Limit (dBuV/m)	Margin (dB)	Detector Type
4824.000	59.85	5.08	64.93	74.00	-9.07	PEAK
4824.000	43.30	5.08	48.38	54.00	-5.62	AVERAGE
7236.000	46.25	7.16	53.41	74.00	-20.59	PEAK
7236.000	36.55	7.16	43.71	54.00	-10.29	AVERAGE

EUT:	Tablet PC	Model Name :	PC1028ITC
Temperature:	25 °C	Test Data	2016-02-23
Pressure:	1010 hPa	Relative Humidity:	60%
Test Mode :	TX:802.11b 2.437 GHz	Test Voltage :	DC 3.7V from battery
Measurement Distance	3 m	Frenqucy Range	1GHz to 25GHz
RBW/VBW	Spurious emission: 1MHz/3MHz for Peak, 1MHz/10Hz for Average. non-restricted band: 100KHz/300KHz for Peak.		

1~25 GHz Harmonics & Spurious Emissions. Peak & Average Measurement

(a) Antenna polarization: Horizontal

Frequency (MHz)	Reading Level (dBuV)	Correct Factor (dB)	Measure Level (dBuV/m)	Limit (dBuV/m)	Margin (dB)	Detector Type
4874.000	55.43	5.13	60.56	74.00	-13.44	PEAK
4874.000	42.71	5.13	47.84	54.00	-6.16	AVERAGE
7311.000	46.64	7.49	54.13	74.00	-19.87	PEAK
7311.000	35.89	7.49	43.38	54.00	-10.62	AVERAGE

(b) Antenna polarization: Vertical

Frequency (MHz)	Reading Level (dBuV)	Correct Factor (dB)	Measure Level (dBuV/m)	Limit (dBuV/m)	Margin (dB)	Detector Type
4874.000	56.32	5.13	61.45	74.00	-12.55	PEAK
4874.000	41.68	5.13	46.81	54.00	-7.19	AVERAGE
7311.000	46.25	7.49	53.74	74.00	-20.26	PEAK
7311.000	34.87	7.49	42.36	54.00	-11.64	AVERAGE

EUT:	Tablet PC	Model Name :	PC1028ITC
Temperature:	25 °C	Test Data	2016-02-23
Pressure:	1010 hPa	Relative Humidity:	60%
Test Mode :	TX:802.11b 2.462 GHz	Test Voltage :	DC 3.7V from battery
Measurement Distance	3 m	Frenqucy Range	1GHz to 25GHz
RBW/VBW	Spurious emission: 1MHz/3MHz for Peak, 1MHz/10Hz for Average. non-restricted band: 100KHz/300KHz for Peak.		

1~25 GHz Harmonics & Spurious Emissions. Peak & Average Measurement

(a) Antenna polarization: Horizontal

Frequency (MHz)	Reading Level (dBuV)	Correct Factor (dB)	Measure Level (dBuV/m)	Limit (dBuV/m)	Margin (dB)	Detector Type
4924.000	56.54	5.18	61.72	74.00	-12.28	PEAK
4924.000	43.01	5.18	48.19	54.00	-5.81	AVERAGE
7386.000	46.87	7.82	54.69	74.00	-19.31	PEAK
7386.000	35.26	7.82	43.08	54.00	-10.92	AVERAGE

(b) Antenna polarization: Vertical

Frequency (MHz)	Reading Level (dBuV)	Correct Factor (dB)	Measure Level (dBuV/m)	Limit (dBuV/m)	Margin (dB)	Detector Type
4924.000	57.38	5.18	62.56	74.00	-11.44	PEAK
4924.000	39.61	5.18	44.79	54.00	-9.21	AVERAGE
7386.000	49.30	7.82	57.12	74.00	-16.88	PEAK
7386.000	38.42	7.82	46.24	54.00	-7.76	AVERAGE

The field strength is calculated by adding the Antenna Factor. Cable Factor & Preamplifier. The basic equation with a sample calculation is as follows:

Final Test Level = Receiver Reading + Antenna Factor + Cable Loss – Preamplifier Factor.

As shown in Section, for frequencies above 1000 MHz. the above field strength limits are based on average limits. However, the peak field strength of any emission shall not exceed the maximum permitted average limits specified above by more than 20 dB under any condition of modulation.

No any other emissions level which are attenuated less than 20dB below the limit.

According to 15.31(o), The amplitude of spurious emissions from intentional radiators and emissions from unintentional radiators which are attenuated more than 20 dB below the permissible value need not be reported unless specifically required elsewhere in this Part.

Hence there no other emissions have been reported.

802.11g mode with 54Mbps data rate

EUT:	Tablet PC	Model Name :	PC1028ITC
Temperature:	25 °C	Test Data	2016-02-23
Pressure:	1010 hPa	Relative Humidity:	60%
Test Mode :	TX:802.11g 2.412 GHz	Test Voltage :	DC 3.7V from battery
Measurement Distance	3 m	Frenqucy Range	1GHz to 25GHz
RBW/VBW	Spurious emission: 1MHz/3MHz for Peak, 1MHz/10Hz for Average. non-restricted band: 100KHz/300KHz for Peak.		

1~25 GHz Harmonics & Spurious Emissions. Peak & Average Measurement

(a) Antenna polarization: Horizontal

Frequency (MHz)	Reading Level (dBuV)	Correct Factor (dB)	Measure Level (dBuV/m)	Limit (dBuV/m)	Margin (dB)	Detector Type
4824.000	54.20	5.08	59.28	74.00	-14.72	PEAK
4824.000	41.34	5.08	46.42	54.00	-7.58	AVERAGE
7236.000	45.81	7.16	52.97	74.00	-21.03	PEAK
7236.000	34.62	7.16	41.78	54.00	-12.22	AVERAGE

(b) Antenna polarization: Vertical

Frequency (MHz)	Reading Level (dBuV)	Correct Factor (dB)	Measure Level (dBuV/m)	Limit (dBuV/m)	Margin (dB)	Detector Type
4824.000	55.73	5.08	60.81	74.00	-13.19	PEAK
4824.000	43.56	5.08	48.64	54.00	-5.36	AVERAGE
7236.000	47.29	7.16	54.45	74.00	-19.55	PEAK
7236.000	36.30	7.16	43.46	54.00	-10.54	AVERAGE

EUT:	Tablet PC	Model Name :	PC1028ITC
Temperature:	25 °C	Test Data	2016-02-23
Pressure:	1010 hPa	Relative Humidity:	60%
Test Mode :	TX:802.11g 2.437 GHz	Test Voltage :	DC 3.7V from battery
Measurement Distance	3 m	Frenqucy Range	1GHz to 25GHz
RBW/VBW	Spurious emission: 1MHz/3MHz for Peak, 1MHz/10Hz for Average. non-restricted band: 100KHz/300KHz for Peak.		

1~25 GHz Harmonics & Spurious Emissions. Peak & Average Measurement

(a) Antenna polarization: Horizontal

Frequency (MHz)	Reading Level (dBuV)	Correct Factor (dB)	Measure Level (dBuV/m)	Limit (dBuV/m)	Margin (dB)	Detector Type
4874.000	53.85	5.13	58.98	74.00	-15.02	PEAK
4874.000	42.77	5.13	47.90	54.00	-6.10	AVERAGE
7311.000	46.41	7.49	53.90	74.00	-20.10	PEAK
7311.000	33.96	7.49	41.45	54.00	-12.55	AVERAGE

(b) Antenna polarization: Vertical

Frequency (MHz)	Reading Level (dBuV)	Correct Factor (dB)	Measure Level (dBuV/m)	Limit (dBuV/m)	Margin (dB)	Detector Type
4874.000	55.53	5.13	60.66	74.00	-13.34	PEAK
4874.000	43.10	5.13	48.23	54.00	-5.77	AVERAGE
7311.000	46.84	7.49	54.33	74.00	-19.67	PEAK
7311.000	34.65	7.49	42.14	54.00	-11.86	AVERAGE

EUT:	Tablet PC	Model Name :	PC1028ITC
Temperature:	25 °C	Test Data	2016-02-23
Pressure:	1010 hPa	Relative Humidity:	60%
Test Mode :	TX:802.11g 2.462 GHz	Test Voltage :	DC 3.7V from battery
Measurement Distance	3 m	Frenqucy Range	1GHz to 25GHz
RBW/VBW	Spurious emission: 1MHz/3MHz for Peak, 1MHz/10Hz for Average. non-restricted band: 100KHz/300KHz for Peak.		

1~25 GHz Harmonics & Spurious Emissions. Peak & Average Measurement

(a) Antenna polarization: Horizontal

Frequency (MHz)	Reading Level (dBuV)	Correct Factor (dB)	Measure Level (dBuV/m)	Limit (dBuV/m)	Margin (dB)	Detector Type
4924.000	55.05	5.18	60.23	74.00	-13.77	PEAK
4924.000	44.23	5.18	49.41	54.00	-4.59	AVERAGE
7386.000	47.82	7.82	55.64	74.00	-18.36	PEAK
7386.000	34.31	7.82	42.13	54.00	-11.87	AVERAGE

(b) Antenna polarization: Vertical

Frequency (MHz)	Reading Level (dBuV)	Correct Factor (dB)	Measure Level (dBuV/m)	Limit (dBuV/m)	Margin (dB)	Detector Type
4924.000	56.17	5.18	61.35	74.00	-12.65	PEAK
4924.000	43.84	5.18	49.02	54.00	-4.98	AVERAGE
7386.000	48.50	7.82	56.32	74.00	-17.68	PEAK
7386.000	36.23	7.82	44.05	54.00	-9.95	AVERAGE

The field strength is calculated by adding the Antenna Factor. Cable Factor & Preamplifier. The basic equation with a sample calculation is as follows:

Final Test Level =Receiver Reading + Antenna Factor + Cable Factor –Preamplifier Factor.

No any other emissions level which are attenuated less than 20dB below the limit.

According to 15.31(o), The amplitude of spurious emissions from intentional radiators and emissions from unintentional radiators which are attenuated more than 20 dB below the permissible value need not be reported unless specifically required elsewhere in this Part.

Hence there no other emissions have been reported.

802.11n(HT20) mode with 72.2Mbps data rate

EUT:	Tablet PC	Model Name :	PC1028ITC
Temperature:	25 °C	Test Data	2016-02-23
Pressure:	1010 hPa	Relative Humidity:	60%
Test Mode :	TX:802.11n(HT20) 2.412 GHz	Test Voltage :	DC 3.7V from battery
Measurement Distance	3 m	Frenqucy Range	1GHz to 25GHz
RBW/VBW	Spurious emission: 1MHz/3MHz for Peak, 1MHz/10Hz for Average. non-restricted band: 100KHz/300KHz for Peak.		

1~25 GHz Harmonics & Spurious Emissions. Peak & Average Measurement

(a) Antenna polarization: Horizontal

Frequency (MHz)	Reading Level (dBuV)	Correct Factor (dB)	Measure Level (dBuV/m)	Limit (dBuV/m)	Margin (dB)	Detector Type
4824.000	55.92	5.08	61.00	74.00	-13.00	PEAK
4824.000	44.83	5.08	49.91	54.00	-4.09	AVERAGE
7236.000	46.26	7.16	53.42	74.00	-20.58	PEAK
7236.000	34.47	7.16	41.63	54.00	-12.37	AVERAGE

(b) Antenna polarization: Vertical

Frequency (MHz)	Reading Level (dBuV)	Correct Factor (dB)	Measure Level (dBuV/m)	Limit (dBuV/m)	Margin (dB)	Detector Type
4824.000	53.78	5.08	58.86	74.00	-15.14	PEAK
4824.000	42.14	5.08	47.22	54.00	-6.78	AVERAGE
7236.000	47.68	7.16	54.84	74.00	-19.16	PEAK
7236.000	36.24	7.16	43.40	54.00	-10.60	AVERAGE

EUT:	Tablet PC	Model Name :	PC1028ITC
Temperature:	25 °C	Test Data	2016-02-23
Pressure:	1010 hPa	Relative Humidity:	60%
Test Mode :	TX:802.11n(HT20) 2.437 GHz	Test Voltage :	DC 3.7V from battery
Measurement Distance	3 m	Frenqucy Range	1GHz to 25GHz
RBW/VBW	Spurious emission: 1MHz/3MHz for Peak, 1MHz/10Hz for Average. non-restricted band: 100KHz/300KHz for Peak.		

1~25 GHz Harmonics & Spurious Emissions. Peak & Average Measurement

(a) Antenna polarization: Horizontal

Frequency (MHz)	Reading Level (dBuV)	Correct Factor (dB)	Measure Level (dBuV/m)	Limit (dBuV/m)	Margin (dB)	Detector Type
4874.000	53.14	5.13	58.27	74.00	-15.73	PEAK
4874.000	42.50	5.13	47.63	54.00	-6.37	AVERAGE
7311.000	46.48	7.49	53.97	74.00	-20.03	PEAK
7311.000	33.12	7.49	40.61	54.00	-13.39	AVERAGE

(b) Antenna polarization: Vertical

Frequency (MHz)	Reading Level (dBuV)	Correct Factor (dB)	Measure Level (dBuV/m)	Limit (dBuV/m)	Margin (dB)	Detector Type
4874.000	55.72	5.13	60.85	74.00	-13.15	PEAK
4874.000	40.53	5.13	45.66	54.00	-8.34	AVERAGE
7311.000	47.22	7.49	54.71	74.00	-19.29	PEAK
7311.000	34.65	7.49	42.14	54.00	-11.86	AVERAGE

EUT:	Tablet PC	Model Name :	PC1028ITC
Temperature:	25 °C	Test Data	2016-02-23
Pressure:	1010 hPa	Relative Humidity:	60%
Test Mode :	TX:802.11n(HT20) 2.462 GHz	Test Voltage :	DC 3.7V from battery
Measurement Distance	3 m	Frenqucy Range	1GHz to 25GHz
RBW/VBW	Spurious emission: 1MHz/3MHz for Peak, 1MHz/10Hz for Average. non-restricted band: 100KHz/300KHz for Peak.		

1~25 GHz Harmonics & Spurious Emissions. Peak & Average Measurement

(a) Antenna polarization: Horizontal

Frequency (MHz)	Reading Level (dBuV)	Correct Factor (dB)	Measure Level (dBuV/m)	Limit (dBuV/m)	Margin (dB)	Detector Type
4924.000	52.58	5.18	57.76	74.00	-16.24	PEAK
4924.000	40.73	5.18	45.91	54.00	-8.09	AVERAGE
7386.000	48.65	7.82	56.47	74.00	-17.53	PEAK
7386.000	35.14	7.82	42.96	54.00	-11.04	AVERAGE

(b) Antenna polarization: Vertical

Frequency (MHz)	Reading Level (dBuV)	Correct Factor (dB)	Measure Level (dBuV/m)	Limit (dBuV/m)	Margin (dB)	Detector Type
4924.000	54.51	5.18	59.69	74.00	-14.31	PEAK
4924.000	43.54	5.18	48.72	54.00	-5.28	AVERAGE
7386.000	47.12	7.82	54.94	74.00	-19.06	PEAK
7386.000	36.68	7.82	44.50	54.00	-9.50	AVERAGE

The field strength is calculated by adding the Antenna Factor. Cable Factor & Preamplifier. The basic equation with a sample calculation is as follows:

Final Test Level =Receiver Reading + Antenna Factor + Cable Loss –Preamplifier Factor.

As shown in Section, for frequencies above 1000 MHz. the above field strength limits are based on average limits. However, the peak field strength of any emission shall not exceed the maximum permitted average limits specified above by more than 20 dB under any condition of modulation.

No any other emissions level which are attenuated less than 20dB below the limit.

According to 15.31(o), The amplitude of spurious emissions from intentional radiators and emissions from unintentional radiators which are attenuated more than 20 dB below the permissible value need not be reported unless specifically required elsewhere in this Part.

Hence there no other emissions have been reported.

Test result: The unit does meet the FCC requirements.

7.4.2 Radiated Emissions which fall in the restricted bands

Test Requirement:	FCC Part 15 C section 15.247 (d) In addition, radiated emissions which fall in the restricted bands, as defined in Section 15.205(a), must also comply with the radiated emission limits specified in Section 15.209(a) (see Section 15.205(c)).
Test Method:	ANSI C63.10: Clause 6.4, 6.5 and 6.6
Test Status:	Pre-Scan has been conducted to determine the worst-case mode from all possible combinations between available modulations, data rates and antenna ports (if EUT with antenna diversity architecture). Following channel(s) was (were) selected for the final test as listed below. Pre-test the EUT under 2 modes: power-supplied by using the AC adapter and power-supplied by using internal battery. After pre-testing, we found the worst case is the test mode of EUT power-supplied by using internal battery.
Test site:	Measurement Distance: 3m (Semi-Anechoic Chamber)
Limit:	40.0 dB μ V/m between 30MHz & 88MHz; 43.5 dB μ V/m between 88MHz & 216MHz; 46.0 dB μ V/m between 216MHz & 960MHz; 54.0 dB μ V/m above 960MHz.
Detector:	For PK value: RBW = 1 MHz for $f \geq 1$ GHz, 100 kHz for $f < 1$ GHz VBW \geq RBW Sweep = auto Detector function = peak Trace = max hold For AV value: RBW = 1 MHz for $f \geq 1$ GHz, 100 kHz for $f < 1$ GHz VBW = 10Hz Sweep = auto Detector function = peak Trace = max hold

Section 15.205 Restricted bands of operation.

(a) Except as shown in paragraph (d) of this section, only spurious emissions are permitted in any of the frequency bands listed below:

MHz	MHz	MHz	GHz
0.090 - 0.110	16.42 - 16.423	399.9 - 410	4.5 - 5.15
1.0495 - 0.505	16.69475 - 16.69525	608 - 614	5.35 - 5.46
2.1735 - 2.1905	16.80425 - 16.80475	960 - 1240	7.25 - 7.75
4.125 - 4.128	25.5 - 25.67	1300 - 1427	8.025 - 8.5
4.17725 - 4.17775	37.5 - 38.25	1435 - 1626.5	9.0 - 9.2
4.20725 - 4.20775	73 - 74.6	1645.5 - 1646.5	9.3 - 9.5
6.215 - 6.218	74.8 - 75.2	1660 - 1710	10.6 - 12.7
6.26775 - 6.26825	108 - 121.94	1718.8 - 1722.2	13.25 - 13.4
6.31175 - 6.31225	123 - 138	2200 - 2300	14.47 - 14.5
8.291 - 8.294	149.9 - 150.05	2310 - 2390	15.35 - 16.2
8.362 - 8.366	156.52475 -	2483.5 - 2500	17.7 - 21.4
8.37625 - 8.38675	156.52525	2655 - 2900	22.01 - 23.12
8.41425 - 8.41475	156.7 - 156.9	3260 - 3267	23.6 - 24.0
12.29 - 12.293	162.0125 - 167.17	3332 - 3339	31.2 - 31.8
12.51975 - 12.52025	167.72 - 173.2	3345.8 - 3358	36.43 - 36.5
12.57675 - 12.57725	240 - 285	3600 - 4400	
13.36 - 13.41	322 - 335.4		

Test Result:

7.4.2.1 802.11b mode with 11Mbps data rate

Test at Channel 1 (2.412 GHz) in transmitting status

Peak Measurement:

Frequency (MHz)	Reading Level (dB μ V)	Antenna factors (dB/m)	Cable loss (dB)	Preamp factor (dB)	Emission Level (dB μ V/m)	Limit (dB μ V/m)	Antenna polarization
2310.000	53.08	27.93	4.74	35.09	50.66	74.00	Vertical
2390.000	54.76	27.63	4.96	35.05	52.30	74.00	V
2483.500	54.25	27.55	4.9	34.99	51.71	74.00	V
2500.000	55.91	27.55	5.00	34.98	53.48	74.00	V
2310.000	54.23	27.93	4.74	35.09	51.81	74.00	Horizontal
2390.000	53.76	27.63	4.96	35.05	51.30	74.00	H
2483.500	53.54	27.55	4.9	34.99	51.00	74.00	H
2500.000	56.87	27.55	5.00	34.98	54.44	74.00	H

Average Measurement:

Frequency (MHz)	Reading Level (dB μ V)	Antenna factors (dB/m)	Cable loss (dB)	Preamp factor (dB)	Emission Level (dB μ V/m)	Limit (dB μ V/m)	Antenna polarization
2310.000	42.94	27.93	4.74	35.09	40.52	54.00	Vertical
2390.000	43.21	27.63	4.96	35.05	40.75	54.00	V
2483.500	42.60	27.55	4.9	34.99	40.06	54.00	V
2500.000	41.78	27.55	5.00	34.98	39.35	54.00	V
2310.000	42.94	27.93	4.74	35.09	40.52	54.00	Horizontal
2390.000	44.33	27.63	4.96	35.05	41.87	54.00	H
2483.500	43.17	27.55	4.9	34.99	40.63	54.00	H
2500.000	42.65	27.55	5.00	34.98	40.22	54.00	H

Test at Channel 6 (2.437 GHz) in transmitting status

Peak Measurement:

Frequency (MHz)	Reading Level (dB μ V)	Antenna factors (dB/m)	Cable loss (dB)	Preamp factor (dB)	Emission Level (dB μ V/m)	Limit (dB μ V/m)	Antenna polarization
2310.000	52.94	27.93	4.74	35.09	50.52	74.00	Vertical
2390.000	53.11	27.63	4.96	35.05	50.65	74.00	V
2483.500	54.28	27.55	4.90	34.99	51.74	74.00	V
2500.000	52.65	27.55	5.00	34.98	50.22	74.00	V
2310.000	53.48	27.93	4.74	35.09	51.06	74.00	Horizontal
2390.000	53.29	27.63	4.96	35.05	50.83	74.00	H
2483.500	52.76	27.55	4.90	34.99	50.22	74.00	H
2500.000	53.60	27.55	5.00	34.98	51.17	74.00	H

Average Measurement:

Frequency (MHz)	Reading Level (dB μ V)	Antenna factors (dB/m)	Cable loss (dB)	Preamp factor (dB)	Emission Level (dB μ V/m)	Limit (dB μ V/m)	Antenna polarization
2310.000	42.74	27.93	4.74	35.09	40.32	54.00	Vertical
2390.000	41.53	27.63	4.96	35.05	39.07	54.00	V
2483.500	42.08	27.55	4.90	34.99	39.54	54.00	V
2500.000	43.74	27.93	4.74	35.09	41.31	54.00	V
2310.000	42.53	27.93	4.74	35.09	40.11	54.00	Horizontal
2390.000	43.61	27.63	4.96	35.05	41.15	54.00	H
2483.500	41.74	27.55	4.90	34.99	39.20	54.00	H
2500.000	42.96	27.93	4.74	35.09	40.53	54.00	H

Test at Channel 11 (2.462 GHz) in transmitting status

Peak Measurement:

Frequency (MHz)	Reading Level (dB μ V)	Antenna factors (dB/m)	Cable loss (dB)	Preamp factor (dB)	Emission Level (dB μ V/m)	Limit (dB μ V/m)	Antenna polarization
2310.000	53.60	27.93	4.74	35.09	51.18	74.00	Vertical
2390.000	52.47	27.63	4.96	35.05	50.01	74.00	V
2483.500	52.51	27.55	4.90	34.99	49.97	74.00	V
2500.000	53.84	27.93	4.74	35.09	51.41	74.00	V
2310.000	52.72	27.93	4.74	35.09	50.30	74.00	Horizontal
2390.000	53.65	27.63	4.96	35.05	51.19	74.00	H
2483.500	53.73	27.55	4.90	34.99	51.19	74.00	H
2500.000	51.60	27.93	4.74	35.09	49.17	74.00	H

Average Measurement:

Frequency (MHz)	Reading Level (dB μ V)	Antenna factors (dB/m)	Cable loss (dB)	Preamp factor (dB)	Emission Level (dB μ V/m)	Limit (dB μ V/m)	Antenna polarization
2310.000	43.65	27.93	4.74	35.09	41.23	54.00	Vertical
2390.000	40.53	27.63	4.96	35.05	38.07	54.00	V
2483.500	42.76	27.55	4.90	34.99	40.22	54.00	V
2500.000	43.19	27.93	4.74	35.09	40.76	54.00	V
2310.000	42.08	27.93	4.74	35.09	39.66	54.00	Horizontal
2390.000	43.76	27.63	4.96	35.05	41.30	54.00	H
2483.500	44.29	27.55	4.90	34.99	41.75	54.00	H
2500.000	42.64	27.93	4.74	35.09	40.21	54.00	H

7.4.2.2 802.11g mode with 54Mbps data rate

Test at Channel 1 (2.412 GHz) in transmitting status

Peak Measurement:

Frequency (MHz)	Reading Level (dB μ V)	Antenna factors (dB/m)	Cable loss (dB)	Preamp factor (dB)	Emission Level (dB μ V/m)	Limit (dB μ V/m)	Antenna polarization
2310.000	54.87	27.93	4.74	35.09	52.45	74.00	Vertical
2390.000	53.02	27.63	4.96	35.05	50.56	74.00	V
2483.500	53.65	27.55	4.90	34.99	51.11	74.00	V
2500.000	51.73	27.55	5.00	34.98	49.30	74.00	V
2310.000	52.58	27.93	4.74	35.09	50.16	74.00	Horizontal
2390.000	53.00	27.63	4.96	35.05	50.54	74.00	H
2483.500	52.16	27.55	4.90	34.99	49.62	74.00	H
2500.000	54.69	27.55	5.00	34.98	52.26	74.00	H

Average Measurement:

Frequency (MHz)	Reading Level (dB μ V)	Antenna factors (dB/m)	Cable loss (dB)	Preamp factor (dB)	Emission Level (dB μ V/m)	Limit (dB μ V/m)	Antenna polarization
2310.000	42.71	27.93	4.74	35.09	40.29	54.00	Vertical
2390.000	43.02	27.63	4.96	35.05	40.56	54.00	V
2483.500	42.85	27.55	4.90	34.99	40.31	54.00	V
2500.000	43.76	27.55	5.00	34.98	41.33	54.00	V
2310.000	42.54	27.93	4.74	35.09	40.12	54.00	Horizontal
2390.000	43.80	27.63	4.96	35.05	41.34	54.00	H
2483.500	43.17	27.55	4.90	34.99	40.63	54.00	H
2500.000	42.43	27.55	5.00	34.98	40.00	54.00	H

Test at Channel 6 (2.437 GHz) in transmitting status

Peak Measurement:

Frequency (MHz)	Reading Level (dB μ V)	Antenna factors (dB/m)	Cable loss (dB)	Preamp factor (dB)	Emission Level (dB μ V/m)	Limit (dB μ V/m)	Antenna polarization
2310.000	52.94	27.93	4.74	35.09	50.52	74.00	Vertical
2390.000	53.68	27.63	4.96	35.05	51.22	74.00	V
2483.500	53.12	27.55	4.90	34.99	50.58	74.00	V
2500.000	54.54	27.55	5.00	34.98	52.11	74.00	V
2310.000	53.20	27.93	4.74	35.09	50.78	74.00	Horizontal
2390.000	54.73	27.63	4.96	35.05	52.27	74.00	H
2483.500	53.65	27.55	4.90	34.99	51.11	74.00	H
2500.000	52.94	27.55	5.00	34.98	50.51	74.00	H

Average Measurement:

Frequency (MHz)	Reading Level (dB μ V)	Antenna factors (dB/m)	Cable loss (dB)	Preamp factor (dB)	Emission Level (dB μ V/m)	Limit (dB μ V/m)	Antenna polarization
2310.000	43.58	27.93	4.74	35.09	41.16	54.00	Vertical
2390.000	42.30	27.63	4.96	35.05	39.84	54.00	V
2483.500	42.75	27.55	4.90	34.99	40.21	54.00	V
2500.000	43.62	27.55	5.00	34.98	41.19	54.00	V
2310.000	43.79	27.93	4.74	35.09	41.37	54.00	Horizontal
2390.000	42.53	27.63	4.96	35.05	40.07	54.00	H
2483.500	43.41	27.55	4.90	34.99	40.87	54.00	H
2500.000	42.10	27.55	5.00	34.98	39.67	54.00	H

Test at Channel 11 (2.462 GHz) in transmitting status

Peak Measurement:

Frequency (MHz)	Reading Level (dB μ V)	Antenna factors (dB/m)	Cable loss (dB)	Preamp factor (dB)	Emission Level (dB μ V/m)	Limit (dB μ V/m)	Antenna polarization
2310.000	53.61	27.93	4.74	35.09	51.19	74.00	Vertical
2390.000	52.59	27.63	4.96	35.05	50.13	74.00	V
2483.500	52.74	27.55	4.90	34.99	50.20	74.00	V
2500.000	53.83	27.55	5.00	34.98	51.40	74.00	V
2310.000	52.50	27.93	4.74	35.09	50.08	74.00	Horizontal
2390.000	53.64	27.63	4.96	35.05	51.18	74.00	H
2483.500	52.98	27.55	4.90	34.99	50.44	74.00	H
2500.000	53.70	27.55	5.00	34.98	51.27	74.00	H

Average Measurement:

Frequency (MHz)	Reading Level (dB μ V)	Antenna factors (dB/m)	Cable loss (dB)	Preamp factor (dB)	Emission Level (dB μ V/m)	Limit (dB μ V/m)	Antenna polarization
2310.000	42.33	27.93	4.74	35.09	39.91	54.00	Vertical
2390.000	43.46	27.63	4.96	35.05	41.00	54.00	V
2483.500	41.56	27.55	4.90	34.99	39.02	54.00	V
2500.000	42.73	27.55	5.00	34.98	40.30	54.00	V
2310.000	43.51	27.93	4.74	35.09	41.09	54.00	Horizontal
2390.000	43.09	27.63	4.96	35.05	40.63	54.00	H
2483.500	42.74	27.55	4.90	34.99	40.20	54.00	H
2500.000	41.72	27.55	5.00	34.98	39.29	54.00	H

7.4.2.3 802.11n(HT20) mode with 72.2Mbps data rate

Test at Channel 1 (2.412 GHz) in transmitting status

Peak Measurement:

Frequency (MHz)	Reading Level (dB μ V)	Antenna factors (dB/m)	Cable loss (dB)	Preamp factor (dB)	Emission Level (dB μ V/m)	Limit (dB μ V/m)	Antenna polarization
2310.000	63.02	27.93	4.74	35.09	60.60	74.00	Vertical
2390.000	62.68	27.63	4.96	35.05	60.22	74.00	V
2483.500	63.97	27.55	4.90	34.99	61.43	74.00	V
2500.000	61.44	27.55	5.00	34.98	59.01	74.00	V
2310.000	58.25	27.93	4.74	35.09	55.83	74.00	Horizontal
2390.000	57.03	27.63	4.96	35.05	54.57	74.00	H
2483.500	59.24	27.55	4.90	34.99	56.70	74.00	H
2500.000	58.37	27.55	5.00	34.98	55.94	74.00	H

Average Measurement:

Frequency (MHz)	Reading Level (dB μ V)	Antenna factors (dB/m)	Cable loss (dB)	Preamp factor (dB)	Emission Level (dB μ V/m)	Limit (dB μ V/m)	Antenna polarization
2310.000	48.13	27.93	4.74	35.09	45.71	54.00	Vertical
2390.000	50.54	27.63	4.96	35.05	48.08	54.00	V
2483.500	48.27	27.55	4.90	34.99	45.73	54.00	V
2500.000	49.56	27.55	5.00	34.98	47.13	54.00	V
2310.000	52.75	27.93	4.74	35.09	50.33	54.00	Horizontal
2390.000	49.28	27.63	4.96	35.05	46.82	54.00	H
2483.500	48.44	27.55	4.90	34.99	45.90	54.00	H
2500.000	48.76	27.55	5.00	34.98	46.33	54.00	H

Test at Channel 6 (2.437 GHz) in transmitting status

Peak Measurement:

Frequency (MHz)	Reading Level (dB μ V)	Antenna factors (dB/m)	Cable loss (dB)	Preamp factor (dB)	Emission Level (dB μ V/m)	Limit (dB μ V/m)	Antenna polarization
2310.000	58.60	27.93	4.74	35.09	56.18	74.00	Vertical
2390.000	59.37	27.63	4.96	35.05	56.91	74.00	V
2483.500	58.41	27.55	4.90	34.99	55.87	74.00	V
2500.000	56.92	27.55	5.00	34.98	54.49	74.00	V
2310.000	57.43	27.93	4.74	35.09	55.01	74.00	Horizontal
2390.000	58.62	27.63	4.96	35.05	56.16	74.00	H
2483.500	56.31	27.55	4.90	34.99	53.77	74.00	H
2500.000	57.98	27.55	5.00	34.98	55.55	74.00	H

Average Measurement:

Frequency (MHz)	Reading Level (dB μ V)	Antenna factors (dB/m)	Cable loss (dB)	Preamp factor (dB)	Emission Level (dB μ V/m)	Limit (dB μ V/m)	Antenna polarization
2310.000	46.46	27.93	4.74	35.09	44.04	54.00	Vertical
2390.000	47.32	27.63	4.96	35.05	44.86	54.00	V
2483.500	46.58	27.55	4.90	34.99	44.04	54.00	V
2500.000	45.20	27.55	5.00	34.98	42.77	54.00	V
2310.000	44.37	27.93	4.74	35.09	41.95	54.00	Horizontal
2390.000	45.27	27.63	4.96	35.05	42.81	54.00	H
2483.500	42.69	27.55	4.90	34.99	40.15	54.00	H
2500.000	43.82	27.55	5.00	34.98	41.39	54.00	H

Test at Channel 11 (2.462 GHz) in transmitting status

Peak Measurement:

Frequency (MHz)	Reading Level (dB μ V)	Antenna factors (dB/m)	Cable loss (dB)	Preamp factor (dB)	Emission Level (dB μ V/m)	Limit (dB μ V/m)	Antenna polarization
2310.000	56.13	27.93	4.74	35.09	53.71	74.00	Vertical
2390.000	55.29	27.63	4.96	35.05	52.83	74.00	V
2483.500	55.74	27.55	4.90	34.99	53.20	74.00	V
2500.000	54.86	27.55	5.00	34.98	52.43	74.00	V
2310.000	52.51	27.93	4.74	35.09	50.09	74.00	Horizontal
2390.000	53.73	27.63	4.96	35.05	51.27	74.00	H
2483.500	53.65	27.55	4.90	34.99	51.11	74.00	H
2500.000	52.11	27.55	5.00	34.98	49.68	74.00	H

Average Measurement:

Frequency (MHz)	Reading Level (dB μ V)	Antenna factors (dB/m)	Cable loss (dB)	Preamp factor (dB)	Emission Level (dB μ V/m)	Limit (dB μ V/m)	Antenna polarization
2310.000	42.98	27.93	4.74	35.09	40.56	54.00	Vertical
2390.000	41.84	27.63	4.96	35.05	39.38	54.00	V
2483.500	42.50	27.55	4.90	34.99	39.96	54.00	V
2500.000	38.25	27.55	5.00	34.98	35.82	54.00	V
2310.000	39.62	27.93	4.74	35.09	37.20	54.00	Horizontal
2390.000	42.76	27.63	4.96	35.05	40.30	54.00	H
2483.500	44.53	27.55	4.90	34.99	41.99	54.00	H
2500.000	43.57	27.55	5.00	34.98	41.14	54.00	H

7.5 6 dB Bandwidth

- Test Requirement:** FCC Part 15 C section 15.247
- (a)(2) Systems using digital modulation techniques may operate in the 902-928 MHz, 2400-2483.5MHz, and 5725-5850 MHz bands. The minimum 6 dB bandwidth shall be at least 500 kHz.
- Test Method:** ANSI C63.10: Clause 6.9.1
- Test Status:** Pre-Scan has been conducted to determine the worst-case mode from all possible combinations between available modulations, data rates and antenna ports (if EUT with antenna diversity architecture). Following channel(s) was (were) selected for the final test as listed below.
- Pre-test the EUT under 2 modes: power-supplied by using the AC adapter and power-supplied by using internal battery. After pre-testing, we found the worst case is the test mode of EUT power-supplied by using internal battery.
- Test Configuration:**

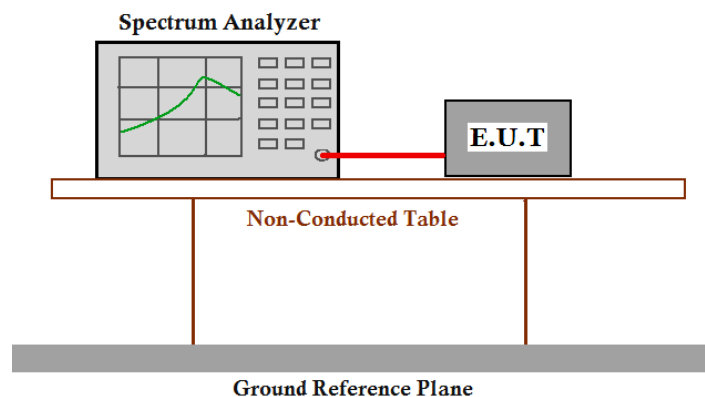

- Test Procedure:**
1. Remove the antenna from the EUT and then connect a low attention attenuation RF cable (cable loss =1.5dB) from the antenna port to the spectrum.
 2. Set the spectrum analyzer:
 Sweep = auto; Detector Function = Peak; ace = Max Hold
 RBW: 1%~5% OBW; VBW: $\geq 3 \times \text{RBW}$
 Span: two times and five times the OBW.
 3. Mark the peak power frequency and -6dB (upper and lower) power frequency.
 4. Repeat until all the test status is investigated.
 5. Report the worse case.

Channel No.	Frequency (MHz)	Mode	Data Rate	Measured 6dB bandwidth (MHz)	Limit	Result
1	2412	802.11b	11 Mbps	10.420	≥500KHz	Pass
6	2437		11 Mbps	10.275		Pass
11	2462		11 Mbps	10.781		Pass
1	2412	802.11g	54 Mbps	16.136	≥500KHz	Pass
6	2437		54 Mbps	16.099		Pass
11	2462		54 Mbps	15.918		Pass
1	2412	802.11n (HT20)	72.2 Mbps	17.510	≥500KHz	Pass
6	2437		72.2 Mbps	17.546		Pass
11	2462		72.2 Mbps	17.510		Pass

Test result: The unit does meet the FCC requirements.

Result plot as follows:

802.11b mode with 11Mbps data rate

Channel 1: 2.412GHz:

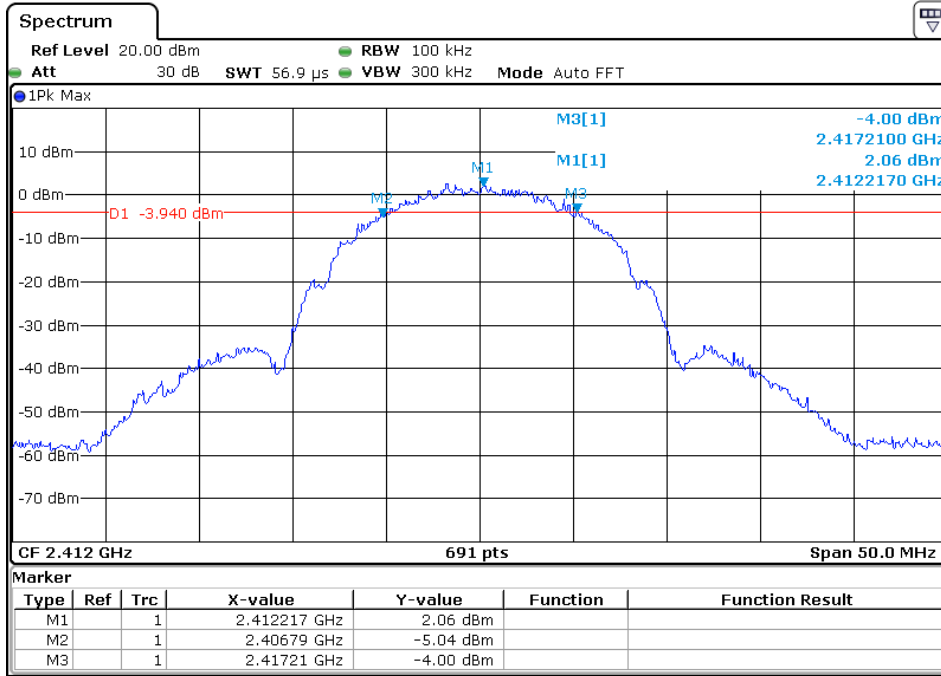

Channel 6: 2.437GHz:

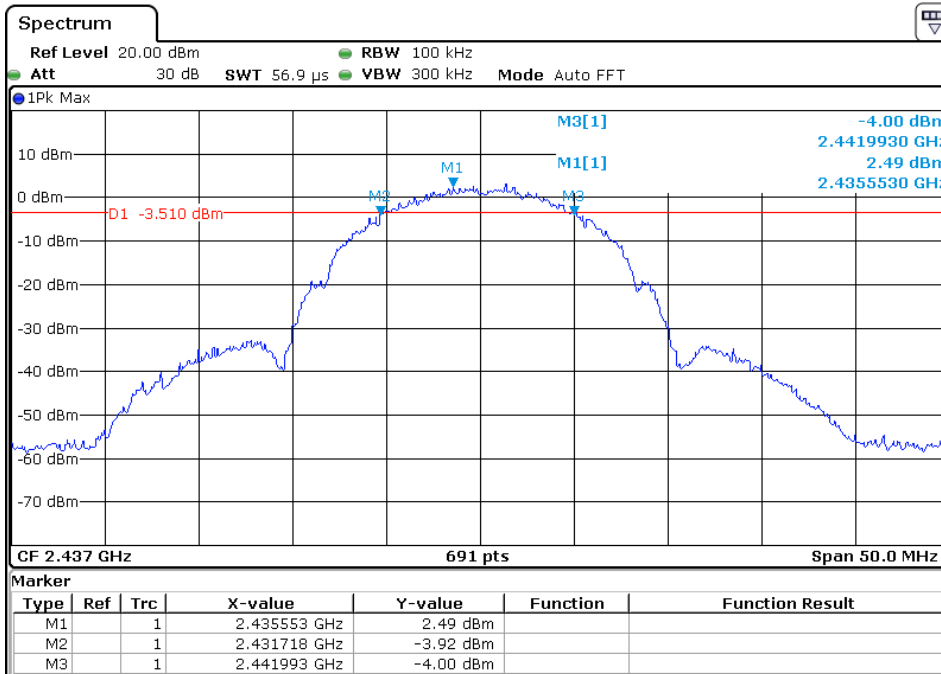

Channel 11: 2.462GHz:

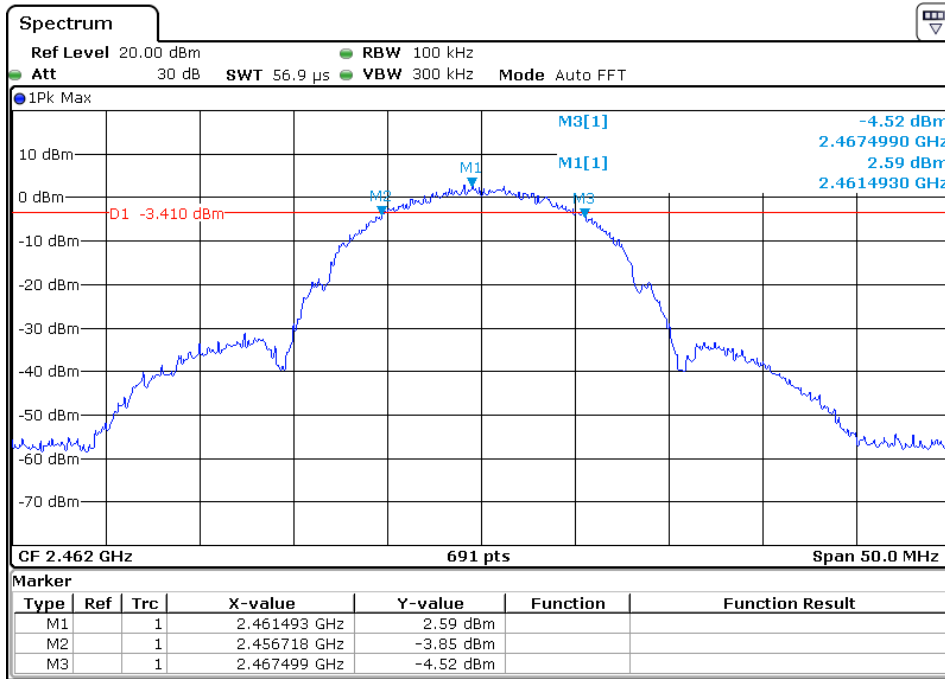

802.11g mode with 54Mbps data rate

Channel 1: 2.412GHz:

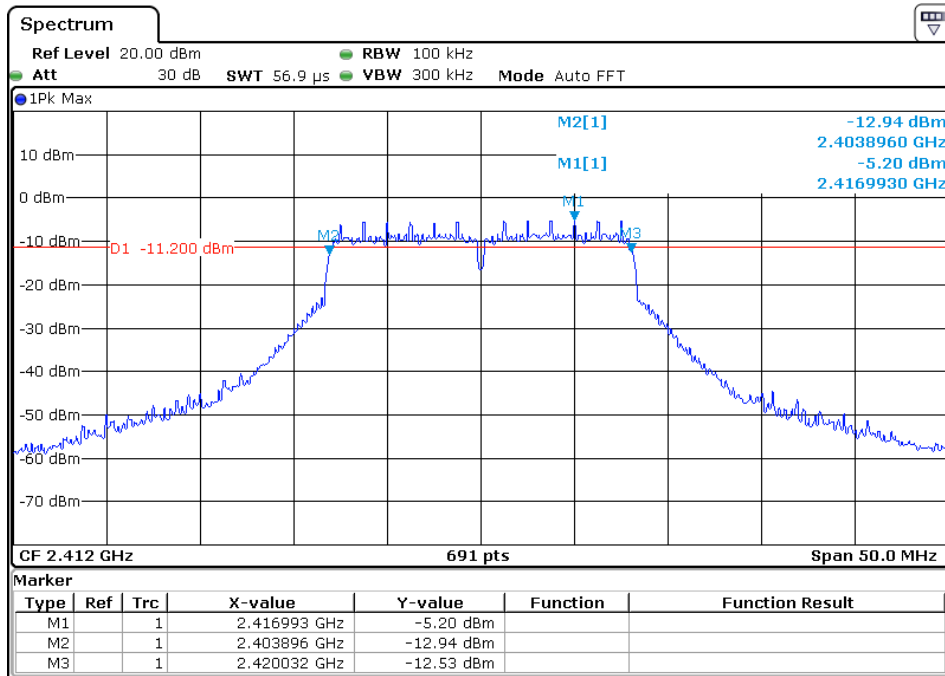

Channel 6: 2.437GHz:

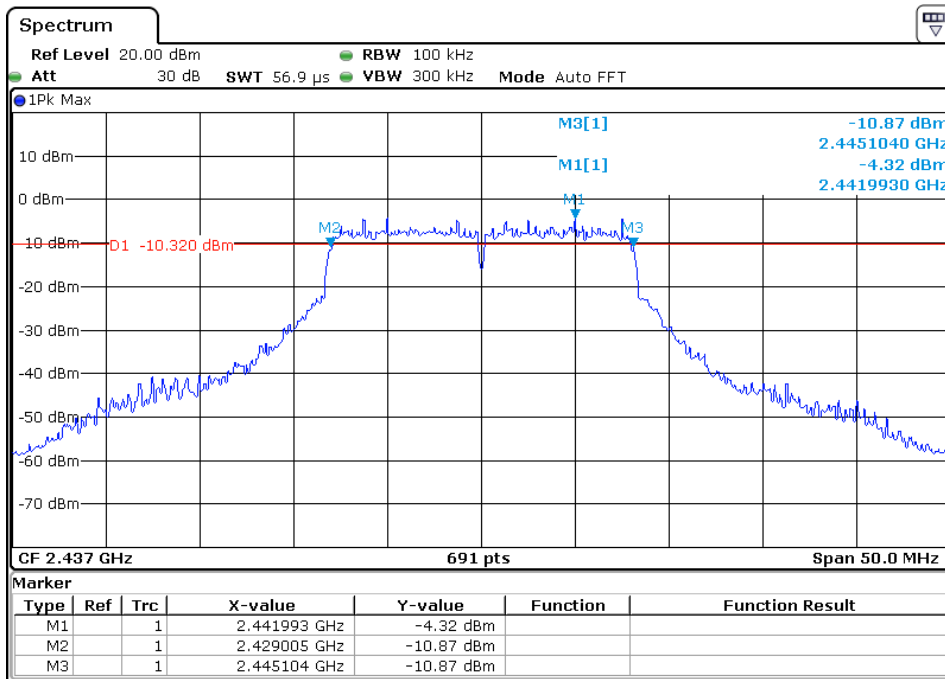

Channel 11: 2.462GHz:

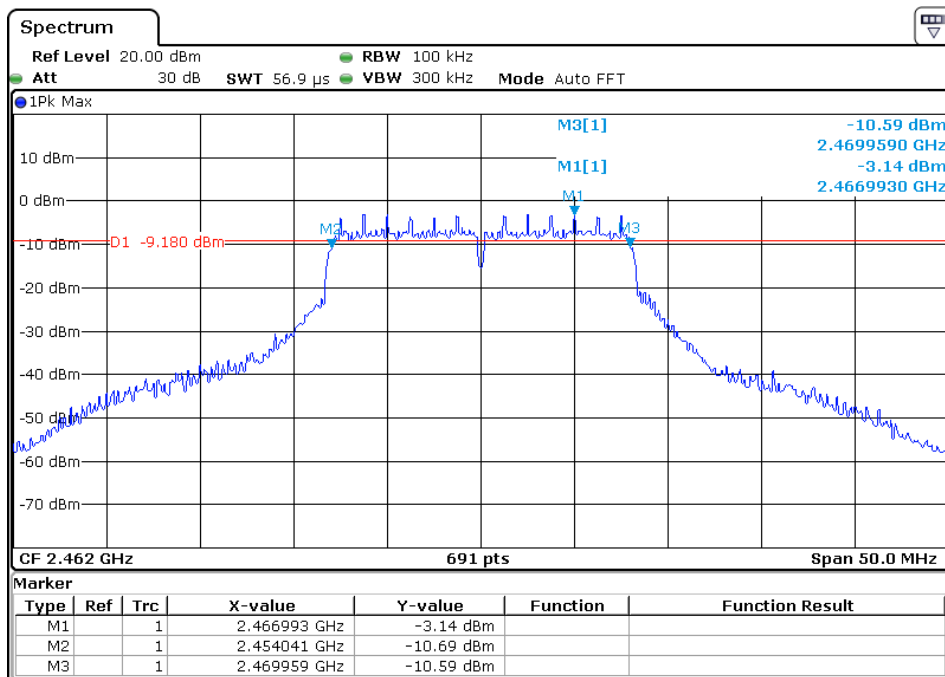

802.11n(HT20) mode with 72.2Mbps data rate

Channel 1: 2.412GHz:

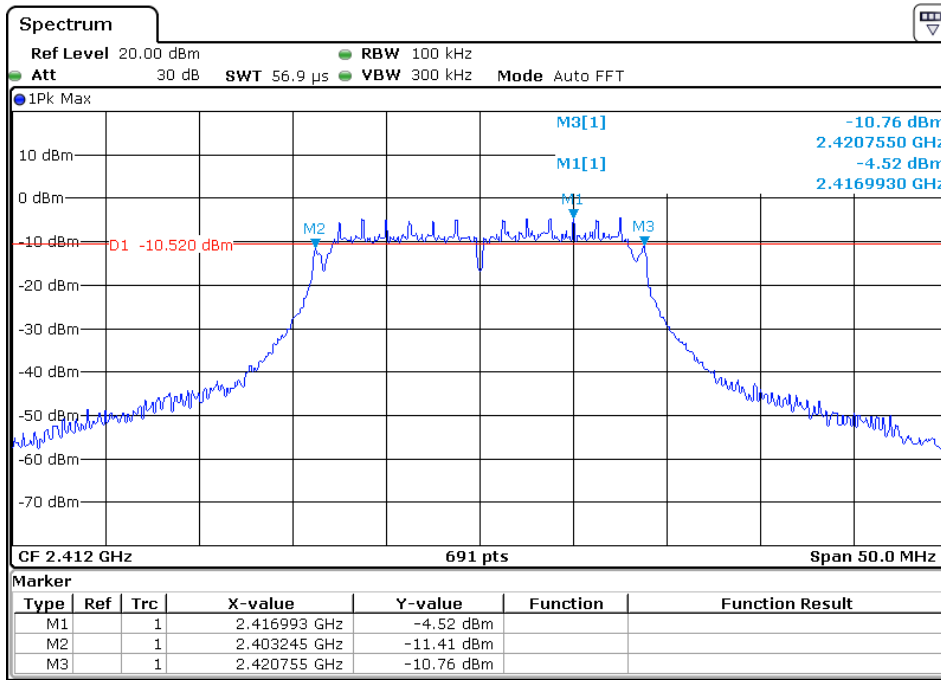

Channel 6: 2.437GHz:

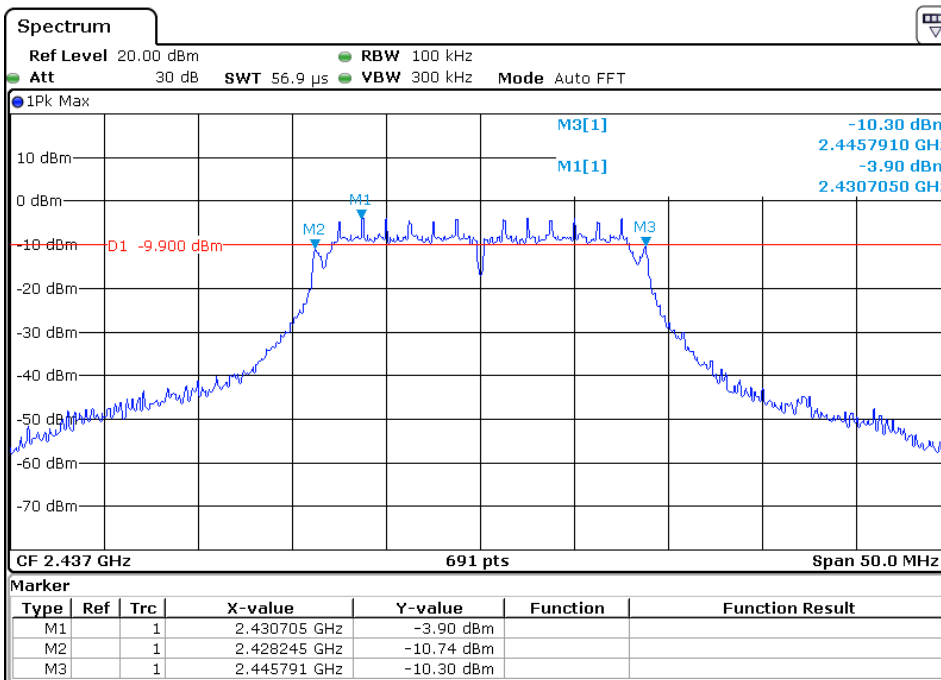

Channel 11: 2.462GHz:

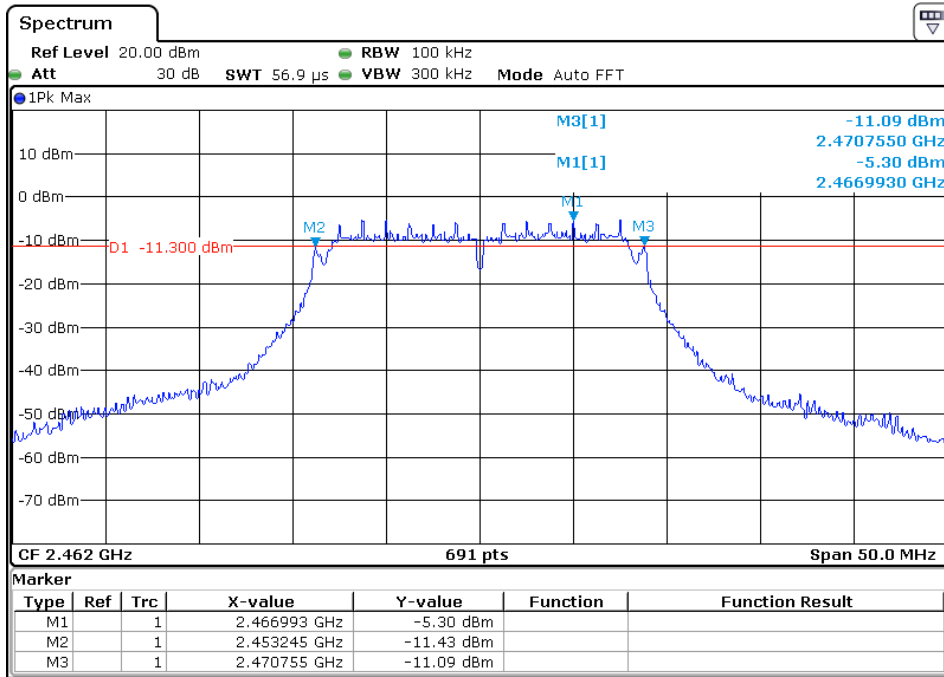

7.6 Maximum Peak Output Power

- Test Requirement:** FCC Part 15 C section 15.247
 (b)(3) For systems using digital modulation in the 902-928 MHz, 2400-2483.5 MHz, and 5725-5850 MHz bands: 1 Watt.
 Except as shown in paragraph (c) of this section, if transmitting antennas of directional gain greater than 6 dBi are used, the conducted output power from the intentional radiator shall be reduced below the stated values in paragraphs (b) (1), (b) (2), and (b) (3) of this section, as appropriate, by the amount in dB that the directional gain of the antenna exceeds 6 dBi.
- Test Method:** FCC/KDB-558074 D01 v03r04 9.2.3 Measurement using an RF average power meter
- Test Status:** Pre-Scan has been conducted to determine the worst-case mode from all possible combinations between available modulations, data rates and antenna ports (if EUT with antenna diversity architecture). Following channel(s) was (were) selected for the final test as listed below.
 Pre-test the EUT under 2 modes: power-supplied by using the AC adapter and power-supplied by using internal battery. After pre-testing, we found the worst case is the test mode of EUT power-supplied by using internal battery.
- Test Configuration:**

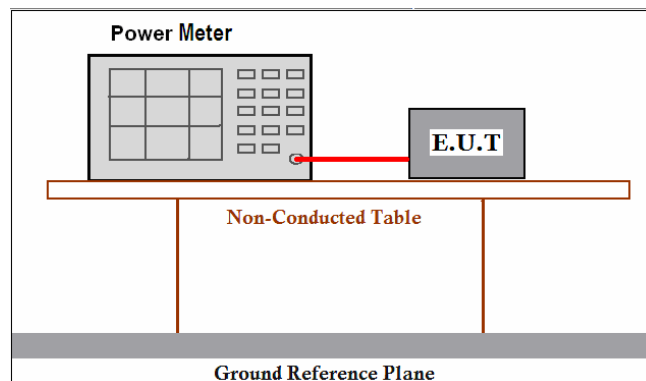

Test Procedure:

1. Remove the antenna from the EUT and then connect a low attention attenuation RF cable
 (Cable loss =0.5dB) from the antenna port to the power meter.
2. Measurement using an RF average power meter.
3. Report the worse case.

Test result:

Channel No.	Frequency (MHz)	Mode	Data Rate	Measured Power (dBm)	Limit	Result
1	2412	802.11b	11 Mbps	9.28	1W(30dBm)	Pass
6	2437		11 Mbps	9.45		Pass
11	2462		11 Mbps	9.68		Pass
1	2412	802.11g	54 Mbps	8.16		Pass
6	2437		54 Mbps	8.54		Pass
11	2462		54 Mbps	8.29		Pass
1	2412	802.11n (HT20)	72.2 Mbps	7.30		Pass
6	2437		72.2 Mbps	7.55		Pass
11	2462		72.2 Mbps	7.49		Pass

Remark: Level = Read Level + Cable Loss.

The unit does meet the FCC requirements.

7.7 Peak Power Spectral Density

Test Requirement: FCC Part 15 C section 15.247
 (e) For digitally modulated systems, the power spectral density conducted from the intentional radiator to the antenna shall not be greater than 8 dBm in any 3 kHz band during any time interval of continuous transmission.
 This power spectral density shall be determined in accordance with the provisions of paragraph (b) of this section. The same method of determining the conducted output power shall be used to determine the power spectral density.

Test Method: ANSI C63.10: Clause 6.11.2.3

Test Status: Pre-Scan has been conducted to determine the worst-case mode from all possible combinations between available modulations, data rates and antenna ports (if EUT with antenna diversity architecture). Following channel(s) was (were) selected for the final test as listed below.
 Pre-test the EUT under 2 modes: power-supplied by using the AC adapter and power-supplied by using internal battery. After pre-testing, we found the worst case is the test mode of EUT power-supplied by using internal battery.

Test Configuration:

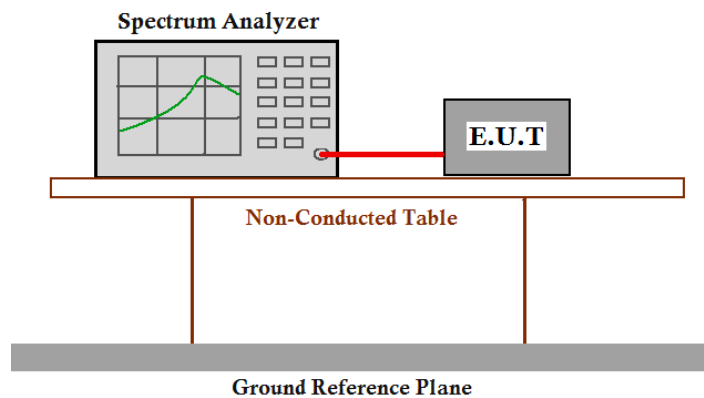

Test Procedure:

1. Remove the antenna from the EUT and then connect a low attention attenuation RF cable (cable loss =1.0 dB) from the antenna port to the spectrum analyzer or power meter.
2. Set the spectrum analyzer:
 - a) Set CENTER FREQUENCY = Frequency from Power Spectral Density Test Matrix (see 6.10.2)
 - b) Set SPAN = 20 MHz (For devices with a nominal 40 MHz BW, 50 MHz span will be needed)
 - c) Set REFERENCE LEVEL = 20 dBm
 - d) Set ATTENUATION = 0 dB (add internal attenuation, if necessary)
 - e) Set SWEEP TIME = Coupled
 - f) Set RBW = 3 kHz
 - g) Set VBW = 10 kHz
 - h) Set DETECTOR = Peak
 - i) Set MKR = Center Frequency
 - j) Set TRACE = CLEAR WRITE

Place the radio in continuous transmit mode. Set the TRACE to MAX HOLD, and after the trace stabilizes, the TRACE to VIEW. Set the marker on the peak of the signal and then adjust the center frequency of the spectrum analyzer to the marker frequency.

After viewing the EUT waveform on the spectrum analyzer, perform the following spectrum analyzer functions to capture the trace:

Set SPAN = 300 kHz

Set SWEEP TIME = 100 s

Set TRACE = MAX HOLD

Set MKR = PEAK SEARCH

3. Measure the Power Spectral Density of the test frequency with special test status.
4. Repeat until all the test status is investigated.
5. Report the worse case.

Channel No.	Frequency (MHz)	Mode	Data Rate	Measured Peak Power		Result
				Spectral Density (dBm/3KHz)	Limit	
1	2412	802.11b	11 Mbps	-10.89	8dBm/3KHz	Pass
6	2437		11 Mbps	-10.33		Pass
11	2462		11 Mbps	-10.44		Pass
1	2412	802.11g	54 Mbps	-16.73		Pass
6	2437		54 Mbps	-18.93		Pass
11	2462		54 Mbps	-18.95		Pass
1	2412	802.11n (HT20)	72.2 Mbps	-19.15		Pass
6	2437		72.2 Mbps	-18.36		Pass
11	2462		72.2 Mbps	-19.59		Pass

Test result: Level = Read Level + Cable Loss.

The unit does meet the FCC requirements.

Result plot as follows:

802.11b mode with 11Mbps data rate

Channel 1: 2.412GHz:

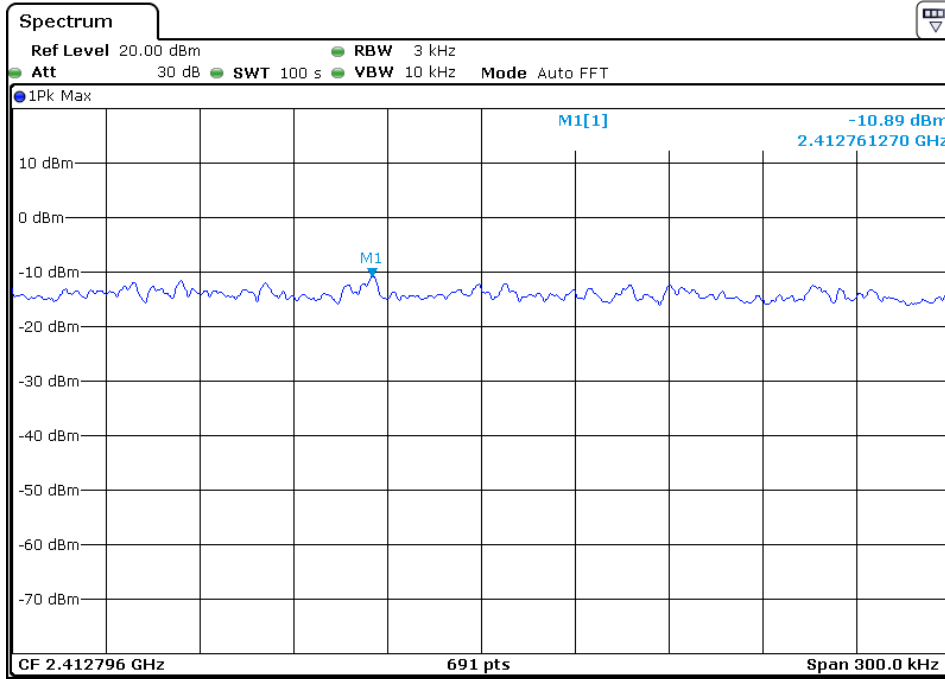

Channel 6: 2.437GHz:

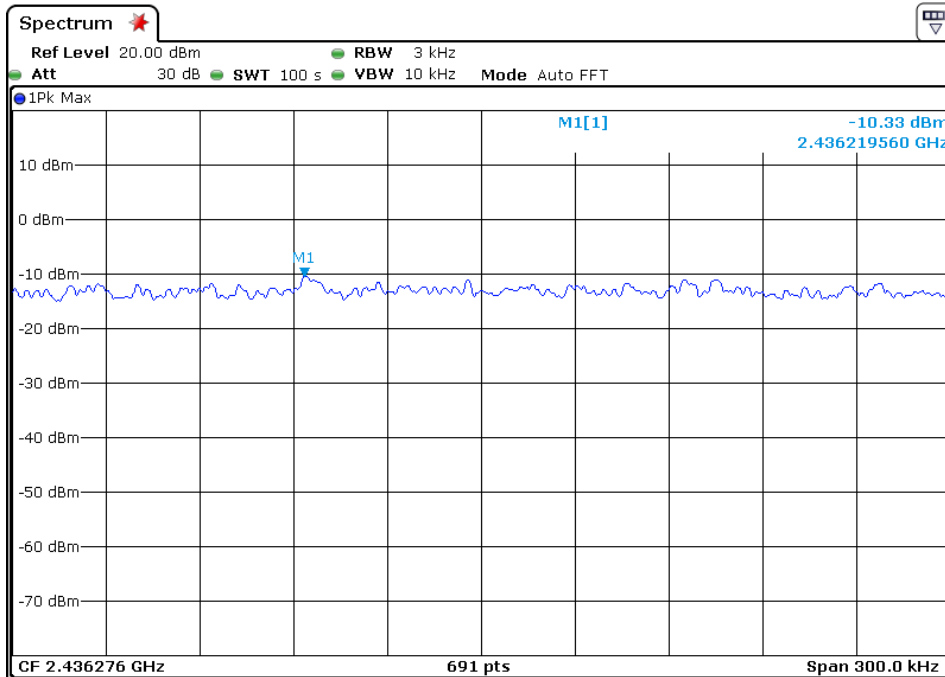

Channel 11: 2.462GHz:

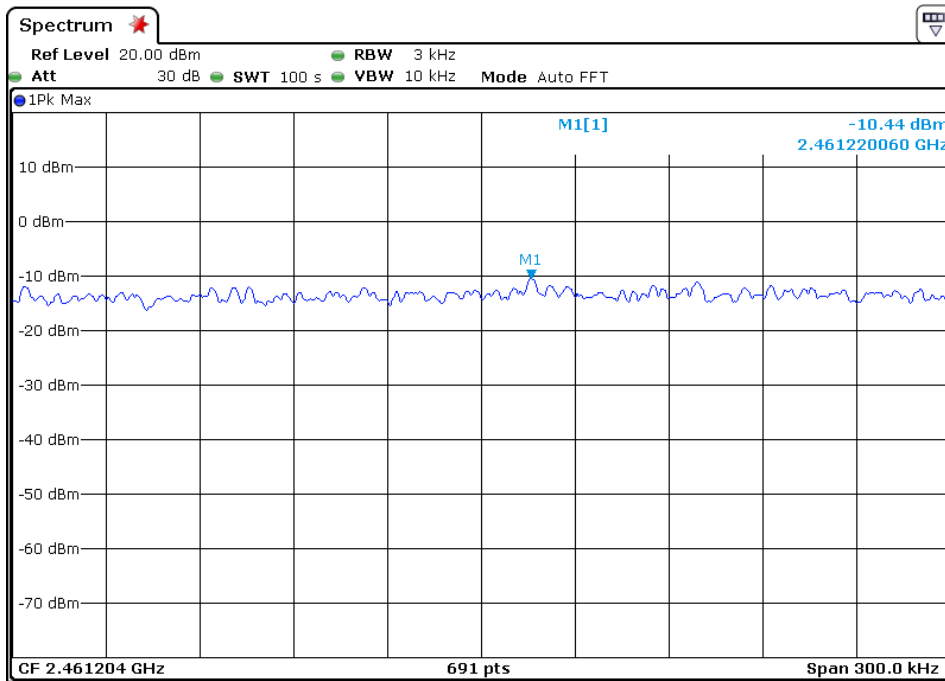

802.11g mode with 54Mbps data rate

Channel 1: 2.412GHz:

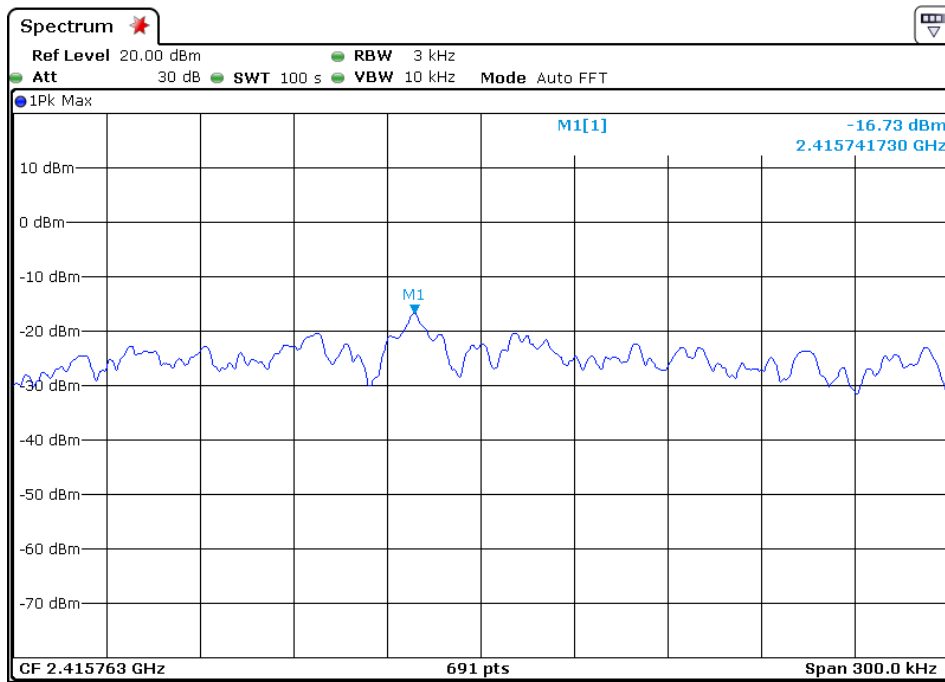

Channel 6: 2.437GHz:

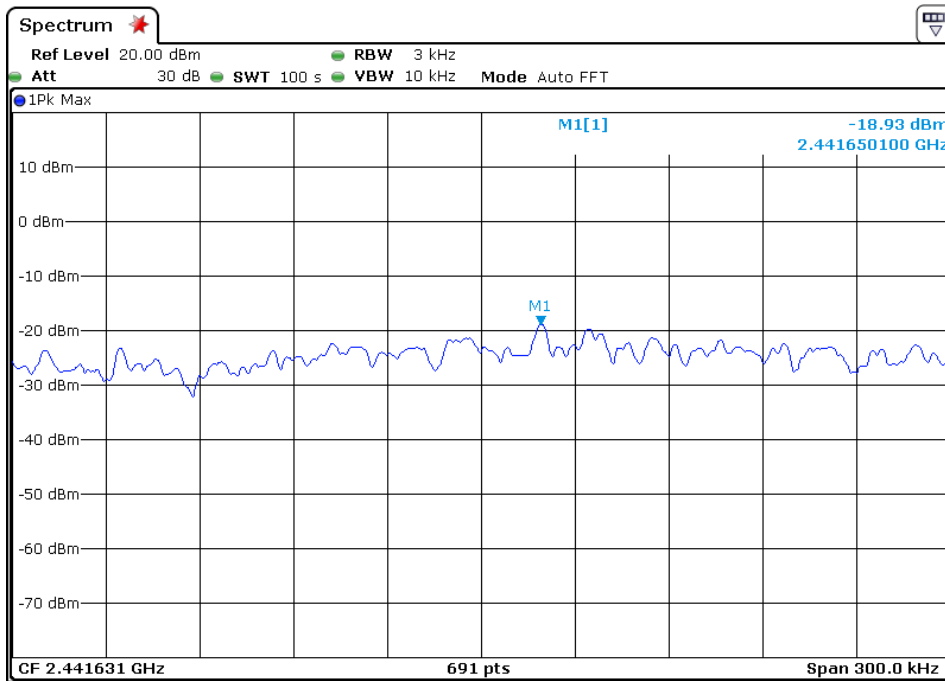

Channel 11: 2.462GHz:

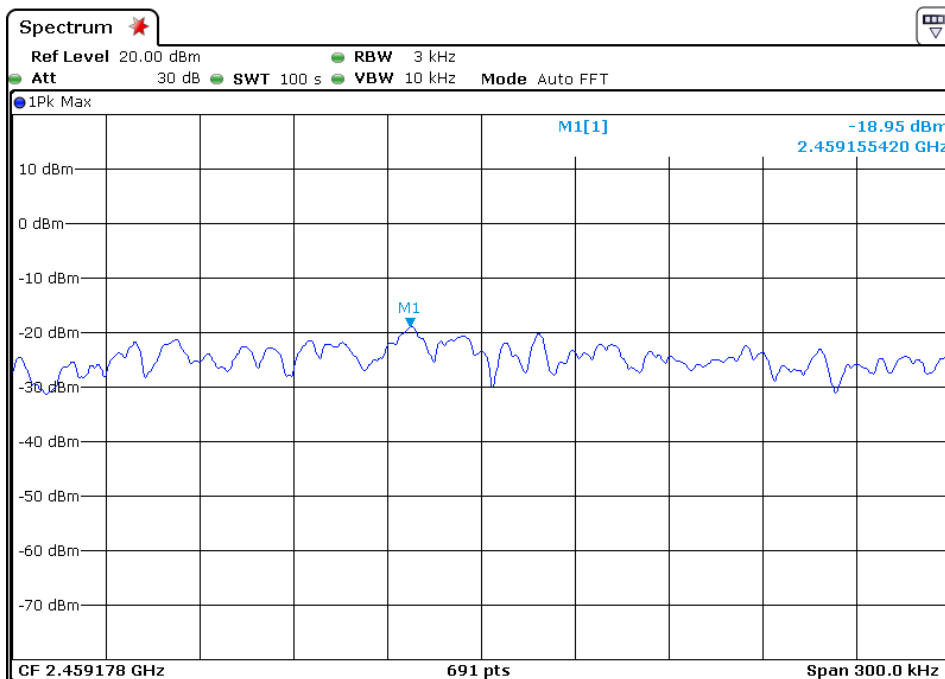

802.11n(HT20) mode with 72.2Mbps data rate

Channel 1: 2.412GHz:

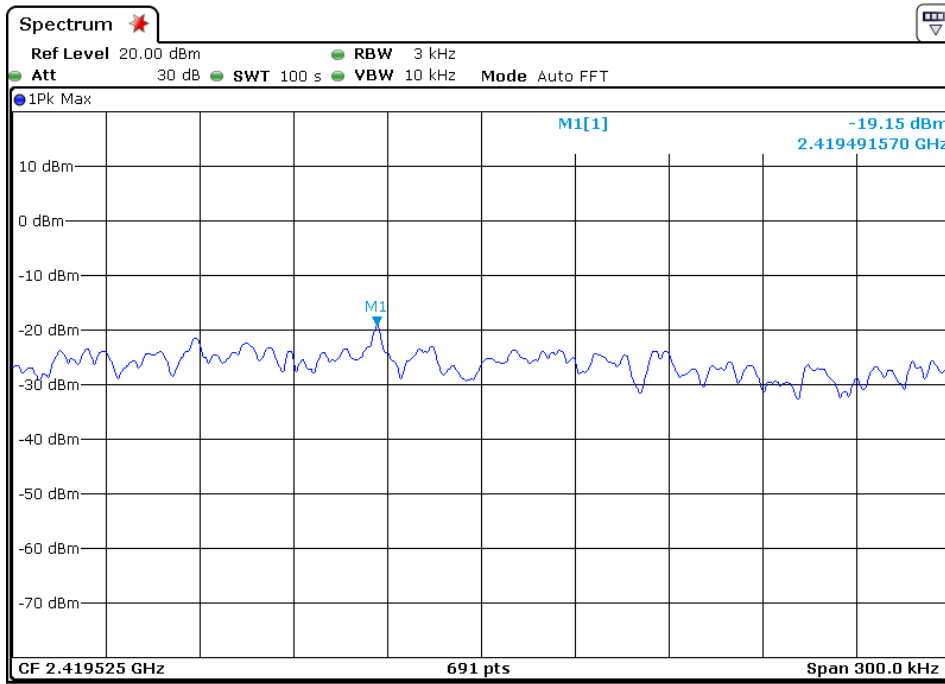

Channel 6: 2.437GHz:

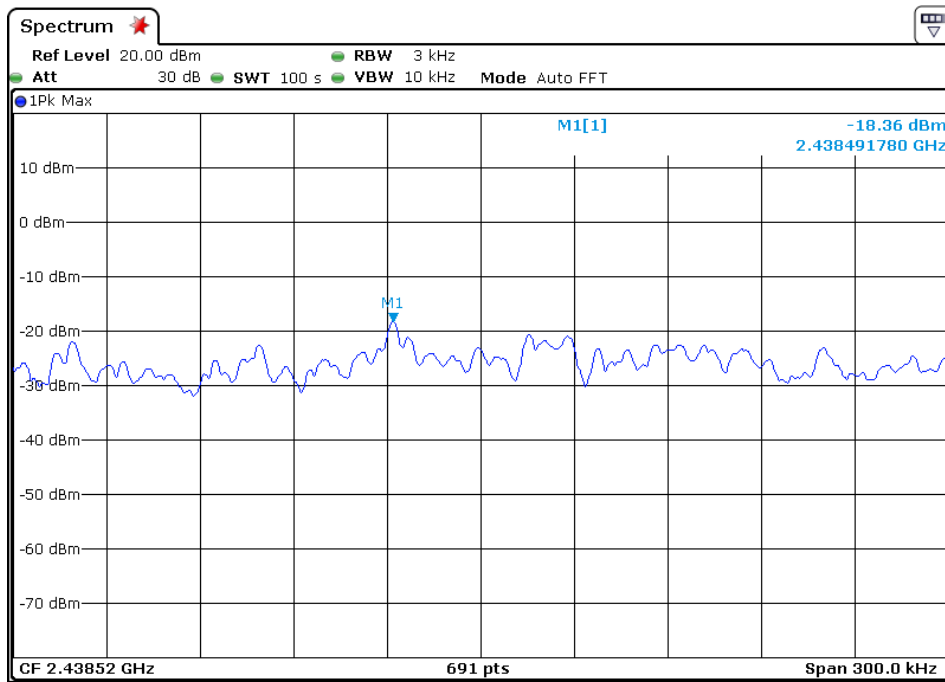

Channel 11: 2.462GHz:

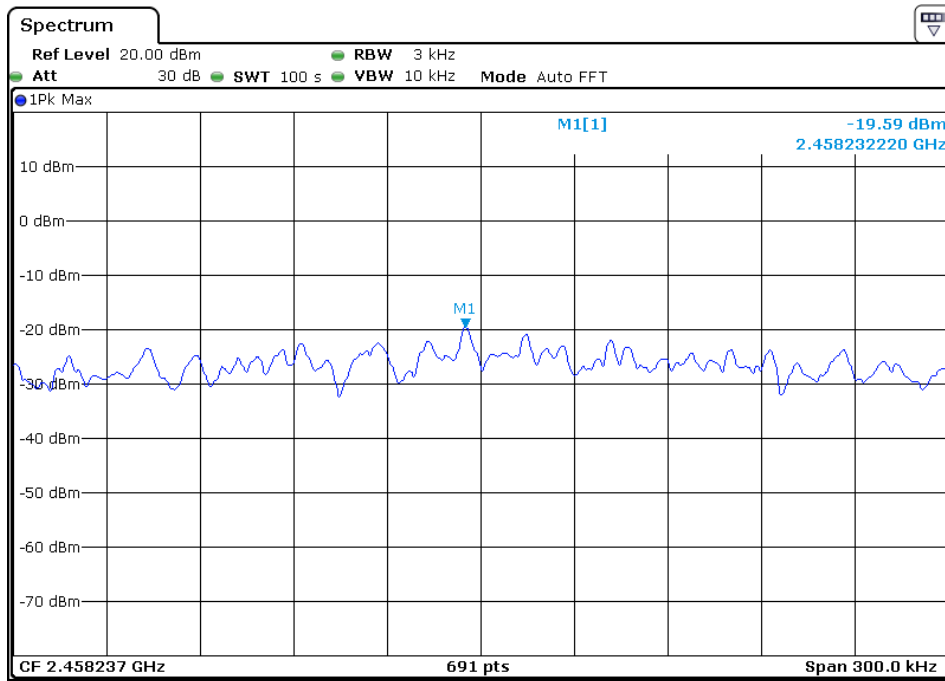

7.8 Band Edges Requirement

Test Requirement:	FCC Part 15 C section 15.247 (d) In any 100 kHz bandwidth outside the frequency band in which the spread spectrum or digitally modulated intentional radiator is operating. The radio frequency power that is produced by the intentional radiator shall be at least 20 dB below that in the 100 kHz bandwidth within the band that contains the highest level of the desired power. Based on either an RF conducted or a radiated measurement. Provided the transmitter demonstrates compliance with the peak conducted power limits.
Frequency Band:	2400 MHz to 2483.5 MHz
Test Method:	FCC/KDB-558074 D01 vv03r04 Clause 13.3.1
Test Status:	Pre-Scan has been conducted to determine the worst-case mode from all possible combinations between available modulations, data rates and antenna ports (if EUT with antenna diversity architecture). Following channel(s) was (were) selected for the final test as listed below. Pre-test the EUT under 2 modes: power-supplied by using the AC adapter and power-supplied by using internal battery. After pre-testing, we found the worst case is the test mode of EUT power-supplied by using internal battery.
Test Configuration:	

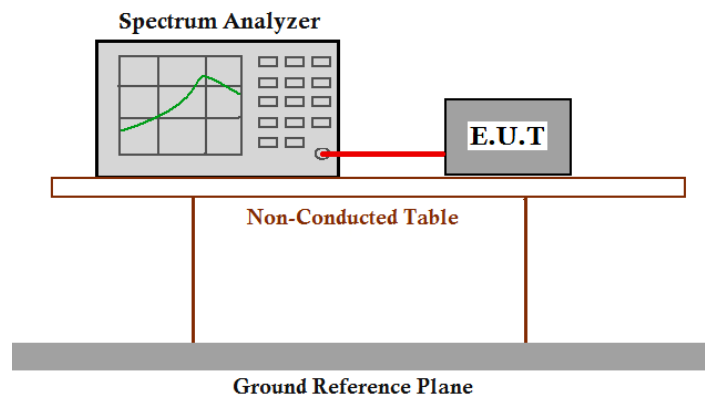

Test Procedure:

1. Remove the antenna from the EUT and then connect a low RF cable from the antenna port to the spectrum analyzer or power meter.
2. Set instrument center frequency to the frequency of the emission to be measured(must be within 2MHz of the authorized band edge).
3. Set span to 2MHz,
4. RBW=100kHz,
5. $VBW \geq 3 \times RBW$
6. Detector=peak
7. Sweep time =auto,

8. Trace mode=max hold.
9. Allow sweep to continue until the trace stabilizes(required measurement time may increase for low duty cycle applications)
10. Compute the power by integrating the spectrum over 1MHz using the analyzer's band power measurement function with band limits set equal to the emission frequency($f_{\text{emission}} \pm 0.5\text{MHz}$).If the instrument does not have a band power function,the sum the amplitude levels(in power units) at 100kHz intervals extending across the 1MHz spectrum defined by $f_{\text{emission}} \pm 0.5\text{MHz}$.

Test result with plots as follows:

Compare with the output power of the lowest frequency, the Lower Edges attenuated more than 20dB

Compare with the output power of the highest frequency, the Upper Edges attenuated more than 20dB.

802.11b mode with 11 Mbps data rate

Channel1: 2.412 GHz

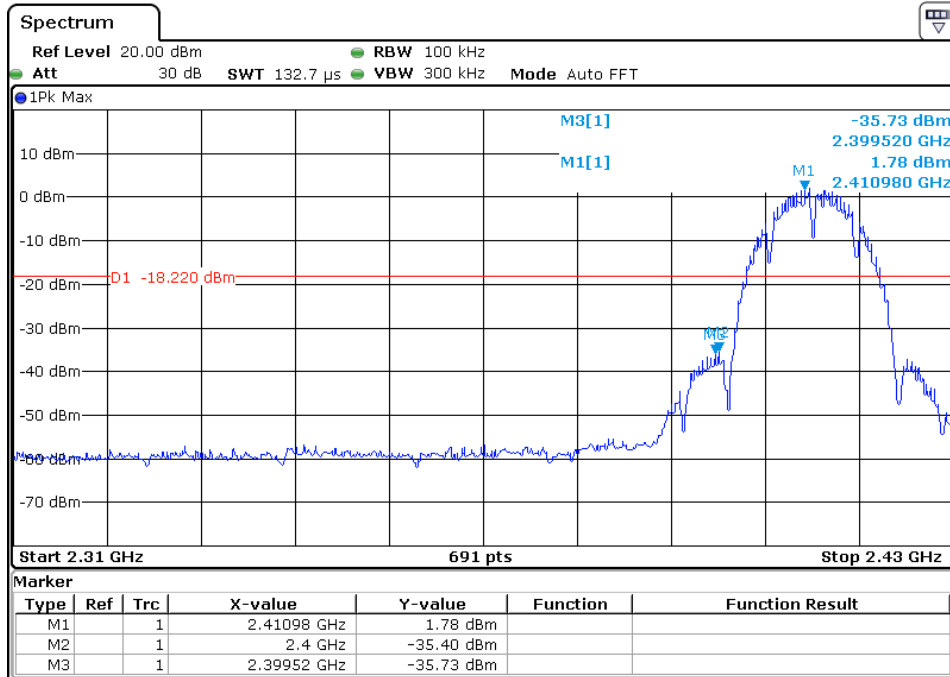

802.11b mode with 11 Mbps data rate

Channel11: 2.462 GHz

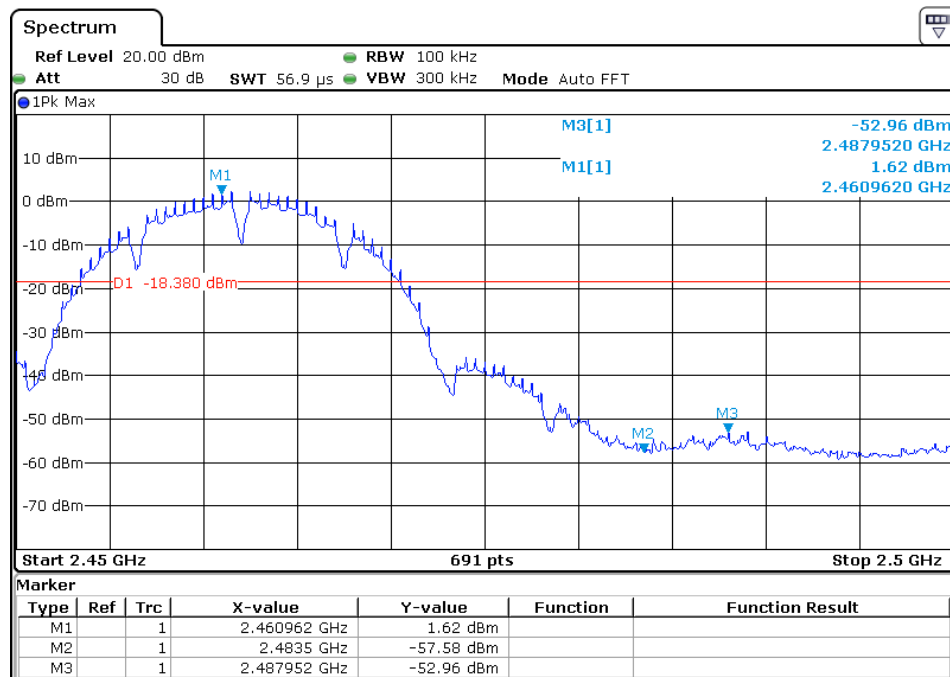

802.11g mode with 54 Mbps data rate
 Channel1: 2.412 GHz

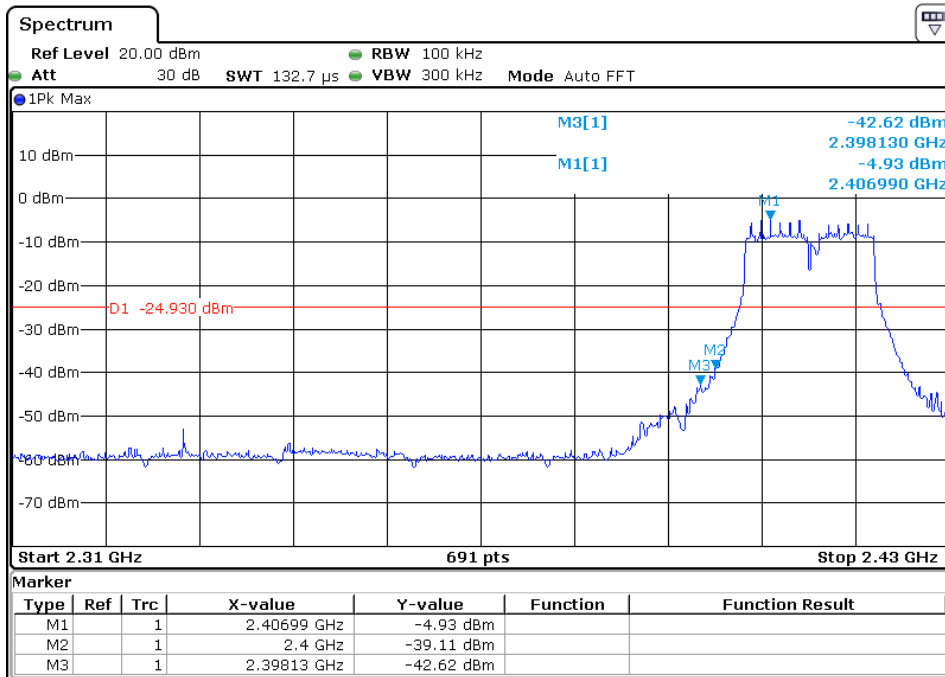

802.11g mode with 54 Mbps data rate
 Channel11: 2.462 GHz

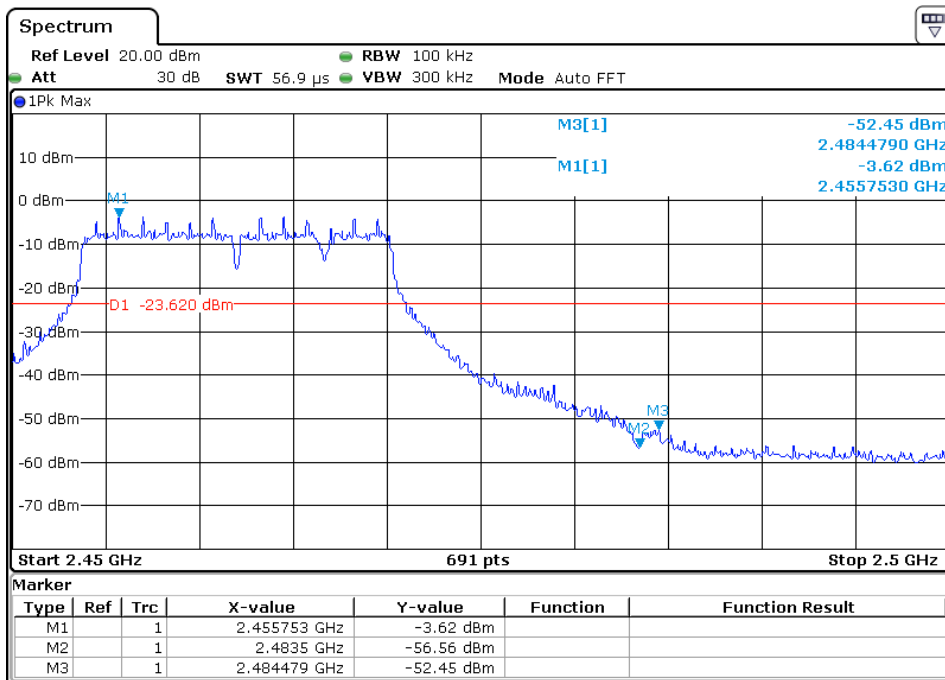

802.11n(HT20) mode with 72.2Mbps data rate
 Channel1: 2.412 GHz

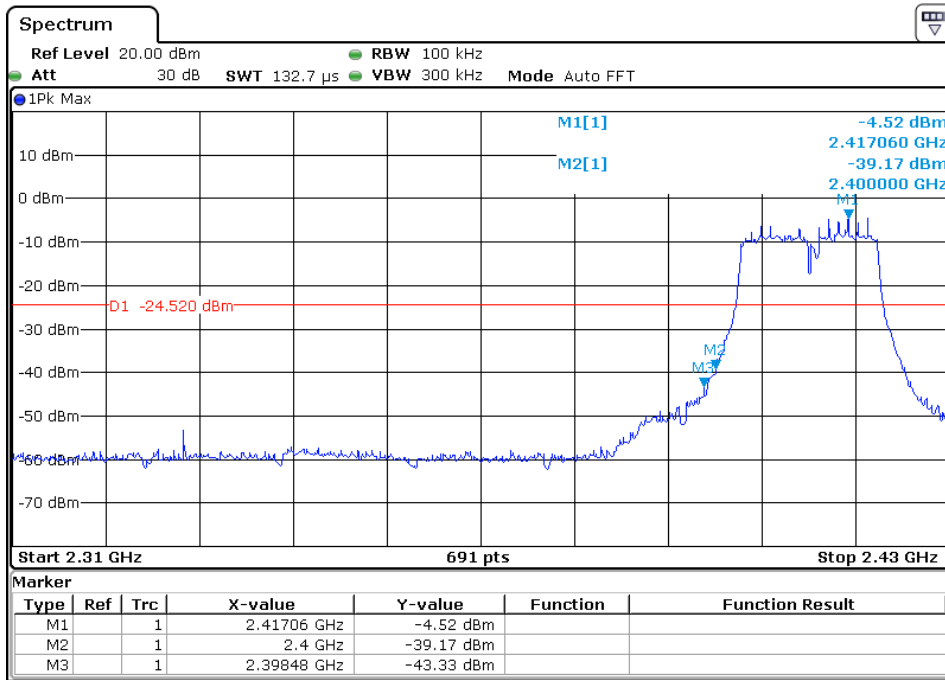

802.11n(HT20) mode with 72.2Mbps data rate
 Channel11: 2.462 GHz

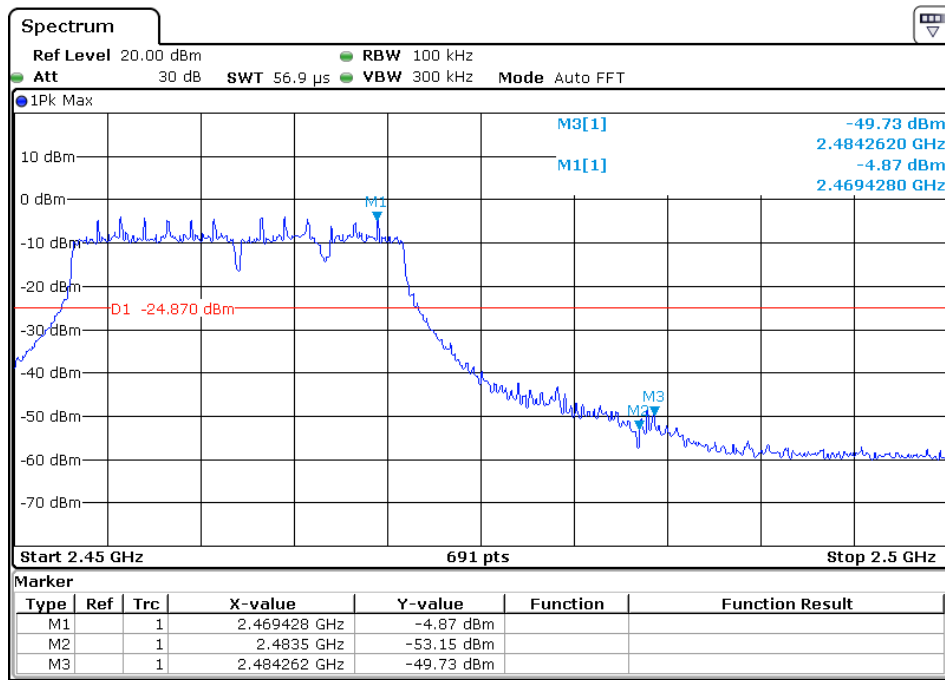

7.9 Conducted Spurious Emissions

Test Requirement: FCC Part 15 C section 15.247

(d) In any 100 kHz bandwidth outside the frequency band in which the spread spectrum or digitally modulated intentional radiator is operating, the radio frequency power that is produced by the intentional radiator shall be at least 20 dB below that in the 100 kHz bandwidth within the band that contains the highest level of the desired power. Based on either an RF conducted or a radiated measurement. Provided the transmitter demonstrates compliance with the peak conducted power limits.

Test Method: ANSI C63.10: Clause 6.7

Test Status: Pre-Scan has been conducted to determine the worst-case mode from all possible combinations between available modulations, data rates and antenna ports (if EUT with antenna diversity architecture). Following channel(s) was (were) selected for the final test as listed below. Pre-test the EUT under 2 modes: power-supplied by using the AC adapter and power-supplied by using internal battery. After pre-testing, we found the worst case is the test mode of EUT power-supplied by using internal battery.

Test Configuration:

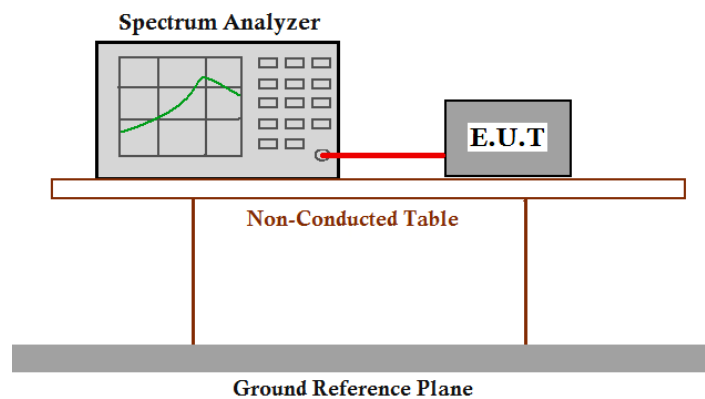

Test Procedure:

1. Remove the antenna from the EUT and then connect a low RF cable from the antenna port to the spectrum analyzer or power meter.
2. Set the spectrum analyzer: RBW=100 KHz, VBW = 300KHz. Sweep = auto; Detector Function = Peak. Trace = Max Hold, Scan up through 10th harmonic.
3. Measure the Conducted Spurious Emissions of the test frequency with special test status.
4. Repeat until all the test status is investigated.
5. Report the worse case.

Result plot as follows:

802.11b mode with 11Mbps data rate

Channel 1: 2.412GHz:

30 MHz to 1 GHz

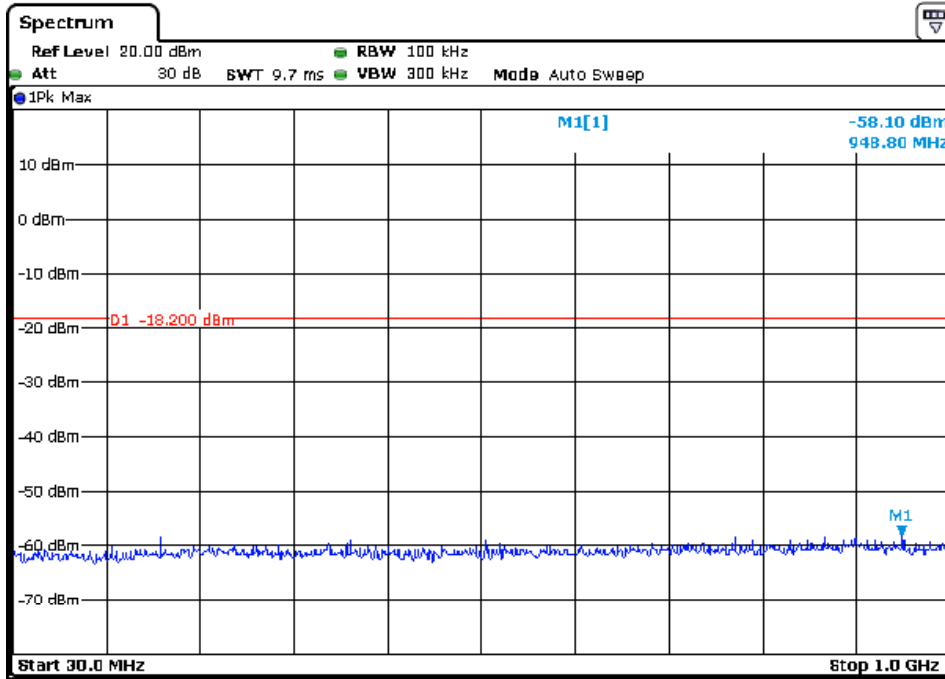

1 G to 3 GHz

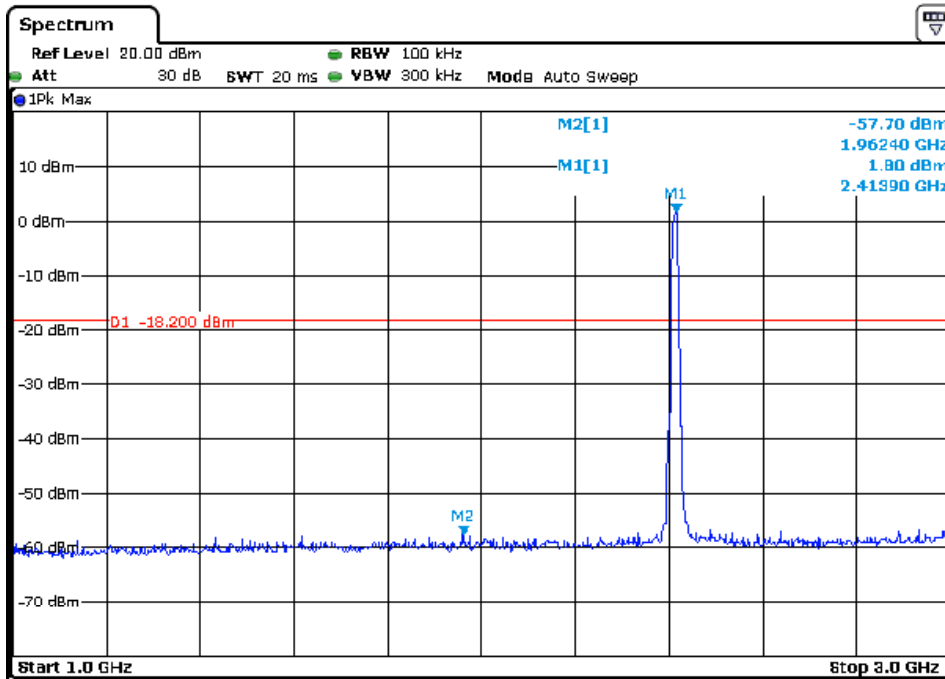

3 G to 13 GHz

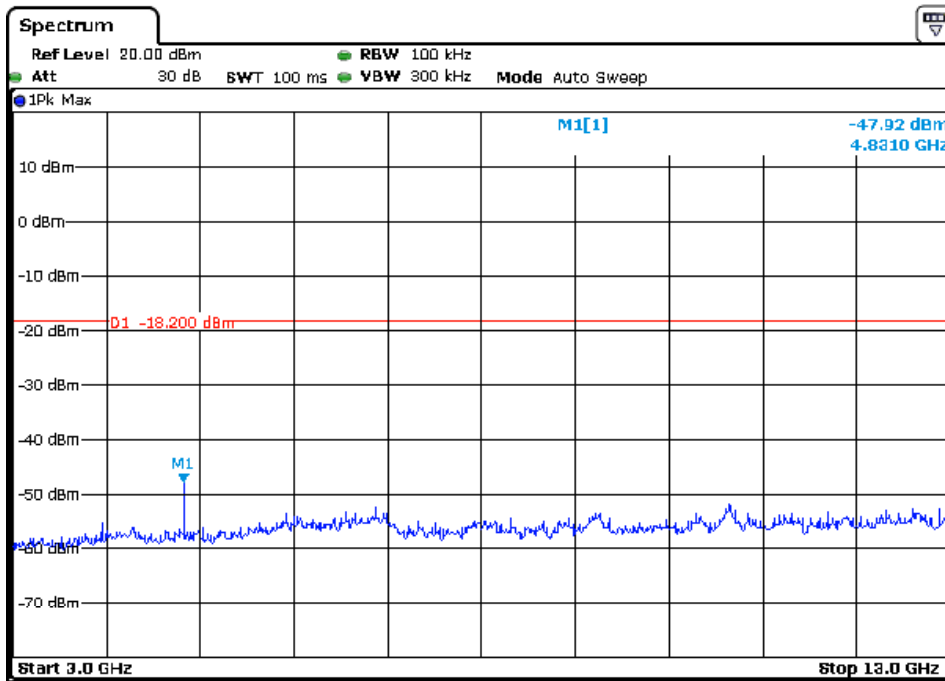

13 G to 25 GHz

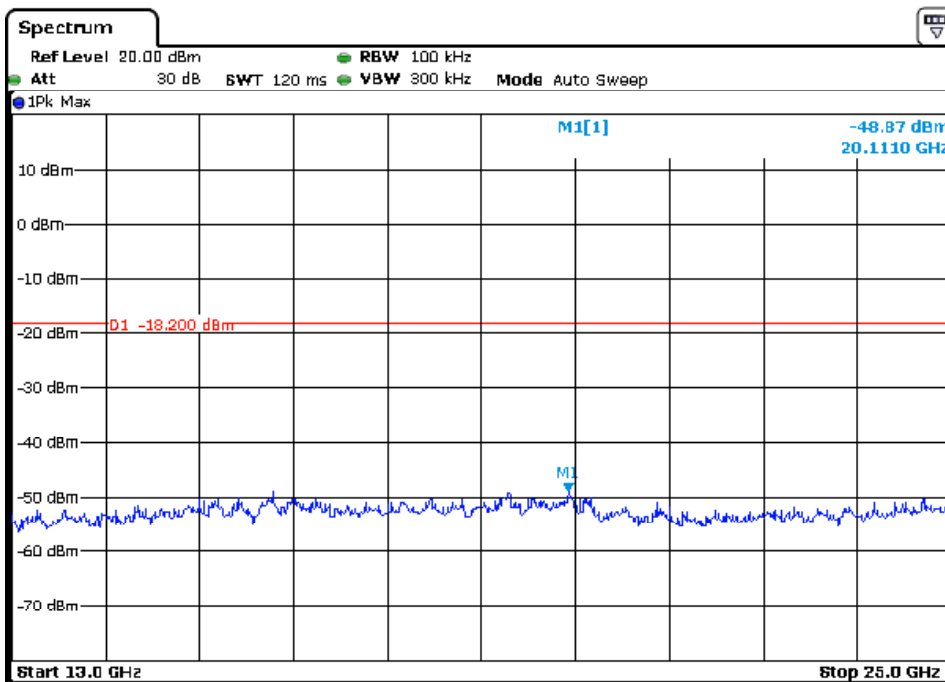

Channel 6: 2.437GHz:

30 MHz to 1 GHz

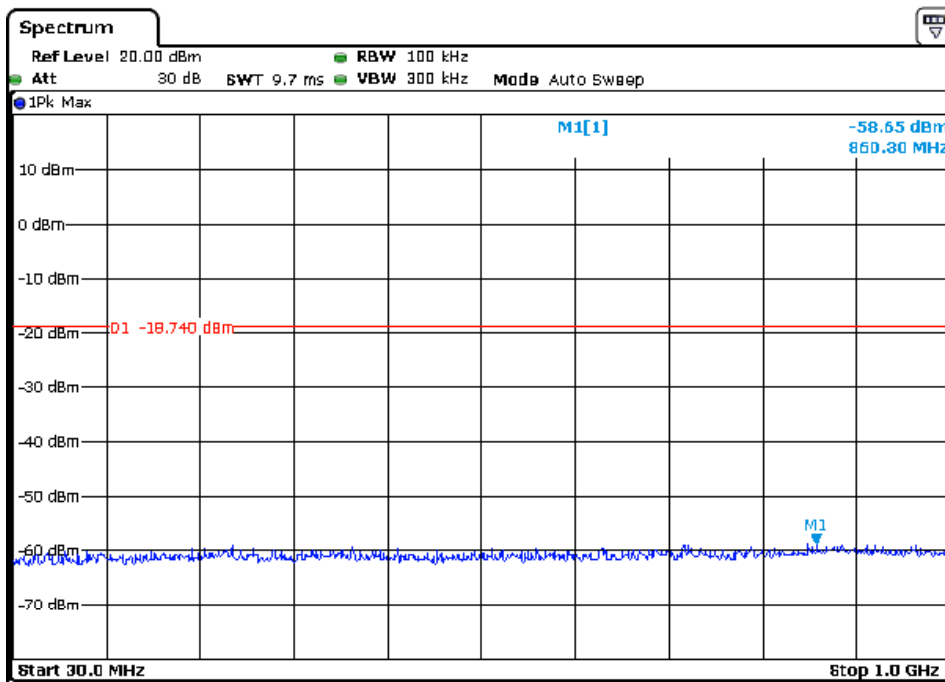

1 G to 3 GHz

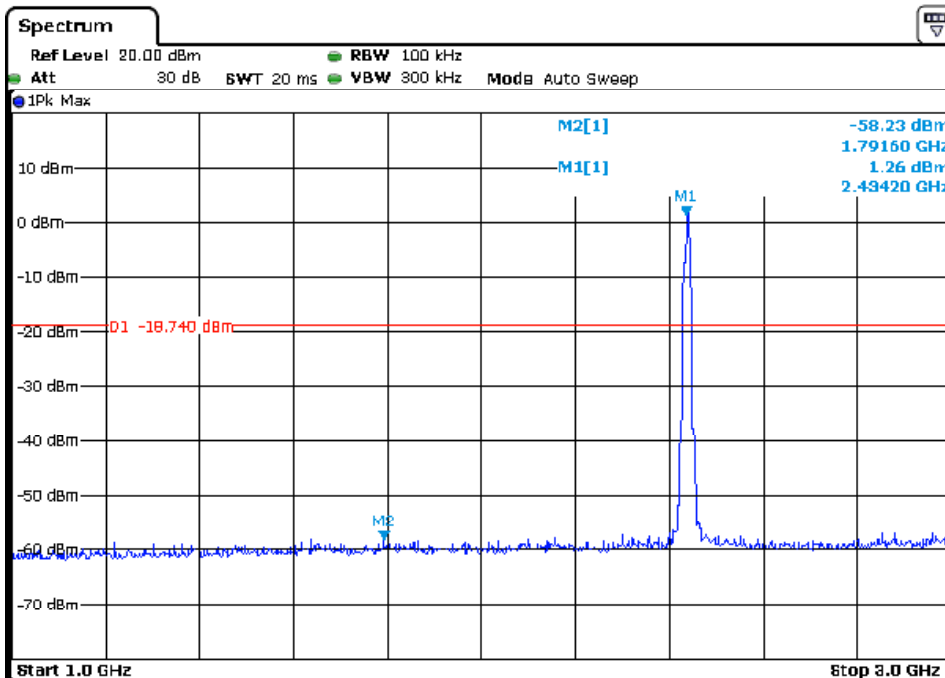

3 G to 13 GHz

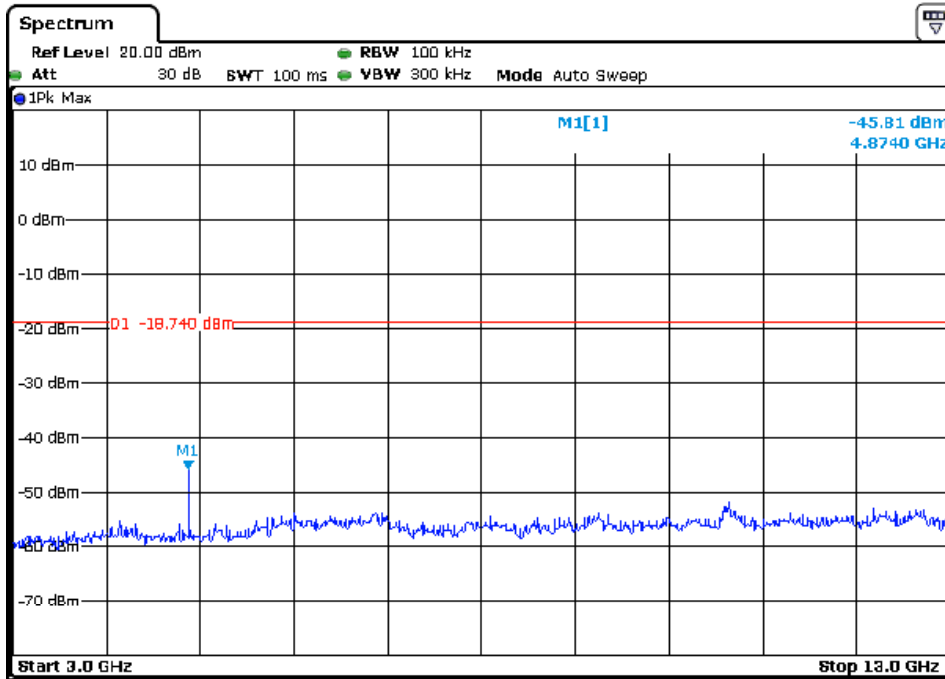

13 G to 25 GHz

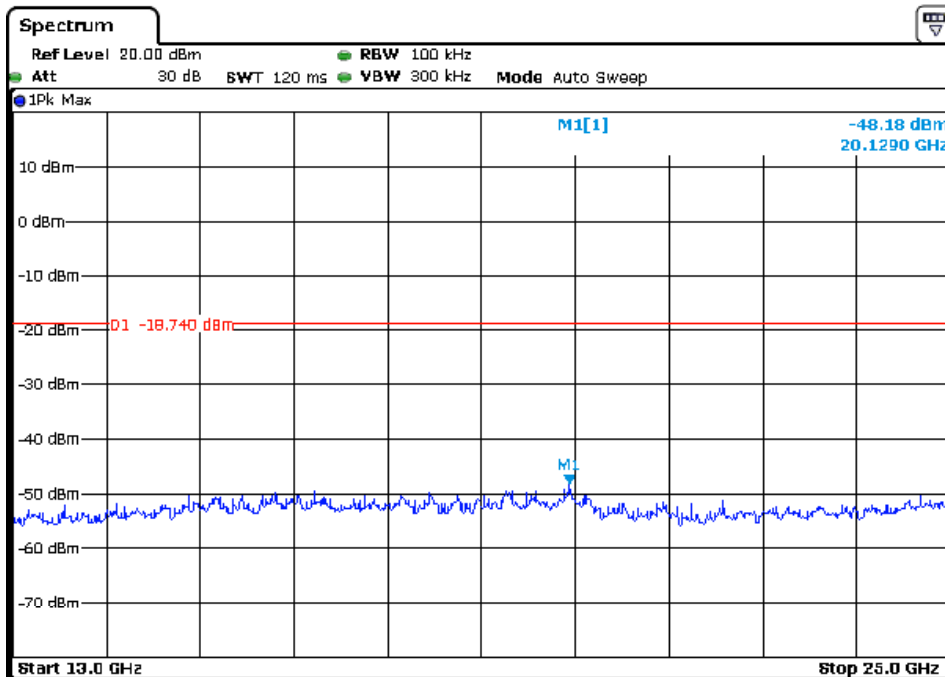

Channel 11:2.462 GHz

30 MHz to 1 GHz

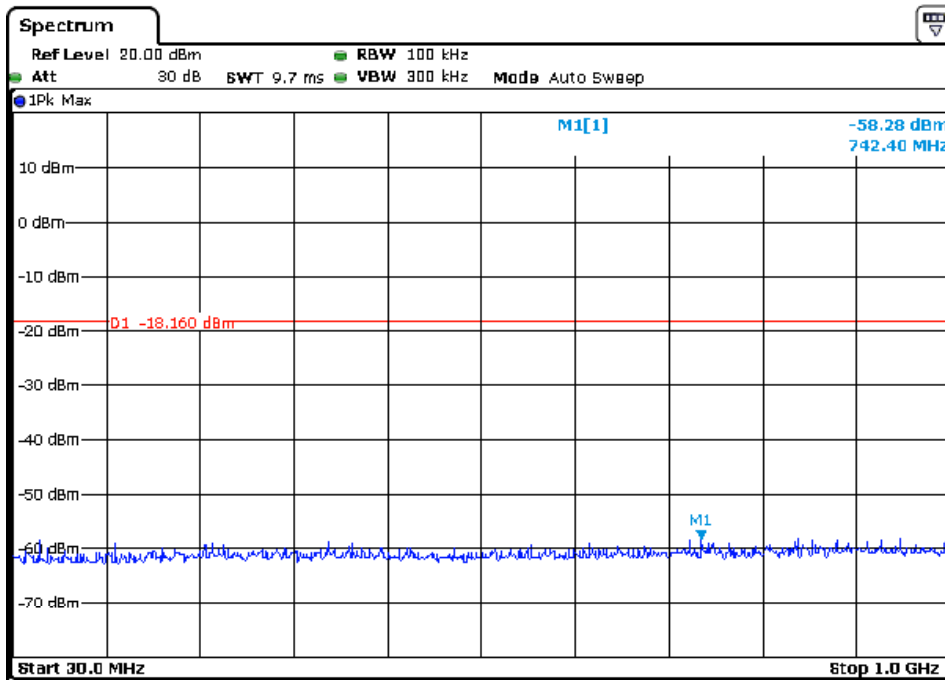

1 G to 3 GHz

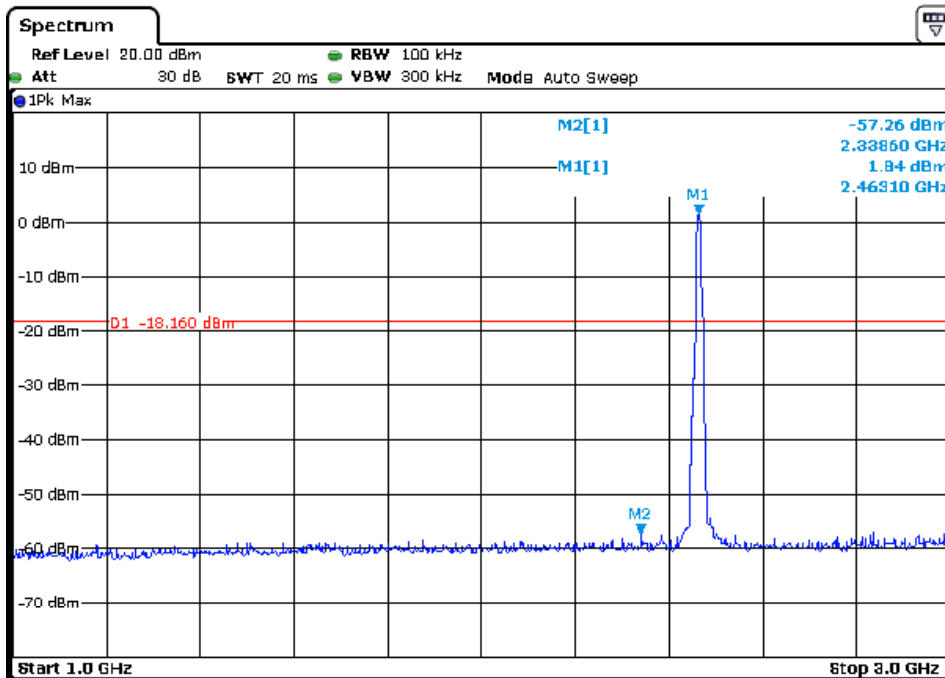

3 G to 13 GHz

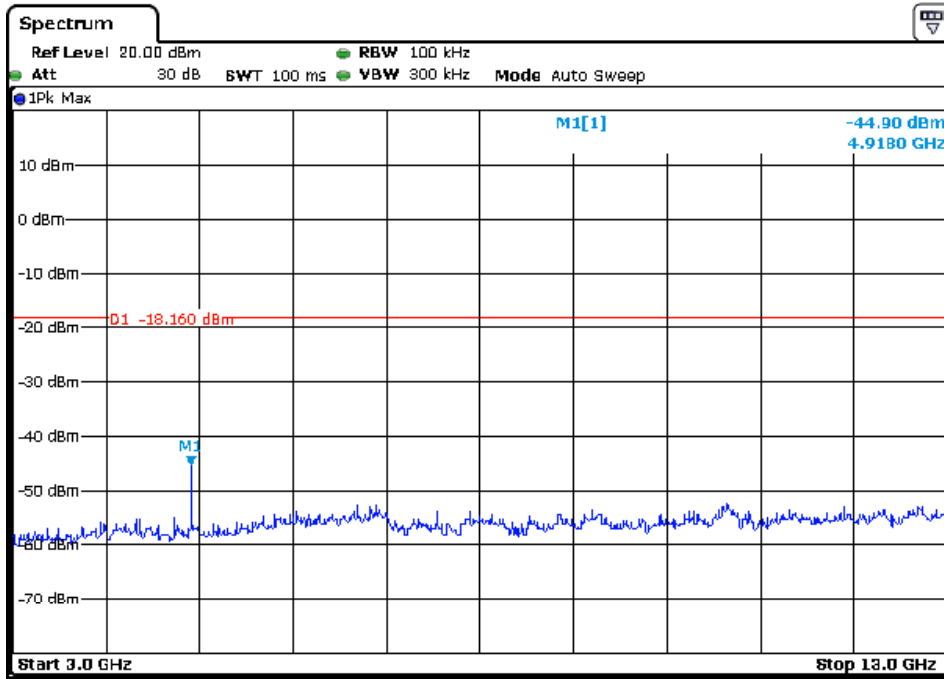

13 G to 25 GHz

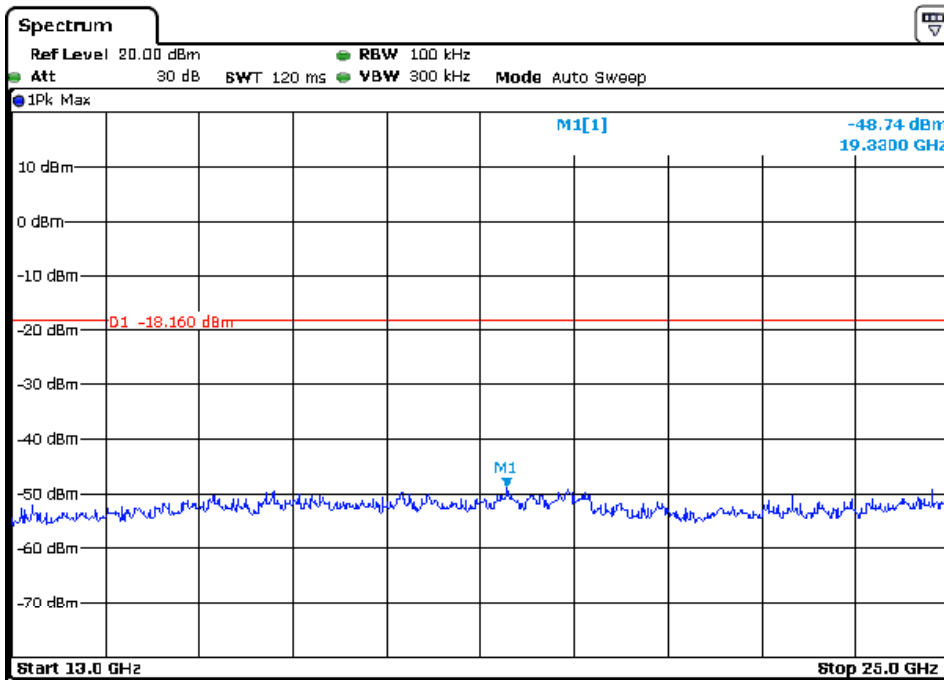

802.11g mode with 54Mbps data rate

Channel 1: 2.412GHz:

30 MHz to 1 GHz

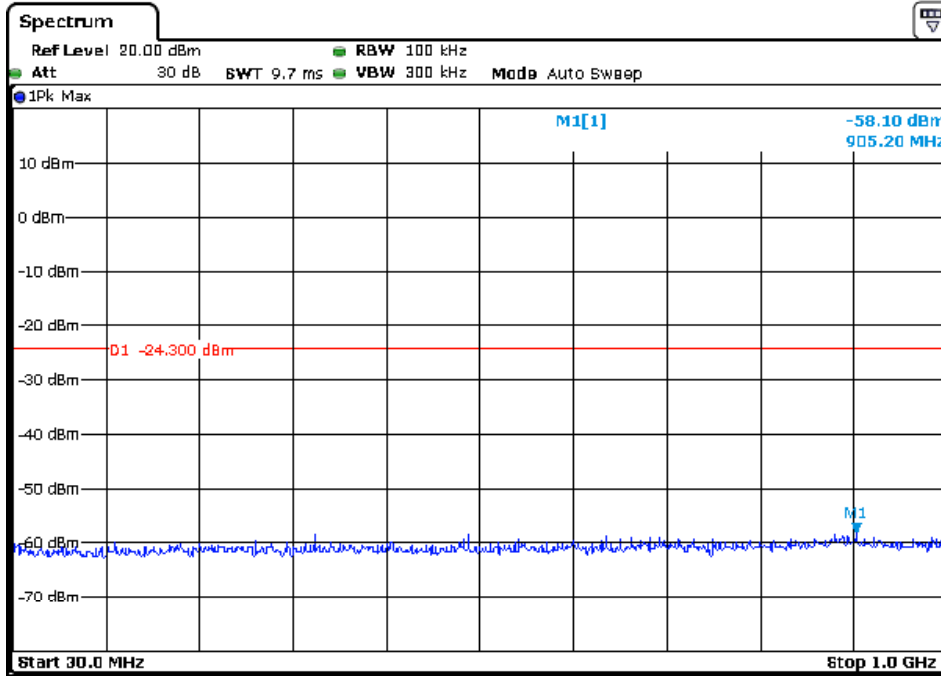

1 G to 3 GHz

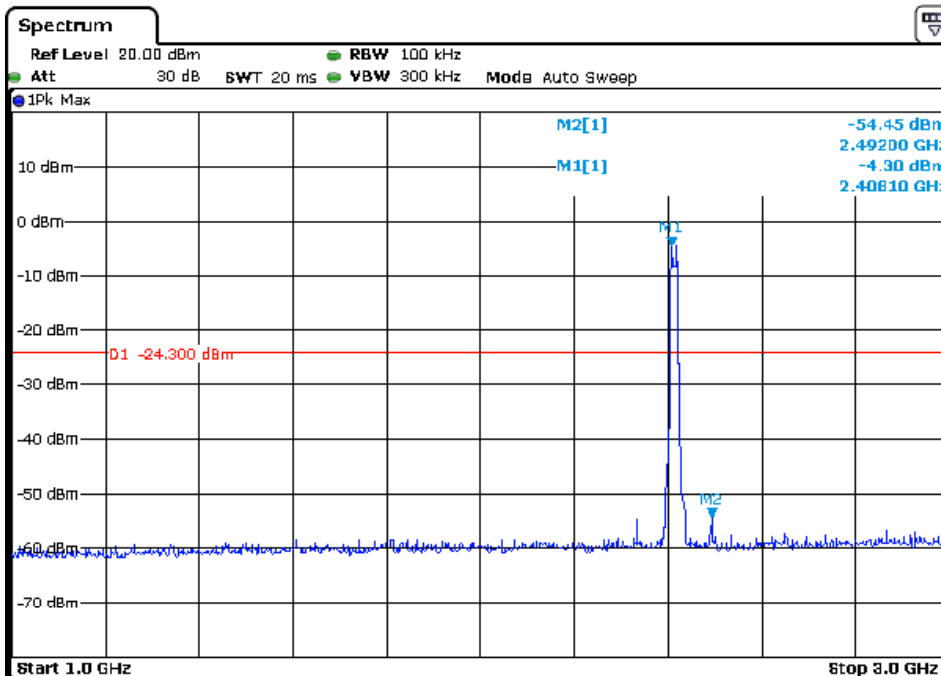

3 G to 13 GHz

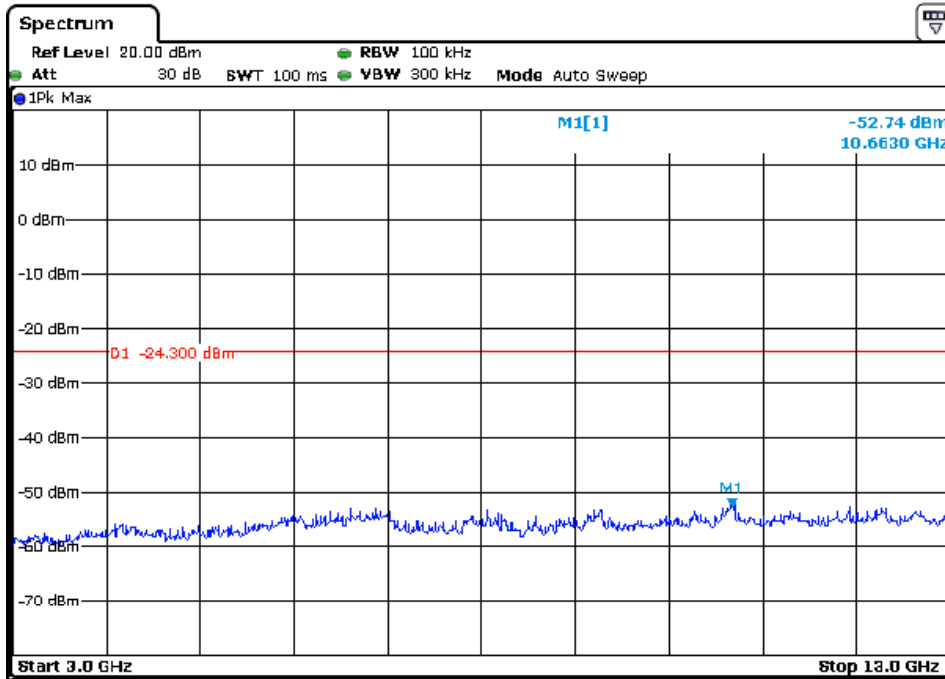

13 G to 25 GHz

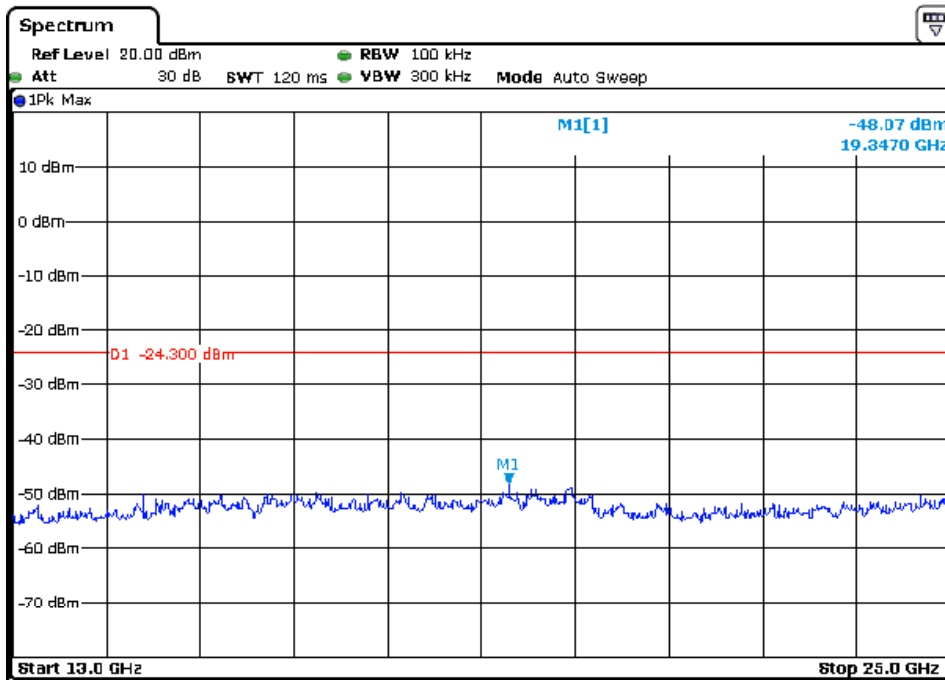

Channel 6: 2.437GHz:

30 MHz to 1 GHz

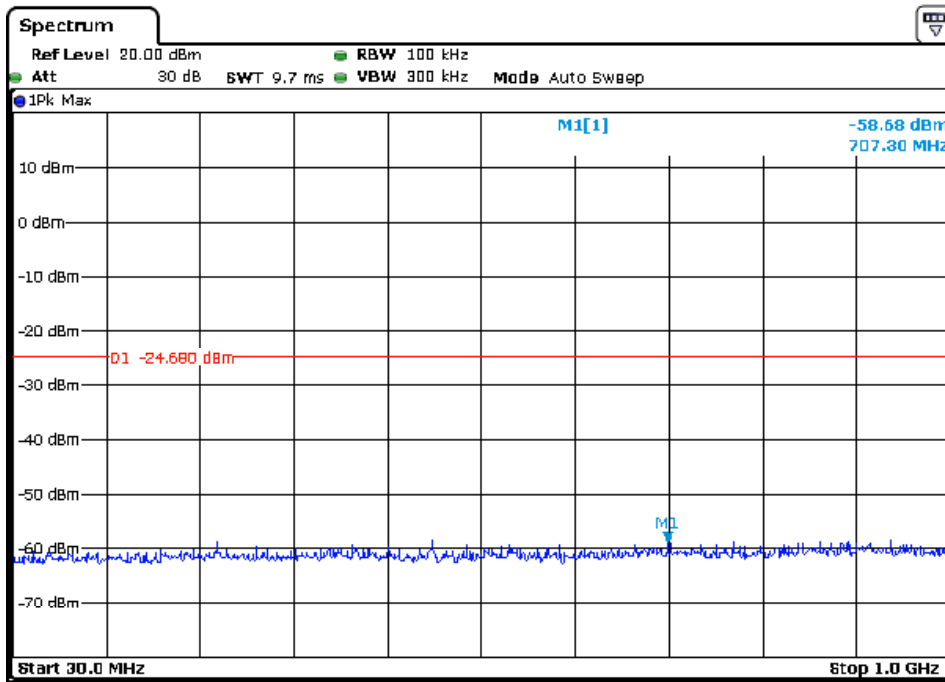

1 G to 3 GHz

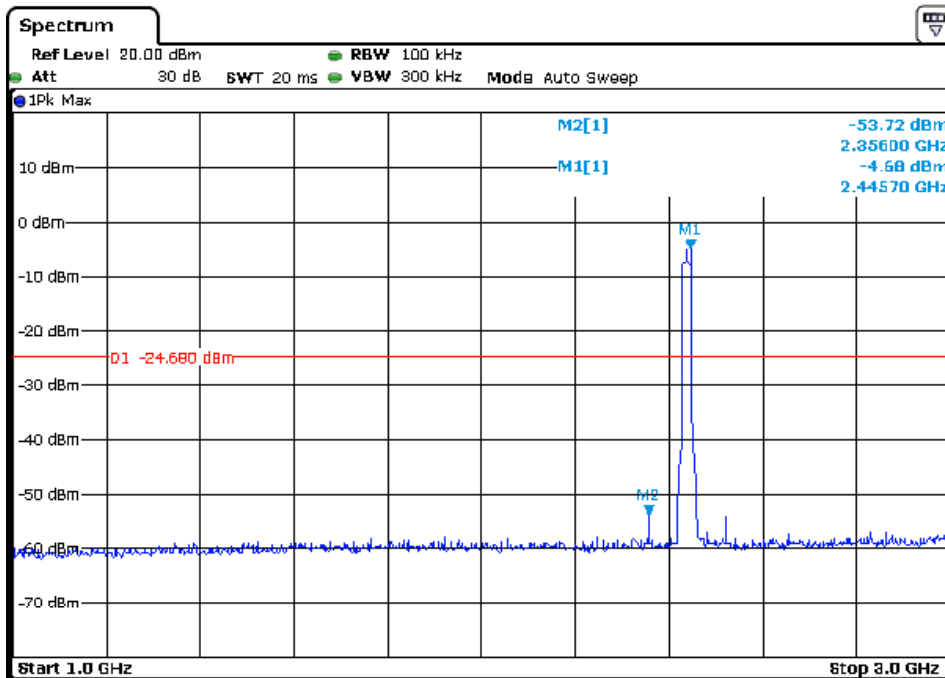

3 G to 13 GHz

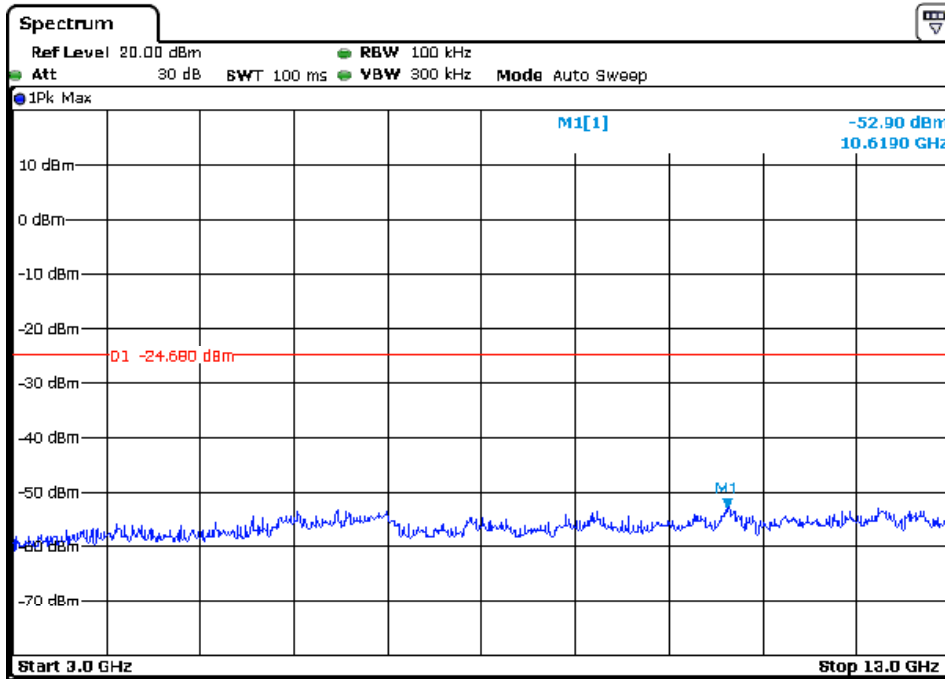

13 G to 25 GHz

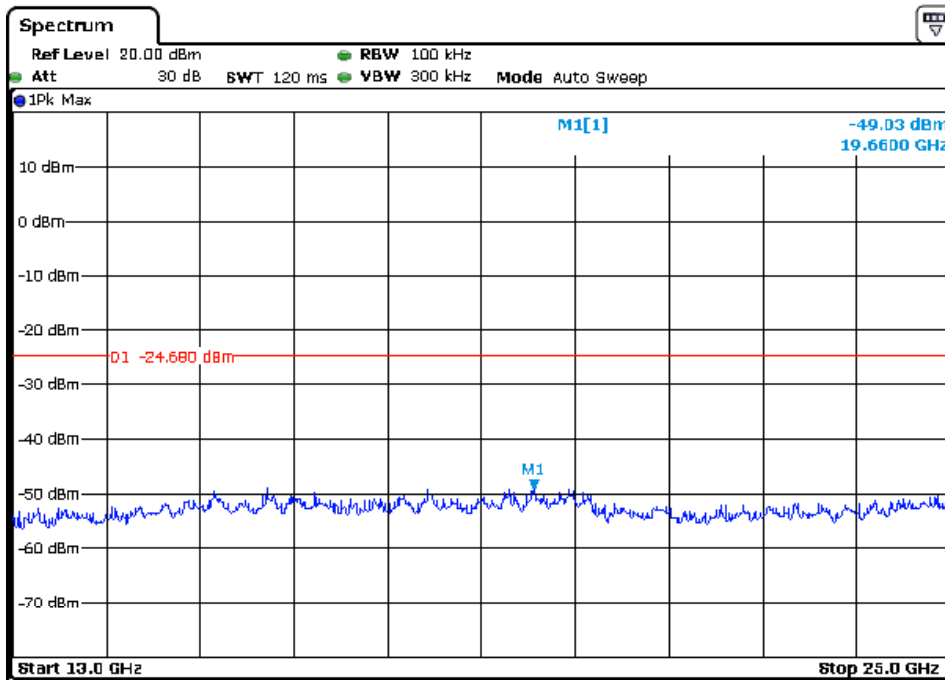

Channel 11:2.462 GHz

30 MHz to 1 GHz

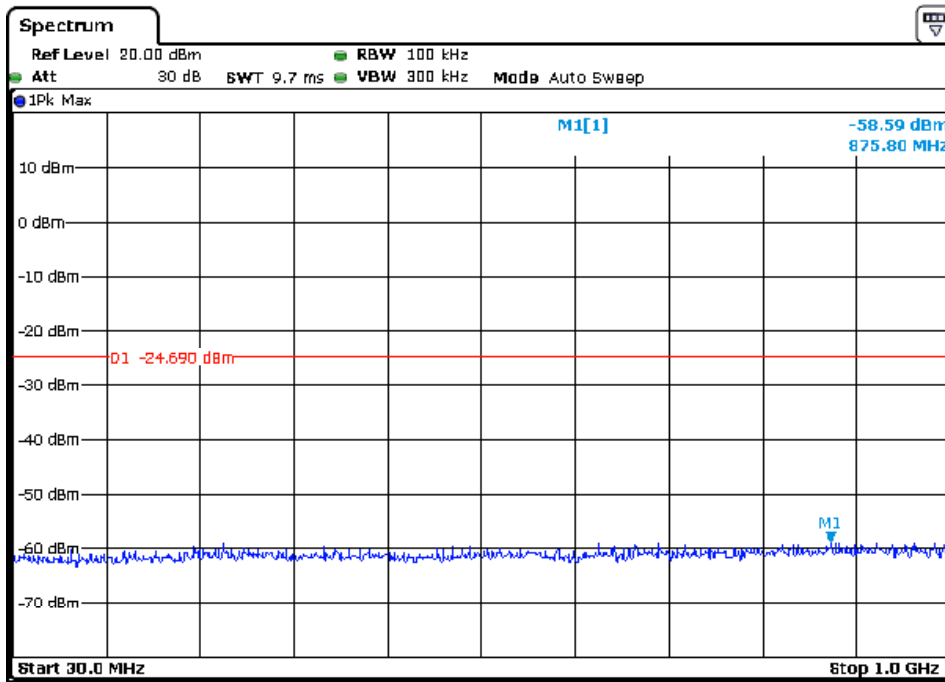

1 G to 3 GHz

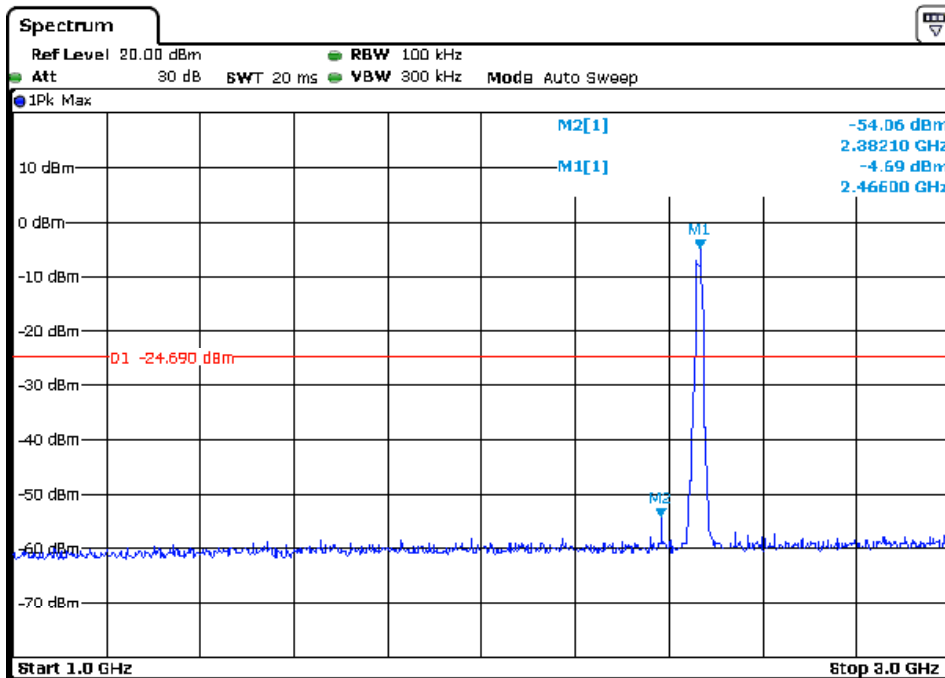

3 G to 13 GHz

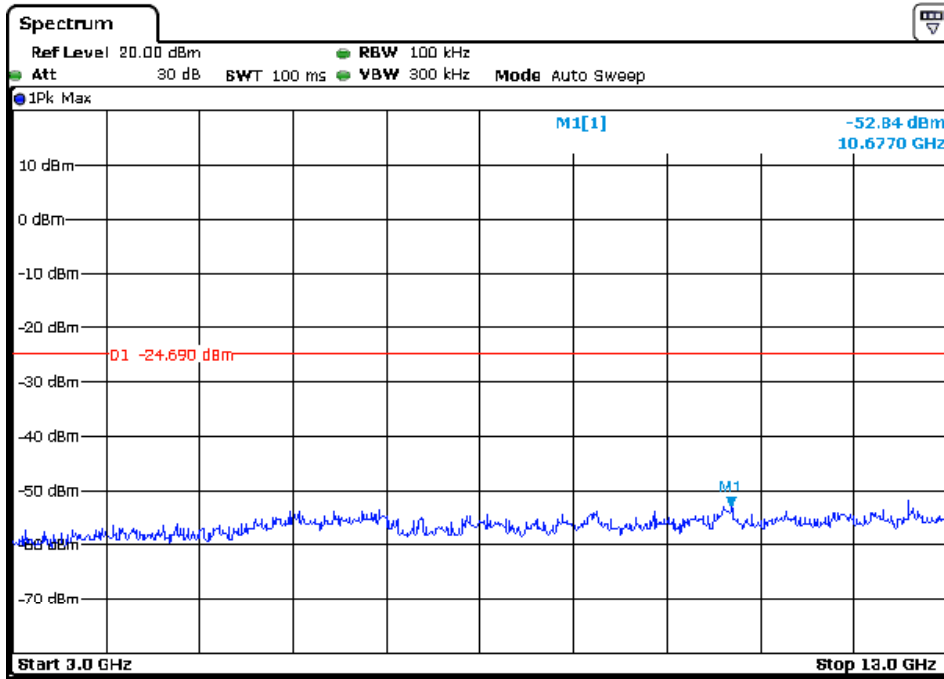

13 G to 25 GHz

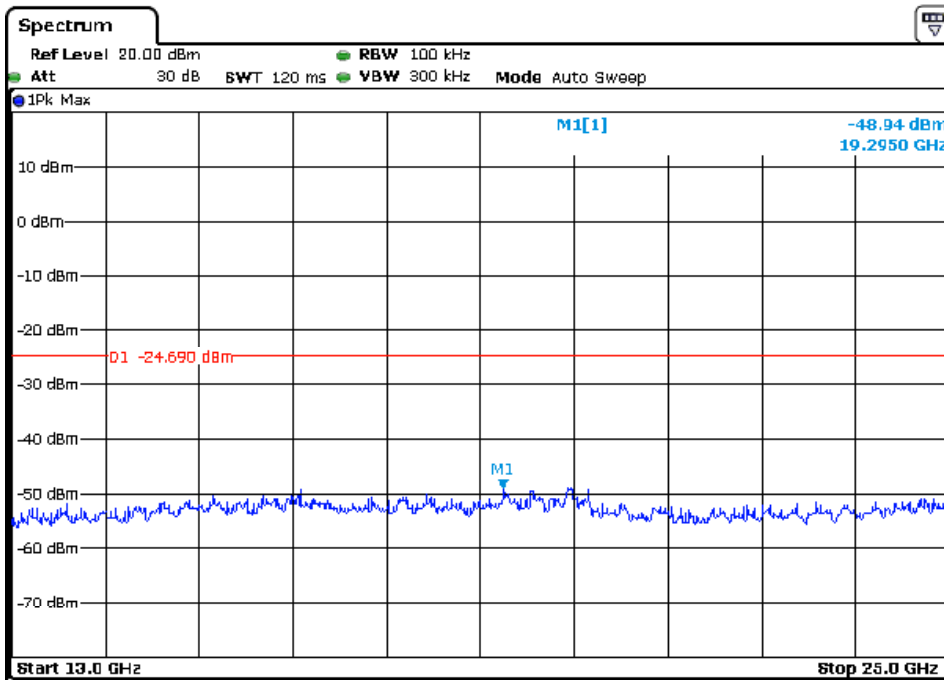

802.11n(HT20) mode with 72.2Mbps data rate

Channel 1: 2.412GHz:

30 MHz to 1 GHz

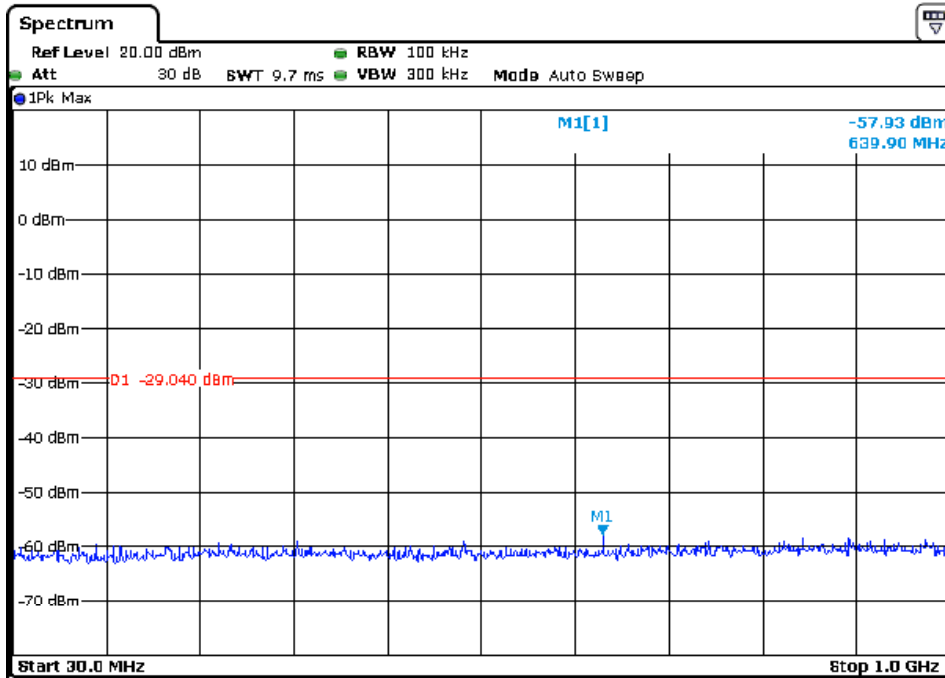

1 G to 3 GHz

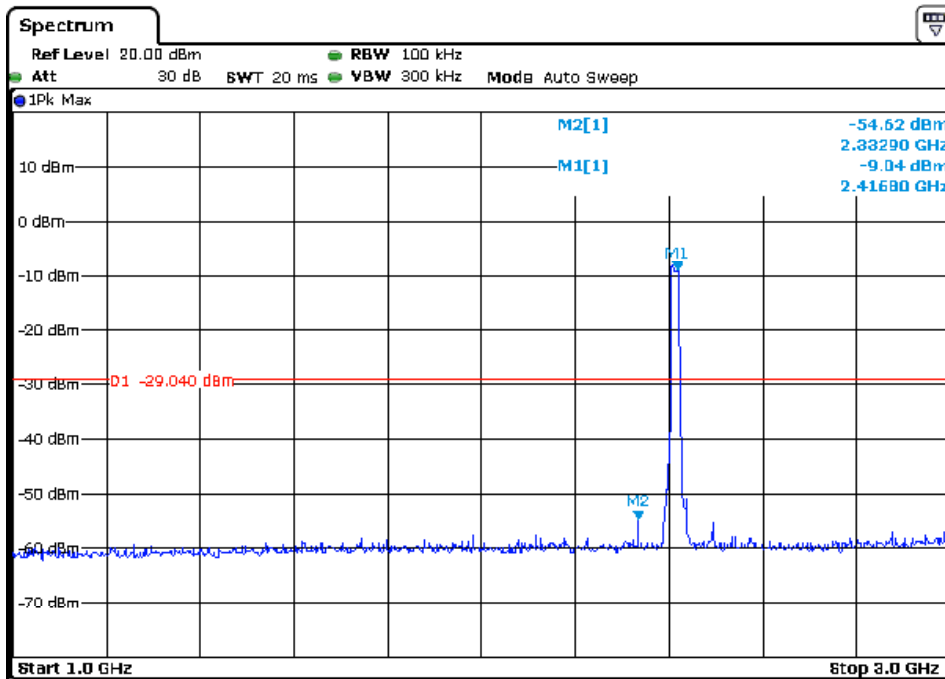

3 G to 13 GHz

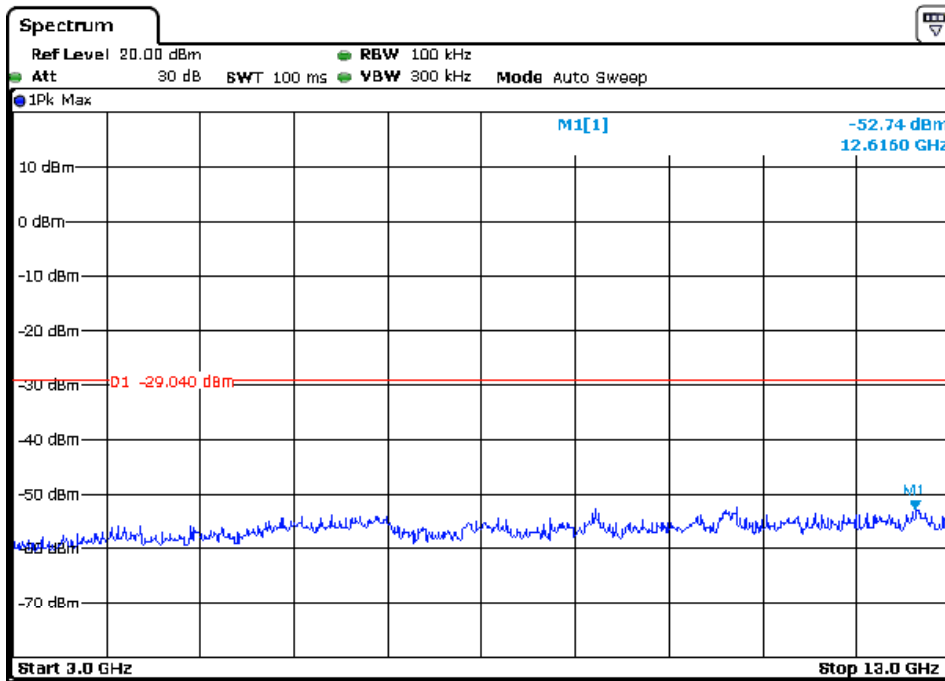

13 G to 25 GHz

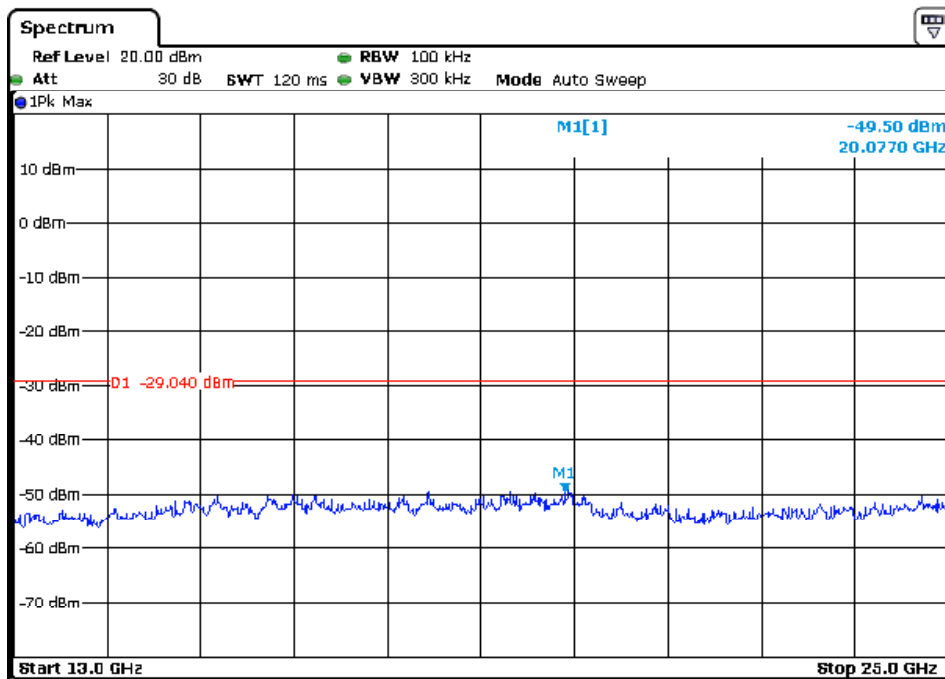

Channel 6: 2.437GHz:

30 MHz to 1 GHz

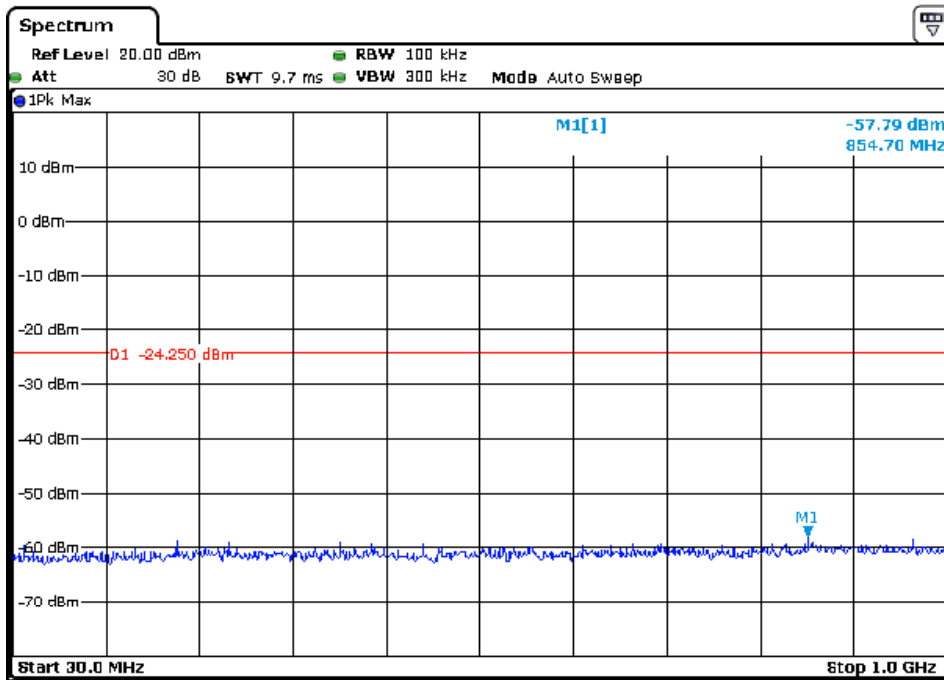

1 G to 3 GHz

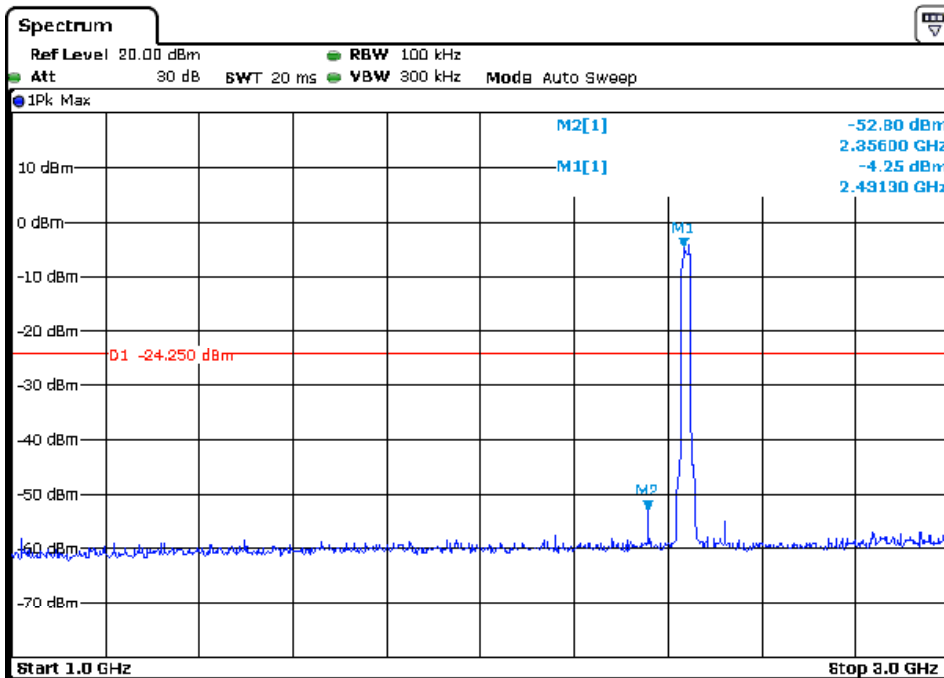

3 G to 13 GHz

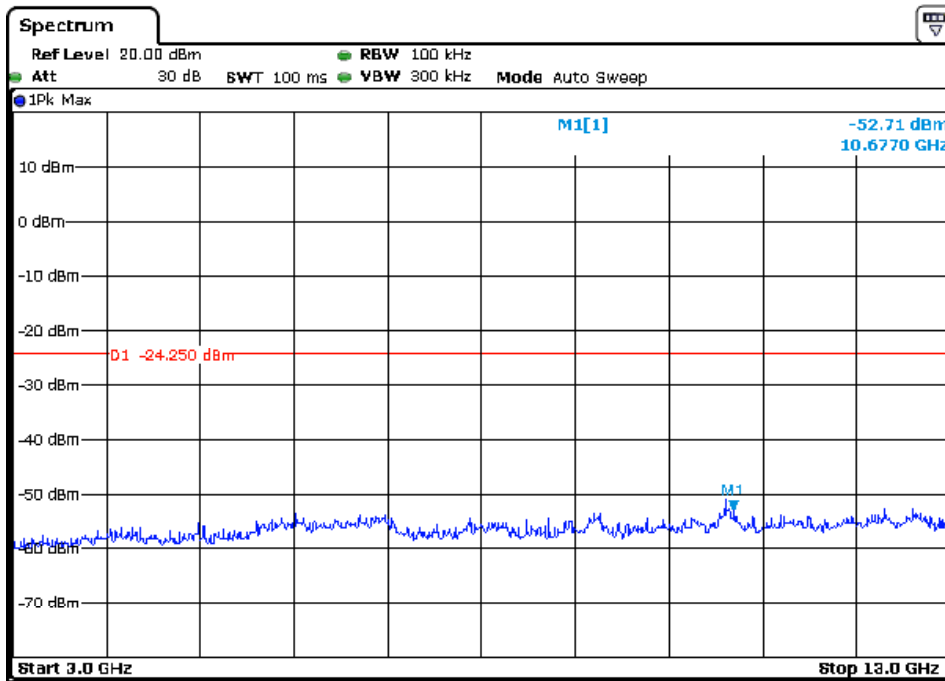

13 G to 25 GHz

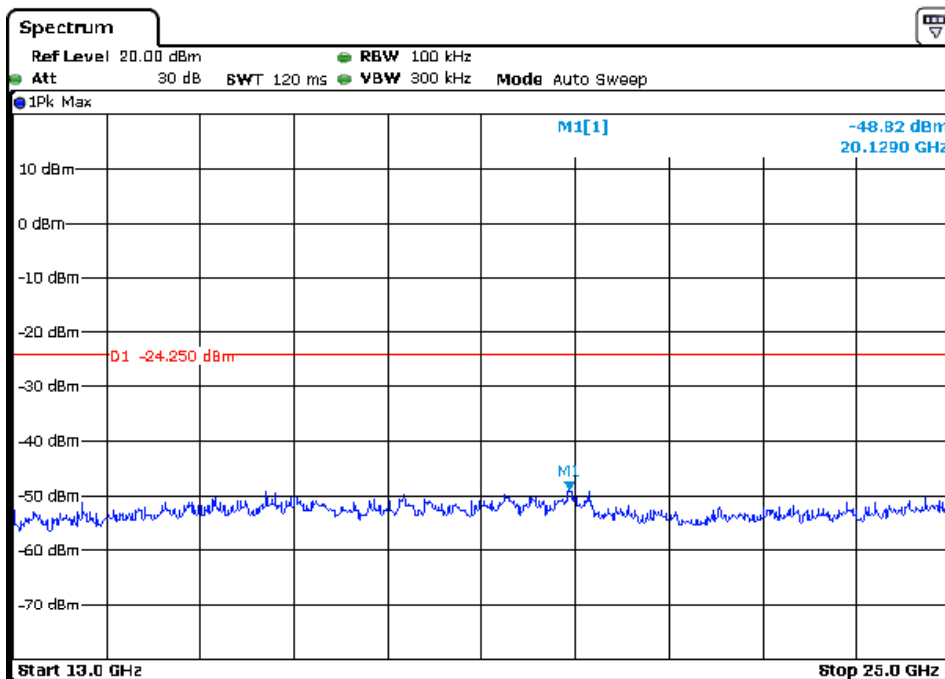

Channel 11:2.462 GHz

30 MHz to 1 GHz

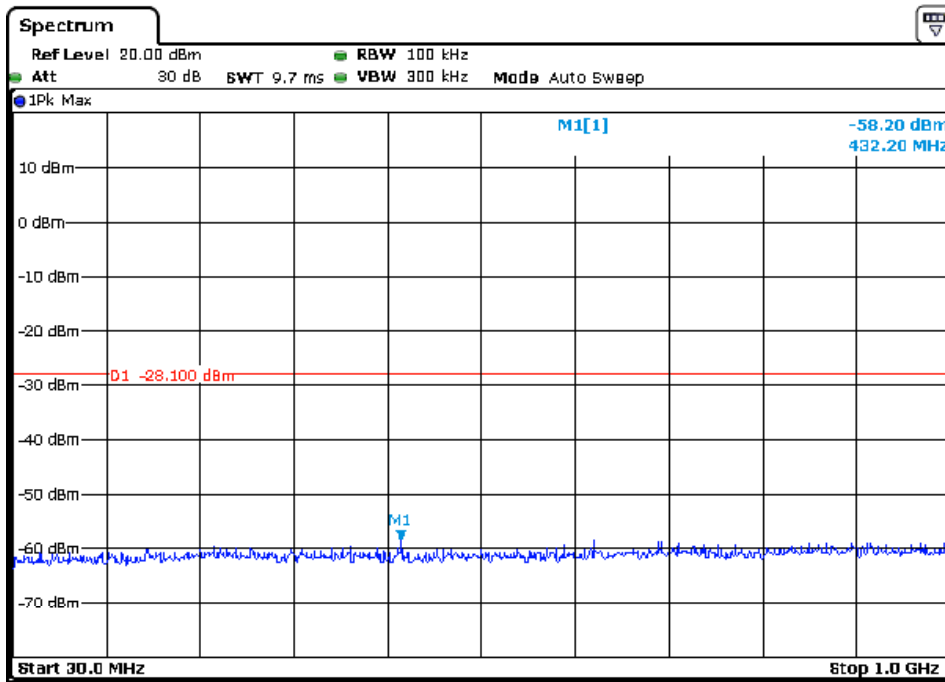

1 G to 3 GHz

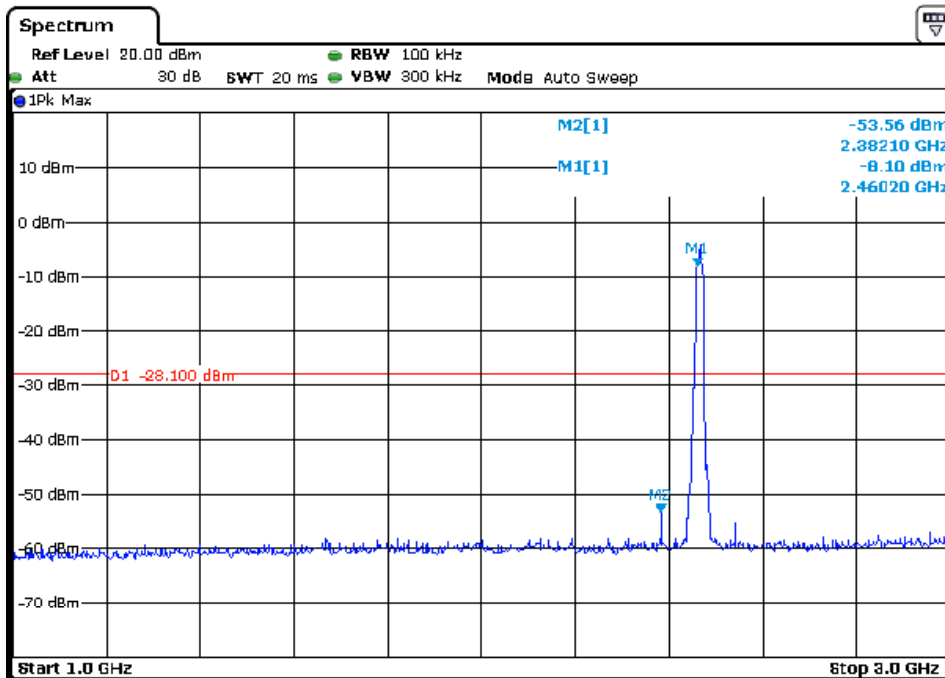

3 G to 13 GHz

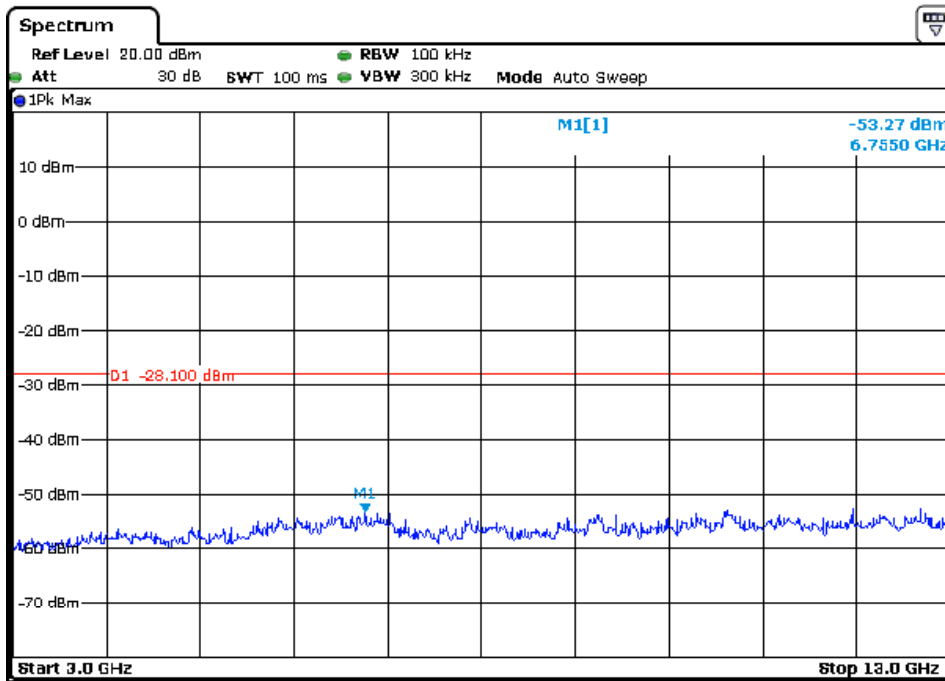

13 G to 25 GHz

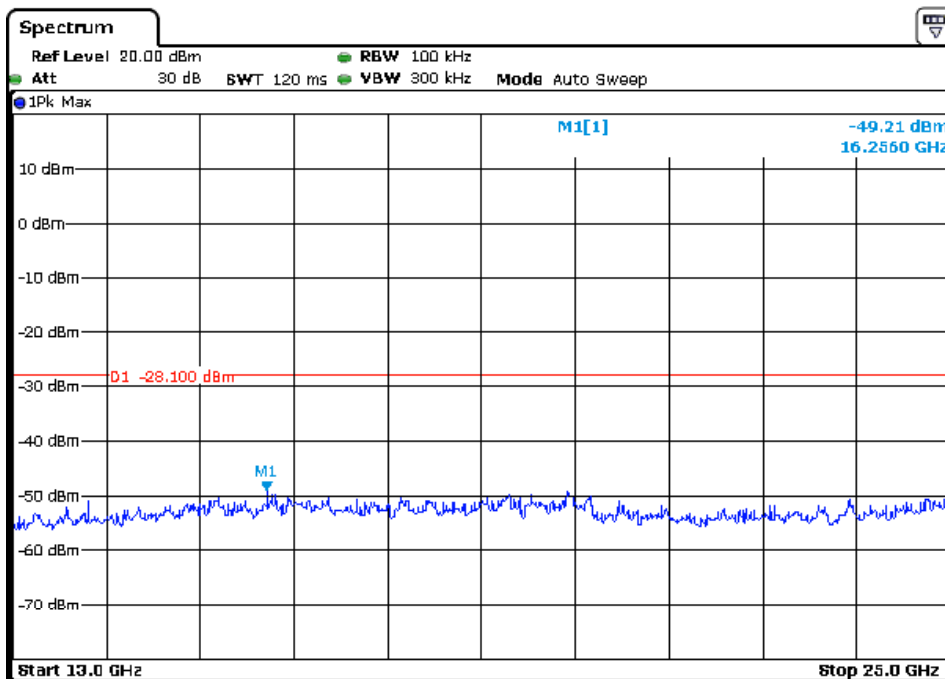

8 Photographs

8.1 Radiated Spurious Emission Test Setup

Below 1GHz:



Above 1GHz:



8.2 Conducted Emission Test Setup



9 APPENDIX-Photographs of EUT Constructional Details



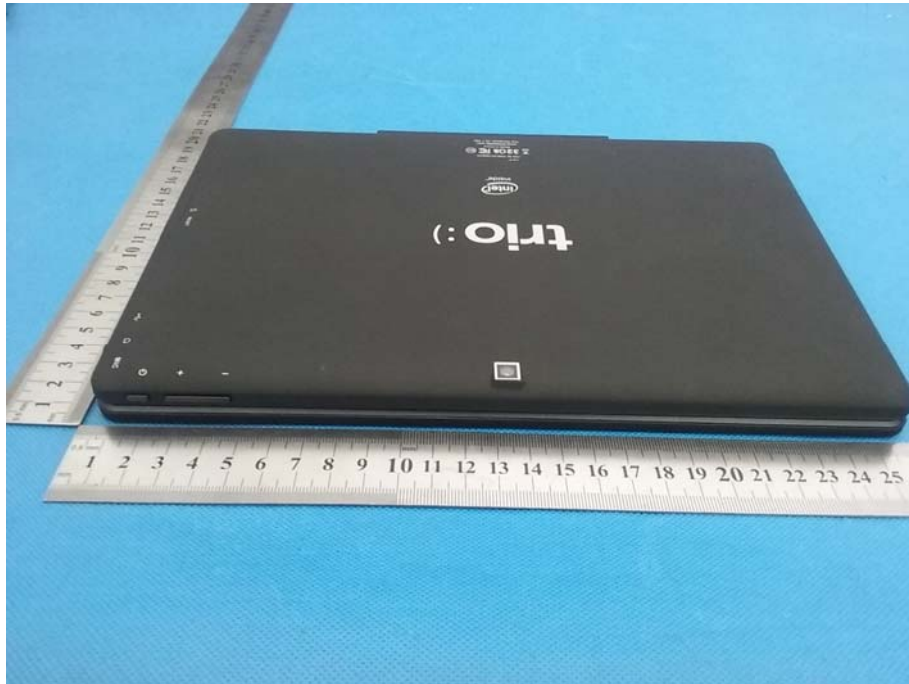





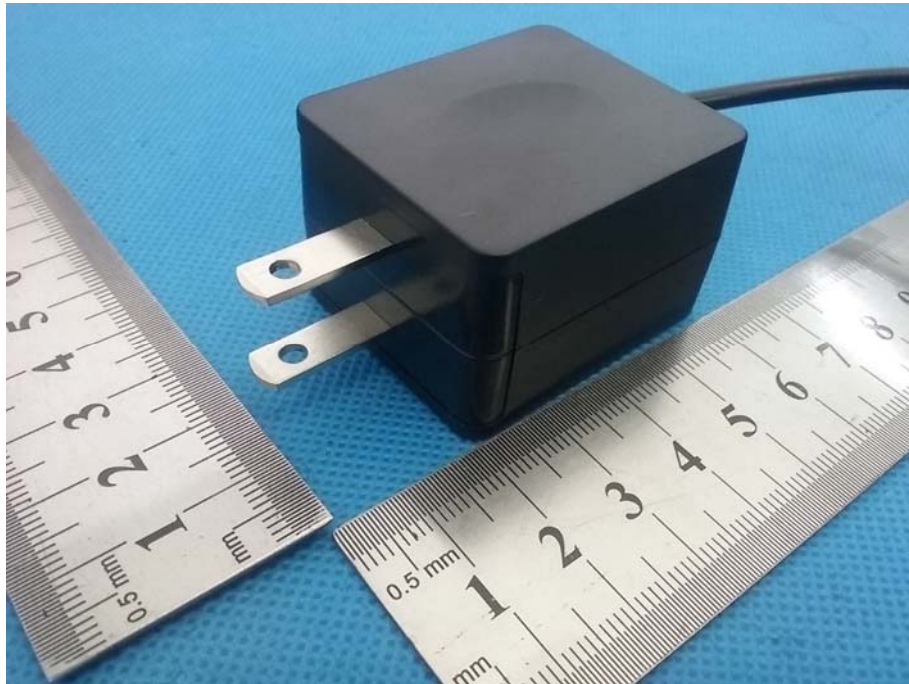

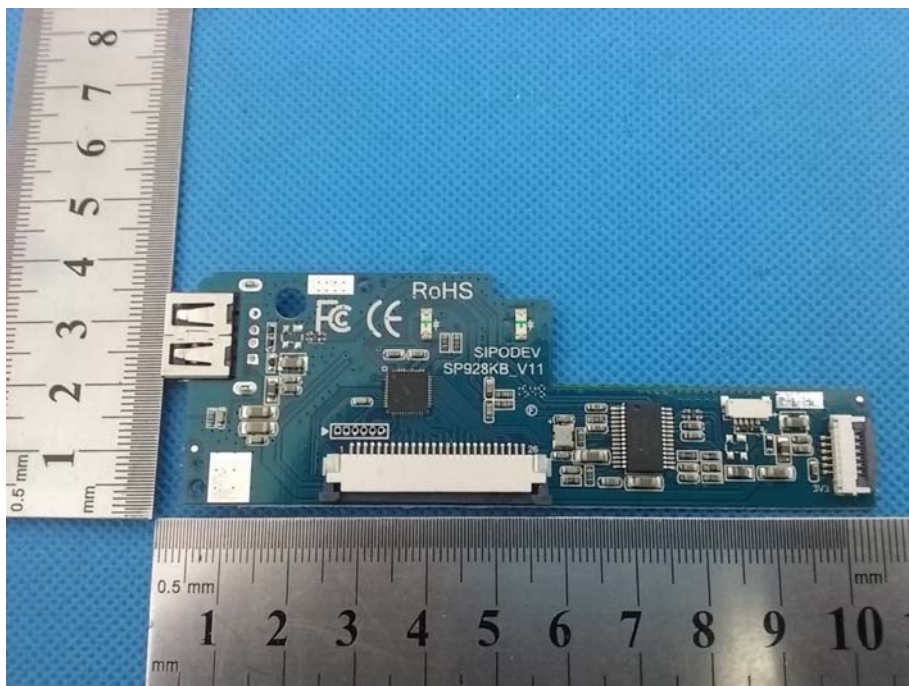

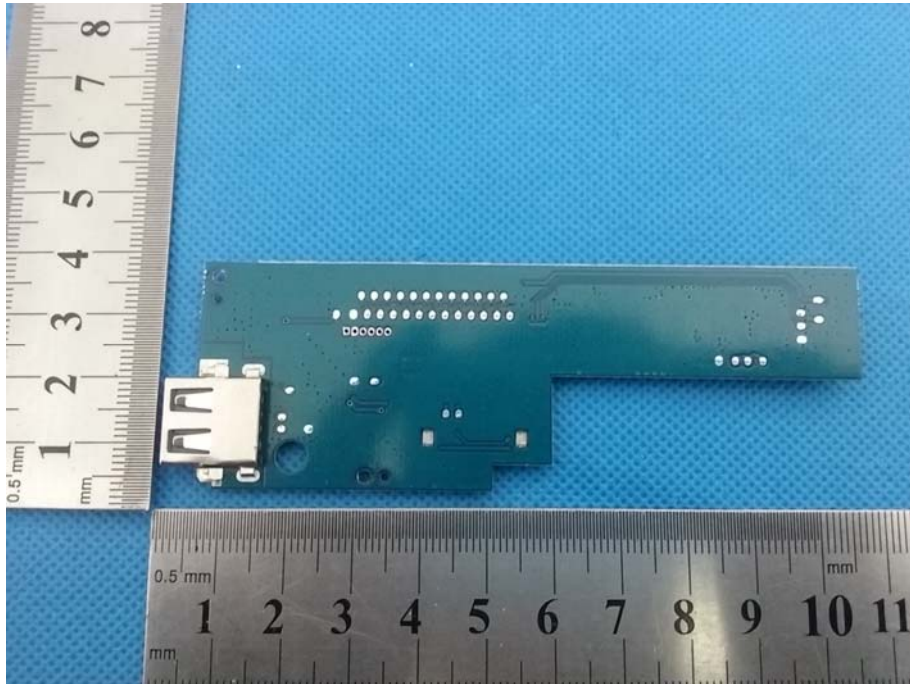



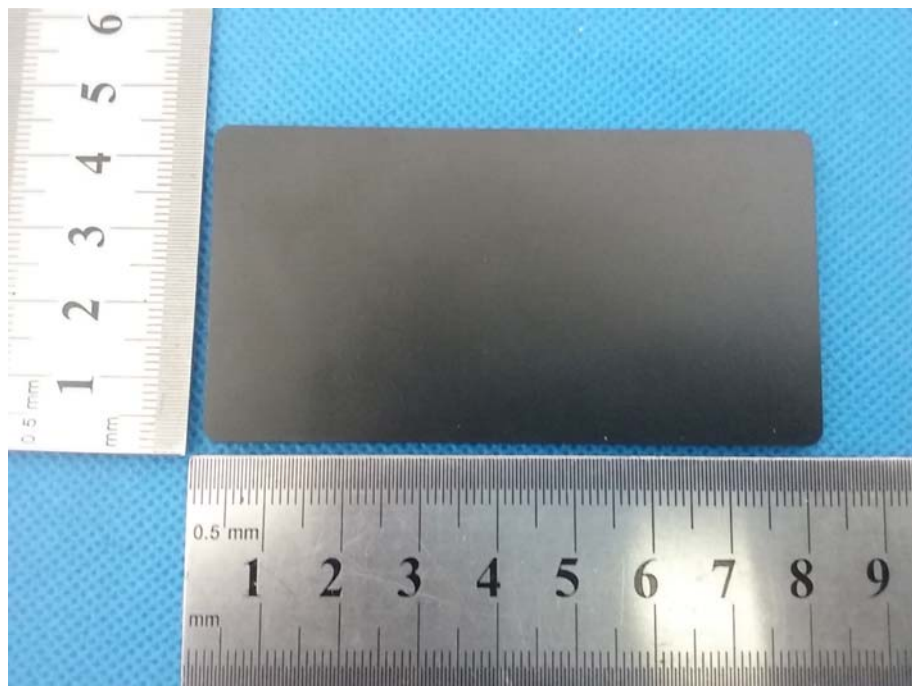
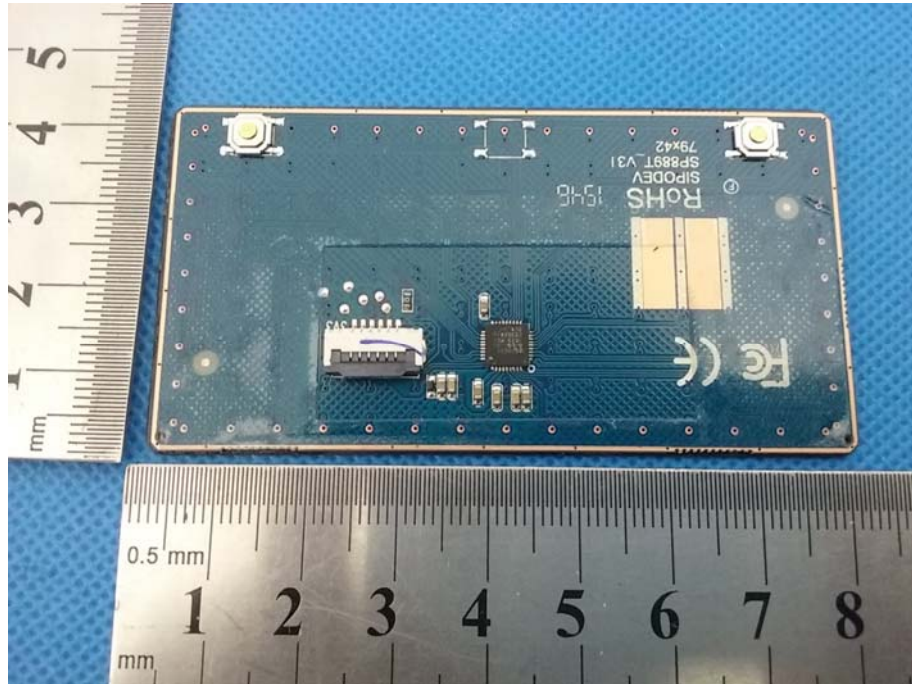

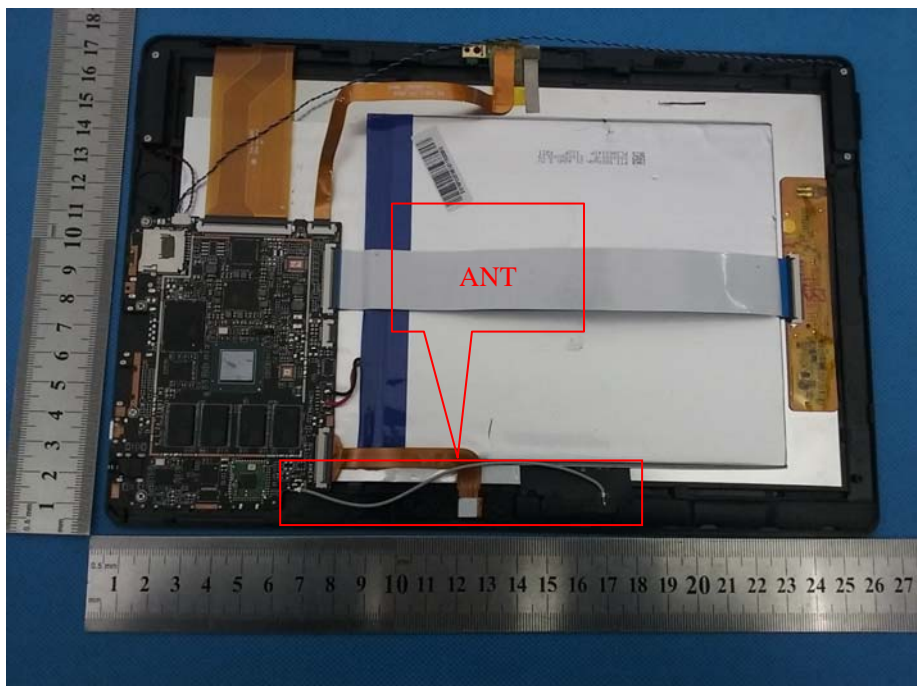
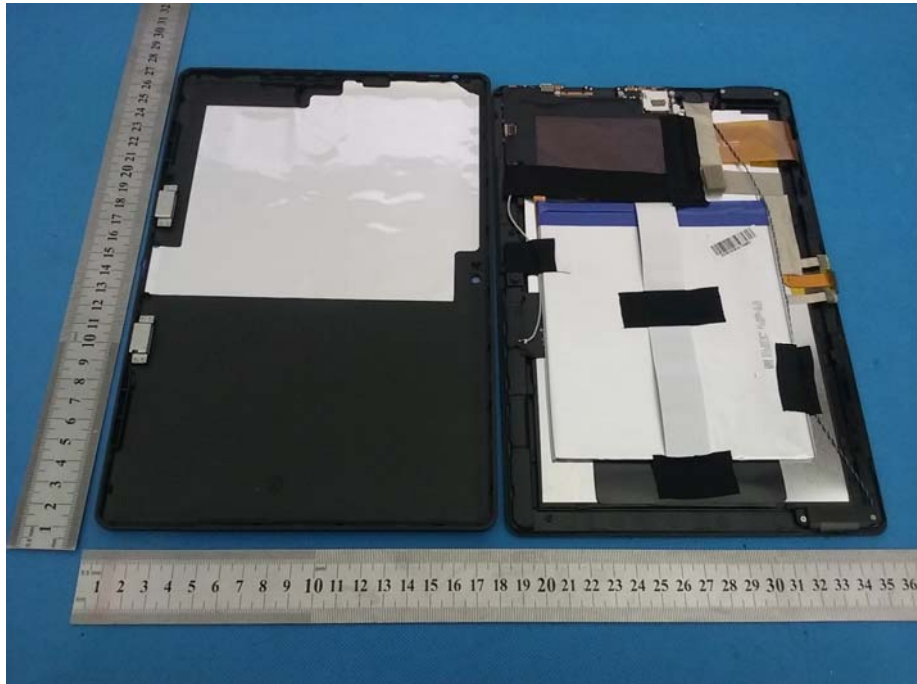



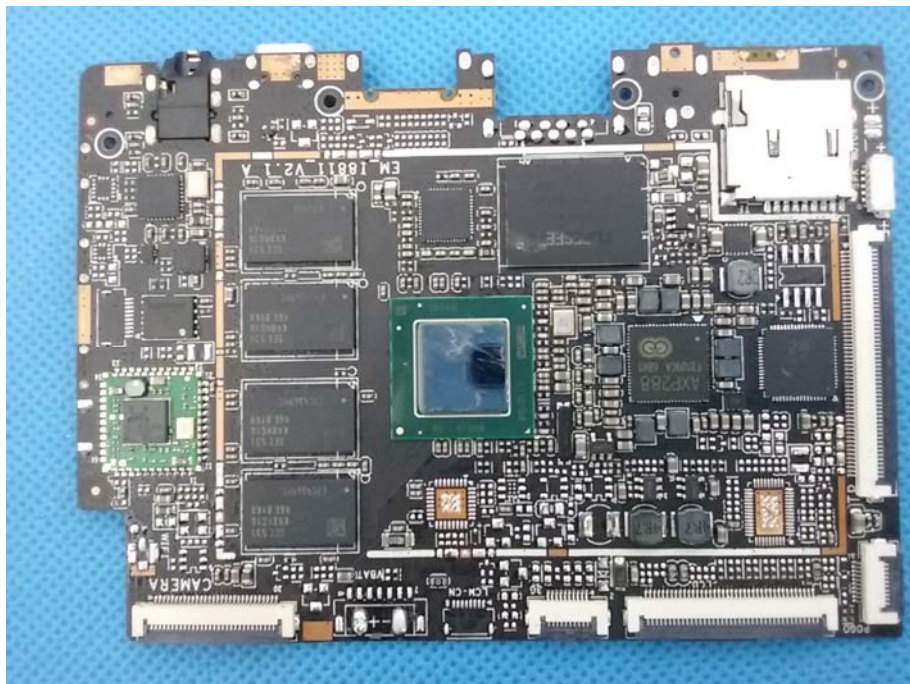
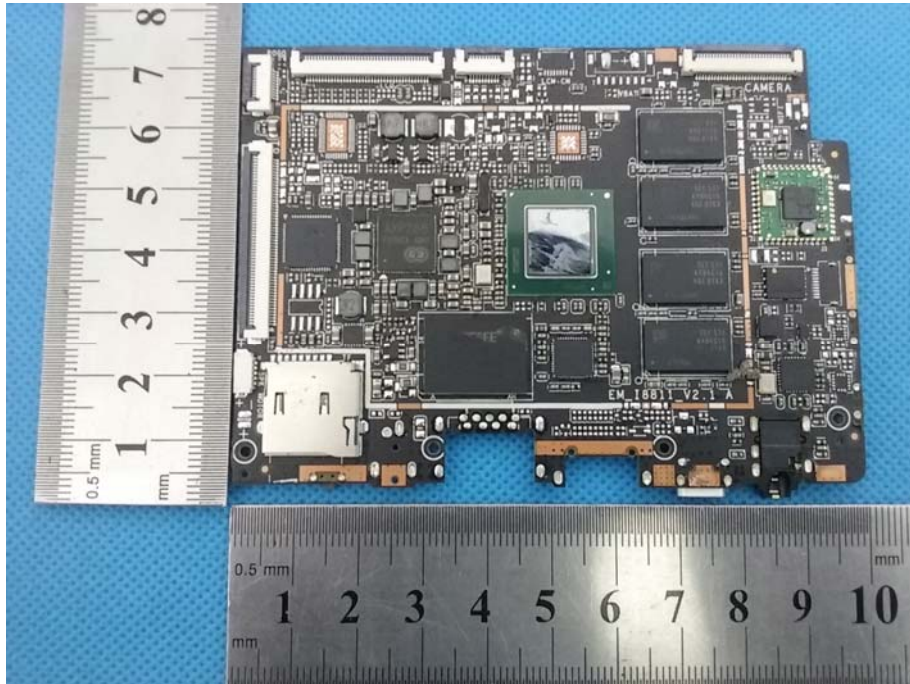

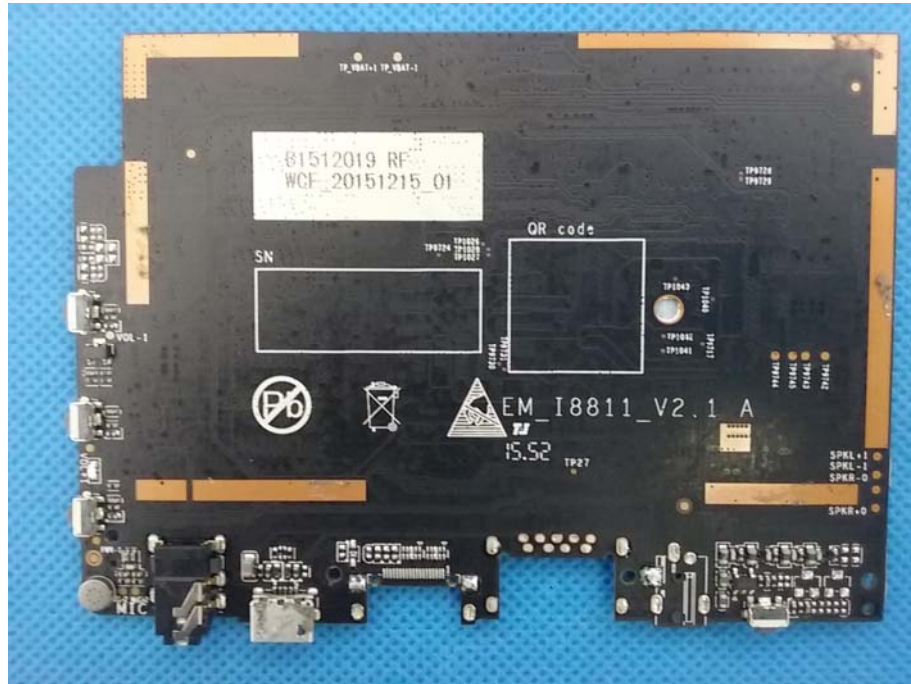

End of report