



Report No.: 170224140GZU-001  
Issued: 2017-07-10

**TEST REPORT**

Applicant Name & Address : Hafele America Co.  
3901 Cheyenne Drive Archdale, NC 27263 United States, America  
Sample Description  
Product : Sound system 420 E  
FCC ID : PW3-HAFELESZOK  
Models No. : 420E/12V/BT034/32W/BlA/2000/02,  
420E/12V/BT034/32W/BlA/2000/03,  
420E/12V/BT034/32W/BlA/2000/04  
Electrical Rating : 12Vdc supplied by adaptor  
Date Received : 24 February 2017  
Date Test Conducted : 24 February 2017 –06 June 2017  
Test standards : 47 CFR PART 15 Subpart C: 2016 section 15.247  
Test Result : Pass

Conclusion : The submitted samples complied with the above rules/standards.

Remark : None.

\*\*\*\*\*End of Page\*\*\*\*\*

**Prepared and Checked By:**

**Approved By:**

*Daniel He*

**Daniel He  
Project Engineer  
Intertek Guangzhou**

*Helen Ma*

**Helen Ma  
Team leader  
Intertek Guangzhou**

**10 July 2017 Date**

This report is for the exclusive use of Intertek's Client and is provided pursuant to the agreement between Intertek and its Client. Intertek's responsibility and liability are limited to the terms and conditions of the agreement. Intertek assumes no liability to any party, other than to the Client in accordance with the agreement, for any loss, expense or damage occasioned by the use of this report. Only the Client is authorized to permit copying or distribution of this report and then only in its entirety. Any use of the Intertek name or one of its marks for the sale or advertisement of the tested material, product or service must first be approved in writing by Intertek. The observations and test results in this report are relevant only to the sample tested. This report by itself does not imply that the material, product, or service is or has ever been under an Intertek certification program. The test report only allows to be revised within three years from its original issued date unless further standard or the requirement was noticed.

Intertek Testing Services Shenzhen Ltd. Guangzhou Branch  
Block E, No.7-2 Guang Dong Software Science Park, Caipin Road, Guangzhou Science City, GETDD Guangzhou, China  
Tel / Fax: 86-20-8213 9688/86-20-3205 7538

## CONTENT

<b>TEST REPORT</b> .....	1
<b>CONTENT</b> .....	2
1.0 Summary of Test.....	3
2.0 General Description .....	4
2.1 Product Description.....	4
2.2 Related Submittal(s) Grants.....	6
2.3 Test Methodology.....	6
2.4 Test Facility.....	6
3.0 System Test Configuration.....	7
3.1 Justification .....	7
3.2 EUT Exercising Software.....	8
3.3 Special Accessories.....	8
3.4 Measurement Uncertainty.....	8
3.5 Equipment Modification.....	8
3.6 Support Equipment List and Description.....	9
4.0 Measurement Results .....	10
4.1 Antenna Requirement .....	10
4.2 20 dB Bandwidth.....	11
4.3 Carrier Frequencies Separated.....	16
4.4 Hopping Channel Number.....	20
4.5 Dwell Time.....	22
4.6 Pseudo random Frequency Hopping Sequence.....	33
4.7 Maximum Peak Conducted Output Power.....	34
4.5 Out of Band Conducted Emissions.....	39
4.6 Out of Band Radiated Emissions.....	43
4.7 Radiated Emissions in Restricted Bands.....	44
4.8 Band Edges Requirement .....	61
4.9 Conducted Emission Test .....	65
5.0 Test Equipment List.....	68

## 1.0 Summary of Test

TEST	TEST REQUIREMENT	TEST METHOD	RESULT
Antenna Requirement	FCC PART 15 C Clause 15.247 (c) and Clause 15.203	FCC PART 15 C Clause 15.247 (c) and Clause 15.203	PASS
20 dB Bandwidth	FCC PART 15 C Clause 15.247 (a)(1)	ANSI C63.10: Clause 7.8.7 & 6.9.2	PASS
Carrier Frequencies Separated	FCC PART 15 C Clause 15.247(a)(1)	ANSI C63.10: Clause 7.8.2	PASS
Hopping Channel Number	FCC PART 15 C Clause 15.247(a)(1)(iii)	ANSI C63.10: Clause 7.8.3	PASS
Dwell Time	FCC PART 15 C Clause 15.247(a)(1)(iii)	ANSI C63.10: Clause 7.8.4	PASS
Pseudorandom Frequency Hopping Sequence	FCC PART 15 C Clause 15.247(a)(1)	FCC PART 15 C Clause 15.247(a)(1)	PASS
Maximum Peak Conducted Output Power	FCC PART 15 C Clause 15.247(b)(1)	ANSI C63.10: Clause 7.8.5	PASS
Out of Band Conducted Emissions	FCC PART 15 C Clause 15.247(d)	ANSI C63.10: Clause 7.8.8	PASS
Out of Band Radiated Emission	FCC PART 15 C Clause 15.247(d)	ANSI C63.10: Clause 6.4, 6.5 and 6.6	N/A
Radiated Emissions in Restricted Bands	FCC PART 15 C Clause 15.209 &15.247(d)	ANSI C63.10: Clause 6.4, 6.5 and 6.6	PASS
Band Edges Measurement	FCC PART 15 C Clause 15.247 (d) &15.205	ANSI C63.10: Clause 7.8.6 & 6.10	PASS
Conducted Emissions at Mains Terminals	FCC PART 15 C Clause 15.207	ANSI C63.10: Clause 6.2	PASS

**Remark:**

N/A: not applicable. Refer to the relative section for the details.  
 EUT: In this whole report EUT means Equipment Under Test.  
 Tx: In this whole report Tx (or tx) means Transmitter.  
 Rx: In this whole report Rx (or rx) means Receiver.  
 RF: In this whole report RF means Radio Frequency.  
 ANSI C63.10: the detail version is ANSI C63.10:2013 in the whole report.

About model 420/12V/BT000/32W/Bla/000/02, 420/12V/BT000/32W/Bla/000/03, 420/12V/BT000/32W/Bla/000/04 have the similar electrical and mechanical construction, the main differences among them are power and speaker quantity, suffix 02, 03, 04 stand for speaker quantity.

So model 420/12V/BT000/32W/Bla/000/04 was selected for full test.

## 2.0 General Description

### 2.1 Product Description

Operating Frequency	2402 MHz to 2480 MHz
Type of Modulation:	GFSK, ( $\pi/4$ )-DQPSK, 8-DPSK
Number of Channels	79 Channels
Channel Separation:	1 MHz
Dwell time	Per channel is less than 0.4s within 31.6s.(0.4s x 79)
Antenna Type	Integral
Antenna gain:	0 dBi
Speciality:	Bluetooth 3.0 with EDR
Function:	Speaker with BT function to transmit and receive audio signal.
Power Supply:	12Vdc supplied by adaptor

Remark: The device meets the requirements stated within Parts 15.247(g) & (h) in that they were developed under the Bluetooth protocol and operate as a true frequency hopping system. The device does not have the ability to be coordinated with other FHSS systems in an effort to avoid the simultaneous occupancy of individual hopping frequencies by multiple transmitters.

EUT modulation and data packet during test:

For Normal mode:

The EUT has been tested on the Modulation of GFSK with DH1, DH3 and DH5 data packet.

For EDR mode:

1. The EUT been tested on the Modulation of ( $\pi/4$ )-DQPSK with 2DH1, 2DH3 and 2DH5 data packet.
2. The EUT has been tested on the Modulation of 8-DPSK with 3DH1, 3DH3 and 3DH5 data packet.

EUT channels and frequencies list:

Test frequencies are lowest channel 0: 2402 MHz, middle channel 39: 2441 MHz and highest channel 78: 2480 MHz.

Channel	Frequency (MHz)	Channel	Frequency (MHz)	Channel	Frequency (MHz)
0	2402	27	2429	54	2456
1	2403	28	2430	55	2457
2	2404	29	2431	56	2458
3	2405	30	2432	57	2459
4	2406	31	2433	58	2460
5	2407	32	2434	59	2461
6	2408	33	2435	60	2462
7	2409	34	2436	61	2463
8	2410	35	2437	62	2464
9	2411	36	2438	63	2465
10	2412	37	2439	64	2466
11	2413	38	2440	65	2467
12	2414	39	2441	66	2468
13	2415	40	2442	67	2469
14	2416	41	2443	68	2470
15	2417	42	2444	69	2471
16	2418	43	2445	70	2472
17	2419	44	2446	71	2473
18	2420	45	2447	72	2474
19	2421	46	2448	73	2475
20	2422	47	2449	74	2476
21	2423	48	2450	75	2477
22	2424	49	2451	76	2478
23	2425	50	2452	77	2479
24	2426	51	2453	78	2480
25	2427	52	2454	/	/
26	2428	53	2455	/	/

## **2.2 Related Submittal(s) Grants**

This is an application for certification of:  
DSS- Part 15 Spread Spectrum Transmitter (BT transmitter portion)

Remaining portions are subject to the following procedures:  
Receiver portion of BT: exempt from technical requirement of this Part.

## **2.3 Test Methodology**

Both AC mains line-conducted and radiated emission measurements were performed according to the procedures in ANSI C63.10:2013. Radiated emission measurement was performed in semi-anechoic chamber and conducted emission measurement was performed in shield room. For radiated emission measurement, preliminary scans and final tests were performed in the semi-anechoic chamber to determine the worst case modes. All radiated tests were performed at an antenna to EUT distance of 3 meters, unless stated otherwise.

## **2.4 Test Facility**

All of the tests are performed at:  
Intertek Testing Services Shenzhen Ltd. Guangzhou Branch.  
Located at Block E, No.7-2 Guang Dong Software Science Park, Caipin Road, Guangzhou Science City, GETDD Guangzhou, 510663, China. This test facility and site measurement data have been fully placed on file with the FCC, test firm registration number is 549654.

### 3.0 System Test Configuration

#### 3.1 Justification

For emissions testing, the equipment under test (EUT) setup to transmit continuously to simplify the measurement methodology. Care was taken to ensure proper power supply voltages during testing. During testing, AC power line was manipulated to produce worst case emissions. It was powered by AC 120V/60Hz supply.

The signal is maximized through rotation and placement in the three orthogonal axes. The antenna height and polarization are varied during the search for maximum signal level. The antenna height is varied from 1 to 4 meters. Radiated emissions are taken at three meters unless the signal level is too low for measurement at that distance. If necessary, a pre-amplifier is used and/or the test is conducted at a closer distance.

All readings are extrapolated back to the equivalent three meter reading using inverse scaling with distance. The spurious emissions more than 20 dB below the permissible value are not reported.

For an intentional radiator, the spectrum shall be investigated from the lowest radio frequency signal generated in the device, without going below 9 kHz, up to at least the frequency shown in the following table:

Frequency range of radiated emission measurements

Lowest frequency generated in the device	Upper frequency range of measurement
9 kHz to below 10 GHz	10th harmonic of highest fundamental frequency or to 40 GHz, whichever is lower
At or above 10 GHz to below 30 GHz	5th harmonic of highest fundamental frequency or to 100 GHz, whichever is lower
At or above 30 GHz	5th harmonic of highest fundamental frequency or to 200 GHz, whichever is lower, unless otherwise specified

Number of fundamental frequencies to be tested in EUT transmit band

Frequency range in which device operates	Number of frequencies	Location in frequency range of operation
1 MHz or less	1	Middle
1 MHz to 10 MHz	2	1 near top and 1 near bottom
More than 10 MHz	3	1 near top, 1 near middle and 1 near bottom

### 3.2 EUT Exercising Software

The test was performed under “CSR BlueSuite V2.6.2” which was provided by manufacture.

### 3.3 Special Accessories

No special accessories used.

### 3.4 Measurement Uncertainty

No.	Item	Measurement Uncertainty
1	RF output power (conducted)	1.1 dB
2	Occupied Channel Bandwidth	2.3%
3	Power Spectral Density	1.5dB
4	Spurious Emission (TX)-Radiated	4.7 dB (25 MHz-1 GHz)
		4.8 dB (1 GHz-18 GHz)
5	Spurious Emission (TX)-Conducted	1.5 dB
6	Spurious Emission (RX) -Radiated	4.7 dB (25 MHz-1 GHz)
		4.8 dB (1 GHz-25 GHz)
7	Spurious Emission (RX)-Conducted	1.5 dB
8	Conducted Emissions at Mains Terminals	2.58dB
9	Temperature	0.5 °C
10	Humidity	0.4 %
11	Time	1.2%

When determining of the test conclusion, the Measurement Uncertainty of test has been considered.

Uncertainty and Compliance – Unless the standard specifically states that measured values are to be extended by the measurement uncertainty in determining compliance, all compliance determinations are based on the actual measured value.

### 3.5 Equipment Modification

Any modifications installed previous to testing by Hafele America Co. will be incorporated in each production model sold / leased in the United States.

No modifications were installed by Intertek Testing Services Shenzhen Ltd. Guangzhou Branch.





### 3.6 Support Equipment List and Description

This product was tested with corresponding accessories as below:

Description	Manufacturer	Model No.	SN/Certificate NO
NoteBook	Lenovo	T430	CCHNGZHL0009
CSR USB-SPI (Fix board)	--	--	--
Adaptor	--	--	--

Remark:

1. The adaptor is not a part of system and won't be sold together, which supplied by Client.
2. After the frequency was fixed, all support equipments were removed out of the Chamber before test.

#### 4.0 Measurement Results

##### 4.1 Antenna Requirement

Standard requirement

15.203 requirement:

For intentional device. According to 15.203, an intentional radiator shall be designed to ensure that no antenna other than that furnished by the responsible party shall be used with the device.

15.247(c) (1)(i) requirement:

(i) Systems operating in the 2400-2483.5 MHz bands that are used exclusively for fixed. Point-to-point operations may employ transmitting antennas with directional gain greater than 6 dBi provided the maximum conducted output power of the intentional radiator is reduced by 1 dB for every 3 dB that the directional gain of the antenna exceeds 6 dBi.

EUT Antenna

The antenna is an integral antenna and no consideration of replacement. The best case gain of the antenna is 0 dBi.

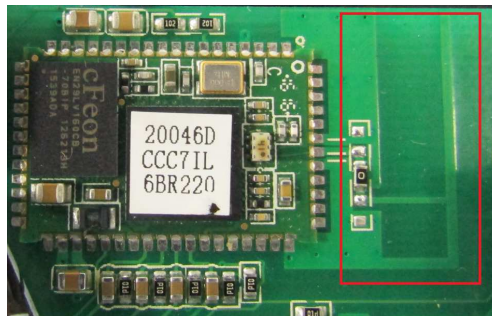

#### 4.2 20 dB Bandwidth

**Test Requirement:** FCC Part 15 C section 15.247  
 (a)(1) Frequency hopping systems shall have hopping channel carrier frequencies separated by a minimum of 25 kHz or the 20 dB bandwidth of the hopping channel, whichever is greater. Alternatively, frequency hopping systems operating in the 2400-2483.5 MHz band may have hopping channel carrier frequencies that are separated by 25 kHz or two-thirds of the 20 dB bandwidth of the hopping channel, whichever is greater, provided the systems operate with an output power no greater than 125 mW.

**Test Method:** ANSI C63.10: Clause 7.8.7 & 6.9.2

**Test Status:** Pre-test the EUT in continuous transmitting mode at the lowest (2402 MHz), middle (2441 MHz) and highest (2480 MHz) channels with different data package. Compliance test in normal mode (DH5) and EDR mode (3DH5) as the worst case was found.

**Test Configuration:**

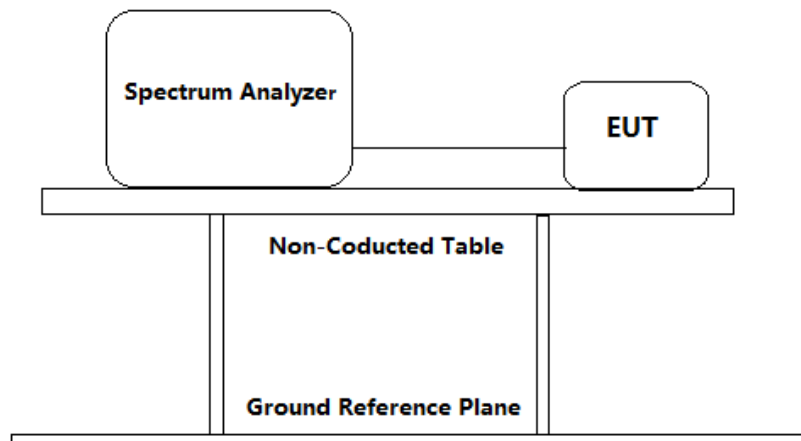

**Test Procedure:**  
 Removed the antenna from the EUT and then connect a low RF cable from the antenna port to the spectrum. The transmitter was operated at its maximum carrier power measured under normal test conditions.

1. The instrument center frequency was set to the nominal EUT channel center frequency. The frequency span for the spectrum analyzer was between two times and five times the OBW(20 dB Bandwidth).
2. The nominal IF filter bandwidth (3 dB RBW) was in the range of 1% to 5% of the OBW, and VBW was approximately three times the RBW.

3. Set the reference level of the instrument as required, keeping the signal from exceeding the maximum input mixer level for linear operation. In general, the peak of the spectral envelope was more than  $[10 \log (OBW/RBW)]$  below the reference level.
4. Step 1) through step 3) might require iteration to adjust within the specified range.
5. The dynamic range of the instrument at the selected RBW was more than 10 dB below the target “-20 dB down” requirement; that is, if the requirement calls for measuring the -20 dB OBW, the instrument noise floor at the selected RBW was at least 30 dB below the reference value.
6. Peak detection and max hold mode (until the trace stabilizes) was used.
7. Used the 20dB bandwidth function of the instrument and reported the measured bandwidth.
8. The occupied bandwidth was reported by providing plot(s) of the measuring instrument display; the plot axes and the scale units per division was clearly labeled. Tabular data was reported in addition to the plot(s).

**Test result:**

**Normal mode (DH5):**

Test Channel	Bandwidth(MHz)	2/3 bandwidth(MHz)
Lowest	0.6972	0.465
Middle	0.6927	0.462
Highest	0.7058	0.471

**EDR mode (3DH5):**

Test Channel	bandwidth	2/3 bandwidth
Lowest	1.2735	0.849
Middle	1.2808	0.854
Highest	1.2952	0.863

Test result: The unit does meet the FCC requirements.

**Result plot as follows:**

**Normal mode (DH5):**

Lowest Channel(2.402 GHz):

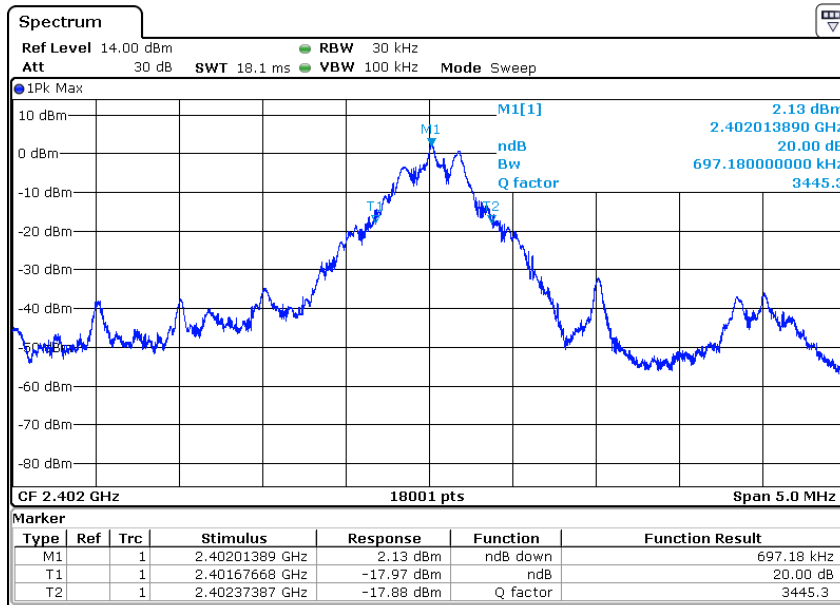

Middle Channel(2.441 GHz):

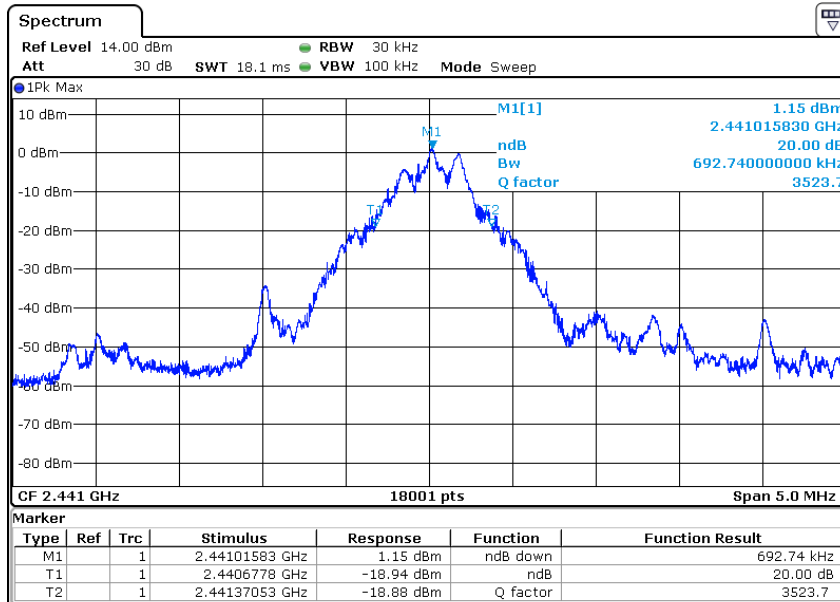

Highest Channel(2.480 GHz):

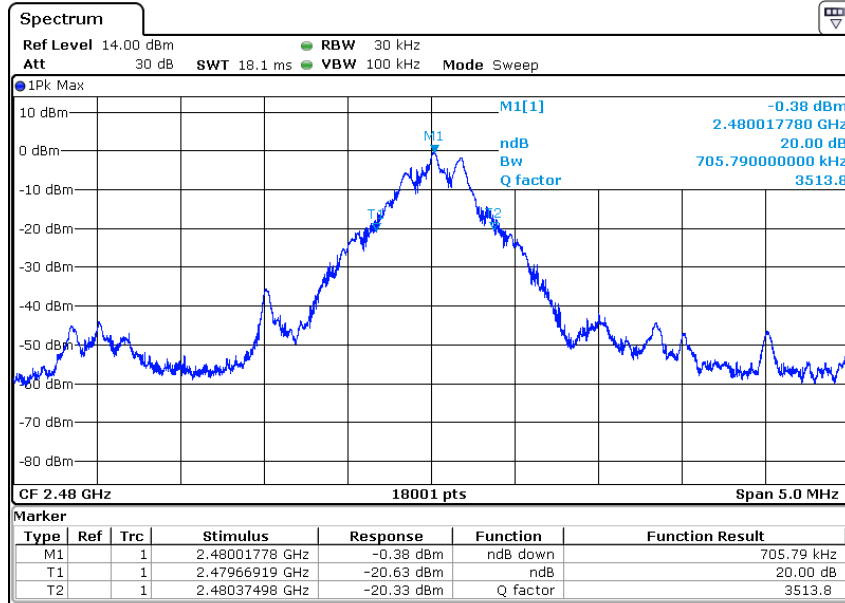

EDR mode (3DH5):

Lowest channel(2.402 GHz):

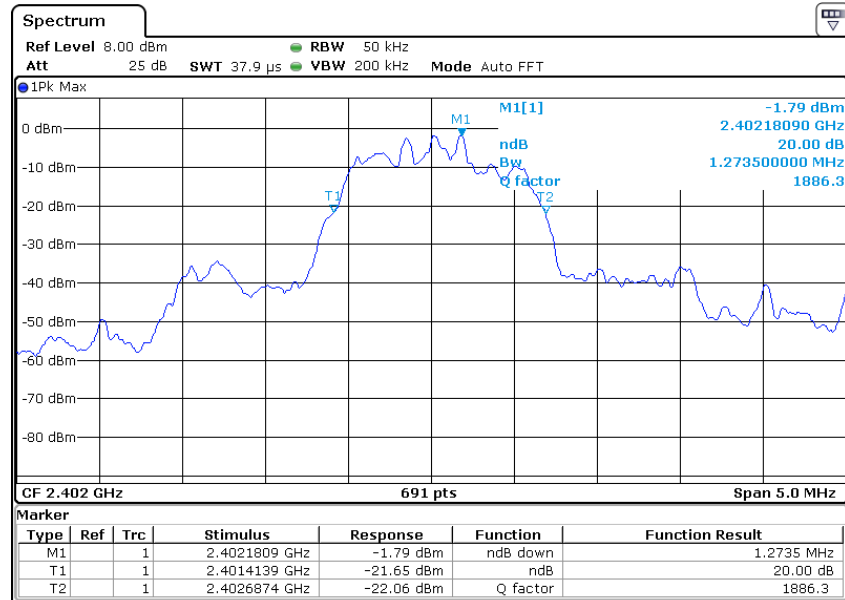

Middle channel(2.441 GHz):

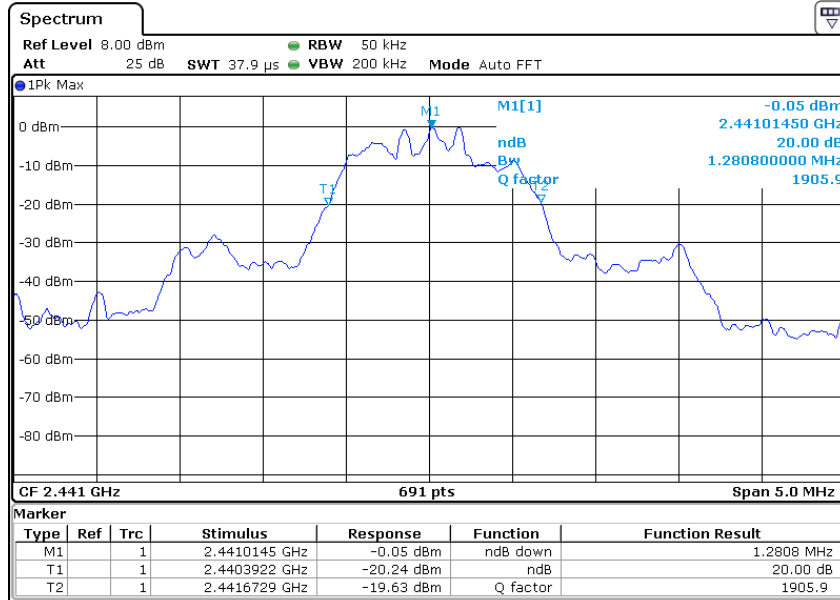

Highest channel(2.480 GHz):

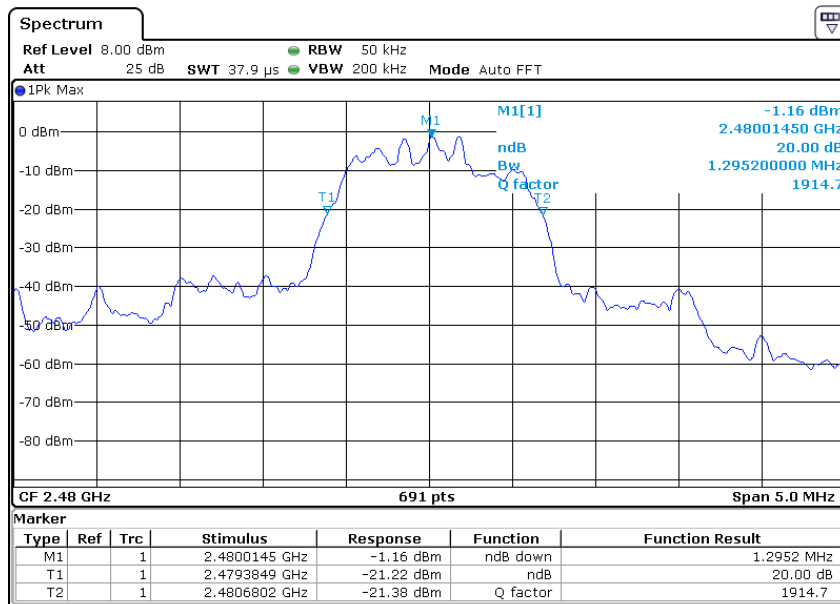

### 4.3 Carrier Frequencies Separated

**Test Requirement:** FCC Part 15 C section 15.247

(a)(1) Frequency hopping systems shall have hopping channel carrier frequencies separated by a minimum of 25 kHz or the 20 dB bandwidth of the hopping channel, whichever is greater. Alternatively, frequency hopping systems operating in the 2400-2483.5 MHz band may have hopping channel carrier frequencies that are separated by 25 kHz or two-thirds of the 20 dB bandwidth of the hopping channel, whichever is greater, provided the systems operate with an output power no greater than 125 mW.

**Test Method:** ANSI C63.10: Clause 7.8.2

**Test Status:** Pre-test the EUT in continuous transmitting mode at the lowest (2402 MHz), middle (2441 MHz) and highest (2480 MHz) channel and hopping mode with different data packet. Compliance test in hopping with Normal mode (DH5) as the worst case was found.

**Test Configuration:**

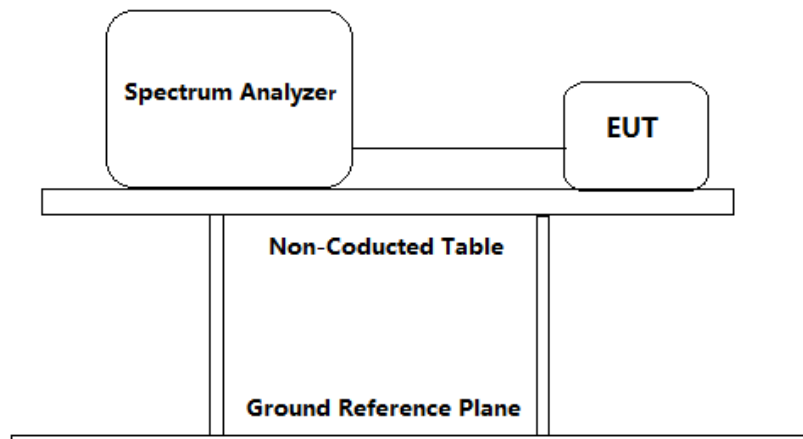

**Test Procedure:**

1. Removed the antenna from the EUT and then connect a low attenuation RF cable from the antenna port to the spectrum.
2. Span: Wide enough to capture the peaks of two adjacent channels.
3. Set the spectrum analyzer: RBW  $\geq$  1% of the span, VBW  $\geq$  RBW, Sweep = auto; Detector Function = Peak. Trace = Max hold.
4. Allowed the trace to stabilize. Use the marker-delta function to determine the separation between the peaks of the adjacent channels.





Report No.: 170224140GZU-001  
Issued: 2017-07-10

**Test result:**

<b>Test Channel</b>	<b>Carrier Frequencies Separated</b>	<b>Pass/Fail</b>
Lower Channels (channel 0 and channel 1)	1.013MHz	Pass
Middle Channels (channel 39 and channel 40)	1.0008MHz	Pass
Upper Channels (channel 77 and channel 78)	1.0058MHz	Pass

**Remark:**

The limit is the maximum two-thirds of the 20 dB bandwidth: 863 kHz.

**Result plot as follows:**

**Lowest Channels: Carrier Frequencies Separated**

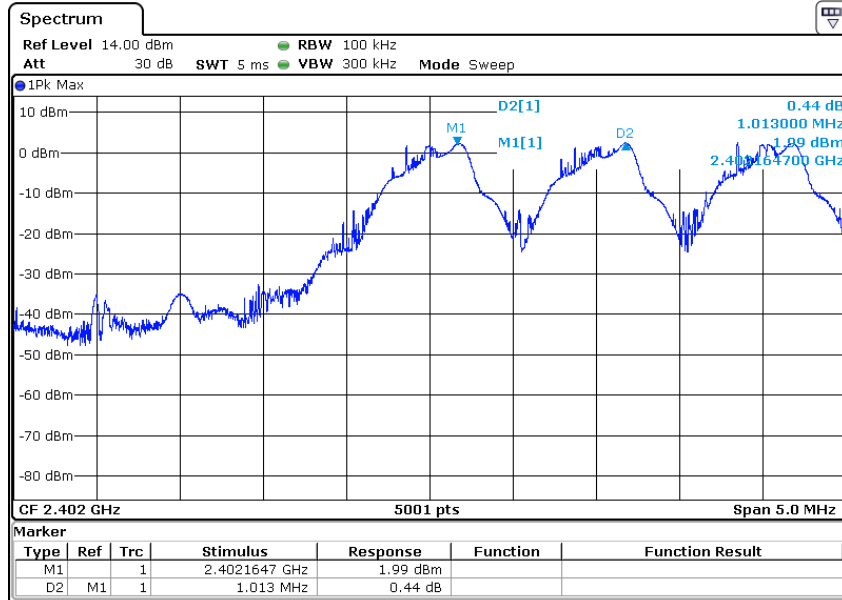

**Middle Channels: Carrier Frequencies Separated**

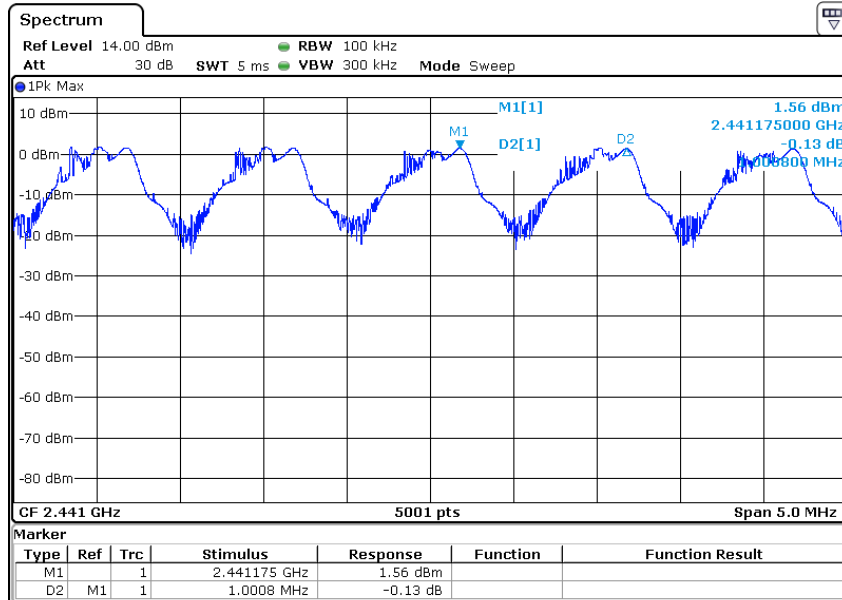

Highest Channels: Carrier Frequencies Separated

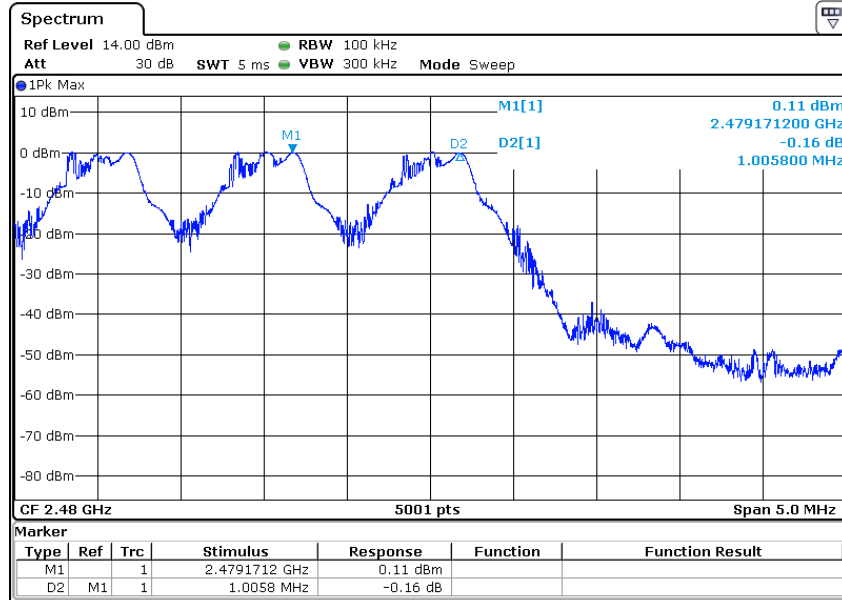

**Test result: The unit does meet the FCC requirements.**

#### 4.4 Hopping Channel Number

**Test Requirement:** FCC Part15 C section 15.247  
 (a)(1)(iii) Frequency hopping systems in the 2400-2483.5 MHz band shall use at least 15 channels.

**Test Method:** ANSI C63.10: Clause 7.8.3

**Test Status:** Pre-test the EUT in hopping mode with different data packet. Compliance test in hopping with Normal mode (DH5) as the worst case was found.

**Test Configuration:**

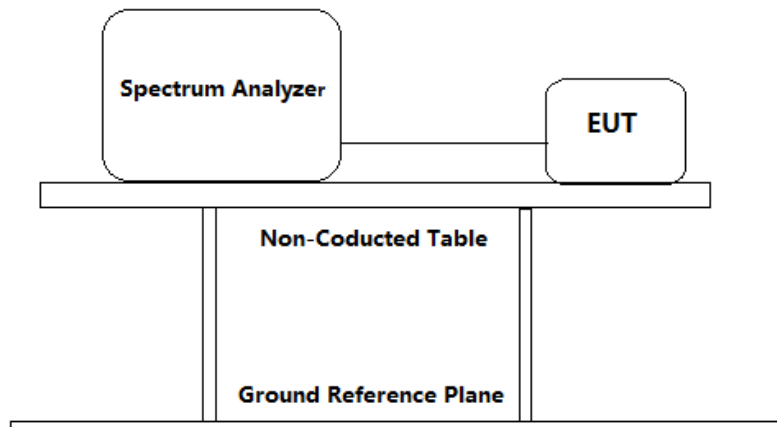

**Test Procedure:**

1. Removed the antenna from the EUT and then connect a low attenuation RF cable from the antenna port to the spectrum.
2. Span: The frequency band of operation
3. Set the spectrum analyzer: RBW = 100 kHz. VBW = 300 kHz. Sweep = auto; Detector Function = Peak. Trace = Max hold.
4. Allowed the trace to stabilize.
5. Set the spectrum analyzer: start frequency = 2400 MHz, stop frequency = 2483.5 MHz. Submit the test result graph.

**Test result:** Total channels are 79 channels.

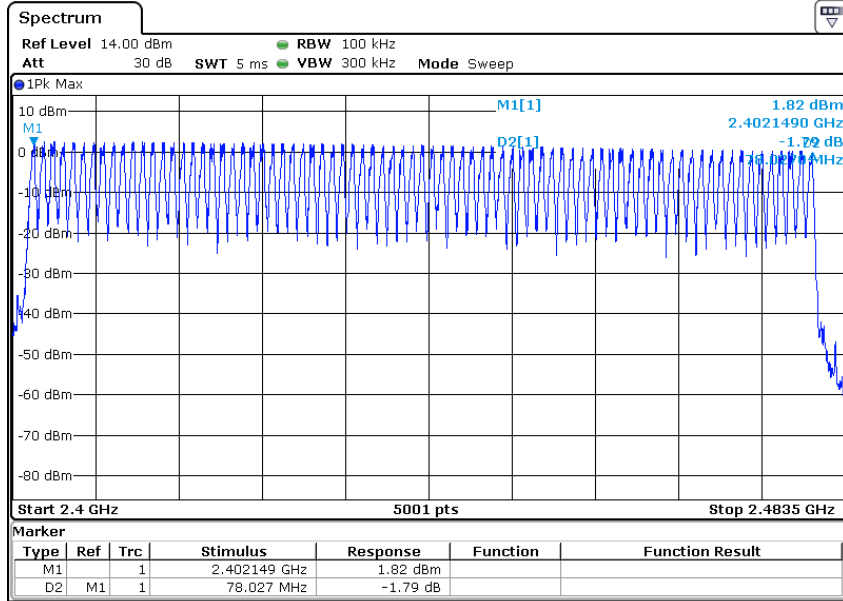

**Test result:** The unit does meet the FCC requirements.

#### 4.5 Dwell Time

**Test Requirement:** FCC Part 15 C section 15.247

(a)(1)(iii) Frequency hopping systems in the 2400-2483.5 MHz band shall use at least 15 channels. The average time of occupancy on any channel shall not be greater than 0.4 seconds within a period of 0.4 seconds multiplied by the number of hopping channels employed. Frequency hopping systems may avoid or suppress transmissions on a particular hopping frequency provided that a minimum of 15 channels are used.

**Test Method:** ANSI C63.10: Clause 7.8.4

**Test Status:** Test the EUT in hopping mode at the lowest (2402 MHz), middle (2441 MHz) and highest (2480 MHz) channel with different data packet. Compliance test in hopping mode with EDR mode (3DH1, 3DH3 and 3DH5) as the worst case was found.

**Test Configuration:**

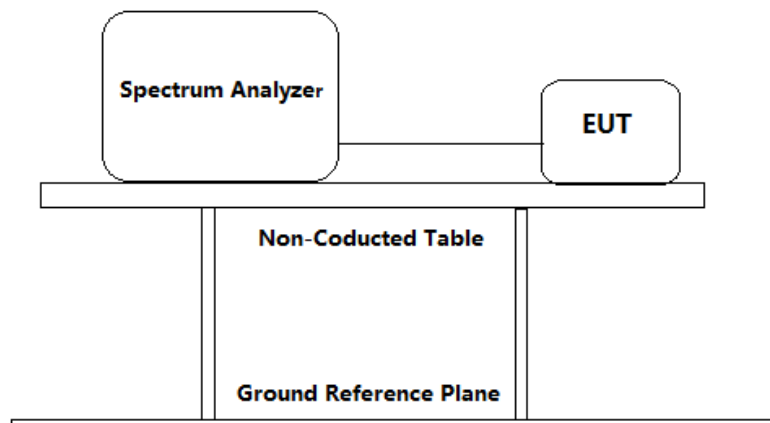

**Test Procedure:**

1. Removed the antenna from the EUT and then connect a low attenuation RF cable from the antenna port to the spectrum.
2. Set spectrum analyzer span = 0, centered on a hopping channel.
3. Set RBW = 1 MHz and VBW = 3 MHz. Sweep = as necessary to capture the entire dwell time per hopping channel. Detector Function = Peak. Trace = Max hold;
4. Used the marker-delta function to determine the dwell time.

**Test Result:**

The test period:  $T = 0.4 \text{ s} \times 79 \text{ Channel} = 31.6 \text{ s}$

<b>1. Channel 0: 2.402 GHz</b>										
3DH1 time slot	=	0.395	(ms)	*	32	*	(31.6/3.16)	=	126.400	ms
3DH3 time slot	=	1.647	(ms)	*	16	*	(31.6/3.16)	=	263.520	ms
3DH5 time slot	=	2.911	(ms)	*	11	*	(31.6/3.16)	=	320.210	ms
<b>2. Channel 39: 2.441 GHz</b>										
3DH1 time slot	=	0.395	(ms)	*	32	*	(31.6/3.16)	=	126.400	ms
3DH3 time slot	=	1.648	(ms)	*	16	*	(31.6/3.16)	=	263.680	ms
3DH5 time slot	=	2.911	(ms)	*	11	*	(31.6/3.16)	=	320.210	ms
<b>3. Channel 78: 2.480 GHz</b>										
3DH1 time slot	=	0.397	(ms)	*	32	*	(31.6/3.16)	=	127.040	ms
3DH3 time slot	=	1.648	(ms)	*	16	*	(31.6/3.16)	=	263.680	ms
3DH5 time slot	=	2.911	(ms)	*	11	*	(31.6/3.16)	=	320.210	ms

The average time of occupancy in the specified 31.6 second period is equal to pulse width x (number of pulse in observation period) x (test period / observation period)

The results are not greater than 0.4 seconds.

**The unit does meet the FCC requirements.**

**Result plot as follows:**

**1. Lowest channel (2.402 GHz):**

(1) 3DH1

Pulse Width:

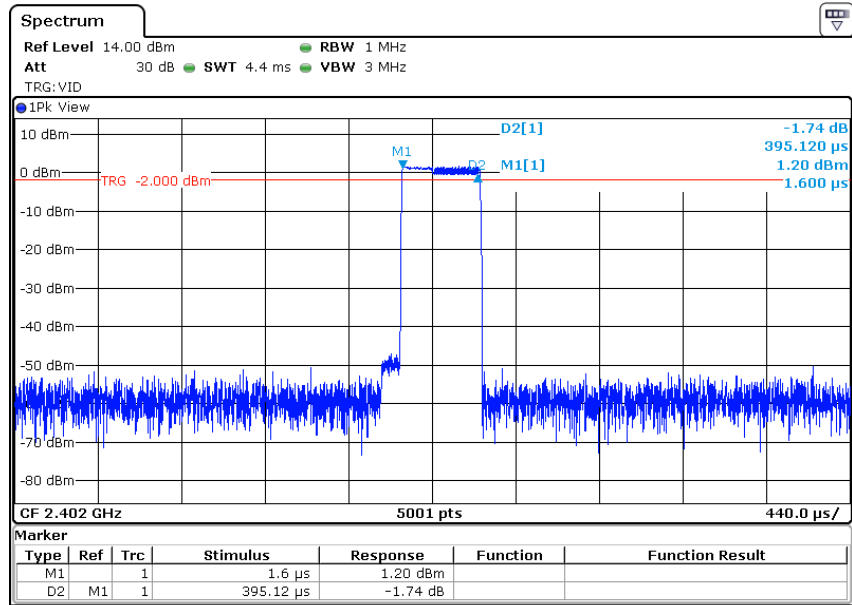

Number of Pulses in 3.16 S observation period:

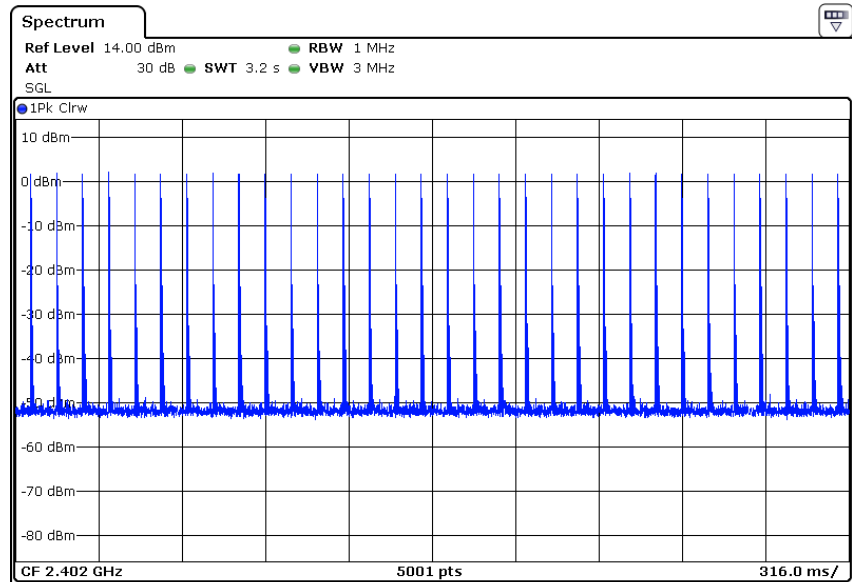



(2) 3DH3

Pulse Width:

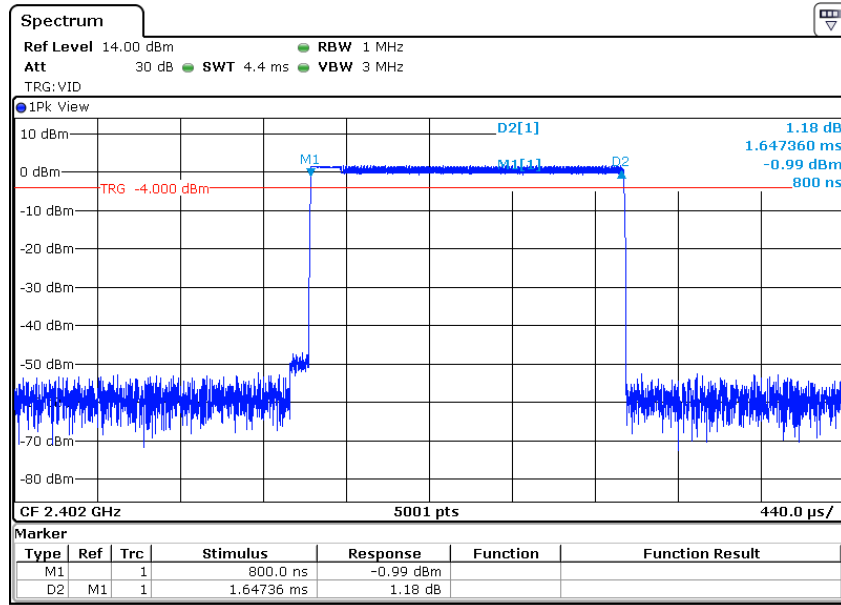

Number of Pulses in 3.16 S observation period:

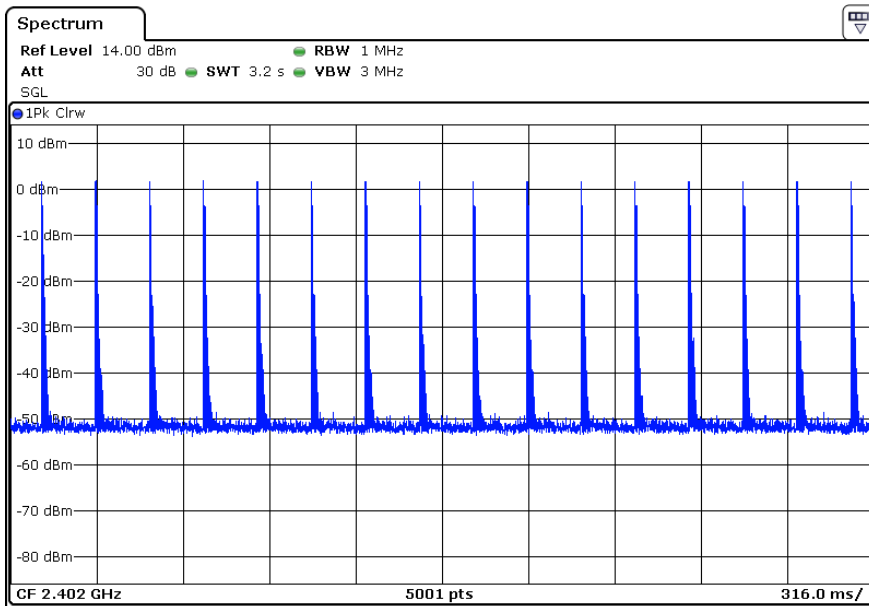

(3) 3DH5

Pulse Width:

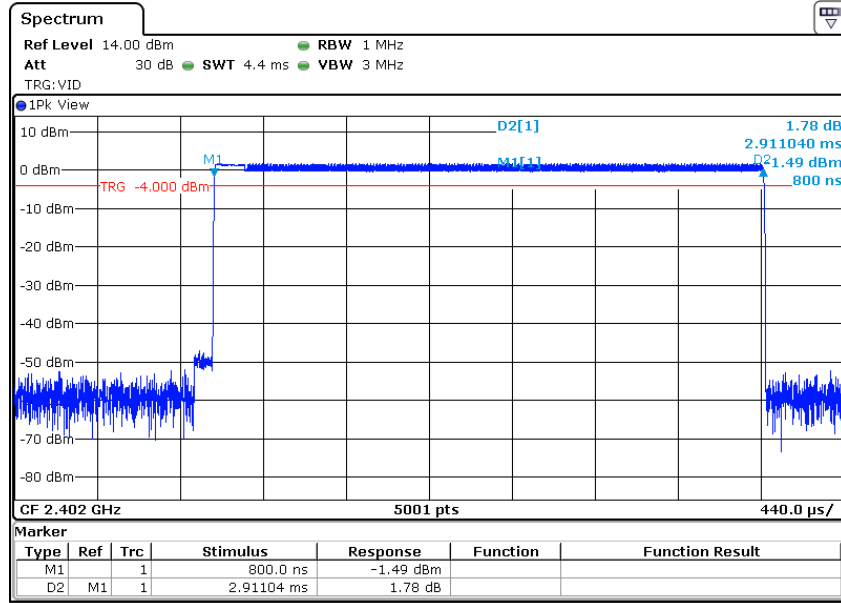

Number of Pulses in 3.16 S observation period:

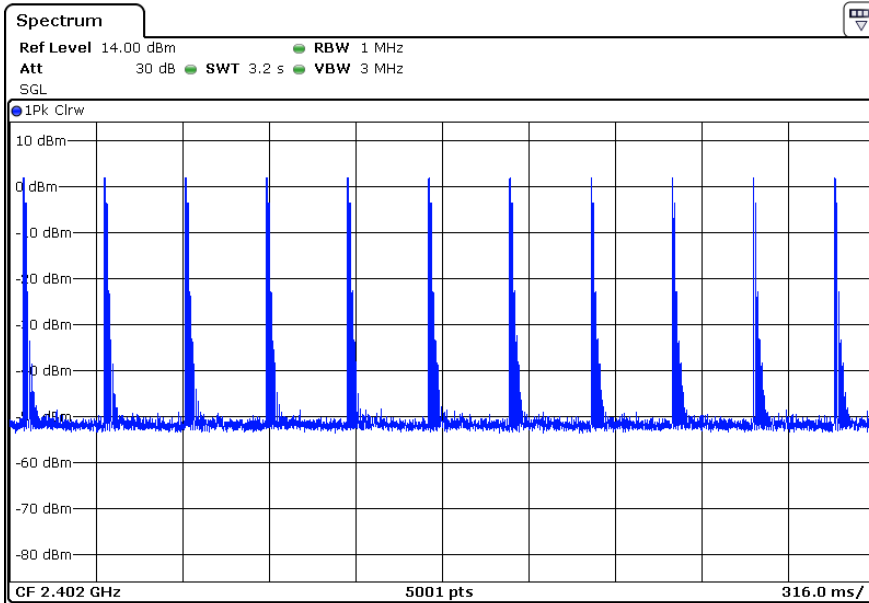

**2. Middle Channel (2.441 GHz):**

(1). 3DH1

Pulse Width:

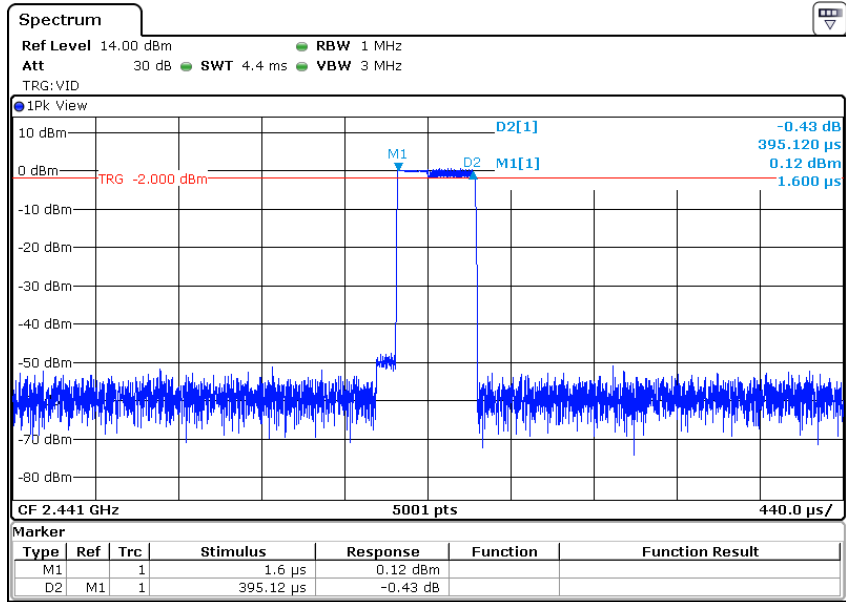

Number of Pulses in 3.16 S observation period:

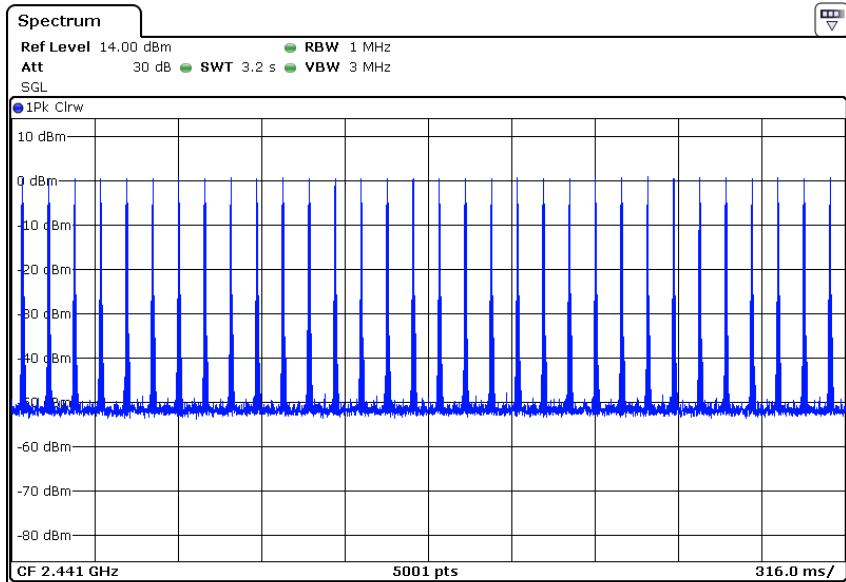

(2) 3DH3

Pulse Width:

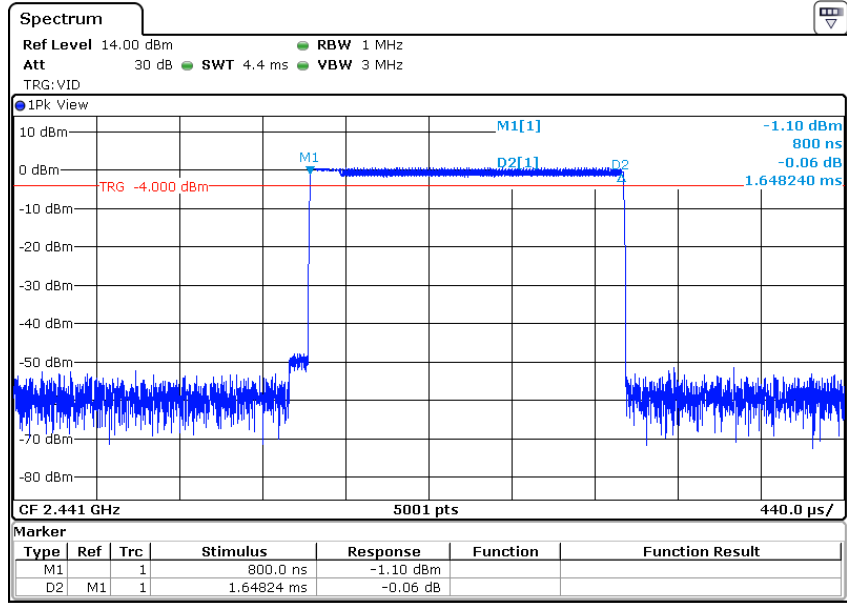

Number of Pulses in 3.16 S observation period:

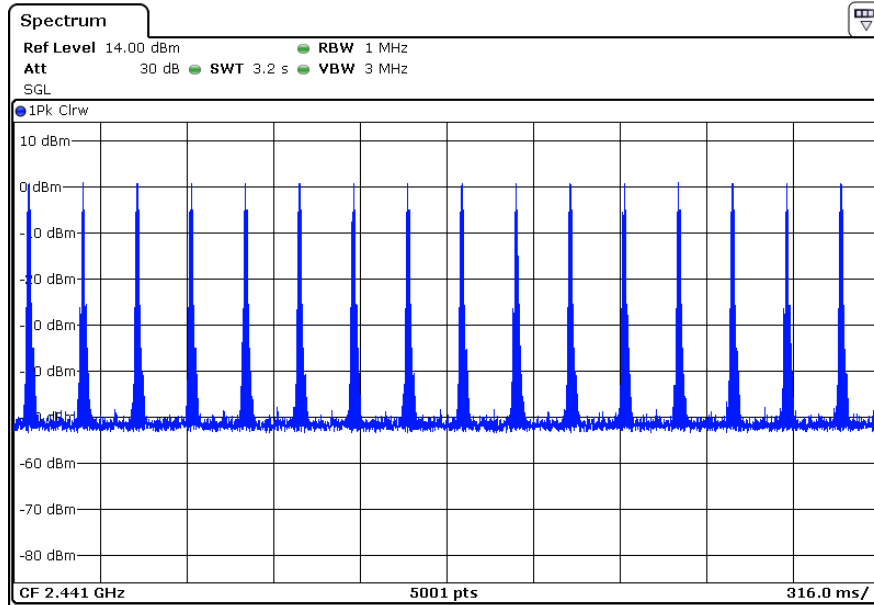

(3) 3DH5

Pulse Width:

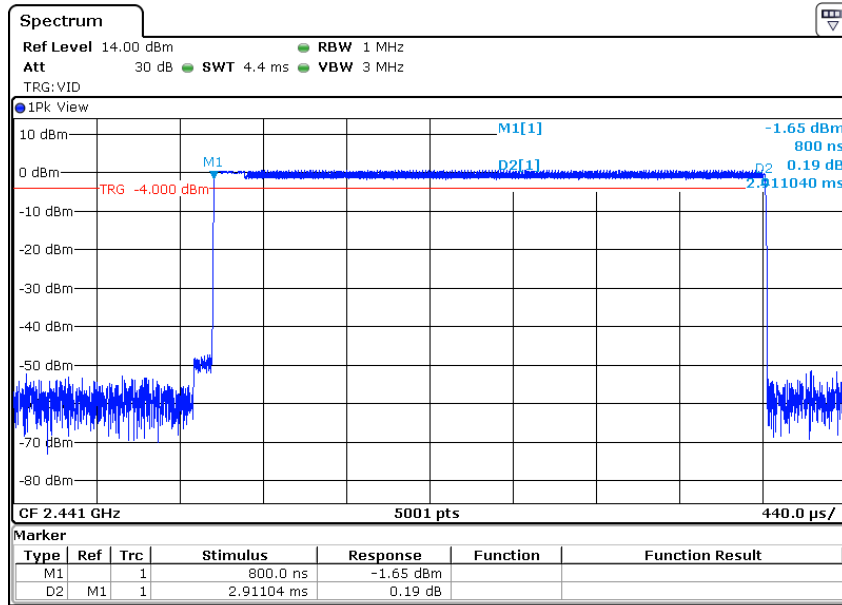

Number of Pulses in 3.16 S observation period:

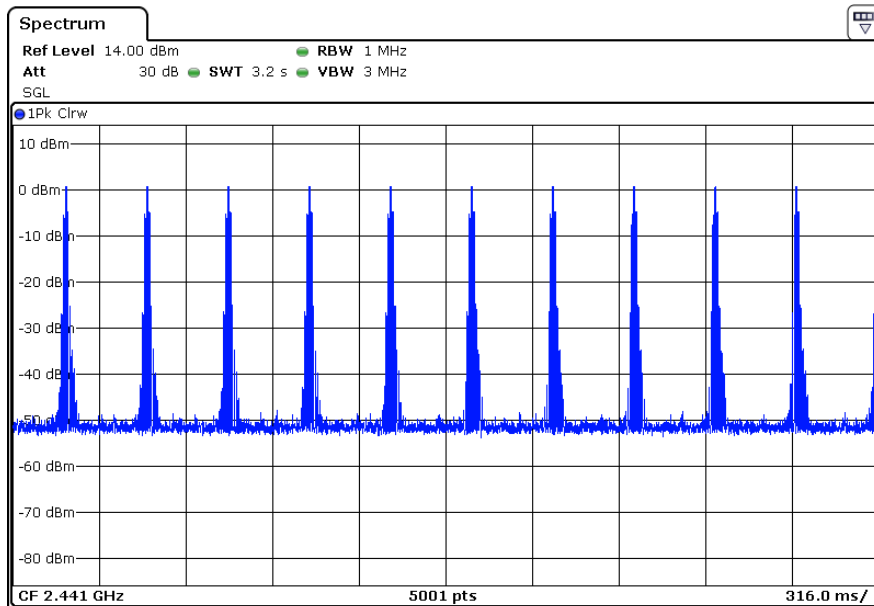

**3. Highest Channel (2.480 GHz):**

(1). 3DH1

Pulse Width:

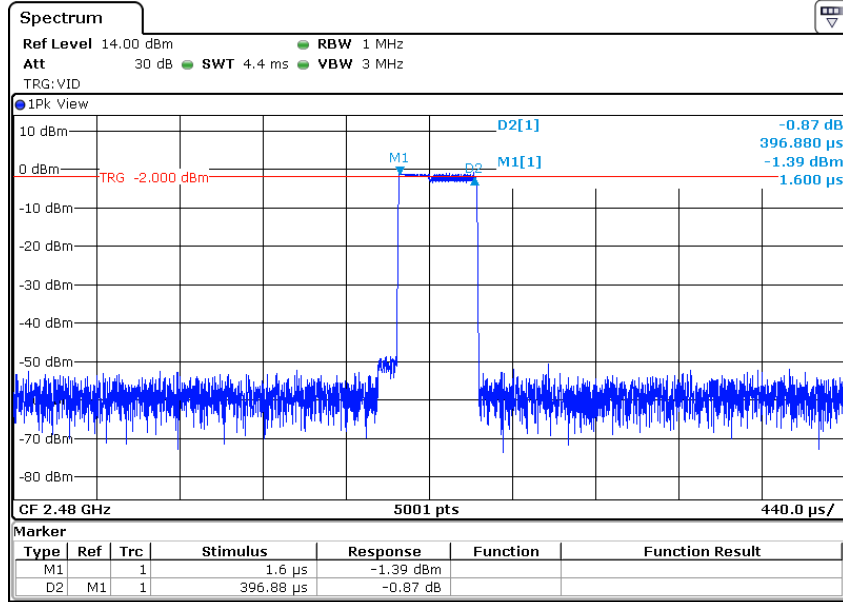

Number of Pulses in 3.16 S observation period:

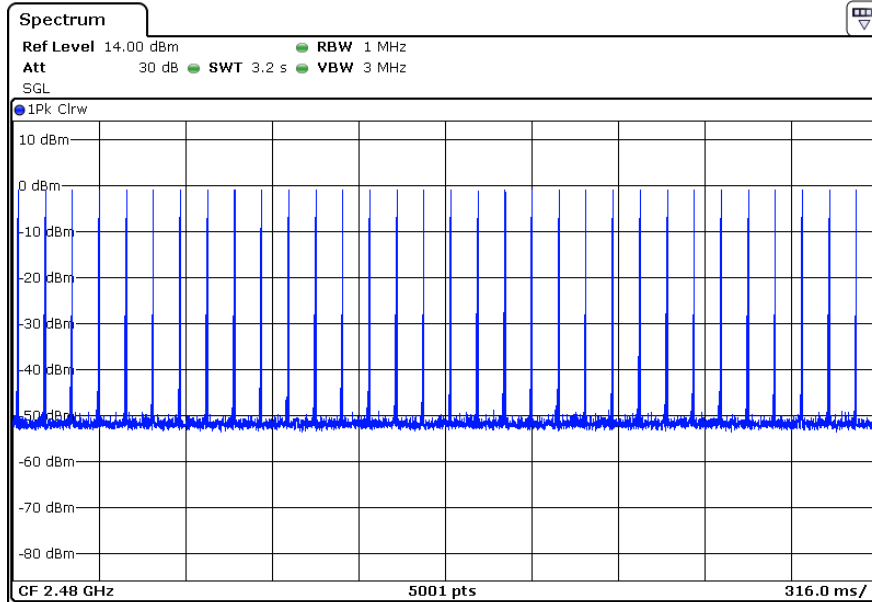

(2) 3DH3

Pulse Width:

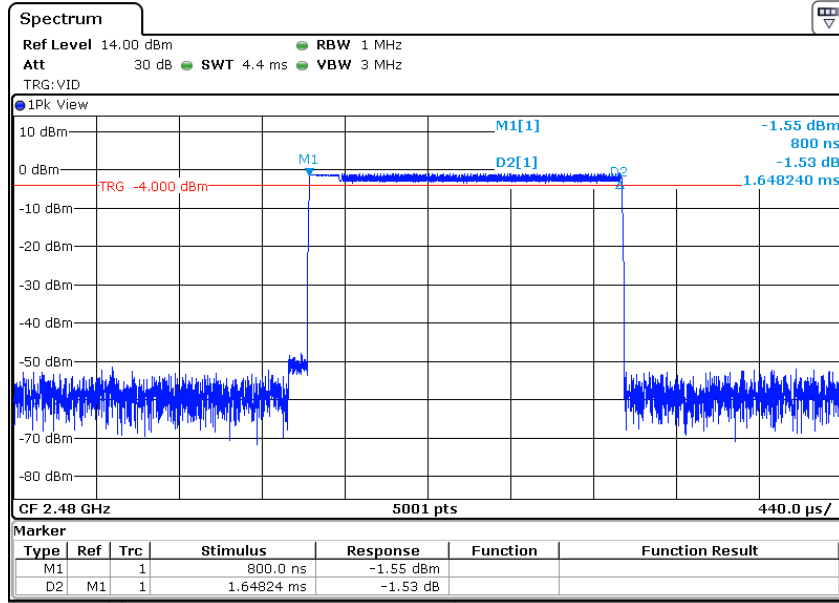

Number of Pulses in 3.16 S observation period:

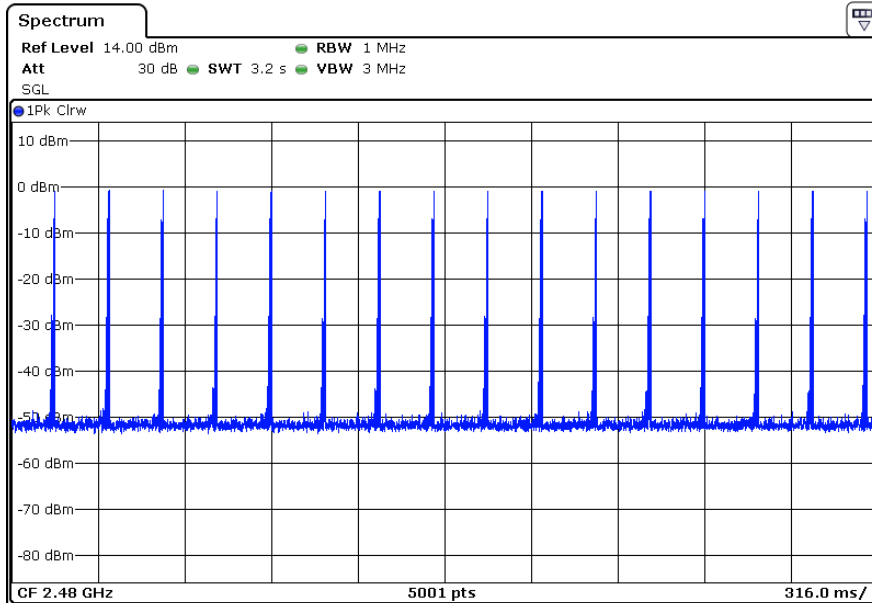

(3) 3DH5

Pulse Width:

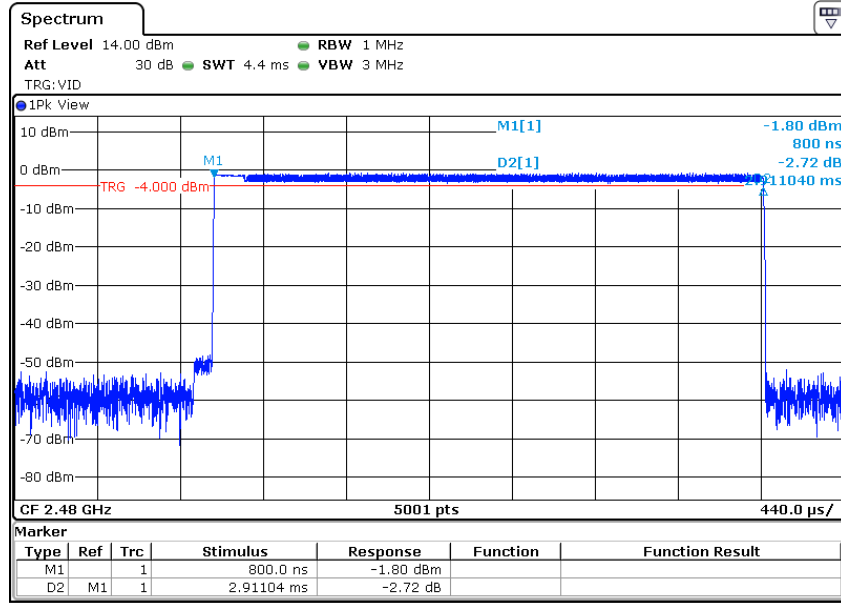

Number of Pulses in 3.16 S observation period:

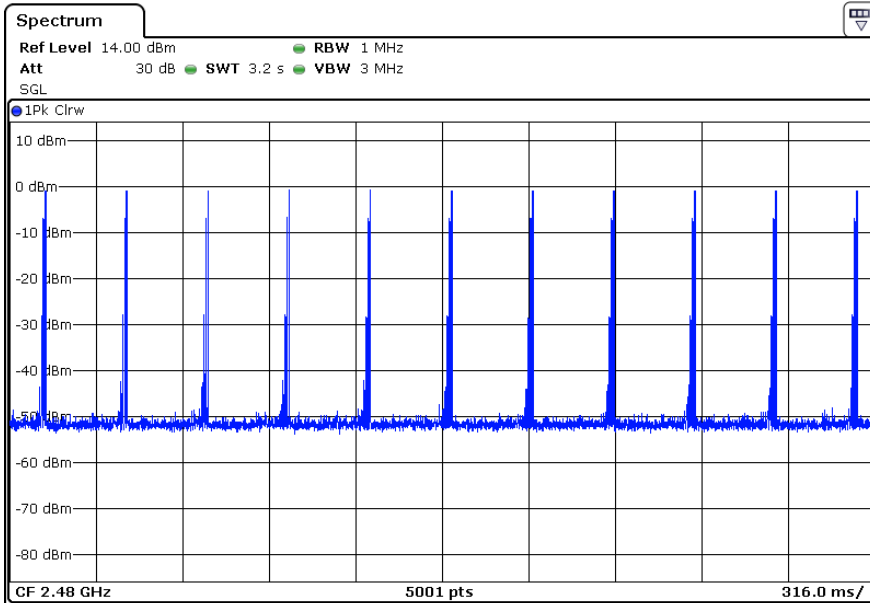



#### **4.6 Pseudo random Frequency Hopping Sequence**

##### 4.6.1 Standard requirement

15.247(a)(1) requirement:

The system shall hop to channel frequencies that are selected at the system hopping rate from a Pseudo random ordered list of hopping frequencies. Each frequency must be used equally on the average by each transmitter. The system receivers shall have input bandwidths that match the hopping channel bandwidths of their corresponding transmitters and shall shift frequencies in synchronization with the transmitted signals.

##### 4.6.2 EUT Pseudo random Frequency Hopping Sequence

Bluetooth protocol is utilized by the EUT. It is shown that each frequency used equally on the average by the transmitter. The system receivers have input bandwidths that match the hopping channel bandwidths of their corresponding transmitters and shift frequencies in synchronization with the transmitted signals.

**4.7 Maximum Peak Conducted Output Power**

Test Requirement: FCC Part 15 C section 15.247  
 (a)(1)Frequency hopping systems operating in the 2400-2483.5 MHz band may have hopping channel carrier frequencies that are separated by 25 kHz or two-thirds of the 20 dB bandwidth of the hopping channel, whichever is greater, provided the systems operate with an output power no greater than 125 mW.

Test Method: ANSI C63.10: Clause 7.8.5

Test Status: Pre-test the EUT in continuous transmitting mode at the lowest (2402 MHz), middle (2441 MHz) and highest (2480 MHz) channel with different data packet. Compliance test in continuous transmitting mode with normal (DH5) and EDR mode (3DH5) as the worst case were found.

Test Configuration:

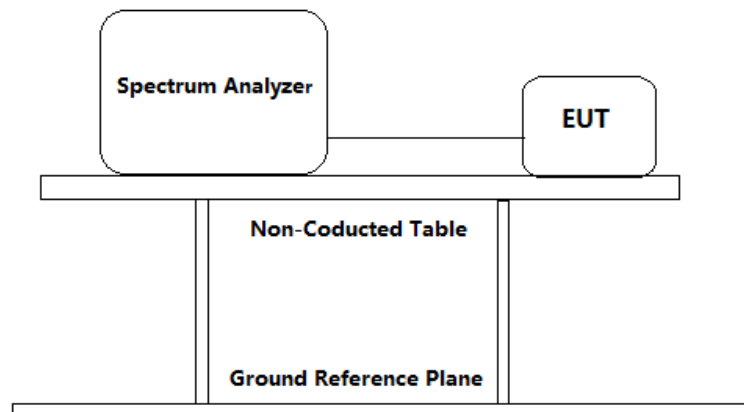

Test Procedure:

1. Removed the antenna from the EUT and then connect a low attenuation RF cable (cable loss=1.0 dB) from the antenna port to the spectrum.
2. Span: Approximately five times the 20 dB bandwidth, centered on a hopping channel.
3. Set the spectrum analyzer: RBW = 2 MHz (RBW > 20 dB bandwidth of the emission being measured) . VBW = 2 MHz. Sweep = auto; Detector Function = Peak. Trace: Max hold.
4. Kept the EUT in transmitting at lowest, medium and highest channel with different data packet individually. Record the max value.

**Test result:**

<b>Normal mode (DH5):</b>				
<b>Test Channel</b>	<b>Fundamental Frequency (MHz)</b>	<b>Output Power (dBm)</b>	<b>Limit (dBm)</b>	<b>Result</b>
Lowest	2402	3.57	21.0	Pass
Middle	2441	2.85	21.0	Pass
Highest	2480	1.19	21.0	Pass
<b>EDR mode(3DH5):</b>				
<b>Test Channel</b>	<b>Fundamental Frequency (MHz)</b>	<b>Output Power (dBm)</b>	<b>Limit (dBm)</b>	<b>Result</b>
Lowest	2402	2.71	21.0	Pass
Middle	2441	1.70	21.0	Pass
Highest	2480	0.00	21.0	Pass
<b>Remark:</b> Cable lose=1.0 dB Level = Read Level + Cable Loss.				

Result plot as follows:

**Normal mode(DH5):**

Lowest Channel(2.402 MHz):

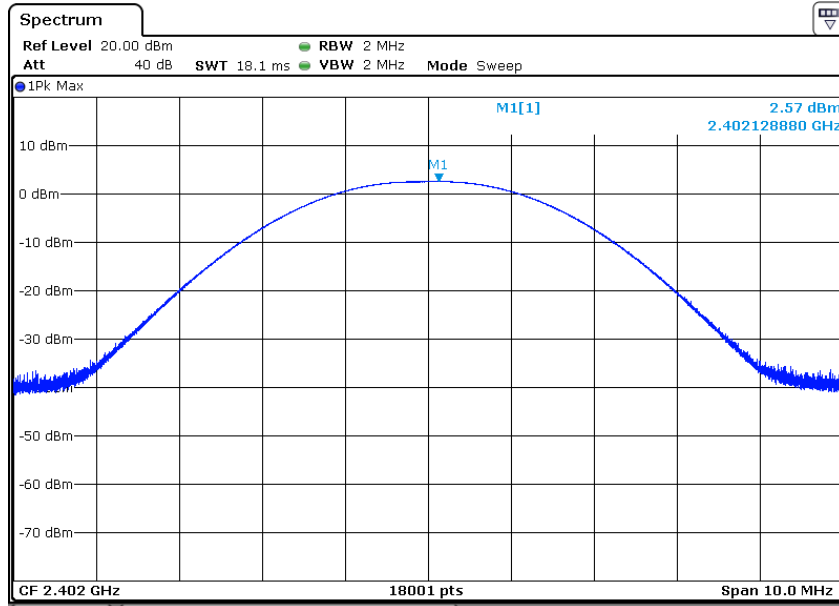

Middle Channel(2.441 GHz):

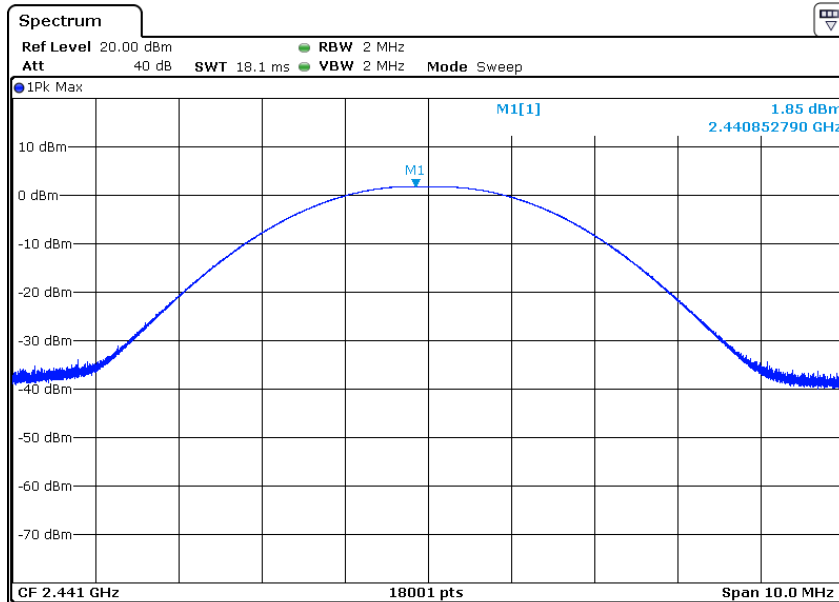

Highest Channel(2.480 GHz):

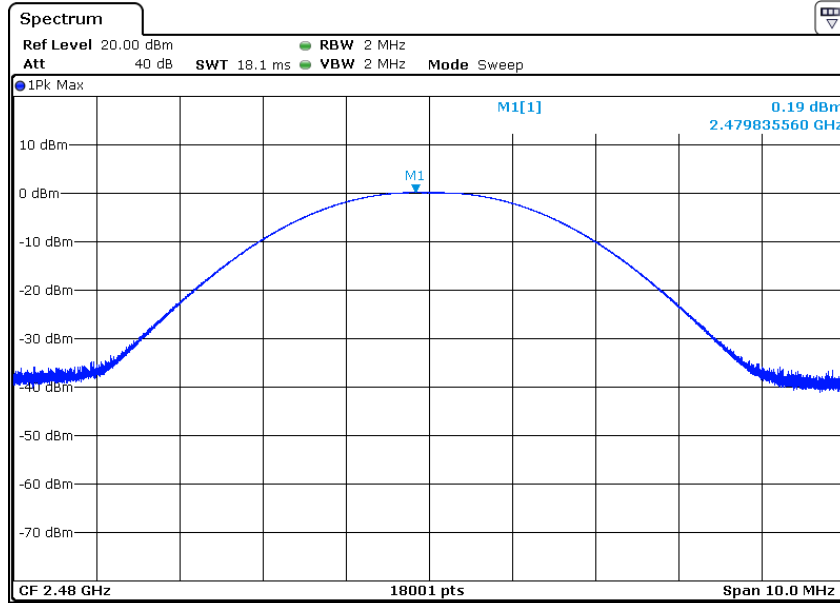

EDR mode (3DH5):

Lowest channel(2.402 GHz):

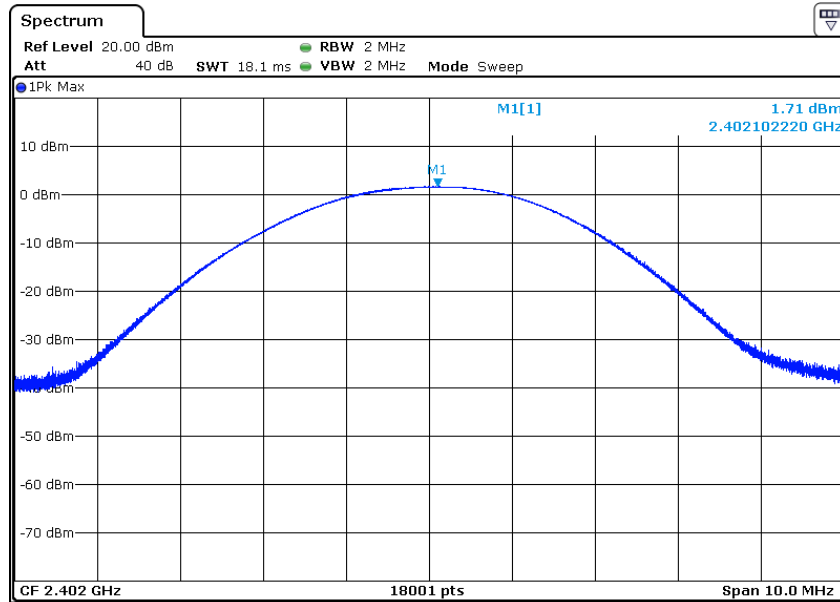

Middle channel(2.441 GHz):

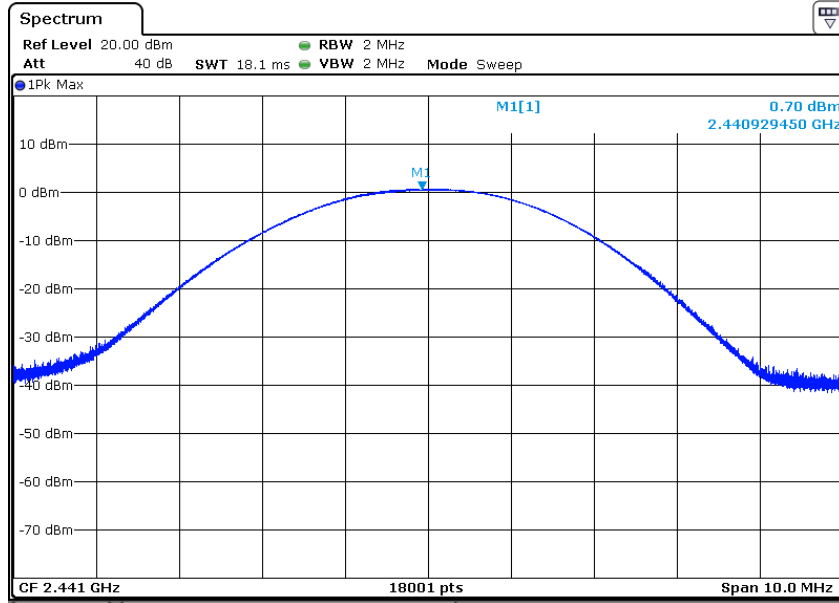

Highest channel(2.480 GHz):

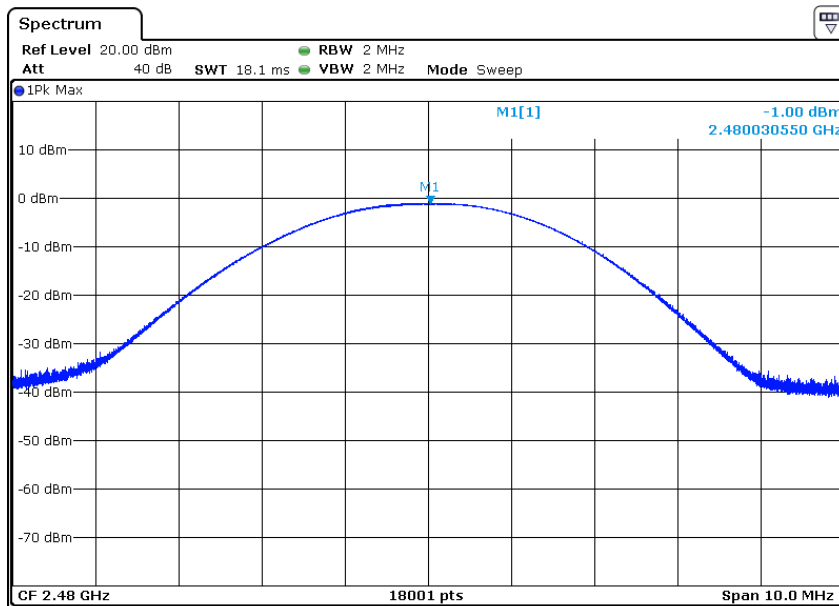

#### 4.5 Out of Band Conducted Emissions

Test Requirement: FCC Part 15 C section 15.247

(d) In any 100 kHz bandwidth outside the frequency band in which the spread spectrum or digitally modulated intentional radiator is operating, the radio frequency power that is produced by the intentional radiator shall be at least 20 dB below that in the 100 kHz bandwidth within the band that contains the highest level of the desired power. Based on either an RF conducted or a radiated measurement. Provided the transmitter demonstrates compliance with the peak conducted power limits.

Test Method: ANSI C63.10: Clause 7.8.8

Test Status: Pre-test the EUT in continuous transmitting mode at the lowest (2402 MHz), middle (2441 MHz) and highest (2480 MHz) channel with different data packet. Compliance test in continuous transmitting mode with EDR mode (3DH5) as the worst case was found.

Test Configuration:

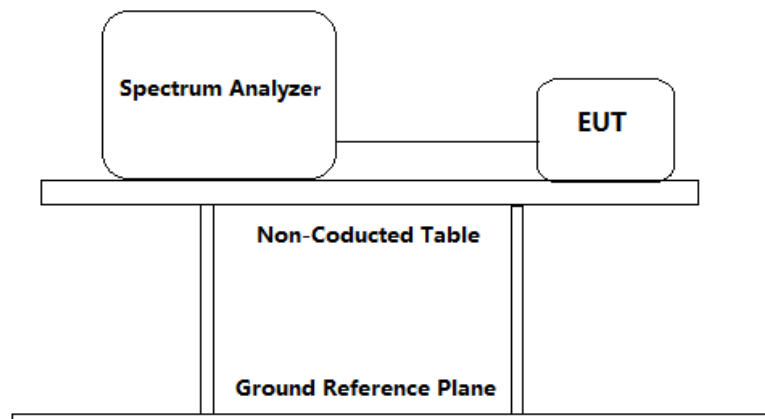

Test Procedure:

1. Removed the antenna from the EUT and then connect a low RF cable (cable loss =1.0dB) from the antenna port to the spectrum analyser.
2. Set the spectrum analyzer: RBW=100 kHz, VBW = 300 kHz. Sweep = auto; Detector Function = Peak. Trace = Max Hold, Scan up through 10<sup>th</sup> harmonic.
3. Measured the Conducted unwanted Emissions of the test frequency with special test status.
4. Repeated until all the test status was investigated.

Result plot as follows:

**Lowest channel (2.402 GHz):**

30 MHz to 25 GHz:

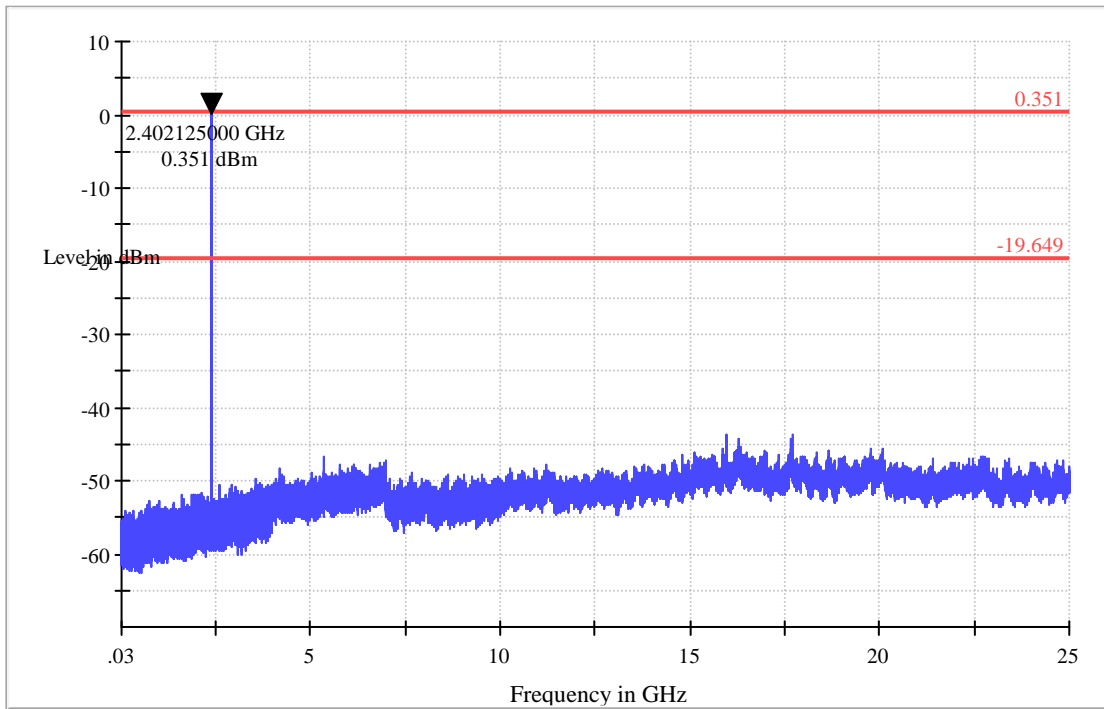

In any 100 kHz bandwidth, the Conducted Spurious Emissions from 30 MHz to 25 GHz were greater than 20dB below the peak emission within the band that contains the highest level of the desired power.



**Middle Channel (2.441 GHz):**

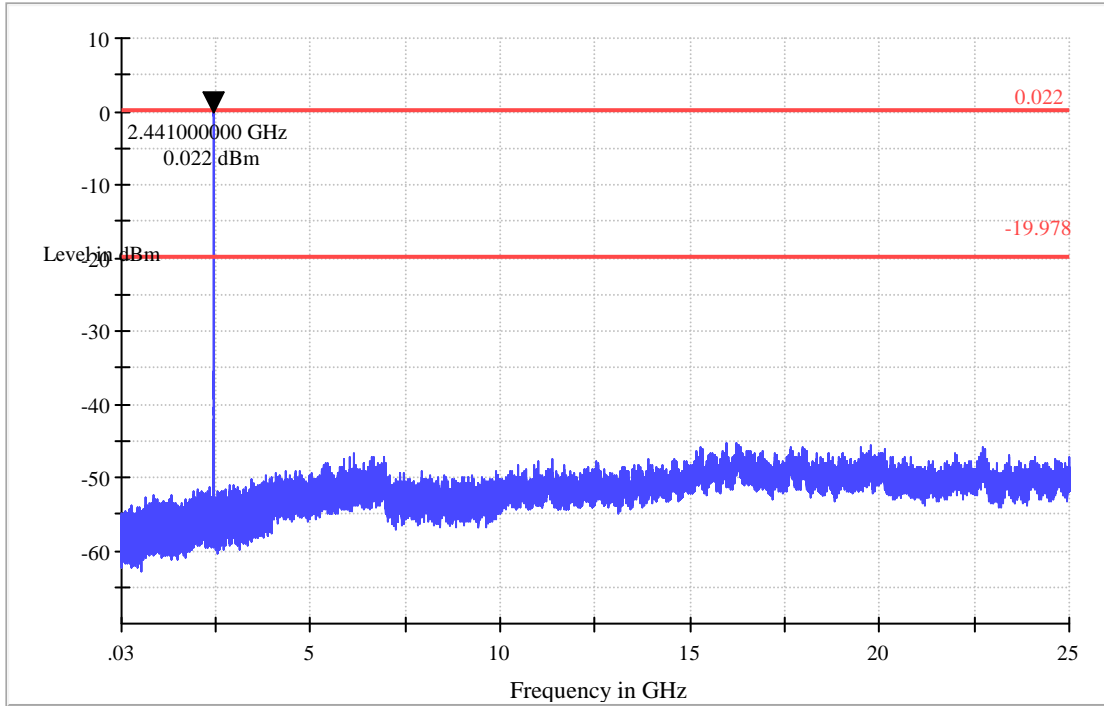

In any 100 kHz bandwidth, the Conducted Spurious Emissions from 30 MHz to 25 GHz were greater than 20dB below the peak emission within the band that contains the highest level of the desired power.

**Highest Channel (2.480 GHz):**

30 MHz to 25 GHz:

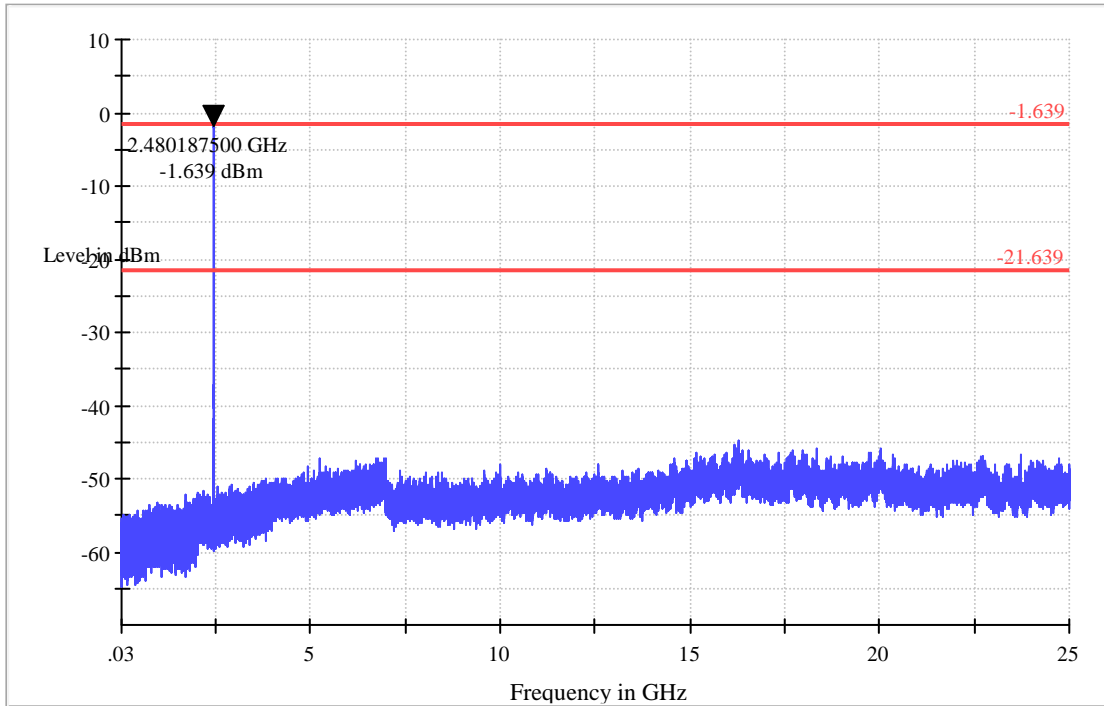

In any 100 kHz bandwidth, the Conducted Spurious Emissions from 30 MHz to 25 GHz were greater than 20dB below the peak emission within the band that contains the highest level of the desired power.



Report No.: 170224140GZU-001  
Issued: 2017-07-10

#### **4.6 Out of Band Radiated Emissions**

For out of band radiated emissions into Non-Restricted Frequency Bands were performed at a 3m separation distance to determine whether these emissions complied with the 20dB attenuation requirement.

- Not required, since all emissions are more than 20dB below fundamental
- See attached data sheet

#### 4.7 Radiated Emissions in Restricted Bands

Test Requirement:	FCC Part 15 C section 15.247  (d) In addition, radiated emissions which fall in the restricted bands, as defined in Section 15.205(a), must also comply with the radiated emission limits specified in Section 15.209(a) (see Section 15.205(c)).
Test Method:	ANSI C63.10: Clause 6.4, 6.5 and 6.6
Test Status:	Pre-test the EUT in continuous transmitting mode at the lowest (2402 MHz), middle (2441 MHz) and highest (2480 MHz) channel with different data packet. Compliance test in continuous transmitting mode with EDR (3DH5) as the worst case was found.
Test site:	Measurement Distance: 3m (Semi-Anechoic Chamber)
Limit:	Section 15.209  40.0 dB $\mu$ V/m between 30MHz & 88MHz; 43.5 dB $\mu$ V/m between 88MHz & 216MHz; 46.0 dB $\mu$ V/m between 216MHz & 960MHz; 54.0 dB $\mu$ V/m above 960MHz.
Detector:	For Peak and Quasi-Peak value: RBW = 1 MHz for $f \geq 1$ GHz, 200 Hz for 9 kHz to 150 kHz 9 kHz for 150 kHz to 30 MHz 120 kHz for 30 MHz to 1GHz VBW $\geq$ RBW Sweep = auto Detector function = peak for $f \geq 1$ GHz, QP for $f < 1$ GHz Trace = max hold  For AV value: RBW = 1 MHz for $f \geq 1$ GHz, 100 kHz for $f < 1$ GHz VBW=10 Hz Sweep = auto Trace = max hold

Section 15.205 Restricted bands of operation.

MHz	MHz	MHz	GHz
0.090 - 0.110	16.42 - 16.423	399.9 - 410	4.5 - 5.15
<sup>1</sup> 0.495 - 0.505	16.69475 -	608 - 614	5.35 - 5.46
2.1735 - 2.1905	16.69525	960 - 1240	7.25 - 7.75
4.125 - 4.128	16.80425 -	1300 - 1427	8.025 - 8.5
4.17725 - 4.17775	16.80475	1435 - 1626.5	9.0 - 9.2
4.20725 - 4.20775	25.5 - 25.67	1645.5 - 1646.5	9.3 - 9.5
6.215 - 6.218	37.5 - 38.25	1660 - 1710	10.6 - 12.7
6.26775 - 6.26825	73 - 74.6	1718.8 - 1722.2	13.25 - 13.4
6.31175 - 6.31225	74.8 - 75.2	2200 - 2300	14.47 - 14.5
8.291 - 8.294	108 - 121.94	2310 - 2390	15.35 - 16.2
8.362 - 8.366	123 - 138	2483.5 - 2500	17.7 - 21.4
8.37625 - 8.38675	149.9 - 150.05	2655 - 2900	22.01 - 23.12
8.41425 - 8.41475	156.52475 -	3260 - 3267	23.6 - 24.0
12.29 - 12.293	156.52525	3332 - 3339	31.2 - 31.8
12.51975 -	156.7 - 156.9	3345.8 - 3358	36.43 - 36.5
12.52025	162.0125 - 167.17	3600 - 4400	
12.57675 -	167.72 - 173.2		
12.57725	240 - 285		
13.36 - 13.41	322 - 335.4		

Test Configuration:

1) 9 kHz to 30 MHz emissions:

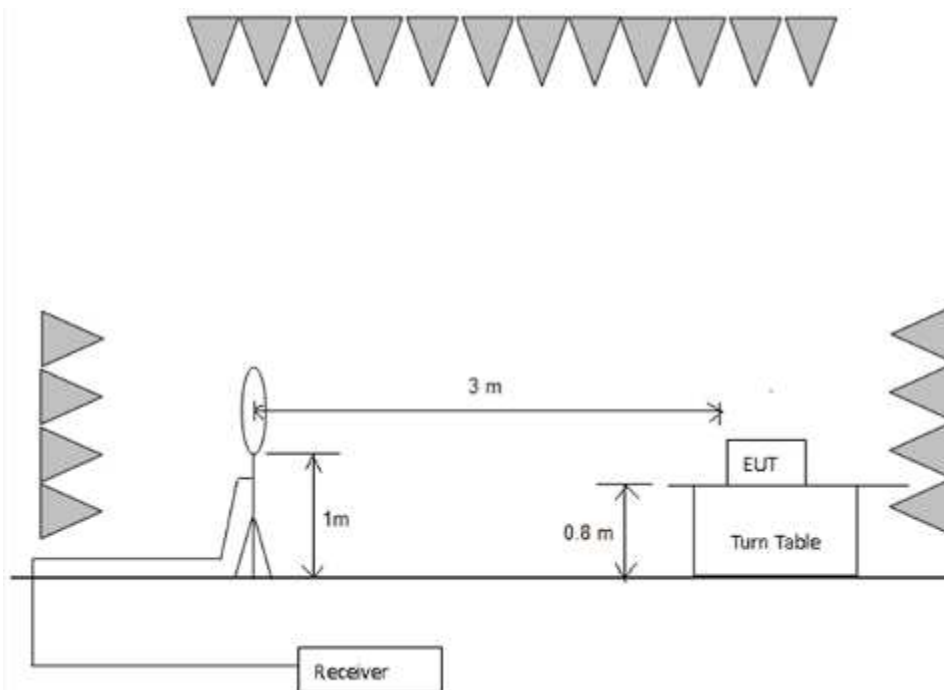

2) 30 MHz to 1 GHz emissions:

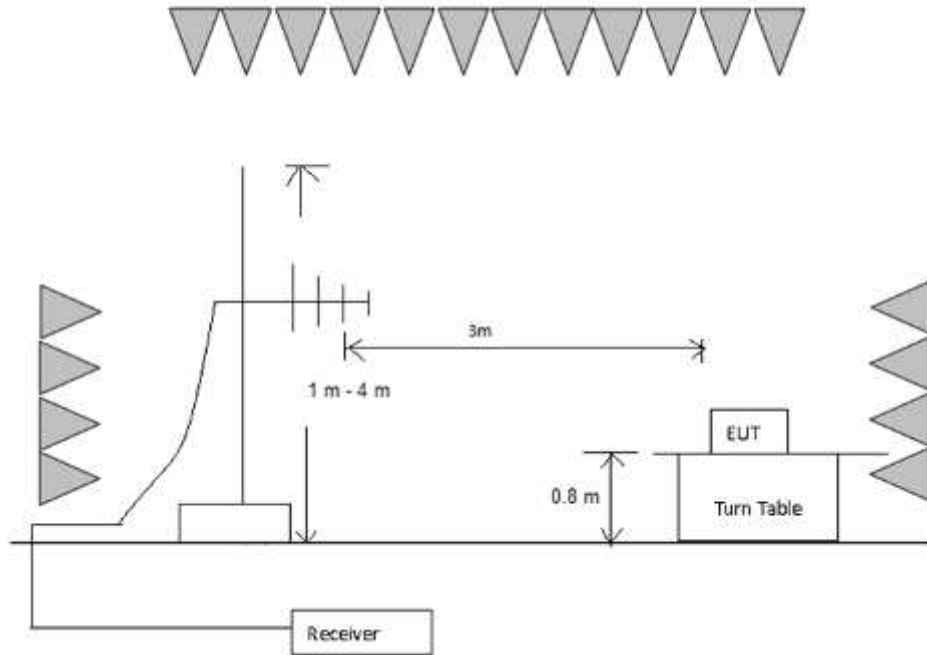

3) 1 GHz to 40 GHz emissions:

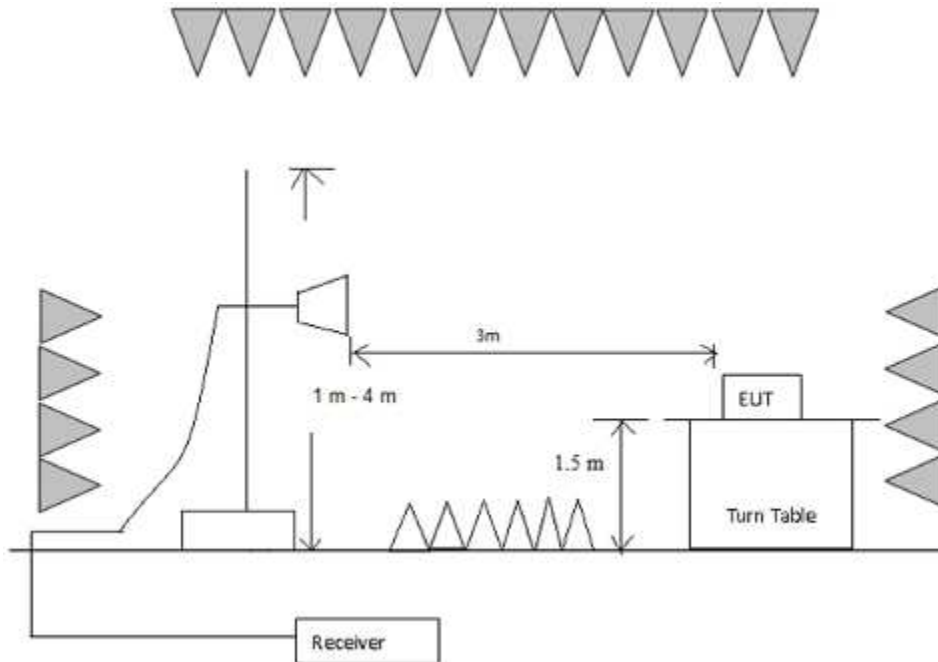

**Test Procedure:**

1) 9 kHz to 30 MHz emissions:

For testing performed with the loop antenna. The centre of the loop was positioned 1 m above the ground and positioned with its plane vertical at the special distance from the EUT. During

testing the loop was rotated about its vertical axis for maximum response at each azimuth and also investigated with the loop positioned in the horizontal plane.

2) 30 MHz to 1 GHz emissions:

For testing performed with the bi-log type antenna. The measurement is performed with the EUT rotated 360°, the antenna height scanned between 1m and 4m, and the antenna rotated to repeat the measurement for both the horizontal and vertical antenna polarizations.

3) 1 GHz to 25 GHz emissions:

Test site with RF absorbing material covering the ground plane that met the site validation criterion called out in CISPR 16-1-4:2010 was used to perform radiated emission test above 1 GHz.

For testing performed with the horn antenna. The measurement is performed with the EUT rotated 360°, the antenna height scanned between 1m and 4m, and the antenna rotated to repeat the measurement for both the horizontal and vertical antenna polarizations.

4) The receiver was scanned from 9 kHz to 25 GHz. When an emission was found, the table was rotated to produce the maximum signal strength. An initial pre-scan was performed for in peak detection mode using the receiver. The EUT was measured for both the Horizontal and Vertical polarities and performed a pre-test three orthogonal planes. For intentional radiators, measurements of the variation of the input power or the radiated signal level of the fundamental frequency component of the emission, as appropriate, shall be performed with the supply voltage varied between 85% and 115% of the nominal rated supply voltage. The worst case emissions were reported.

**Normal mode (DH5)**

Test at Lowest Channel (2.402 GHz) in transmitting status

9 kHz~30 MHz Field Strength of Unwanted Emissions. Quasi-Peak Measurement

The measurements with active loop antenna were greater than 20dB below the limit, so the test data were not recorded in the test report.

30 MHz~1 GHz Spurious Emissions .Quasi-Peak Measurement

**Vertical:**

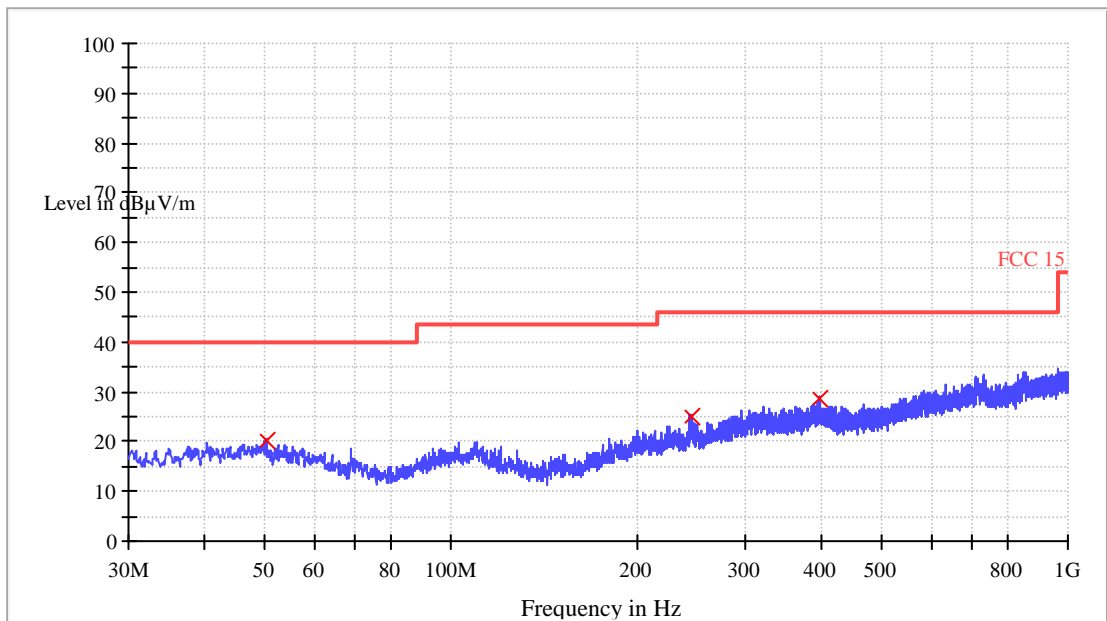

Frequency (MHz)	Receiver Reading Level (dBµV)	Correction factors (dB/m)	Emission Level (dBµV/m)	Limit (dBµV/m)
50.28	6.2	14.1	20.3	40.0
244.80	11.0	13.9	24.9	46.0
395.44	10.9	17.6	28.5	46.0

Remark:

Final Test Level = Receiver Reading + Correction Factor

Correction Factor = Antenna Factor + Cable Loss.



**Horizontal:**

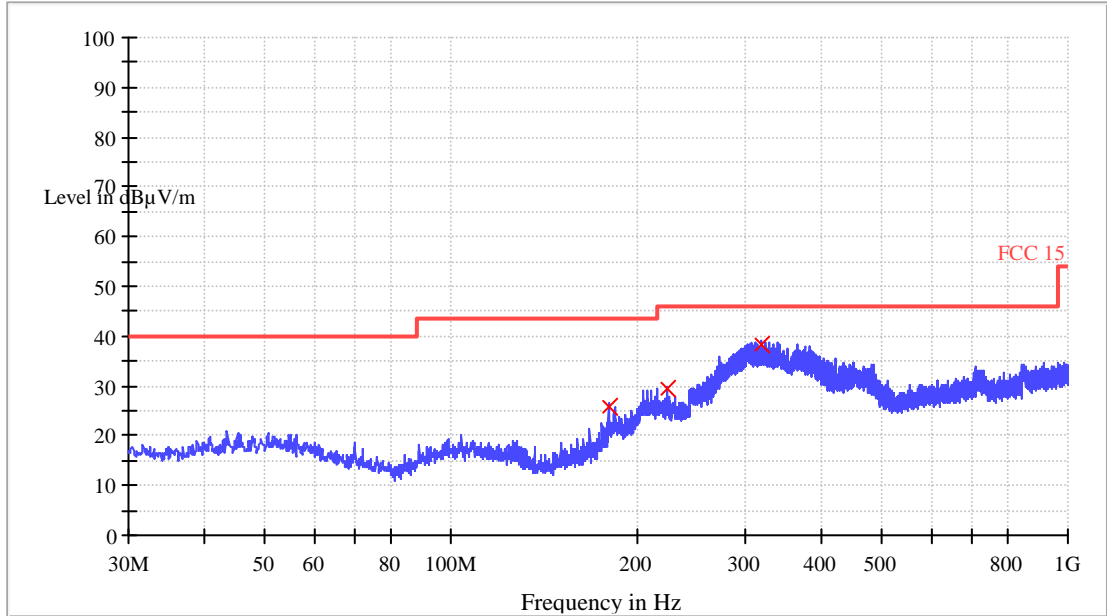

Frequency (MHz)	Receiver Reading Level (dBµV)	Correction factors (dB/m)	Emission Level (dBµV/m)	Limit (dBµV/m)
179.96	15.1	10.7	25.8	43.5
223.92	16.1	13.3	29.4	46.0
318.64	22.6	15.8	38.4	46.0

Remark:

Final Test Level = Receiver Reading + Correction Factor

Correction Factor = Antenna Factor + Cable Loss.

1~25 GHz Radiated Emissions. Peak & Average Measurement

**PK Measurement:**

Frequency (MHz)	PK Reading Level (dBμV)	Correction factors (dB/m)	PK Emission Level (dBμV/m)	PK Limit (dBμV/m)	Antenna polarization
1601.25	66.6	-11.5	55.1	74	Horizontal
4804.42	57.7	-0.5	57.2	74	Horizontal
7206.64	44.3	3.9	48.2	74	Horizontal
1601.21	61.2	-11.5	49.7	74	Vertical
4804.27	55.4	-0.5	54.9	74	Vertical
7206.59	44.0	3.9	47.9	74	Vertical

**AV Measurement:**

Frequency (MHz)	AV Reading Level (dBμV)	Correction factors (dB/m)	AV Emission Level (dBμV/m)	AV Limit (dBμV/m)	Antenna polarization
1601.25	59.1	-11.5	47.6	54	Horizontal
4804.42	49.7	-0.5	49.2	54	Horizontal
7206.64	/	3.9	/	54	Horizontal
1601.21	/	-11.5	/	54	Vertical
4804.27	48.1	-0.5	47.6	54	Vertical
7206.59	/	3.9	/	54	Vertical

The field strength is calculated by adding the Antenna Factor, Cable Factor & Preamplifier. The basic equation with a sample calculation is as follows:

Final Test Level = Receiver Reading + Correction Factor

Correction Factor = Antenna Factor + Cable Loss – Preamplifier Factor.

Remark:

Harmonic Emissions was tested with filter (Product name: MICRO-TRONICS, model name: BRM50702), other radiated emissions were found below the reference noise level

When Peak emission level was below AV limit, the AV emission level did not be recorded.

Band Edge test Restricted Bands  
 Horizontal

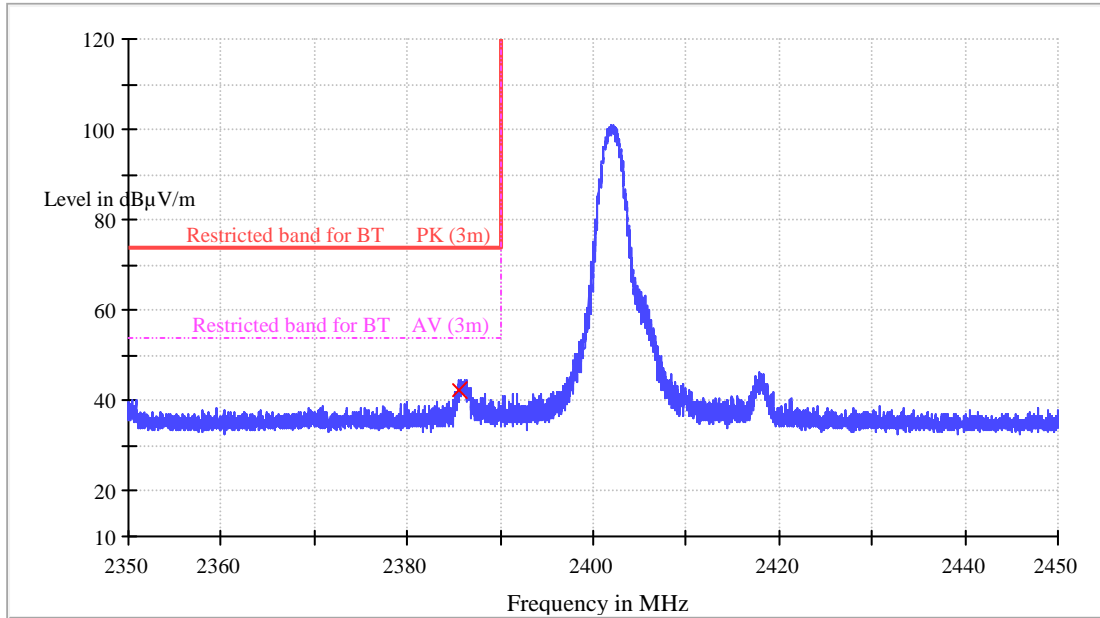

Frequency (MHz)	PK Reading Level (dBµV)	Correction factors (dB/m)	PK Emission Level (dBµV/m)	Limit (dBµV/m)
2385.56	47.0	-2.3	44.7	74.0

Remark:

Final Test Level = Receiver Reading + Correction Factor

Correction Factor = Antenna Factor + Cable Loss – Preamplifier Factor.

When Peak emission level was below AV limit, the AV emission level did not be recorded.

Vertical

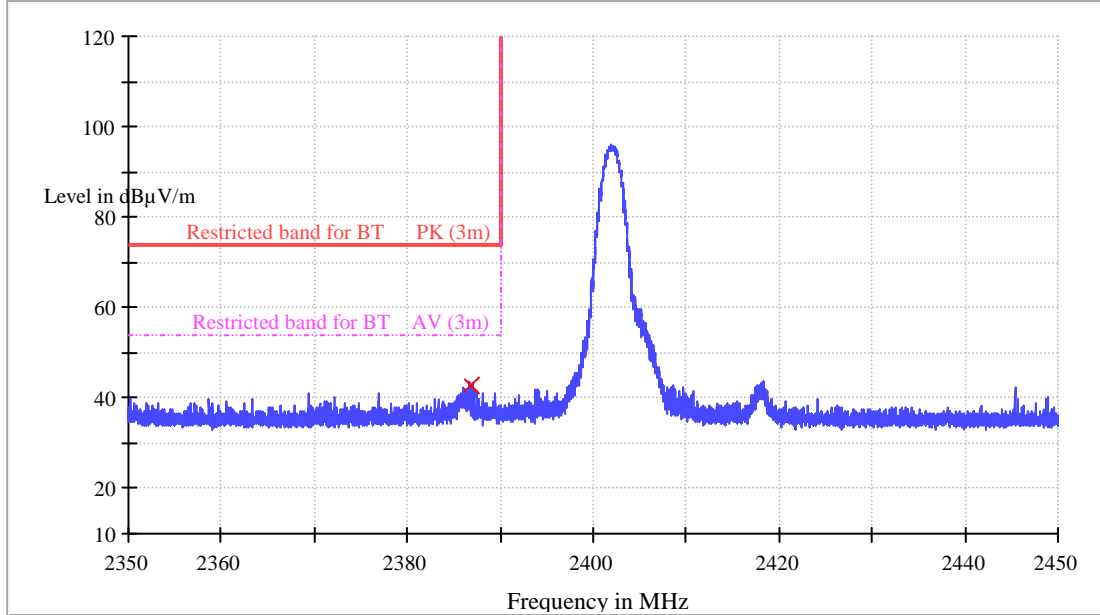

Frequency (MHz)	PK Reading Level (dBµV)	Correction factors (dB/m)	PK Emission Level (dBµV/m)	Limit (dBµV/m)
2386.72	46.1	-2.3	43.8	74.0

Remark:

Final Test Level = Receiver Reading + Correction Factor

Correction Factor = Antenna Factor + Cable Loss – Preamplifier Factor.

When Peak emission level was below AV limit, the AV emission level did not be recorded.

Test at Middle Channel (2.441 GHz) in transmitting status

9 kHz~30 MHz Field Strength of Unwanted Emissions. Quasi-Peak Measurement

The measurements with active loop antenna were greater than 20dB below the limit, so the test data were not recorded in the test report.

30 MHz~1 GHz Spurious Emissions .Quasi-Peak Measurement

**Vertical:**

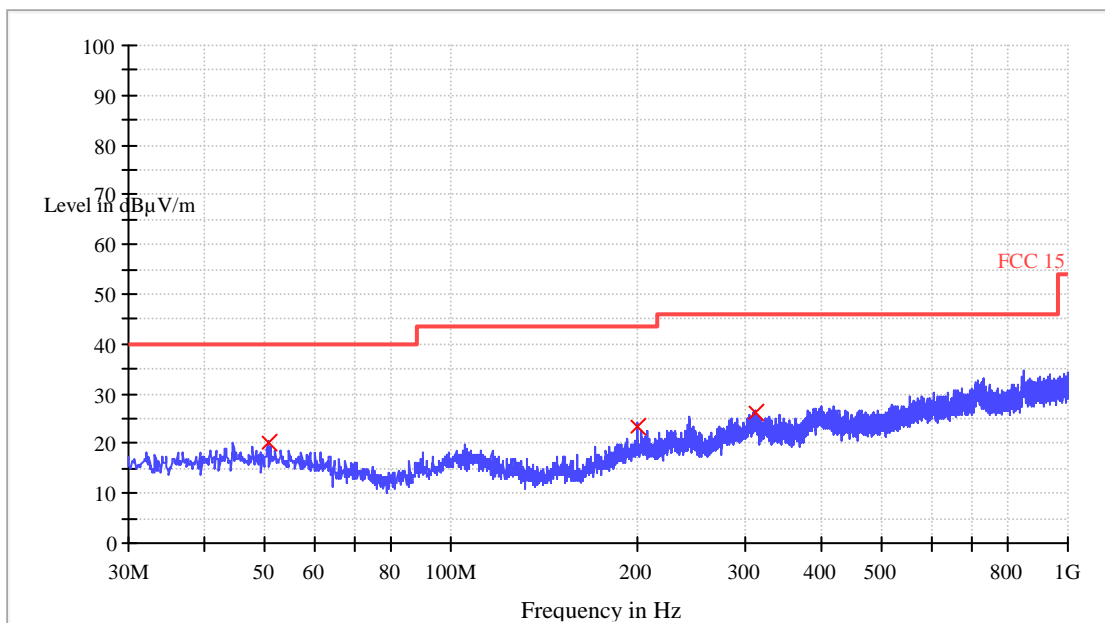

Frequency (MHz)	Receiver Reading Level (dBµV)	Correction factors (dB/m)	Emission Level (dBµV/m)	Limit (dBµV/m)
50.48	6.2	14.0	20.2	40.0
200.24	10.9	12.6	23.5	43.5
310.72	10.8	15.6	26.4	46.0

Remark:

Final Test Level =Receiver Reading + Correction Factor

Correction Factor = Antenna Factor + Cable Loss.

**Horizontal:**

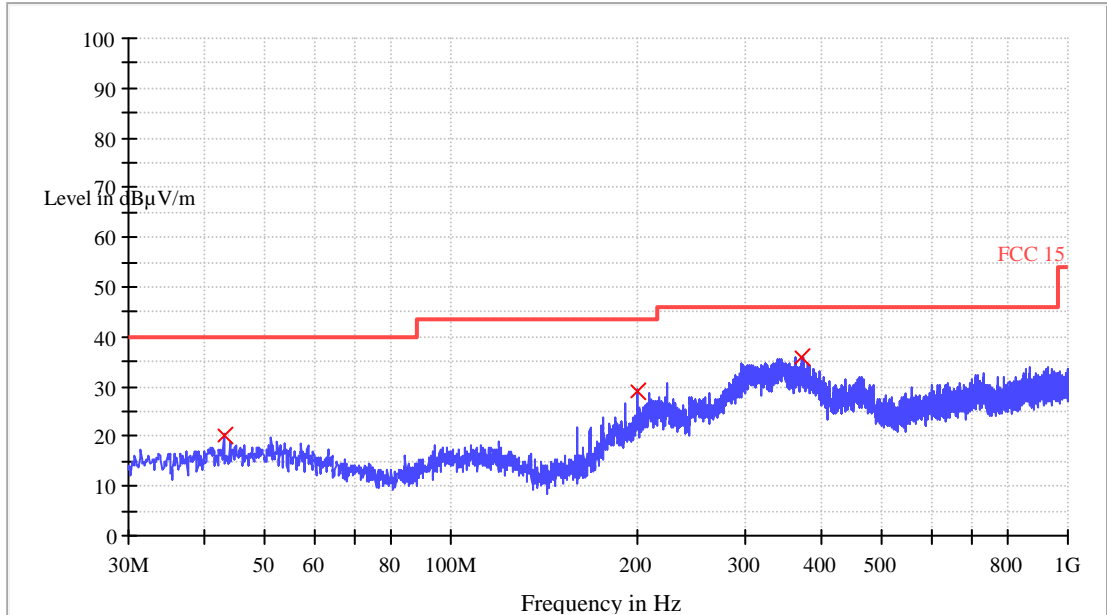

Frequency (MHz)	Receiver Reading Level (dBµV)	Correction factors (dB/m)	Emission Level (dBµV/m)	Limit (dBµV/m)
42.88	6.2	13.8	20.0	40.0
200.04	16.4	12.6	29.0	43.5
371.28	18.7	17.0	35.7	46.0

Remark:

Final Test Level = Receiver Reading + Correction Factor

Correction Factor = Antenna Factor + Cable Loss.

1~25 GHz Radiated Emissions. Peak & Average Measurement

**PK Measurement:**

Frequency (MHz)	PK Reading Level (dBμV)	Correction factors (dB/m)	PK Emission Level (dBμV/m)	PK Limit (dBμV/m)	Antenna polarization
1626.41	66.5	-11.3	55.2	74	Horizontal
4882.37	53.4	-0.5	52.9	74	Horizontal
7336.53	41.8	3.9	45.7	74	Horizontal
1626.34	60.7	-11.3	49.4	74	Vertical
4882.42	51.4	-0.5	50.9	74	Vertical
7336.41	39.7	3.9	43.6	74	Vertical

**AV Measurement:**

Frequency (MHz)	AV Reading Level (dBμV)	Correction factors (dB/m)	AV Emission Level (dBμV/m)	AV Limit (dBμV/m)	Antenna polarization
1626.41	59.6	-11.3	48.3	54	Horizontal
4882.37	/	-0.5	/	54	Horizontal
7336.53	/	3.9	/	54	Horizontal
1626.34	/	-11.3	/	54	Vertical
4882.42	/	-0.5	/	54	Vertical
7336.41	/	3.9	/	54	Vertical

The field strength is calculated by adding the Antenna Factor, Cable Factor & Preamplifier. The basic equation with a sample calculation is as follows:

Final Test Level = Receiver Reading + Correction Factor

Correction Factor = Antenna Factor + Cable Loss – Preamplifier Factor.

Remark:

Harmonic Emissions was tested with filter (Product name: MICRO-TRONICS, model name: BRM50702), other radiated emissions were found below the reference noise level

When Peak emission level was below AV limit, the AV emission level did not be recorded.

Test at Highest Channel (2.480 GHz) in transmitting status

9 kHz~30 MHz Field Strength of Unwanted Emissions. Quasi-Peak Measurement

The measurements with active loop antenna were greater than 20dB below the limit, so the test data were not recorded in the test report.

30 MHz~1 GHz Spurious Emissions .Quasi-Peak Measurement

**Vertical:**

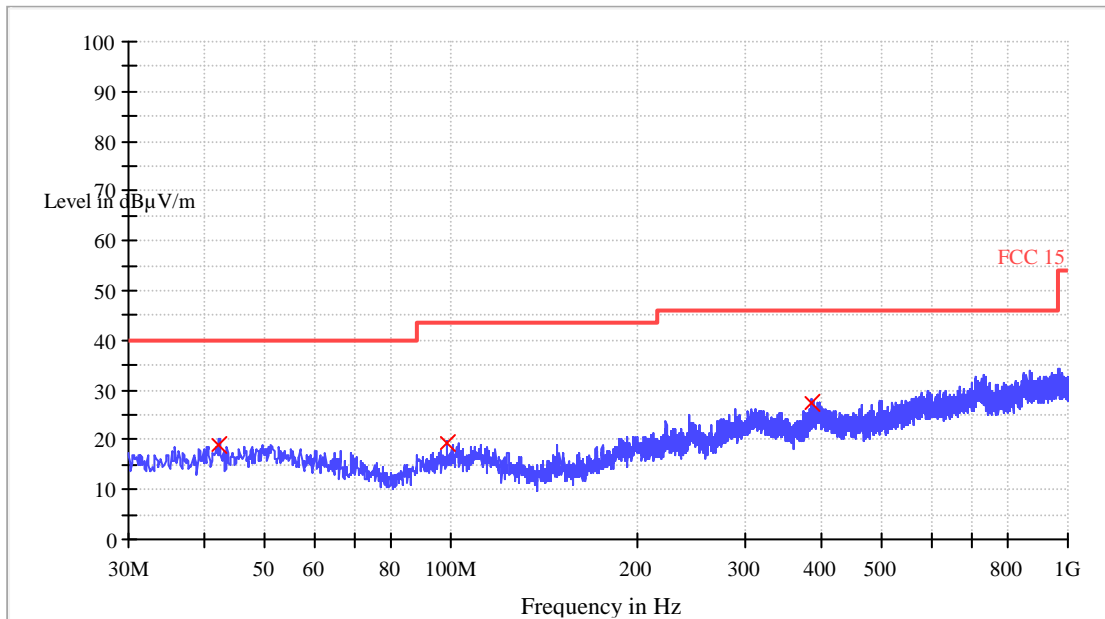

Frequency (MHz)	Receiver Reading Level (dBµV)	Correction factors (dB/m)	Emission Level (dBµV/m)	Limit (dBµV/m)
42.08	5.5	13.6	19.1	40.0
98.28	7.1	12.1	19.2	43.5
383.96	10.2	17.3	27.5	46.0

Remark:

Final Test Level =Receiver Reading + Correction Factor

Correction Factor = Antenna Factor + Cable Loss.



**Horizontal:**

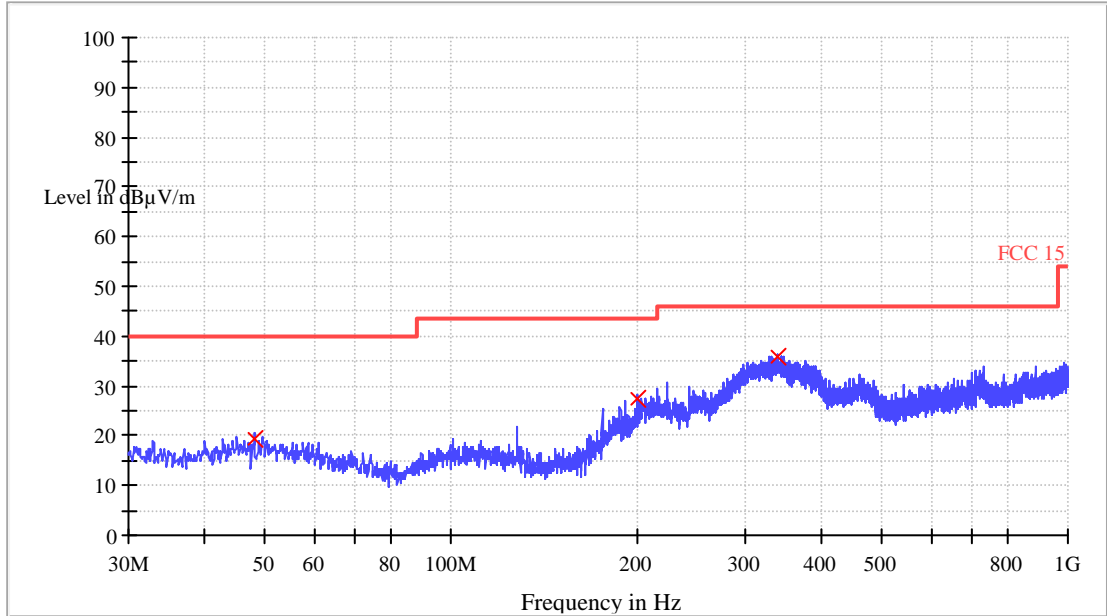

Frequency (MHz)	Receiver Reading Level (dBµV)	Correction factors (dB/m)	Emission Level (dBµV/m)	Limit (dBµV/m)
48.12	5.4	14.1	19.5	40.0
199.96	15.0	12.6	27.6	43.5
337.72	19.8	16.2	36.0	46.0

Remark:

Final Test Level = Receiver Reading + Correction Factor

Correction Factor = Antenna Factor + Cable Loss.

1~25 GHz Radiated Emissions. Peak & Average Measurement

1~25 GHz Radiated Emissions. Peak & Average Measurement

**PK Measurement:**

Frequency (MHz)	PK Reading Level (dBμV)	Correction factors (dB/m)	PK Emission Level (dBμV/m)	PK Limit (dBμV/m)	Antenna polarization
1652.40	65.8	-11.1	54.7	74	Horizontal
4960.25	51.7	-0.5	51.2	74	Horizontal
7440.12	42.9	3.3	46.2	74	Horizontal
1652.37	64.0	-11.1	52.9	74	Vertical
4959.41	49.6	-0.5	49.1	74	Vertical
7440.35	41.5	3.3	44.8	74	Vertical

**AV Measurement:**

Frequency (MHz)	AV Reading Level (dBμV)	Correction factors (dB/m)	AV Emission Level (dBμV/m)	AV Limit (dBμV/m)	Antenna polarization
1652.40	60.9	-11.1	49.8	54	Horizontal
4960.25	/	-0.5	/	54	Horizontal
7440.12	/	3.3	/	54	Horizontal
1652.37	/	-11.1	/	54	Vertical
4959.41	/	-0.5	/	54	Vertical
7440.35	/	3.3	/	54	Vertical

The field strength is calculated by adding the Antenna Factor, Cable Factor & Preamplifier. The basic equation with a sample calculation is as follows:

Final Test Level = Receiver Reading + Correction Factor

Correction Factor = Antenna Factor + Cable Loss – Preamplifier Factor.

Remark: Harmonic Emissions was tested with filter (Product name: MICRO-TRONICS, model name: BRM50702), other radiated emissions were found below the reference noise level

When Peak emission level was below AV limit, the AV emission level did not be recorded.

Band Edge test Restricted Bands  
 Horizontal

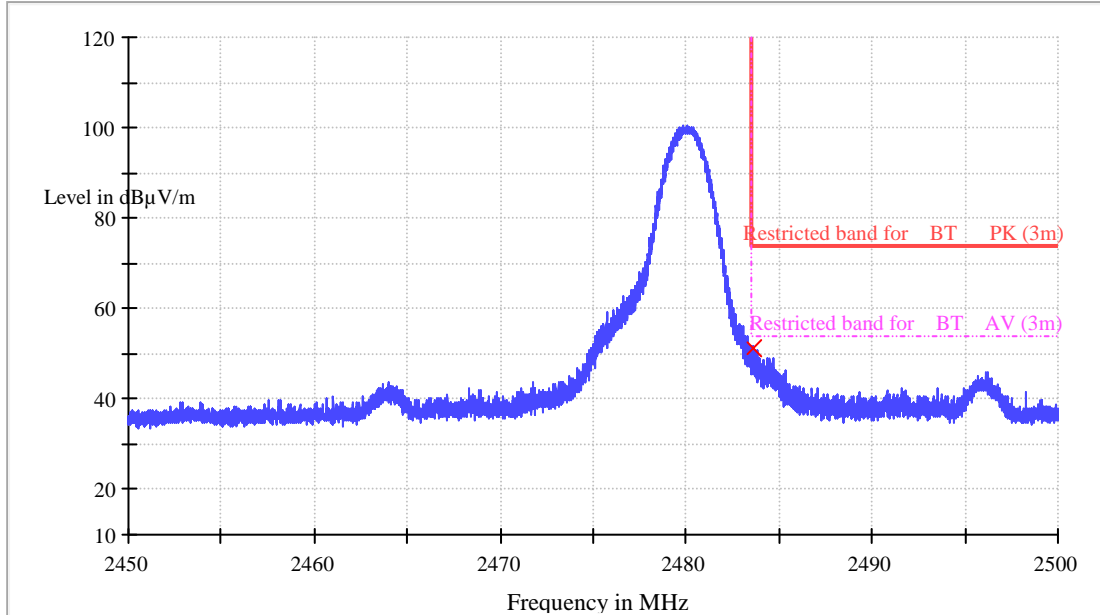

Frequency (MHz)	PK Reading Level (dBµV)	Correction factors (dB/m)	PK Emission Level (dBµV/m)	Limit (dBµV/m)
2483.55	53.7	-2.1	51.6	74.0

Remark:

Final Test Level = Receiver Reading + Correction Factor

Correction Factor = Antenna Factor + Cable Loss – Preamplifier Factor.

When Peak emission level was below AV limit, the AV emission level did not be recorded.

Vertical

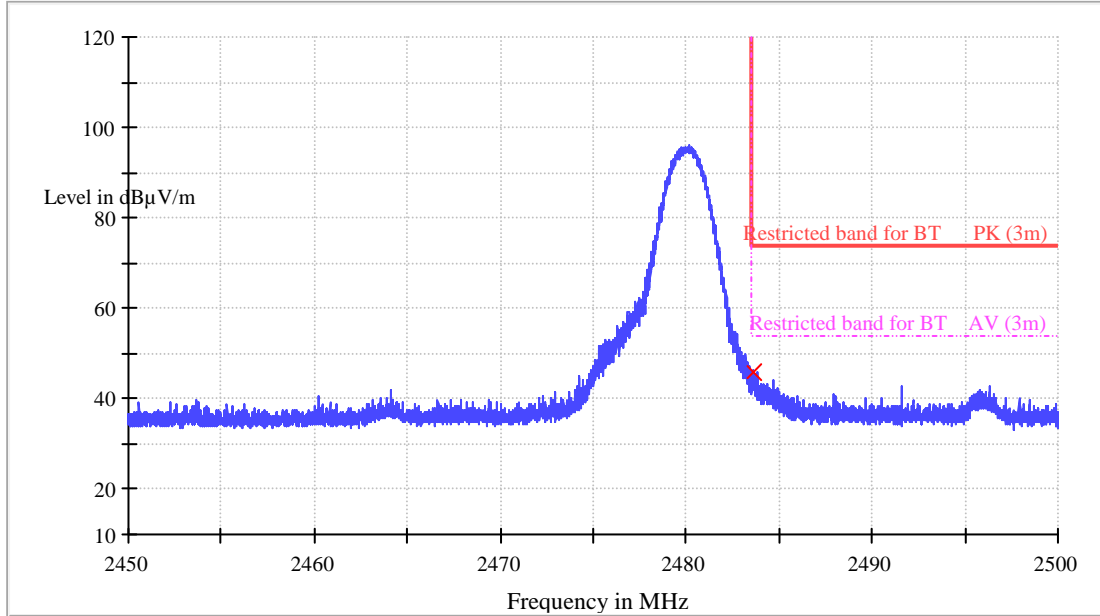

Frequency (MHz)	PK Reading Level (dBµV)	Correction factors (dB/m)	PK Emission Level (dBµV/m)	Limit (dBµV/m)
2483.66	48.6	-2.1	46.5	74.0

Remark:

Final Test Level = Receiver Reading + Correction Factor

Correction Factor = Antenna Factor + Cable Loss – Preamplifier Factor.

When Peak emission level was below AV limit, the AV emission level did not be recorded.

#### 4.8 Band Edges Requirement

Test Requirement:	FCC Part 15 C section 15.247  (d) In any 100 kHz bandwidth outside the frequency band in which the spread spectrum or digitally modulated intentional radiator is operating. The radio frequency power that is produced by the intentional radiator shall be at least 20 dB below that in the 100 kHz bandwidth within the band that contains the highest level of the desired power. Based on either an RF conducted or a radiated measurement. Provided the transmitter demonstrates compliance with the peak conducted power limits.
Frequency Band:	2400 MHz to 2483.5 MHz
Test Method:	ANSI C63.10: Clause 7.8.6 & 6.10
Test Status:	Pre-test the EUT in continuous transmitting mode at the lowest (2402 MHz), and highest (2480 MHz) channel and hopping mode with different data packet. Compliance test in continuous transmitting mode with Normal mode (DH5) as the worst case was found.
Test Configuration:	For Band Edges Emission in Radiated mode, Please refer to clause 4.7

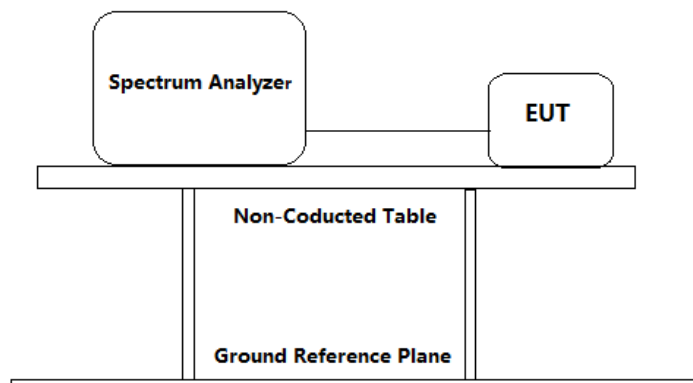

- Test Procedure: For Band Edges Emission in Radiated mode, Please refer to clause 4.7
1. Removed the antenna from the EUT and then connect a low RF cable from the antenna port to the spectrum analyzer or power meter.
  2. Set RBW of spectrum analyzer to 100 kHz and VBW of spectrum analyzer to 300 kHz with suitable frequency span including 100 kHz bandwidth from band edge.
  3. Repeated until all the test status was investigated.
  4. Reported the worst case.

**Test result with plots as follows:**

**For conducted mode:**

The band edges was measured and recorded Result:

The Lower Edges attenuated more than 20dB.

The Upper Edges attenuated more than 20dB.

Result plot as follows:

Normal mode (DH5):

Lowest channel: 2.402 GHz

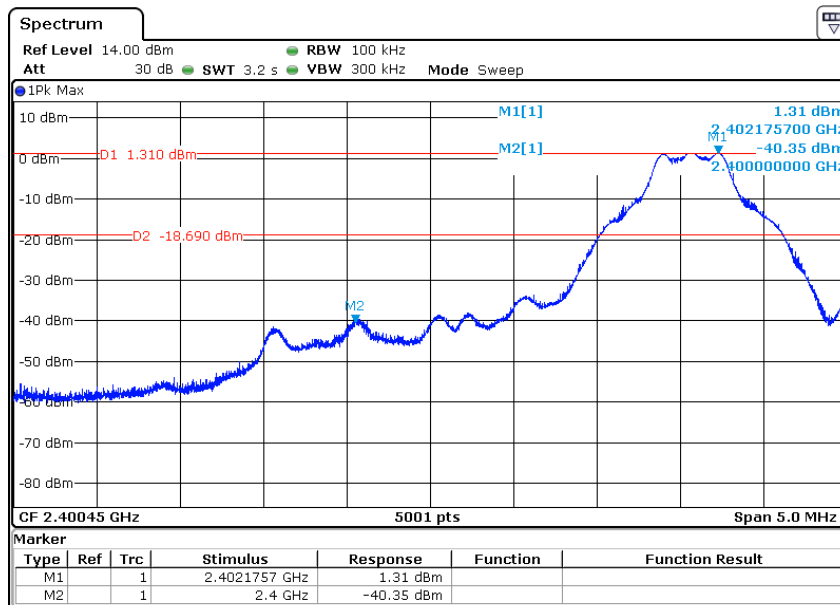

Hopping mode

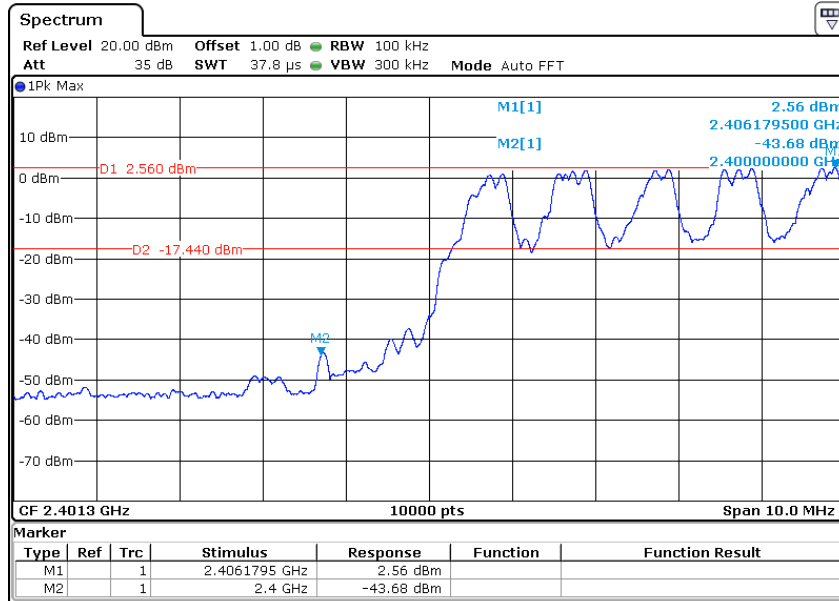

Highest Channel: 2.480 GHz

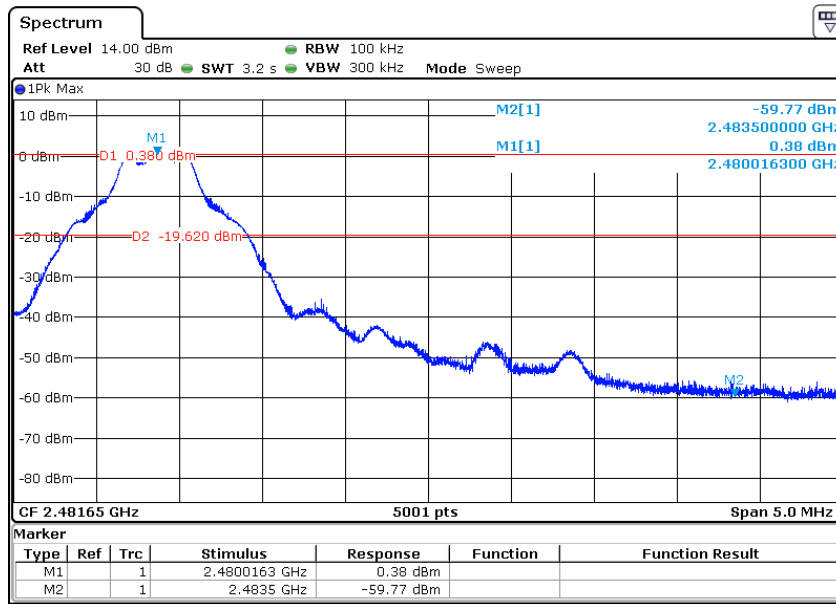

Hopping mode:

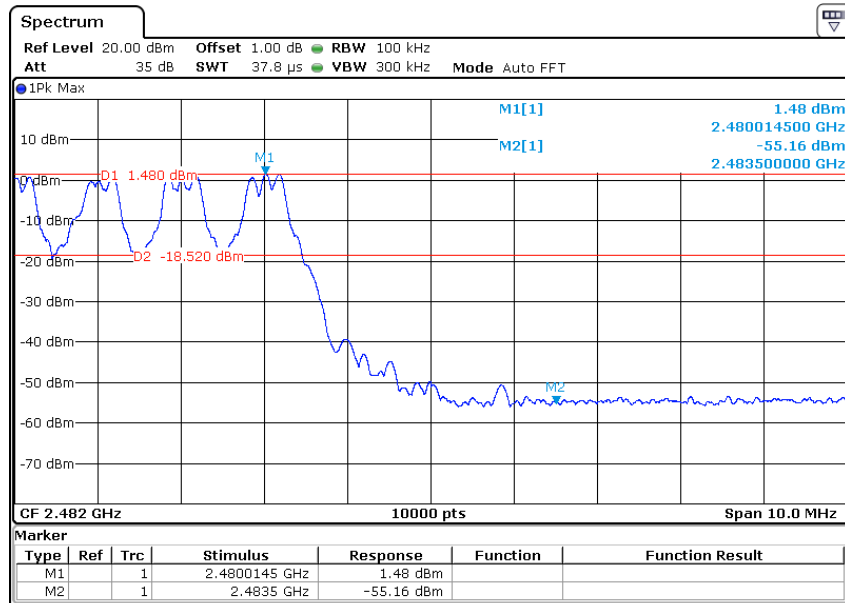

**For radiated mode:**

Please refer Clause 4.7 Radiated Emissions in Restricted Bands of this test report for more details. The resultant field strength in band edges meet the general radiated emission limit in section 15.209, which does not exceed 74 dBμV/m (Peak Limit) and 54dBμV/m (Average Limit).



**4.9 Conducted Emission Test**

Test Configuration:

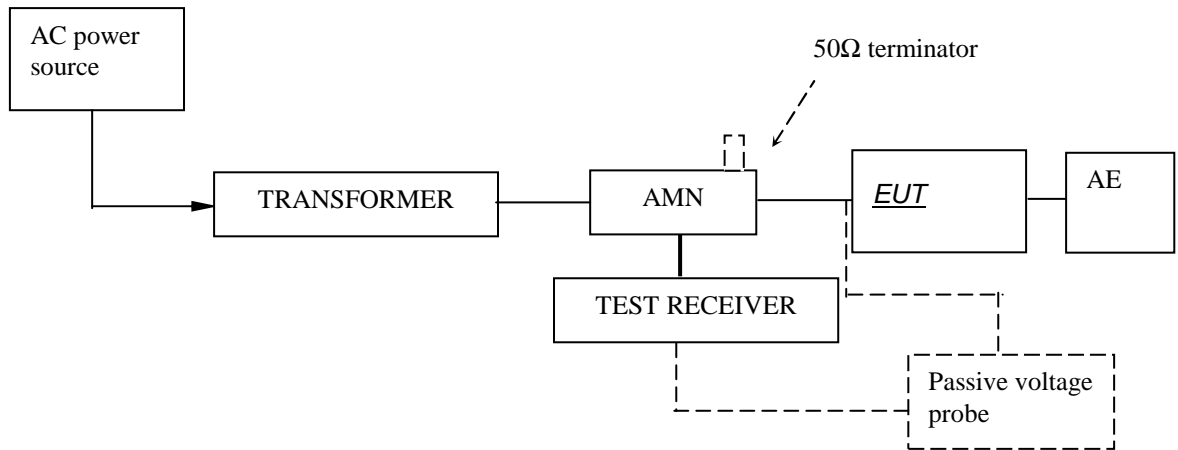

**Test Setup and Procedure**

Test was performed according to ANSI C63.10 Clause 6.2. The EUT was set to achieve the maximum emission level. The mains terminal disturbance voltage was measured with the EUT in a shielded room. The EUT was connected to AC power source through an Artificial Mains Network which provides a 50Ω linear impedance. Artificial hand is used if appropriate (for handheld apparatus). The load/control terminal disturbance voltage was measured with passive voltage probe if appropriate.

The table-top EUT was placed on a 0.8m high non-metallic table above earthed ground plane (Ground Reference Plane). And for floor standing EUT, was placed on a 0.1m high non-metallic supported on GRP. The EUT keeps a distance of at least 0.8m from any other of the metallic surface. The Artificial Mains Network is situated at a distance of 0.8m from the EUT.

During the test, mains lead of EUT excess 0.8m was folded back and forth parallel to the lead so as to form a horizontal bundle with a length between 0.3m and 0.4m.

The bandwidth of test receiver was set at 9 kHz. The frequency range from 150 kHz to 30MHz was checked.

Test Data

At main terminal: Pass

Tested Wire: Live

Operation Mode: transmitting mode

EDIT PEAK LIST (Final Measurement Results)				
Trace1:	FCC15QP			
Trace2:	FCC15AV			
Trace3:	---			
TRACE	FREQUENCY	LEVEL dBµV	DELTA LIMIT dB	
1 Quasi Peak	406 kHz	35.59 L1	-22.13	
2 Average	406 kHz	35.38 L1	-12.34	
2 Average	1.21 MHz	18.20 L1	-27.80	
2 Average	4.846 MHz	15.61 L1	-30.38	
2 Average	6.462 MHz	21.19 L1	-28.80	

Tested Wire: Neutral

Operation Mode: transmitting mode

EDIT PEAK LIST (Final Measurement Results)				
Trace1:	FCC15QP			
Trace2:	FCC15AV			
Trace3:	---			
TRACE	FREQUENCY	LEVEL dBµV	DELTA LIMIT dB	
2 Average	322 kHz	21.52 L1	-28.12	
1 Quasi Peak	330 kHz	29.28 L1	-30.16	
2 Average	406 kHz	34.74 L1	-12.98	
1 Quasi Peak	534 kHz	34.81 L1	-21.18	
2 Average	1.214 MHz	21.55 L1	-24.44	

Emission Curve

Tested Wire: Live

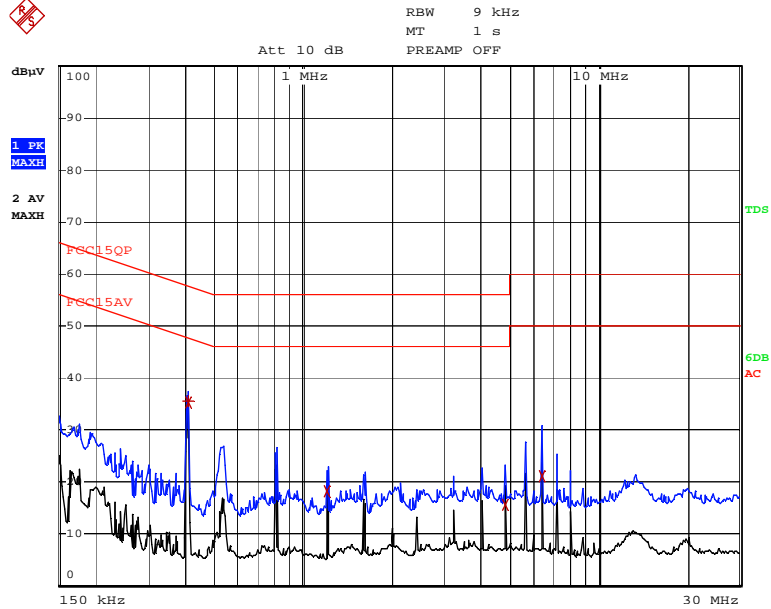

Tested Wire: Neutral

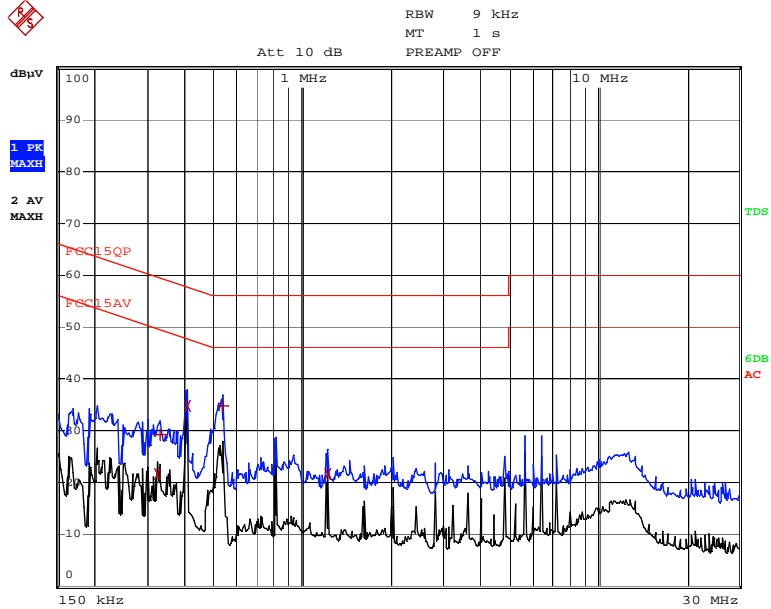

## 5.0 Test Equipment List

### Radiated Emission/Radio

Equipment No.	Equipment	Model	Manufacturer	Cal. Due date (MM-DD-YYYY)	Calibration Interval
EM030-04	3m Semi-Anechoic Chamber	9×6×6 m <sup>3</sup>	ETS·LINDGRE N	2018/5/1	1Y
EM031-02	EMI Test Receiver (9 kHz~7 GHz)	R&S ESR7	R&S	2018/3/27	1Y
EM031-03	Signal and Spectrum Analyzer (10 Hz~40 GHz)	R&S FSV40	R&S	2017/5/18	1Y
EM011-04	Loop antenna (9 kHz-30 MHz)	HFH2-Z2	R&S	2018/6/14	1Y
EM061-03	TRILOG Super Broadband test Antenna (30 MHz-1.5 GHz) (TX)	VULB 9161	SCHWARZBECK	2018/6/7	1Y
EM033-01	TRILOG Super Broadband test Antenna(30 MHz-3 GHz) (RX)	VULB 9163	SCHWARZBECK	2017/9/8	1Y
EM033-02	Bouble-Ridged Waveguide Horn Antenna (800 MHz-18 GHz)(RX)	R&S HF907	R&S	2018/6/7	1Y
EM033-03	High Frequency Antenna & preamplifier(18 GHz~26.5 GHz) (RX)	R&S SCU-26	R&S	2018/5/4	1Y
EM033-04	High Frequency Antenna & preamplifier (26 GHz-40 GHz)	R&S SCU-40	R&S	2018/5/4	1Y
EM031-02-01	Coaxial cable(9 kHz-1 GHz)	N/A	R&S	2018/5/18	1Y
EM033-02-02	Coaxial cable(1 GHz-18 GHz)	N/A	R&S	2018/5/18	1Y
EM033-04-02	Coaxial cable(18 GHz~40 GHz)	N/A	R&S	2018/5/25	1Y
EM031-01	Signal Generator (9 kHz~6 GHz)	SMB100A	R&S	2017/7/30	1Y
SZ180-10	Signal Generator (10MHz-40GHz)	68369B	Wiltron	2017/5/23	1Y
EM040-01	Band Reject/Notch Filter	WRHFV	Wainwright	N/A	1Y
EM040-02	Band Reject/Notch Filter	WRCGV	Wainwright	N/A	1Y
EM040-03	Band Reject/Notch Filter	WRCGV	Wainwright	N/A	1Y
EM022-03	2.45 GHz Filter	BRM50702	Micro-Tronics	2018/5/9	1Y
SA016-16	Programmable Temperature & Humidity Test Chamber	MHU-800LJ	TERCHY	2017/10/21	1Y
SA016-22	Climatic Test Chamber	C7-1500	Vötsch	2017/10/21	1Y
SA012-74	Digital Multimeter	FLUKE175	FLUKE	2017/10/13	1Y
EM010-01	Regulated DC Power supply	PAB-3003A	GUANHUA	N/A	1Y
SA040-22	Regulated DC Power supply	IT6721	ITECH	2017/9/18	1Y
EM084-06	Audio Analyzer	8903B	HP	2018/4/3	1Y
EM084-07	Modulation Analyzer	8901B	HP	2018/6/15	1Y
EM045-01-01	EMC32 software (RE/RS)	V10.01.00	R&S	N/A	N/A
EM045-01-09	EMC32 software (328/893)	V9.26.01	R&S	N/A	N/A

### Conducted emission at the mains terminals

Equipment No.	Equipment	Model	Manufacturer	Cal. Due date (YYYY-MM-DD)	Calibration Interval
EM080-05	EMI receiver	ESCI	R&S	2017/7/26	1Y
EM006-05	LISN	ENV216	R&S	2017/9/18	1Y
EM006-06	LISN	ENV216	R&S	2017/9/18	1Y
EM006-06-01	Coaxial cable	/	R&S	2018/4/6	1Y
EM004-04	EMC shield Room	8m×3m×3m	Zhongyu	2018/1/23	1Y