

TEST REPORT

FCC ID: PVEMOTICAMX2

Applicant : Motic China Group Co., Ltd
 Address : MOTIC BLDG, TORCH HI-TECH INDUSTRIAL DEV ZONE
 XIAMEN FUJIAN,361006,CN

Equipment under Test (EUT):

Name	:	Moticam X ² Smart Camera
Model	:	MOTICAM X ²
Trademark	:	Motic

Standards : FCC PART 15, SUBPART C : 2013 (Section 15.247) /

Report No. : T1840041 05

Date of Test : November 03, November 06, 2014

Date of Issue : November 06, 2014

Test Result :	PASS *
----------------------	---------------

* In the configuration tested, the EUT complied with the standards specified above

Authorized Signature



(Mark Zhu)
 General Manager

The manufacture should ensure that all the products in series production are in conformity with the product sample detailed in this report.

If the product in this report is used in any configuration other than that detailed in the report, the manufacturer must ensure the new system complies with all relevant standards. Any mention of Shenzhen Certification Technology Service Co., Ltd. Or test done by Shenzhen Certification Technology Service Co., Ltd. Approvals in connection with, distribution or use of the product described in this report must be approved by Shenzhen Certification Technology Service Co., Ltd. Approvals in writing.

TABLE OF CONTENT

Description	Page
1 General Information -----	4
1.1 Description of Device (EUT)-----	4
1.2 Description of Test Facility-----	5
2 EMC Equipment List-----	5
3 Test Procedure-----	7
4 Summary of Measurement -----	8
4.1 Summary of test result -----	8
4.2 Test connection -----	8
4.3 Assistant equipment used for test-----	9
4.4 Test mode-----	9
4.5 Channel list-----	10
4.6 Test Conditions -----	10
4.7 Measurement Uncertainty (95% confidence levels, k=2)-----	10
5 Spurious Emission -----	11
5.1 Radiation Emission-----	11
5.1.1 Radiation Emission Limits(15.209) -----	11
5.1.2 Test Setup -----	11
5.1.3 Test Procedure -----	13
5.1.4 Test Equipment Setting For emission test Result -----	14
5.1.5 Test Condition -----	14
5.1.6 Test Result-----	14
6 POWER LINE CONDUCTED EMISSION -----	29
6.1 Conducted Emission Limits(15.207) -----	29
6.2 Test Setup -----	29
6.3 Test Procedure -----	30
6.4 Test Results -----	30
7 Conducted Maximum Output Power -----	33
7.1 Test limit-----	33
7.2 Test Procedure -----	33
7.3 Test Setup -----	33
7.4 Test Results -----	33
8 PEAK POWER SPECTRAL DENSITY -----	35
8.1 Test limit-----	35
8.1.1 Please refer section15.247. -----	35
8.2 Method of measurement -----	35
8.3 Test Setup -----	35
8.4 Test Results -----	36
9 Bandwidth-----	43
9.1 Test limit-----	43
9.2 Method of measurement -----	43
9.3 Test Setup -----	43
9.4 Test Results -----	43
10 Band Edge Check-----	51
10.1 Test limit-----	51
10.2 Test Procedure -----	51

10.3	Test Setup -----	51
10.4	Test Result-----	51
11	Antenna Requirement -----	68
11.1	Standard Requirement-----	68
11.2	Antenna Connected Construction-----	68
11.3	Result -----	68
12	Photographs of Test Setup -----	69
13	Photographs of EUT -----	71

1 General Information

1.1 Description of Device (EUT)

Trade Name	:	Motic
EUT	:	Moticam X Smart Camera
Model No.	:	MOTICAM X ²
DIFF.	:	N/A
Antenna Type	:	Integral Antenna, max gain 2.5 dBi.
Operation Frequency	:	IEEE 802.11b: 2412MHz-2462MHz IEEE 802.11g: 2412MHz-2462MHz IEEE 802.11n HT20: 2412-2462MHz IEEE 802.11n HT40: 2422-2452MHz
Channel number	:	IEEE 802.11b/g: 11 Channels IEEE 802.11n HT20 2.4GHz band: 11 Channels IEEE 802.11n HT40 2.4GHz band: 7 Channels
Modulation type	:	IEEE 802.11b: DSSS(CCK,DQPSK,DBPSK) IEEE 802.11g: OFDM(64QAM, 16QAM, QPSK, BPSK) IEEE 802.11n :OFDM(64QAM, 16QAM, QPSK, BPSK)
Power Supply	:	DC3.7V from battery or DC 5V from adapter for charging.
Adapter	:	W&T-AD18W050100
Applicant	:	Motic China Group Co., Ltd
Address	:	MOTIC BLDG, TORCH HI-TECH INDUSTRIAL DEV ZONE XIAMEN FUJIAN,361006,CN
Manufacturer	:	Motic China Group Co., Ltd
Address	:	MOTIC BLDG, TORCH HI-TECH INDUSTRIAL DEV ZONE XIAMEN FUJIAN,361006,CN

1.2 Description of Test Facility

Alpha Product Testing Laboratory
 Building B, East Area of Nanchang Second, Industrial Zone, Gushu 2nd Road,
 Bao'an, Shenzhen, China

August 11, 2014 File on Federal Communication Commission
 Registration Number: 203110

July 18, 2014 Certificated by IC
 Registration Number: 12135A

2 EMC Equipment List

Equipment	Manufacture	Model No.	Serial No.	Last cal.	Cal Interval
3m Semi-Anechoic	ETS-LINDGREN	N/A	SEL0017	2015.01.19	1 Year
Spectrum analyzer	Agilent	E4407B	MY49510055	2015.01.19	1 Year
Receiver	R&S	ESCI	101165	2015.01.19	1 Year
Receiver	R&S	ESCI	101202	2015.01.19	1 Year
Bilog Antenna	SCHWARZBECK	VULB 9168	9168-438	2015.01.21	1 Year
Horn Antenna	SCHWARZBECK	BBHA 9120 D	BBHA 9120 D(1201)	2015.01.21	1 Year
Horn Antenna	SCHWARZBECK	BBHA 9170	BBHA 9170 D(1432)	2015.01.21	1 Year
Active Loop Antenna	Beijing Daze	ZN30900A	SEL0097	2015.01.21	1 Year
L.I.S.N.	SCHWARZBECK	NSLK8126	8126466	2015.01.19	1 Year
Cable	Resenberger	SUCOFLEX 104	MY6562/4	2015.01.19	1 Year
Cable	Resenberger	SUCOFLEX 104	309972/4	2015.01.19	1 Year
Cable	Resenberger	SUCOFLEX 104	329112/4	2015.01.19	1 Year
Power Meter	Anritsu	ML2487A	6K00001491	2015.01.19	1 Year

Power sensor	Anritsu	ML2491A	32516	2015.01.19	1 Year
Pre-amplifier	SCHWARZBECK	BBV9743	9743-019	2015.01.19	1 Year
Pre-amplifier	Quietek	AP-180C	CHM-0602012	2015.01.19	1 Year

3 Test Procedure

POWER LINE CONDUCTED INTERFERENCE: The test procedure used was ANSI Standard C63.4-2003 using a 50 u H LISN. Both Lines were observed. The bandwidth of the receiver was 10kHz with an appropriate sweep speed. The ambient temperature of the EUT was 25°C with a humidity of 58%.

RADIATION INTERFERENCE: The test procedure used was ANSI Standard C63.4-2003 using a ANRITSU spectrum analyzer with a pre-selector. The analyzer was calibrated in dB above a micro volt at the output of the antenna. The resolution bandwidth was 100kHz and the video bandwidth was 300 kHz up to 1 GHz and 1 MHz with a video BW of 3MHz above 1 GHz. The ambient temperature of the EUT was 25°C with a humidity of 58%.

FORMULA OF CONVERSION FACTORS: The Field Strength at 3m was established by adding the meter reading of the spectrum analyzer (which is set to read in units of dBuV) to the antenna correction factor supplied by the antenna manufacturer and cable loss. The antenna correction factors and cable loss are stated in terms of dB. The gain of the Pre-selector was accounted for in the Spectrum Analyzer Meter Reading.

Example:

Freq (MHz) METER READING + ACF + CABLE = FS

33.20 dBuV + 10.36 dB + 0.9 dB= 44.46 dBuV/m @ 3m

ANSI STANDARD C63.4-2003 10.1.7 MEASUREMENT PROCEDURES: The EUT was placed on a table 80 cm high and with dimensions of 1m by 1.5m. The EUT was placed in the center of the table (1.5m side). The table used for radiated measurements is capable of continuous rotation. When an emission was found, the table was rotated to produce the maximum signal strength. At this point, the antenna was raised and lowered from 1m to 4m. The antenna was placed in both the horizontal and vertical planes. The situation was similar for the conducted measurement except that the table did not rotate. The EUT was setup as described in ANSI Standard C63.4-2003 10.1.7 with the EUT 40 cm from the vertical ground wall.

4 Summary of Measurement

4.1 Summary of test result

Test Item	Test Requirement	Standards Paragraph	Result
Spurious Emission	FCC PART 15 : 2013	Section 15.247&15.209	Compliance
Conduction Emission	FCC PART 15: 2013	Section 15.207	Compliance
Bandwidth Test	FCC PART 15:2013	Section 15.247	Compliance
Peak Power	FCC PART 15:2013	Section 15.247	Compliance
Power Density	FCC PART 15:2013	Section 15.247	Compliance
Band Edge	FCC PART 15:2013	Section 15.247	Compliance
Antenna Requirement	FCC PART 15 : 2013	Section 15.203	Compliance

Note: The EUT has been tested as an independent unit. And Continual Transmitting in maximum power

Note2: The EUT was programmed to be in continuously transmitting mode and the transmit duty cycle is not less than 98%.”

4.2 Test connection

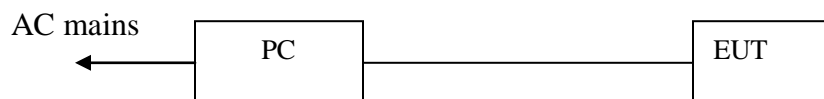

4.3 Assistant equipment used for test

Description	:	Notebook
Manufacturer	:	ACER
Model No.	:	ZQT

4.4 Test mode

Tested mode, channel, and data rate information			
Mode	data rate (Mbps)(see Note)	Channel	Frequency (MHz)
IEEE 802.11b	1	Low :CH1	2412
	1	Middle: CH6	2437
	1	High: CH11	2462
IEEE 802.11g	6	Low :CH1	2412
	6	Middle: CH6	2437
	6	High: CH11	2462
IEEE 802.11 n/HT20 with 2.4G	6.5	Low :CH1	2412
	6.5	Middle: CH6	2437
	6.5	High: CH11	2462
IEEE 802.11 n/HT40 with 2.4G	13.5	Low :CH3	2422
	13.5	Middle: CH6	2437
	13.5	High: CH9	2452

Note: According exploratory test, EUT will have maximum output power in those data rate. so those data rate were used for all test.

4.5 Channel list

For IEEE 802.11b/g and IEEE 802.11n/HT20 with 2.4G					
Channel	Frequency (MHz)	Channel	Frequency (MHz)	Channel	Frequency (MHz)
CH1	2412	CH5	2432	CH9	2452
CH2	2417	CH6	2437	CH10	2457
CH3	2422	CH7	2442	CH11	2462
CH4	2427	CH8	2447		

For IEEE 802.11n/HT40 with 2.4G					
Channel	Frequency (MHz)	Channel	Frequency (MHz)	Channel	Frequency (MHz)
---	---	CH5	2432	CH9	2452
---	---	CH6	2437		
CH3	2422	CH7	2442		
CH4	2427	CH8	2447		

4.6 Test Conditions

Temperature range	21-25°C
Humidity range	40-75%
Pressure range	86-106kPa

4.7 Measurement Uncertainty (95% confidence levels, k=2)

Item	MU	Remark
Uncertainty for Power point Conducted Emissions Test	2.42dB	
Uncertainty for Radiation Emission test in 3m chamber (below 30MHz)	2.13 dB	Polarize: V
	2.57dB	Polarize: H
Uncertainty for Radiation Emission test in 3m chamber (30MHz to 1GHz)	3.54dB	Polarize: V
	4.1dB	Polarize: H
Uncertainty for Radiation Emission test in 3m chamber (1GHz to 25GHz)	2.08dB	Polarize: H
	2.56dB	Polarize: V
Uncertainty for radio frequency	1×10 ⁻⁹	
Uncertainty for conducted RF Power	0.65dB	
Uncertainty for temperature	0.2°C	
Uncertainty for humidity	1%	
Uncertainty for DC and low frequency voltages	0.06%	

5 Spurious Emission

5.1 Radiation Emission

5.1.1 Radiation Emission Limits(15.209)

Frequencies (MHz)	Field Strength (microrvolts/meter)	Measurement Distance (meters)
0.009~0.490	2400/F(KHz)	300
0.490~1.705	24000/F(KHz)	30
1.705~30.0	30	30
30~88	100	3
88~216	150	3
216~960	200	3
Above 960	500	3

Harmonic emissions limits comply with below 54 dBuV/m at 3m. Other emissions radiated outside of the specified frequency bands, except for harmonics, shall be attenuated by at least 50 dB below the level of the fundamental or comply with the radiated emissions limits specified in section 15.209(a) limit in the table below has to be followed.

NOTE:

- a) The tighter limit applies at the band edges.
- b) Emission Level(dB uV/m)=20log Emission Level(Uv/m)

5.1.2 Test Setup

See the next page

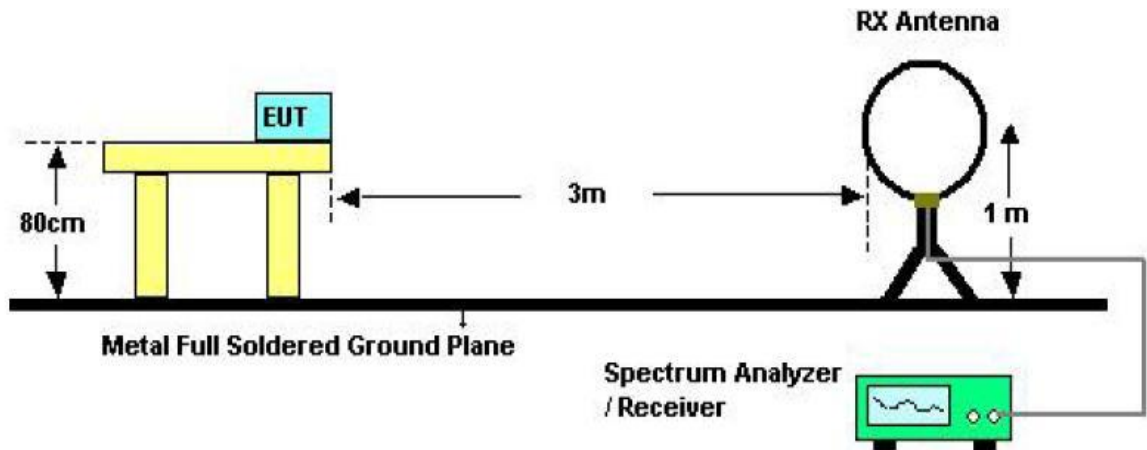

Below 30MHz Test Setup

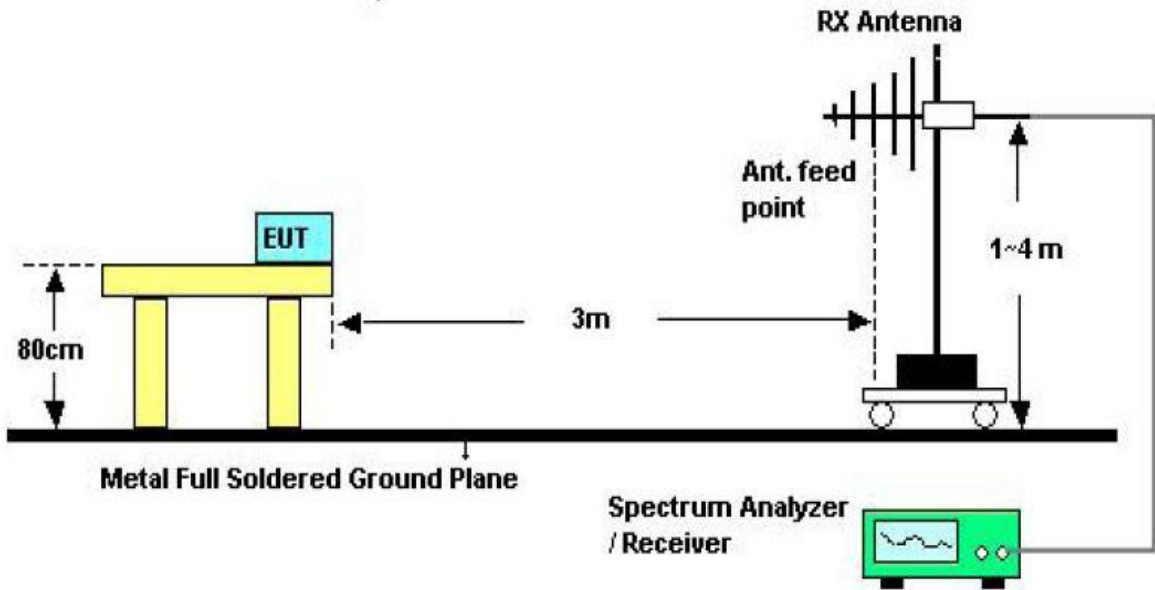

Above 30MHz Test Setup

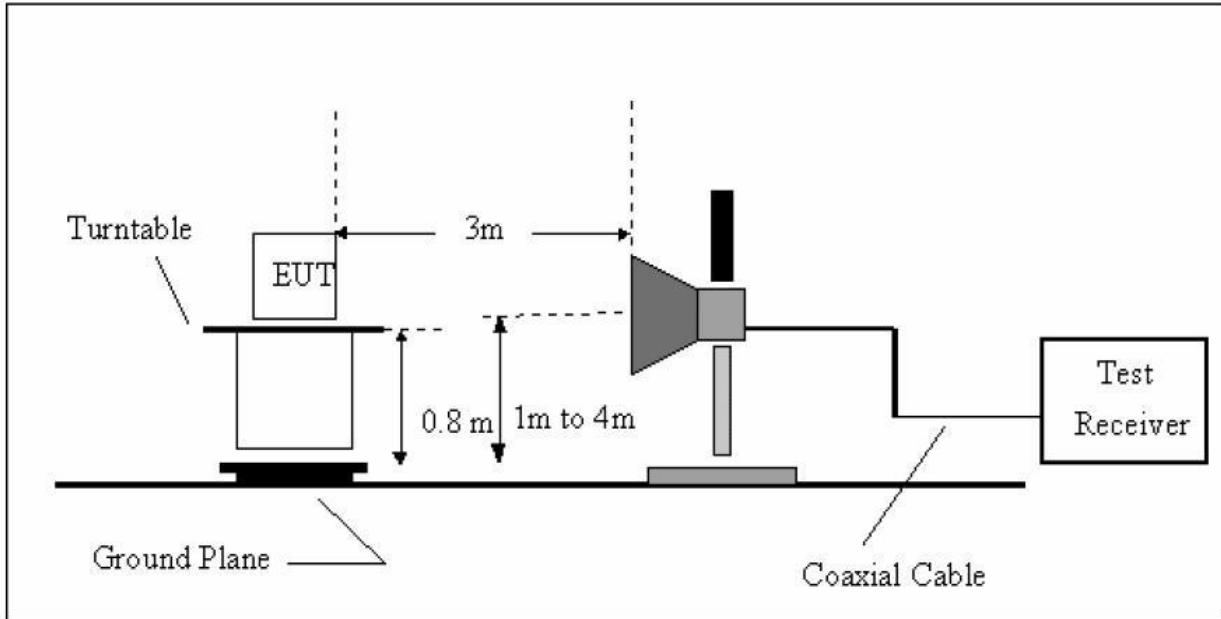

Above 1GHz Test Setup

5.1.3 Test Procedure

- a) The measuring distance of 3m shall be used for measurements at frequency up to 1GHz and above 1GHz, The EUT was placed on a rotating 0.8 m high above ground, The table was rotated 360 degrees to determine the position of the highest radiation
- b) The Test antenna shall vary between 1m and 4m, Both Horizontal and Vertical antenna are set of make measurement.
- c) The initial step in collecting conducted emission data is a spectrum analyzer Peak detector mode pre-scanning the measurement frequency range. Significant Peaks are then marked. and then Qusia Peak Detector mode premeasured
- d) If Peak value comply with QP limit Below 1GHz. The EUT deemed to comply with QP limit. But the Peak value and average value both need to comply with applicable limit above 1GHz.
- e) For the actual test configuration, please see the test setup photo.

5.1.4 Test Equipment Setting For emission test Result

9KHz~150KHz	RBW 200Hz	VBW 1KHz
150KHz~30MHz	RBW 9KHz	VBW 30KHz
30MHz~1GHz	RBW 120KHz	VBW 300KHz
Above 1GHz	RBW 1MHz	VBW 3MHz

5.1.5 Test Condition

Continual Transmitting in maximum power.

5.1.6 Test Result

We have scanned the 9KHz from 25GHz to the EUT.
Detailed information please see the following page.

From 9KHz to 30MHz: Conclusion: PASS

Note: The amplitude of spurious emissions which are attenuated by more than 20dB below the permissible value has no need to be reported.

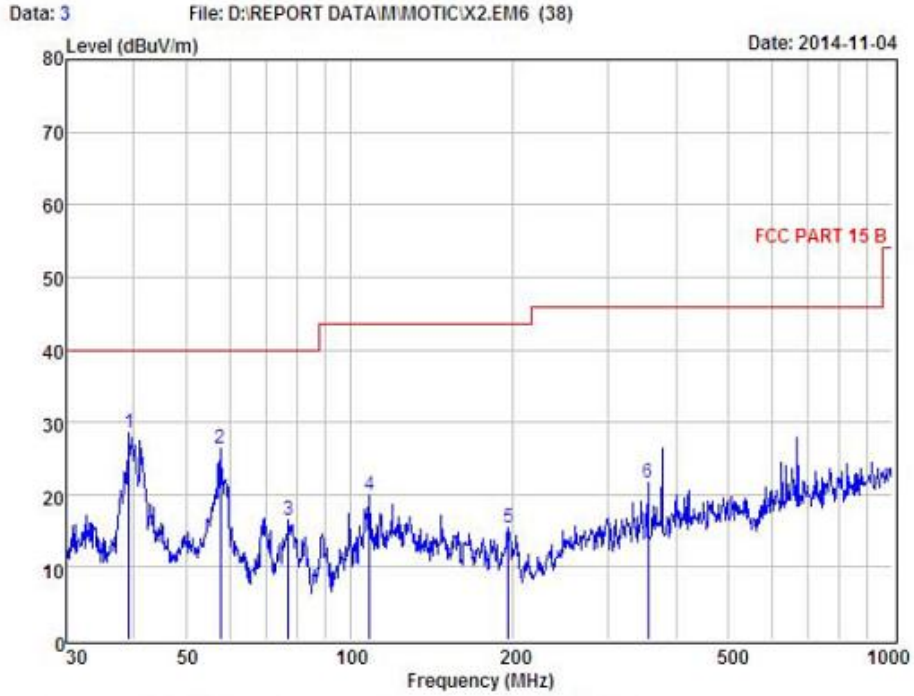

Condition : FCC PART 15 B 3m POL: HORIZONTAL
 EUT : Moticam X2Smart Camera
 Model No : Moticam X2
 Test Mode :
 Power : DC 5V from adapter with AC 120V/60Hz
 Test Engineer :
 Remark :
 Temp : 24.2°C
 Hum : 54%

Item	Freq MHz	Read Level dBUV	Antenna Factor dB	Preamp Factor dB	Cable Loss dB	Level dBUV	Limit dBUV	Margin dBUV	Remark
1	39.16	40.19	14.07	25.81	0.13	28.58	40.00	-11.42	Peak
2	57.80	40.69	12.91	27.36	0.23	26.47	40.00	-13.53	Peak
3	77.05	33.46	9.60	26.78	0.29	16.57	40.00	-23.43	Peak
4	108.65	35.31	11.13	26.86	0.41	19.99	43.50	-23.51	Peak
5	195.82	31.87	10.13	26.96	0.48	15.52	43.50	-27.98	Peak
6	355.43	31.47	13.91	24.28	0.63	21.73	46.00	-24.27	Peak

Remark: Level = Read Level + Antenna Factor - Preamp Factor + Cable Loss

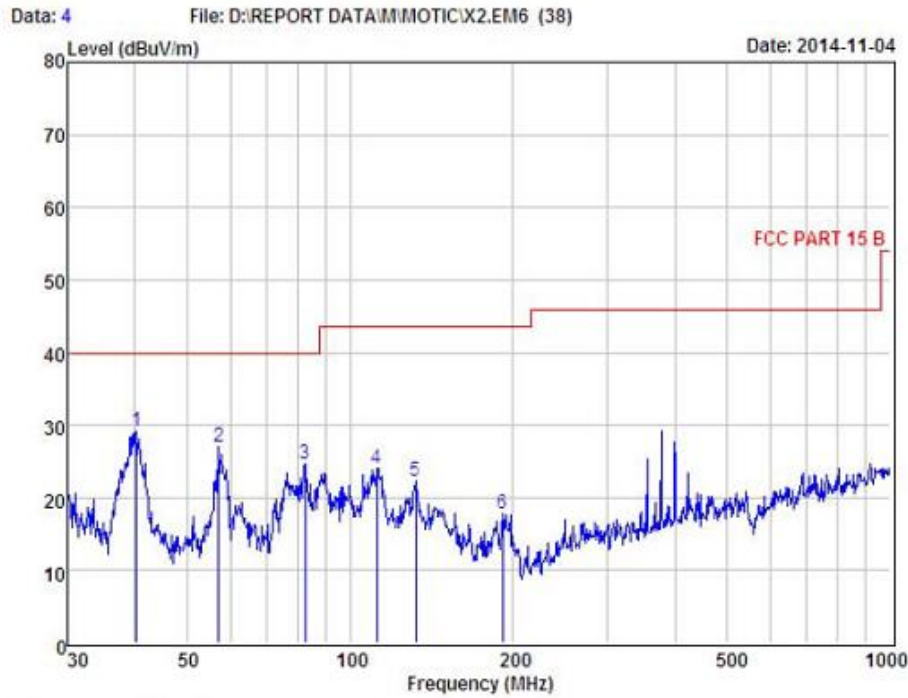

Condition : FCC PART 15 B 3m POL: VERTICAL
 EUT : Moticam X2Smart Camera
 Model No : Moticam X2
 Test Mode :
 Power : DC 5V from adapter with AC 120V/60Hz
 Test Engineer :
 Remark :
 Temp : 24.2°C
 Hum : 54%

Item	Freq MHz	Read Level dBuV	Antenna Factor dB	Preamp Factor dB	Cable Loss dB	Level dBuV	Limit dBuV	Margin dBuV	Remark
1	40.28	40.78	14.07	25.81	0.18	29.22	40.00	-10.78	Peak
2	57.19	41.30	12.91	27.36	0.14	26.99	40.00	-13.01	Peak
3	82.65	41.83	9.35	26.80	0.20	24.58	40.00	-15.42	Peak
4	112.13	38.85	11.50	26.87	0.47	23.95	43.50	-19.55	Peak
5	132.22	35.74	12.93	26.89	0.57	22.35	43.50	-21.15	Peak
6	191.75	33.79	10.36	26.95	0.58	17.78	43.50	-25.72	Peak

Remark: Level = Read Level + Antenna Factor - Preamp Factor + Cable Loss

Remark1: The EUT has been tested for X,Y and Z Axis, and only worst data of X Axis was listed in report.
 Remark2: All modes have been tested, and only worst data of 802.11n HT20 mode, Channel 2437MHz was listed in this report.

From 1G-25GHz
IEEE 802.11b

EUT	Moticam X Smart Camera	Model Name	MOTICAM X 2
Temperature	26°C	Relative Humidity	56%
Pressure	960hPa	Test voltage	DC 5V From adapter
Test Mode	TX Low		

Freq. (MHz)	Ant. Pol H/V	Peak Reading (dBuV)	AV Reading (dBuV)	Ant. / CL CF (dB)	Actual Fs		Peak Limit (dBuV/m)	AV Limit (dBuV/m)	Margin (dB)	Remark
					Peak (dBuV/m)	AV (dBuV/m)				
1103	V	43.18	---	-11.24	31.94	---	74	54	42.06	Peak
4824	V	41.25	---	0.64	41.89	---	74	54	32.11	Peak
N/A										

EUT	Moticam X Smart Camera	Model Name	MOTICAM X 2
Temperature	26°C	Relative Humidity	56%
Pressure	960hPa	Test voltage	DC 5V From adapter
Test Mode	TX Low		

Freq. (MHz)	Ant. Pol H/V	Peak Reading (dBuV)	AV Reading (dBuV)	Ant. / CL CF (dB)	Actual Fs		Peak Limit (dBuV/m)	AV Limit (dBuV/m)	Margin (dB)	Remark
					Peak (dBuV/m)	AV (dBuV/m)				
1103	H	43.46	---	-11.24	32.22	---	74	54	41.78	Peak
4824	H	38.27	---	0.64	38.91	---	74	54	35.09	Peak
N/A										

Notes: AV Means AV detector test data, Peak Means Peak detector test data.

Emissions attenuated more than 20 dB below the permissible value are not reported.

EUT	Moticam X Smart Camera	Model Name	MOTICAM X 2
Temperature	26°C	Relative Humidity	56%
Pressure	960hPa	Test voltage	DC 5V From adapter
Test Mode	TX Mid		

Freq. (MHz)	Ant. Pol H/V	Peak Reading (dBuV)	AV Reading (dBuV)	Ant. / CL CF (dB)	Actual Fs		Peak Limit (dBuV/m)	AV Limit (dBuV/m)	Margin (dB)	Remark
					Peak (dBuV/m)	AV (dBuV/m)				
1103	V	42.51	---	-11.24	31.27	---	74	54	42.73	Peak
4874	V	41.59	---	0.76	42.35	---	74	54	31.65	Peak

EUT	Moticam X Smart Camera	Model Name	MOTICAM X 2
Temperature	26°C	Relative Humidity	56%
Pressure	960hPa	Test voltage	DC 5V From adapter
Test Mode	TX Mid		

Freq. (MHz)	Ant. Pol H/V	Peak Reading (dBuV)	AV Reading (dBuV)	Ant. / CL CF (dB)	Actual Fs		Peak Limit (dBuV/m)	AV Limit (dBuV/m)	Margin (dB)	Remark
					Peak (dBuV/m)	AV (dBuV/m)				
1103	H	42.21	---	-11.24	30.97	---	74	54	43.03	Peak
4874	H	39.7	---	0.76	40.46	---	74	54	33.54	Peak

Notes: AV Means AV detector test data, Peak Means Peak detector test data.

Emissions attenuated more than 20 dB below the permissible value are not reported.

EUT	Moticam X Smart Camera	Model Name	MOTICAM X 2
Temperature	26°C	Relative Humidity	56%
Pressure	960hPa	Test voltage	DC 5V From adapter
Test Mode	TX High		

Freq. (MHz)	Ant. Pol H/V	Peak Reading (dBuV)	AV Reading (dBuV)	Ant. / CL CF (dB)	Actual Fs		Peak Limit (dBuV/m)	AV Limit (dBuV/m)	Margin (dB)	Remark
					Peak (dBuV/m)	AV (dBuV/m)				
1103	V	43.9	---	-11.24	32.66	---	74	54	41.34	Peak
4924	V	40.77	---	0.87	41.64	---	74	54	32.36	Peak

EUT	Moticam X Smart Camera	Model Name	MOTICAM X 2
Temperature	26°C	Relative Humidity	56%
Pressure	960hPa	Test voltage	DC 5V From adapter
Test Mode	TX High		

Freq. (MHz)	Ant. Pol H/V	Peak Reading (dBuV)	AV Reading (dBuV)	Ant. / CL CF (dB)	Actual Fs		Peak Limit (dBuV/m)	AV Limit (dBuV/m)	Margin (dB)	Remark
					Peak (dBuV/m)	AV (dBuV/m)				
1103	V	42.28	---	-11.24	31.04	---	74	54	42.96	Peak
4924	V	41.69	---	0.87	42.56	---	74	54	31.44	Peak

Notes: AV Means AV detector test data, Peak Means Peak detector test data.

Emissions attenuated more than 20 dB below the permissible value are not reported.

All modes have been tested, and only worst data of mode 802.11b is listed in this report.

IEEE 802.11 g:

EUT	Moticam X Smart Camera	Model Name	MOTICAM X ²
Temperature	26°C	Relative Humidity	56%
Pressure	960hPa	Test voltage	DC 5V From adapter
Test Mode	TX Low		

Freq. (MHz)	Ant. Pol H/V	Peak Reading (dBuV)	AV Reading (dBuV)	Ant. / CL CF (dB)	Actual Fs		Peak Limit (dBuV/m)	AV Limit (dBuV/m)	Margin (dB)	Remark
					Peak (dBuV/m)	AV (dBuV/m)				
1145	V	42.08	---	-11.24	30.84	---	74	54	43.16	Peak
2586	V	42.38	---	-7.13	35.25	---	74	54	38.75	Peak
3062	V	42.62	---	-5.74	36.88	---	74	54	37.12	Peak
4824	V	40.55	---	0.64	41.19	---	74	54	32.81	Peak
N/A										

EUT	Moticam X Smart Camera	Model Name	MOTICAM X ²
Temperature	26°C	Relative Humidity	56%
Pressure	960hPa	Test voltage	DC 5V From adapter
Test Mode	TX Low		

Freq. (MHz)	Ant. Pol H/V	Peak Reading (dBuV)	AV Reading (dBuV)	Ant. / CL CF (dB)	Actual Fs		Peak Limit (dBuV/m)	AV Limit (dBuV/m)	Margin (dB)	Remark
					Peak (dBuV/m)	AV (dBuV/m)				
1294	H	42.49	---	-10.96	31.53	---	74	54	42.47	Peak
2038	H	42.17	---	-8.58	33.59	---	74	54	40.41	Peak
3483	H	42.31	---	-4.95	37.36	---	74	54	36.64	Peak
4824	H	41.4	---	0.64	42.04	---	74	54	31.96	Peak
N/A										

Notes: AV Means AV detector test data, Peak Means Peak detector test data.

Emissions attenuated more than 20 dB below the permissible value are not reported.

EUT	Moticam X Smart Camera	Model Name	MOTICAM X 2
Temperature	26°C	Relative Humidity	56%
Pressure	960hPa	Test voltage	DC 5V From adapter
Test Mode	TX Mid		

Freq. (MHz)	Ant. Pol H/V	Peak Reading (dBuV)	AV Reading (dBuV)	Ant. / CL CF (dB)	Actual Fs		Peak Limit (dBuV/m)	AV Limit (dBuV/m)	Margin (dB)	Remark
					Peak (dBuV/m)	AV (dBuV/m)				
1374	V	42.18	---	-10.43	31.75	---	74	54	42.25	Peak
2589	V	43.01	---	-7.13	35.88	---	74	54	38.12	Peak
3365	V	42.72	---	-5.18	37.54	---	74	54	36.46	Peak
4874	V	40.52	---	0.76	41.28	---	74	54	32.72	Peak

EUT	Moticam X Smart Camera	Model Name	MOTICAM X 2
Temperature	26°C	Relative Humidity	56%
Pressure	960hPa	Test voltage	DC 5V From adapter
Test Mode	TX Mid		

Freq. (MHz)	Ant. Pol H/V	Peak Reading (dBuV)	AV Reading (dBuV)	Ant. / CL CF (dB)	Actual Fs		Peak Limit (dBuV/m)	AV Limit (dBuV/m)	Margin (dB)	Remark
					Peak (dBuV/m)	AV (dBuV/m)				
1321	H	42.74	---	-10.84	31.9	---	74	54	42.1	Peak
2314	H	43.06	---	-7.46	35.6	---	74	54	38.4	Peak
3577	H	43.19	---	-4.76	38.43	---	74	54	35.57	Peak
4874	H	41.37	---	0.76	42.13	---	74	54	31.87	Peak

Notes: AV Means AV detector test data, Peak Means Peak detector test data.

Emissions attenuated more than 20 dB below the permissible value are not reported.

EUT	Moticam X Smart Camera	Model Name	MOTICAM X 2
Temperature	26°C	Relative Humidity	56%
Pressure	960hPa	Test voltage	DC 5V From adapter
Test Mode	TX High		

Freq. (MHz)	Ant. Pol H/V	Peak Reading (dBuV)	AV Reading (dBuV)	Ant. / CL CF (dB)	Actual Fs		Peak Limit (dBuV/m)	AV Limit (dBuV/m)	Margin (dB)	Remark
					Peak (dBuV/m)	AV (dBuV/m)				
1302	V	41.83	---	-10.84	30.99	---	74	54	43.01	Peak
2982	V	41.49	---	-5.86	35.63	---	74	54	38.37	Peak
3831	V	41.97	---	-3.96	38.01	---	74	54	35.99	Peak
4924	V	41.01	---	0.87	41.88	---	74	54	32.12	Peak

EUT	Moticam X Smart Camera	Model Name	MOTICAM X 2
Temperature	26°C	Relative Humidity	56%
Pressure	960hPa	Test voltage	DC 5V From adapter
Test Mode	TX High		

Freq. (MHz)	Ant. Pol H/V	Peak Reading (dBuV)	AV Reading (dBuV)	Ant. / CL CF (dB)	Actual Fs		Peak Limit (dBuV/m)	AV Limit (dBuV/m)	Margin (dB)	Remark
					Peak (dBuV/m)	AV (dBuV/m)				
1446	H	40.89	---	-10.29	30.6	---	74	54	43.4	Peak
2198	H	42.06	---	-8.24	33.82	---	74	54	40.18	Peak
3905	H	42.46	---	-3.68	38.78	---	74	54	35.22	Peak
4924	H	42.1	---	0.87	42.97	---	74	54	31.03	Peak

Notes: AV Means AV detector test data, Peak Means Peak detector test data.

Emissions attenuated more than 20 dB below the permissible value are not reported.

IEEE 802.11n/HT20 with 2.4G

EUT	Moticam X Smart Camera	Model Name	MOTICAM X 2
Temperature	26°C	Relative Humidity	56%
Pressure	960hPa	Test voltage	DC 5V From adapter
Test Mode	TX Low		

Freq. (MHz)	Ant. Pol H/V	Peak Reading (dBuV)	AV Reading (dBuV)	Ant. / CL CF (dB)	Actual Fs		Peak Limit (dBuV/m)	AV Limit (dBuV/m)	Margin (dB)	Remark
					Peak (dBuV/m)	AV (dBuV/m)				
1492	V	42.29	---	-10.27	32.02	---	74	54	41.98	Peak
2671	V	42.63	---	-6.94	35.69	---	74	54	38.31	Peak
3948	V	43.21	---	-3.68	39.53	---	74	54	34.47	Peak
4824	V	40.76	---	0.64	41.4	---	74	54	32.6	Peak
N/A										

EUT	Moticam X Smart Camera	Model Name	MOTICAM X 2
Temperature	26°C	Relative Humidity	56%
Pressure	960hPa	Test voltage	DC 5V From adapter
Test Mode	TX Low		

Freq. (MHz)	Ant. Pol H/V	Peak Reading (dBuV)	AV Reading (dBuV)	Ant. / CL CF (dB)	Actual Fs		Peak Limit (dBuV/m)	AV Limit (dBuV/m)	Margin (dB)	Remark
					Peak (dBuV/m)	AV (dBuV/m)				
1451	H	42.8	---	-10.27	32.53	---	74	54	41.47	Peak
2839	H	42.03	---	-6.17	35.86	---	74	54	38.14	Peak
3607	H	41.94	---	-4.52	37.42	---	74	54	36.58	Peak
4824	H	41.21	---	0.64	41.85	---	74	54	32.15	Peak
N/A										

Notes: AV Means AV detector test data, Peak Means Peak detector test data.

Emissions attenuated more than 20 dB below the permissible value are not reported.

EUT	Moticam X Smart Camera	Model Name	MOTICAM X 2
Temperature	26°C	Relative Humidity	56%
Pressure	960hPa	Test voltage	DC 5V From adapter
Test Mode	TX Mid		

Freq. (MHz)	Ant. Pol H/V	Peak Reading (dBuV)	AV Reading (dBuV)	Ant. / CL CF (dB)	Actual Fs		Peak Limit (dBuV/m)	AV Limit (dBuV/m)	Margin (dB)	Remark
					Peak (dBuV/m)	AV (dBuV/m)				
1262	V	42.25	---	-10.96	31.29	---	74	54	42.71	Peak
2013	V	42.99	---	-8.58	34.41	---	74	54	39.59	Peak
3798	V	41.93	---	-4.07	37.86	---	74	54	36.14	Peak
4874	V	40.85	---	0.76	41.61	---	74	54	32.39	Peak

EUT	Moticam X Smart Camera	Model Name	MOTICAM X 2
Temperature	26°C	Relative Humidity	56%
Pressure	960hPa	Test voltage	DC 5V From adapter
Test Mode	TX Mid		

Freq. (MHz)	Ant. Pol H/V	Peak Reading (dBuV)	AV Reading (dBuV)	Ant. / CL CF (dB)	Actual Fs		Peak Limit (dBuV/m)	AV Limit (dBuV/m)	Margin (dB)	Remark
					Peak (dBuV/m)	AV (dBuV/m)				
1511	H	41.23	---	-10.14	31.09	---	74	54	42.91	Peak
2353	H	41.94	---	-7.59	34.35	---	74	54	39.65	Peak
3266	H	43.39	---	-5.39	38	---	74	54	36	Peak
4874	H	41.84	---	0.76	42.6	---	74	54	31.4	Peak

Notes: AV Means AV detector test data, Peak Means Peak detector test data.

Emissions attenuated more than 20 dB below the permissible value are not reported.

EUT	Moticam X Smart Camera	Model Name	MOTICAM X 2
Temperature	26°C	Relative Humidity	56%
Pressure	960hPa	Test voltage	DC 5V From adapter
Test Mode	TX High		

Freq. (MHz)	Ant. Pol H/V	Peak Reading (dBuV)	AV Reading (dBuV)	Ant. / CL CF (dB)	Actual Fs		Peak Limit (dBuV/m)	AV Limit (dBuV/m)	Margin (dB)	Remark
					Peak (dBuV/m)	AV (dBuV/m)				
1477	V	42.84	---	-10.27	32.57	---	74	54	41.43	Peak
2703	V	42.15	---	-6.43	35.72	---	74	54	38.28	Peak
3561	V	42.69	---	-4.76	37.93	---	74	54	36.07	Peak
4924	V	40.45	---	0.87	41.32	---	74	54	32.68	Peak

EUT	Moticam X Smart Camera	Model Name	MOTICAM X 2
Temperature	26°C	Relative Humidity	56%
Pressure	960hPa	Test voltage	DC 5V From adapter
Test Mode	TX High		

Freq. (MHz)	Ant. Pol H/V	Peak Reading (dBuV)	AV Reading (dBuV)	Ant. / CL CF (dB)	Actual Fs		Peak Limit (dBuV/m)	AV Limit (dBuV/m)	Margin (dB)	Remark
					Peak (dBuV/m)	AV (dBuV/m)				
1503	H	40.47	---	-10.14	30.33	---	74	54	43.67	Peak
3588	H	41.78	---	-4.96	36.82	---	74	54	37.18	Peak
4153	H	42.54	---	-2.48	40.06	---	74	54	33.94	Peak
4924	H	40.11	---	0.87	40.98	---	74	54	33.02	Peak

Notes: AV Means AV detector test data, Peak Means Peak detector test data.

Emissions attenuated more than 20 dB below the permissible value are not reported.

IEEE 802.11n/HT40 with 2.4G

EUT	Moticam X Smart Camera	Model Name	MOTICAM X ²
Temperature	26°C	Relative Humidity	56%
Pressure	960hPa	Test voltage	DC 5V From adapter
Test Mode	TX Low		

Freq. (MHz)	Ant. Pol H/V	Peak Reading (dBuV)	AV Reading (dBuV)	Ant. / CL CF (dB)	Actual Fs		Peak Limit (dBuV/m)	AV Limit (dBuV/m)	Margin (dB)	Remark
					Peak (dBuV/m)	AV (dBuV/m)				
1551	V	42.26	---	-10.07	32.19	---	74	54	41.81	Peak
2695	V	41.08	---	-6.94	34.14	---	74	54	39.86	Peak
3463	V	42.62	---	-4.95	37.67	---	74	54	36.33	Peak
4844	V	42.11	---	0.64	42.75	---	74	54	31.25	Peak
N/A										

EUT	Moticam X Smart Camera	Model Name	MOTICAM X ²
Temperature	26°C	Relative Humidity	56%
Pressure	960hPa	Test voltage	DC 5V From adapter
Test Mode	TX Low		

Freq. (MHz)	Ant. Pol H/V	Peak Reading (dBuV)	AV Reading (dBuV)	Ant. / CL CF (dB)	Actual Fs		Peak Limit (dBuV/m)	AV Limit (dBuV/m)	Margin (dB)	Remark
					Peak (dBuV/m)	AV (dBuV/m)				
1542	H	41.86	---	-10.14	31.72	---	74	54	42.28	Peak
2358	H	42.05	---	-7.59	34.46	---	74	54	39.54	Peak
3096	H	41.63	---	-5.74	35.89	---	74	54	38.11	Peak
4844	H	42.18	---	0.64	42.82	---	74	54	31.18	Peak
N/A										

Notes: AV Means AV detector test data, Peak Means Peak detector test data.

Emissions attenuated more than 20 dB below the permissible value are not reported.

EUT	Moticam X Smart Camera	Model Name	MOTICAM X 2
Temperature	26°C	Relative Humidity	56%
Pressure	960hPa	Test voltage	DC 5V From adapter
Test Mode	TX Mid		

Freq. (MHz)	Ant. Pol H/V	Peak Reading (dBuV)	AV Reading (dBuV)	Ant. / CL CF (dB)	Actual Fs		Peak Limit (dBuV/m)	AV Limit (dBuV/m)	Margin (dB)	Remark
					Peak (dBuV/m)	AV (dBuV/m)				
1628	V	42.26	---	-9.84	32.42	---	74	54	41.58	Peak
2593	V	42.61	---	-7.13	35.48	---	74	54	38.52	Peak
3301	V	41.58	---	-5.31	36.27	---	74	54	37.73	Peak
4874	V	42.06	---	0.76	42.82	---	74	54	31.18	Peak

EUT	Moticam X Smart Camera	Model Name	MOTICAM X 2
Temperature	26°C	Relative Humidity	56%
Pressure	960hPa	Test voltage	DC 5V From adapter
Test Mode	TX Mid		

Freq. (MHz)	Ant. Pol H/V	Peak Reading (dBuV)	AV Reading (dBuV)	Ant. / CL CF (dB)	Actual Fs		Peak Limit (dBuV/m)	AV Limit (dBuV/m)	Margin (dB)	Remark
					Peak (dBuV/m)	AV (dBuV/m)				
1564	H	43.03	---	-10.07	32.96	---	74	54	41.04	Peak
2248	H	42.82	---	-8.13	34.69	---	74	54	39.31	Peak
3159	H	41.56	---	-5.52	36.04	---	74	54	37.96	Peak
4874	H	42.33	---	0.76	43.09	---	74	54	30.91	Peak

Notes: AV Means AV detector test data, Peak Means Peak detector test data.

Emissions attenuated more than 20 dB below the permissible value are not reported.

EUT	Moticam X Smart Camera	Model Name	MOTICAM X ²
Temperature	26°C	Relative Humidity	56%
Pressure	960hPa	Test voltage	DC 5V From adapter
Test Mode	TX High		

Freq. (MHz)	Ant. Pol H/V	Peak Reading (dBuV)	AV Reading (dBuV)	Ant. / CL CF (dB)	Actual Fs		Peak Limit (dBuV/m)	AV Limit (dBuV/m)	Margin (dB)	Remark
					Peak (dBuV/m)	AV (dBuV/m)				
1645	V	42.26	---	-9.84	32.42	---	74	54	41.58	Peak
2590	V	41.85	---	-7.13	34.72	---	74	54	39.28	Peak
3851	V	42.32	---	-3.84	38.48	---	74	54	35.52	Peak
4904	V	42.28	---	0.87	43.15	---	74	54	30.85	Peak

EUT	Moticam X Smart Camera	Model Name	MOTICAM X ²
Temperature	26°C	Relative Humidity	56%
Pressure	960hPa	Test voltage	DC 5V From adapter
Test Mode	TX High		

Freq. (MHz)	Ant. Pol H/V	Peak Reading (dBuV)	AV Reading (dBuV)	Ant. / CL CF (dB)	Actual Fs		Peak Limit (dBuV/m)	AV Limit (dBuV/m)	Margin (dB)	Remark
					Peak (dBuV/m)	AV (dBuV/m)				
1792	H	42.52	---	-9.27	33.25	---	74	54	40.75	Peak
2804	H	42.41	---	-6.17	36.24	---	74	54	37.76	Peak
3743	H	41.75	---	-4.24	37.51	---	74	54	36.49	Peak
4904	H	42.28	---	0.87	43.15	---	74	54	30.85	Peak

Notes: AV Means AV detector test data, Peak Means Peak detector test data.

Emissions attenuated more than 20 dB below the permissible value are not reported.

6 POWER LINE CONDUCTED EMISSION

6.1 Conducted Emission Limits(15.207)

Frequency MHz	Limits dB(μ V)	
	Quasi-peak Level	Average Level
0.15 -0.50	66 -56*	56 - 46*
0.50 -5.00	56	46
5.00 -30.00	60	50

Notes: 1. *Decreasing linearly with logarithm of frequency.

2. The lower limit shall apply at the transition frequencies.

3.The limit decreases in line with the logarithm of the frequency in the rang of 0.15 to 0.50 MHz.

6.2 Test Setup

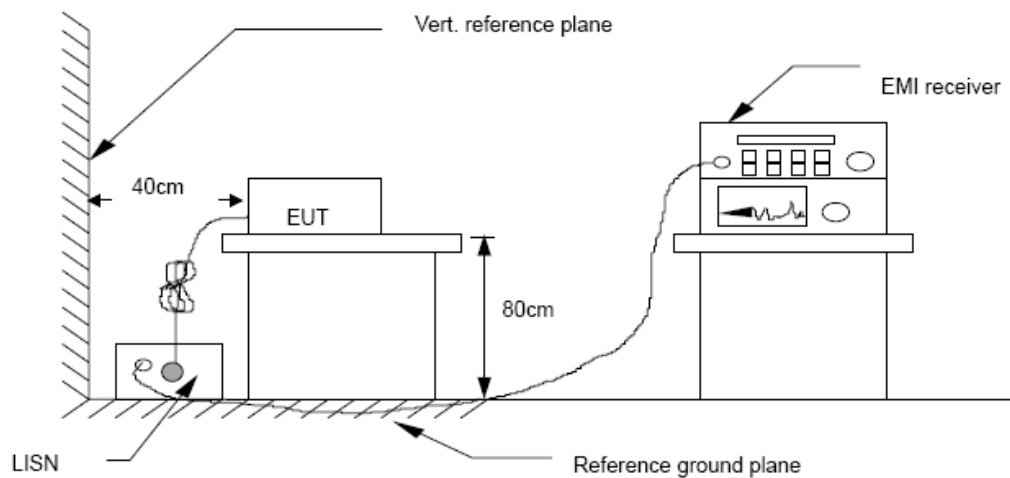

6.3 Test Procedure

The EUT is put on the plane 0.8m high above the ground by insulating support and is connected to the power mains through a line impedance stabilization network (L.I.S.N.). This provides a 50ohm coupling impedance for the EUT system. Please refer the block diagram of the test setup and photographs. Both sides of AC lines are checked to find out the maximum conducted emission. In order to find the maximum emission levels, the relative positions of equipment and all of the interface cables shall be changed according to ANSI C63.4-2003 on Conducted Emission Measurement. The bandwidth of test receiver (R & S ESCMOTICAM X Ø) is set at 9 kHz.

6.4 Test Results

PASS

Detailed information please see the following page.

Data: 7 File: E:\TEST REPORT\M\MoticamX2.EM6 (13) Date: 2014-11-05 Time: 09:07:45

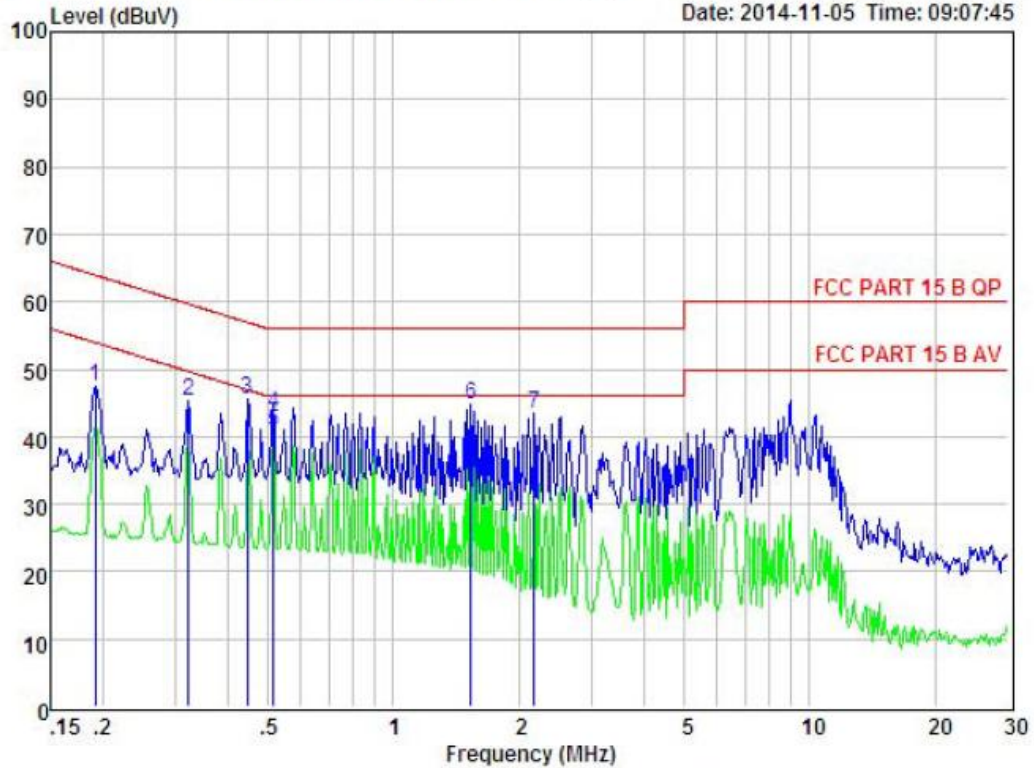

Condition : FCC PART 15 B QP POL: LINE Temp:24 °C Hum:56 %
 EUT : Moticam X2 Smart Camera
 Model No : Moticam X2
 Test Mode : Working
 Power : DC 5V From Adapter AC 120V/60Hz
 Test Engineer: Gemini
 Remark :

Item	Freq MHz	Read dBuV	LISN Factor dB	Preamp Factor dB	Cable Loss dB	Level dBuV	Limit dBuV	Margin dBuV	Remark
1	0.192	37.55	0.03	-9.72	0.10	47.40	63.93	-16.53	Peak
2	0.322	35.39	0.03	-9.72	0.10	45.24	59.66	-14.42	Peak
3	0.447	35.63	0.03	-9.72	0.10	45.48	56.93	-11.45	Peak
4	0.516	33.50	0.03	-9.72	0.10	43.35	56.00	-12.65	QP
5	0.516	30.80	0.03	-9.72	0.10	40.65	46.00	-5.35	Average
6	1.535	34.96	0.05	-9.71	0.10	44.82	56.00	-11.18	Peak
7	2.178	33.61	0.06	-9.70	0.10	43.47	56.00	-12.53	Peak

Remarks: Level = Read + LISN Factor - Preamp Factor + Cable loss

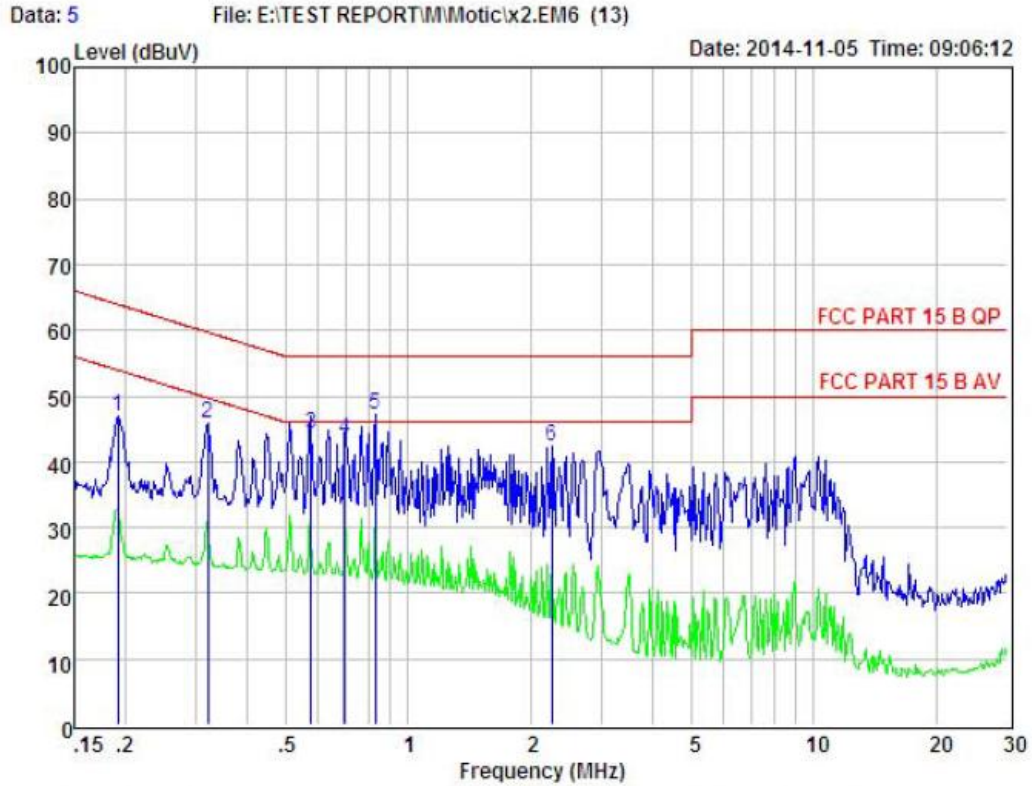

Condition : FCC PART 15 B QP POL: NEUTRAL Temp:24 °C Hum:56 %
 EUT : Moticam X2 Smart Camera
 Model No : Moticam X2
 Test Mode : Working
 Power : DC 5V From Adapter AC 120V/60Hz
 Test Engineer: Gemini
 Remark :

Item	Freq MHz	Read dBuV	LISN Factor dB	Preamp Factor dB	Cable Loss dB	Level dBuV	Limit dBuV	Margin dBuV	Remark
1	0.192	37.09	0.03	-9.72	0.10	46.94	63.93	-16.99	Peak
2	0.320	35.95	0.03	-9.72	0.10	45.80	59.71	-13.91	Peak
3	0.576	34.35	0.03	-9.72	0.10	44.20	56.00	-11.80	Peak
4	0.697	33.56	0.04	-9.72	0.10	43.42	56.00	-12.58	Peak
5	0.830	37.48	0.02	-9.71	0.10	47.31	56.00	-8.69	Peak
6	2.261	32.62	0.06	-9.70	0.11	42.49	56.00	-13.51	Peak

Remarks: Level = Read + LISN Factor - Preamp Factor + Cable loss

7 Conducted Maximum Output Power

7.1 Test limit

Please refer section 15.247.

Regulation 15.247(b) The limit of Maximum Peak Output Power Measurement is 1W(30dBm)

7.2 Test Procedure

Details see the KDB558074 Meas Guidance V03

7.2.1 Place the EUT on the table and set it in transmitting mode.

7.2.2 Connected the EUT's antenna port to power meter by 20dB attenuator.

7.2.3 Measure out each mode and each bands output Average power of EUT.

Note: The cable loss and attenuator loss were offset into measure device as amplitude offset.

Details see the KDB558074 DTS Meas Guidance V03

7.3 Test Setup

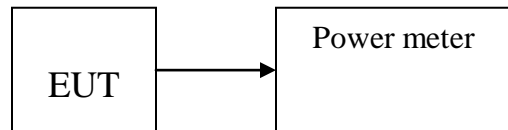

7.4 Test Results

PASS

Detailed information please see the following page.

EUT: Moticam X ² Smart Camera		M/N: MOTICAM X ²		
Test date: 2014-11-05		Test site: RF site	Tested by: Simple Guan	
Mode	Frequency (MHz)	Average Output power (dBm)	Limit (dBm)	Margin (dB)
IEEE 802.11 b	CH1: 2412	17.36	30	12.64
	CH6: 2437	17.46	30	12.54
	CH11: 2462	17.12	30	12.88
IEEE 802.11 g	CH1: 2412	16.53	30	13.47
	CH6: 2437	16.83	30	13.17
	CH11: 2462	16.79	30	13.21
IEEE 802.11 n/HT20 with 2.4G	CH1: 2412	15.16	30	14.84
	CH6: 2437	15.64	30	14.36
	CH11: 2462	15.23	30	14.77
IEEE 802.11 n/HT40 with 2.4G	CH1: 2422	15.34	30	14.66
	CH6: 2437	15.74	30	14.26
	CH11: 2452	15.66	30	14.34
Conclusion: PASS				

8 PEAK POWER SPECTRAL DENSITY

8.1 Test limit

8.1.1 Please refer section 15.247.

8.1.2 For direct sequence systems, the peak power spectral density conducted from the intentional radiator to the antenna shall not be greater than 8dBm in any 3kHz band during any time interval of continuous transmission.

8.1.3 The direct sequence operating of the hybrid system, with the frequency hopping operation turned off, shall comply with the power density requirements of paragraph (d) of this section.

8.2 Method of measurement

Details see the KDB558074 DTS Meas Guidance V03

8.2.1 Place the EUT on the table and set it in transmitting mode.

8.2.2 Remove the antenna from the EUT and then connect a low loss RF cable from the antenna port to the spectrum analyzer.

8.2.3 Set the spectrum analyzer as RBW = 3kHz, VBW = 10kHz, span=5-30%EBW, detail see the test plot.

8.2.4 Record the max reading.

8.2.5 Repeat the above procedure until the measurements for all frequencies are completed.

8.3 Test Setup

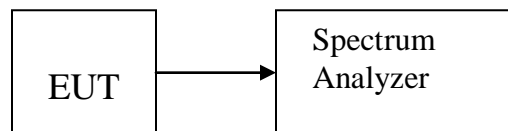

8.4 Test Results

PASS.

Detailed information please see the following page.

Channel	Frequency (MHz)	Power Spectral Density (dBm)	Limit (dBm)	Result
IEEE 802.11b:				
Low	2412	-10.747	8	PASS
Mid	2437	-10.925	8	PASS
High	2462	-11.989	8	PASS
IEEE 802.11g:				
Low	2412	-14.386	8	PASS
Mid	2437	-14.670	8	PASS
High	2462	-14.830	8	PASS
IEEE 802.11n/HT20 with 2.4G:				
Low	2412	-13.642	8	PASS
Mid	2437	-14.188	8	PASS
High	2462	-15.203	8	PASS
IEEE 802.11n/HT40 with 2.4G:				
Low	2422	-17.286	8	PASS
Mid	2437	-17.124	8	PASS
High	2452	-18.493	8	PASS

IEEE 802.11b:
CH Low :



CH Mid :

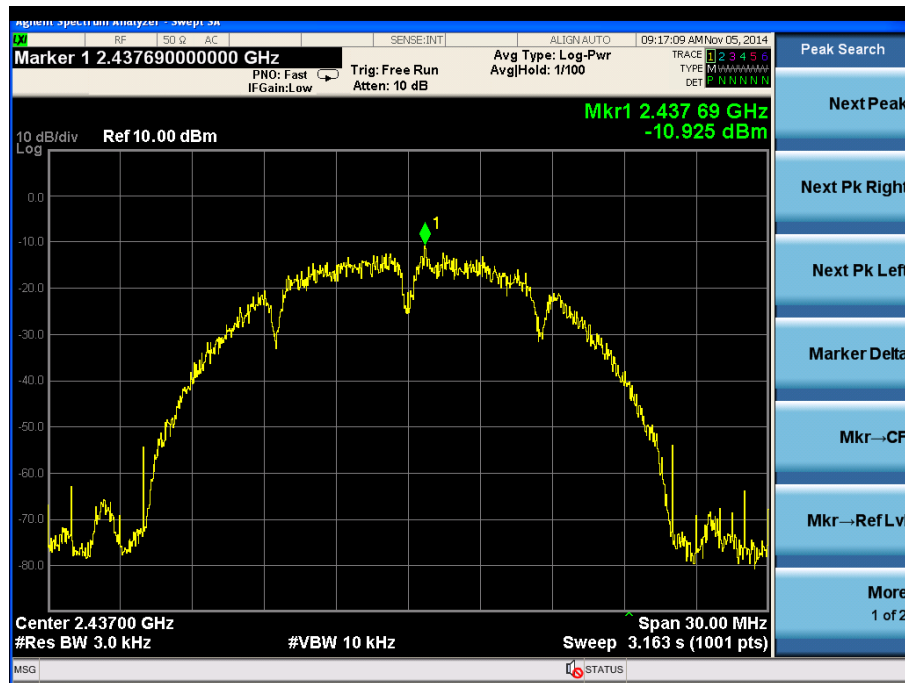

CH High :



IEEE 802.11g:

CH Low :

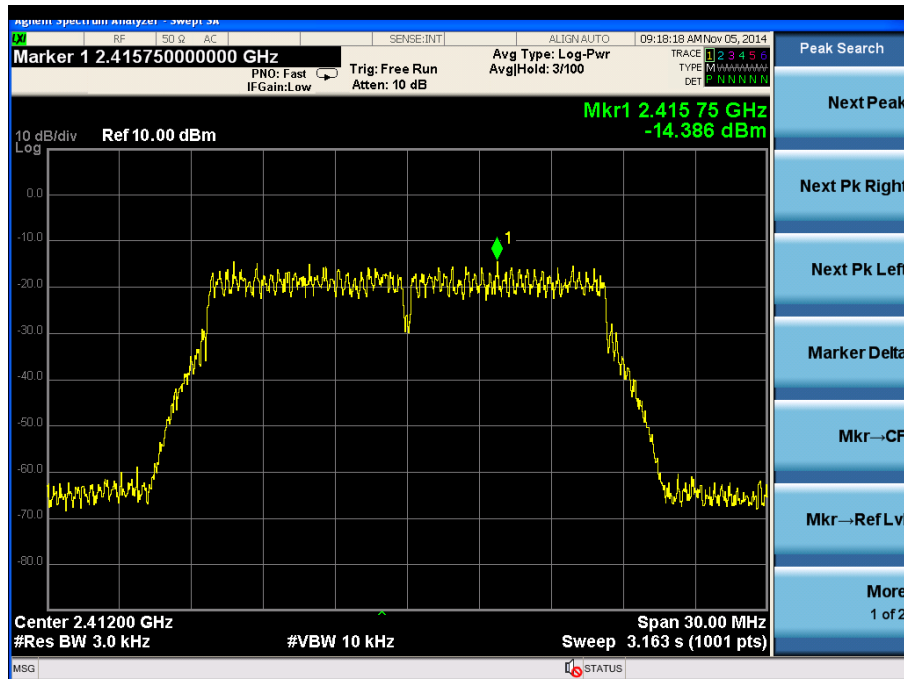

CH Mid :

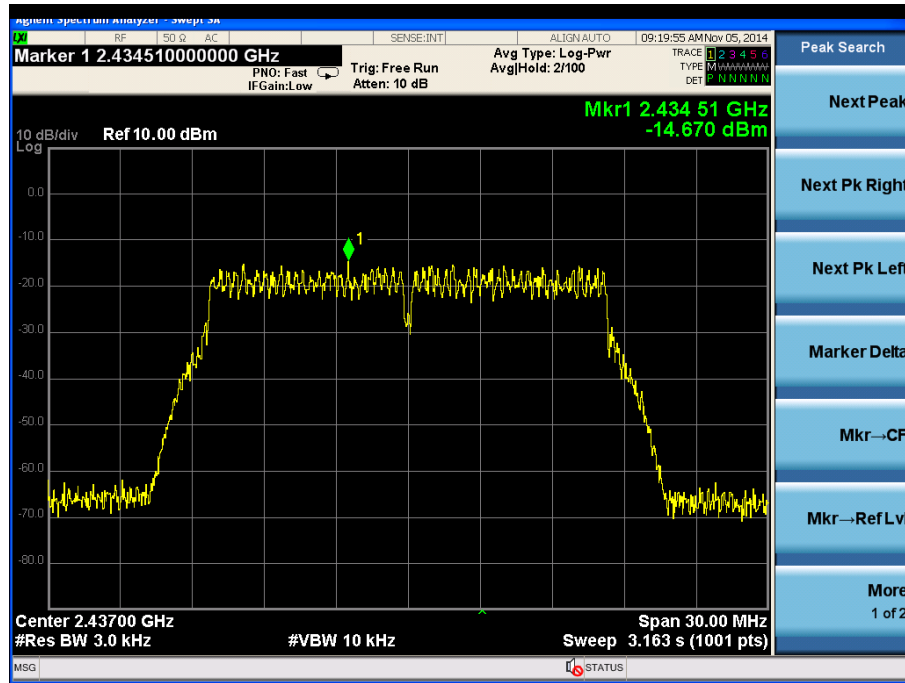

CH High :

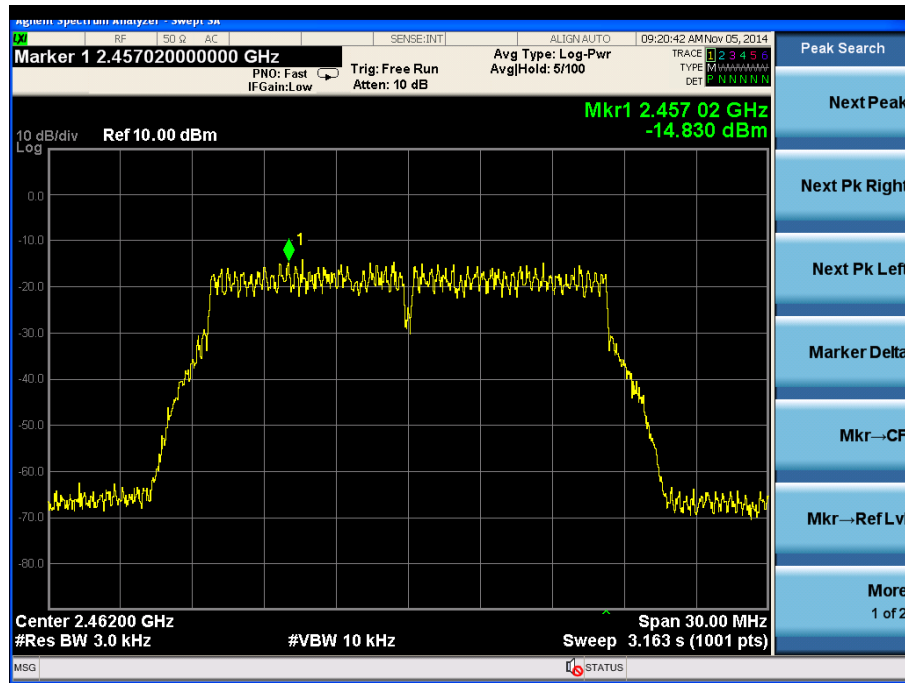

IEEE 802.11n/HT20 with 2.4G:
CH Low :

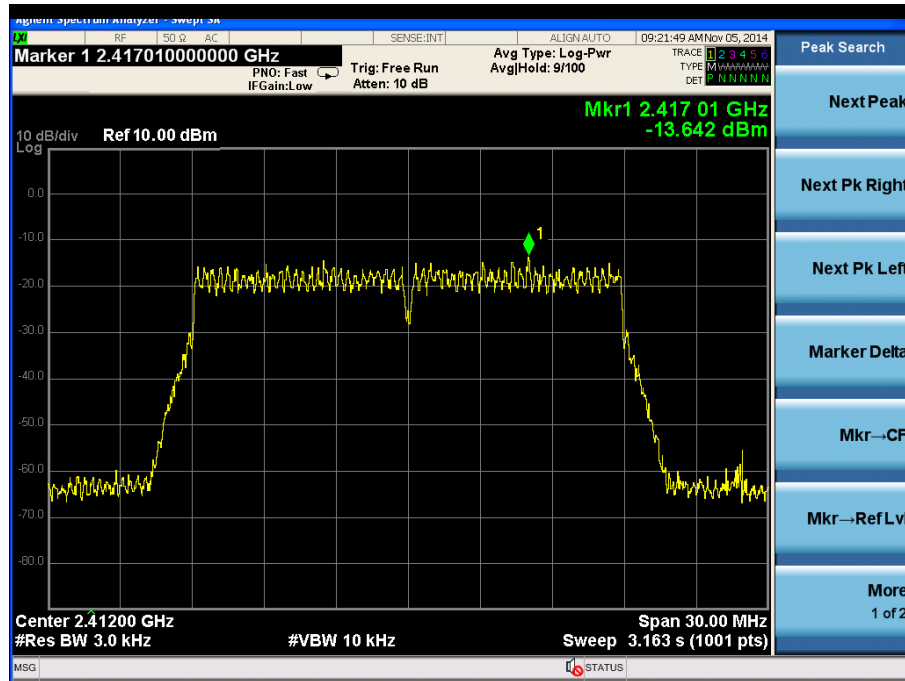

CH Mid :

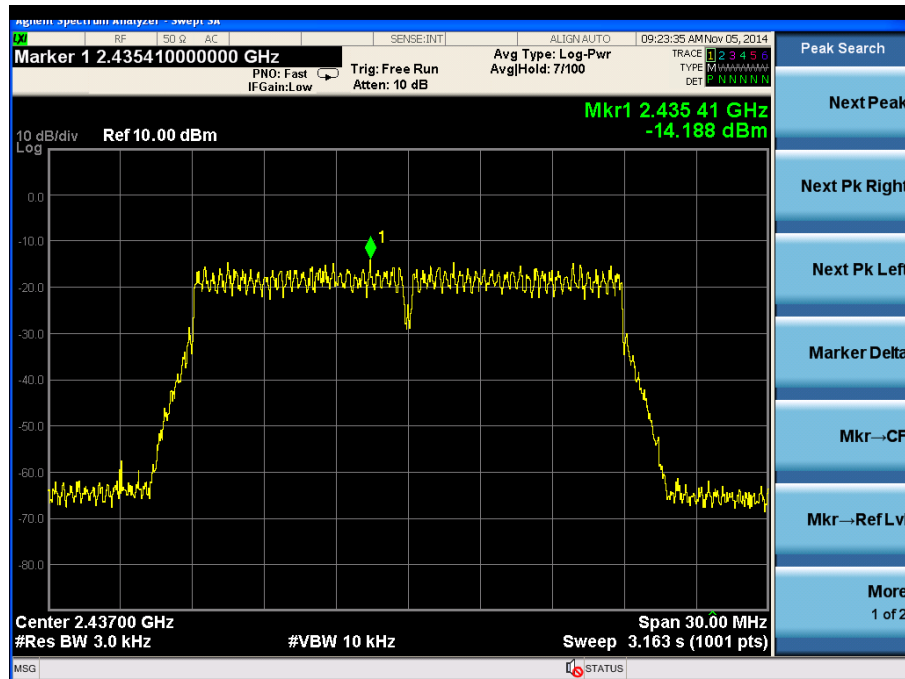

CH High :

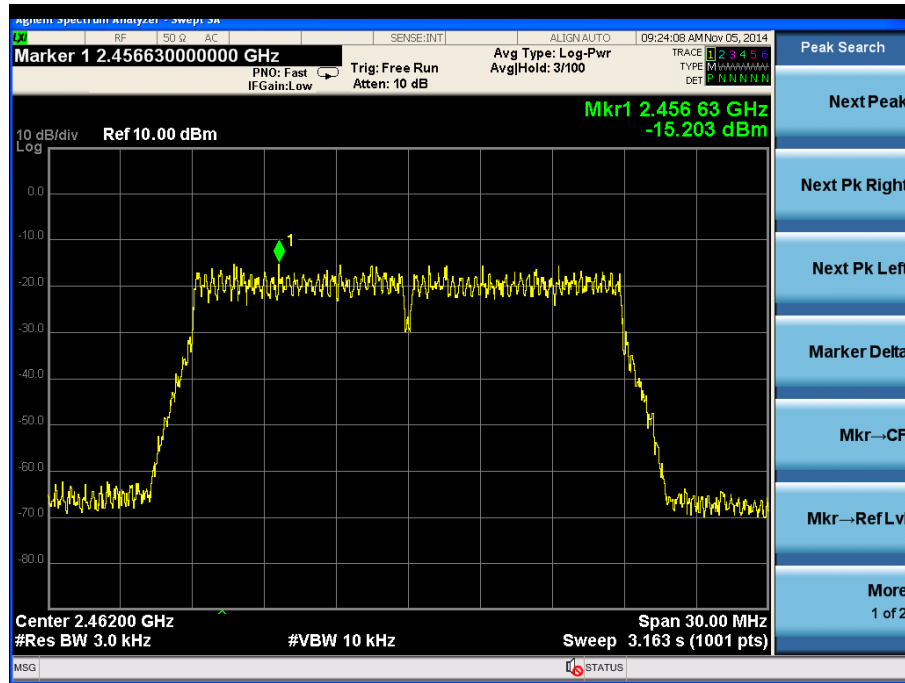

IEEE 802.11n/HT40 with 2.4G:
CH Low :

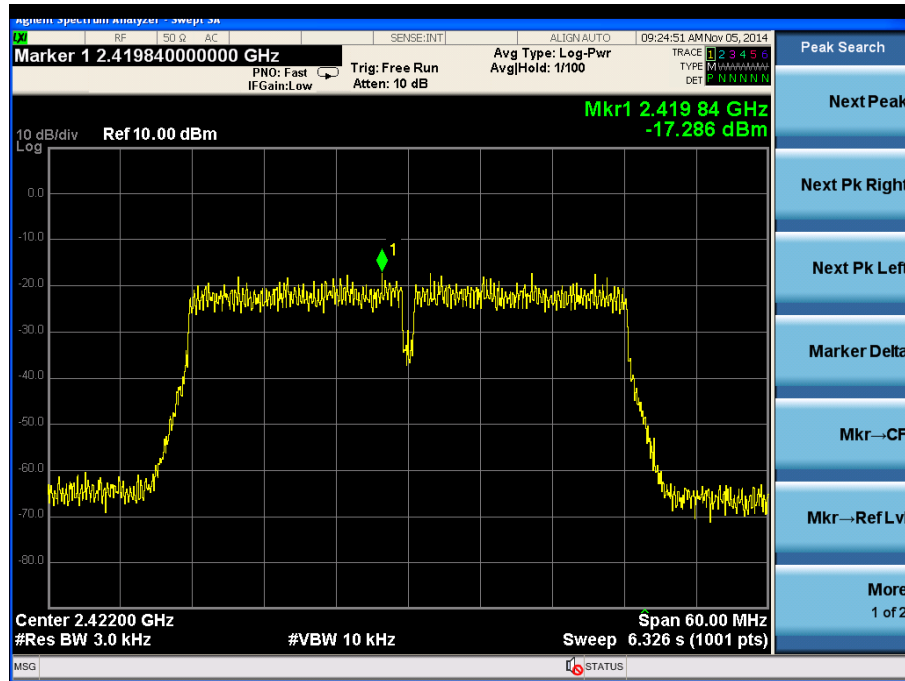

CH Mid:

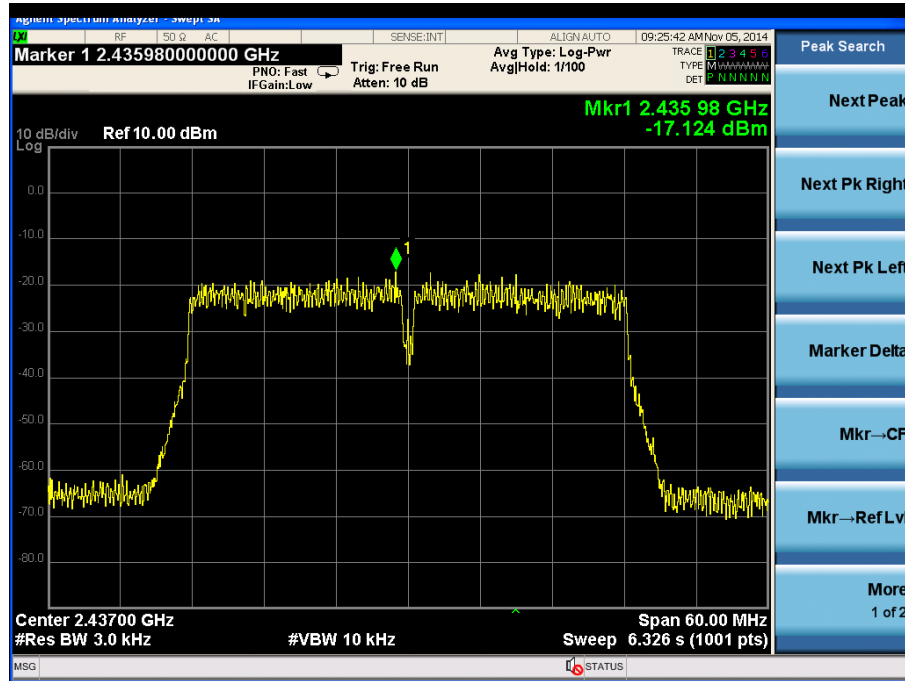

CH High

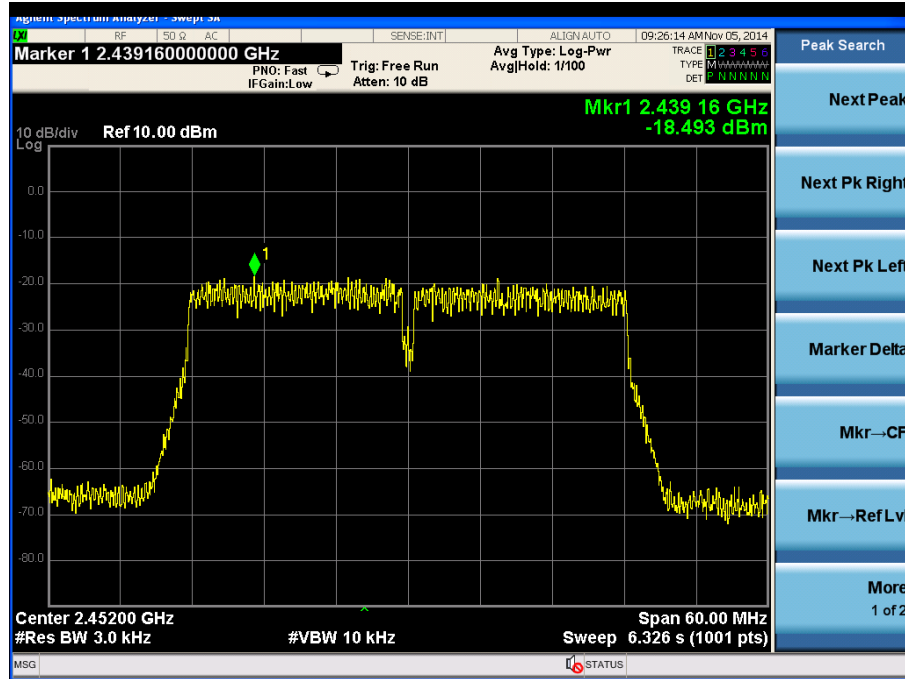

9 Bandwidth

9.1 Test limit

Please refer section 15.247

For direct sequence systems, the minimum 6dB bandwidth shall be at least 500kHz.

9.2 Method of measurement

Details see the KDB558074 D01 Meas Guidance

a) The bandwidth is measured at an amplitude level reduced 20dB from the reference level.

The reference level is the level of the highest amplitude signal observed from the transmitter at the fundamental frequency. Once the reference level is established, the equipment is conditioned with typical modulating signal to produce the worst-case (i.e. the widest) bandwidth.

b) The test receiver set $RBW = 1-5 \% EBW$, $VBW \geq 3RBW$, Sweep time set auto, detail see the test plot.

9.3 Test Setup

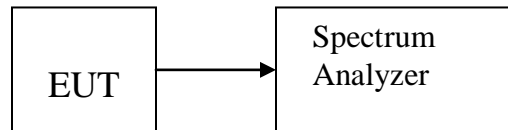

9.4 Test Results

PASS.

Detailed information please see the following page.

Channel	Frequency (MHz)	6dB Bandwidth (MHz)	Limit (MHz)	Result
IEEE 802.11b:				
Low	2412	10.12	0.5	PASS
Mid	2437	10.12	0.5	PASS
High	2462	10.14	0.5	PASS
IEEE 802.11g:				
Low	2412	16.44	0.5	PASS
Mid	2437	16.50	0.5	PASS
High	2462	16.46	0.5	PASS
IEEE 802.11n/HT20 with 2.4G:				
Low	2412	17.66	0.5	PASS
Mid	2437	17.64	0.5	PASS
High	2462	17.83	0.5	PASS
IEEE 802.11n/HT40 with 2.4G:				
Low	2422	36.42	0.5	PASS
Mid	2437	36.54	0.5	PASS
High	2452	36.49	0.5	PASS

IEEE 802.11b:
CH Low :

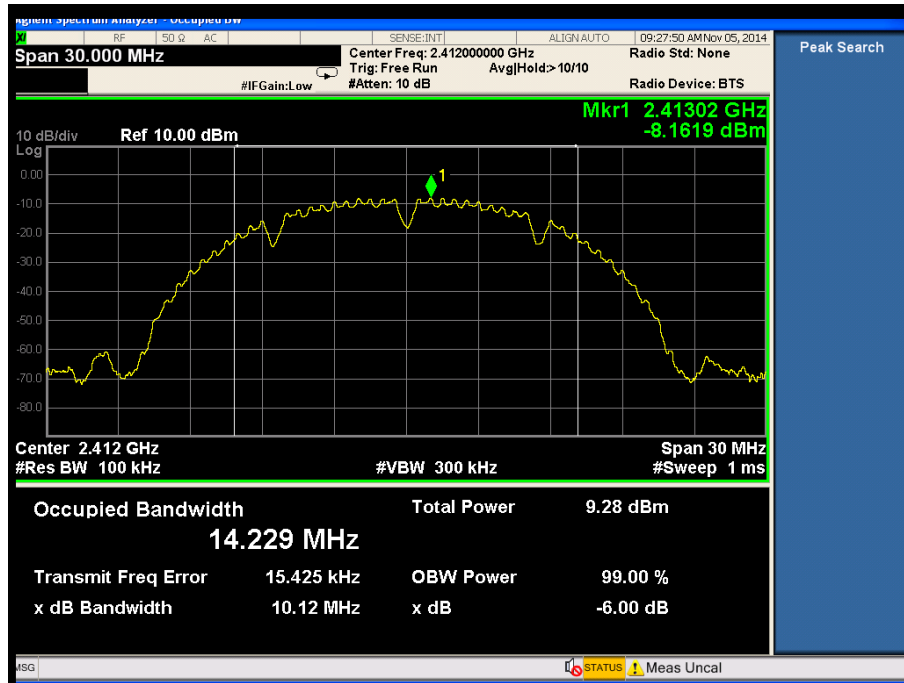

CH Mid :

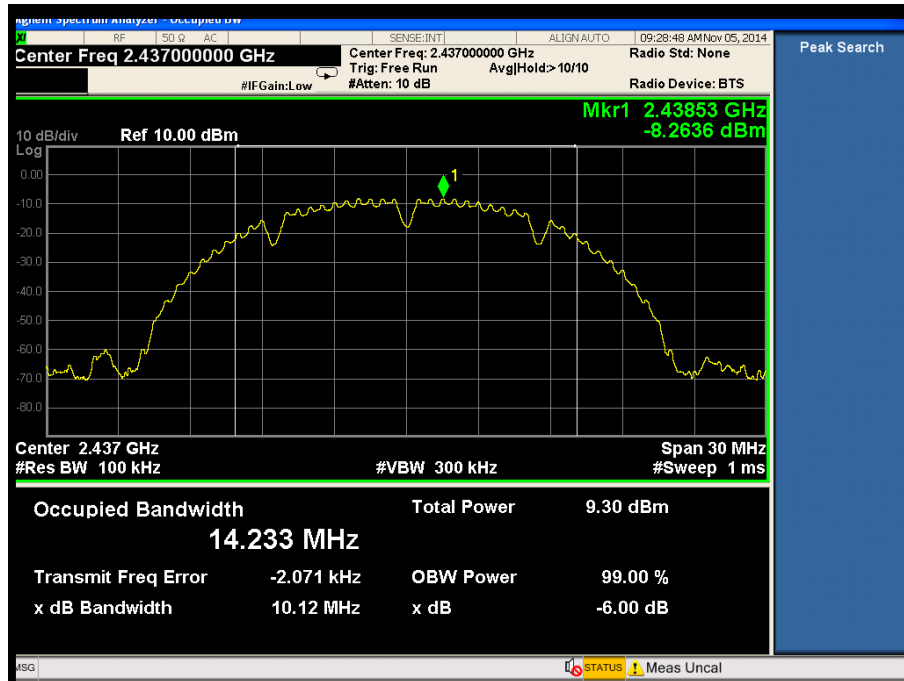

CH High :

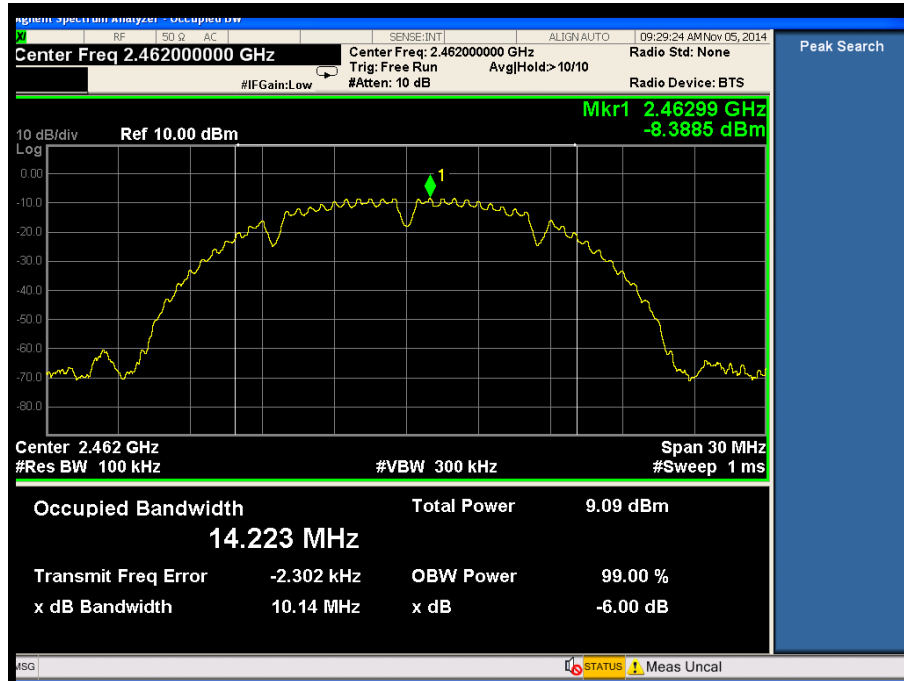

IEEE 802.11g:
 CH Low :

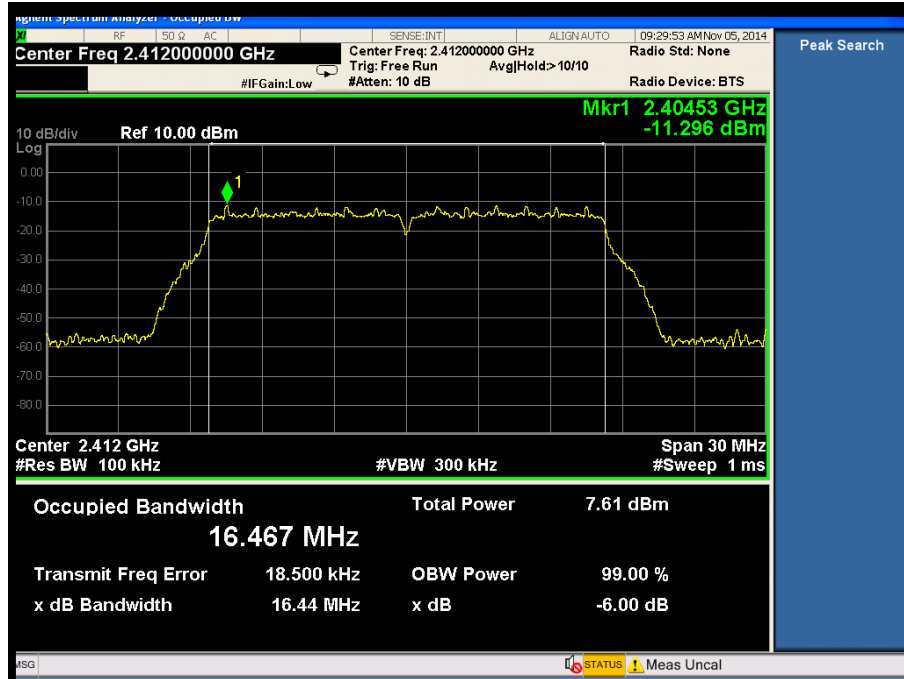

CH Mid :

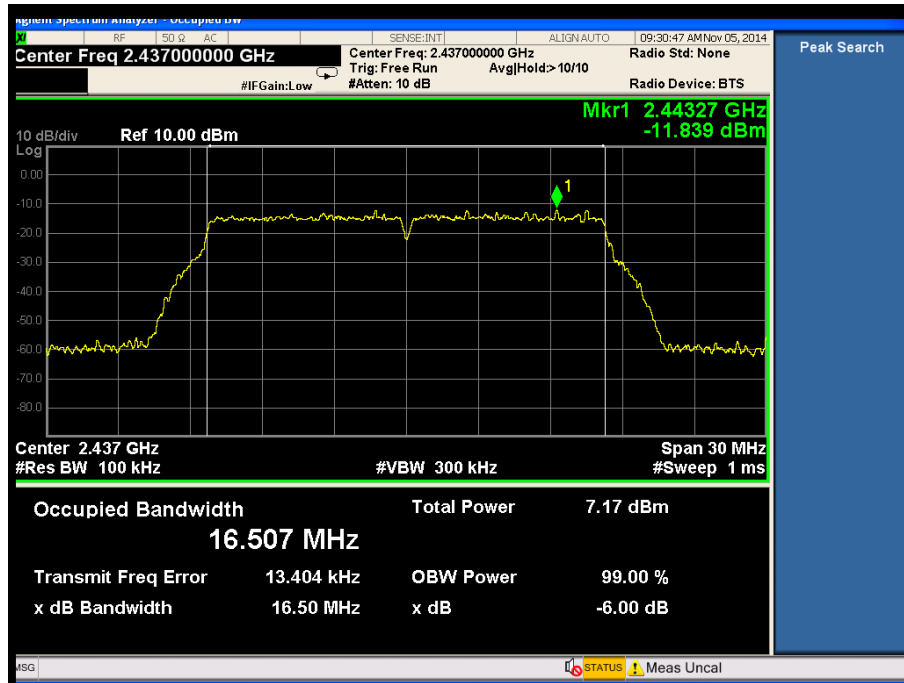

CH High :

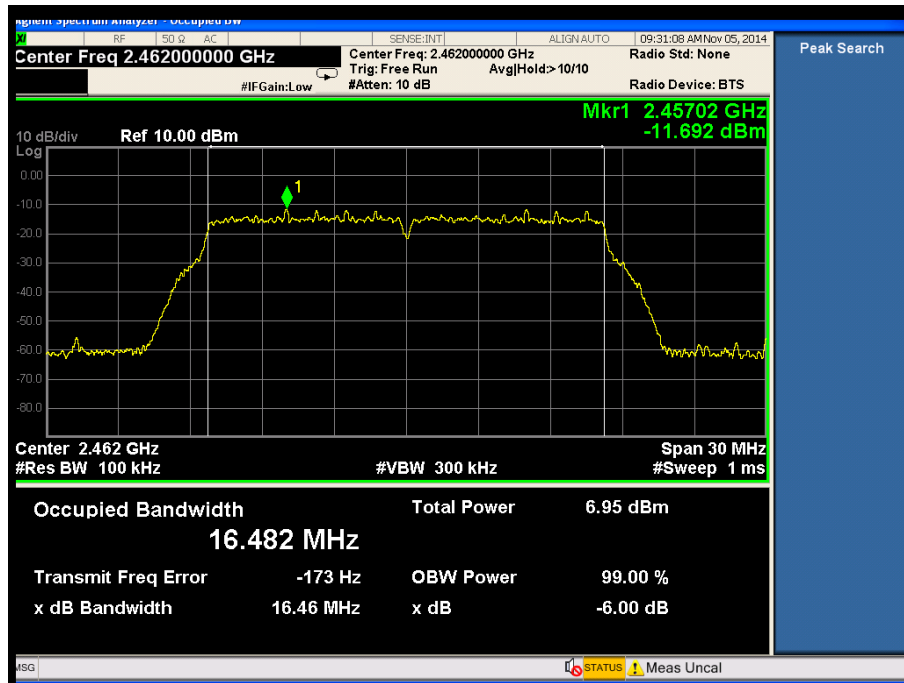

IEEE 802.11n/HT20 with 2.4G:
CH Low :

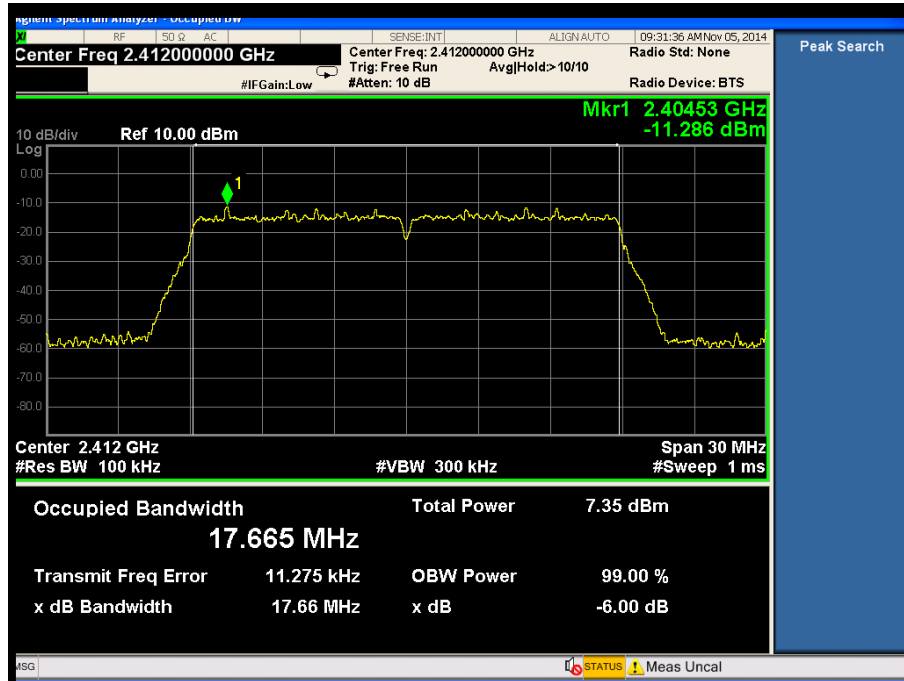

CH Mid :

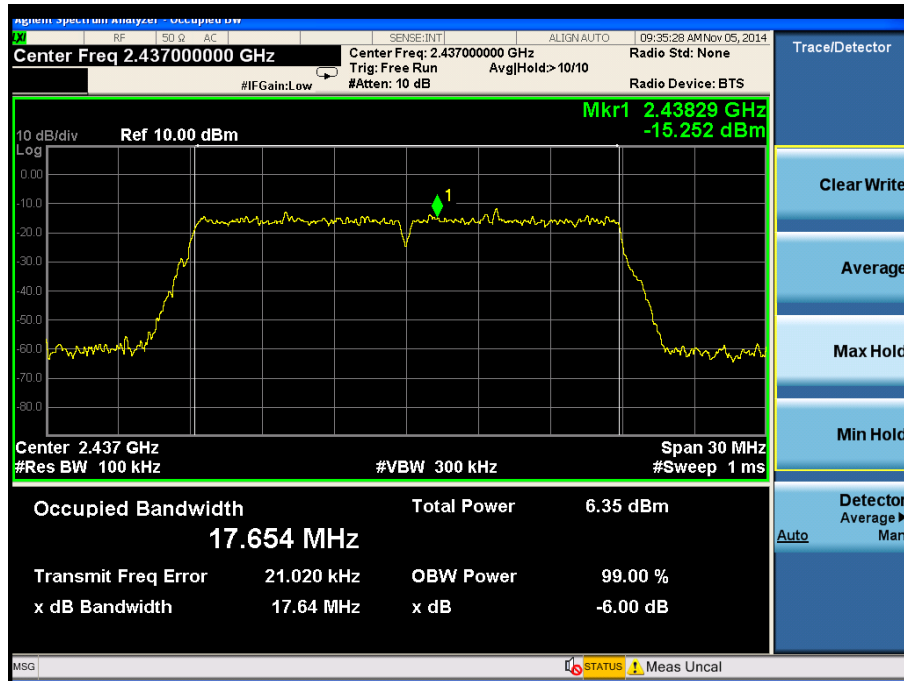

CH High :

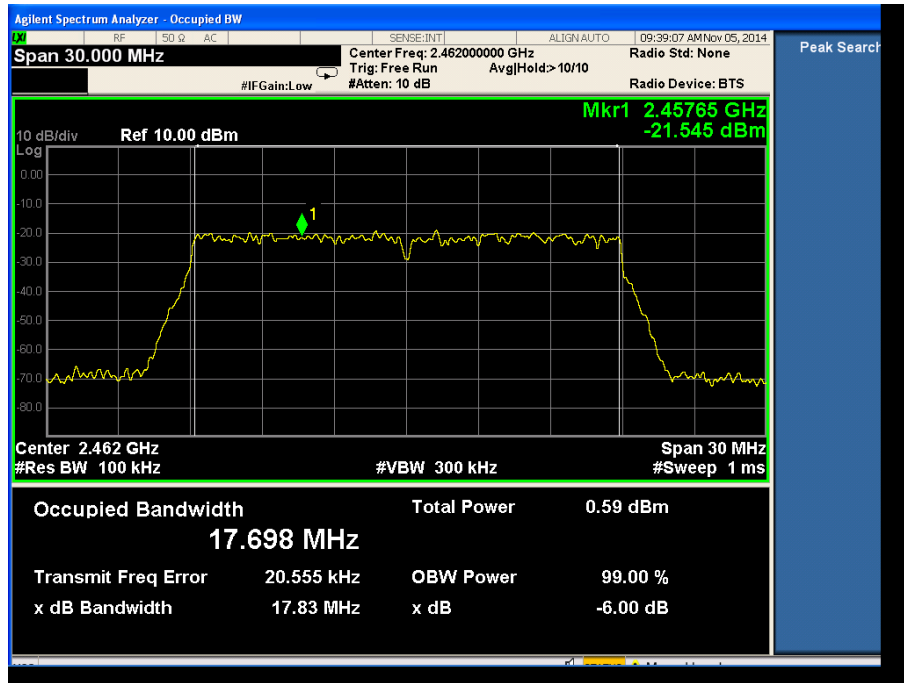

IEEE 802.11n/HT40 with 2.4G:

CH Low :

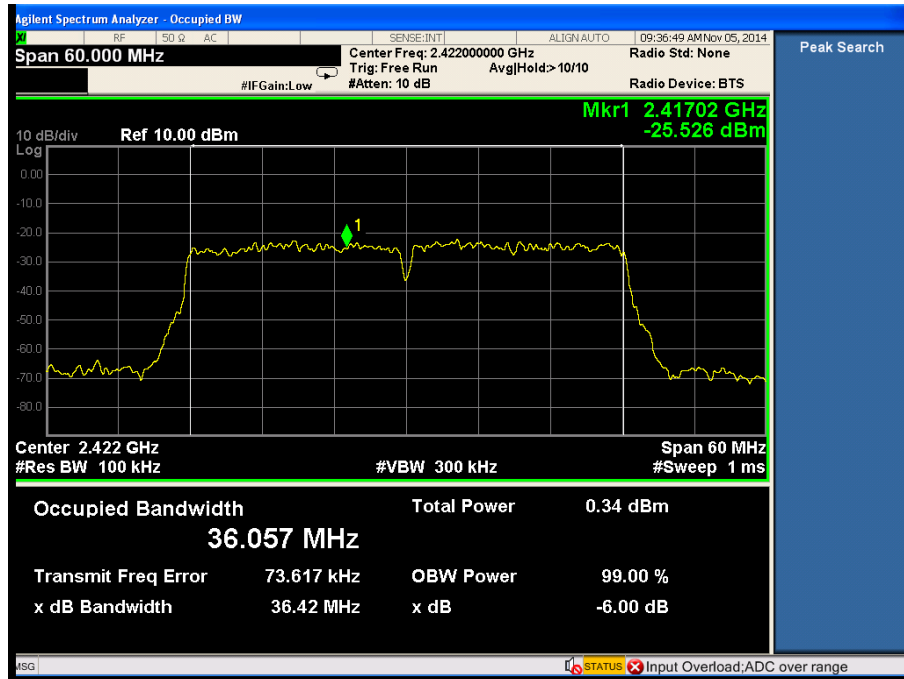

CH Mid :

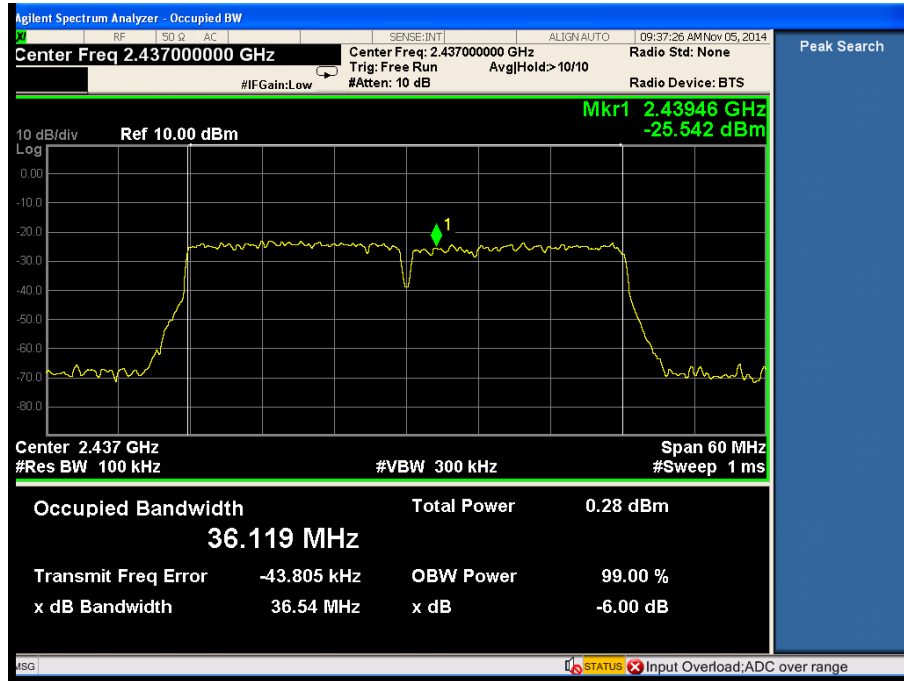

CH High :

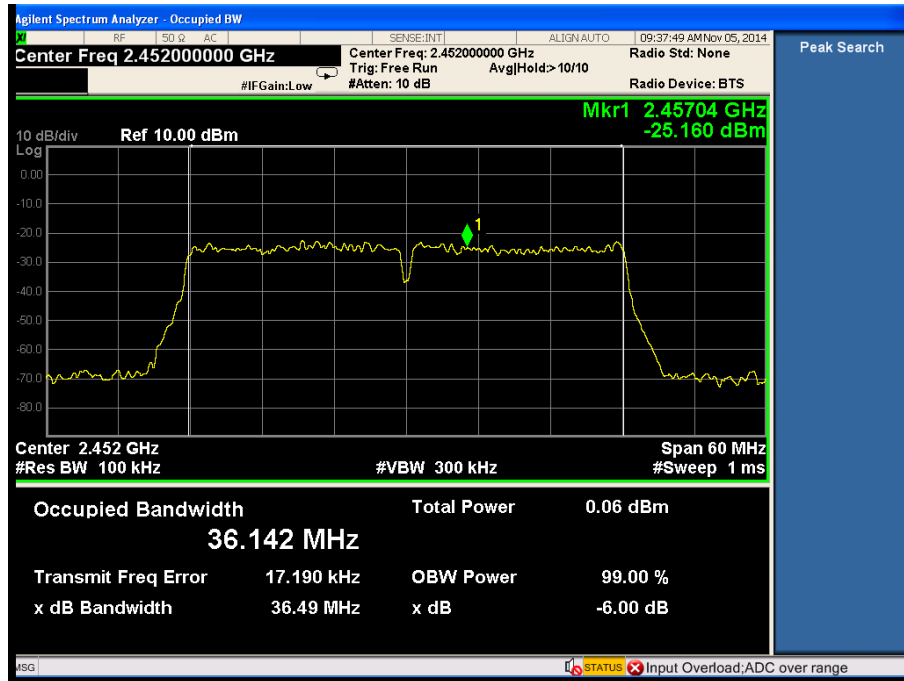

10 Band Edge Check

10.1 Test limit

Please refer section 15.247

All the lower and upper band-edges emissions appearing within 2310MHz to 2390MHz and 2483.5MHz to 2500MHz restricted frequency bands shall not exceed the limits shown in 15.209, all the other emissions outside operation frequency band 2400MHz to 2483.5MHz and 5725MHz to 5850MHz shall be at least 20dB below the fundamental emissions, or comply with 15.209 limits.

10.2 Test Procedure

- 12.2.1 Put the EUT on a 0.8m high table, power on the EUT. Emissions were scanned and measured rotating the EUT to 360 degrees, Find the maximum Emission
- 12.2.2 Check the spurious emissions out of band.
- 12.2.3 RBW,VBW Setting, please see the following test plot.

10.3 Test Setup

Same as 5.2.2.

10.4 Test Result

PASS.

Detailed information please see the following page.

IEEE 802.11b:
CH LOW :

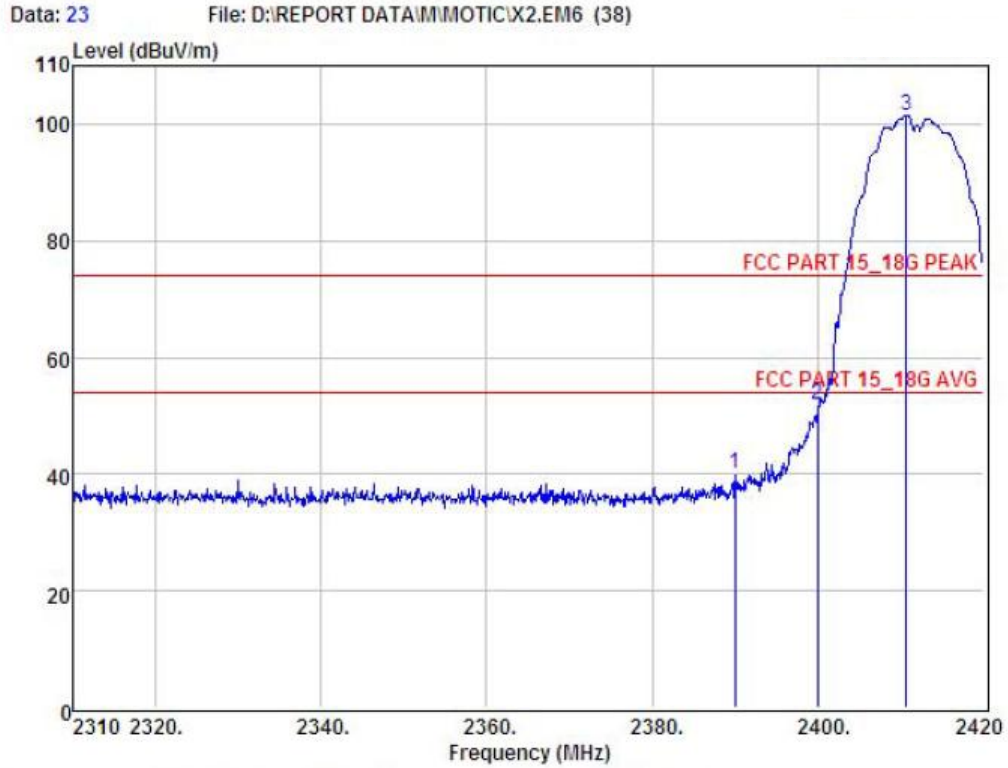

Condition : FCC PART 15_18G PEAK 3m POL: HORIZONTAL
 EUT : Moticam X2Smart Camera
 Model No : Moticam X2
 Test Mode : 802.11b 2412MHz
 Power : DC 5V from adapter with AC120V/60Hz
 Test Engineer :
 Remark :
 Temp :
 Hum :

Item	Freq MHz	Read Level dBuV	Antenna Factor dB	Preamp Factor dB	Cable Loss dB	Level dBuV	Limit dBuV	Margin dBuV	Remark
1	2390.00	43.49	27.62	34.97	3.92	40.06	74.00	-33.94	Peak
2	2400.00	55.24	27.62	34.97	3.94	51.83	74.00	-22.17	Peak
3	2410.65	104.97	27.61	34.97	3.94	101.55	74.00	27.55	Peak

Remark: Level = Read Level + Antenna Factor - Preamp Factor + Cable Loss

Data: 24 File: D:\REPORT DATA\MOTICAM\X2.EM6 (38)

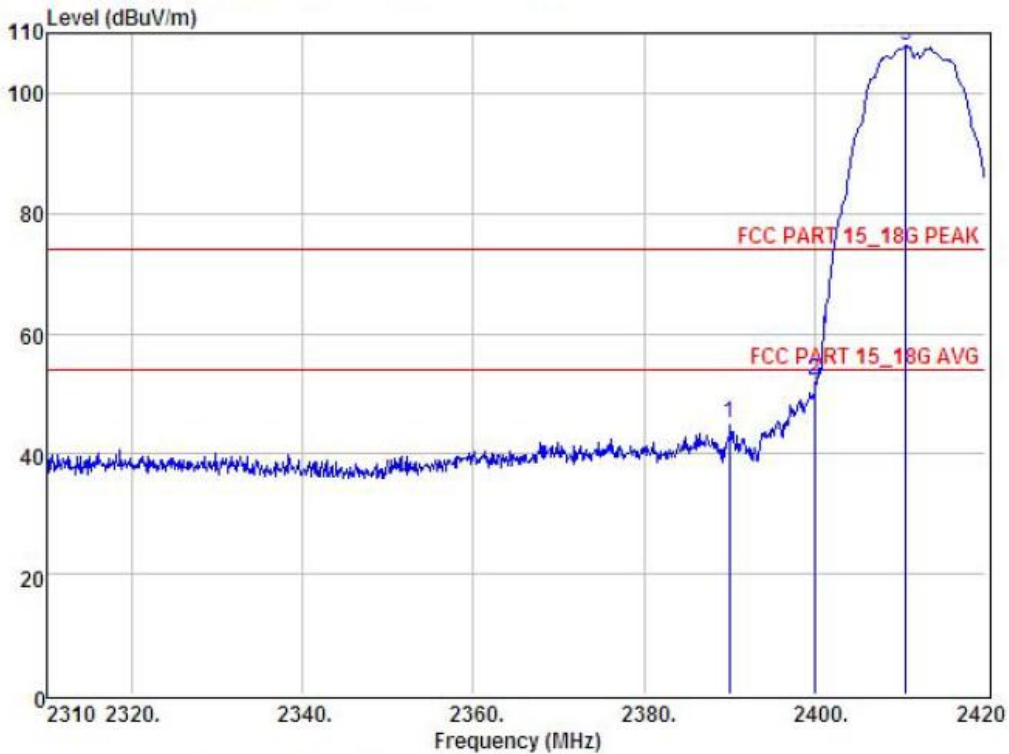

Condition : FCC PART 15_18G PEAK 3m POL: VERTICAL
 EUT : Moticom X2Smart Camera
 Model No : Moticom X2
 Test Mode : 802.11b 2412MHz
 Power : DC 5V from adapter with AC120V/60Hz
 Test Engineer :
 Remark :
 Temp :
 Hum :

Item	Freq MHz	Read Level dBuV	Antenna Factor dB	Preamp Factor dB	Cable Loss dB	Level dBuV	Limit dBuV	Margin dBuV	Remark
1	2390.00	48.47	27.62	34.97	3.92	45.04	74.00	-28.96	Peak
2	2400.00	55.48	27.62	34.97	3.94	52.07	74.00	-21.93	Peak
3	2410.65	111.35	27.61	34.97	3.94	107.93	74.00	33.93	Peak

Remark: Level = Read Level + Antenna Factor - Preamp Factor + Cable Loss

CH High :

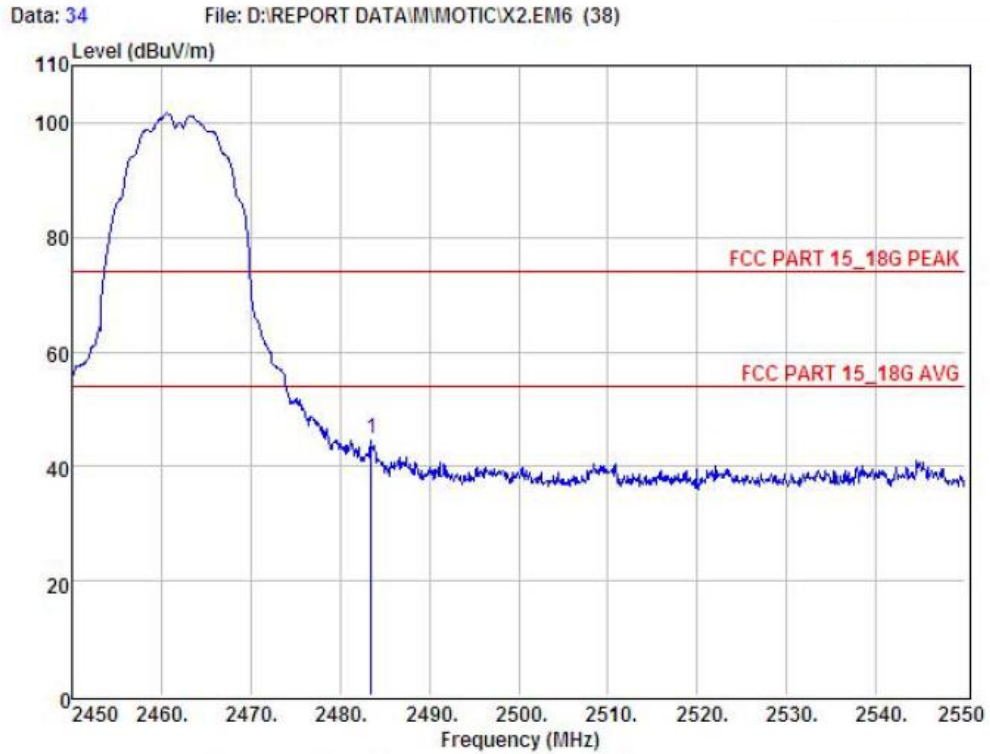

Condition : FCC PART 15_18G PEAK 3m POL: HORIZONTAL
 EUT : Moticam X2Smart Camera
 Model No : Moticam X2
 Test Mode : 802.11b 2462MHz
 Power : DC 5V from adapter with AC120V/60Hz
 Test Engineer :
 Remark :
 Temp :
 Hum :

Item	Freq MHz	Read Level dBuV	Antenna Factor dB	Preamp Factor dB	Cable Loss dB	Level dBuV	Limit dBuV	Margin dBuV	Remark
1	2483.50	48.14	27.59	34.97	4.00	44.76	74.00	-29.24	Peak

Remark: Level = Read Level + Antenna Factor - Preamp Factor + Cable Loss

Data: 33 File: D:\REPORT DATA\MMOTIC\X2.EM6 (38)

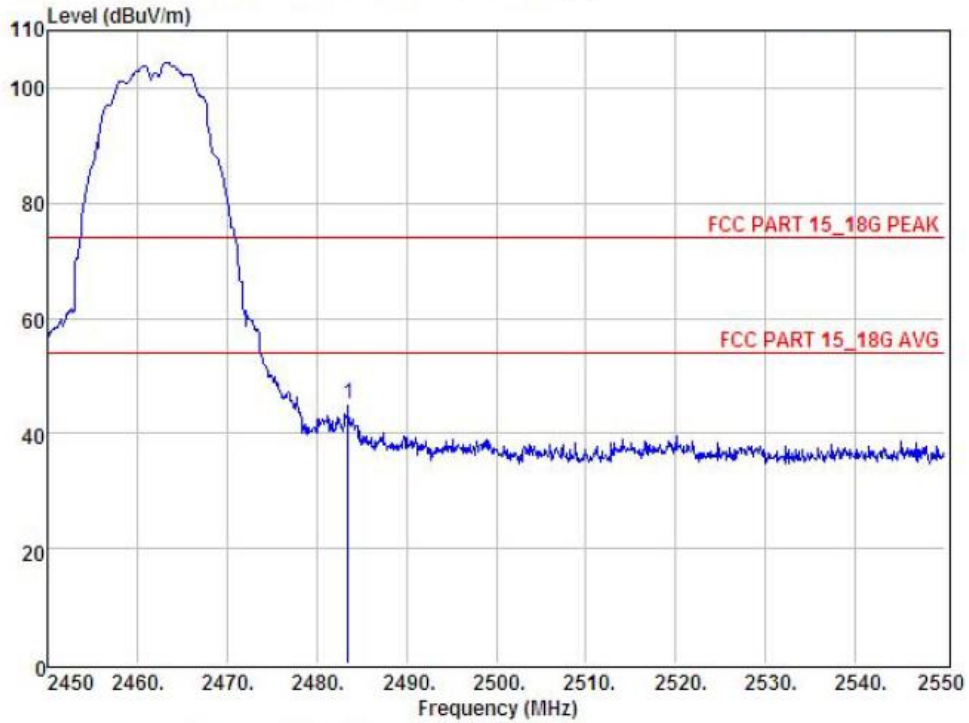

Condition : FCC PART 15_18G PEAK 3m POL: VERTICAL
 EUI : Moticam X2Smart Camera
 Model No : Moticam X2
 Test Mode : 802.11b 2462MHz
 Power : DC 5V from adapter with AC120V/60Hz
 Test Engineer :
 Remark :
 Temp :
 Hum :

Item	Freq MHz	Read Level dBuV	Antenna Factor dB	Preamp Factor dB	Cable Loss dB	Level dBuV	Limit dBuV	Margin dBuV	Remark
1	2483.50	48.55	27.59	34.97	4.00	45.17	74.00	-28.83	Peak

Remark: Level = Read Level + Antenna Factor - Preamp Factor + Cable Loss

IEEE 802.11g:
CH LOW :

Data: 26 File: D:\REPORT DATA\MMOTIC\X2.EM6 (38)

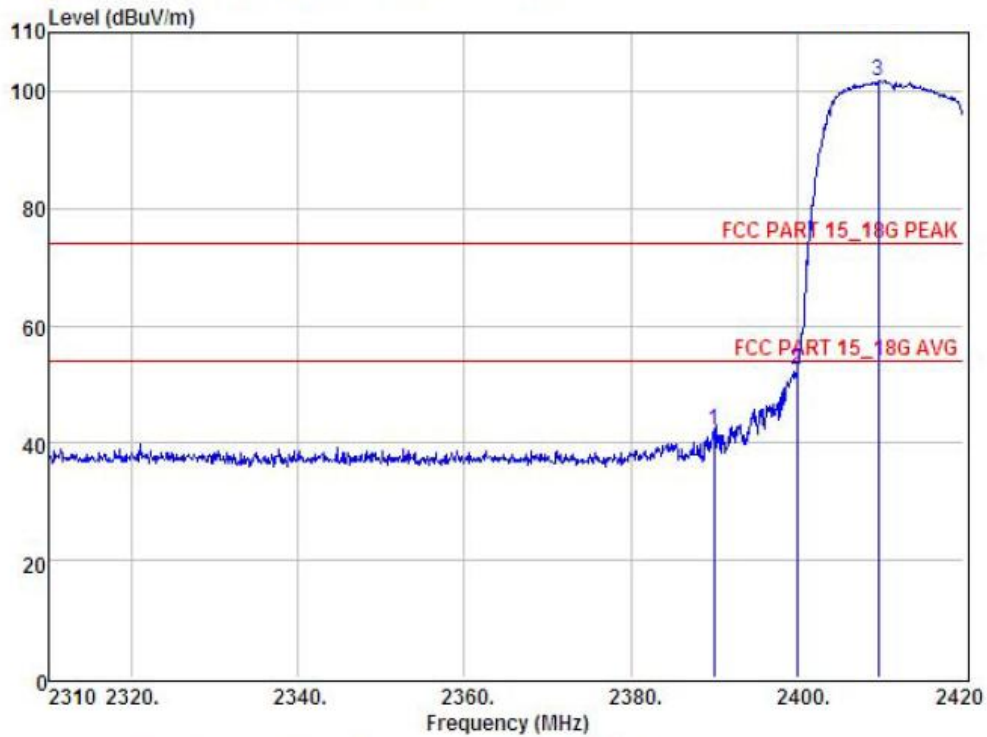

Condition : FCC PART 15_18G PEAK 3m POL: HORIZONTAL
 EUI : Moticom X2Smart Camera
 Model No : Moticom X2
 Test Mode : 802.11g 2412MHz
 Power : DC 5V from adapter with AC120V/60Hz
 Test Engineer :
 Remark :
 Temp :
 Hum :

Item	Freq MHz	Read Level dBuV	Antenna Factor dB	Preamp Factor dB	Cable Loss dB	Level dBuV	Limit dBuV	Margin dBuV	Remark
1	2390.00	45.60	27.62	34.97	3.92	42.17	74.00	-31.83	Peak
2	2400.00	55.96	27.62	34.97	3.94	52.55	74.00	-21.45	Peak
3	2409.77	105.15	27.61	34.97	3.94	101.73	74.00	27.73	Peak

Remark: Level = Read Level + Antenna Factor - Preamp Factor + Cable Loss

Data: 25 File: D:\REPORT DATA\MMOTIC\X2.EM6 (38)

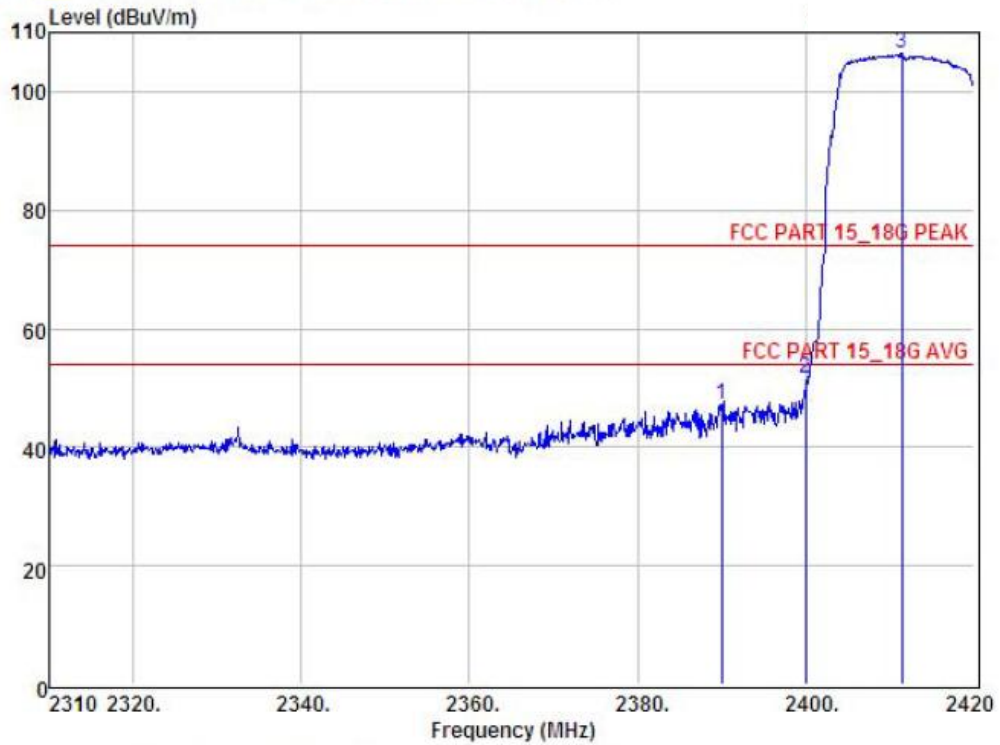

Condition : FCC PART 15_18G PEAK 3m POL: VERTICAL
 EUT : Moticam X2Smart Camera
 Model No : Moticam X2
 Test Mode : 802.11g 2412MHz
 Power : DC 5V from adapter with AC120V/60Hz
 Test Engineer :
 Remark :
 Temp :
 Hum :

Item	Freq MHz	Read Level dBuV	Antenna Factor dB	Preamp Factor dB	Cable Loss dB	Level dBuV	Limit dBuV	Margin dBuV	Remark
1	2390.00	50.74	27.62	34.97	3.92	47.31	74.00	-26.69	Peak
2	2400.00	55.13	27.62	34.97	3.94	51.72	74.00	-22.28	Peak
3	2411.42	110.02	27.61	34.97	3.94	106.60	74.00	32.60	Peak

Remark: Level = Read Level + Antenna Factor - Preamp Factor + Cable Loss

CH High :

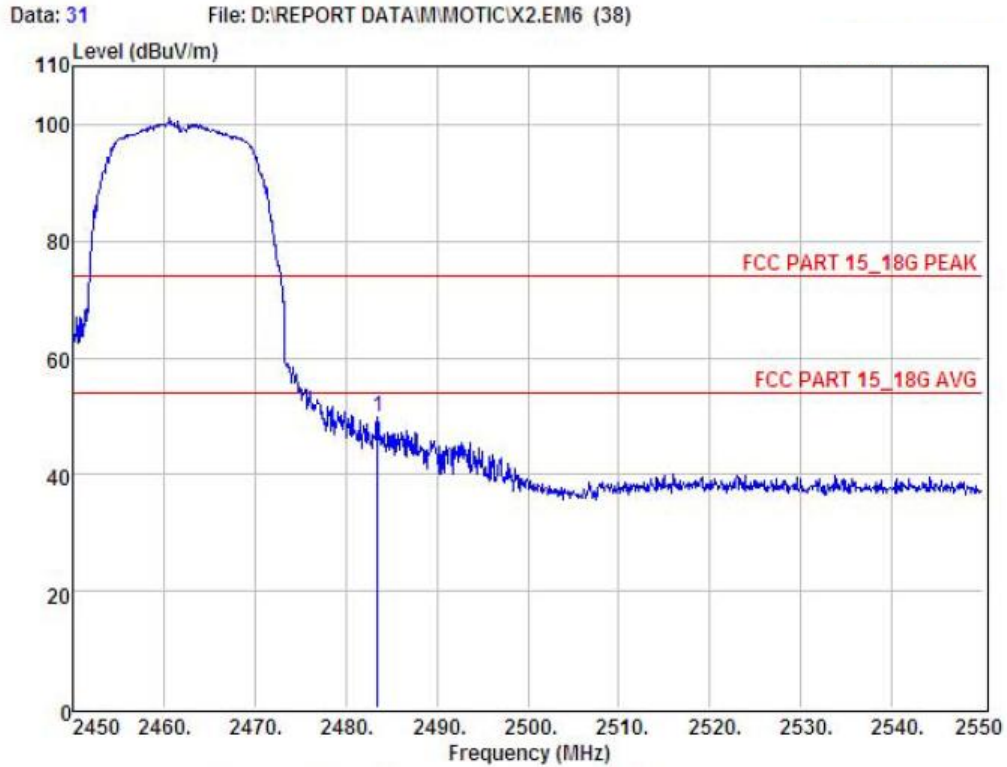

```

Condition      : FCC PART 15_18G PEAK 3m      POL: HORIZONTAL
EUT            : Moticam X2Smart Camera
Model No       : Moticam X2
Test Mode      : 802.11g 2462MHz
Power          : DC 5V from adapter with AC120V/60Hz
Test Engineer  :
Remark         :
Temp           :
Hum            :
    
```

Item	Freq MHz	Read Level dBuV	Antenna Factor dB	Preamp Factor dB	Cable Loss dB	Level dBuV	Limit dBuV	Margin dBuV	Remark
1	2483.50	53.13	27.59	34.97	4.00	49.75	74.00	-24.25	Peak

Remark: Level = Read Level + Antenna Factor - Preamp Factor + Cable Loss

CH High

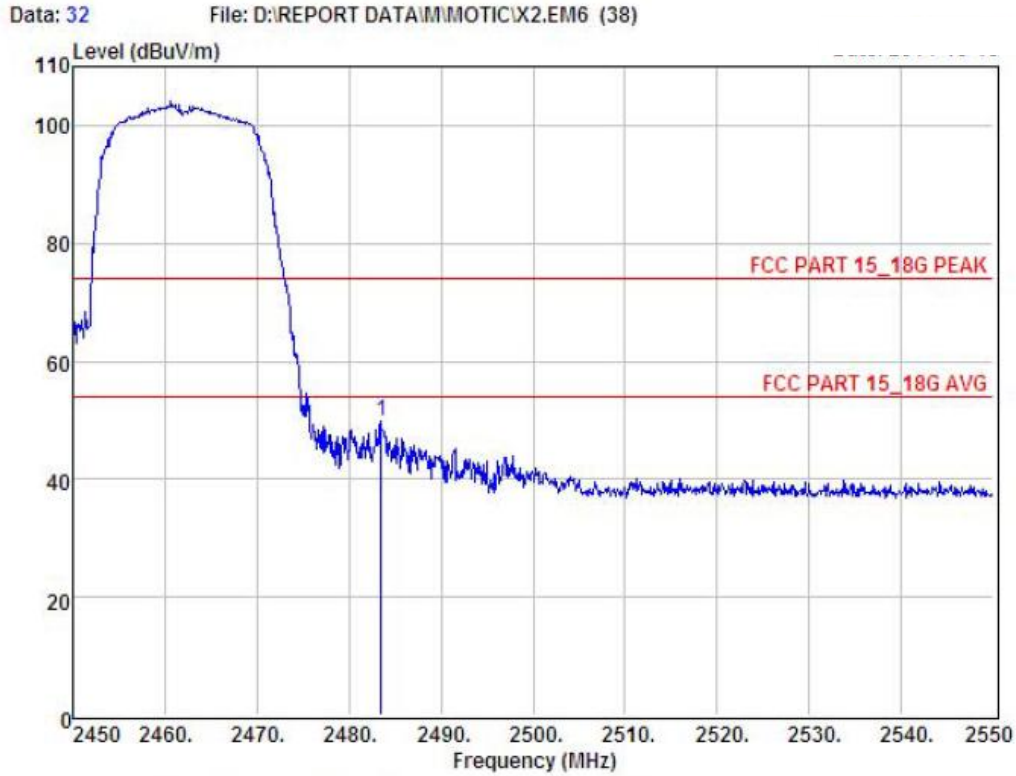

Condition : FCC PART 15_18G PEAK 3m POL: VERTICAL
 EUT : Moticam X2Smart Camera
 Model No : Moticam X2
 Test Mode : 802.11g 2462MHz
 Power : DC 5V from adapter with AC120V/60Hz
 Test Engineer :
 Remark :
 Temp :
 Hum :

Item	Freq MHz	Read Level dBuV	Antenna Factor dB	Preamp Factor dB	Cable Loss dB	Level dBuV	Limit dBuV	Margin dBuV	Remark
1	2483.50	53.25	27.59	34.97	4.00	49.87	74.00	-24.13	Peak

Remark: Level = Read Level + Antenna Factor - Preamp Factor + Cable Loss

IEEE 802.11n/HT20 with 2.4G:
CH LOW :

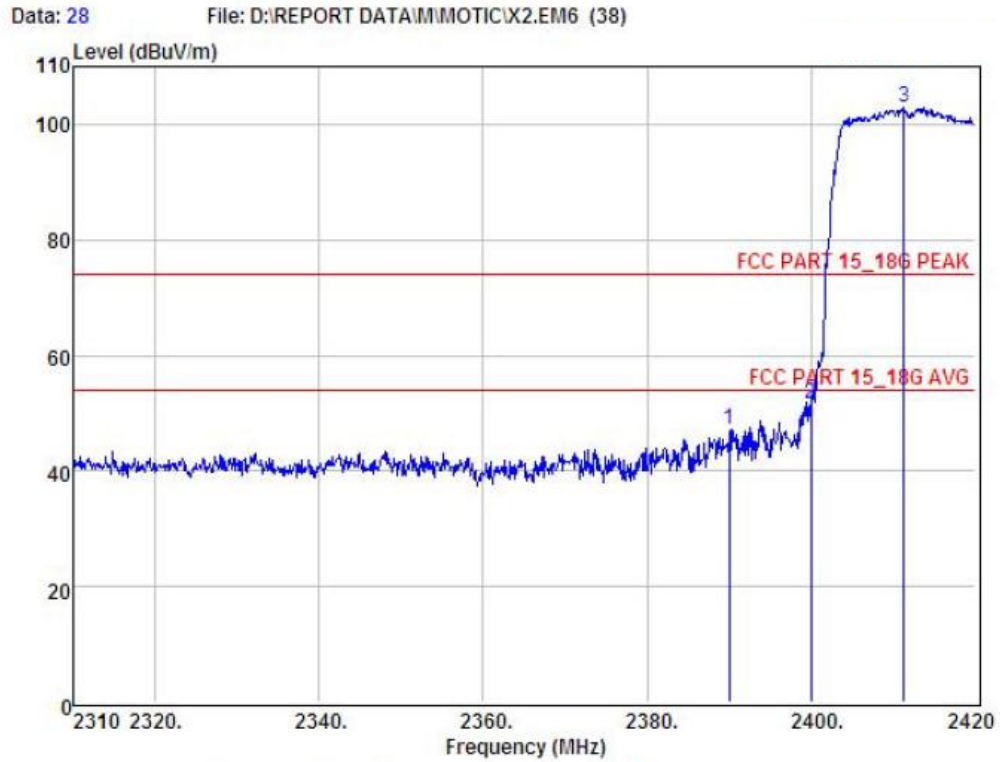

Condition : FCC PART 15_18G PEAK 3m POL: HORIZONTAL
 EUT : Moticom X2Smart Camera
 Model No : Moticom X2
 Test Mode : 802.11n/HT20 2412MHz
 Power : DC 5V from adapter with AC120V/60Hz
 Test Engineer :
 Remark :
 Temp :
 Hum :

Item	Freq MHz	Read Level dBuV	Antenna Factor dB	Preamp Factor dB	Cable Loss dB	Level dBuV	Limit dBuV	Margin dBuV	Remark
1	2390.00	50.49	27.62	34.97	3.92	47.06	74.00	-26.94	Peak
2	2400.00	55.14	27.62	34.97	3.94	51.73	74.00	-22.27	Peak
3	2411.31	106.34	27.61	34.97	3.94	102.92	74.00	28.92	Peak

Remark: Level = Read Level + Antenna Factor - Preamp Factor + Cable Loss

Data: 27 File: D:\REPORT DATA\MOTICAM\X2.EM6 (38)

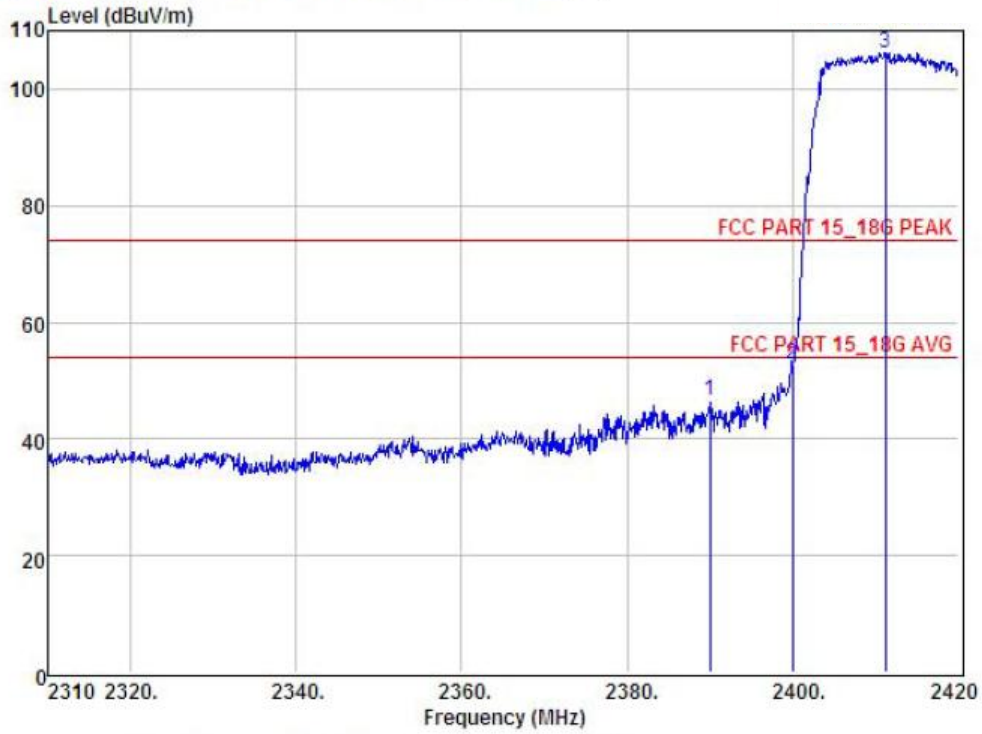

Condition : FCC PART 15_18G PEAK 3m POL: VERTICAL
 EUI : Moticam X2Smart Camera
 Model No : Moticam X2
 Test Mode : 802.11n/HT20 2412MHz
 Power : DC 5V from adapter with AC120V/60Hz
 Test Engineer :
 Remark :
 Temp :
 Hum :

Item	Freq MHz	Read Level dBuV	Antenna Factor dB	Preamp Factor dB	Cable Loss dB	Level dBuV	Limit dBuV	Margin dBuV	Remark
1	2390.00	49.96	27.62	34.97	3.92	46.53	74.00	-27.47	Peak
2	2400.00	56.25	27.62	34.97	3.94	52.84	74.00	-21.16	Peak
3	2411.20	109.68	27.61	34.97	3.94	106.26	74.00	32.26	Peak

Remark: Level = Read Level + Antenna Factor - Preamp Factor + Cable Loss

CH High :

Data: 30 File: D:\REPORT DATA\MMOTIC\X2.EM6 (38)

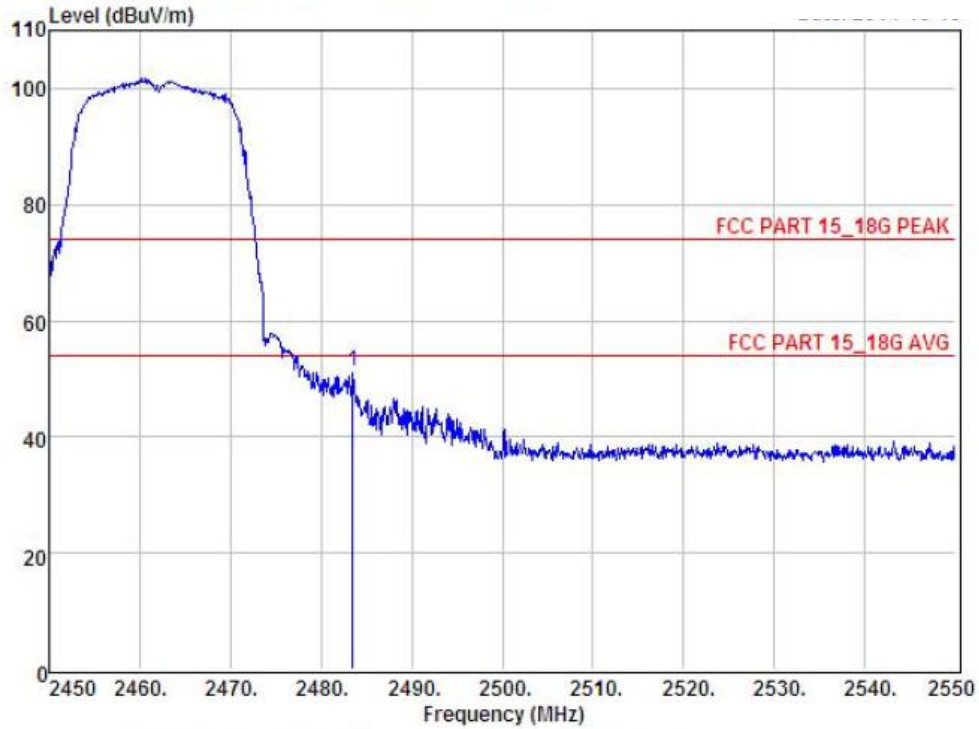

Condition : FCC PART 15_18G PEAK 3m POL: HORIZONTAL
 EUT : Moticam X2Smart Camera
 Model No : Moticam X2
 Test Mode : 802.11n/HT20 2462MHz
 Power : DC 5V from adapter with AC120V/60Hz
 Test Engineer :
 Remark :
 Temp :
 Hum :

Item	Freq MHz	Read Level dBuV	Antenna Factor dB	Preamp Factor dB	Cable Loss dB	Level dBuV	Limit dBuV	Margin dBuV	Remark
1	2483.50	54.76	27.59	34.97	4.00	51.38	74.00	-22.62	Peak

Remark: Level = Read Level + Antenna Factor - Preamp Factor + Cable Loss

Data: 29 File: D:\REPORT DATA\MMOTIC\X2.EM6 (38)

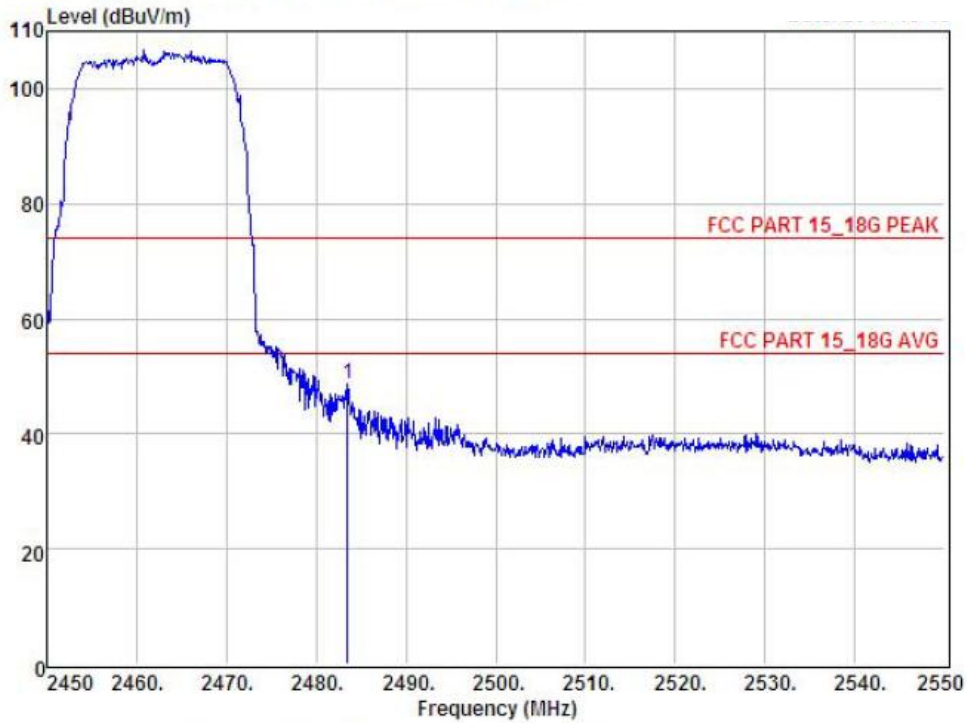

Condition : FCC PART 15_18G PEAK 3m POL: VERTICAL
 EUT : Moticam X2Smart Camera
 Model No : Moticam X2
 Test Mode : 802.11n/HT20 2462MHz
 Power : DC 5V from adapter with AC120V/60Hz
 Test Engineer :
 Remark :
 Temp :
 Hum :

Item	Freq MHz	Read Level dBuV	Antenna Factor dB	Preamp Factor dB	Cable Loss dB	Level dBuV	Limit dBuV	Margin dBuV	Remark
1	2483.50	52.04	27.59	34.97	4.00	48.66	74.00	-25.34	Peak

Remark: Level = Read Level + Antenna Factor - Preamp Factor + Cable Loss

IEEE 802.11n/HT40 with 2.4G:
CH LOW :

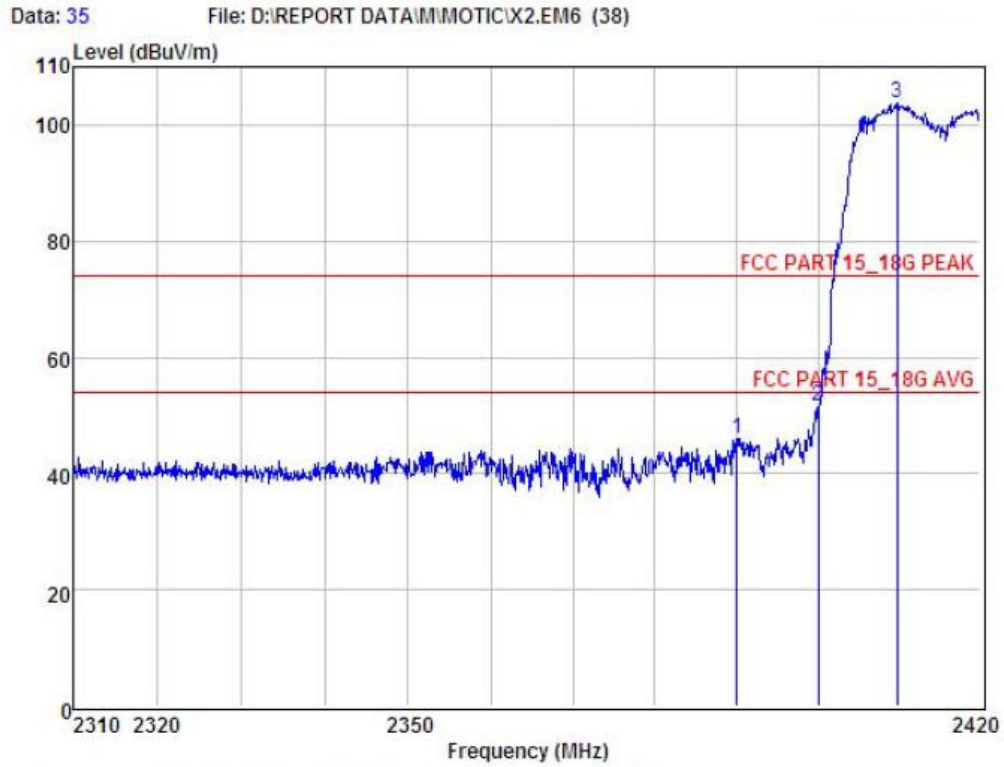

Condition : FCC PART 15_18G PEAK 3m POL: HORIZONTAL
 EUT : Moticom X2Smart Camera
 Model No : Moticom X2
 Test Mode : 802.11n/HT40 Low
 Power : DC 5V from adapter with AC120V/60Hz
 Test Engineer :
 Remark :
 Temp : 25.2°C
 Hum : 56%

Item	Freq MHz	Read Level dBuV	Antenna Factor dB	Preamp Factor dB	Cable Loss dB	Level dBuV	Limit dBuV	Margin dBuV	Remark
1	2390.00	49.36	27.62	34.97	3.92	45.93	74.00	-28.07	Peak
2	2400.00	54.95	27.62	34.97	3.94	51.54	74.00	-22.46	Peak
3	2409.78	107.15	27.61	34.97	3.94	103.73	74.00	29.73	Peak

Remark: Level = Read Level + Antenna Factor - Preamp Factor + Cable Loss

Data: 36 File: D:\REPORT DATA\MMOTIC\X2.EM6 (38)

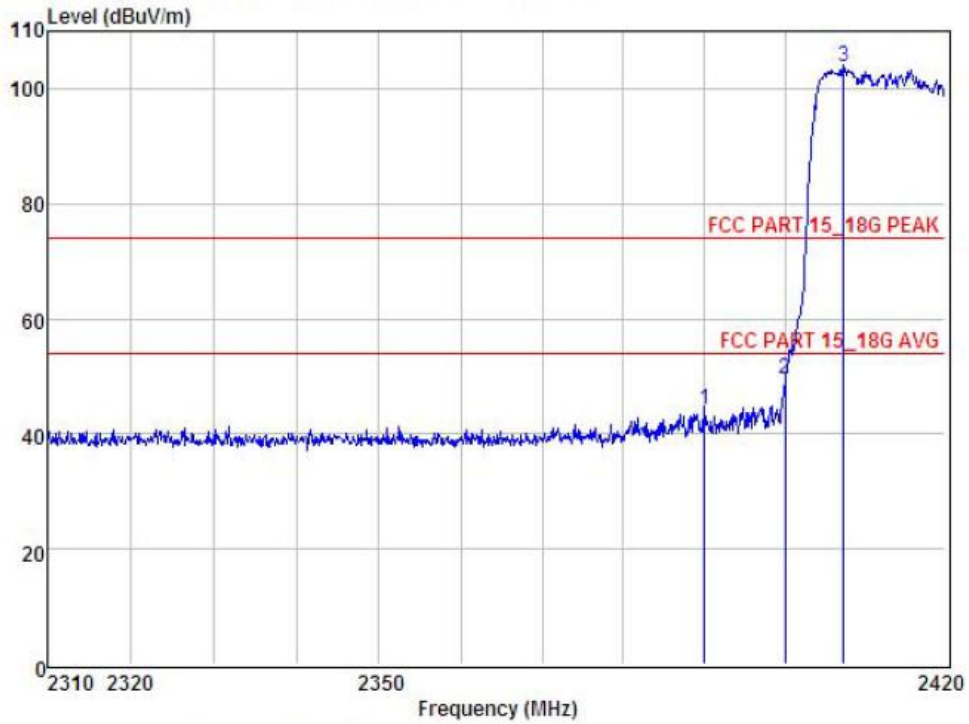

Condition : FCC PART 15_18G PEAK 3m POL: VERTICAL
 EUT : Moticam X2Smart Camera
 Model No : Moticam X2
 Test Mode : 802.11n/HT40 Low
 Power : DC 5V from adapter with AC120V/60Hz
 Test Engineer :
 Remark :
 Temp : 25.2°C
 Hum : 56%

Item	Freq MHz	Read Level dBuV	Antenna Factor dB	Preamp Factor dB	Cable Loss dB	Level dBuV	Limit dBuV	Margin dBuV	Remark
1	2390.00	47.66	27.62	34.97	3.92	44.23	74.00	-29.77	Peak
2	2400.00	53.08	27.62	34.97	3.94	49.67	74.00	-24.33	Peak
3	2407.31	107.21	27.61	34.97	3.94	103.79	74.00	29.79	Peak

Remark: Level = Read Level + Antenna Factor - Preamp Factor + Cable Loss

CH High

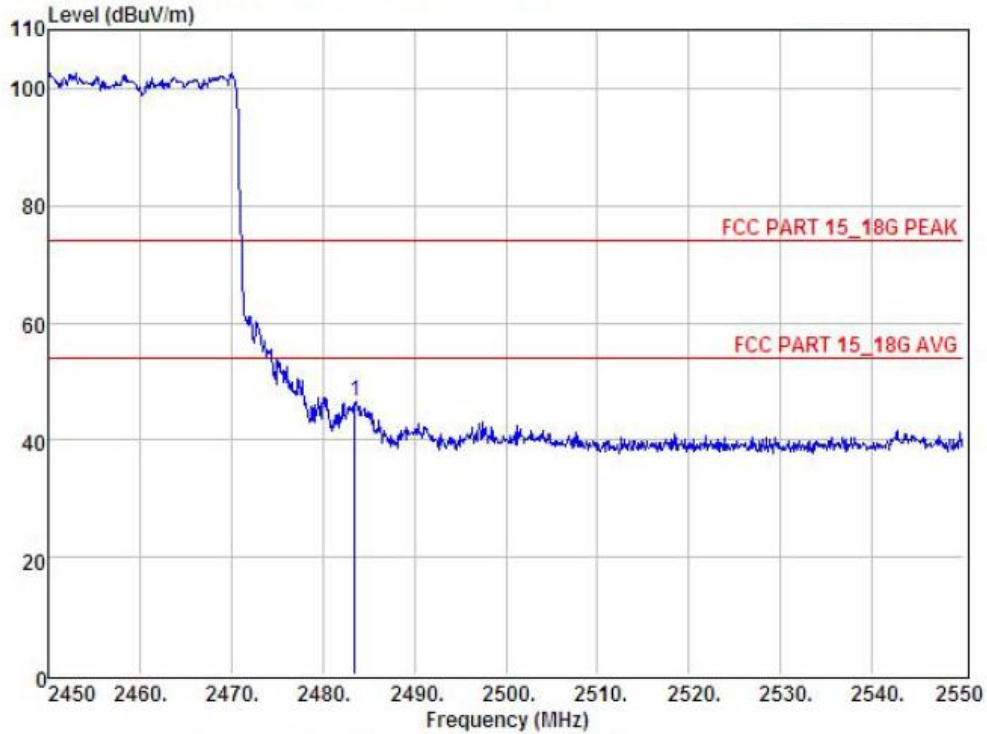

Condition : FCC PART 15_18G PEAK 3m POL: HORIZONTAL
 EUI : Moticam X2Smart Camera
 Model No : Moticam X2
 Test Mode : 802.11n/HT40 High
 Power : DC 5V from adapter with AC120V/60Hz
 Test Engineer :
 Remark :
 Temp : 25.2°C
 Hum : 56%

Item	Freq MHz	Read Level dBuV	Antenna Factor dB	Preamp Factor dB	Cable Loss dB	Level dBuV	Limit dBuV	Margin dBuV	Remark
1	2483.50	49.84	27.59	34.97	4.00	46.46	74.00	-27.54	Peak

Remark: Level = Read Level + Antenna Factor - Preamp Factor + Cable Loss

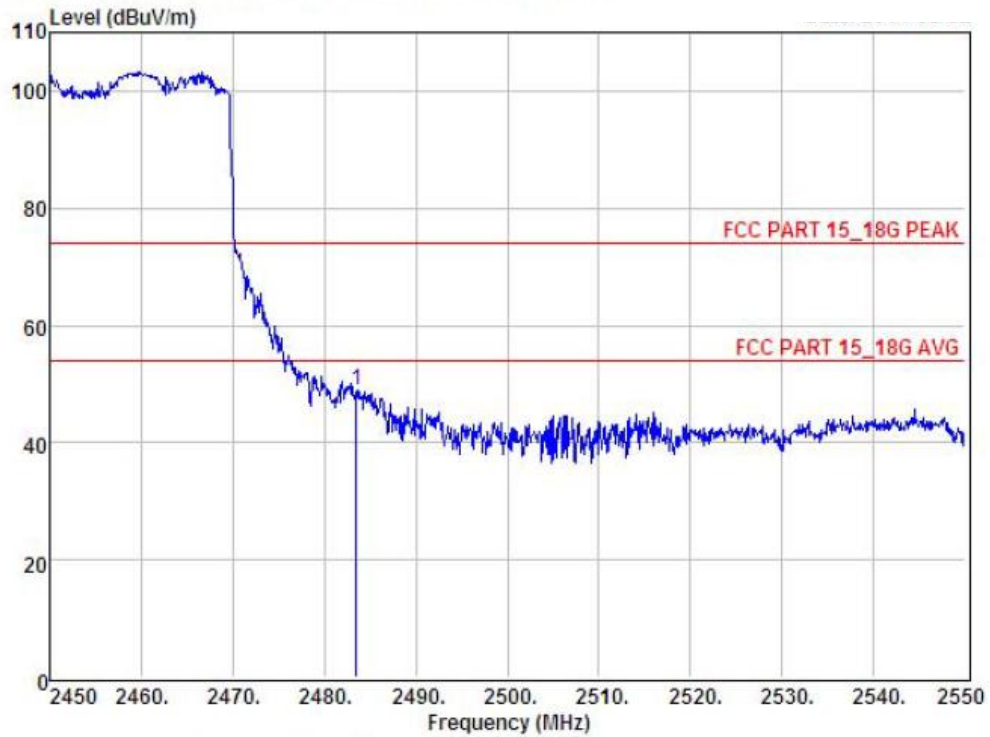

Condition : FCC PART 15_18G PEAK 3m POL: VERTICAL
 EUI : Moticam X2Smart Camera
 Model No : Moticam X2
 Test Mode : 802.11n/HT40 High
 Power : DC 5V from adapter with AC120V/60Hz
 Test Engineer :
 Remark :
 Temp : 25.2°C
 Hum : 56%

Item	Freq MHz	Read Level dBuV	Antenna Factor dB	Preamp Factor dB	Cable Loss dB	Level dBuV	Limit dBuV	Margin dBuV	Remark
1	2483.50	52.45	27.59	34.97	4.00	49.07	74.00	-24.93	

Remark: Level = Read Level + Antenna Factor - Preamp Factor + Cable Loss

11 Antenna Requirement

11.1 Standard Requirement

An intentional radiator shall be designed to ensure that no antenna other than that furnished by the responsible party shall be used with the device. The use of a permanently attached antenna or of an antenna that uses a unique coupling to the intentional radiator shall be considered sufficient to comply with the provisions of this Section. The manufacturer may design the unit so that a broken antenna can be replaced by the user, but the use of a standard antenna jack or electrical connector is prohibited.

11.2 Antenna Connected Construction

The directional gains of antenna used for transmitting is 2.5 dBi, and the antenna is a printed antenna and no consideration of replacement. Please see EUT photo for details.

11.3 Result

The EUT antenna is Integral Antenna. It comply with the standard requirement.

12 Photographs of Test Setup

Photographs-Radiated Emission Test Setup in Chamber Below 1G

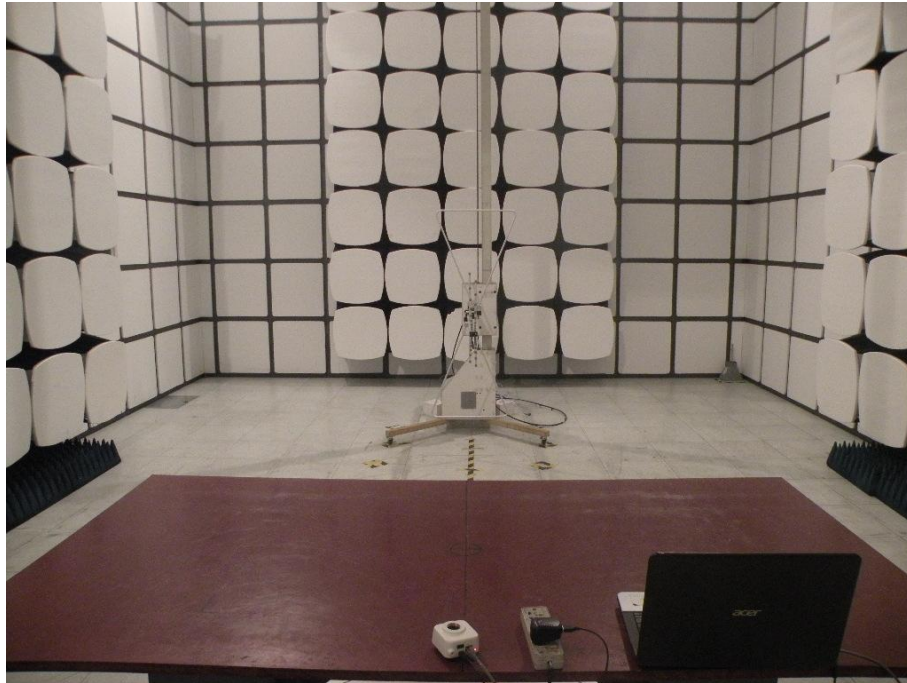

Above 1G

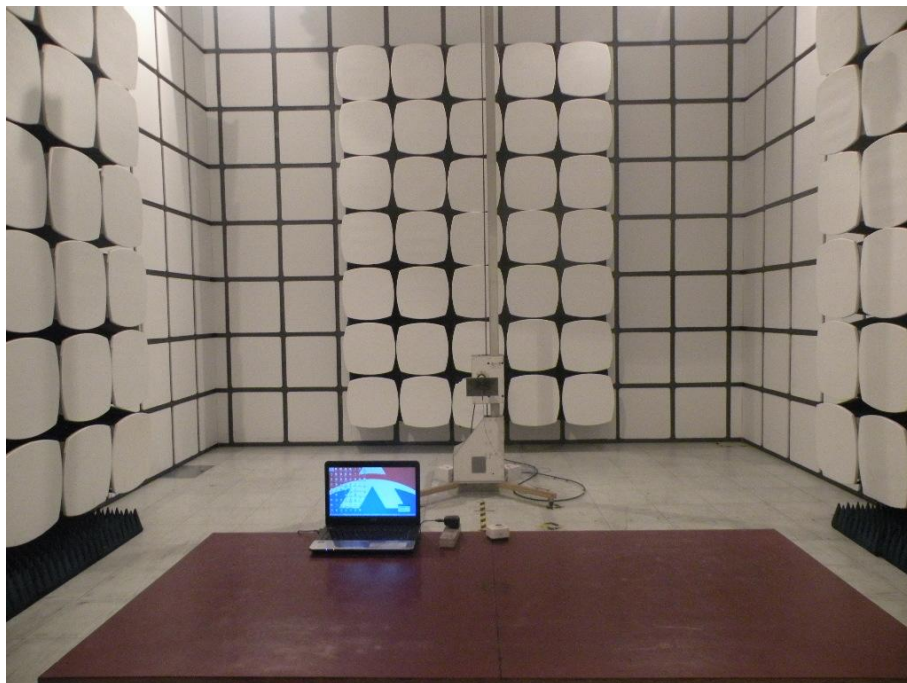

Photographs-Conducted Emission Test Setup



13 Photographs of EUT





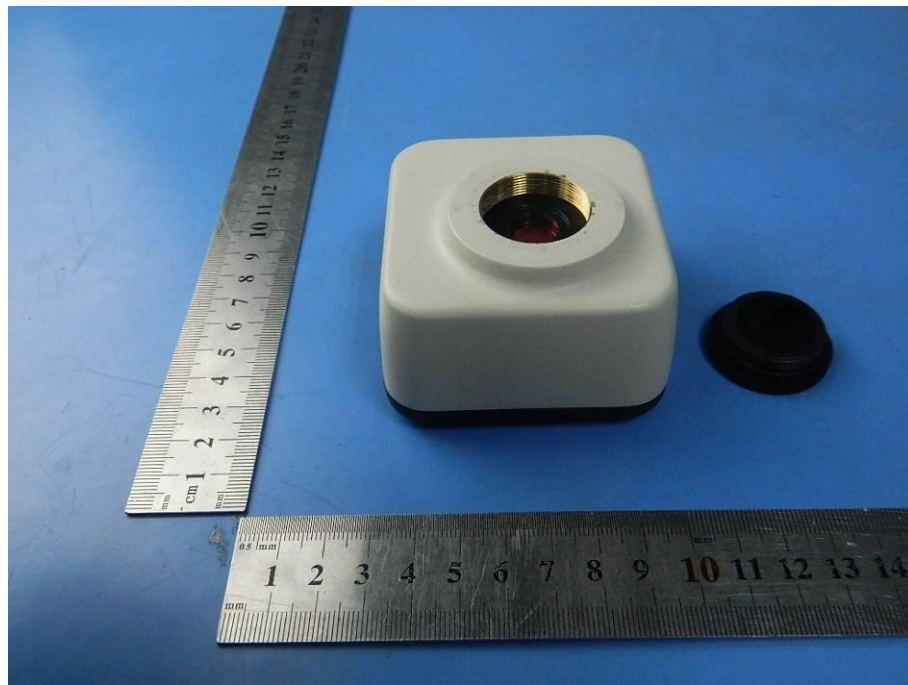



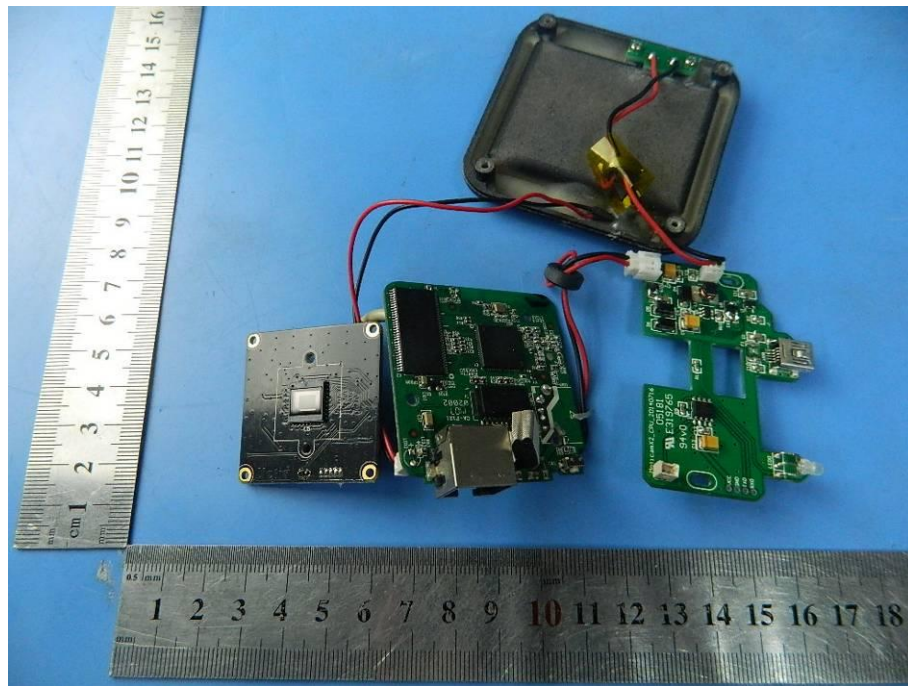
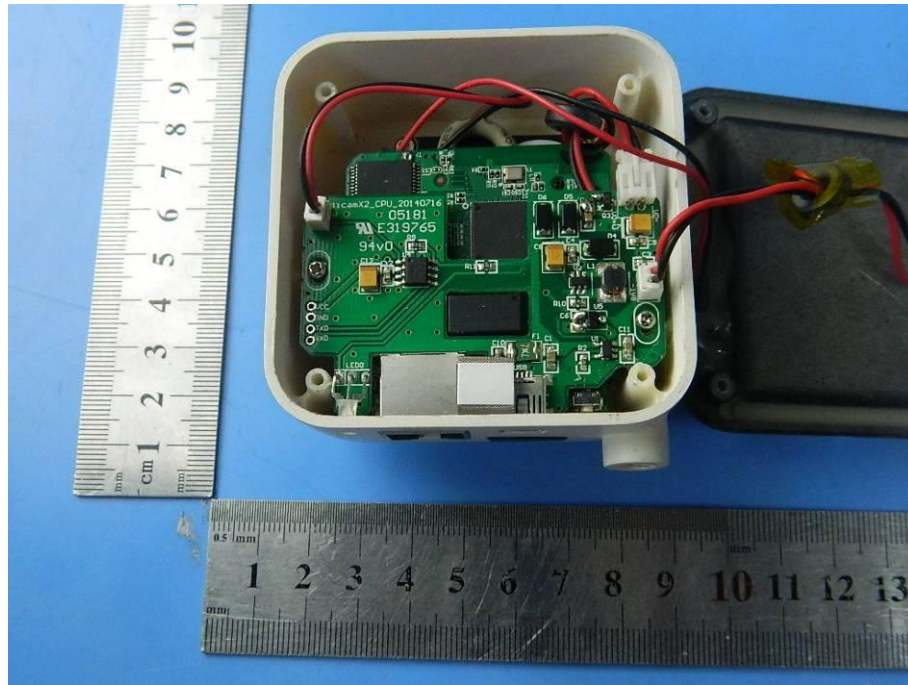

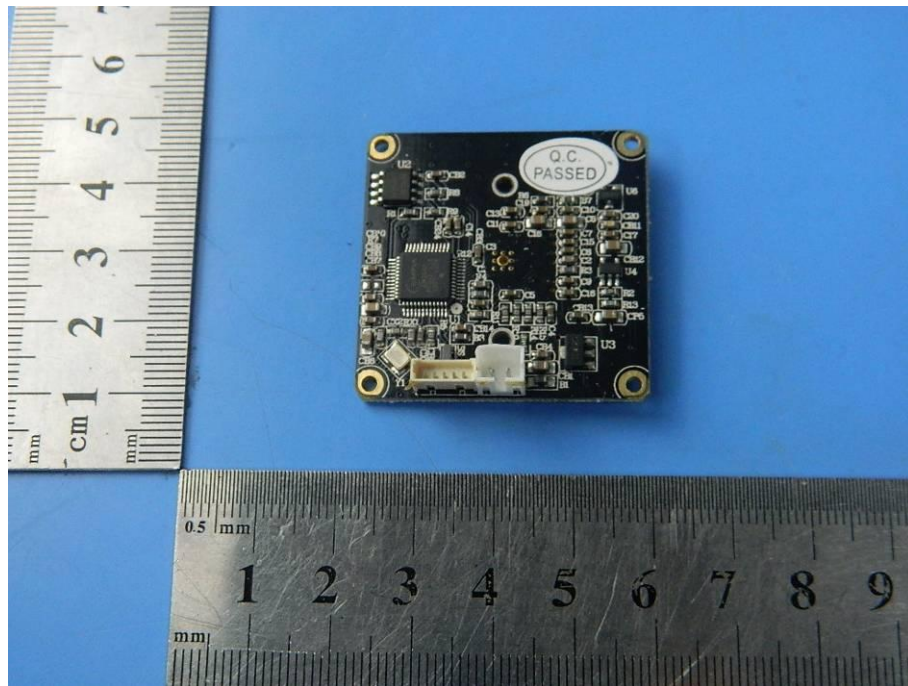
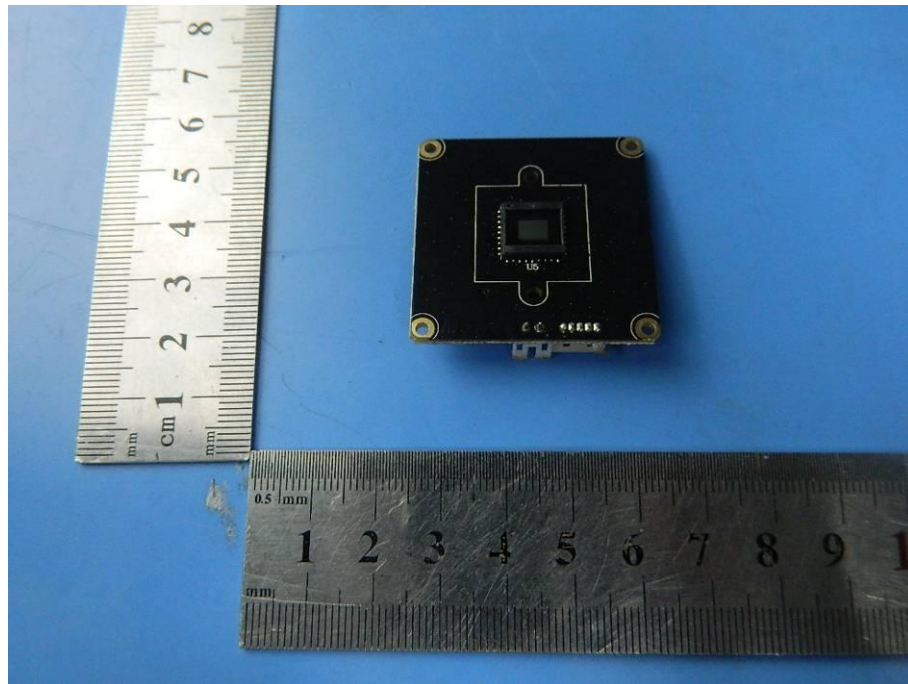

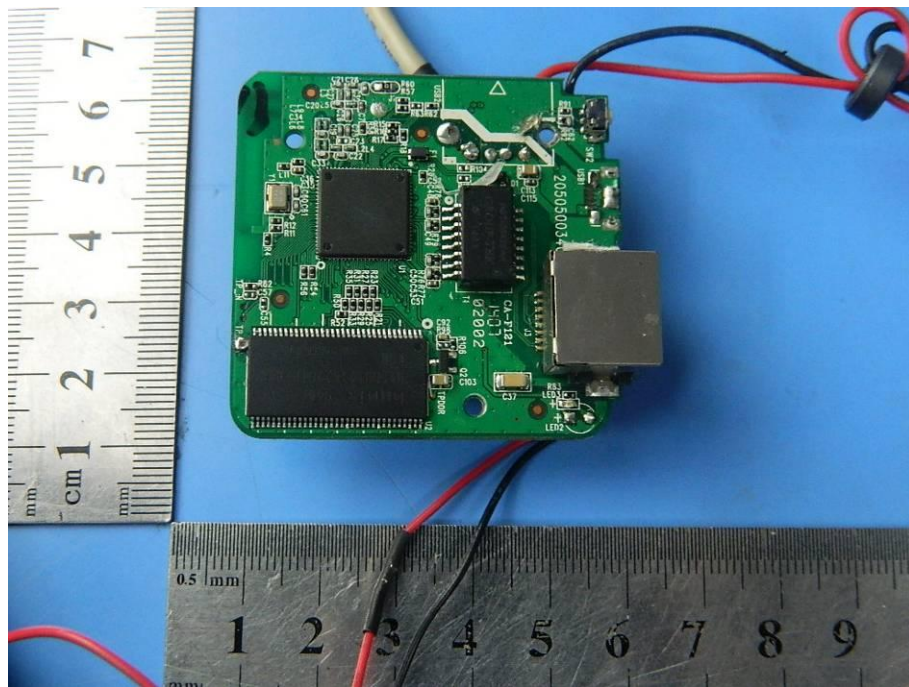
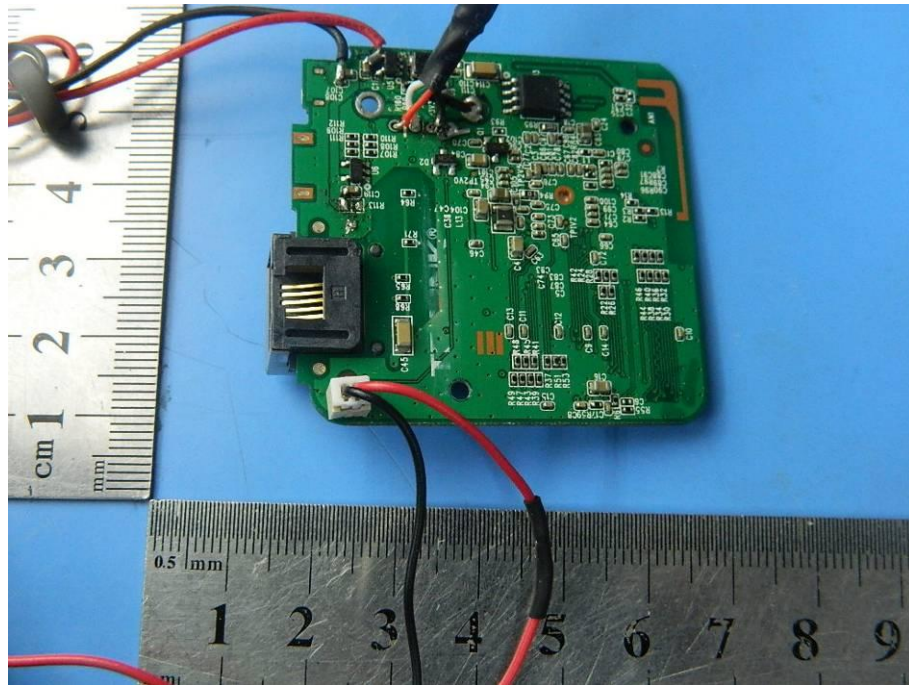

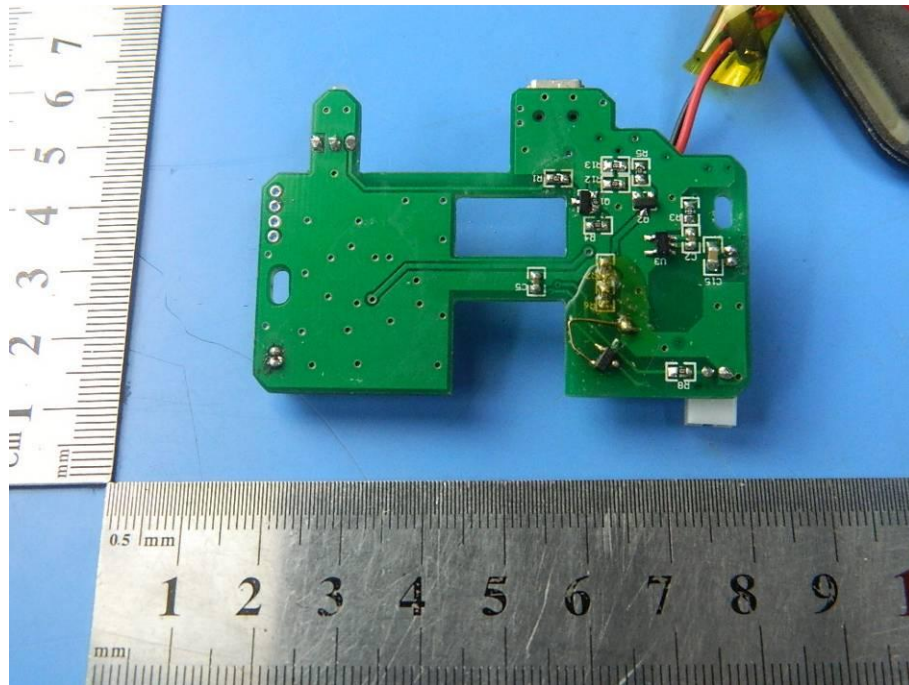
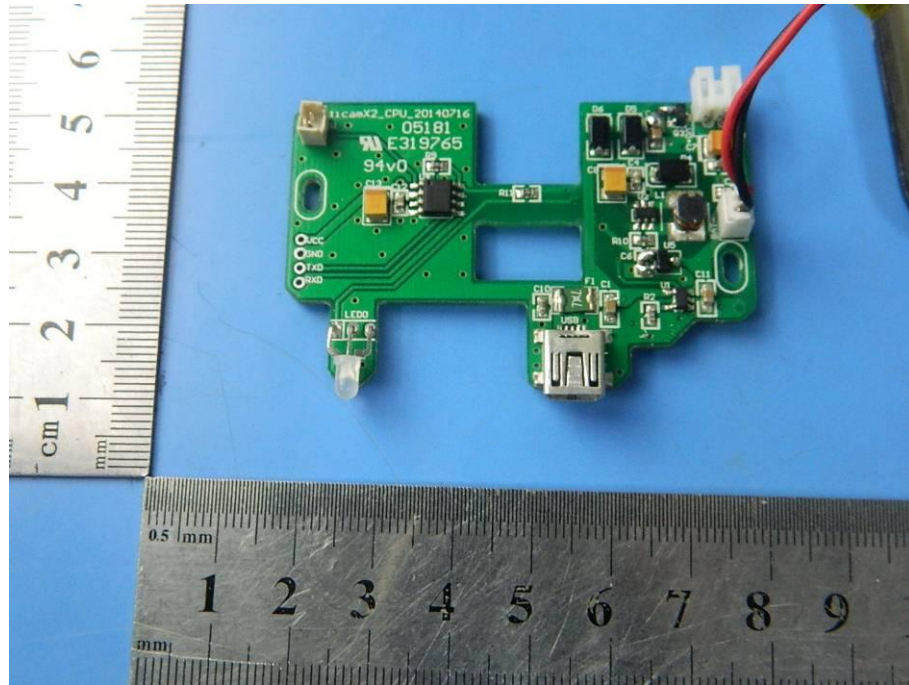

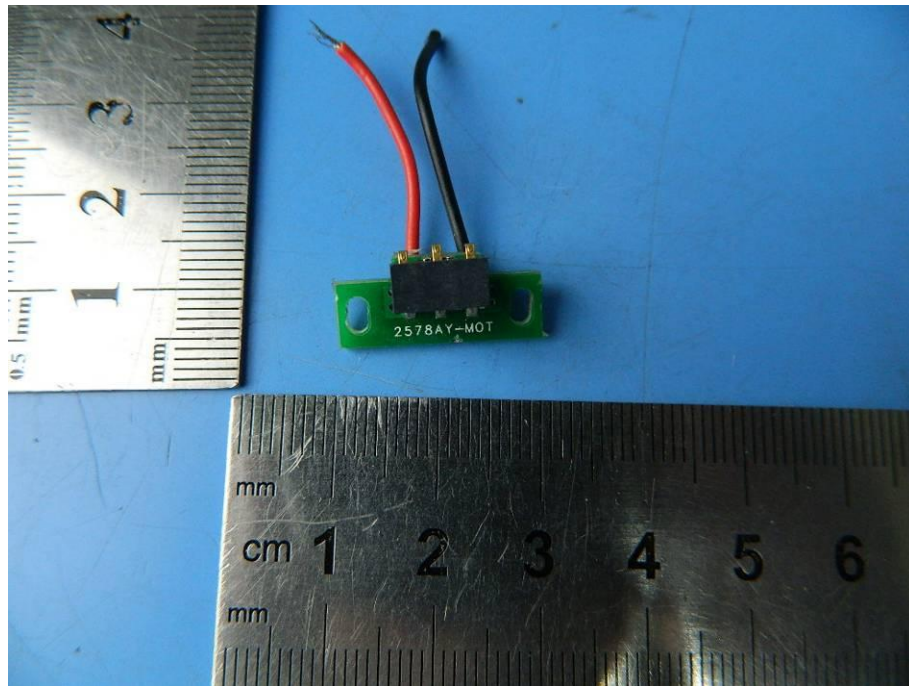
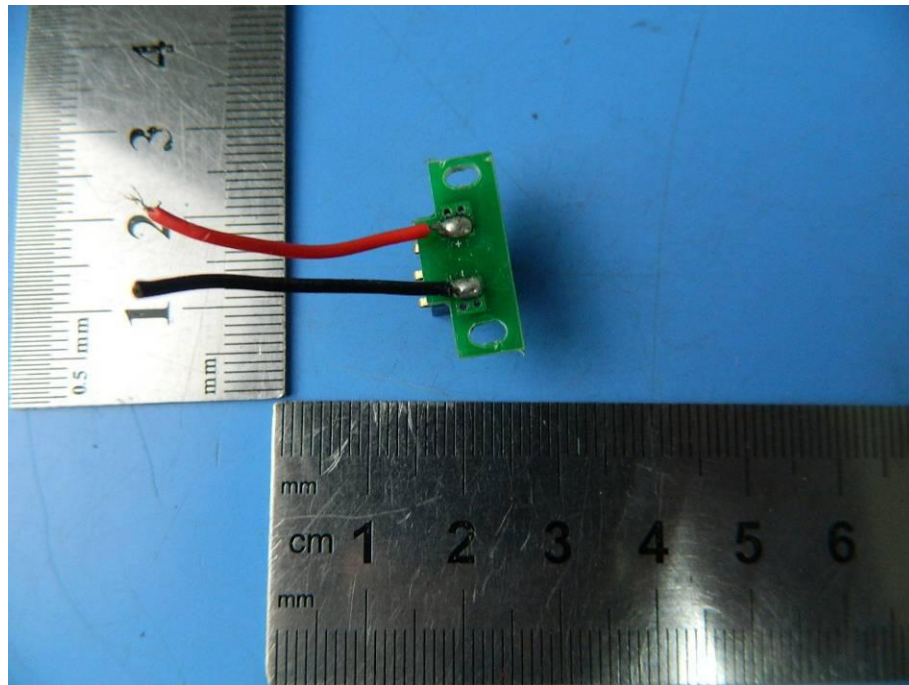

-----END OF THE REPORT-----