



Shenzhen Certification Technology Service Co., Ltd
2F, Building B, East Area of Nanchang Second Industrial
Zone, Gushu 2nd Road, Bao'an District, Shenzhen
518126, P.R. China.

TEST REPORT

FCC ID: PVEMOTICAMX

Applicant : Motic China Group Co., Ltd
Address : Motic BLDG, TORCH HI-TECH INDUSTRIAL DEV ZONE XIAMEN
FUJIAN, CHINA, 361006

Equipment under Test (EUT):

Name : Digital WI-FI Camera
Model : Moticam X

Standards : FCC PART 15, SUBPART C : 2011 (Section 15.247)

Report No. : STE121108551

Date of Test : November 12-16, 2012

Date of Issue : November 17, 2012

Test Result :	PASS *
----------------------	---------------

* In the configuration tested, the EUT complied with the standards specified above

Authorized Signature

(Mark Zhu)
General Manager

The manufacture should ensure that all the products in series production are in conformity with the product sample detailed in this report.

If the product in this report is used in any configuration other than that detailed in the report, the manufacturer must ensure the new system complies with all relevant standards. Any mention of Shenzhen Certification Technology Service Co., Ltd. Or test done by Shenzhen Certification Technology Service Co., Ltd. Approvals in connection with, distribution or use of the product described in this report must be approved by Shenzhen Certification Technology Service Co., Ltd. Approvals in writing.

TABLE OF CONTENT

Description	Page
1 General Information -----	3
1.1 Description of Device (EUT) -----	3
1.2 Description of Test Facility -----	3
2 EMC Equipment List -----	4
3 Test Procedure -----	5
4 Summary of Measurement -----	6
4.1 Summary of test result -----	6
4.2 Test connection -----	6
4.3 Assistant equipment used for test -----	6
4.4 Test mode -----	7
5 Spurious Emission -----	8
5.1 Conducted Spurious Emission -----	8
5.2 Radiation Emission -----	21
6 POWER LINE CONDUCTED EMISSION -----	38
6.1 Conducted Emission Limits(15.207) -----	38
6.2 Test Setup -----	38
6.3 Test Procedure -----	39
6.4 Test Results -----	39
7 Conducted Maximum Output Power -----	42
7.1 Test limit -----	42
7.2 Test Procedure -----	42
7.3 Test Setup -----	42
7.4 Test Results -----	42
8 PEAK POWER SPECTRAL DENSITY -----	62
8.1 Test limit -----	62
8.2 Method of measurement -----	62
8.3 Test Setup -----	62
8.4 Test Results -----	63
9 6dB Bandwidth -----	70
9.1 Test limit -----	70
9.2 Method of measurement -----	70
9.3 Test Setup -----	70
9.4 Test Results -----	70
10 Band Edge Check -----	78
10.1 Test limit -----	78
10.2 Test Procedure -----	78
10.3 Test Setup -----	78
10.4 Test Result -----	78
11 Antenna Requirement -----	95
11.1 Standard Requirement -----	95
11.2 Antenna Connected Construction -----	95
11.3 Result -----	95
12 Photographs of Test Setup -----	96
13 Photographs of EUT -----	99

1 General Information

1.1 Description of Device (EUT)

Trade Name	: Motic®
EUT	: Digital WI-FI Camera
Model No.	: Moticam X
Type of Antenna	: Integral Antenna
Antenna Specification	: 2.5dBi
Operation Frequency	: 2412~2462MHz for 802.11b.g.n/HT20 2422-2452MHz for 802.11n/HT40
Channel number	: 11 for 802.11b.g.n/HT20 7 for 802.11n/HT40 IEEE 802.11b: DSSS(CCK,DQPSK,DBPSK)
Modulation type	: IEEE 802.11g: OFDM(64QAM, 16QAM, QPSK, BPSK) IEEE 802.11n :OFDM(64QAM, 16QAM, QPSK, BPSK)
Power Supply	: DC 5V from Adapter
Rated PF output Power	: 14.71dBm for 802.11b.g.n/HT20 13.74dBm MHz for 802.11n/HT40
Applicant	: Motic China Group Co., Ltd
Address	: Motic BLDG, TORCH HI-TECH INDUSTRIAL DEV ZONE XIAMEN FUJIAN, CHINA, 361006
Manufacturer	: Motic China Group Co., Ltd
Address	: Motic BLDG, TORCH HI-TECH INDUSTRIAL DEV ZONE XIAMEN FUJIAN, CHINA, 361006

1.2 Description of Test Facility

Shenzhen Certification Technology Service Co., Ltd.
2F, Building B, East Area of Nanchang Second Industrial Zone,
Gushu 2nd Road, Bao'an District, Shenzhen 518126, P.R. China
FCC Registered No.:197647

2 EMC Equipment List

Equipment	Manufacture	Model No.	Serial No.	Last cal.	Cal Interval
3m Semi-Anechoic	ETS-LINDGREN	N/A	SEL0017	Oct. 31, 12	1 Year
Spectrum analyzer	Agilent	E4407B	MY46185649	Oct. 31, 12	1 Year
Receiver	R&S	ESCI	100492	Oct. 31, 12	1 Year
Receiver	R&S	ESCI	101202	Oct. 31, 12	1 Year
Bilog Antenna	Sunol	JB3	A121206	Feb.12, 12	1 Year
Horn Antenna	EMCO	3115	640201028-06	Feb.12, 12	1 Year
Active Loop Antenna	Beijing Daze	ZN30900A	SEL0097	Feb.12, 12	1 Year
L.I.S.N.	SCHWARZBECK	NSLK8126	8126466	Oct. 31, 12	1 Year
Cable	Resenberger	N/A	No.1	Oct. 31, 12	1 Year
Cable	SCHWARZBECK	N/A	No.2	Oct. 31, 12	1 Year
Cable	SCHWARZBECK	N/A	No.3	Oct. 31, 12	1 Year
Pre-amplifier	R&S	AFS42-00101 800-25-S-42	SEL0081	Oct. 31, 12	1 Year
Pre-amplifier	R&S	AFS33-1800265 0-30-8P-44	SEL0080	Oct. 31, 12	1 Year

3 Test Procedure

POWER LINE CONDUCTED INTERFERENCE: The test procedure used was ANSI Standard C63.4-2003 using a 50 u H LISN. Both Lines were observed. The bandwidth of the receiver was 10kHz with an appropriate sweep speed. The ambient temperature of the EUT was 25°C with a humidity of 58%.

RADIATION INTERFERENCE: The test procedure used was ANSI Standard C63.4-2003 using a ANRITSU spectrum analyzer with a pre-selector. The analyzer was calibrated in dB above a micro volt at the output of the antenna. The resolution bandwidth was 100kHz and the video bandwidth was 300 kHz up to 1 GHz and 1 MHz with a video BW of 3MHz above 1 GHz. The ambient temperature of the EUT was 25°C with a humidity of 58%.

FORMULA OF CONVERSION FACTORS: The Field Strength at 3m was established by adding the meter reading of the spectrum analyzer (which is set to read in units of dBuV) to the antenna correction factor supplied by the antenna manufacturer and cable loss. The antenna correction factors and cable loss are stated in terms of dB. The gain of the Pre-selector was accounted for in the Spectrum Analyzer Meter Reading.

Example:

Freq (MHz) METER READING + ACF + CABLE = FS

33.20 dBuV + 10.36 dB + 0.9 dB = 44.46 dBuV/m @ 3m

ANSI STANDARD C63.4-2003 10.1.7 MEASUREMENT PROCEDURES: The EUT was placed on a table 80 cm high and with dimensions of 1m by 1.5m. The EUT was placed in the center of the table (1.5m side). The table used for radiated measurements is capable of continuous rotation. When an emission was found, the table was rotated to produce the maximum signal strength. At this point, the antenna was raised and lowered from 1m to 4m. The antenna was placed in both the horizontal and vertical planes. The situation was similar for the conducted measurement except that the table did not rotate. The EUT was setup as described in ANSI Standard C63.4-2003 10.1.7 with the EUT 40 cm from the vertical ground wall.

4 Summary of Measurement

4.1 Summary of test result

Test Item	Test Requirement	Standards Paragraph	Result
Spurious Emission	FCC PART 15 : 2011	Section 15.247&15.209	Compliance
Conduction Emission	FCC PART 15: 2011	Section 15.207	Compliance
6dB Bandwidth Test	FCC PART 15: 2011	Section 15.247	Compliance
Peak Power	FCC PART 15: 2011	Section 15.247	Compliance
Power Density	FCC PART 15: 2011	Section 15.247	Compliance
Band Edge	FCC PART 15: 2011	Section 15.247	Compliance
Antenna Requirement	FCC PART 15 : 2011	Section 15.203	Compliance

Note: The EUT has been tested as an independent unit. And Continual Transmitting in maximum power (The Adapter be used during Test)

4.2 Test connection

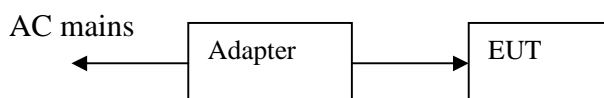

4.3 Assistant equipment used for test

Description	:	N/A
Manufacturer	:	N/A
Model No.	:	N/A

4.4 Test mode

Tested mode, channel, and data rate information			
Mode	data rate (Mbps)(see Note)	Channel	Frequency (MHz)
IEEE 802.11b	1	Low :CH1	2412
	1	Middle: CH6	2437
	1	High: CH11	2462
IEEE 802.11g	6	Low :CH1	2412
	6	Middle: CH6	2437
	6	High: CH11	2462
IEEE 802.11n/HT20	6.5	Low :CH1	2412
	6.5	Middle: CH6	2437
	6.5	High: CH11	2462
IEEE 802.11n/HT40	13.5	Low :CH3	2422
	13.5	Middle:CH6	2437
	13.5	High:CH9	2452
Note: According exploratory test, EUT will have maximum output power in those data rate. so those data rate were used for all test.			

5 Spurious Emission

5.1 Conducted Spurious Emission

5.1.1 Test limit

Please refer section 15.247.

In any 100 kHz bandwidth outside the frequency band in which the spread spectrum or digitally modulated intentional radiator is operating, the radio frequency power that is produced by the intentional radiator shall be at least 20 dB below that in the 100 kHz bandwidth within the band that contains the highest level of the desired power, based on either an RF conducted or a radiated measurement. Attenuation below the general limits specified in Section 15.209(a) is not required. In addition, radiated emissions which fall in the restricted bands, as defined in Section 15.205(a), must also comply with the radiated emission limits specified in Section 15.209(a) (see Section 15.205(c)).

5.1.2 Method of measurement

Conducted RF measurements of the transmitter output were made to confirm that the EUT antenna port conducted emissions meet the specified limit and to identify any spurious signals that require further investigation or measurements on the radiated emissions site.

The transmitter output is connected to the spectrum analyzer.

RBW=100 KHz, VBW=300 KHz below 1G,

RBW=1MHz, VBW=3MHz above 1G,

Measurements are made over the 30MHz to 25GHz range with the transmitter set to the lowest, middle, and highest channels.

5.1.3 Test Setup



5.1.4 Test Results

PASS.

Detailed information please see the following page.

IEEE 802.11b:

CH Low : 30MHz-25GHz

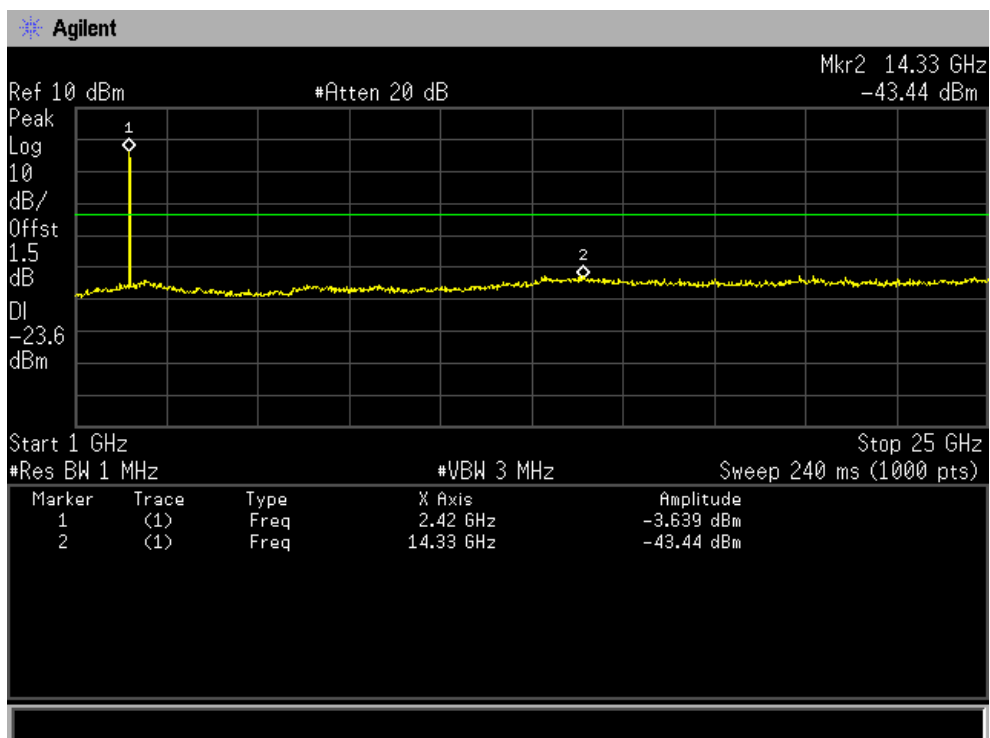
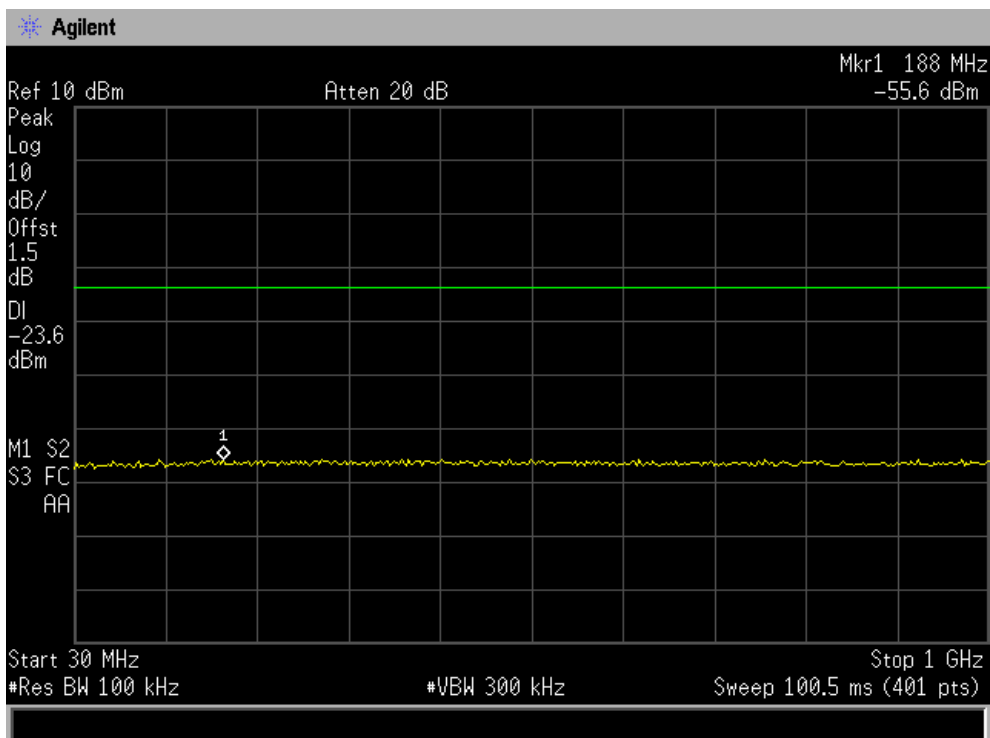

CH Mid : 30MHz-25GHz

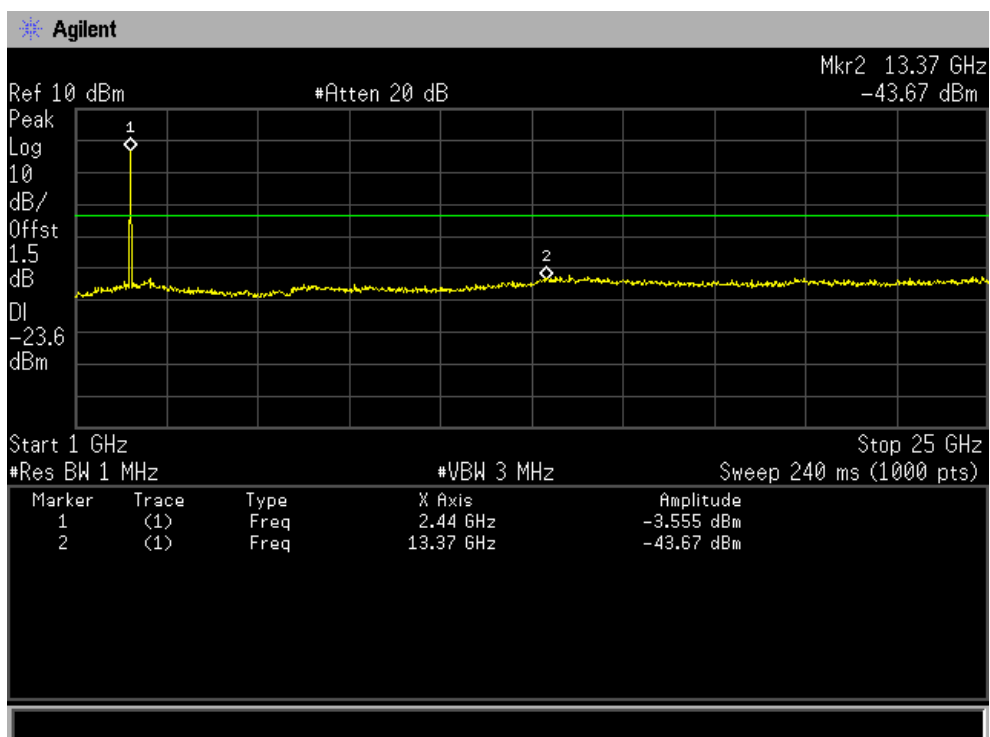
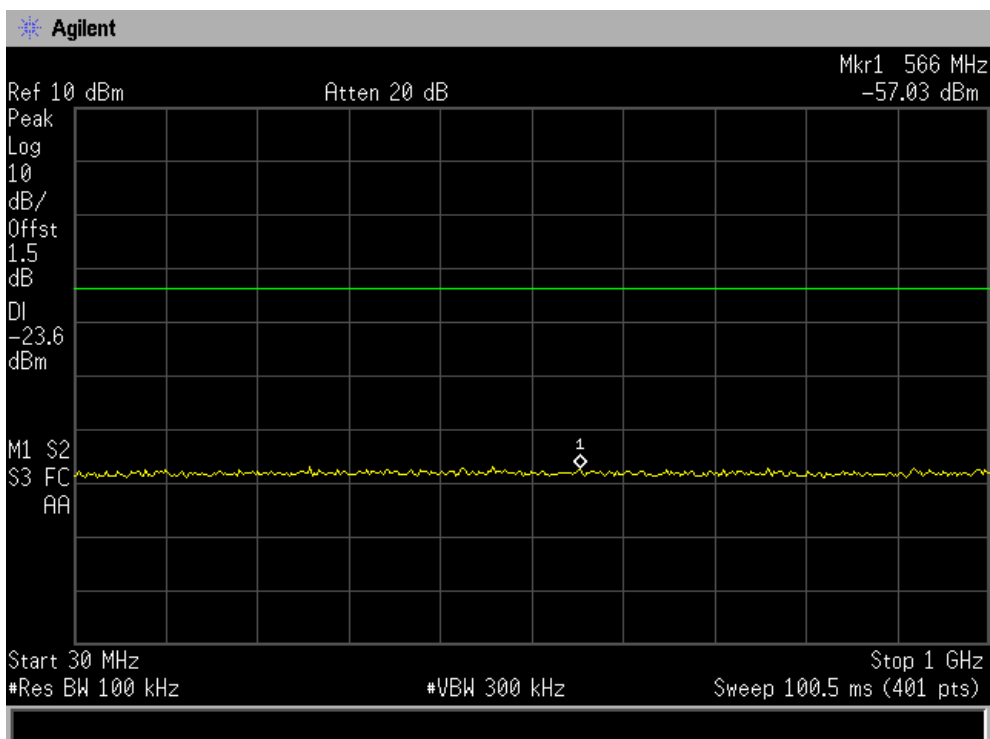

CH High : 30MHz-25GHz

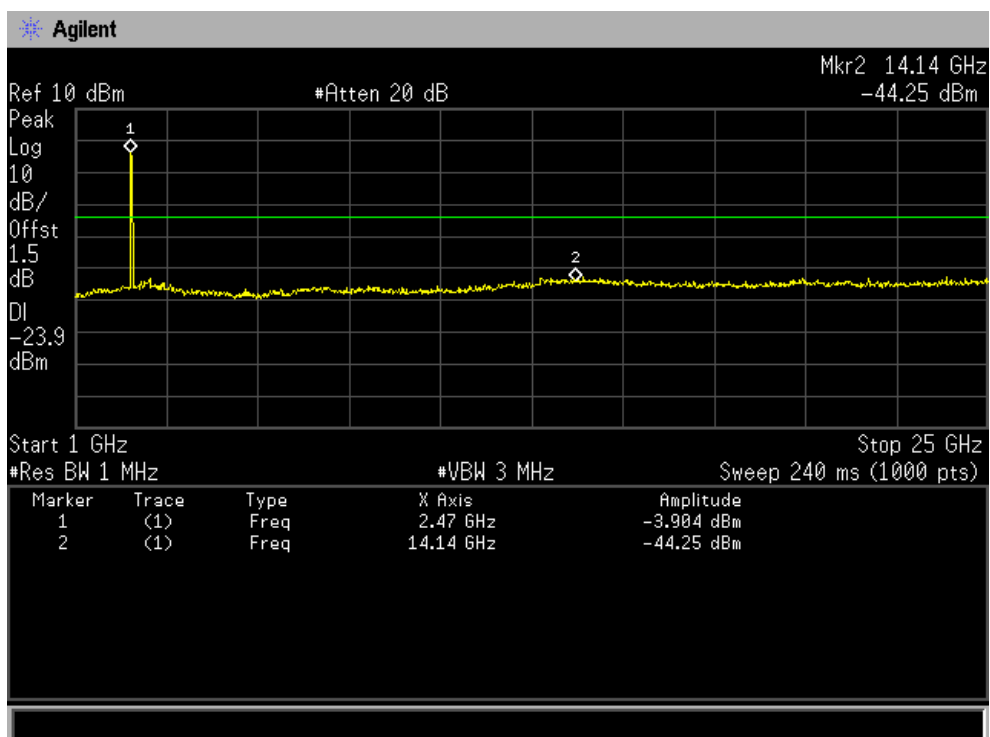
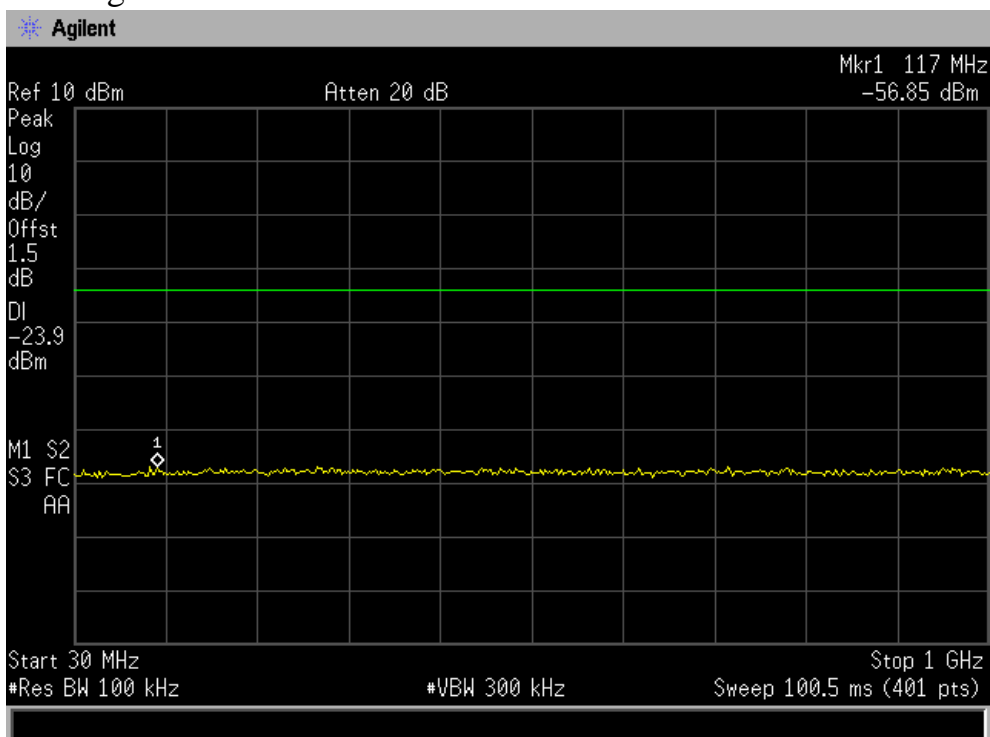

IEEE 802.11g:

CH Low : 30MHz-25GHz

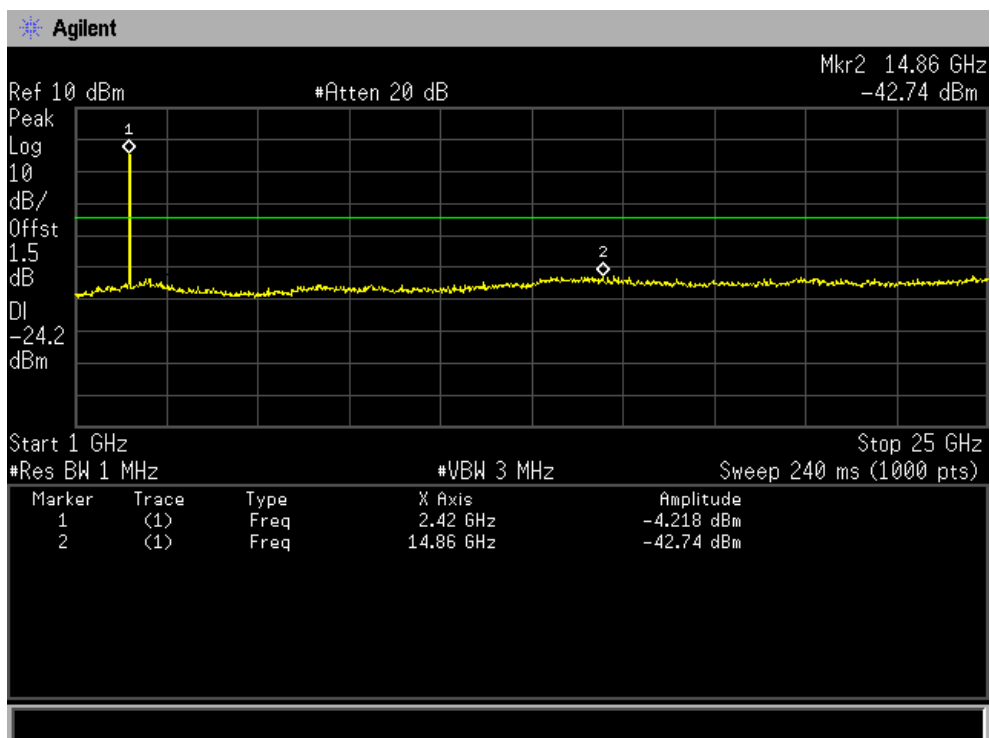
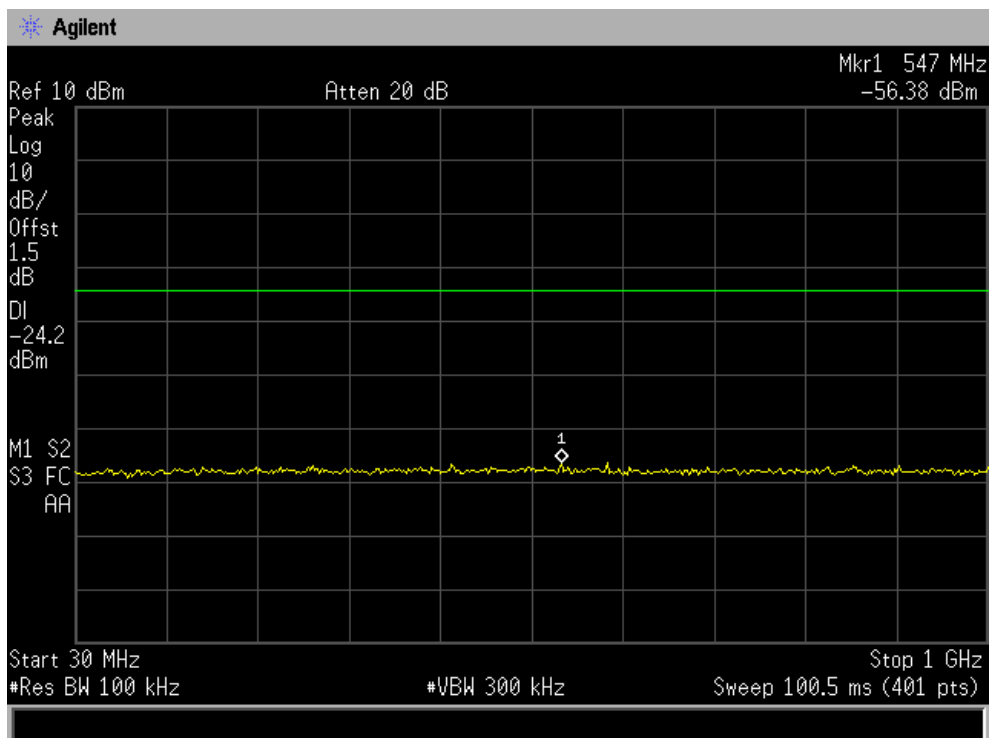

CH Mid : 30MHz-25GHz

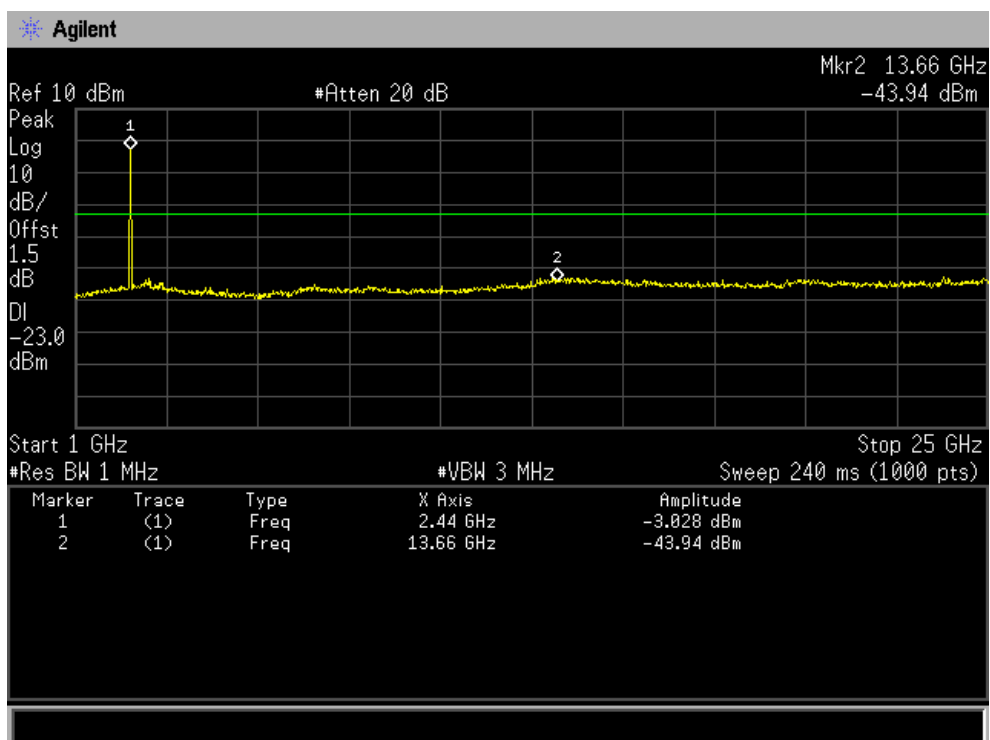
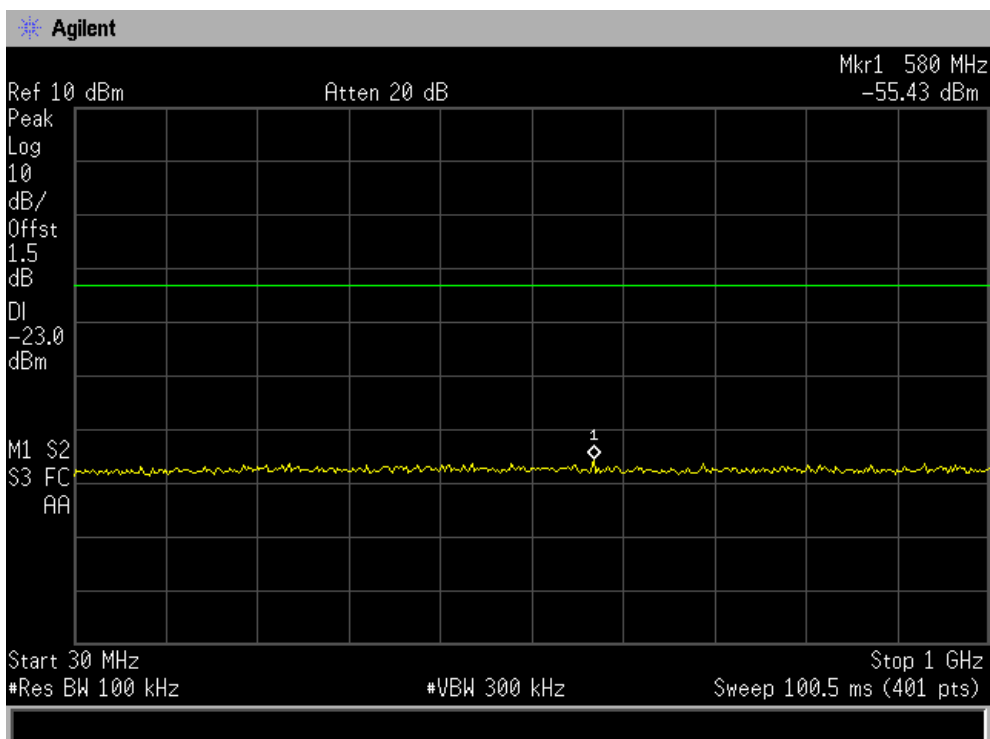

CH High : 30MHz-25GHz

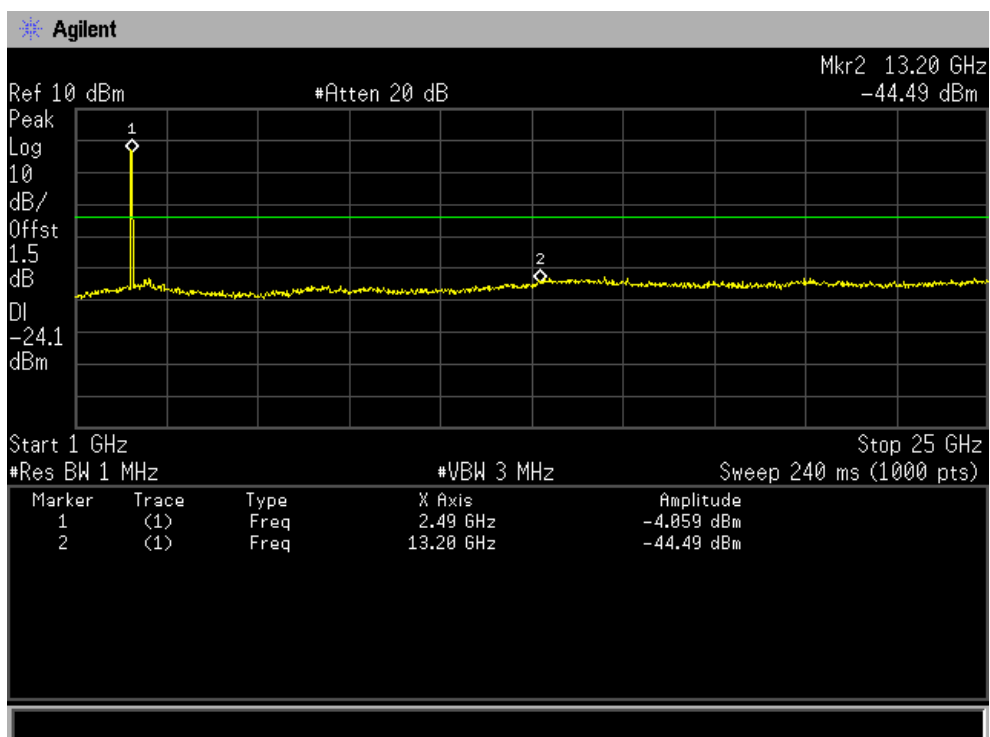
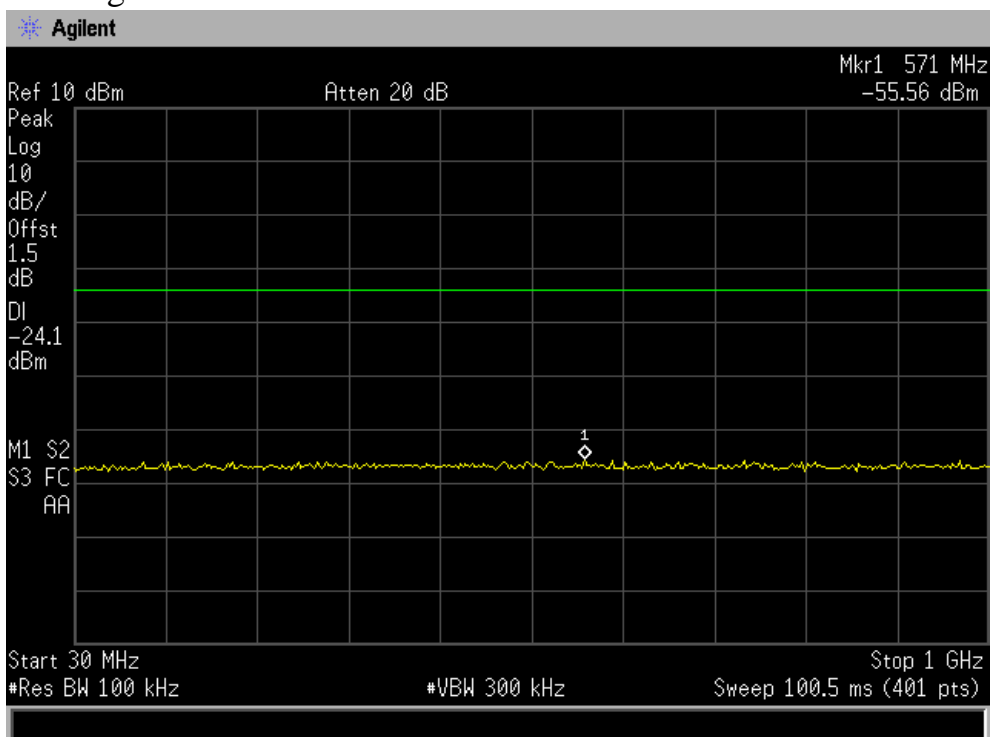

IEEE 802.11n/HT20:

CH Low : 30MHz-25GHz

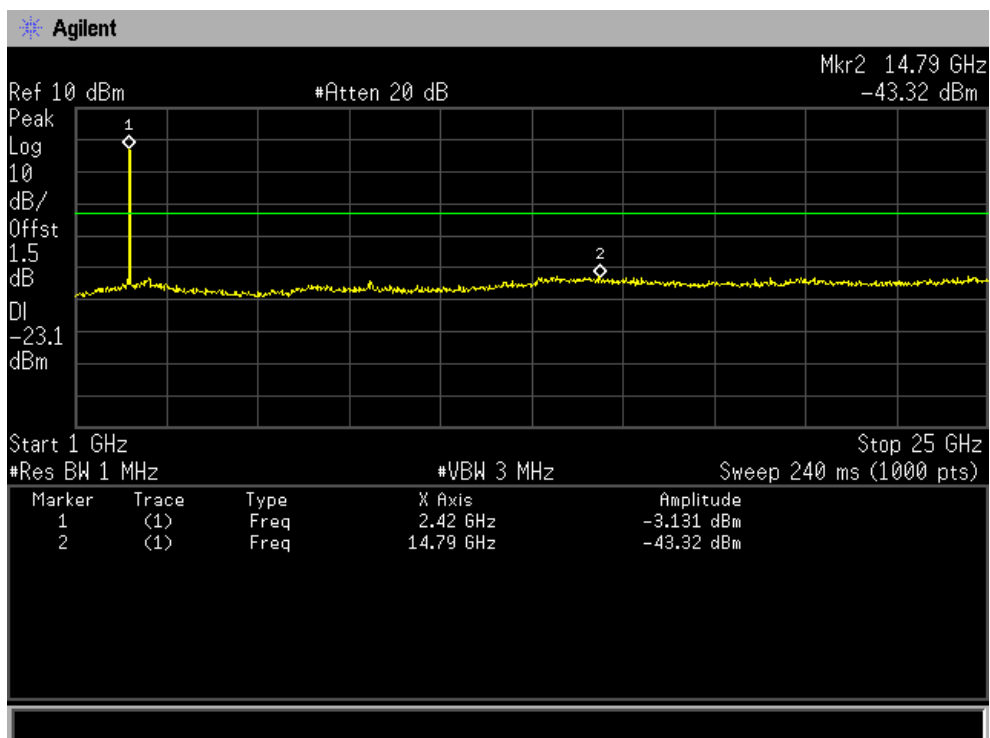
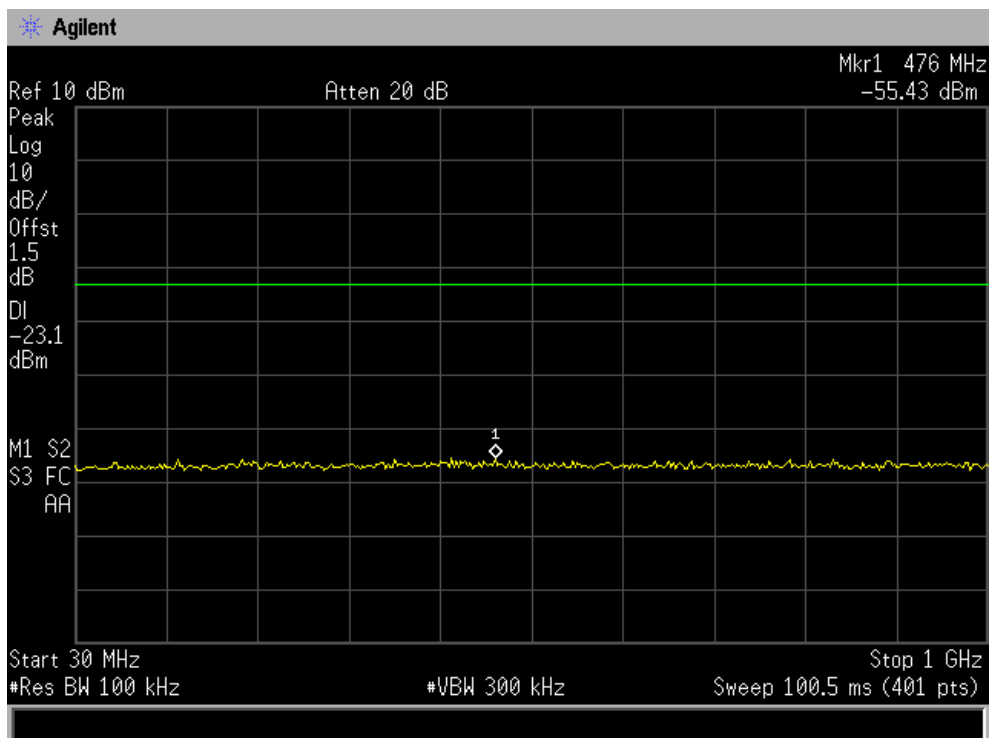

CH Mid : 30MHz-25GHz

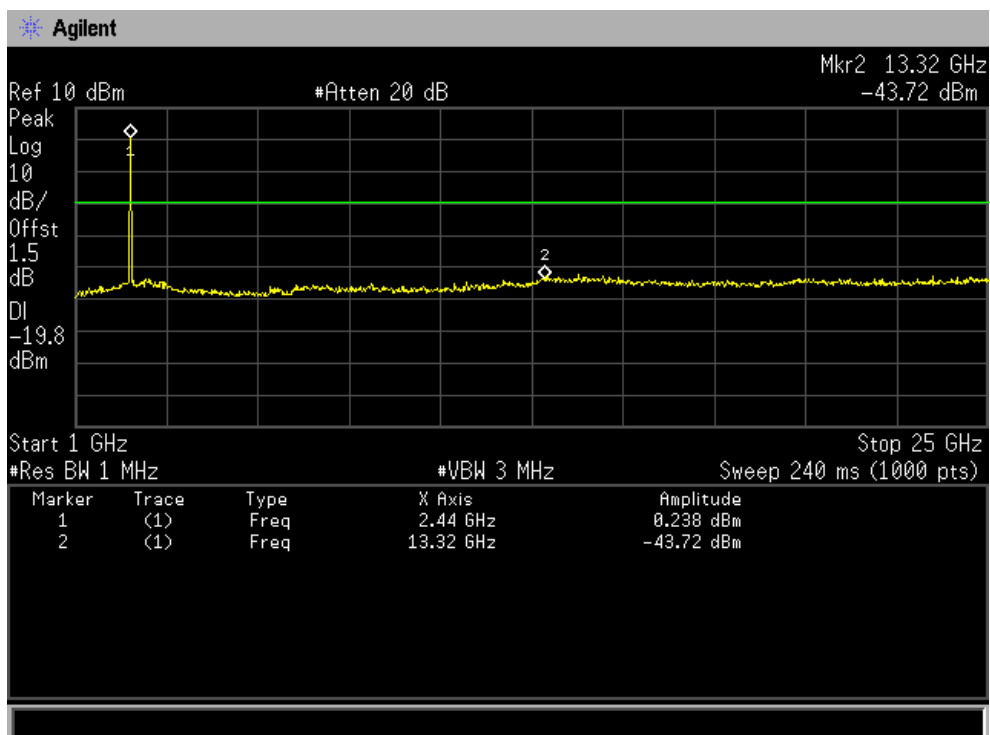
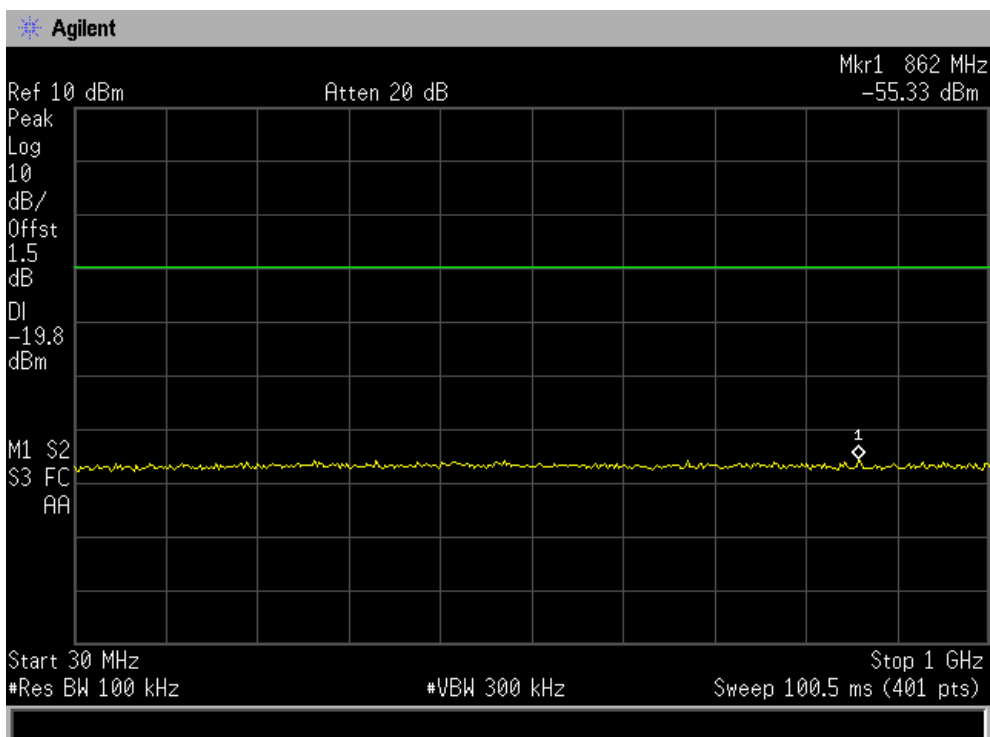

CH High : 30MHz-25GHz

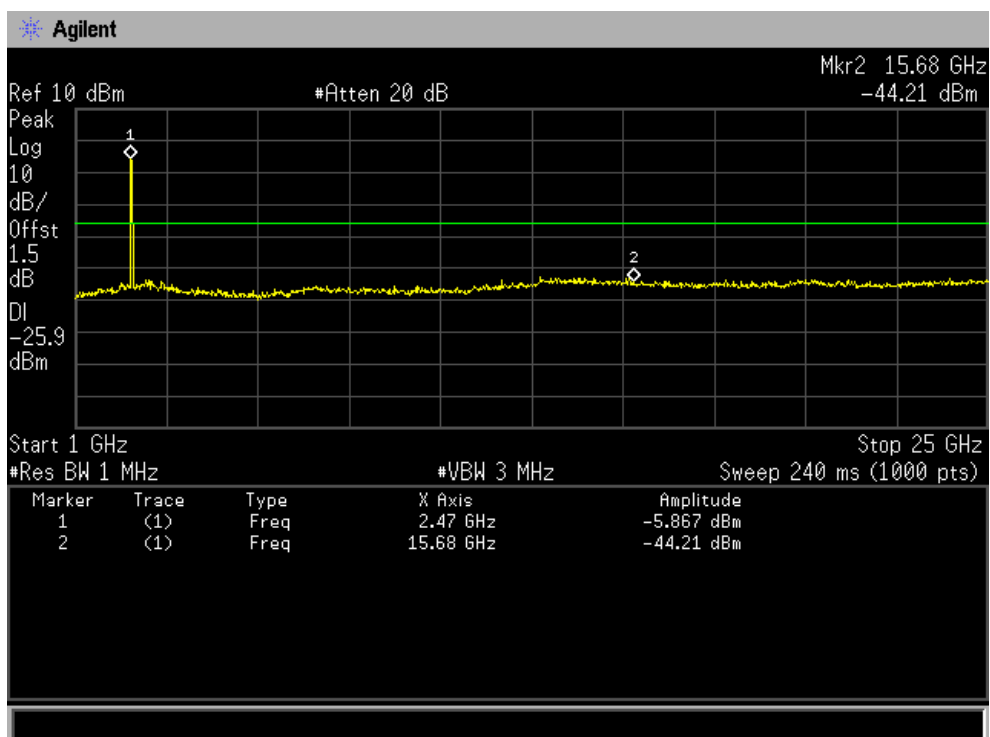
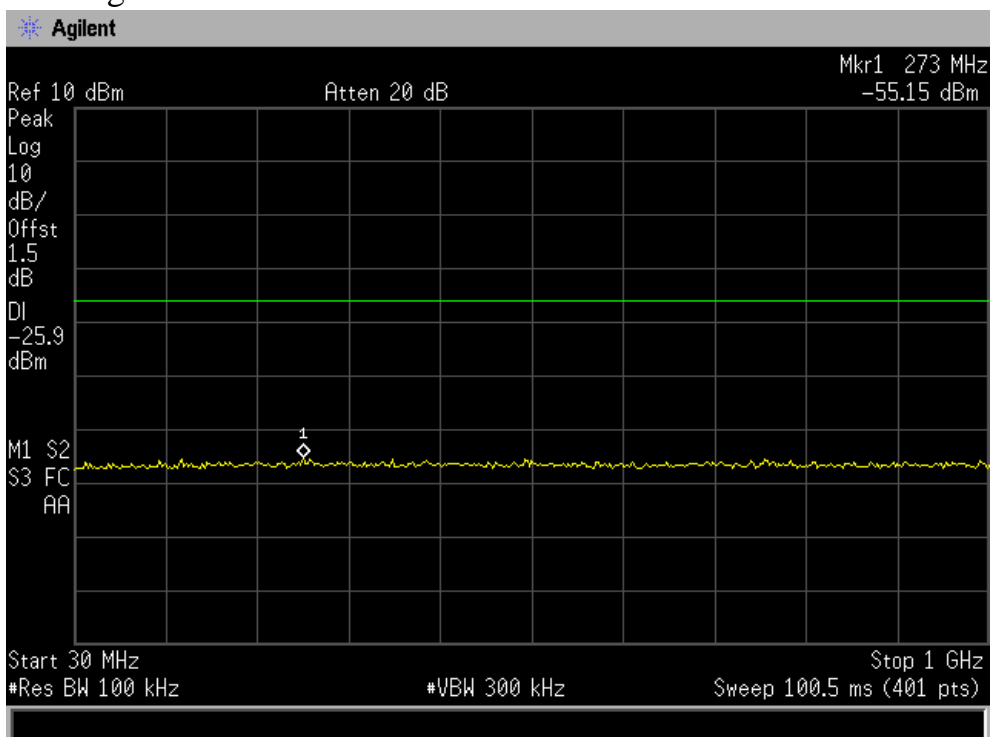

IEEE 802.11n/HT40:

CH Low : 30MHz-25GHz

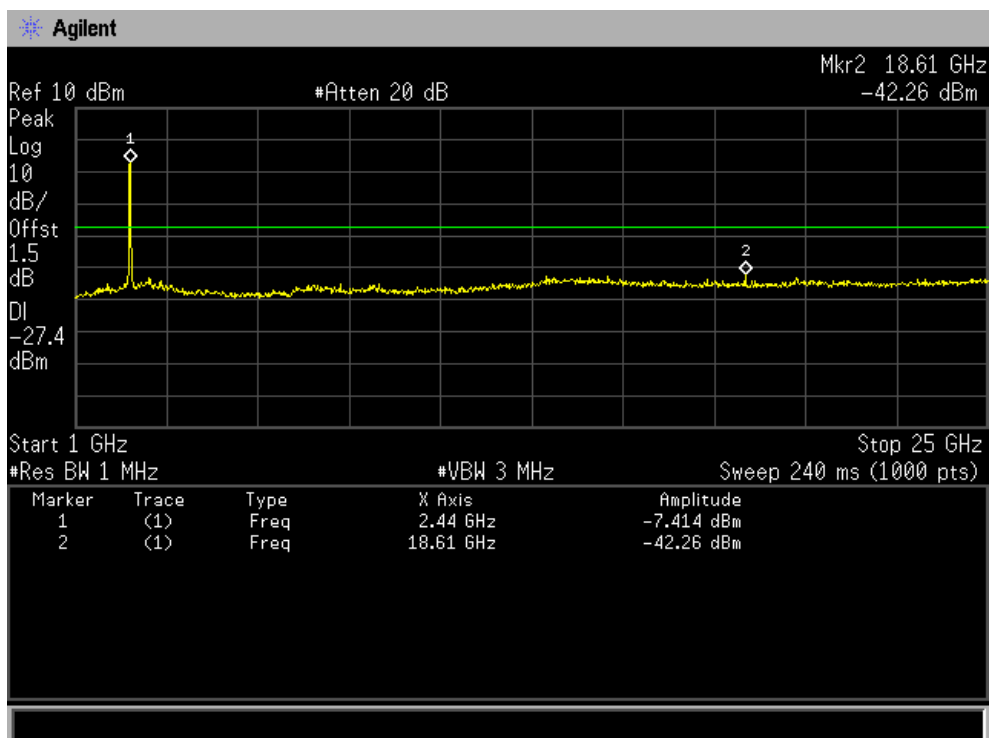
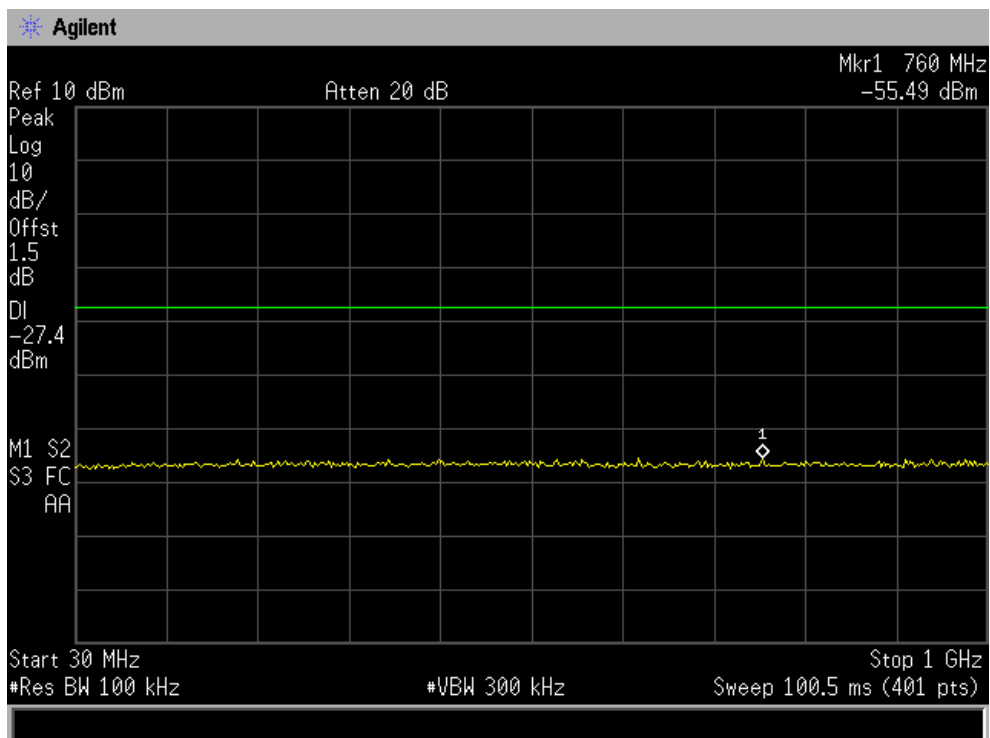

CH Mid : 30MHz-25GHz

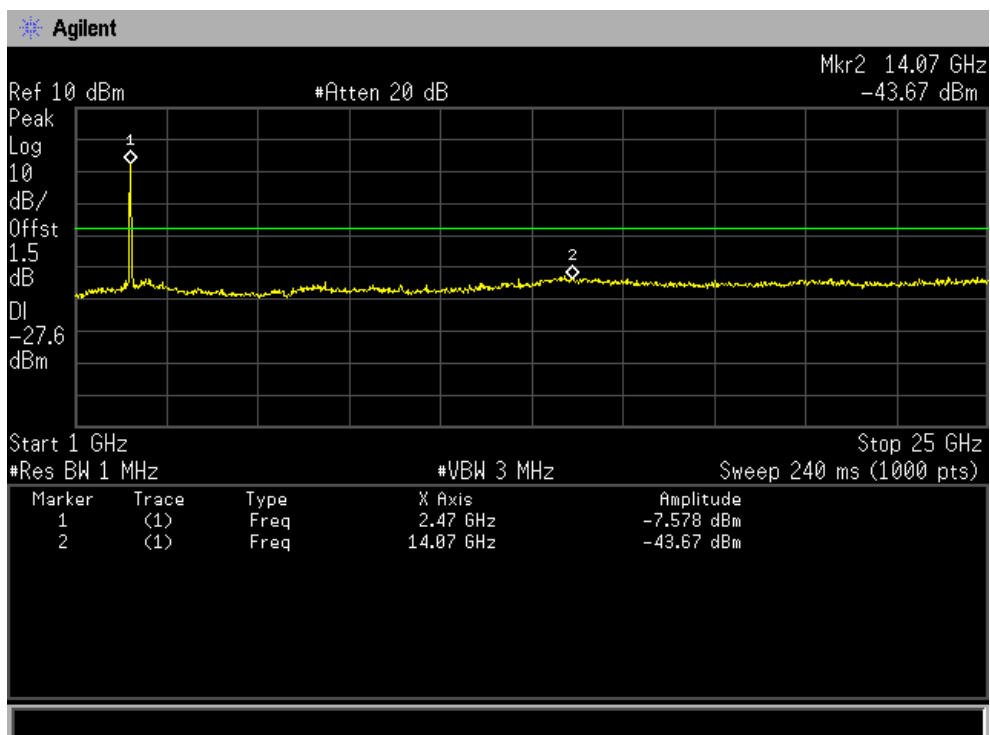
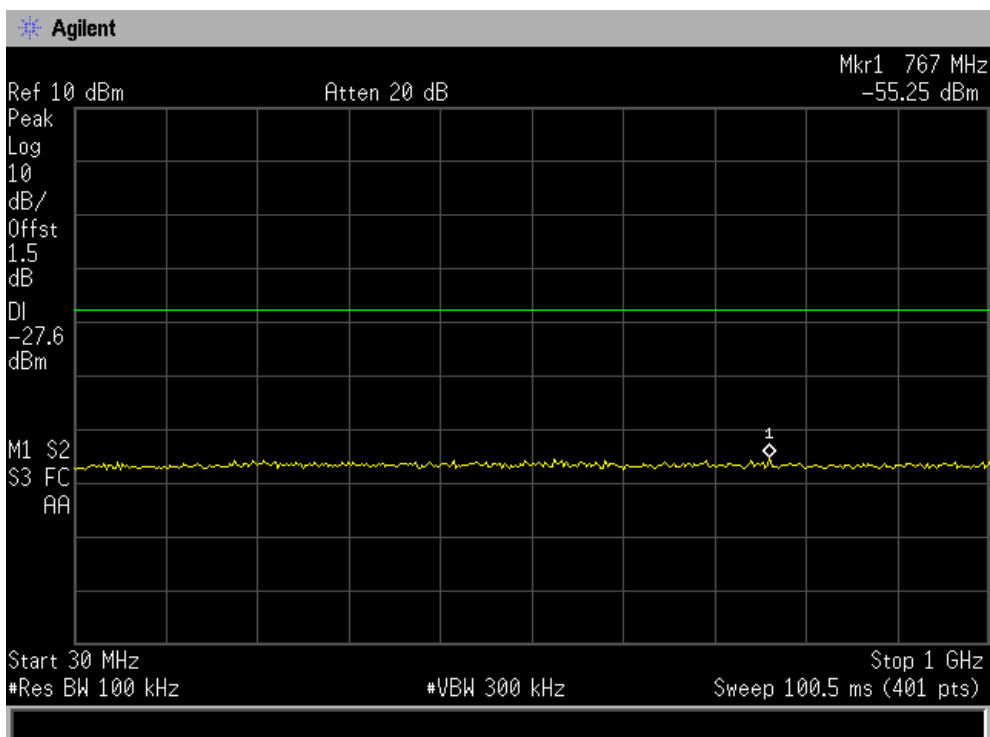

CH High : 30MHz-25GHz

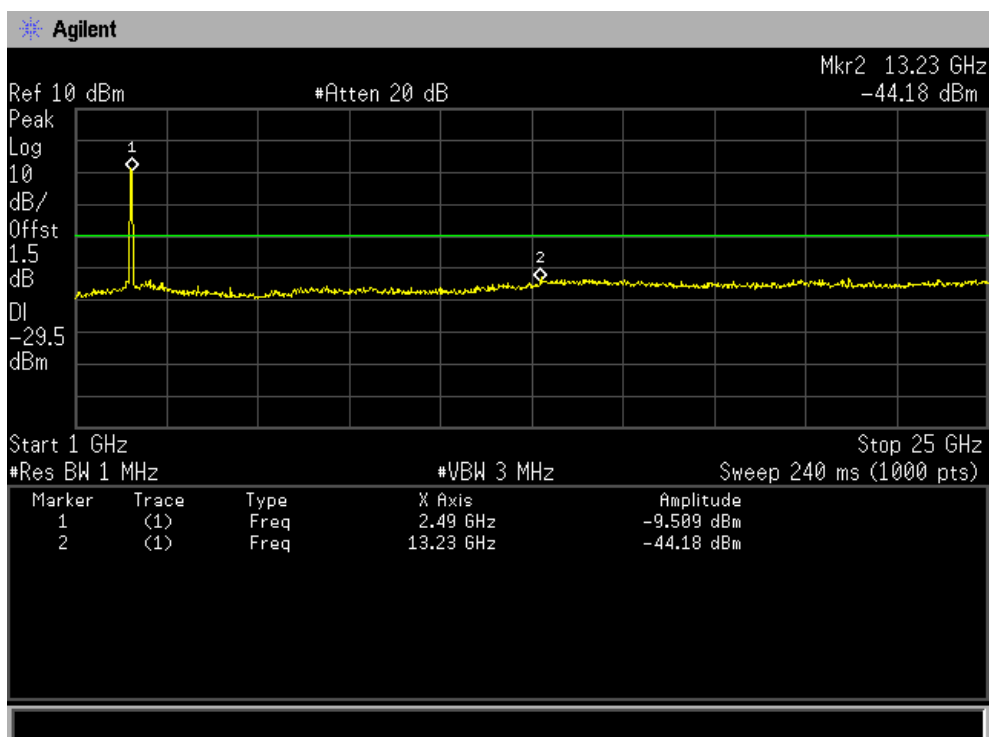
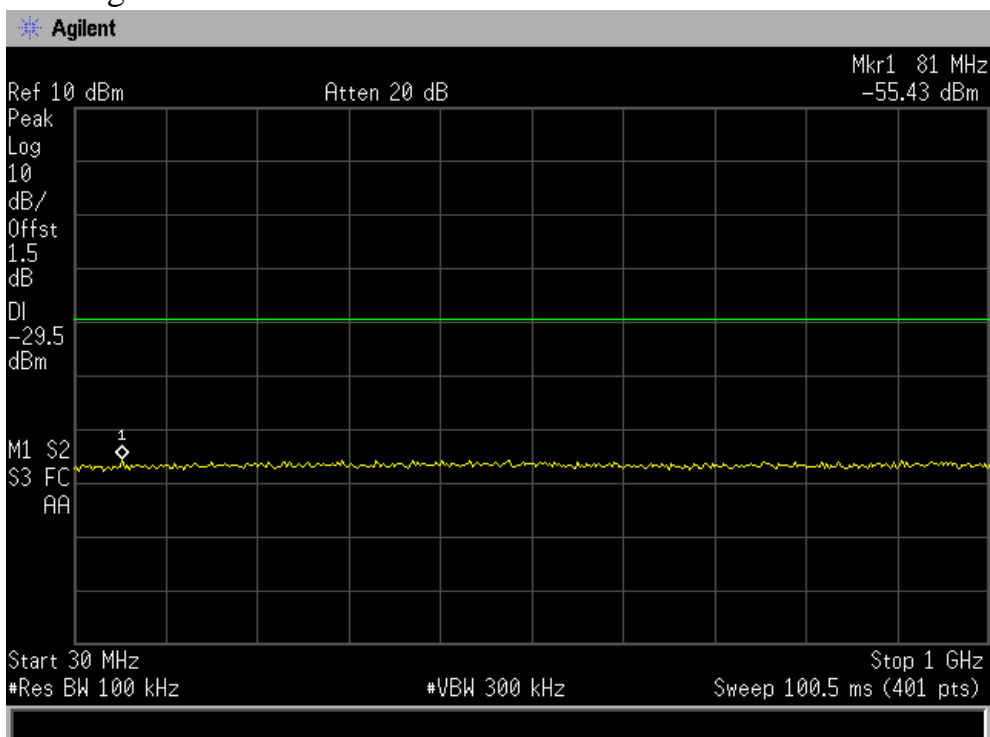

5.2 Radiation Emission

5.2.1 Radiation Emission Limits(15.209)

Frequencies (MHz)	Field Strength (micorvolts/meter)	Measurement Distance (meters)
0.009~0.490	2400/F(KHz)	300
0.490~1.705	24000/F(KHz)	30
1.705~30.0	30	30
30~88	100	3
88~216	150	3
216~960	200	3
Above 960	500	3

Harmonic emissions limits comply with below 54 dBuV/m at 3m. Other emissions radiated outside of the specified frequency bands, except for harmonics, shall be attenuated by at least 50 dB below the level of the fundamental or comply with the radiated emissions limits specified in section 15.209(a) limit in the table below has to be followed.

NOTE:

- a) The tighter limit applies at the band edges.
- b) Emission Level(dB uV/m)=20log Emission Level(Uv/m)

5.2.2 Test Setup

See the next page

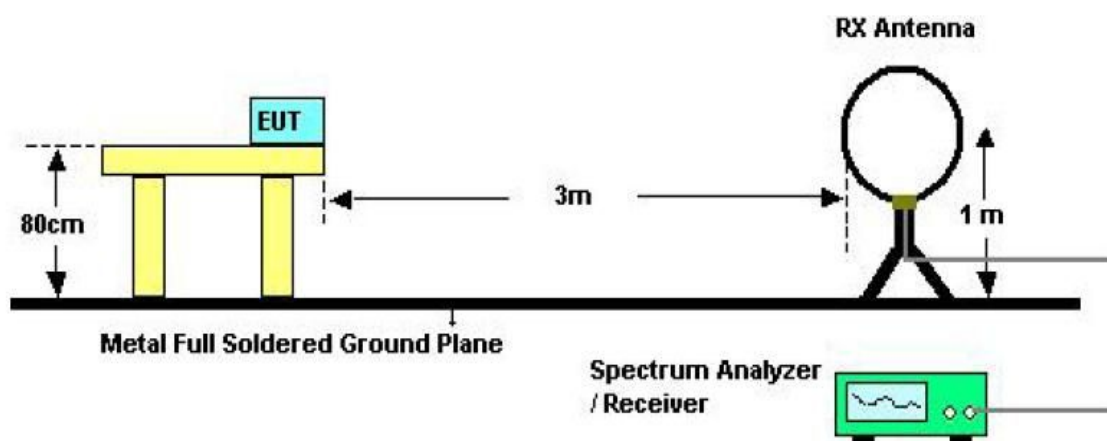

Below 30MHz Test Setup

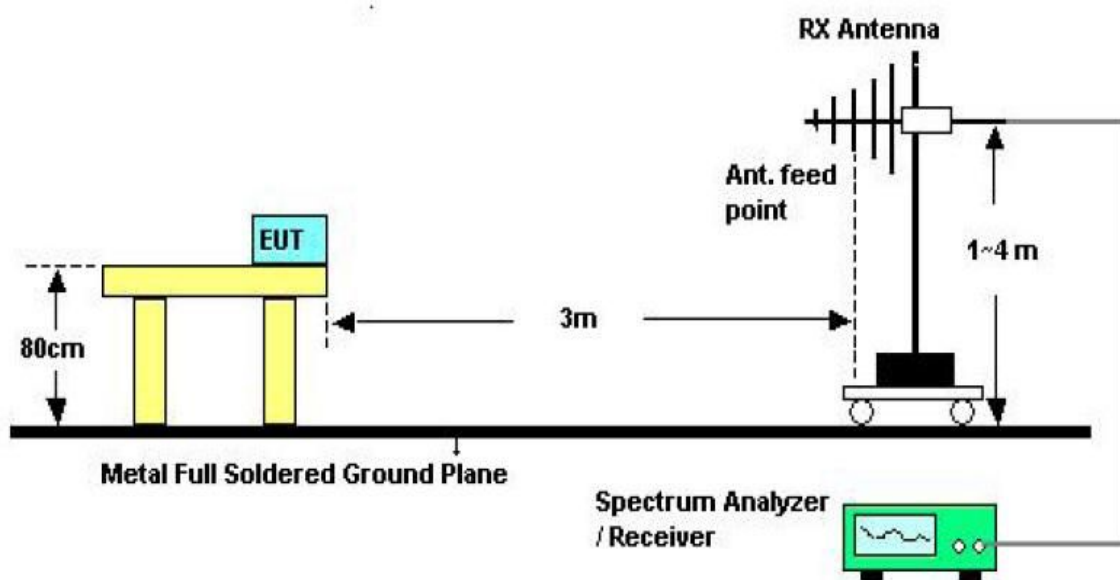

Above 30MHz Test Setup

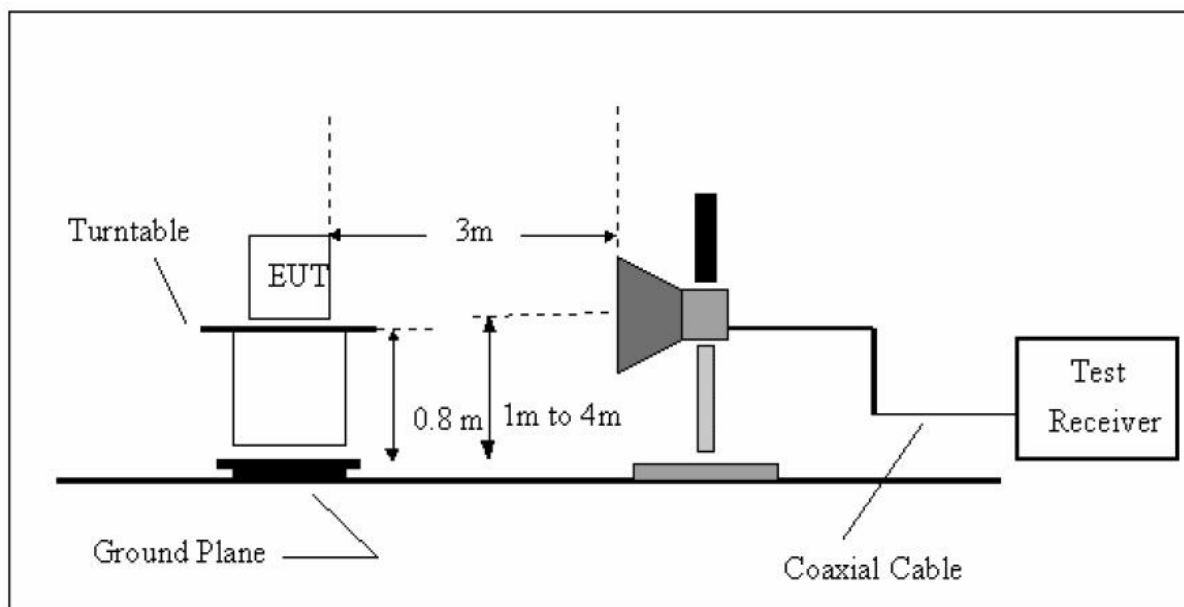

Above 1GHz Test Setup

5.2.3 Test Procedure

- a) The measuring distance of 3m shall be used for measurements at frequency up to 1GHz and above 1GHz, The EUT was placed on a rotating 0.8 m high above ground, The table was rotated 360 degrees to determine the position of the highest radiation
- b) The Test antenna shall vary between 1m and 4m,Both Horizontal and Vertical antenna are set of make measurement.
- c) The initial step in collecting conducted emission data is a spectrum analyzer Peak detector mode pre-scanning the measurement frequency range. Significant Peaks are then marked. and then Qusia Peak Detector mode premeasured
- d) If Peak value comply with QP limit Below 1GHz.The EUT deemed to comply with QP limit. But the Peak value and average value both need to comply with applicable limit above 1GHz.
- e) For the actual test configuration, please see the test setup photo.

5.2.4 Test Equipment Setting For emission test Result

9KHz~150KHz	RBW 200Hz	VBW1KHz
150KHz~30MHz	RBW 9KHz	VBW 30KHz
30MHz~1GHz	RBW 120KHz	VBW 300KHz
Above 1GHz	RBW 1MHz	VBW 3MHz

5.2.5 Test Condition

Continual Transmitting in maximum power.

5.2.6 Test Result

We have scanned the 10th harmonic from 9KHz to the EUT.

Detailed information please see the following page.

From 9KHz to 30MHz: Conclusion: PASS

Note: The amplitude of spurious emissions which are attenuated by more than 20dB below the permissible value has no need to be reported.

Report No.: STE121108551
 From 30MHz to 1GHz



Shenzhen Certification Technology Service Co., Ltd
 2F, Building B, East Area of Nanchang Second Industrial Zone,
 Gushu 2nd Road, Bao'an District, Shenzhen 518126, P.R. China
 Tel: 4006786199 FAX: +86-755-26736857
 Website: http://www.cessz.com Email: Service@cessz.com

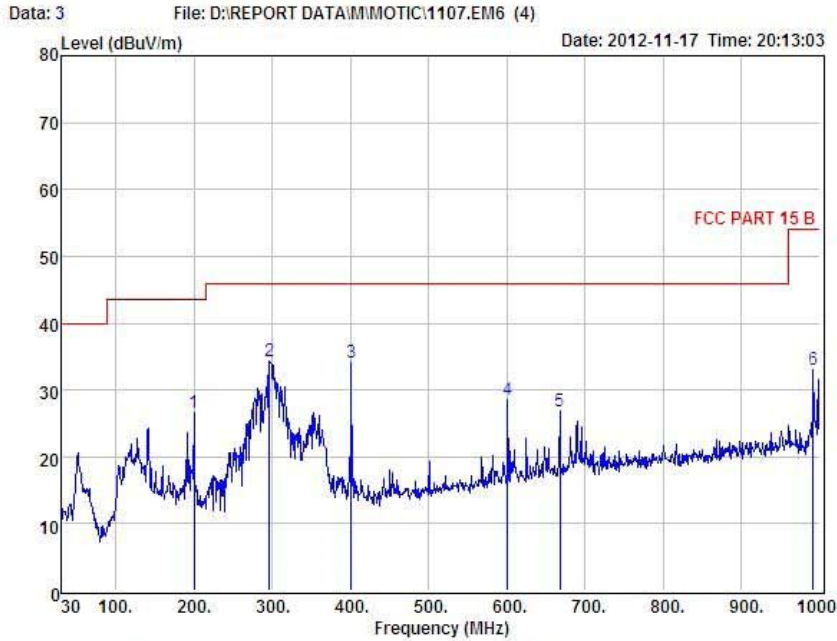

Condition : FCC PART 15 B 3m POL: HORIZONTAL
 EUT : Digital WI-FI Camera
 Model No : Moticam
 Test Mode : On
 Power : DC 5V From Adapter AC 120V/60Hz
 Test Engineer : Reak
 Remark :

Item	Freq MHz	Read Level dBuV	Antenna Factor dB	Preamp Factor dB	Cable Loss dB	Level dBuV	Limit dBuV	Margin dBuV	Remark
1	199.75	43.24	9.90	26.97	0.43	26.60	43.50	-16.90	QP
2	296.75	47.85	12.76	27.19	0.94	34.36	46.00	-11.64	QP
3	400.54	46.17	14.74	27.43	0.71	34.19	46.00	-11.81	QP
4	600.36	36.98	18.32	27.82	1.02	28.50	46.00	-17.50	QP
5	667.29	34.25	19.30	27.78	0.96	26.73	46.00	-19.27	QP
6	991.27	36.87	22.22	27.58	1.51	33.02	54.00	-20.98	QP



Shenzhen Certification Technology Service Co., Ltd.
 2F, Building B, East Area of Nanchang Second Industrial Zone,
 Gushu 2nd Road, Bao'an District, Shenzhen 518126, P.R. China
 Tel: 4006786199 FAX: +86-755-26736857
 Website: http://www.cessz.com Email: Service@cessz.com

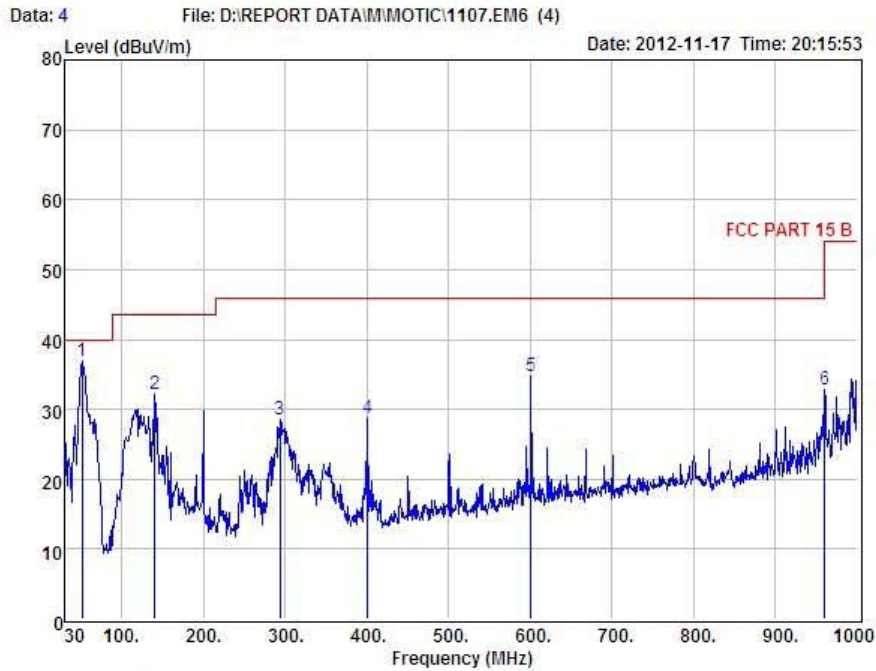

Condition : FCC PART 15 B 3m POL: VERTICAL
 EUT : Digital WI-FI Camera
 Model No : Moticom
 Test Mode : On
 Power : DC 5V From Adapter AC 120V/60Hz
 Test Engineer : Reak
 Remark :

Item	Freq MHz	Read Level dBuV	Antenna Factor dB	Preamp Factor dB	Cable Loss dB	Level dBuV	Limit dBuV	Margin dBuV	Remark
1	51.34	51.03	13.38	27.83	0.25	36.83	40.00	-3.17	QP
2	140.58	45.38	13.51	26.90	0.27	32.26	43.50	-11.24	QP
3	293.84	42.32	12.67	27.18	0.74	28.55	46.00	-17.45	QP
4	400.54	40.62	14.74	27.43	0.71	28.64	46.00	-17.36	QP
5	600.36	43.13	18.32	27.82	1.02	34.65	46.00	-11.35	QP
6	960.23	36.54	22.17	27.61	1.75	32.85	54.00	-21.15	QP

IEEE 802.11b

EUT	Digital WI-FI Camera	Model Name	Moticam X
Temperature	26°C	Relative Humidity	56%
Pressure	960hPa	Test voltage	DC 5V From Adapter with AC 120V/60Hz
Test Mode	TX Low		

Freq. (MHz)	Ant. Pol H/V	Peak Reading (dBuV)	AV Reading (dBuV)	Ant. / CL CF (dB)	Actual Fs		Peak Limit (dBuV/m)	AV Limit (dBuV/m)	Margin (dB)	Remark
					Peak (dBuV/m)	AV (dBuV/m)				
1139	V	54.50	---	-11.24	43.26	---	74.00	54.00	-10.74	Peak
1721	V	51.07	---	-9.53	41.54	---	74.00	54.00	-12.46	Peak
2275	V	48.18	---	-8.07	40.11	---	74.00	54.00	-13.89	Peak
4824	V	43.61	---	0.64	44.25	---	74.00	54.00	-9.75	Peak
N/A										

EUT	Digital WI-FI Camera	Model Name	Moticam X
Temperature	26°C	Relative Humidity	56%
Pressure	960hPa	Test voltage	DC 5V From Adapter with AC 120V/60Hz
Test Mode	TX Low		

Freq. (MHz)	Ant. Pol H/V	Peak Reading (dBuV)	AV Reading (dBuV)	Ant. / CL CF (dB)	Actual Fs		Peak Limit (dBuV/m)	AV Limit (dBuV/m)	Margin (dB)	Remark
					Peak (dBuV/m)	AV (dBuV/m)				
1272	H	52.77	---	-10.96	41.81	---	74.00	54.00	-12.19	Peak
1910	H	50.43	---	-8.86	41.57	---	74.00	54.00	-12.43	Peak
2947	H	45.39	---	-5.95	39.44	---	74.00	54.00	-14.56	Peak
4824	H	42.62	---	0.64	43.26	---	74.00	54.00	-10.74	Peak
N/A										

Notes: AV Means AV detector test data, Peak Means Peak detector test data.
Emissions attenuated more than 20 dB below the permissible value are not reported.

EUT	Digital WI-FI Camera	Model Name	Moticam X
Temperature	26°C	Relative Humidity	56%
Pressure	960hPa	Test voltage	DC 5V From Adapter with AC 120V/60Hz
Test Mode	TX Mid		

Freq. (MHz)	Ant. Pol H/V	Peak Reading (dBuV)	AV Reading (dBuV)	Ant. / CL CF (dB)	Actual Fs		Peak Limit (dBuV/m)	AV Limit (dBuV/m)	Margin (dB)	Remark
					Peak (dBuV/m)	AV (dBuV/m)				
1258	V	53.380	---	-10.96	42.42	---	74.00	54.00	-11.58	Peak
2013	V	49.84	---	-8.58	41.26	---	74.00	54.00	-12.74	Peak
2972	V	47.93	---	-5.86	42.07	---	74.00	54.00	-11.93	Peak
4874	V	40.56	---	0.76	41.32	---	74.00	54.00	-12.68	Peak

EUT	Digital WI-FI Camera	Model Name	Moticam X
Temperature	26°C	Relative Humidity	56%
Pressure	960hPa	Test voltage	DC 5V From Adapter with AC 120V/60Hz
Test Mode	TX Mid		

Freq. (MHz)	Ant. Pol H/V	Peak Reading (dBuV)	AV Reading (dBuV)	Ant. / CL CF (dB)	Actual Fs		Peak Limit (dBuV/m)	AV Limit (dBuV/m)	Margin (dB)	Remark
					Peak (dBuV/m)	AV (dBuV/m)				
120.3	H	52.67	---	-11.52	41.15	---	74.00	54.00	-12.85	Peak
1991	H	50.85	---	-8.64	42.21	---	74.00	54.00	-11.79	Peak
3481	H	48.11	---	-4.95	43.16	---	74.00	54.00	-10.84	Peak
4874	H	41.88	---	0.76	42.64	---	74.00	54.00	-11.36	Peak

Notes: AV Means AV detector test data, Peak Means Peak detector test data.
Emissions attenuated more than 20 dB below the permissible value are not reported.

EUT	Digital WI-FI Camera	Model Name	Moticam X
Temperature	26°C	Relative Humidity	56%
Pressure	960hPa	Test voltage	DC 5V From Adapter with AC 120V/60Hz
Test Mode	TX High		

Freq. (MHz)	Ant. Pol H/V	Peak Reading (dBuV)	AV Reading (dBuV)	Ant. / CL CF (dB)	Actual Fs		Peak Limit (dBuV/m)	AV Limit (dBuV/m)	Margin (dB)	Remark
					Peak (dBuV/m)	AV (dBuV/m)				
1351	V	52.86	---	-10.43	42.43	---	74.00	54.00	-11.57	Peak
2265	V	49.59	---	-8.07	41.52	---	74.00	54.00	-12.48	Peak
3148	V	48.33	---	-5.63	42.7	---	74.00	54.00	-11.30	Peak
4924	V	40.30	---	0.87	41.17	---	74.00	54.00	-12.83	Peak

EUT	Digital WI-FI Camera	Model Name	Moticam X
Temperature	26°C	Relative Humidity	56%
Pressure	960hPa	Test voltage	DC 5V From Adapter with AC 120V/60Hz
Test Mode	TX High		

Freq. (MHz)	Ant. Pol H/V	Peak Reading (dBuV)	AV Reading (dBuV)	Ant. / CL CF (dB)	Actual Fs		Peak Limit (dBuV/m)	AV Limit (dBuV/m)	Margin (dB)	Remark
					Peak (dBuV/m)	AV (dBuV/m)				
1315	H	52.3	---	-10.84	41.46	---	74.00	54.00	-12.54	Peak
2366	H	50.97	---	-7.59	43.38	---	74.00	54.00	-10.62	Peak
3742	H	44.67	---	-4.24	40.43	---	74.00	54.00	-13.57	Peak
4924	H	40.42	---	0.87	41.29	---	74.00	54.00	-12.71	Peak

Notes: AV Means AV detector test data, Peak Means Peak detector test data.
Emissions attenuated more than 20 dB below the permissible value are not reported.

IEEE 802.11 g:

EUT	Digital WI-FI Camera	Model Name	Moticam X
Temperature	26°C	Relative Humidity	56%
Pressure	960hPa	Test voltage	DC 5V From Adapter with AC 120V/60Hz
Test Mode	TX Low		

Freq. (MHz)	Ant. Pol H/V	Peak Reading (dBuV)	AV Reading (dBuV)	Ant. / CL CF (dB)	Actual Fs		Peak Limit (dBuV/m)	AV Limit (dBuV/m)	Margin (dB)	Remark
					Peak (dBuV/m)	AV (dBuV/m)				
1137	V	52.86	---	-11.24	41.62	---	74.00	54.00	-12.38	Peak
2573	V	59.38	---	-7.13	52.25	---	74.00	54.00	-1.75	Peak
3085	V	46.78	---	-5.74	41.04	---	74.00	54.00	-12.96	Peak
4824	V	39.83	---	0.64	40.47	---	74.00	54.00	-13.53	Peak
N/A										

EUT	Digital WI-FI Camera	Model Name	Moticam X
Temperature	26°C	Relative Humidity	56%
Pressure	960hPa	Test voltage	DC 5V From Adapter with AC 120V/60Hz
Test Mode	TX Low		

Freq. (MHz)	Ant. Pol H/V	Peak Reading (dBuV)	AV Reading (dBuV)	Ant. / CL CF (dB)	Actual Fs		Peak Limit (dBuV/m)	AV Limit (dBuV/m)	Margin (dB)	Remark
					Peak (dBuV/m)	AV (dBuV/m)				
1255	H	52.09	---	-10.96	41.13	---	74.00	54.00	-12.87	Peak
2016	H	50.12	---	-8.58	41.54	---	74.00	54.00	-12.46	Peak
3471	H	48.41	---	-4.95	43.46	---	74.00	54.00	-10.54	Peak
4824	H	41.89	---	0.64	42.53	---	74.00	54.00	-11.47	Peak
N/A										

Notes: AV Means AV detector test data, Peak Means Peak detector test data.
Emissions attenuated more than 20 dB below the permissible value are not reported.

EUT	Digital WI-FI Camera	Model Name	Moticam X
Temperature	26°C	Relative Humidity	56%
Pressure	960hPa	Test voltage	DC 5V From Adapter with AC 120V/60Hz
Test Mode	TX Mid		

Freq. (MHz)	Ant. Pol H/V	Peak Reading (dBuV)	AV Reading (dBuV)	Ant. / CL CF (dB)	Actual Fs		Peak Limit (dBuV/m)	AV Limit (dBuV/m)	Margin (dB)	Remark
					Peak (dBuV/m)	AV (dBuV/m)				
1354	V	52.11	---	-10.43	41.68	---	74.00	54.00	-12.32	Peak
2571	V	47.55	---	-7.13	40.420	---	74.00	54.00	-13.58	Peak
3396	V	47.43	---	-5.18	42.25	---	74.00	54.00	-11.75	Peak
4874	V	40.62	---	0.76	41.38	---	74.00	54.00	-12.62	Peak

EUT	Digital WI-FI Camera	Model Name	Moticam X
Temperature	26°C	Relative Humidity	56%
Pressure	960hPa	Test voltage	DC 5V From Adapter with AC 120V/60Hz
Test Mode	TX Mid		

Freq. (MHz)	Ant. Pol H/V	Peak Reading (dBuV)	AV Reading (dBuV)	Ant. / CL CF (dB)	Actual Fs		Peak Limit (dBuV/m)	AV Limit (dBuV/m)	Margin (dB)	Remark
					Peak (dBuV/m)	AV (dBuV/m)				
1339	H	51.47	---	-10.84	40.63	---	74.00	54.00	-13.37	Peak
2347	H	48.61	---	-7.46	41.15	---	74.00	54.00	-12.85	Peak
3589	H	46.80	---	-4.76	42.04	---	74.00	54.00	-11.96	Peak
4874	H	42.42	---	0.76	43.18	---	74.00	54.00	-10.82	Peak

Notes: AV Means AV detector test data, Peak Means Peak detector test data.
Emissions attenuated more than 20 dB below the permissible value are not reported.

EUT	Digital WI-FI Camera	Model Name	Moticam X
Temperature	26°C	Relative Humidity	56%
Pressure	960hPa	Test voltage	DC 5V From Adapter with AC 120V/60Hz
Test Mode	TX High		

Freq. (MHz)	Ant. Pol H/V	Peak Reading (dBuV)	AV Reading (dBuV)	Ant. / CL CF (dB)	Actual Fs		Peak Limit (dBuV/m)	AV Limit (dBuV/m)	Margin (dB)	Remark
					Peak (dBuV/m)	AV (dBuV/m)				
1320	V	51.37	---	-10.84	40.53	---	74.00	54.00	-13.47	Peak
2954	V	48.02	---	-5.86	42.16	---	74.00	54.00	-11.84	Peak
3826	V	45.49	---	-3.96	41.53	---	74.00	54.00	-12.47	Peak
4924	V	41.20	---	0.87	42.07	---	74.00	54.00	-11.93	Peak

EUT	Digital WI-FI Camera	Model Name	Moticam X
Temperature	26°C	Relative Humidity	56%
Pressure	960hPa	Test voltage	DC 5V From Adapter with AC 120V/60Hz
Test Mode	TX High		

Freq. (MHz)	Ant. Pol H/V	Peak Reading (dBuV)	AV Reading (dBuV)	Ant. / CL CF (dB)	Actual Fs		Peak Limit (dBuV/m)	AV Limit (dBuV/m)	Margin (dB)	Remark
					Peak (dBuV/m)	AV (dBuV/m)				
1422	H	52.01	---	-10.29	41.72	---	74.00	54.00	-12.28	Peak
2173	H	48.5	---	-8.24	40.26	---	74.00	54.00	-13.74	Peak
3916	H	45.11	---	-3.68	41.43	---	74.00	54.00	-12.57	Peak
4924	H	42.49	---	0.87	43.36	---	74.00	54.00	-10.64	Peak

Notes: AV Means AV detector test data, Peak Means Peak detector test data.
Emissions attenuated more than 20 dB below the permissible value are not reported.

IEEE 802.11n/HT20

EUT	Digital WI-FI Camera	Model Name	Moticam X
Temperature	26°C	Relative Humidity	56%
Pressure	960hPa	Test voltage	DC 5V From Adapter with AC 120V/60Hz
Test Mode	TX Low		

Freq. (MHz)	Ant. Pol H/V	Peak Reading (dBuV)	AV Reading (dBuV)	Ant. / CL CF (dB)	Actual Fs		Peak Limit (dBuV/m)	AV Limit (dBuV/m)	Margin (dB)	Remark
					Peak (dBuV/m)	AV (dBuV/m)				
1471	V	73.75	---	-10.27	63.48	---	74.00	54.00	9.48	Peak
2682	V	49.41	---	-6.94	42.47	---	74.00	54.00	-11.53	Peak
3911	V	44.92	---	-3.68	41.24	---	74.00	54.00	-12.76	Peak
4824	V	39.91	---	0.64	40.550	---	74.00	54.00	-13.45	Peak
N/A										

EUT	Digital WI-FI Camera	Model Name	Moticam X
Temperature	26°C	Relative Humidity	56%
Pressure	960hPa	Test voltage	DC 5V From Adapter with AC 120V/60Hz
Test Mode	TX Low		

Freq. (MHz)	Ant. Pol H/V	Peak Reading (dBuV)	AV Reading (dBuV)	Ant. / CL CF (dB)	Actual Fs		Peak Limit (dBuV/m)	AV Limit (dBuV/m)	Margin (dB)	Remark
					Peak (dBuV/m)	AV (dBuV/m)				
1495	H	51.43	---	-10.27	41.16	---	74.00	54.00	-12.84	Peak
2810	H	48.38	---	-6.17	42.21	---	74.00	54.00	-11.79	Peak
3621	H	45.94	---	-4.52	41.42	---	74.00	54.00	-12.58	Peak
4824	H	42.39	---	0.64	43.03	---	74.00	54.00	-10.97	Peak
N/A										

Notes: AV Means AV detector test data, Peak Means Peak detector test data.
Emissions attenuated more than 20 dB below the permissible value are not reported.

EUT	Digital WI-FI Camera	Model Name	Moticam X
Temperature	26°C	Relative Humidity	56%
Pressure	960hPa	Test voltage	DC 5V From Adapter with AC 120V/60Hz
Test Mode	TX Mid		

Freq. (MHz)	Ant. Pol H/V	Peak Reading (dBuV)	AV Reading (dBuV)	Ant. / CL CF (dB)	Actual Fs		Peak Limit (dBuV/m)	AV Limit (dBuV/m)	Margin (dB)	Remark
					Peak (dBuV/m)	AV (dBuV/m)				
1298	V	53.32	---	-10.96	42.36	---	74.00	54.00	-11.64	Peak
2041	V	51.84	---	-8.58	43.26	---	74.00	54.00	-10.74	Peak
3752	V	45.71	---	-4.07	41.64	---	74.00	54.00	-12.36	Peak
4874	V	40.37	---	0.76	41.13	---	74.00	54.00	-12.87	Peak

EUT	Digital WI-FI Camera	Model Name	Moticam X
Temperature	26°C	Relative Humidity	56%
Pressure	960hPa	Test voltage	DC 5V From Adapter with AC 120V/60Hz
Test Mode	TX Mid		

Freq. (MHz)	Ant. Pol H/V	Peak Reading (dBuV)	AV Reading (dBuV)	Ant. / CL CF (dB)	Actual Fs		Peak Limit (dBuV/m)	AV Limit (dBuV/m)	Margin (dB)	Remark
					Peak (dBuV/m)	AV (dBuV/m)				
1528	H	51.35	---	-10.14	41.21	---	74.00	54.00	-12.79	Peak
2391	H	49.91	---	-7.59	42.32	---	74.00	54.00	-11.68	Peak
3283	H	46.92	---	-5.39	41.53	---	74.00	54.00	-12.47	Peak
4874	H	42.66	---	0.76	43.42	---	74.00	54.00	-10.58	Peak

Notes: AV Means AV detector test data, Peak Means Peak detector test data.
Emissions attenuated more than 20 dB below the permissible value are not reported.

EUT	Digital WI-FI Camera	Model Name	Moticam X
Temperature	26°C	Relative Humidity	56%
Pressure	960hPa	Test voltage	DC 5V From Adapter with AC 120V/60Hz
Test Mode	TX High		

Freq. (MHz)	Ant. Pol H/V	Peak Reading (dBuV)	AV Reading (dBuV)	Ant. / CL CF (dB)	Actual Fs		Peak Limit (dBuV/m)	AV Limit (dBuV/m)	Margin (dB)	Remark
					Peak (dBuV/m)	AV (dBuV/m)				
1482	V	51.81	---	-10.27	41.54	---	74.00	54.00	-12.46	Peak
2739	V	49.69	---	-6.43	43.26	---	74.00	54.00	-10.74	Peak
3581	V	48.24	---	-4.76	43.48	---	74.00	54.00	-10.52	Peak
4924	V	65.61	---	0.87	66.48	---	74.00	54.00	12.48	Peak

EUT	Digital WI-FI Camera	Model Name	Moticam X
Temperature	26°C	Relative Humidity	56%
Pressure	960hPa	Test voltage	DC 5V From Adapter with AC 120V/60Hz
Test Mode	TX High		

Freq. (MHz)	Ant. Pol H/V	Peak Reading (dBuV)	AV Reading (dBuV)	Ant. / CL CF (dB)	Actual Fs		Peak Limit (dBuV/m)	AV Limit (dBuV/m)	Margin (dB)	Remark
					Peak (dBuV/m)	AV (dBuV/m)				
1542	H	51.39	---	-10.14	41.25	---	74.00	54.00	-12.75	Peak
3597	H	48.10	---	-4.96	43.14	---	74.00	54.00	-10.86	Peak
4173	H	43.01	---	-2.48	40.53	---	74.00	54.00	-13.47	Peak
4924	H	41.55	---	0.87	42.42	---	74.00	54.00	-11.58	Peak

Notes: AV Means AV detector test data, Peak Means Peak detector test data.
Emissions attenuated more than 20 dB below the permissible value are not reported.

IEEE 802.11n/HT40

EUT	Digital WI-FI Camera	Model Name	Moticam X
Temperature	26°C	Relative Humidity	56%
Pressure	960hPa	Test voltage	DC 5V From Adapter with AC 120V/60Hz
Test Mode	TX Low		

Freq. (MHz)	Ant. Pol H/V	Peak Reading (dBuV)	AV Reading (dBuV)	Ant. / CL CF (dB)	Actual Fs		Peak Limit (dBuV/m)	AV Limit (dBuV/m)	Margin (dB)	Remark
					Peak (dBuV/m)	AV (dBuV/m)				
1597	V	52.75	---	-10.07	42.68	---	74.00	54.00	-11.32	Peak
2672	V	50.20	---	-6.94	43.26	---	74.00	54.00	-10.74	Peak
3473	V	46.49	---	-4.95	41.54	---	74.00	54.00	-12.46	Peak
4844	V	39.55	---	0.64	40.19	---	74.00	54.00	-13.81	Peak
N/A										

EUT	Digital WI-FI Camera	Model Name	Moticam X
Temperature	26°C	Relative Humidity	56%
Pressure	960hPa	Test voltage	DC 5V From Adapter with AC 120V/60Hz
Test Mode	TX Low		

Freq. (MHz)	Ant. Pol H/V	Peak Reading (dBuV)	AV Reading (dBuV)	Ant. / CL CF (dB)	Actual Fs		Peak Limit (dBuV/m)	AV Limit (dBuV/m)	Margin (dB)	Remark
					Peak (dBuV/m)	AV (dBuV/m)				
1505	H	51.39	---	-10.14	41.25	---	74.00	54.00	-12.75	Peak
2391	H	50.11	---	-7.59	42.52	---	74.00	54.00	-11.48	Peak
3052	H	49.21	---	-5.74	43.47	---	74.00	54.00	-10.53	Peak
4844	H	40.60	---	0.64	41.24	---	74.00	54.00	-12.76	Peak
N/A										

Notes: AV Means AV detector test data, Peak Means Peak detector test data.
Emissions attenuated more than 20 dB below the permissible value are not reported.

EUT	Digital WI-FI Camera	Model Name	Moticam X
Temperature	26°C	Relative Humidity	56%
Pressure	960hPa	Test voltage	DC 5V From Adapter with AC 120V/60Hz
Test Mode	TX Mid		

Freq. (MHz)	Ant. Pol H/V	Peak Reading (dBuV)	AV Reading (dBuV)	Ant. / CL CF (dB)	Actual Fs		Peak Limit (dBuV/m)	AV Limit (dBuV/m)	Margin (dB)	Remark
					Peak (dBuV/m)	AV (dBuV/m)				
1609	V	50.60	---	-9.84	40.76	---	74.00	54.00	-13.24	Peak
2577	V	49.45	---	-7.13	42.320	---	74.00	54.00	-11.68	Peak
3320	V	48.73	---	-5.31	43.42	---	74.00	54.00	-10.58	Peak
4874	V	40.77	---	0.76	41.53	---	74.00	54.00	-12.47	Peak

EUT	Digital WI-FI Camera	Model Name	Moticam X
Temperature	26°C	Relative Humidity	56%
Pressure	960hPa	Test voltage	DC 5V From Adapter with AC 120V/60Hz
Test Mode	TX Mid		

Freq. (MHz)	Ant. Pol H/V	Peak Reading (dBuV)	AV Reading (dBuV)	Ant. / CL CF (dB)	Actual Fs		Peak Limit (dBuV/m)	AV Limit (dBuV/m)	Margin (dB)	Remark
					Peak (dBuV/m)	AV (dBuV/m)				
1592	H	50.89	---	-10.07	40.82	---	74.00	54.00	-13.18	Peak
2211	H	49.72	---	-8.13	41.59	---	74.00	54.00	-12.41	Peak
3185	H	45.94	---	-5.52	40.42	---	74.00	54.00	-13.58	Peak
4874	H	41.42	---	0.76	42.18	---	74.00	54.00	-11.82	Peak

Notes: AV Means AV detector test data, Peak Means Peak detector test data.
Emissions attenuated more than 20 dB below the permissible value are not reported.

EUT	Digital WI-FI Camera	Model Name	Moticam X
Temperature	26°C	Relative Humidity	56%
Pressure	960hPa	Test voltage	DC 5V From Adapter with AC 120V/60Hz
Test Mode	TX High		

Freq. (MHz)	Ant. Pol H/V	Peak Reading (dBuV)	AV Reading (dBuV)	Ant. / CL CF (dB)	Actual Fs		Peak Limit (dBuV/m)	AV Limit (dBuV/m)	Margin (dB)	Remark
					Peak (dBuV/m)	AV (dBuV/m)				
1618	V	47.42	---	-9.84	37.58	---	74.00	54.00	-16.42	Peak
2572	V	47.74	---	-7.13	40.61	---	74.00	54.00	-13.39	Peak
3890	V	43.56	---	-3.84	39.72	---	74.00	54.00	-14.28	Peak
4904	V	41.4	---	0.87	42.27	---	74.00	54.00	-11.73	Peak

EUT	Digital WI-FI Camera	Model Name	Moticam X
Temperature	26°C	Relative Humidity	56%
Pressure	960hPa	Test voltage	DC 5V From Adapter with AC 120V/60Hz
Test Mode	TX High		

Freq. (MHz)	Ant. Pol H/V	Peak Reading (dBuV)	AV Reading (dBuV)	Ant. / CL CF (dB)	Actual Fs		Peak Limit (dBuV/m)	AV Limit (dBuV/m)	Margin (dB)	Remark
					Peak (dBuV/m)	AV (dBuV/m)				
1751	H	50.79	---	-9.27	41.52	---	74.00	54.00	-12.48	Peak
2833	H	46.45	---	-6.17	40.28	---	74.00	54.00	-13.72	Peak
3725	H	46.42	---	-4.24	42.18	---	74.00	54.00	-11.82	Peak
4904	H	42.06	---	0.87	42.93	---	74.00	54.00	-11.07	Peak

Notes: AV Means AV detector test data, Peak Means Peak detector test data.
Emissions attenuated more than 20 dB below the permissible value are not reported.

6 POWER LINE CONDUCTED EMISSION

6.1 Conducted Emission Limits(15.207)

Frequency MHz	Limits dB(μ V)	
	Quasi-peak Level	Average Level
0.15 -0.50	66 -56*	56 - 46*
0.50 -5.00	56	46
5.00 -30.00	60	50

Notes: 1. *Decreasing linearly with logarithm of frequency.

2. The lower limit shall apply at the transition frequencies.

3. The limit decreases in line with the logarithm of the frequency in the rang of 0.15 to 0.50 MHz.

6.2 Test Setup

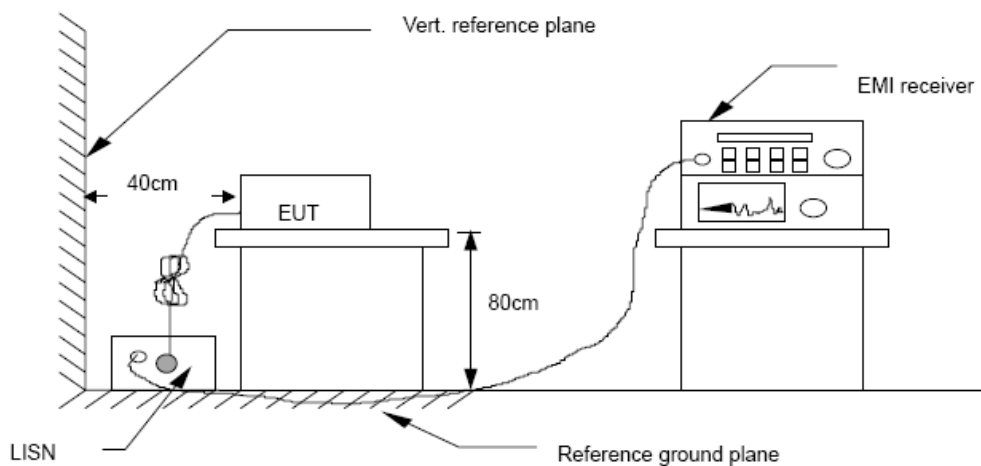

6.3 Test Procedure

The EUT is put on the plane 0.8m high above the ground by insulating support and is connected to the power mains through a line impedance stabilization network (L.I.S.N.). This provides a 50ohm coupling impedance for the EUT system. Please refer the block diagram of the test setup and photographs. Both sides of AC lines are checked to find out the maximum conducted emission. In order to find the maximum emission levels, the relative positions of equipment and all of the interface cables shall be changed according to ANSI C63.4-2003 on Conducted Emission Measurement. The bandwidth of test receiver (R & S ESCS30) is set at 9 kHz.

6.4 Test Results

PASS

Detailed information please see the following page.



Shenzhen Certification Technology Service Co., Ltd.
 2F, Building B, East Area of Nanchang Second Industrial Zone,
 Gushu 2nd Road, Bao'an District, Shenzhen 518126, P.R. China
 Tel: 4006786199 Fax: +86-755-26736857
 Website: <http://www.cessz.com> Email: Service@cessz.com

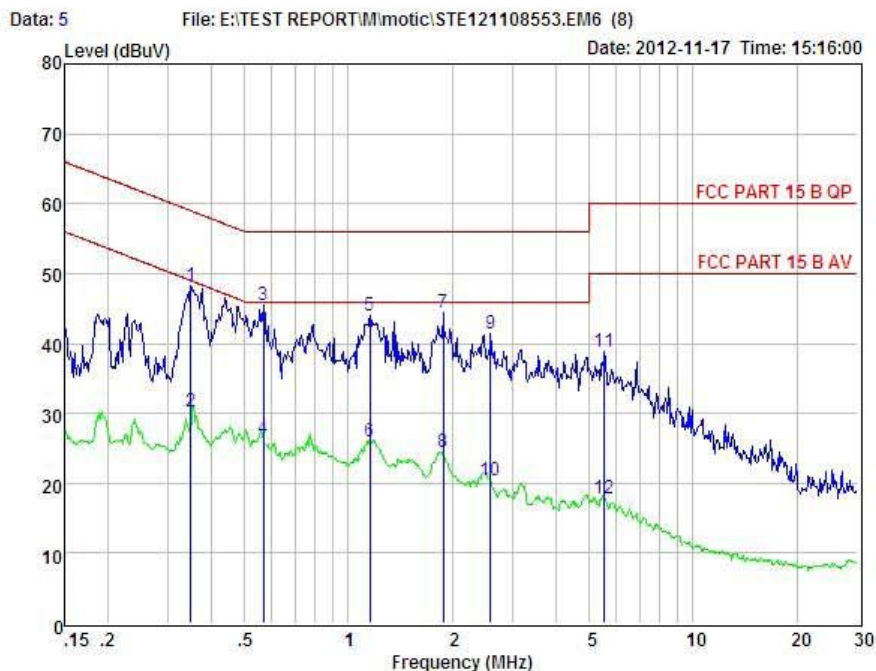

Condition : FCC PART 15 B QP POL: LINE Temp:24 °C Hum:56 %
 EUT : Digital WI-FI Camera
 Model No : Motocam X
 Test Mode : On
 Power : DC 5V From Adapter AC 120V/60Hz
 Test Engineer: Reak
 Remark :

Item	Freq MHz	Read dBuV	LISN Factor dB	Preamp Factor dB	Cable Loss dB	Level dBuV	Limit dBuV	Margin dBuV	Remark
1	0.35	38.47	0.03	-9.72	0.10	48.32	59.00	-10.68	QP
2	0.35	20.47	0.03	-9.72	0.10	30.32	49.00	-18.68	Average
3	0.57	35.55	0.03	-9.72	0.10	45.40	56.00	-10.60	QP
4	0.57	16.55	0.03	-9.72	0.10	26.40	46.00	-19.60	Average
5	1.15	34.16	0.04	-9.71	0.10	44.01	56.00	-11.99	QP
6	1.15	16.16	0.04	-9.71	0.10	26.01	46.00	-19.99	Average
7	1.89	34.59	0.05	-9.70	0.10	44.44	56.00	-11.56	QP
8	1.89	14.59	0.05	-9.70	0.10	24.44	46.00	-21.56	Average
9	2.58	31.58	0.06	-9.70	0.11	41.45	56.00	-14.55	QP
10	2.58	10.58	0.06	-9.70	0.11	20.45	46.00	-25.55	Average
11	5.53	29.00	0.10	-9.64	0.13	38.87	60.00	-21.13	QP
12	5.53	8.00	0.10	-9.64	0.13	17.87	50.00	-32.13	Average

Remarks: Level = Read + LISN Factor - Preamp Factor + Cable loss



Shenzhen Certification Technology Service Co., Ltd.
 2F, Building B, East Area of Nanchang Second Industrial Zone,
 Gushu 2nd Road, Bao'an District, Shenzhen 518126, P.R. China
 Tel: 4006786199 Fax: +86-755-26736857
 Website: <http://www.cessz.com> Email: Service@cessz.com

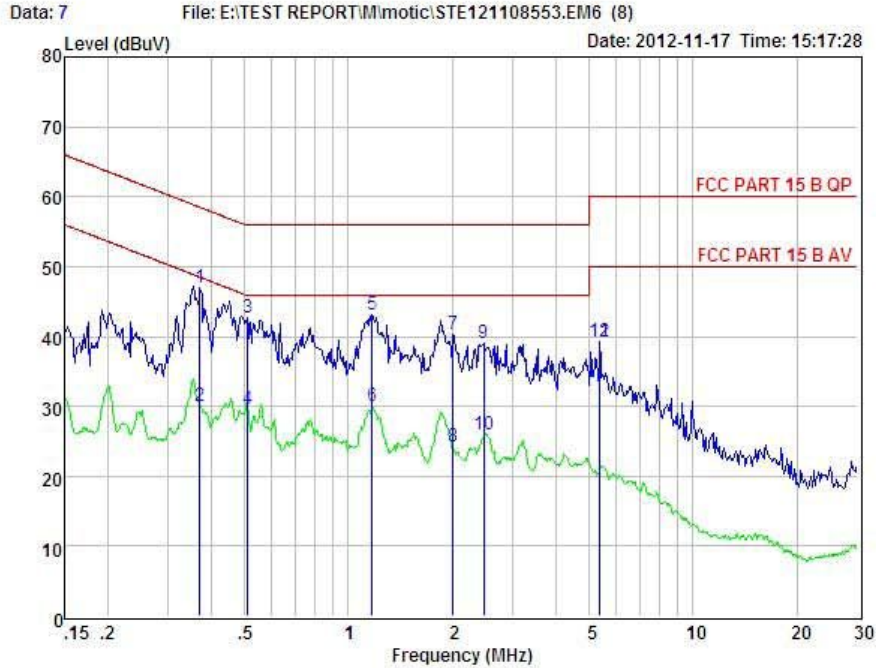

Condition : FCC PART 15 B QP POL: NEUTRAL Temp:24 °C Hum:56 %
 EUT : Digital WI-FI Camera
 Model No : Moticom X
 Test Mode : On
 Power : DC 5V From Adapter AC 120V/60Hz
 Test Engineer: Reak
 Remark :

Item	Freq MHz	Read dBuV	LISN Factor dB	Preamp Factor dB	Cable Loss dB	Level dBuV	Limit dBuV	Margin dBuV	Remark
1	0.37	37.08	0.03	-9.72	0.10	46.93	58.47	-11.54	QP
2	0.37	20.08	0.03	-9.72	0.10	29.93	48.47	-18.54	Average
3	0.51	32.77	0.03	-9.72	0.10	42.62	56.00	-13.38	QP
4	0.51	19.77	0.03	-9.72	0.10	29.62	46.00	-16.38	Average
5	1.17	33.24	0.04	-9.71	0.10	43.09	56.00	-12.91	QP
6	1.17	20.24	0.04	-9.71	0.10	30.09	46.00	-15.91	Average
7	2.01	30.43	0.06	-9.70	0.10	40.29	56.00	-15.71	QP
8	2.01	14.43	0.06	-9.70	0.10	24.29	46.00	-21.71	Average
9	2.47	29.10	0.06	-9.70	0.11	38.97	56.00	-17.03	QP
10	2.47	16.10	0.06	-9.70	0.11	25.97	46.00	-20.03	Average
11	5.36	29.45	0.10	-9.66	0.13	39.34	60.00	-20.66	QP
12	5.36	29.45	0.10	-9.66	0.13	39.34	50.00	-10.66	Average

Remarks: Level = Read + LISN Factor - Preamp Factor + Cable loss

7 Conducted Maximum Output Power

7.1 Test limit

Please refer section 15.247.

Regulation 15.247(b) The limit of Maximum Peak Output Power Measurement is 1W(30dBm)

7.2 Test Procedure

Details see the KDB558074 D01 Meas Guidance

- 7.2.1 Place the EUT on the table and set it in transmitting mode.
- 7.2.2 Remove the antenna from the EUT and then connect a low loss RF cable from the antenna port to the spectrum analyzer.
- 7.2.3 Set the spectrum analyzer as RBW = 3MHz, VBW = 3MHz, Sweep=auto.
- 7.2.4 Record the max. reading.
- 7.2.5 Repeat the above procedure until the measurements for all frequencies are completed.

Details see the KDB558074 DTS Meas Guidance

7.3 Test Setup

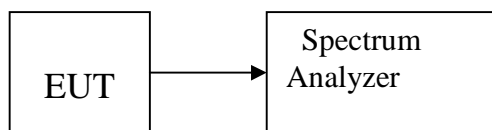

7.4 Test Results

PASS

Detailed information please see the following page.

Channel	Frequency (MHz)	Data Rate (Mbps)	PK Output Power (dBm)	AVG Output Power (dBm)	Limit (dBm)
IEEE802.11b					
Low	2412	1	13.49	10.31	30
Mid	2437	1	13.87	11.20	30
High	2462	1	14.55	11.66	30
IEEE802.11g					
Low	2412	6	15.55	12.35	30
Mid	2437	6	16.43	13.50	30
High	2462	6	17.87	14.05	30
IEEE802.11n HT20					
Low	2412	6.5	14.74	12.57	30
Mid	2437	6.5	16.50	14.26	30
High	2462	6.5	16.68	14.65	30
IEEE802.11n HT40					
Low	2422	13	9.05	6.84	30
Mid	2437	13	8.36	6.13	30
High	2452	13	8.71	6.54	30

26dB bandwidth(EBW)

IEEE 802.11b: CH Low :

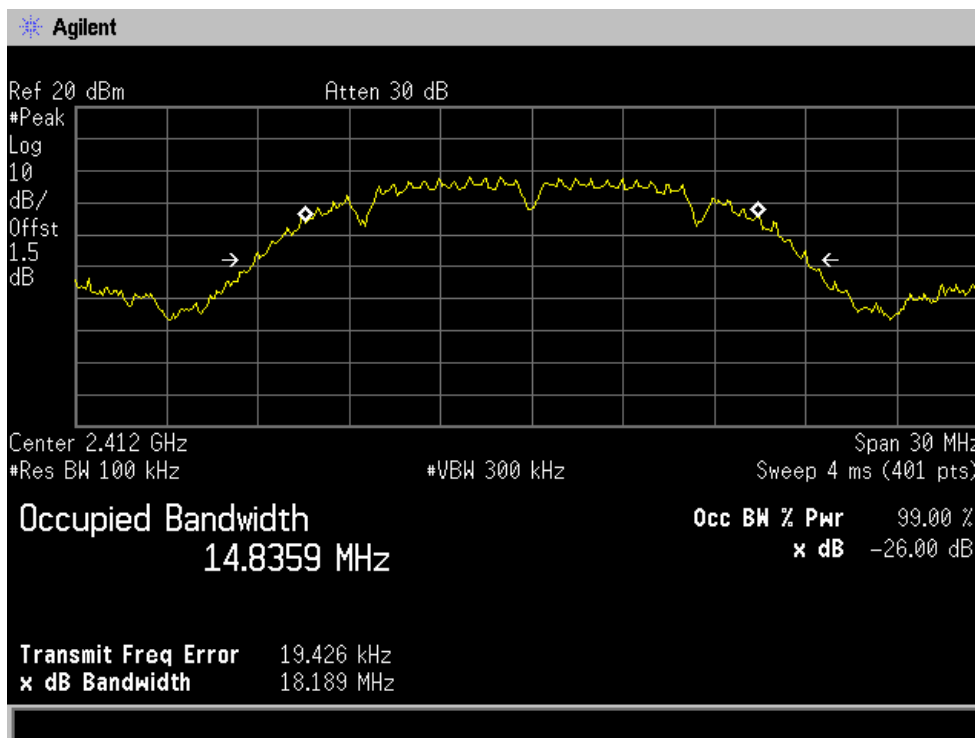

CH Mid:

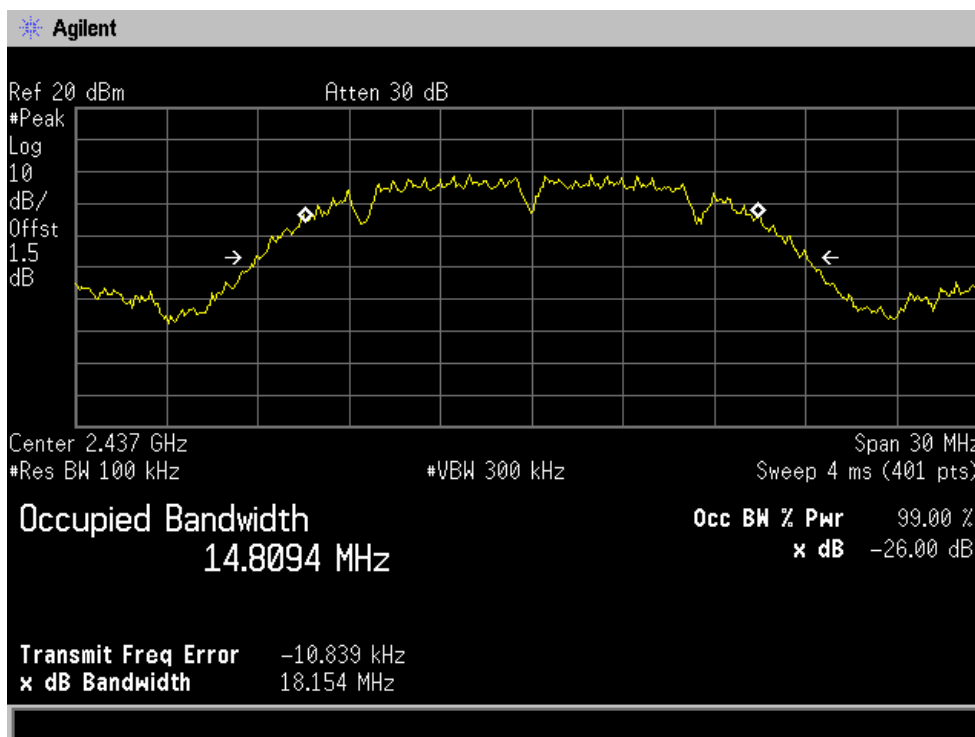

CH High:

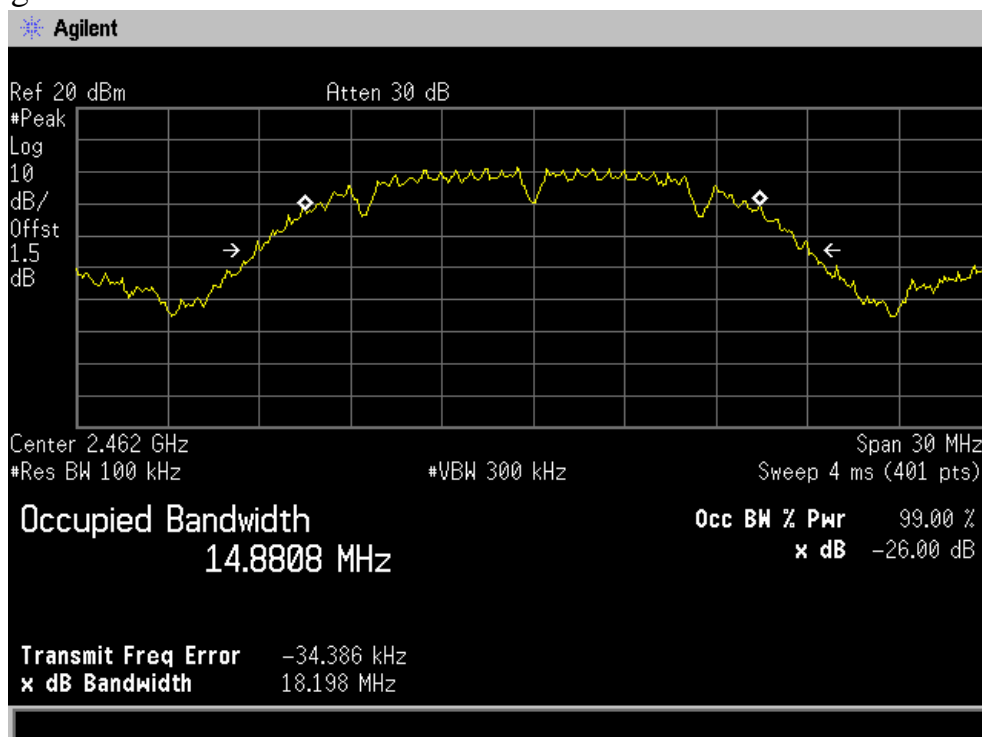

IEEE 802.11g: CH Low :

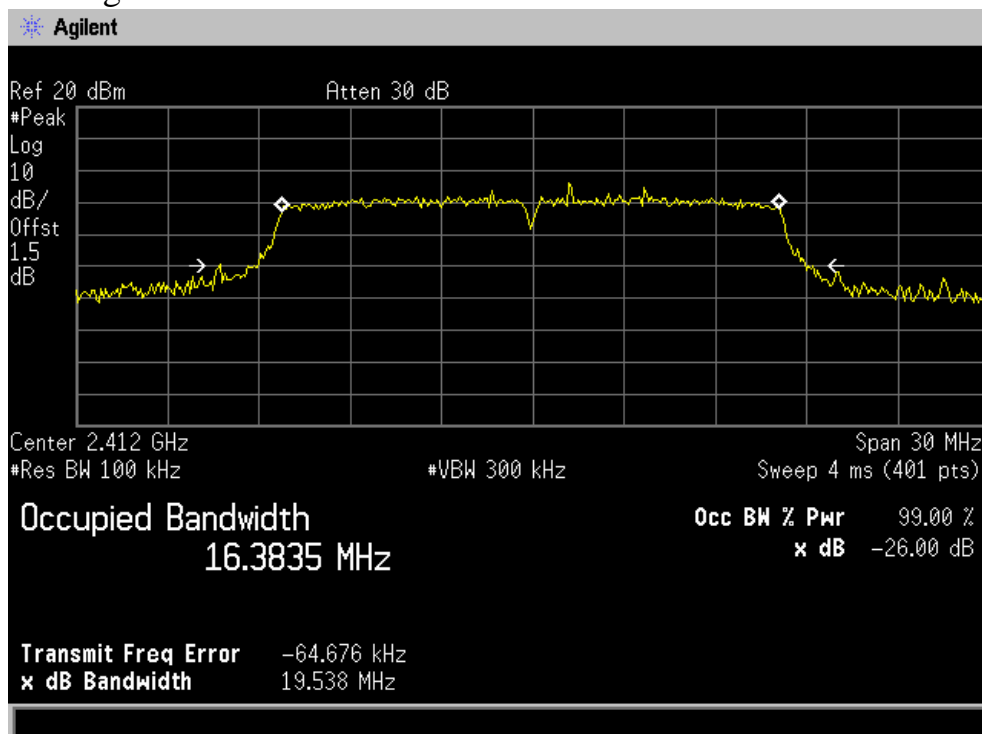

CH Mid:

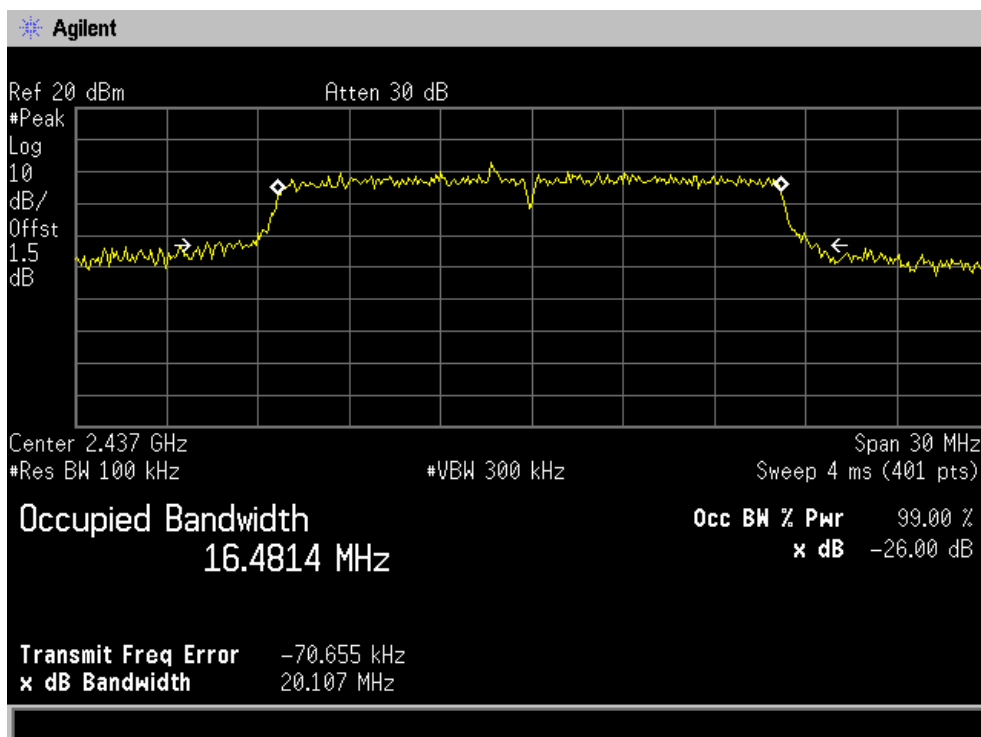

CH High:

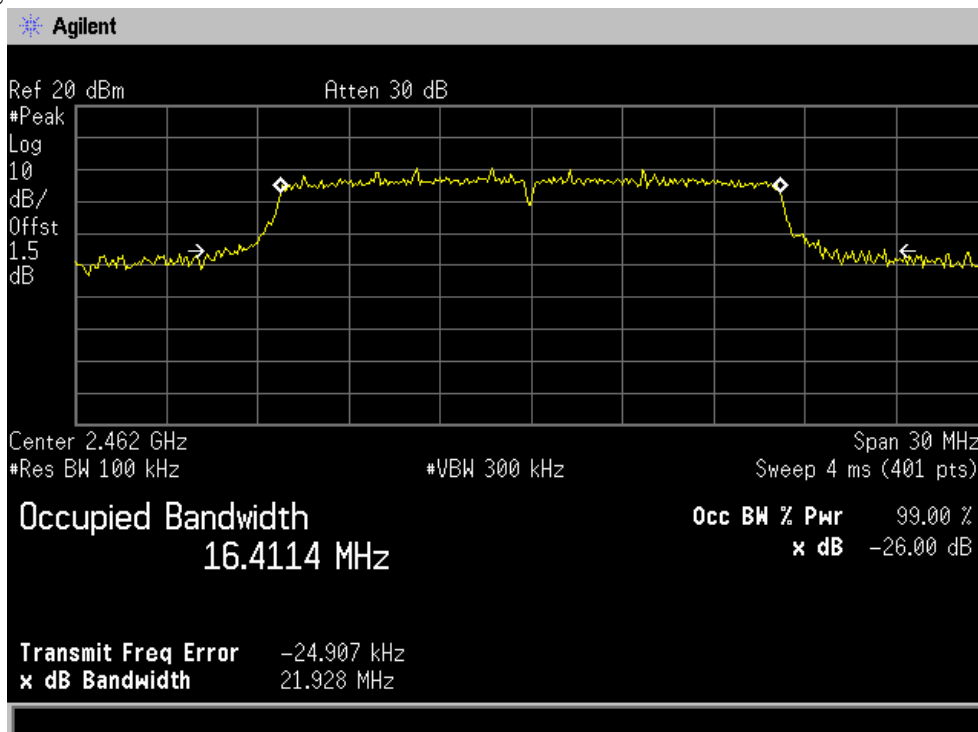

IEEE 802.11n/HT20: CH Low :

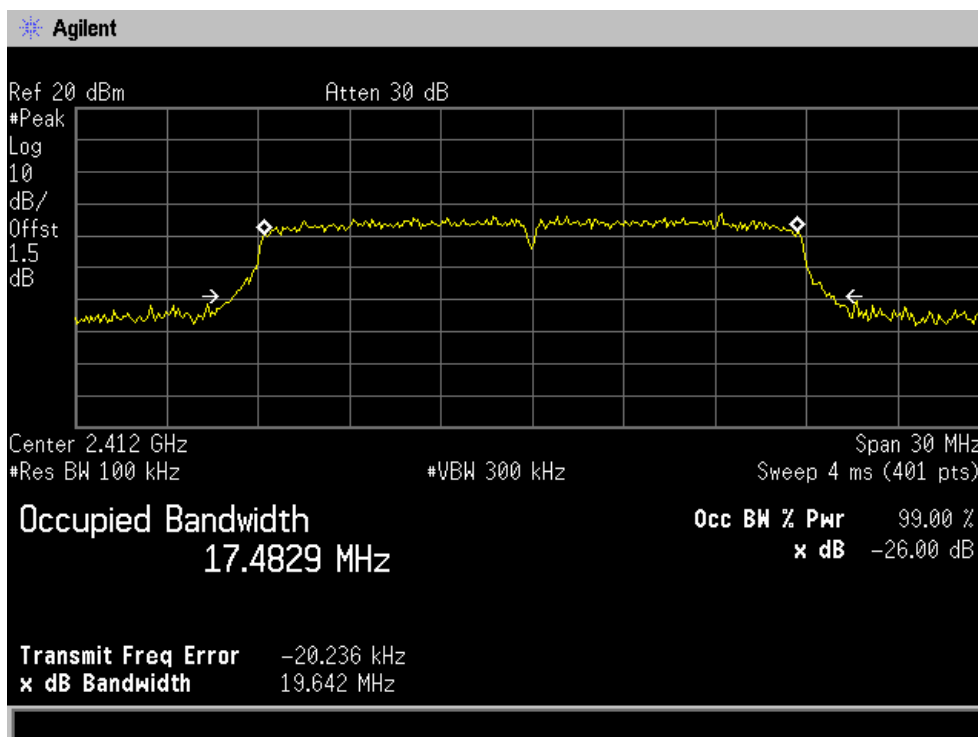

CH Mid :

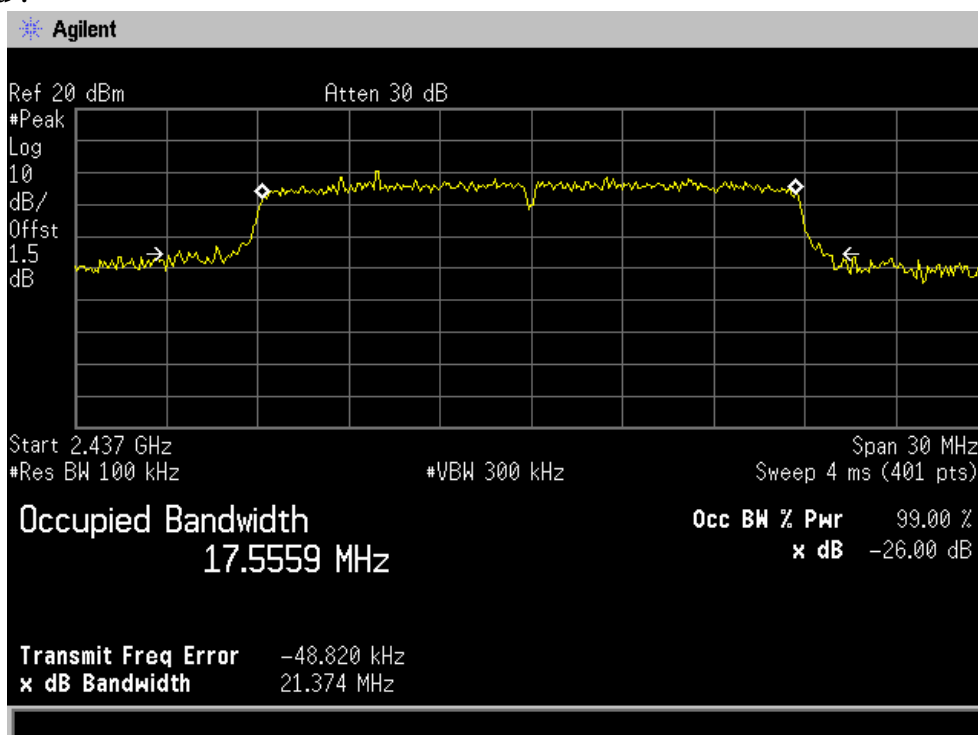

CH High :

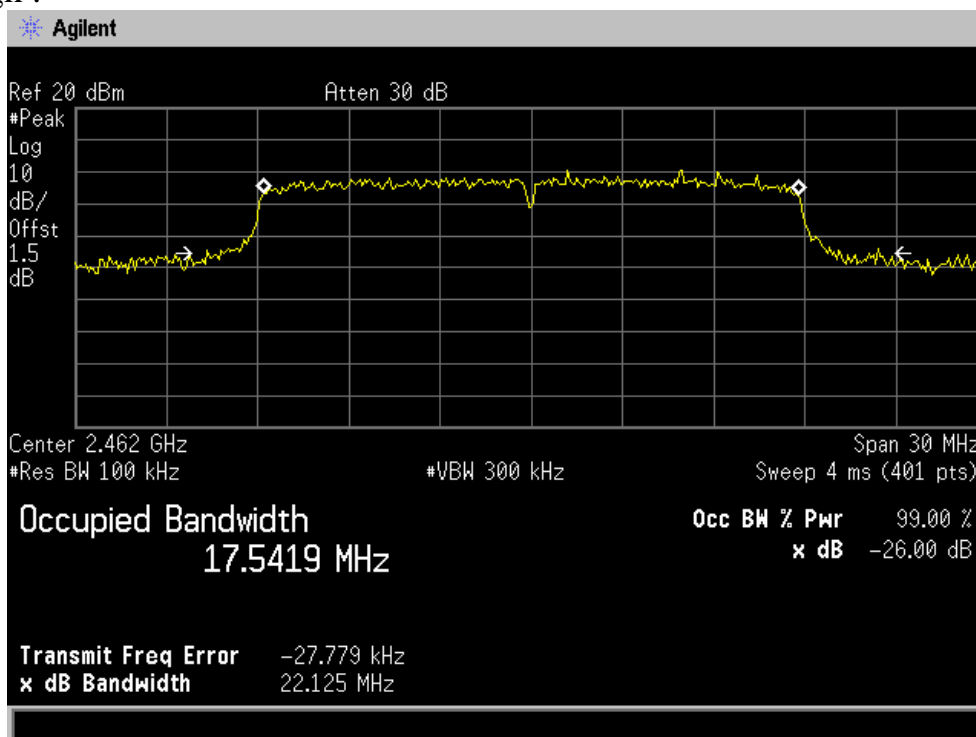

IEEE 802.11n/HT40: CH Low :

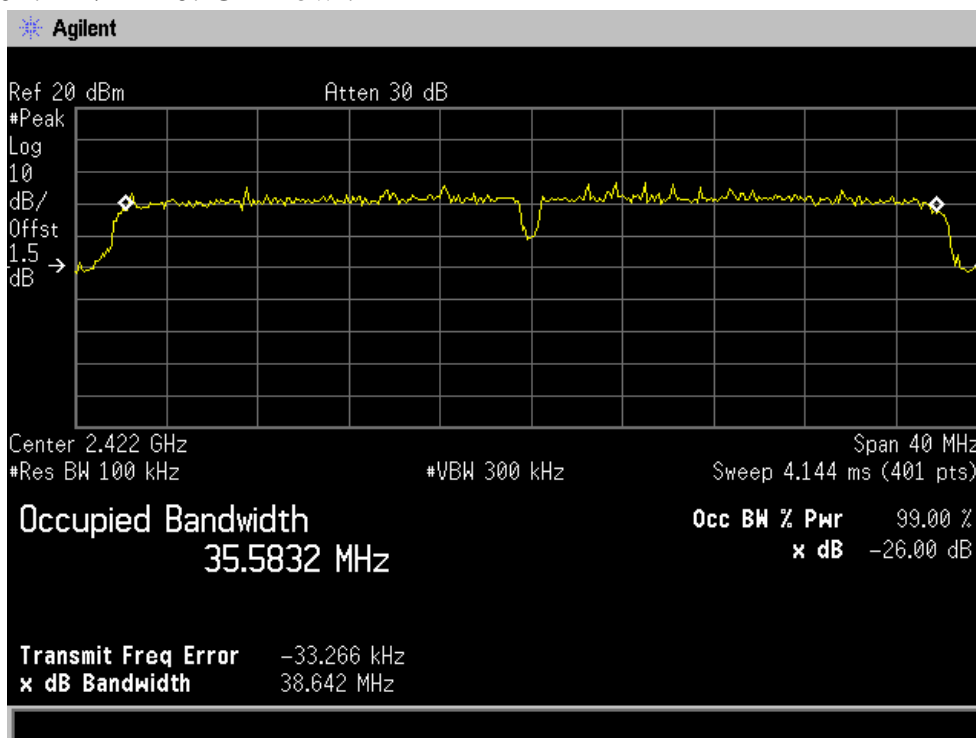

CH Mid :

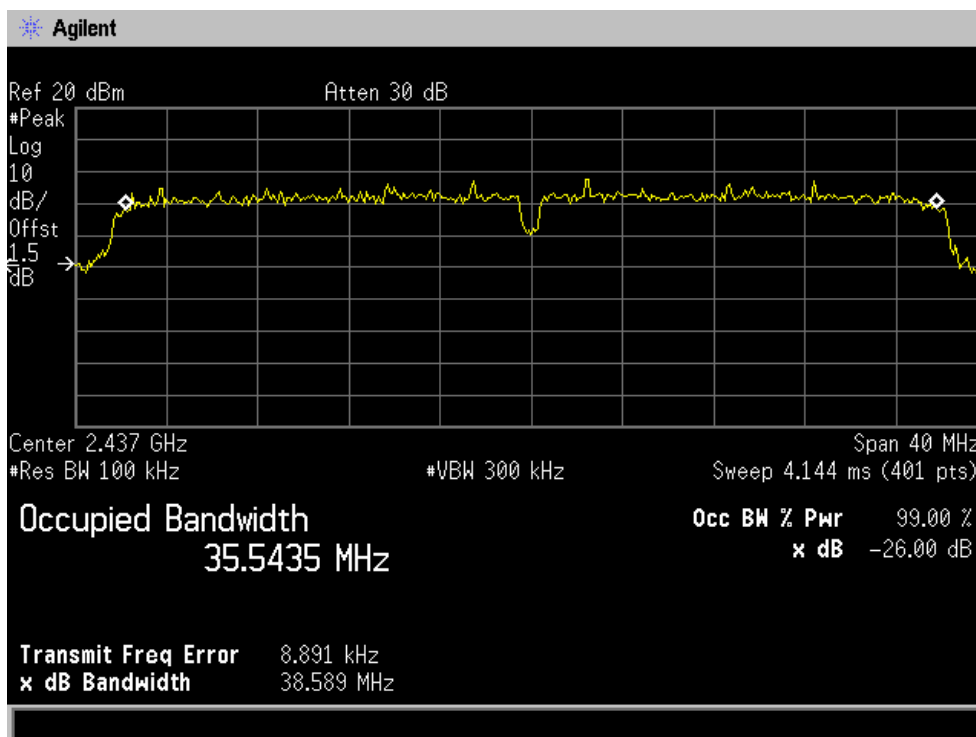

CH High :

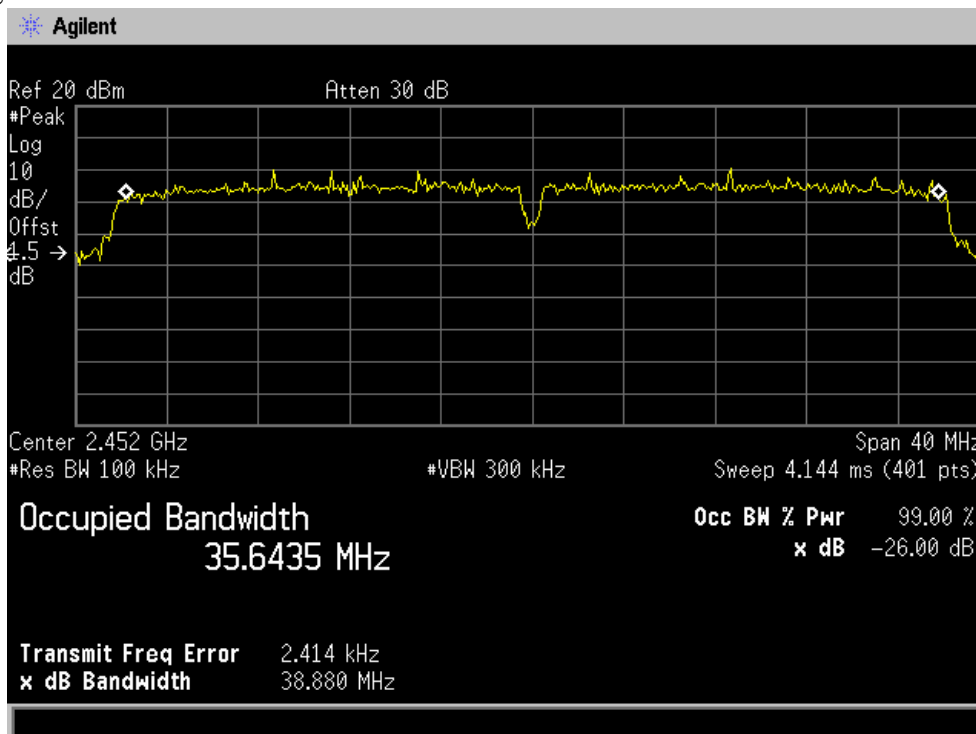

Maximum Peak Conducted Output Power

IEEE 802.11b: CH Low :

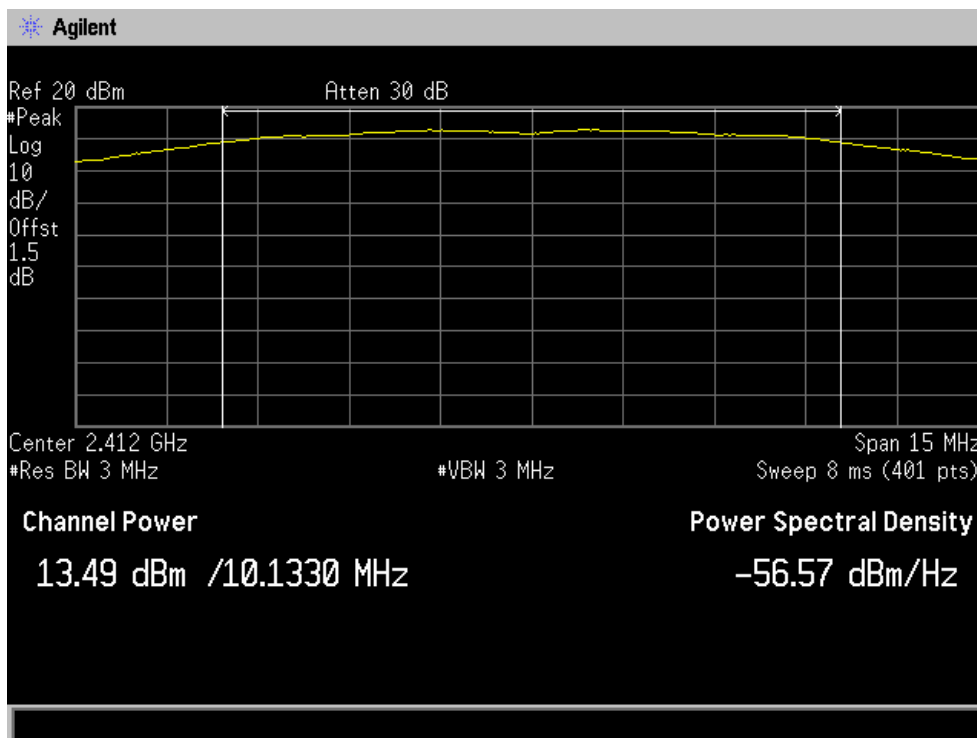

CH Mid :

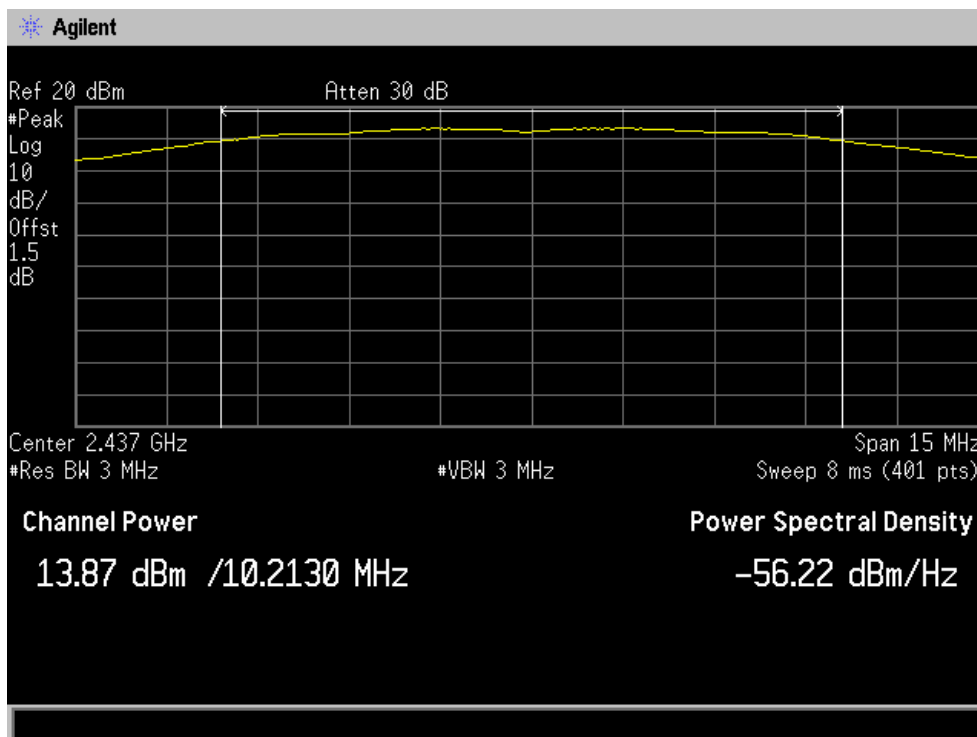

CH High :

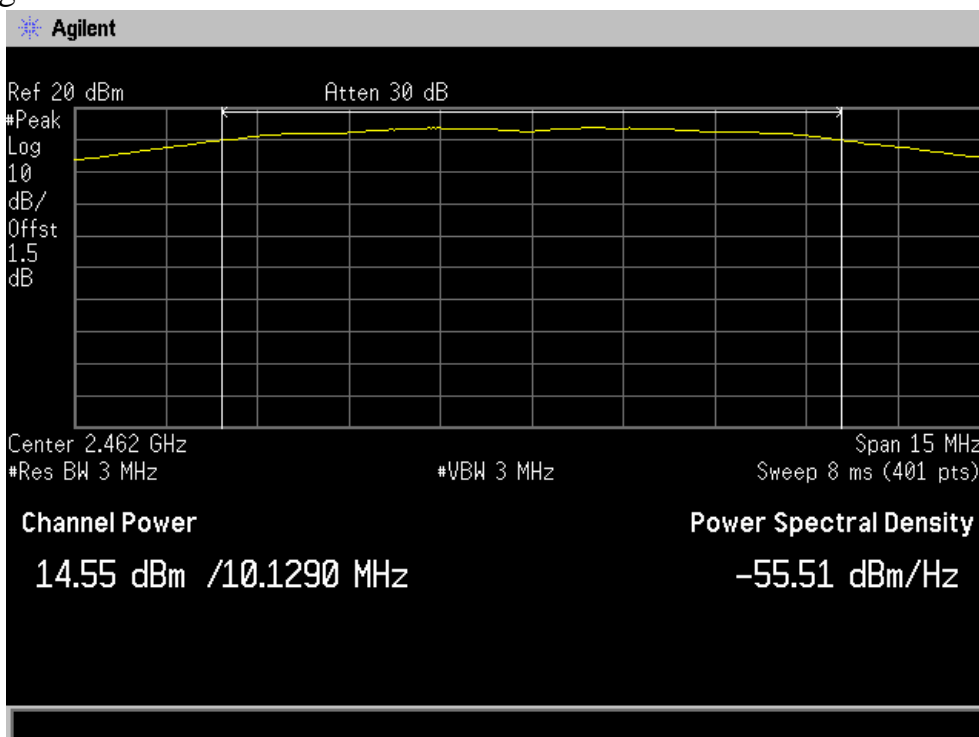

IEEE 802.11g: CH Low :

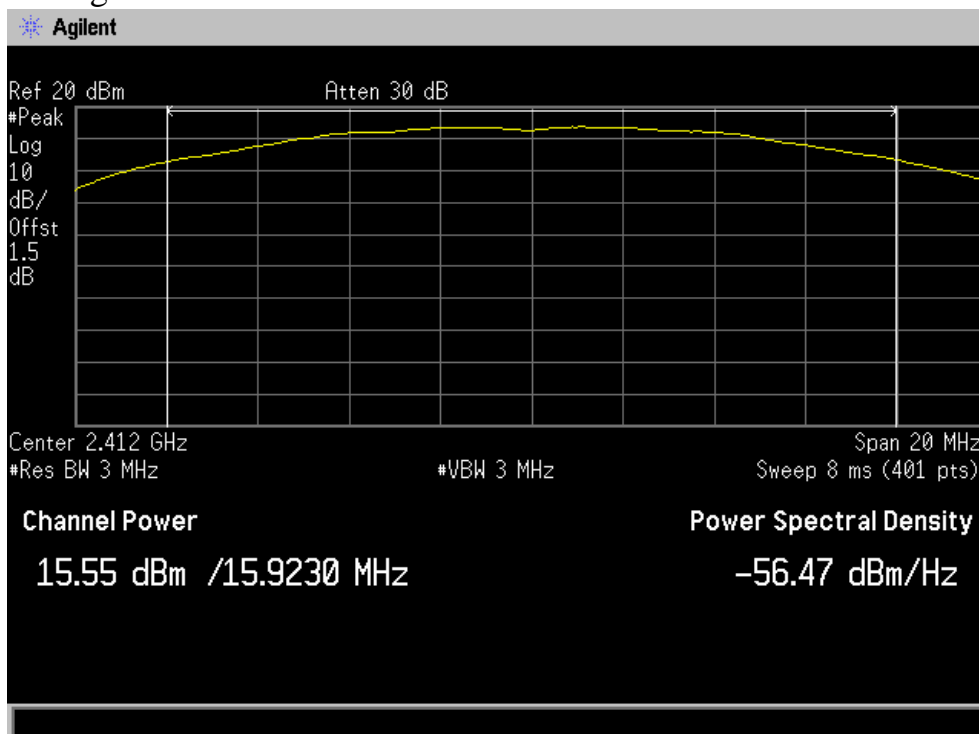

CH Mid :

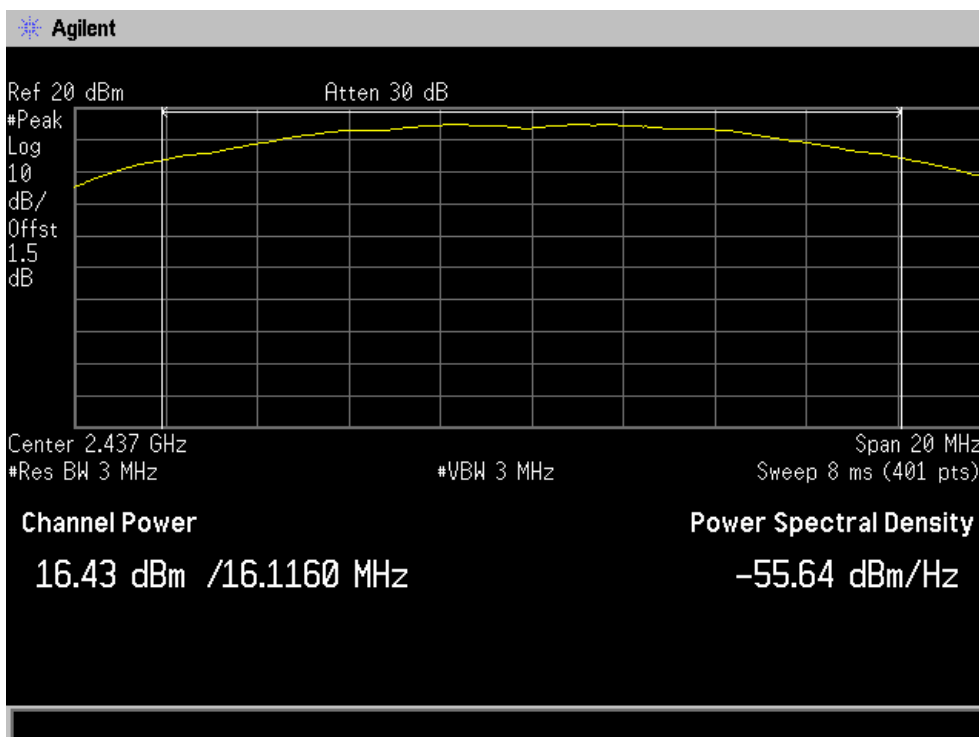

CH High :

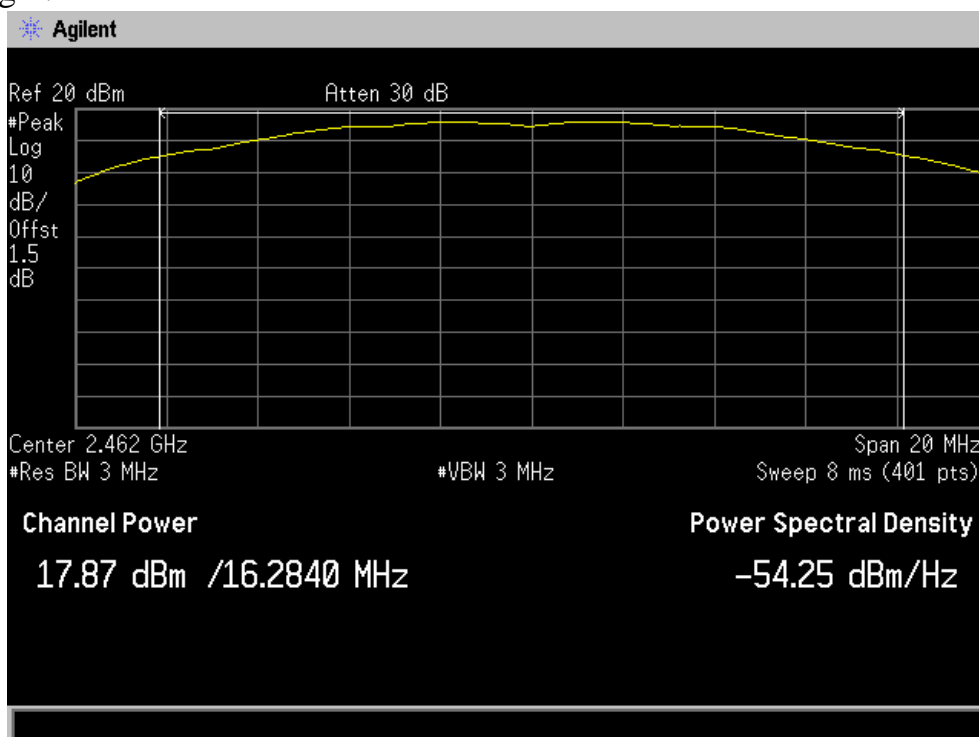

IEEE 802.11n/HT20: CH Low :

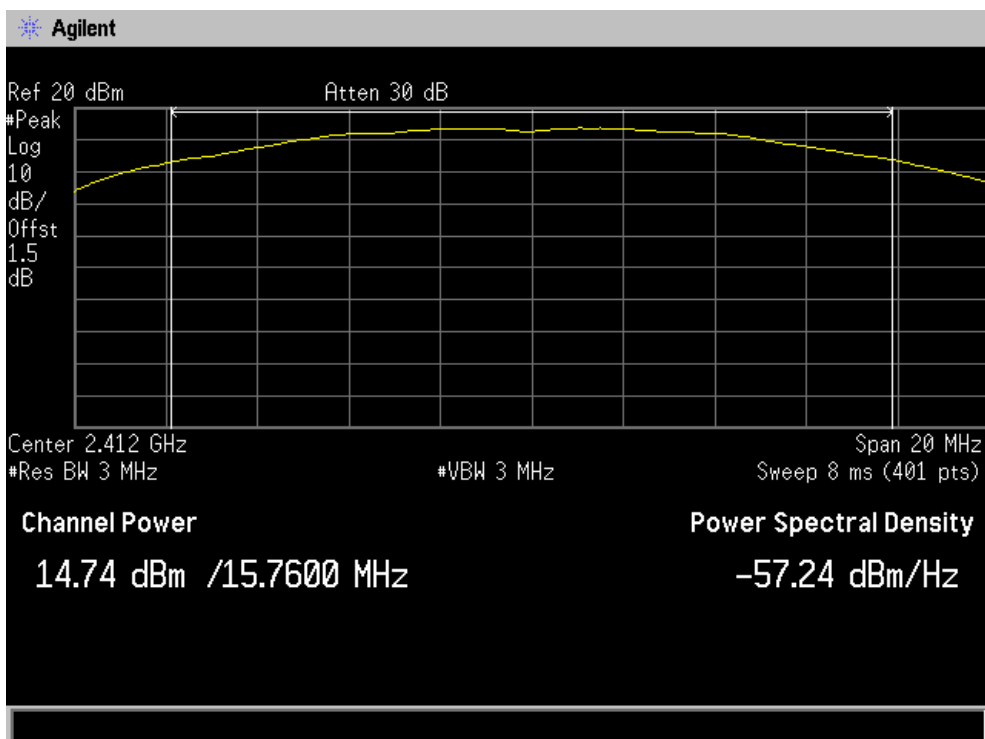

CH Mid :

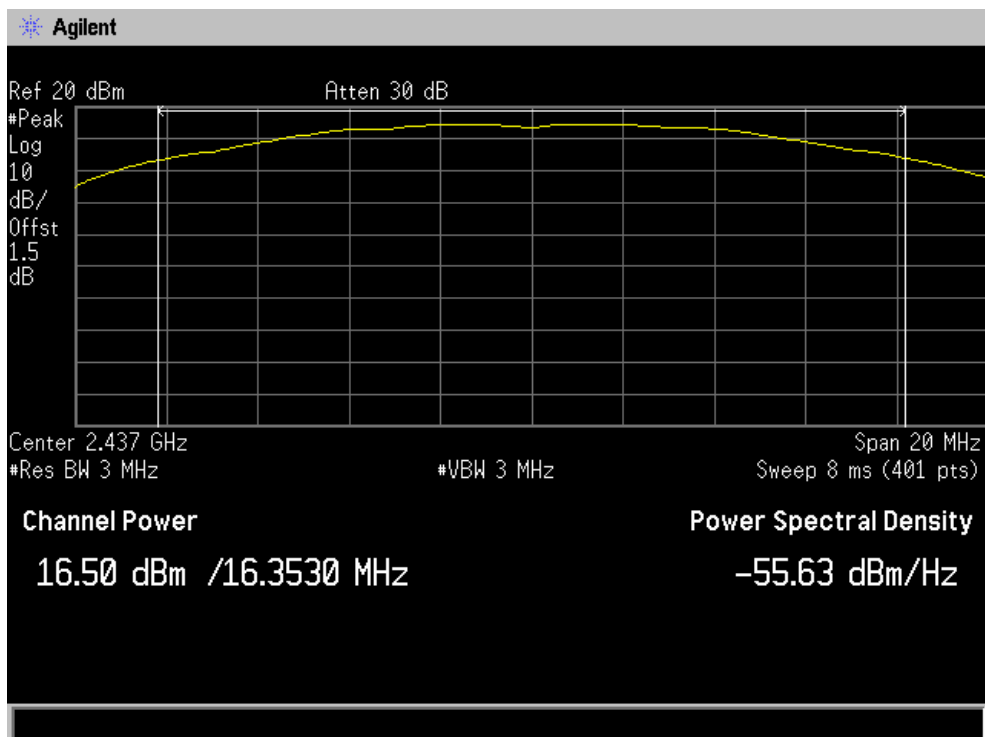

CH High :

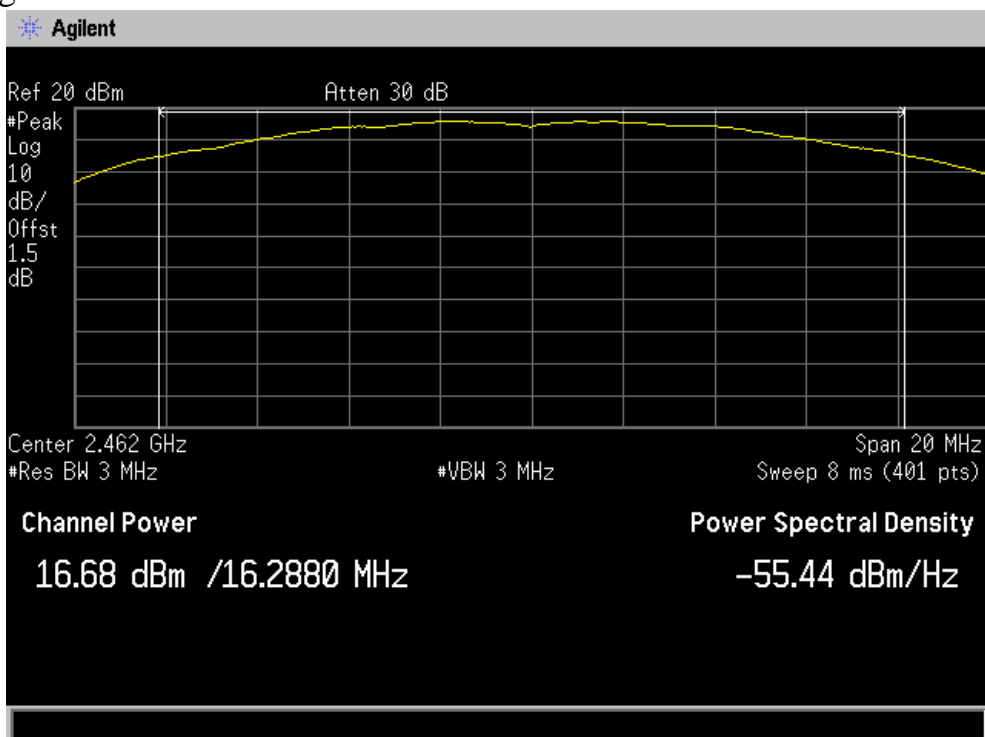

IEEE 802.11n/HT40: CH Low :

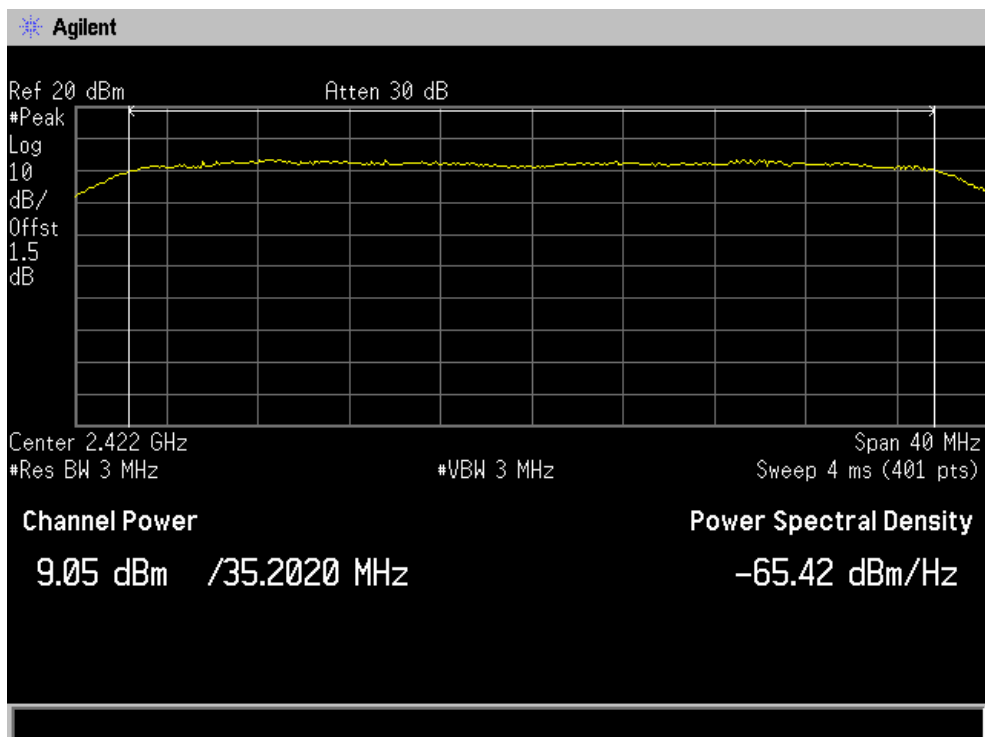

CH Mid :

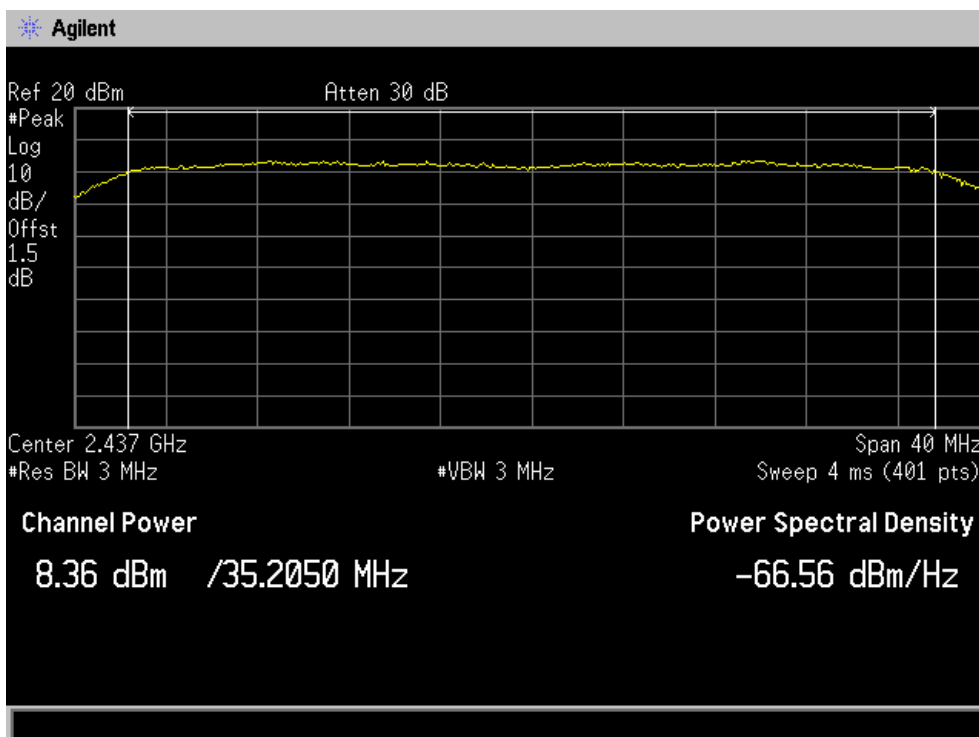

CH High :

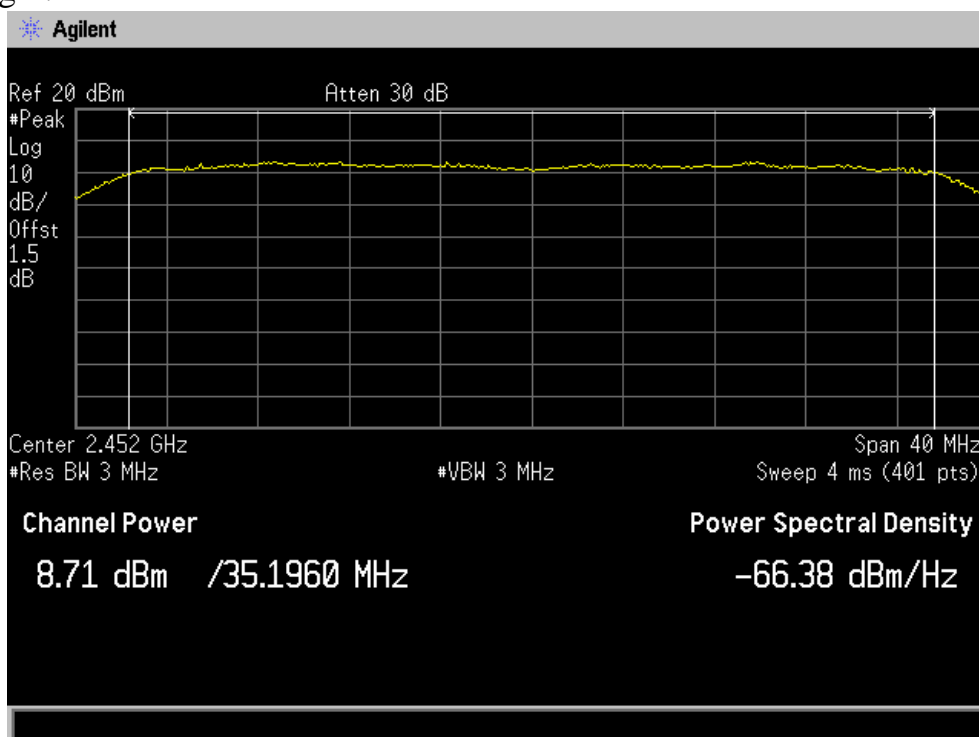

Maximum Conducted Output Power

IEEE 802.11b: CH Low :

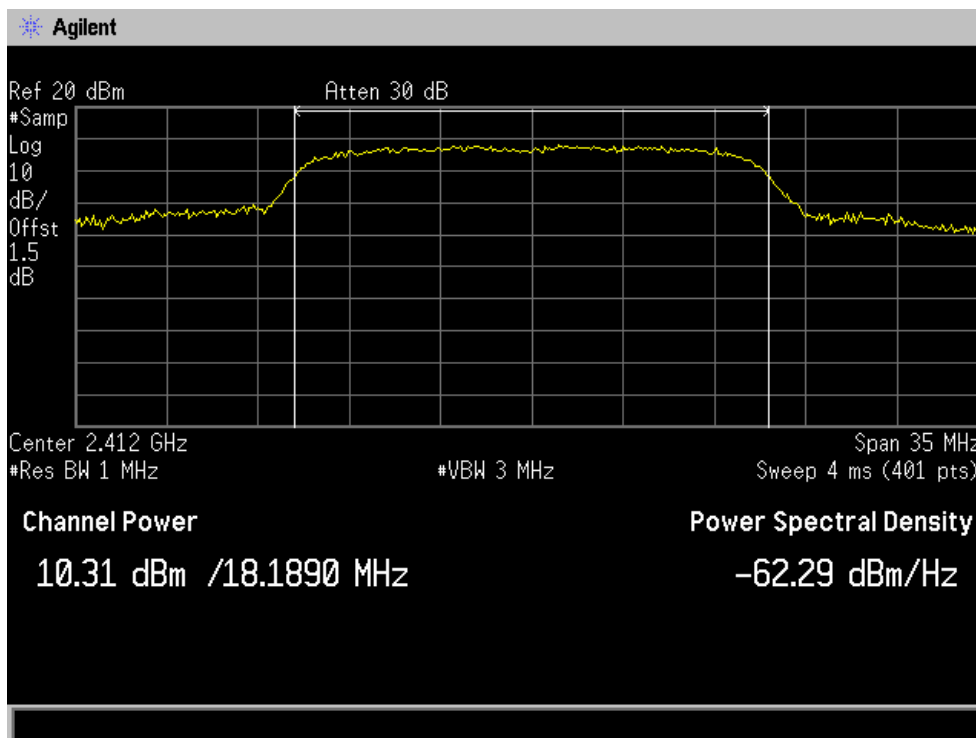

CH Mid :

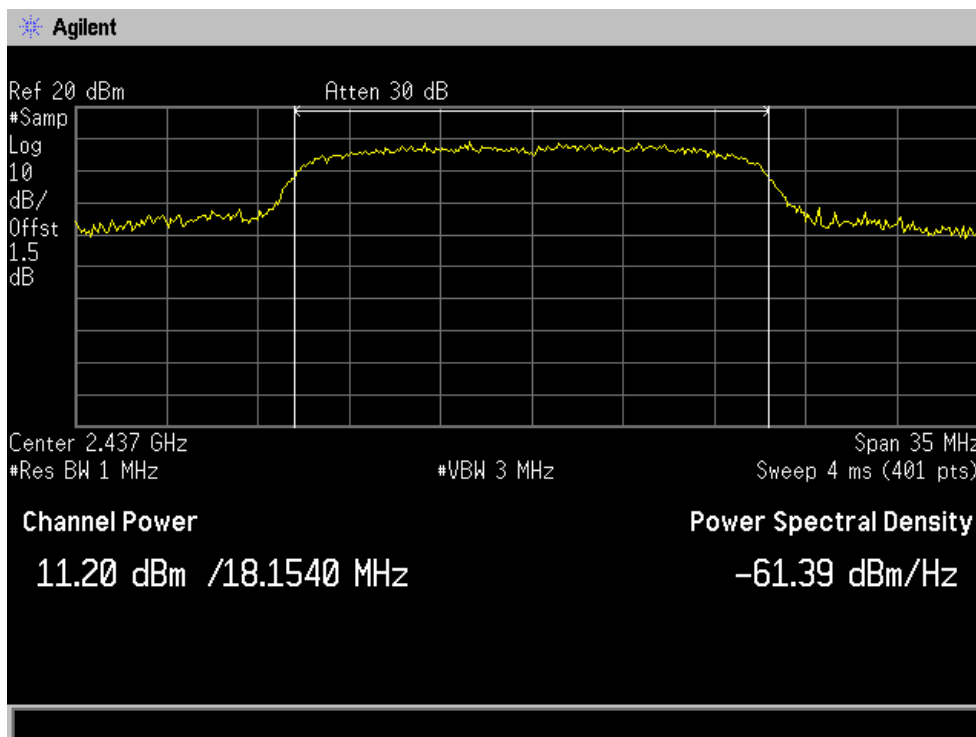

CH High :

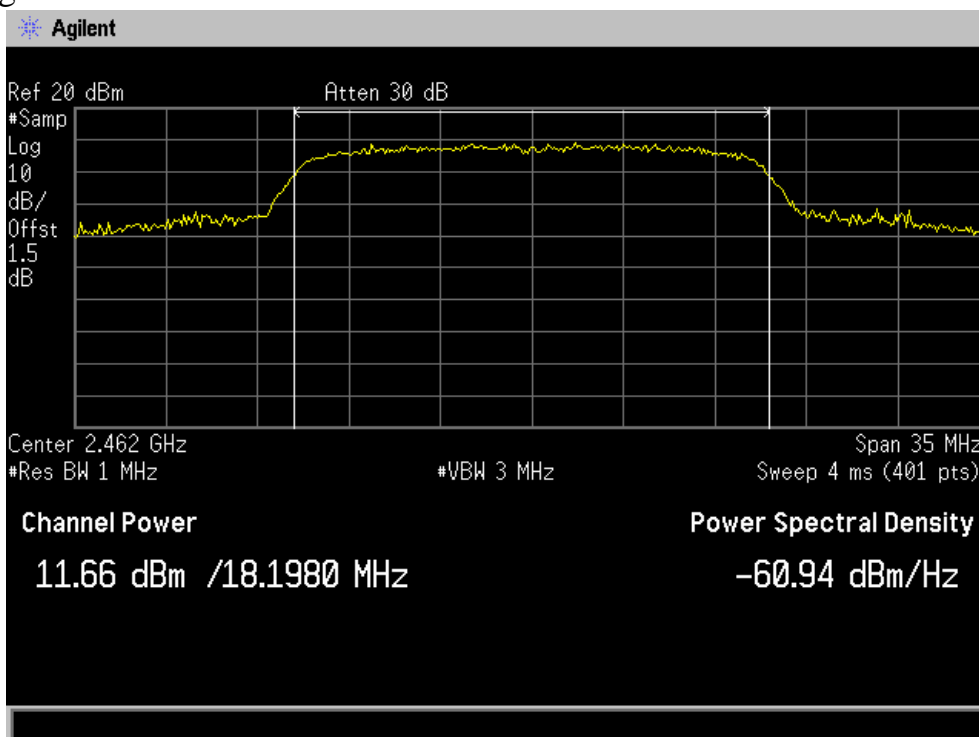

IEEE 802.11g: CH Low :

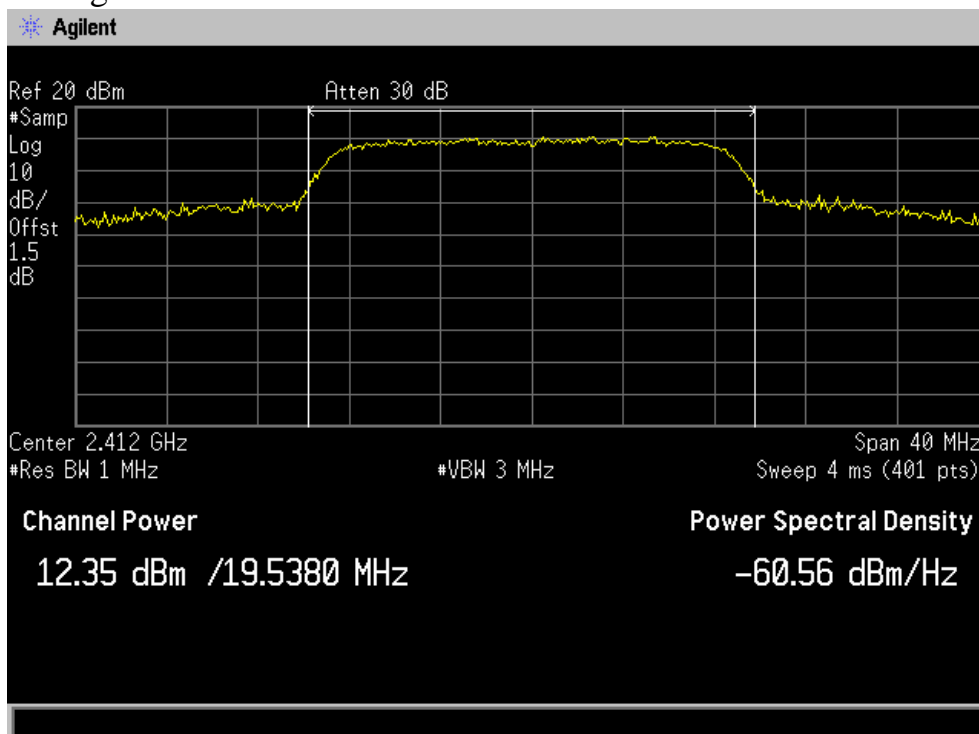

CH Mid :

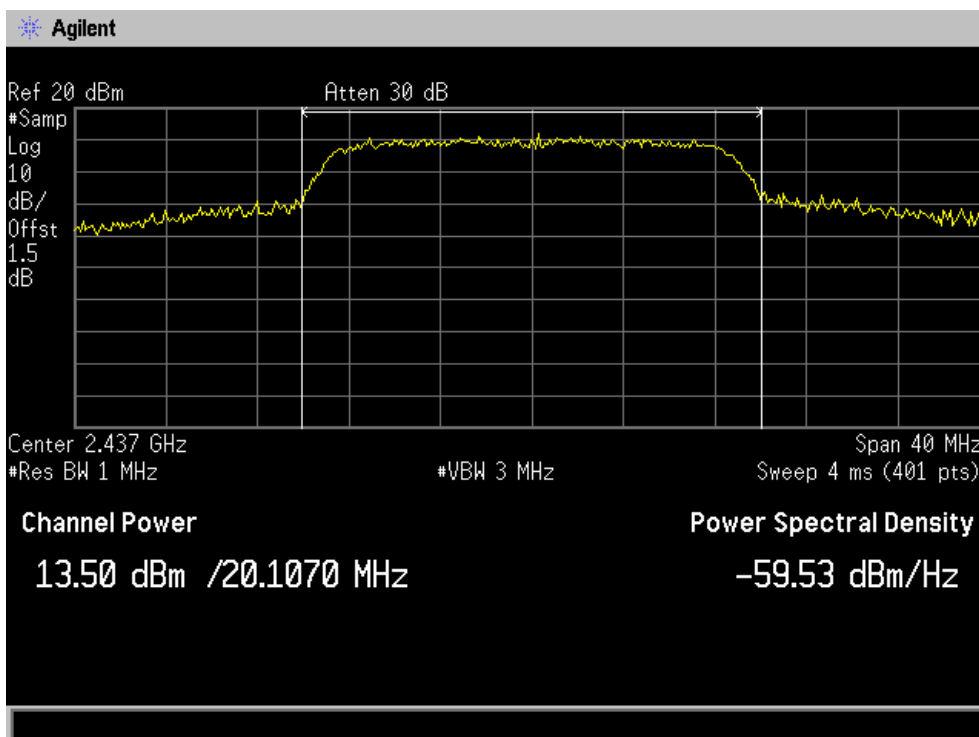

CH High :

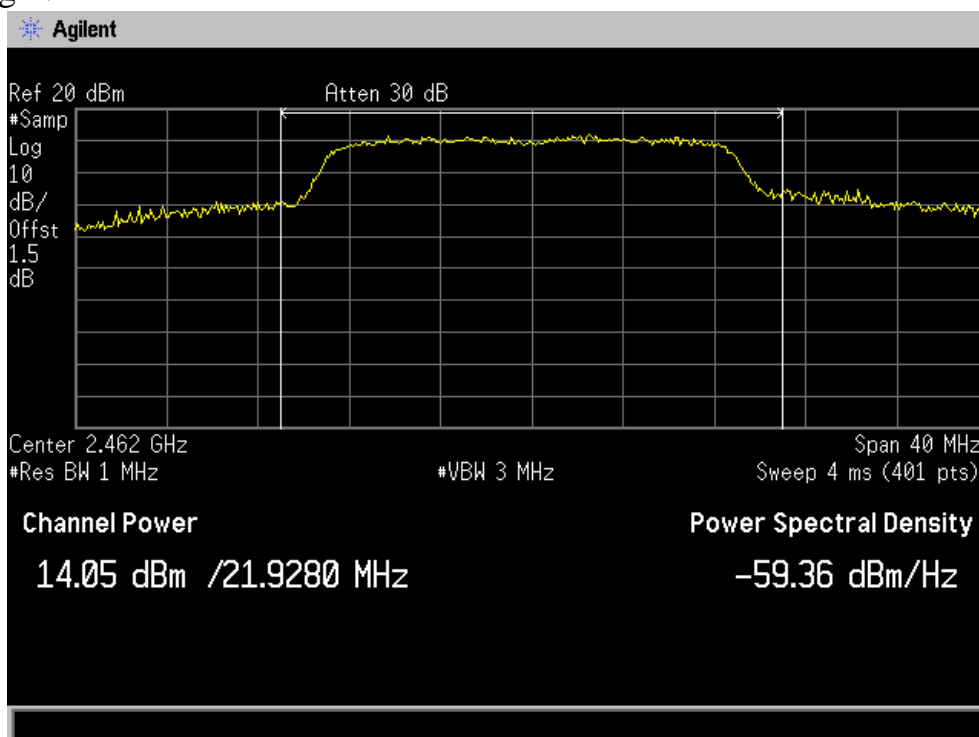

IEEE 802.11n/HT20: CH Low :

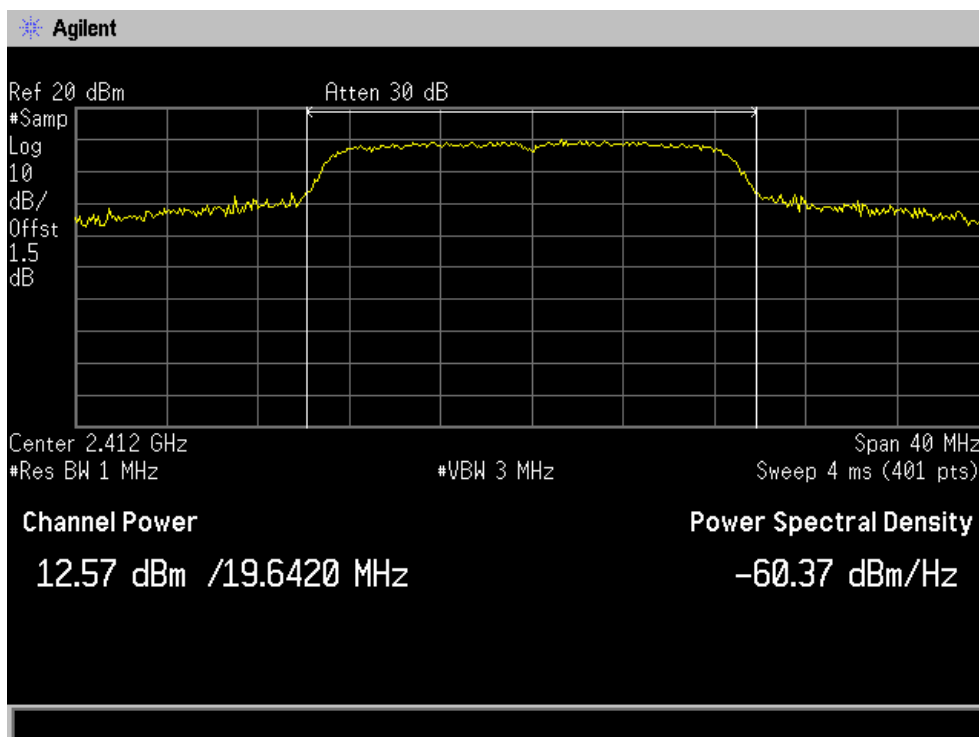

CH Mid :

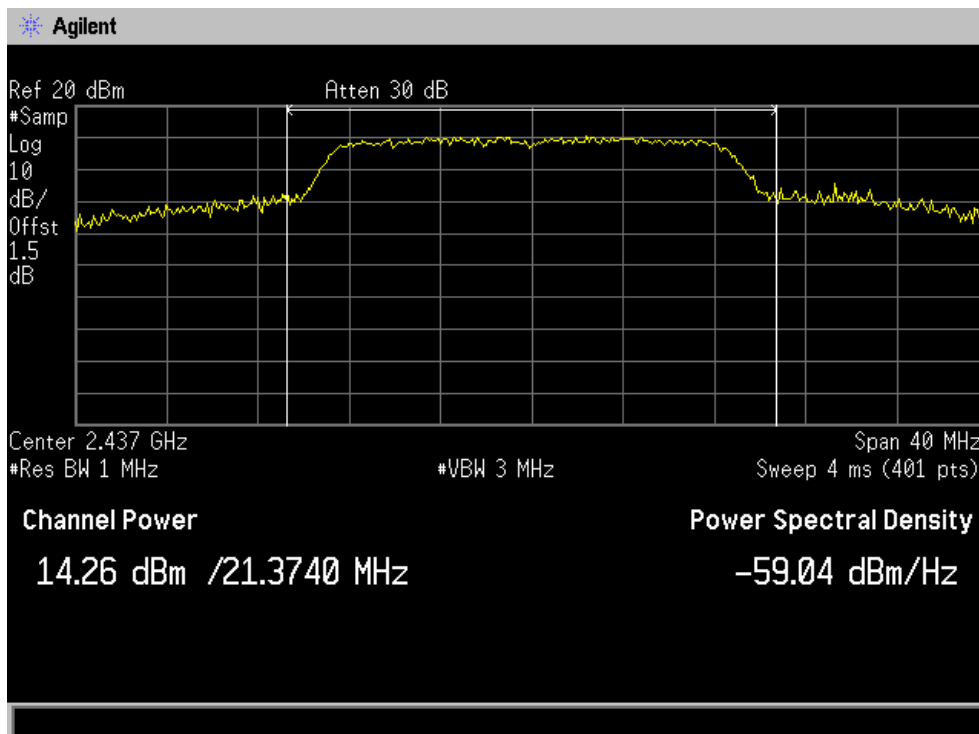

CH High :

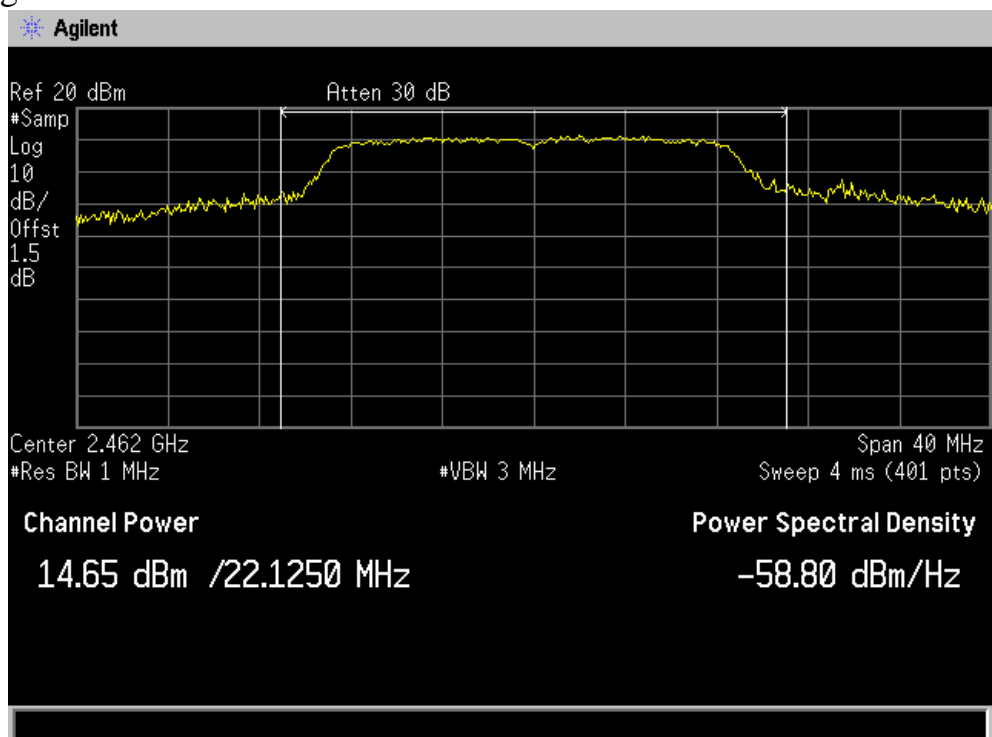

IEEE 802.11n/HT40: CH Low :

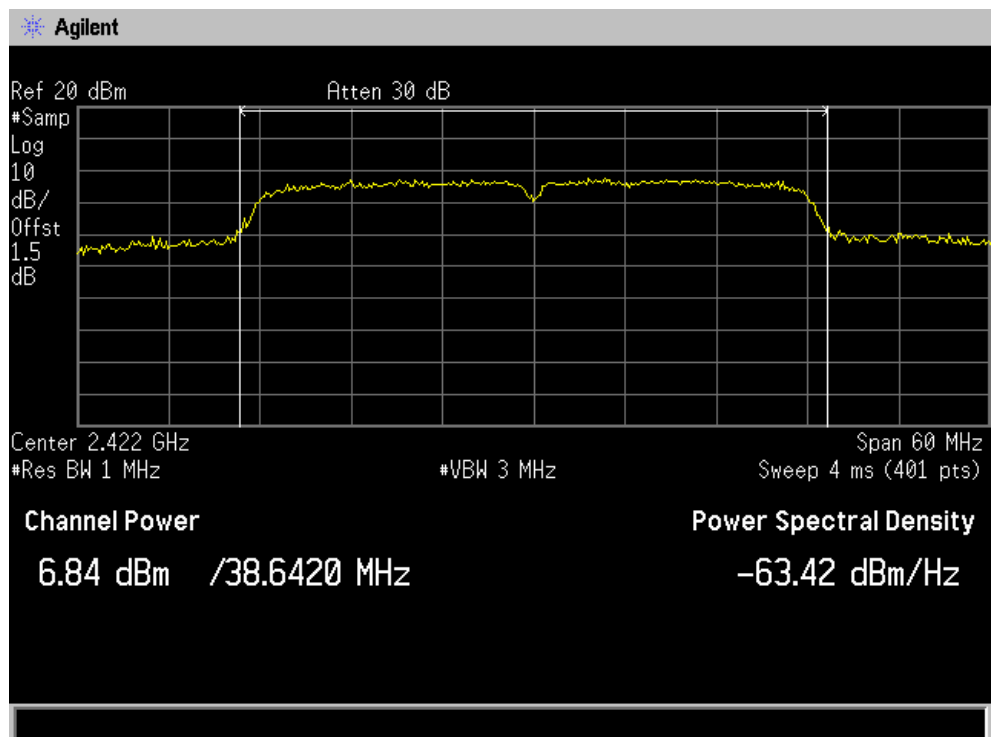

CH Mid :

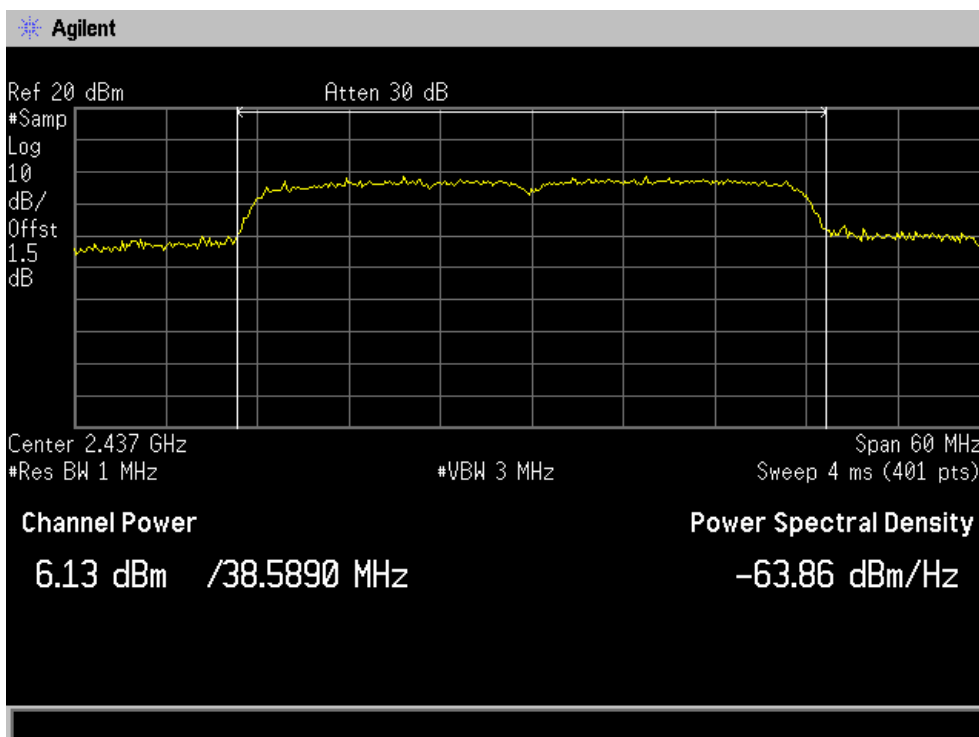

CH High :

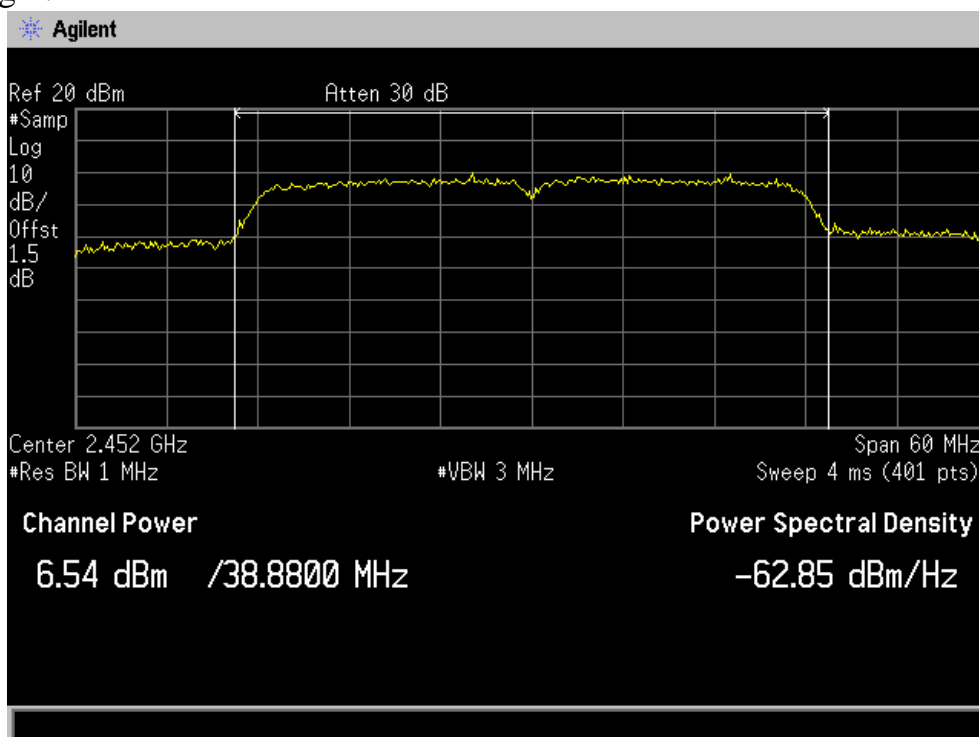

8 PEAK POWER SPECTRAL DENSITY

8.1 Test limit

8.1.1 Please refer section 15.247.

8.1.2 For direct sequence systems, the peak power spectral density conducted from the intentional radiator to the antenna shall not be greater than 8dBm in any 3kHz band during any time interval of continuous transmission.

8.1.3 The direct sequence operating of the hybrid system, with the frequency hopping operation turned off, shall comply with the power density requirements of paragraph (d) of this section.

8.2 Method of measurement

Details see the KDB558074 D01 Meas Guidance

8.2.1 Place the EUT on the table and set it in transmitting mode.

8.2.2 Remove the antenna from the EUT and then connect a low loss RF cable from the antenna port to the spectrum analyzer.

8.2.3 Set the spectrum analyzer as RBW = 3kHz, VBW = 10kHz, span=5-30%EBW, detail see the test plot.

8.2.4 Record the max reading.

8.2.5 Repeat the above procedure until the measurements for all frequencies are completed.

8.3 Test Setup

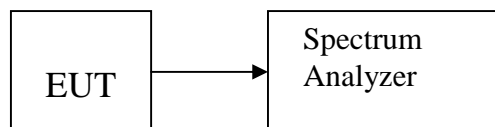

8.4 Test Results

PASS.

Detailed information please see the following page.

Channel	Frequency (MHz)	Power Spectral Density (dBm)	BCWF (dBm)	Final Power Spectral Density (dBm)	Limit (dBm)	Result
IEEE 802.11b:						
Mid	2412	-14.39	-15.2	-29.59	8	PASS
High	2437	-12.49	-15.2	-27.69	8	PASS
Low	2462	-11.15	-15.2	-26.35	8	PASS
IEEE 802.11g:						
Low	2412	-14.96	-15.2	-30.16	8	PASS
Mid	2437	-14.18	-15.2	-29.38	8	PASS
High	2462	-14.10	-15.2	-29.30	8	PASS
IEEE 802.11n/HT20:						
Low	2412	-16.60	-15.2	-31.80	8	PASS
Mid	2437	-14.18	-15.2	-29.38	8	PASS
High	2462	-15.41	-15.2	-30.61	8	PASS
IEEE 802.11n/HT40:						
Low	2422	-17.22	-15.2	-32.42	8	PASS
Mid	2437	-16.15	-15.2	-31.35	8	PASS
High	2452	-16.83	-15.2	-32.03	8	PASS
Note: $BCWF = 10\log(3 \text{ kHz}/100 \text{ kHz}) = -15.2 \text{ dB}$.						

IEEE 802.11b:

CH Low :

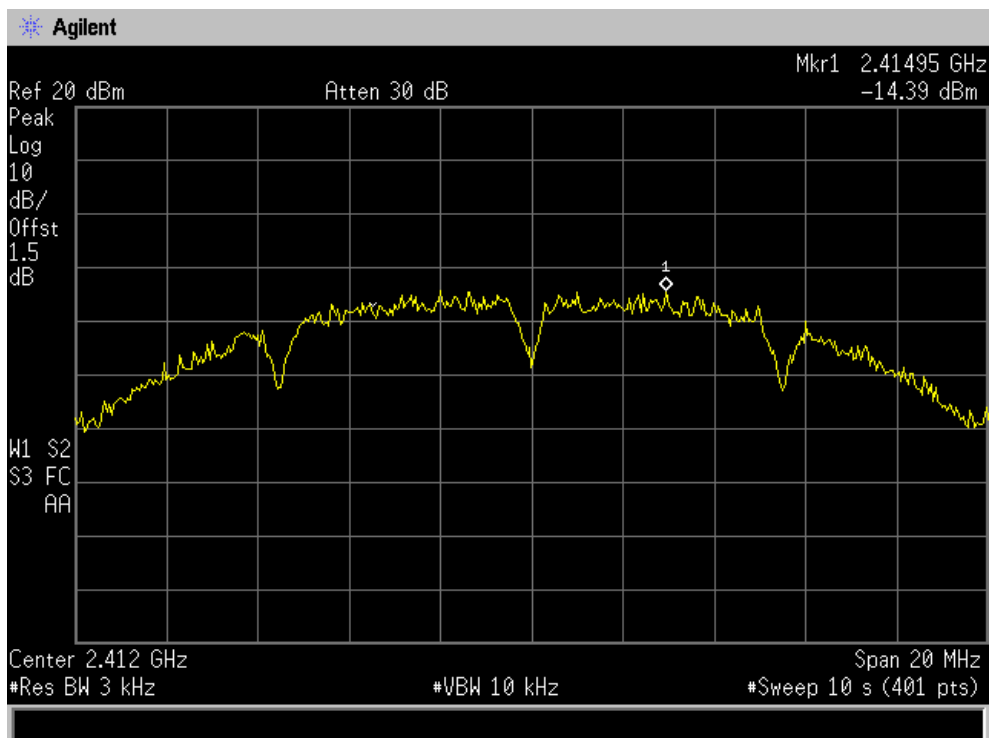

CH Mid :

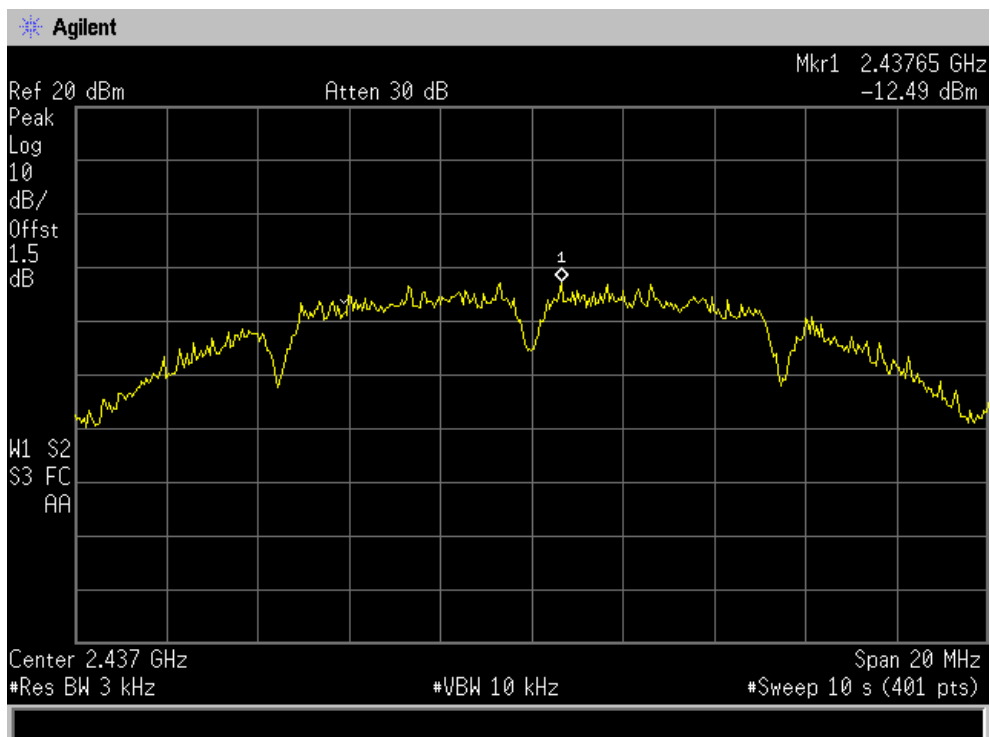

CH High :

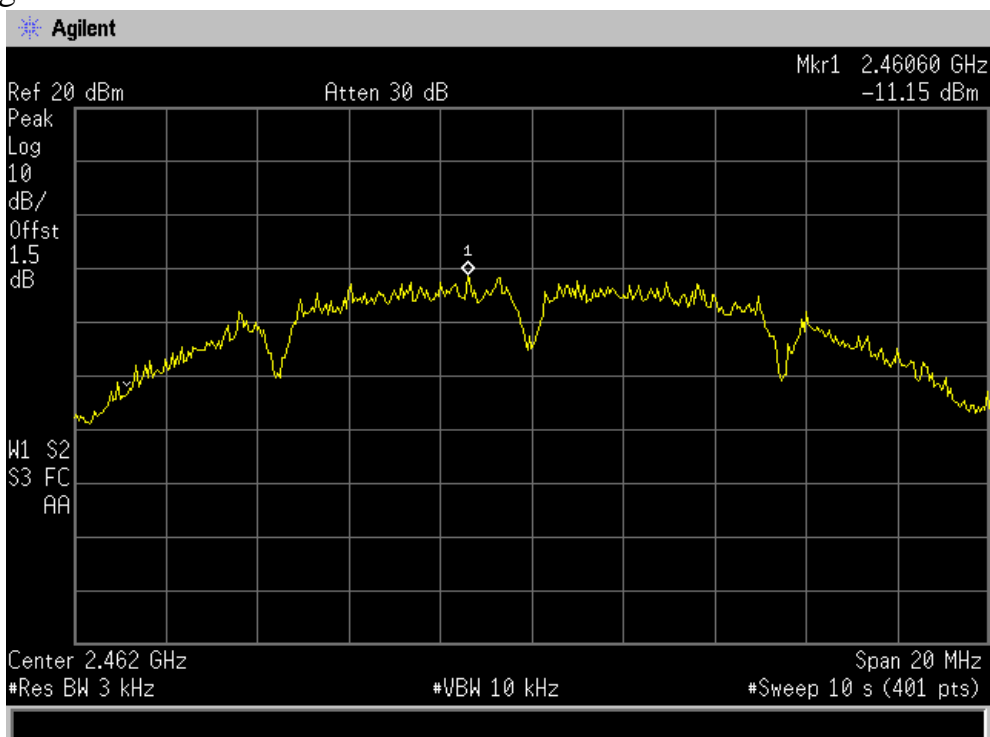

IEEE 802.11g:

CH Low :

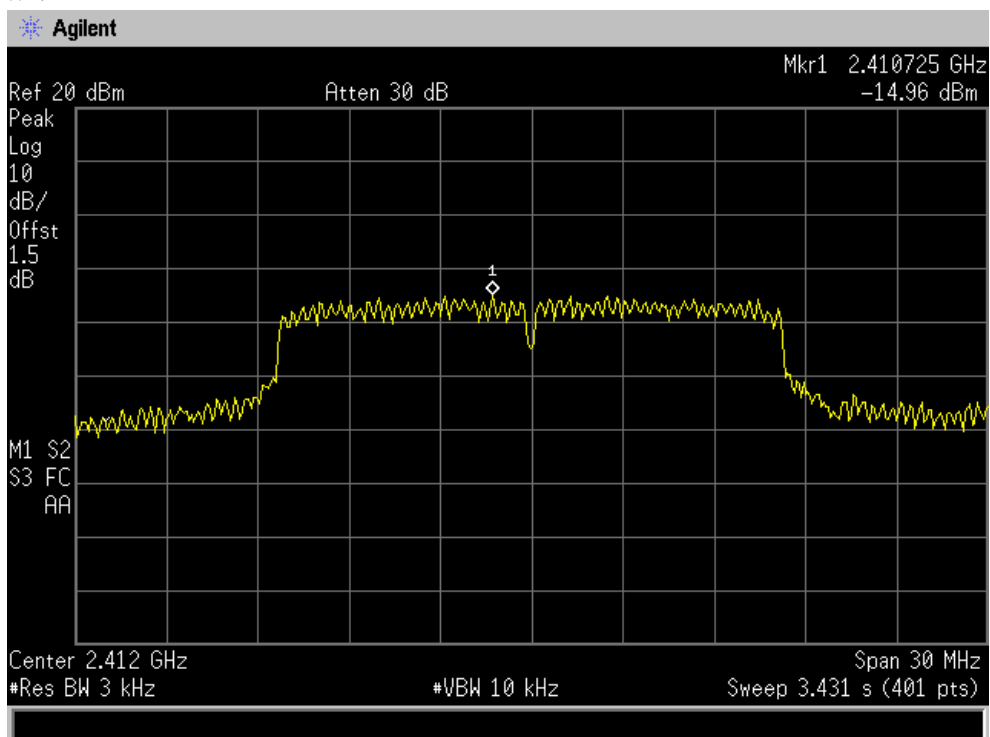

CH Mid :

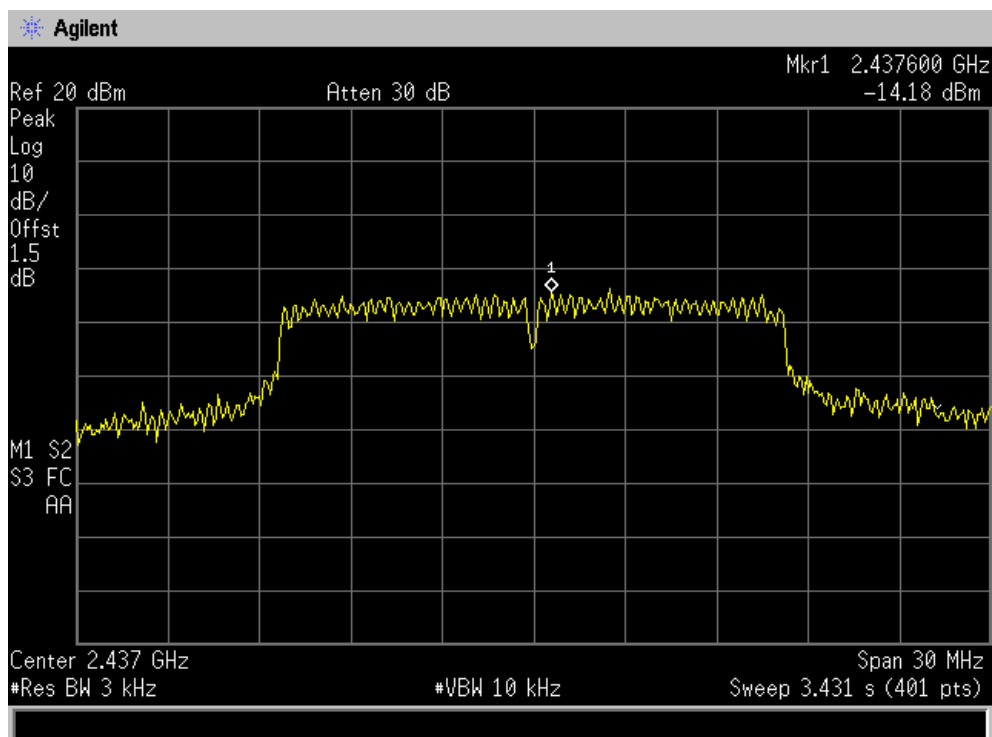

CH High :

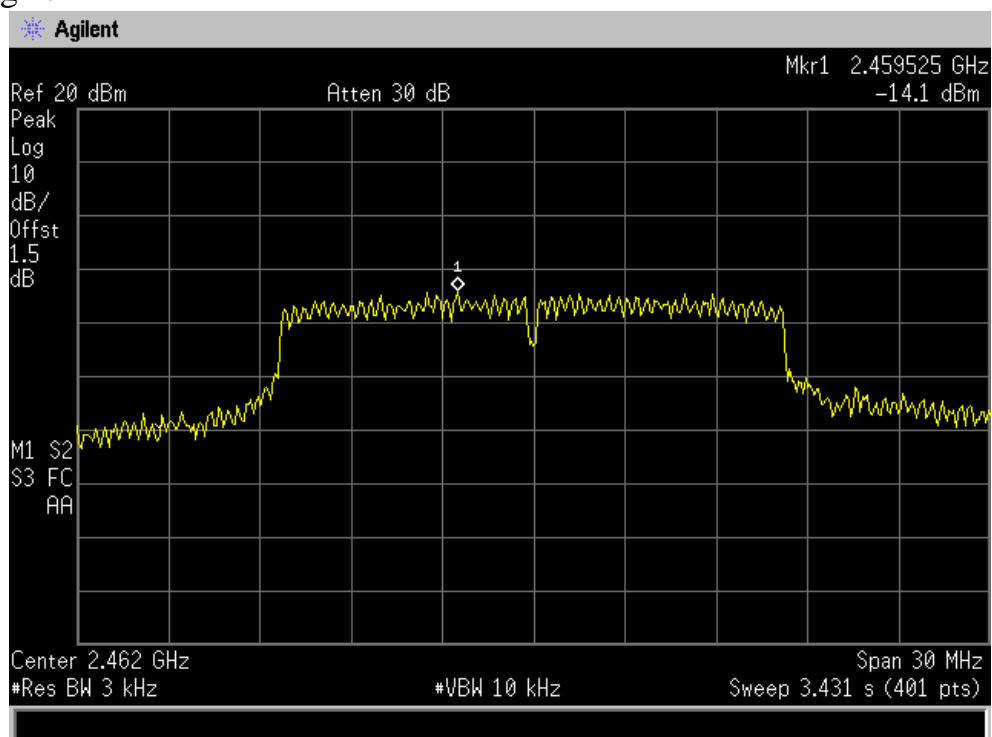

IEEE 802.11n/HT20:

CH Low :

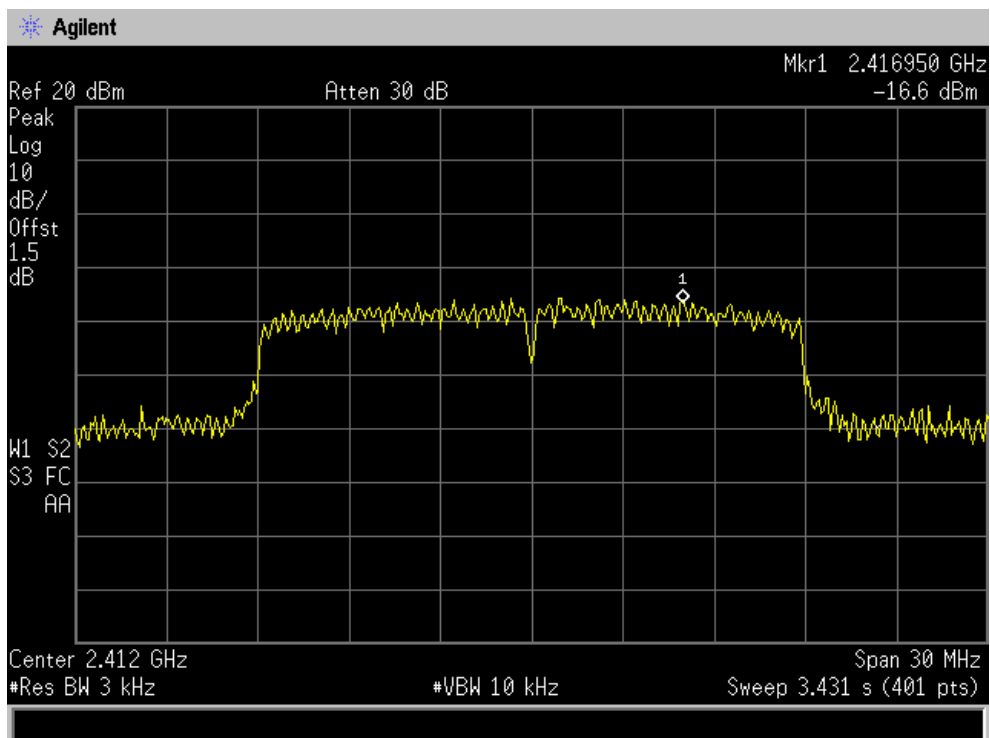

CH Mid :

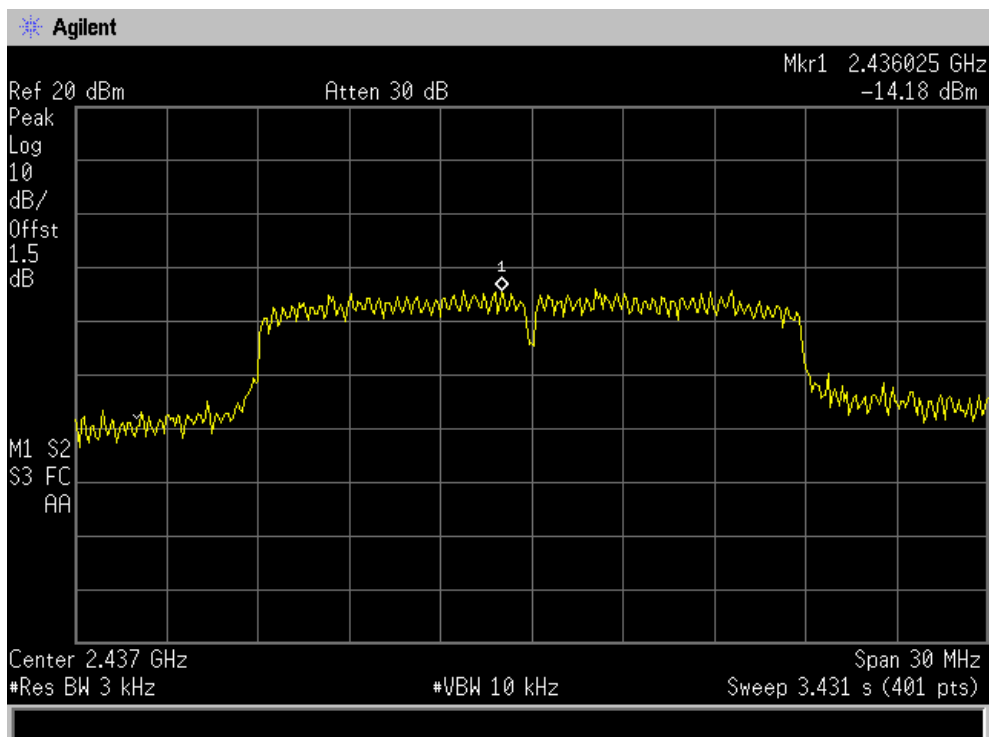

CH High :

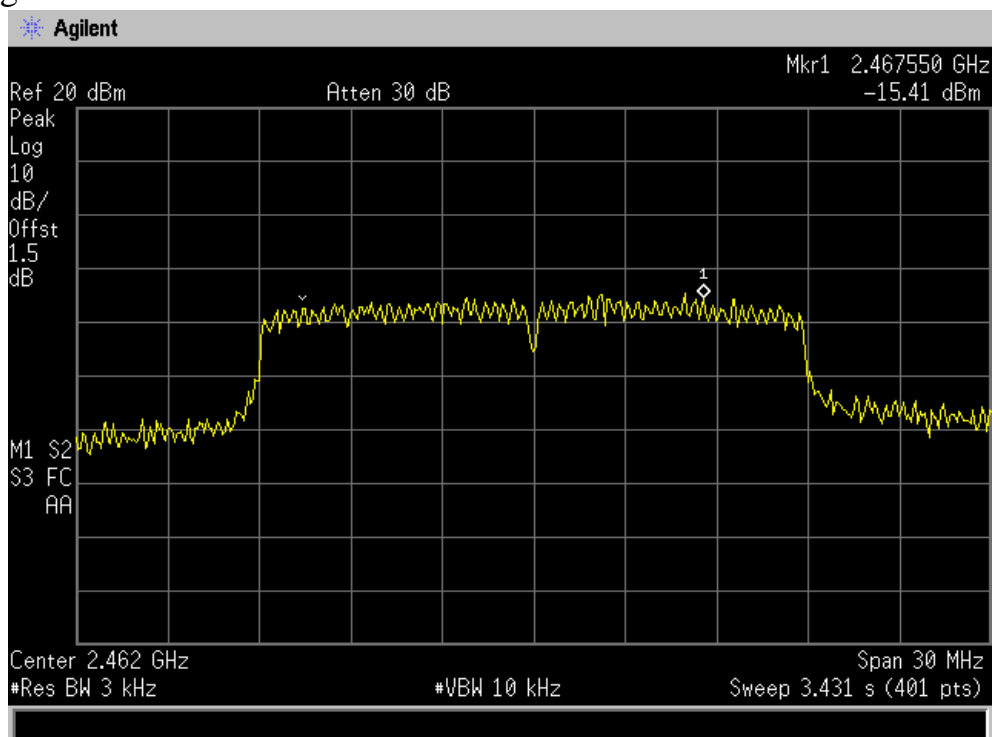

IEEE 802.11n/HT40:

CH Low :

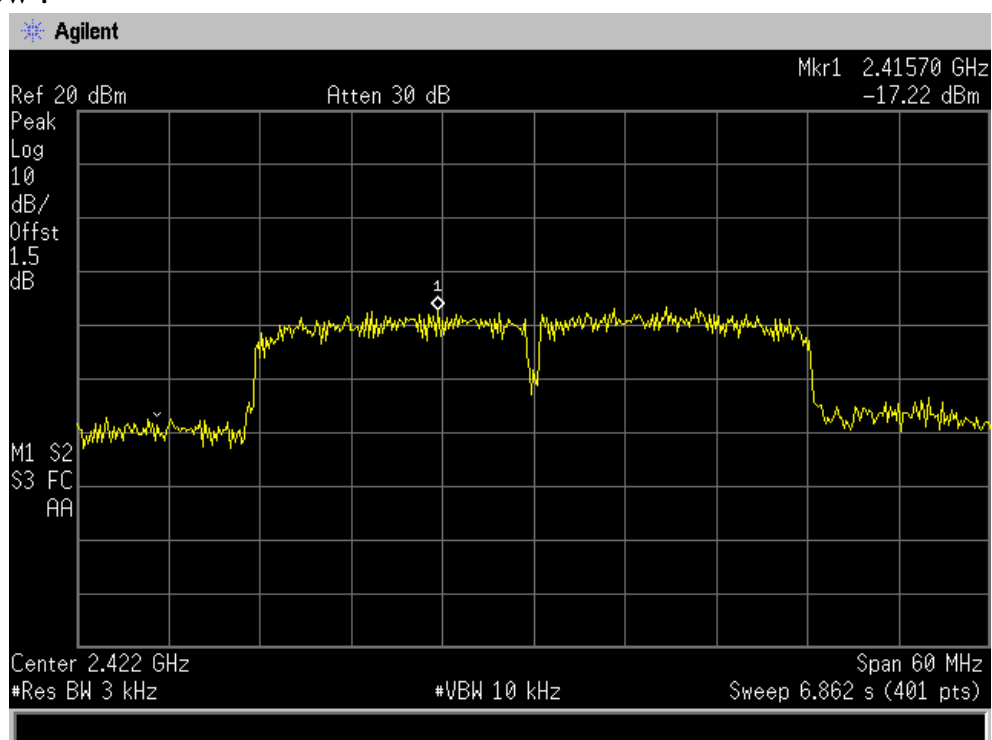

CH Mid :

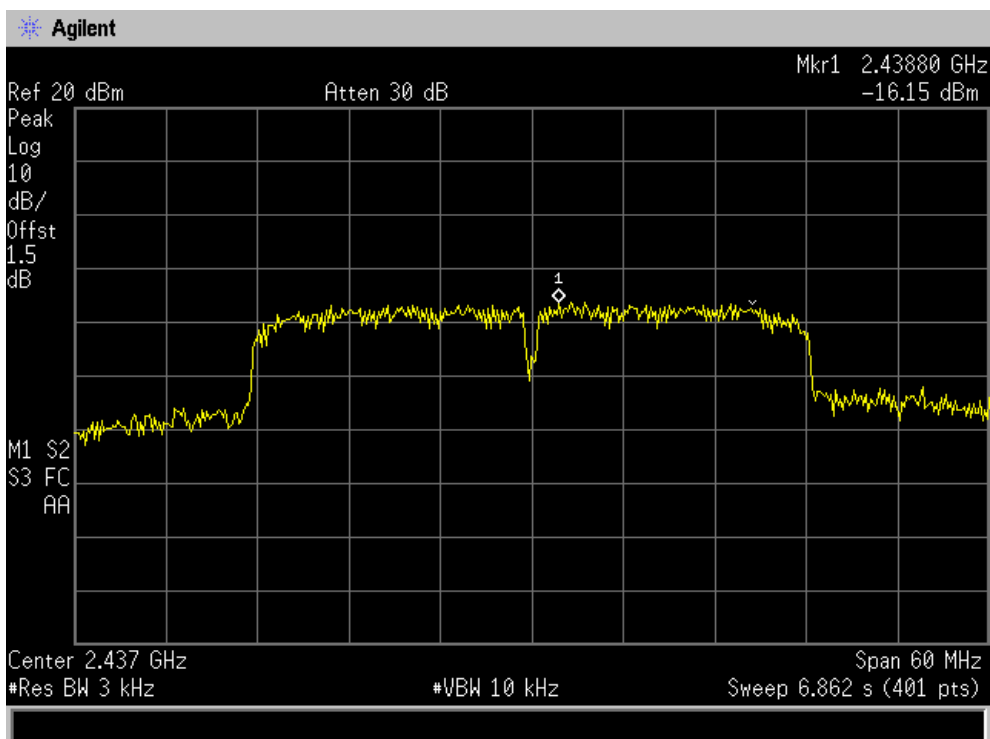

CH High :

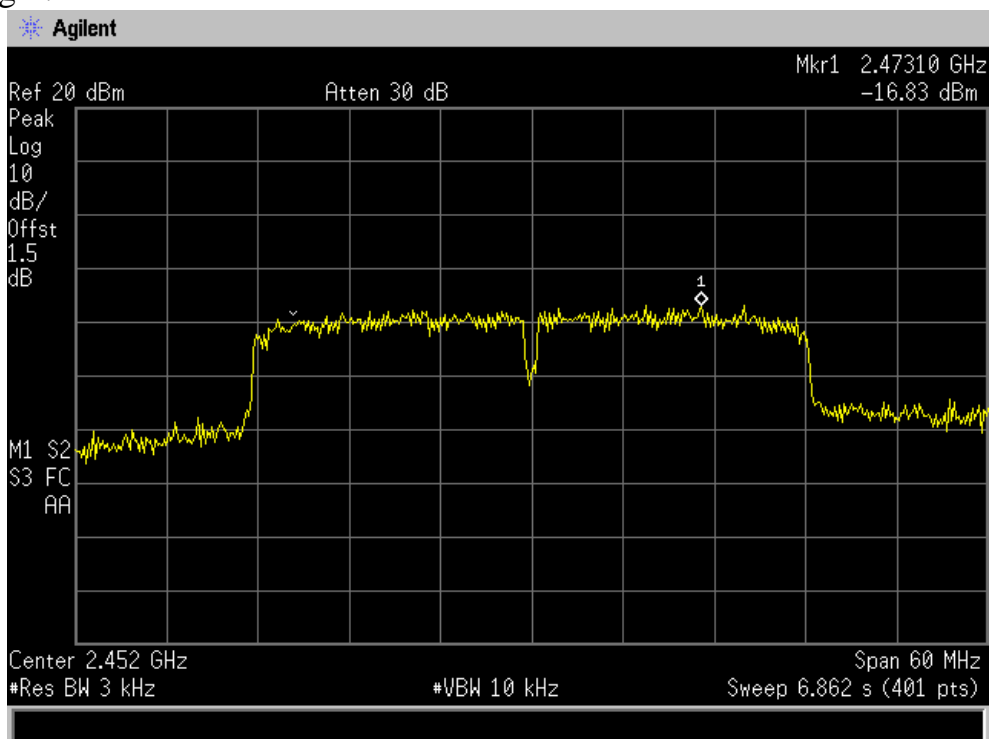

9 6dB Bandwidth

9.1 Test limit

Please refer section 15.247

For direct sequence systems, the minimum 6dB bandwidth shall be at least 500kHz.

9.2 Method of measurement

Details see the KDB558074 D01 Meas Guidance

- a) The test receiver set RBW = 100kHz, VBW \geq 3RBW, Detector = Peak, Trace mode = max hold, Sweep = auto couple, Allow the trace to stabilize, Measure the maximum width of the emission that is constrained by the frequencies associated with the two outermost amplitude points (upper and lower) that are attenuated by 6 dB relative to the maximum level measured in the fundamental emission.
- b) The automatic bandwidth measurement capability of a spectrum analyzer may be employed using the X dB bandwidth mode with X set to 6 dB, if it implements the functionality described above. When using this capability, care should be taken to ensure that the bandwidth measurement is not influenced by any intermediate power nulls in the fundamental emission that may be \geq 6 dB. detail see the test plot.

9.3 Test Setup

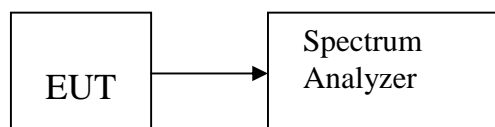

9.4 Test Results

PASS.

Detailed information please see the following page.

Channel	Frequency (MHz)	6dB Bandwidth (MHz)	Limit (MHz)	Result
IEEE 802.11b:				
Mid	2412	10.133	0.5	PASS
High	2437	10.213	0.5	PASS
Low	2462	10.129	0.5	PASS
IEEE 802.11g:				
Low	2412	15.923	0.5	PASS
Mid	2437	16.116	0.5	PASS
High	2462	16.284	0.5	PASS
IEEE 802.11n/HT20:				
Low	2412	15.760	0.5	PASS
Mid	2437	16.353	0.5	PASS
High	2462	16.288	0.5	PASS
IEEE 802.11n/HT40:				
Low	2422	35.202	0.5	PASS
Mid	2437	35.205	0.5	PASS
High	2452	35.196	0.5	PASS

IEEE 802.11b:

CH Low :

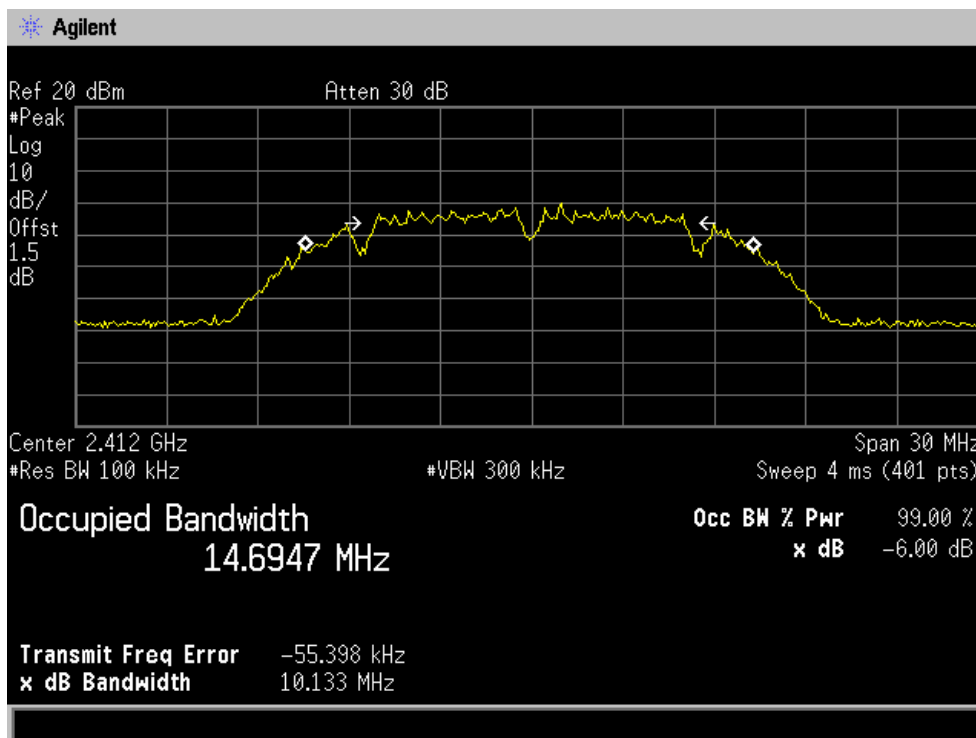

CH Mid :

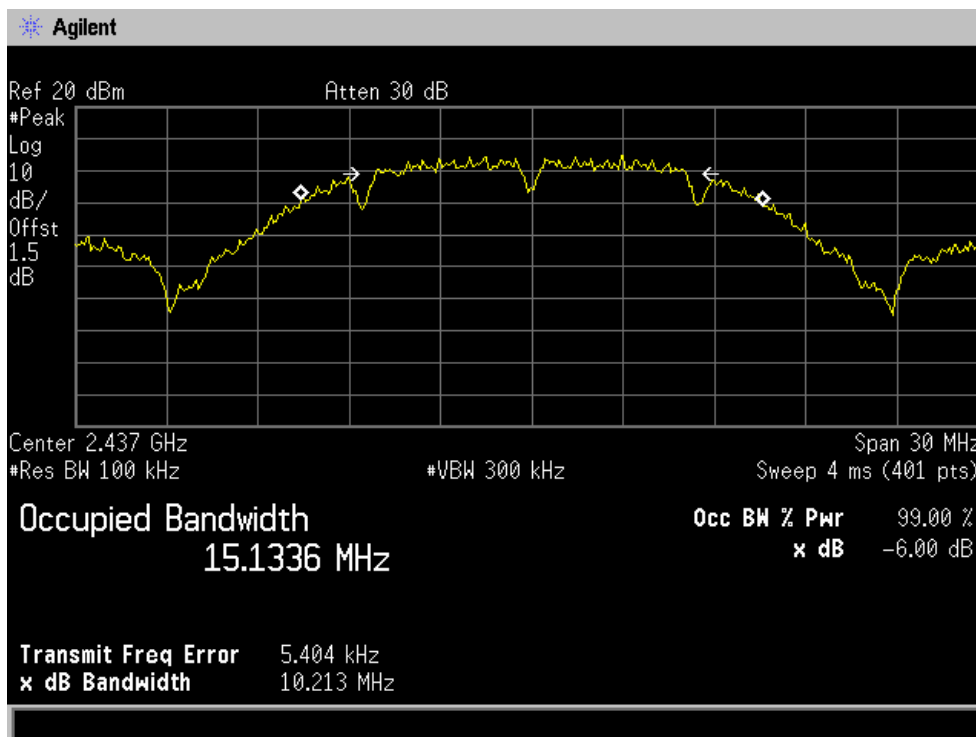

CH High :

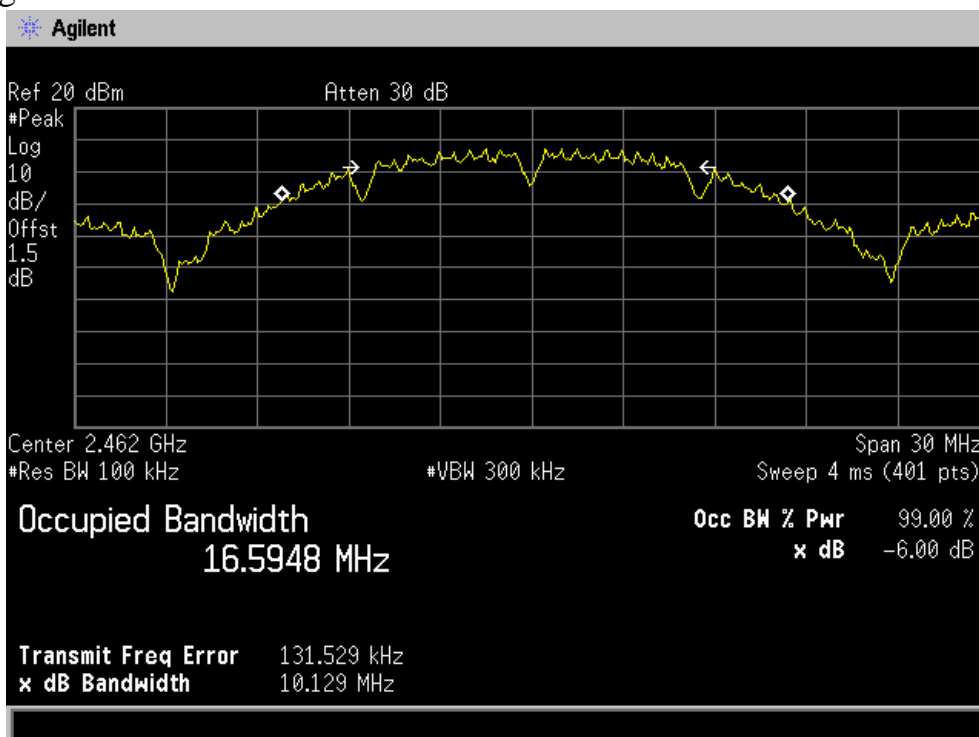

IEEE 802.11g:

CH Low :

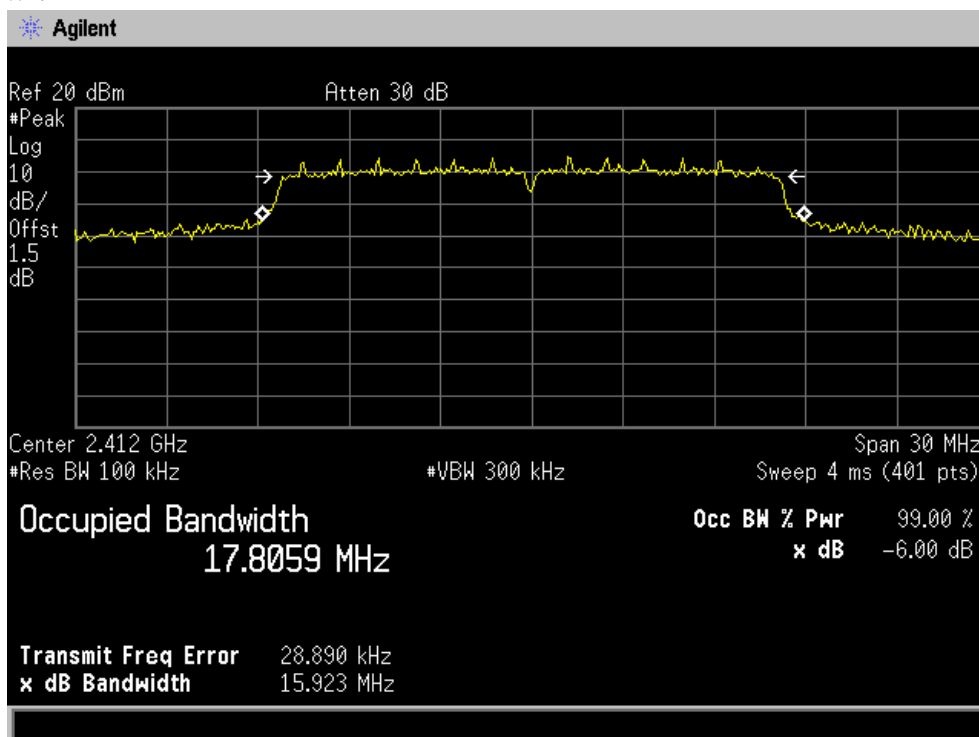

CH Mid :

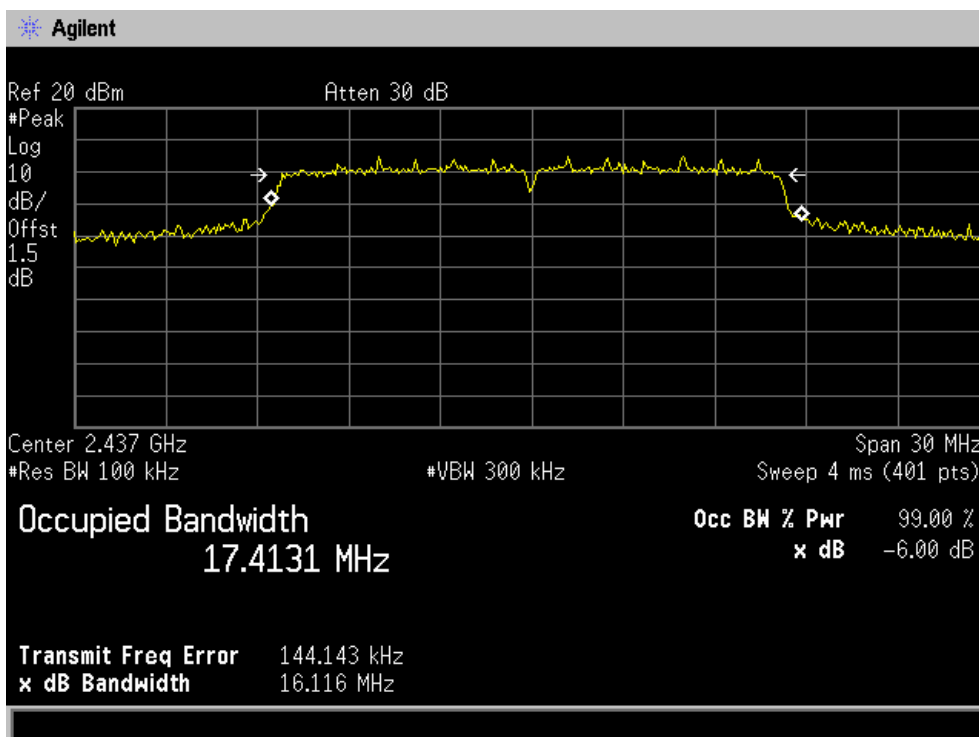

CH High :

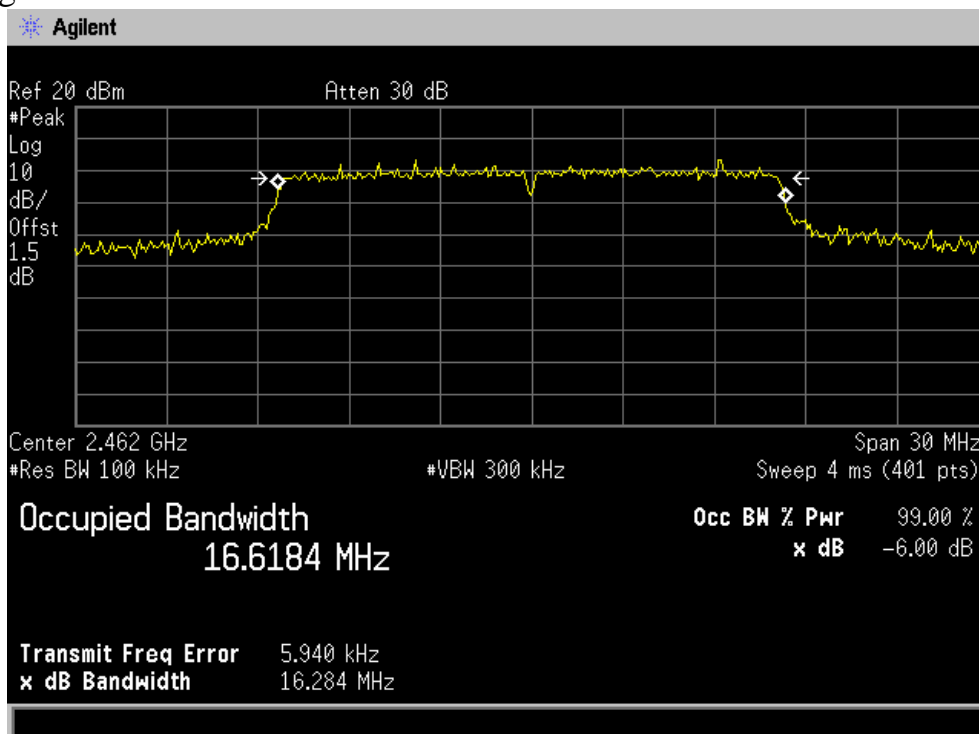

Report No.: STE121108551

IEEE 802.11n/HT20:

CH Low :

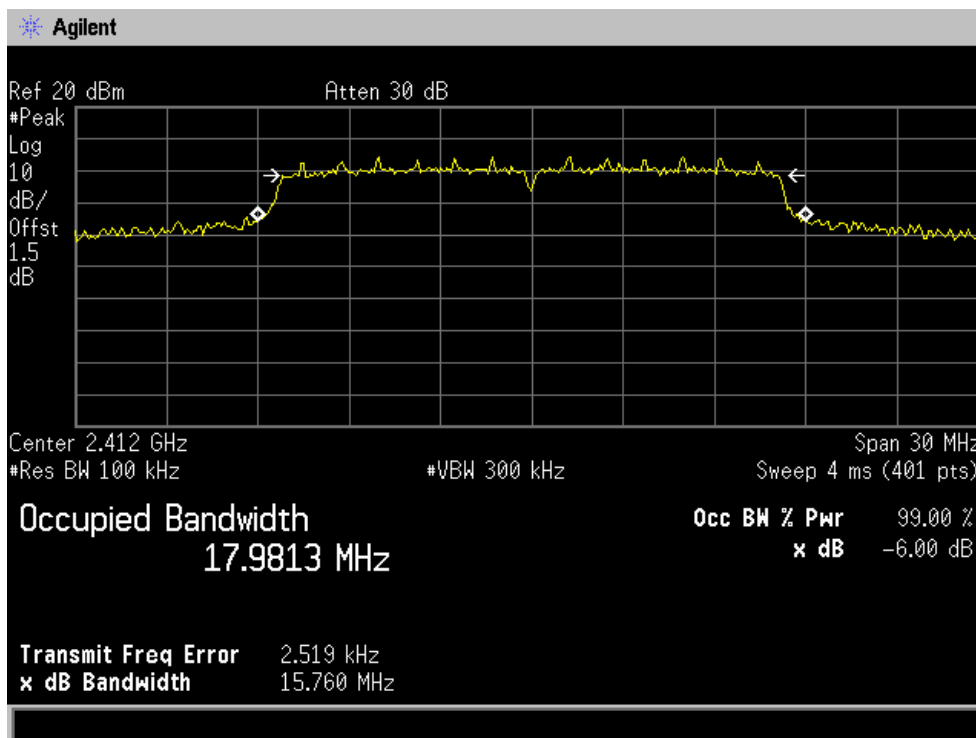

CH Mid :

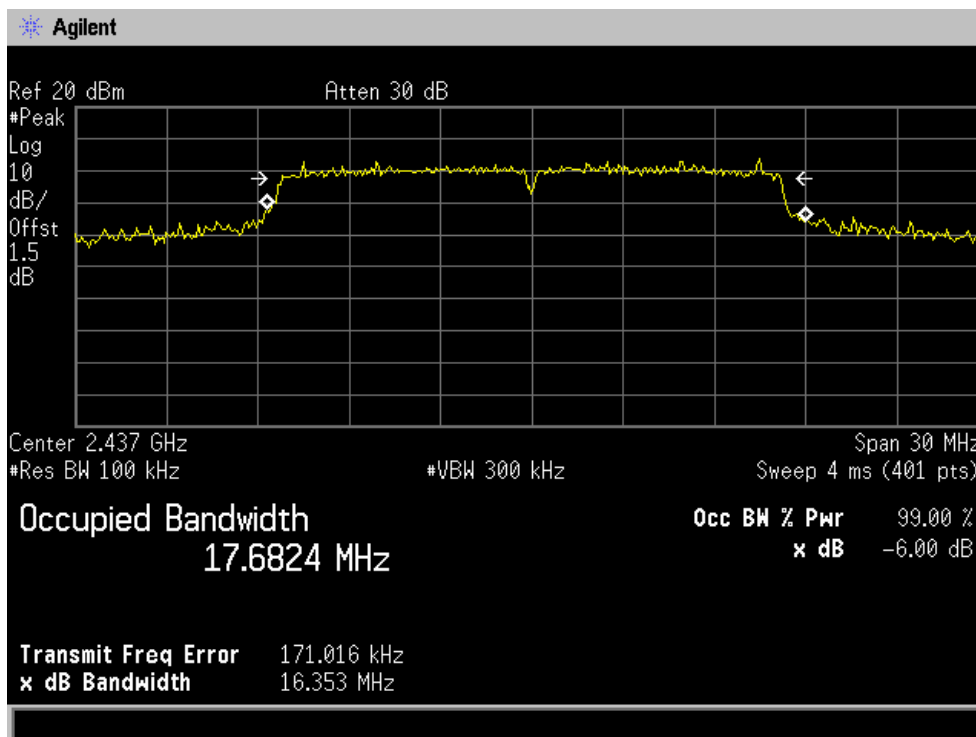

CH High :

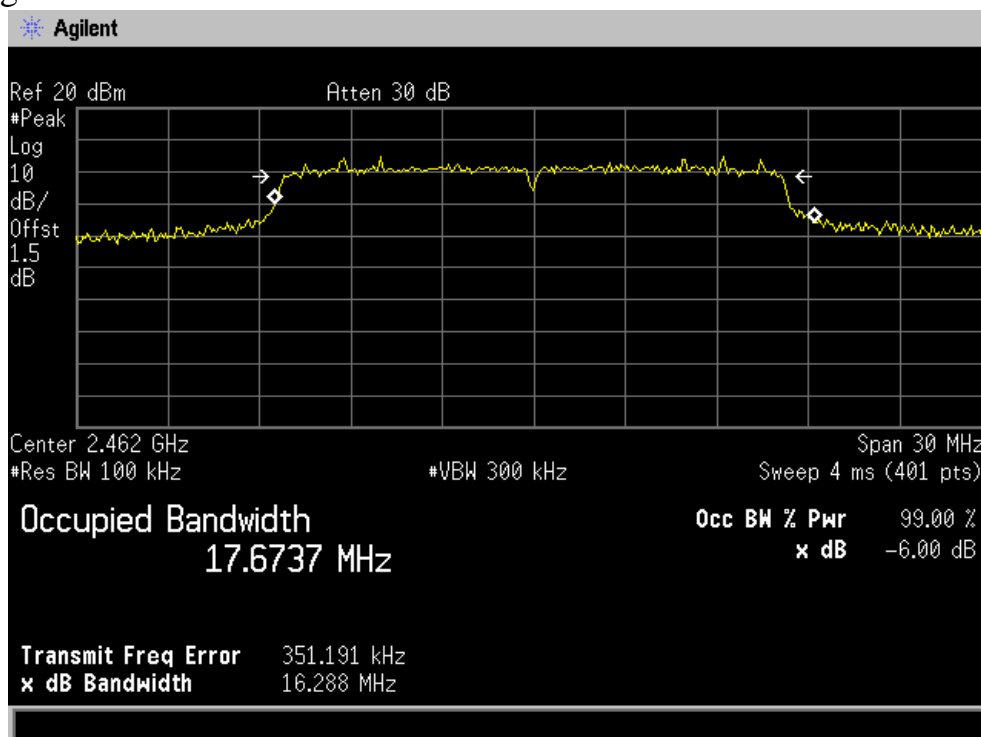

IEEE 802.11n/HT40:

CH Low :

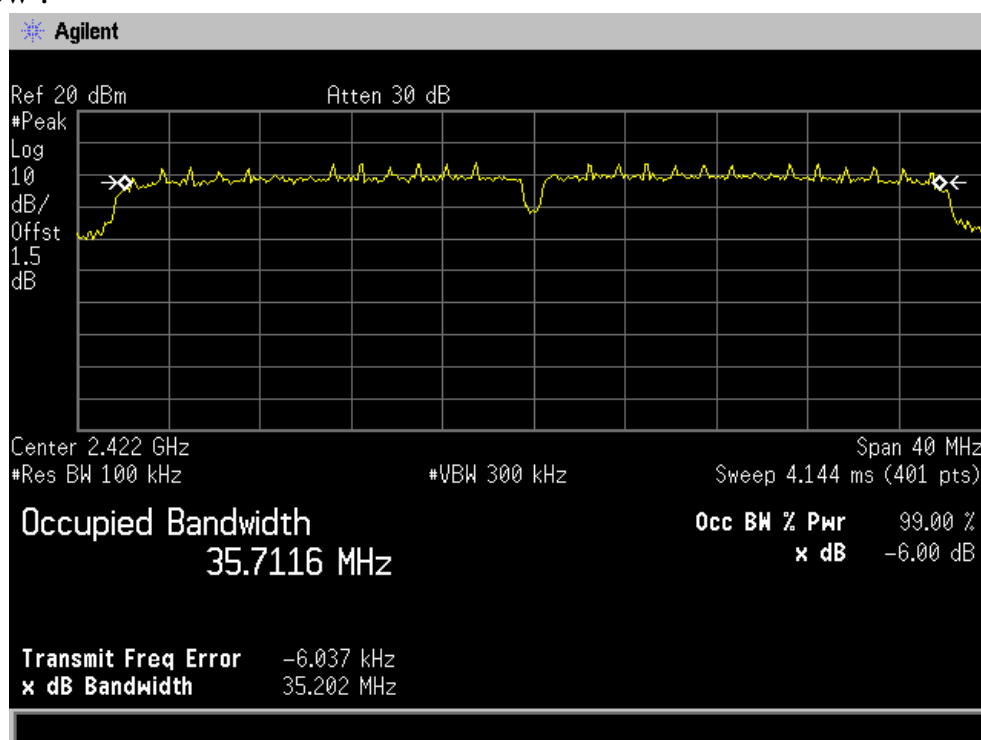

CH Mid :

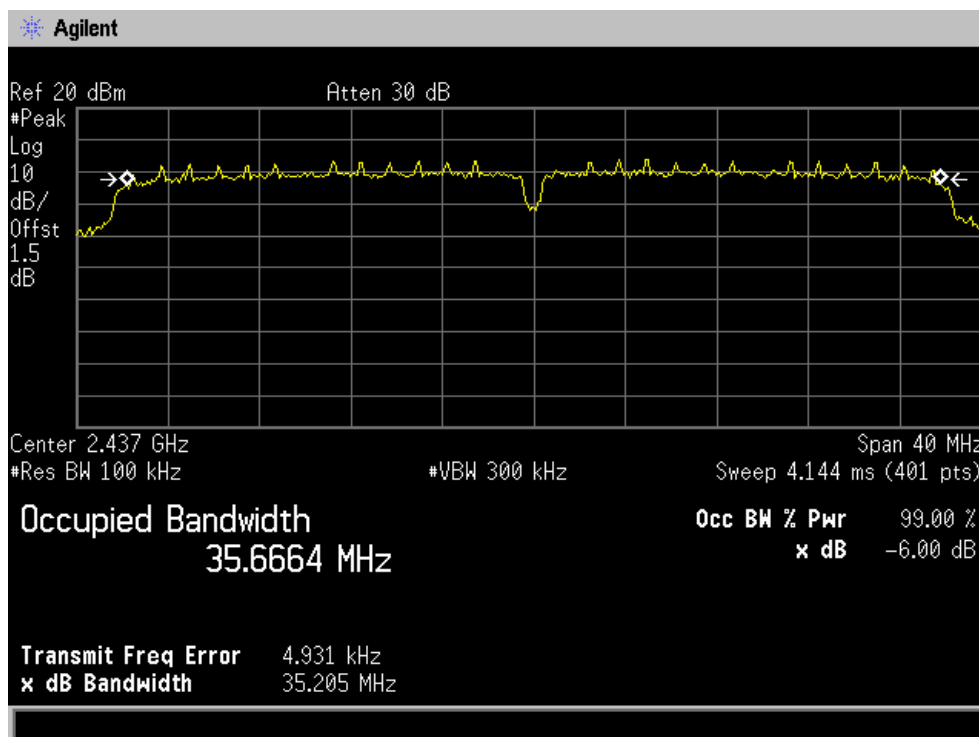

CH High :

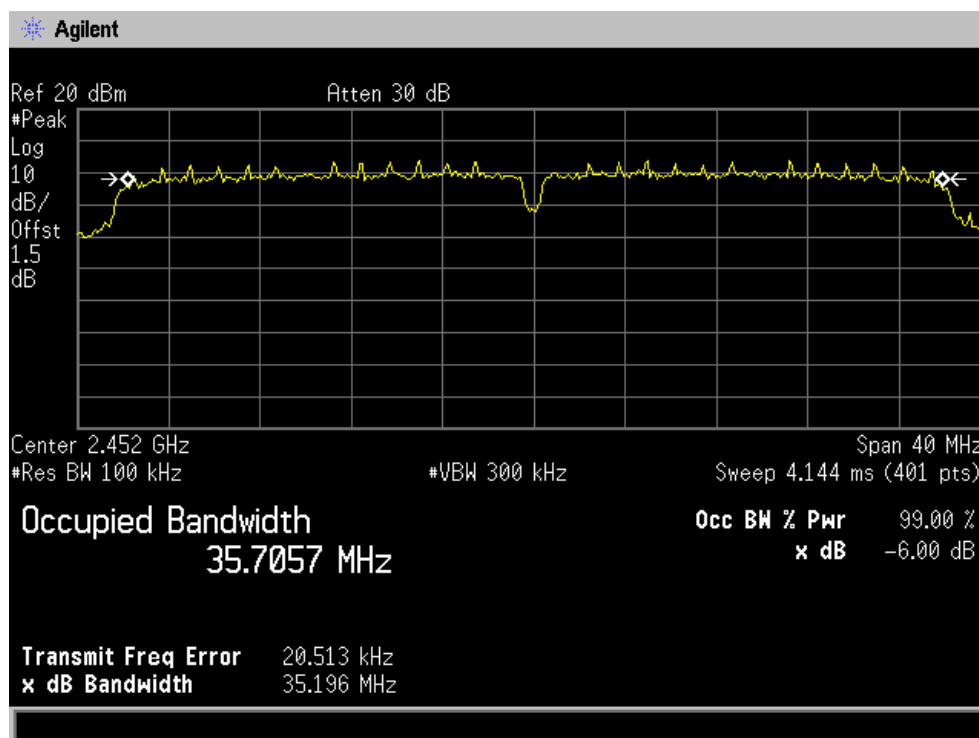

10 Band Edge Check

10.1 Test limit

Please refer section 15.247

All the lower and upper band-edges emissions appearing within 2310MHz to 2390MHz and 2483.5MHz to 2500MHz restricted frequency bands shall not exceed the limits shown in 15.209, all the other emissions outside operation frequency band 2400MHz to 2483.5MHz shall be at least 20dB below the fundamental emissions, or comply with 15.209 limits.

10.2 Test Procedure

12.2.1 Put the EUT on a 0.8m high table, power on the EUT. Emissions were scanned and measured rotating the EUT to 360 degrees, Find the maximum Emission

12.2.2 Check the spurious emissions out of band.

12.2.3 RBW,VBW Setting, for peak detector: RBW:1MHz, VBW: 1MHz, for peak detector: RBW:1MHz, VBW: 10MHz, please see the following test plot.

10.3 Test Setup

Same as 5.2.2.

10.4 Test Result

PASS.

Detailed information please see the following page.

IEEE 802.11b:

CH LOW :

Detector mode: Peak

Polarity: Horizontal

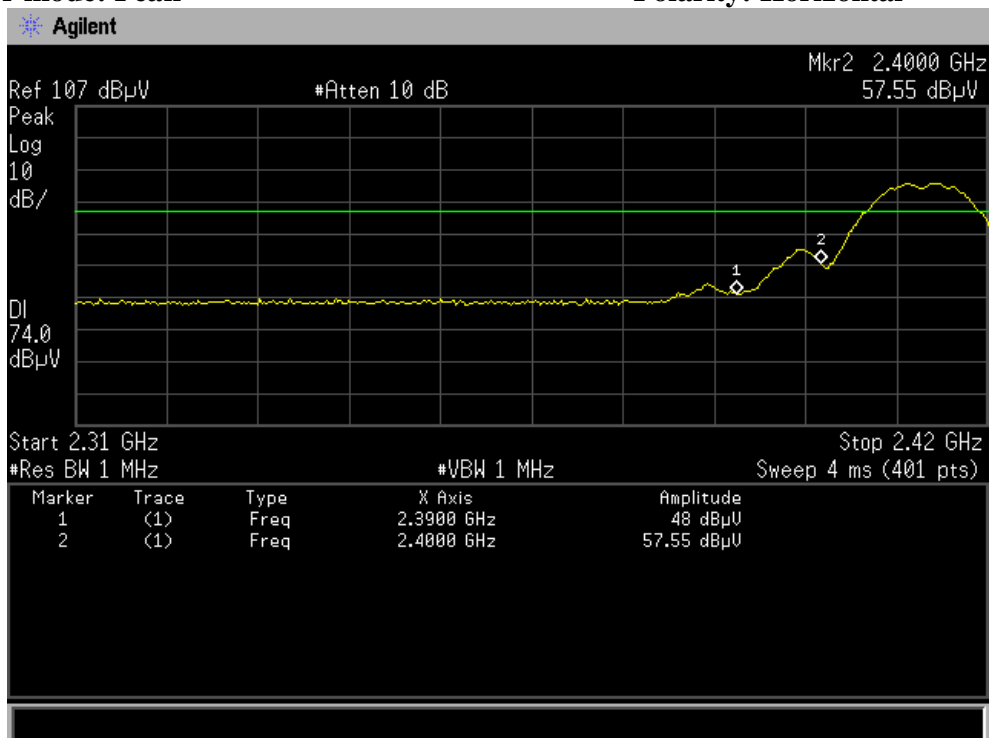

Detector mode: Average

Polarity: Horizontal

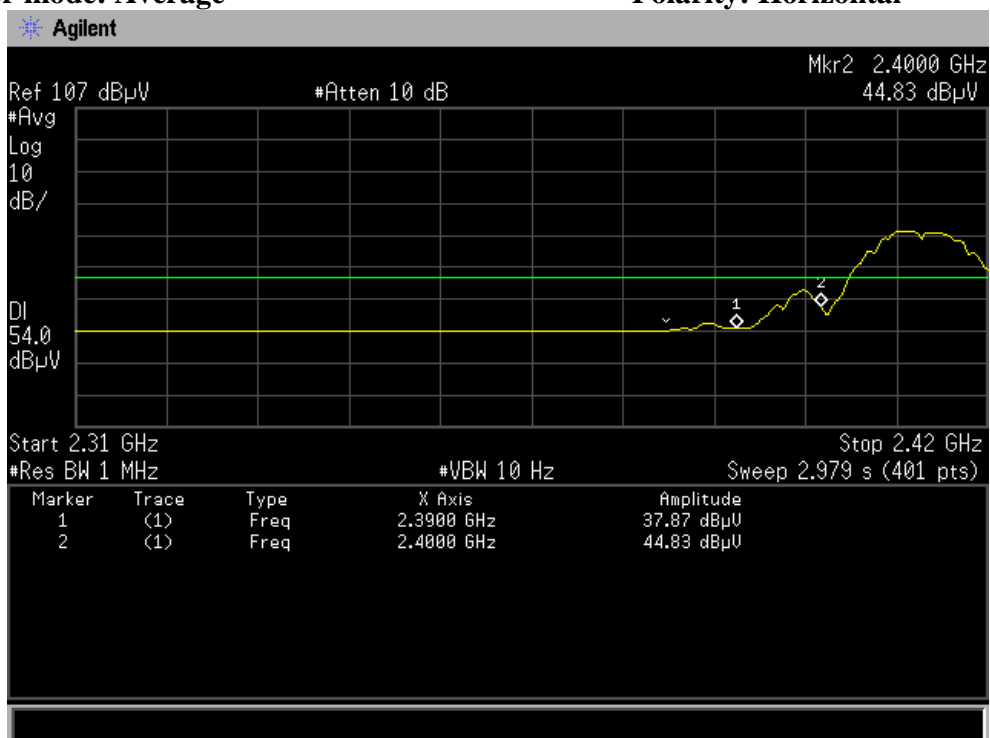

Report No.: STE121108551

CH High :

Detector mode: Peak

Polarity: Horizontal

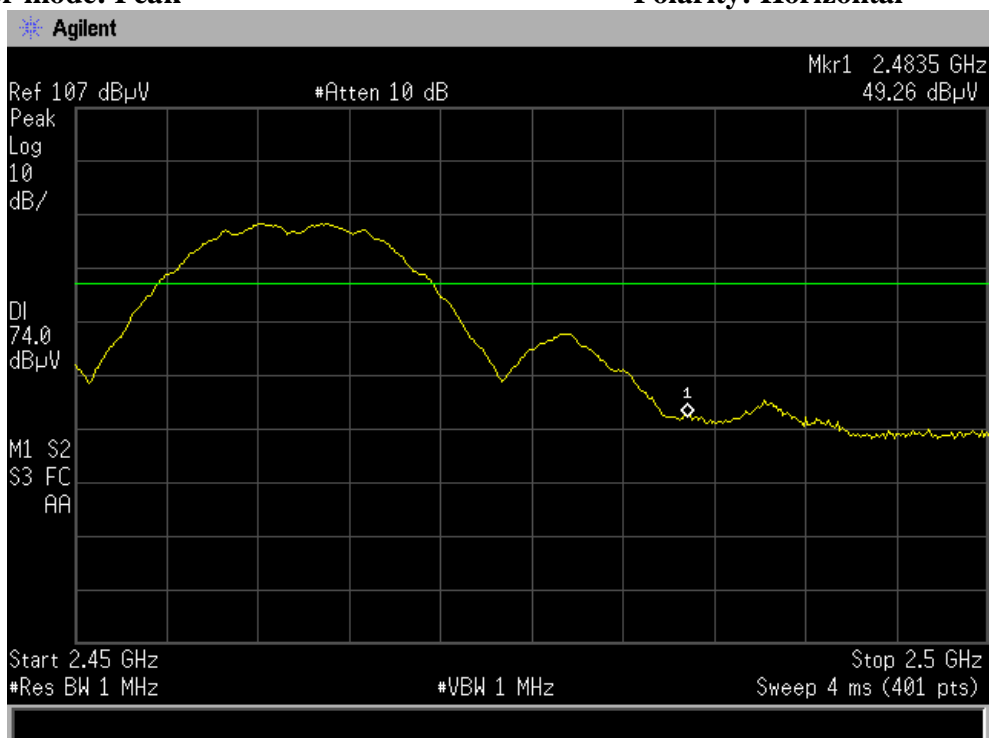

Detector mode: Average

Polarity: Horizontal

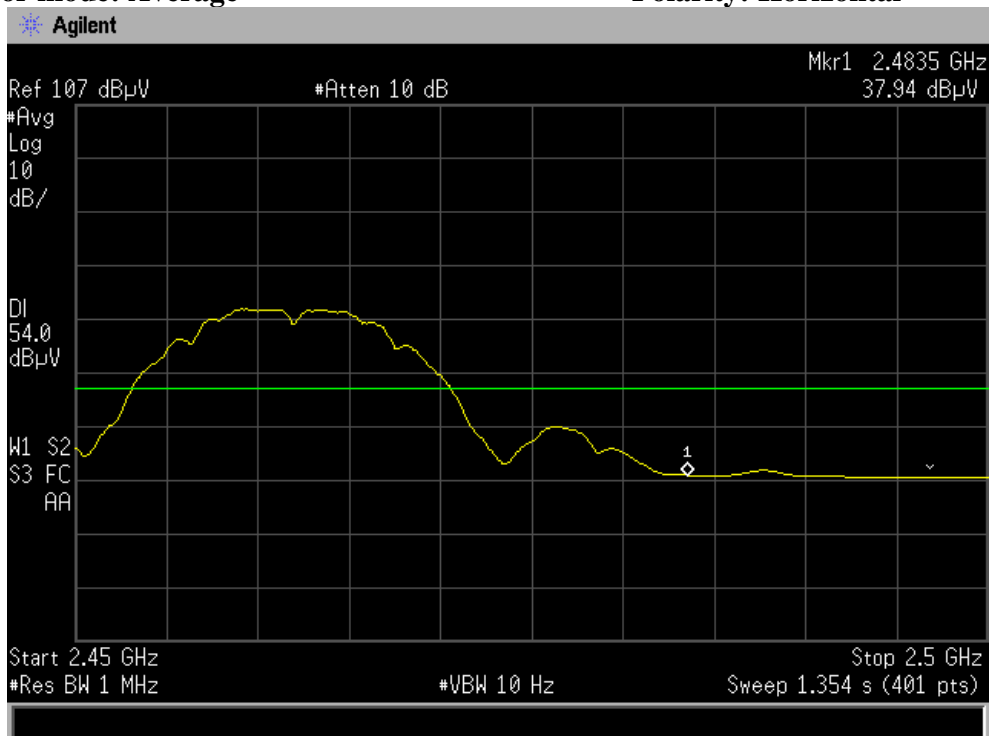

CH LOW :

Detector mode: Peak

Polarity: Vertical

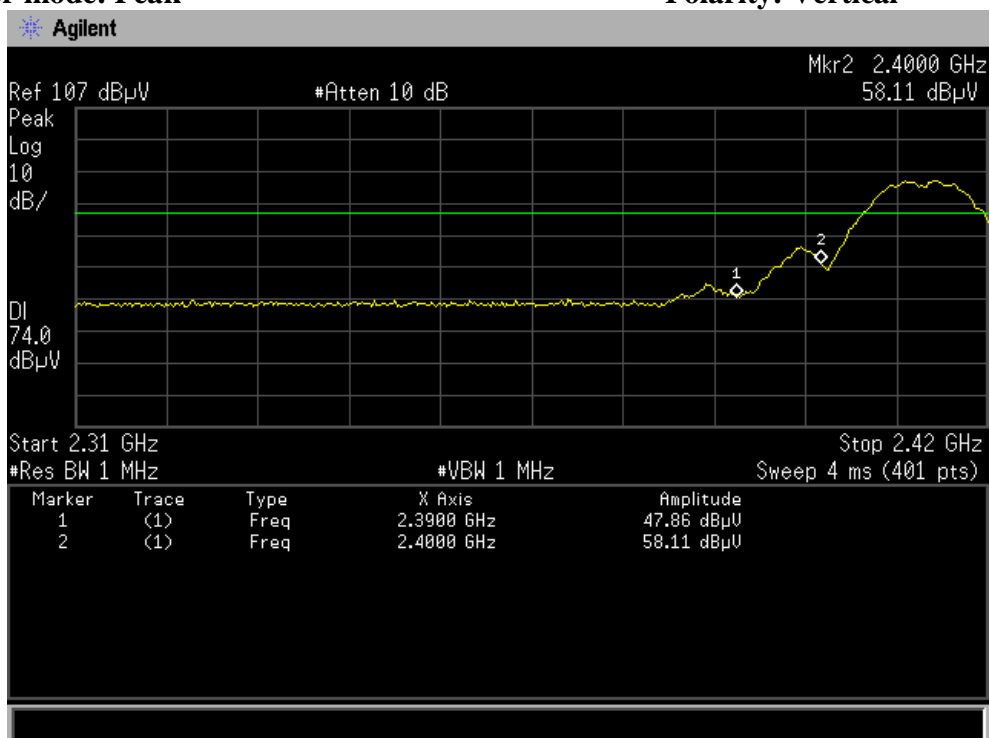

Detector mode: Average

Polarity: Vertical

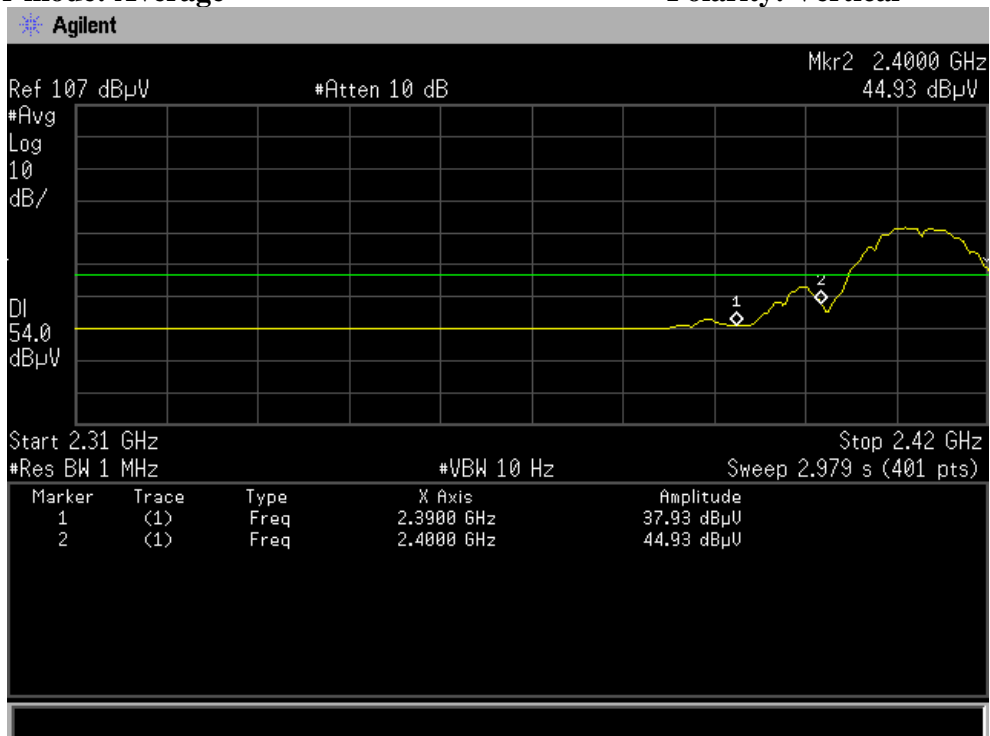

Report No.: STE121108551

CH High :

Detector mode: Peak

Polarity: Vertical

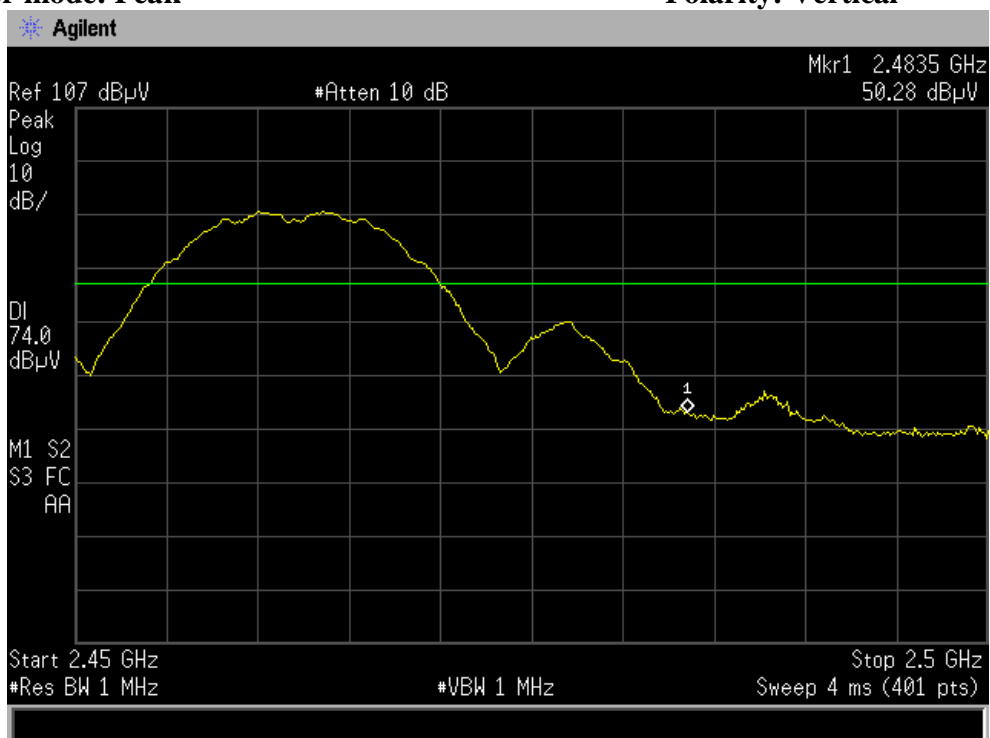

Detector mode: Average

Polarity: Vertical

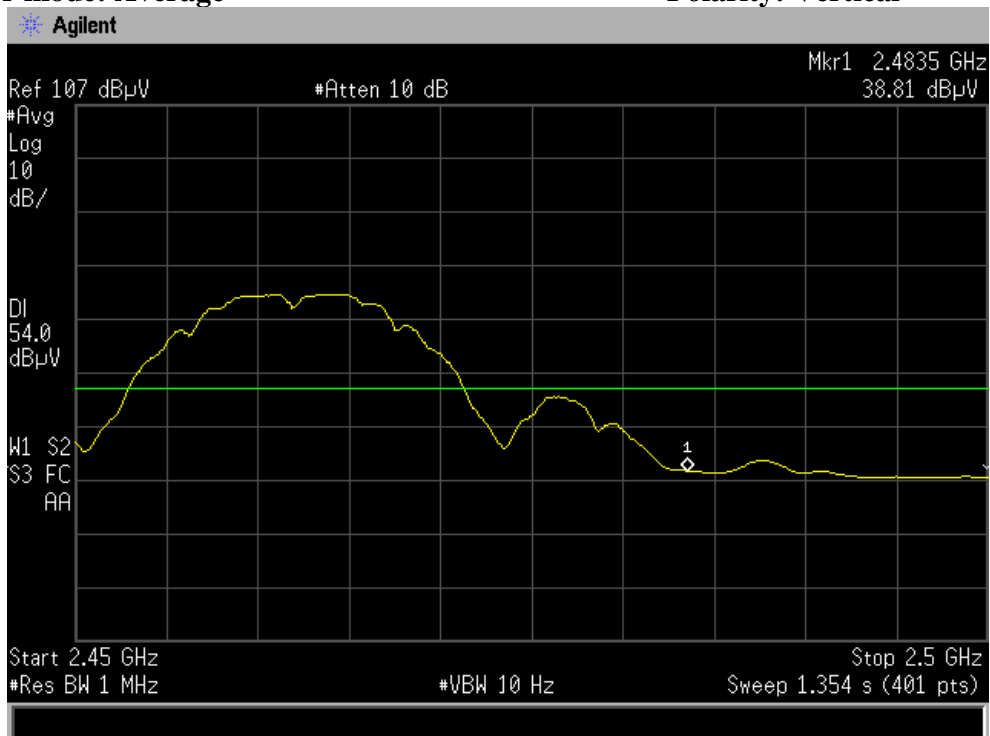

IEEE 802.11g:

CH LOW :

Detector mode: Peak

Polarity: Horizontal

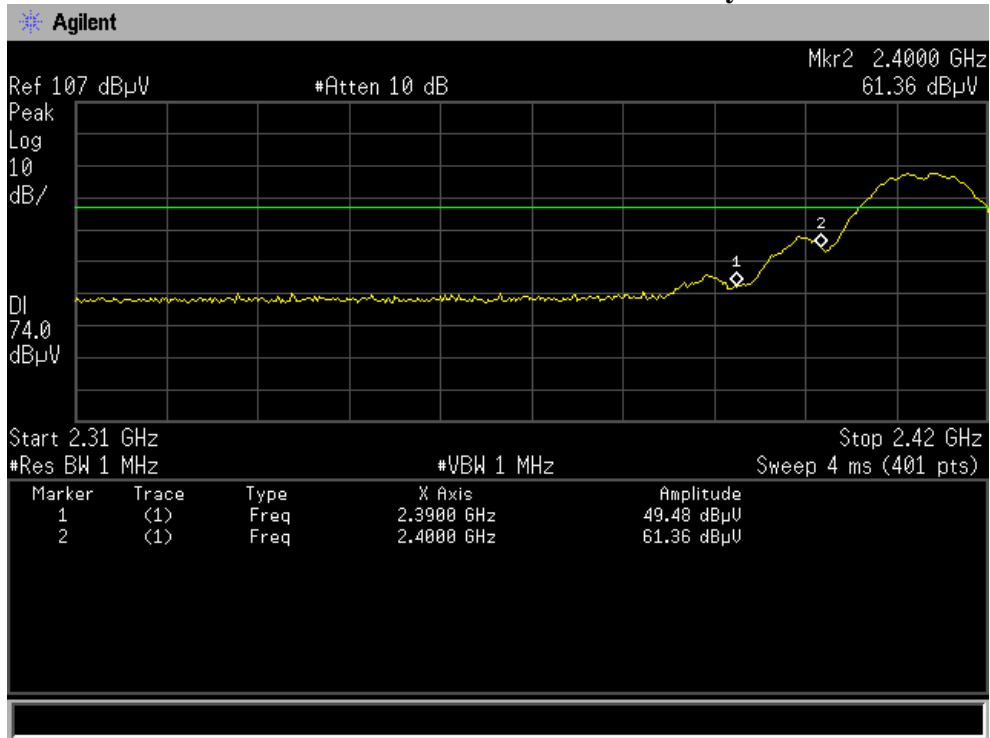

Detector mode: Average

Polarity: Horizontal

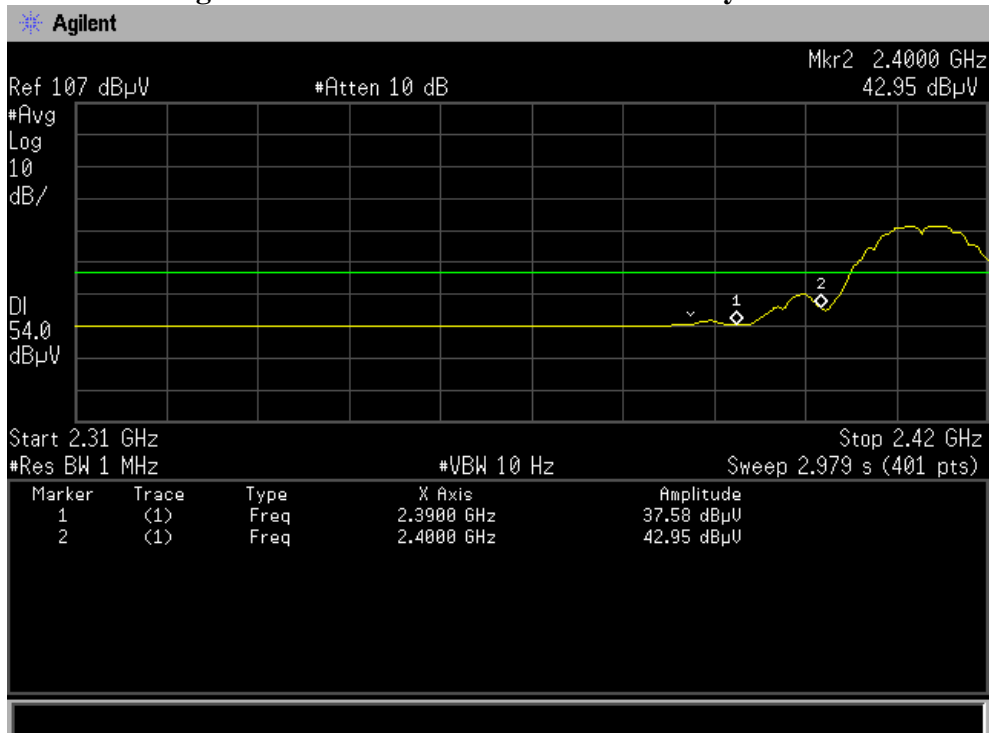

CH High :

Detector mode: Peak

Polarity: Horizontal

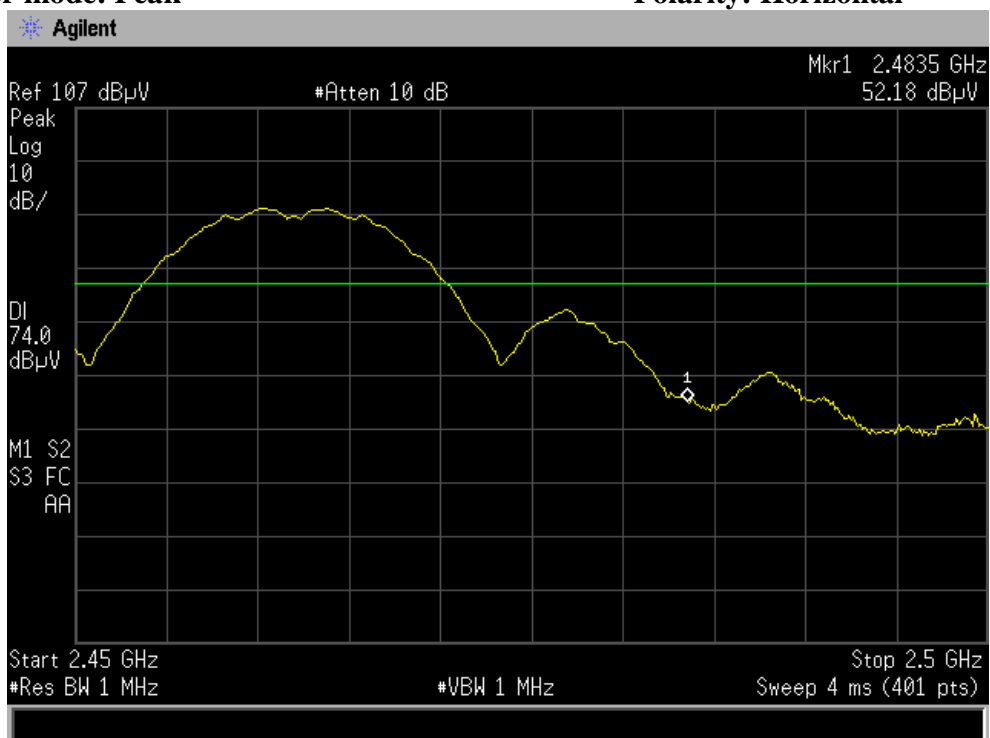

Detector mode: Average

Polarity: Horizontal

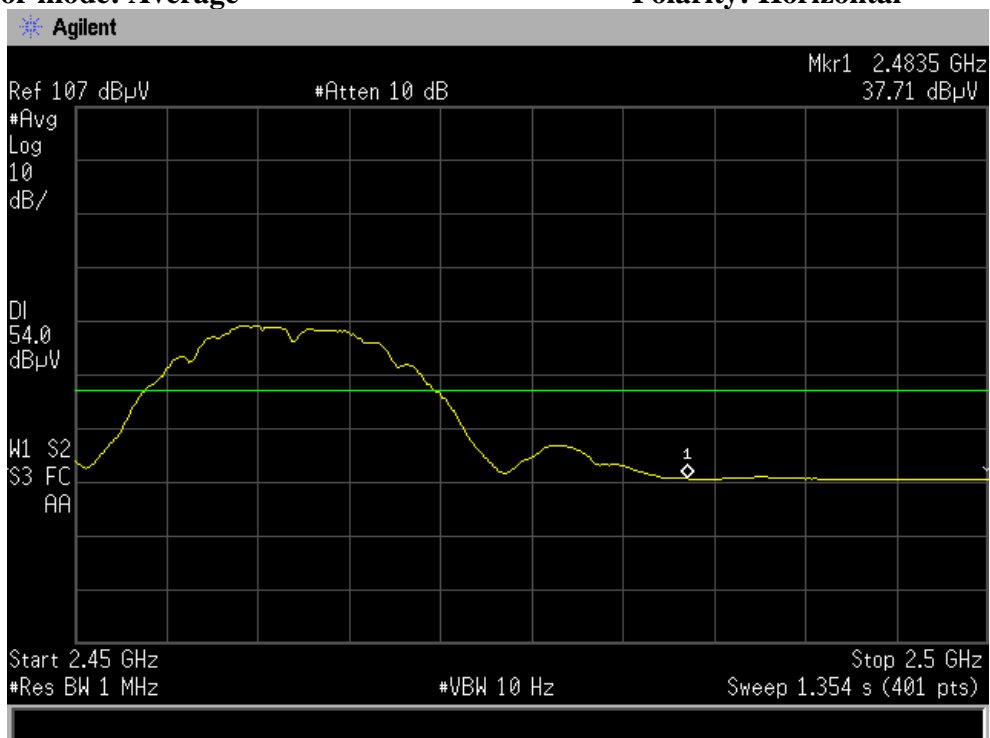

CH LOW :

Detector mode: Peak

Polarity: Vertical

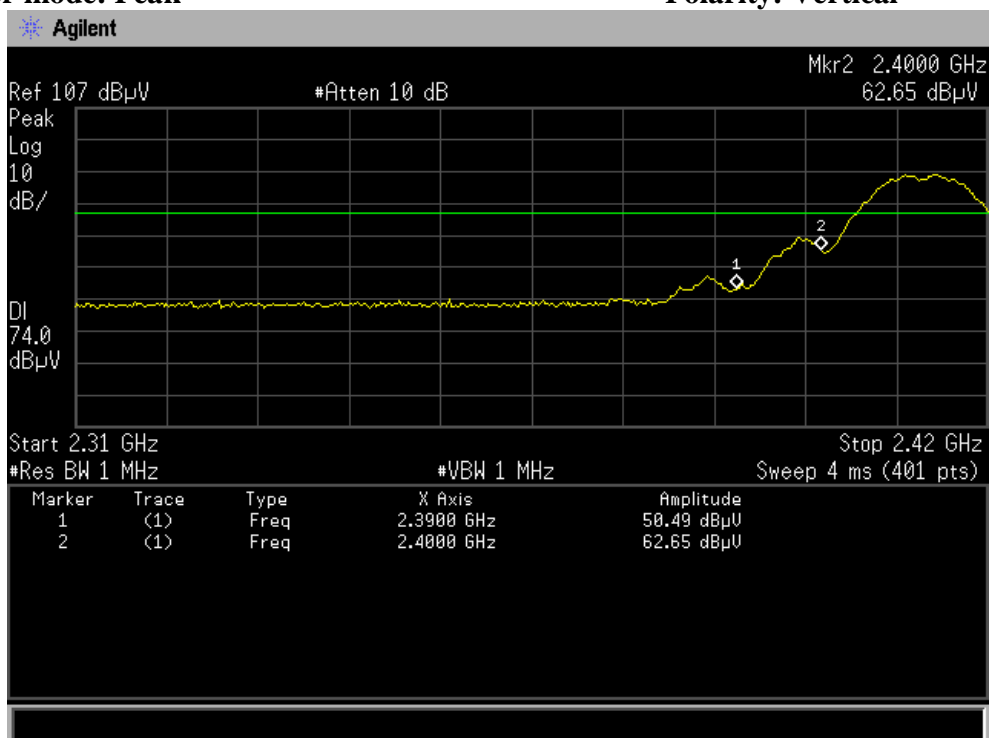

Detector mode: Average

Polarity: Vertical

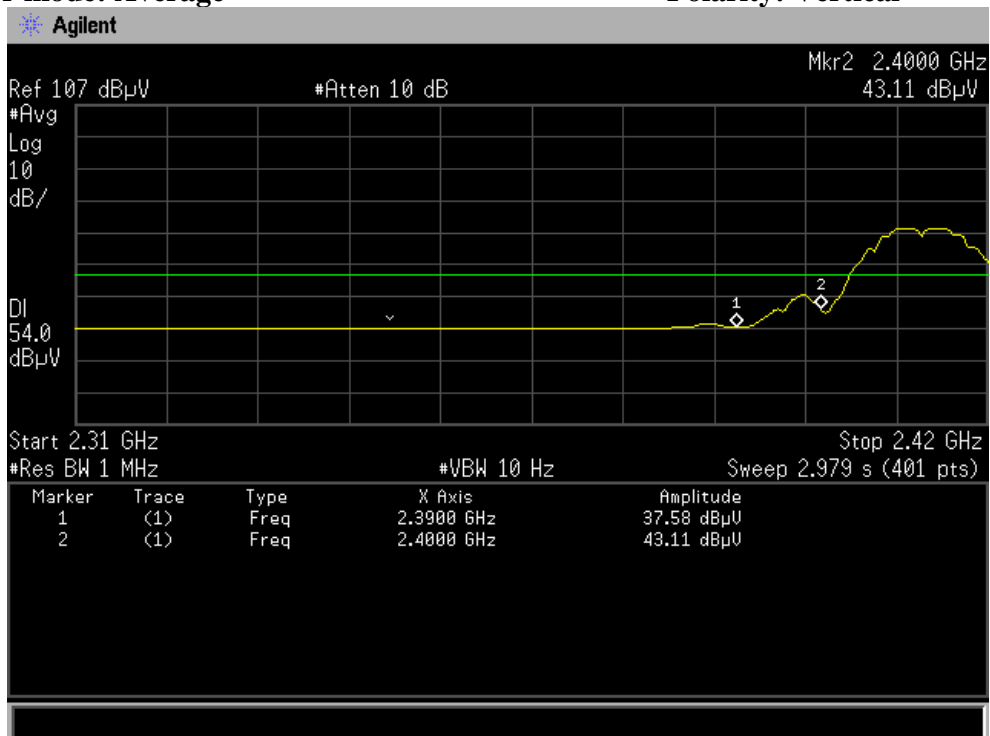

Report No.: STE121108551

CH High :

Detector mode: Peak

Polarity: Vertical

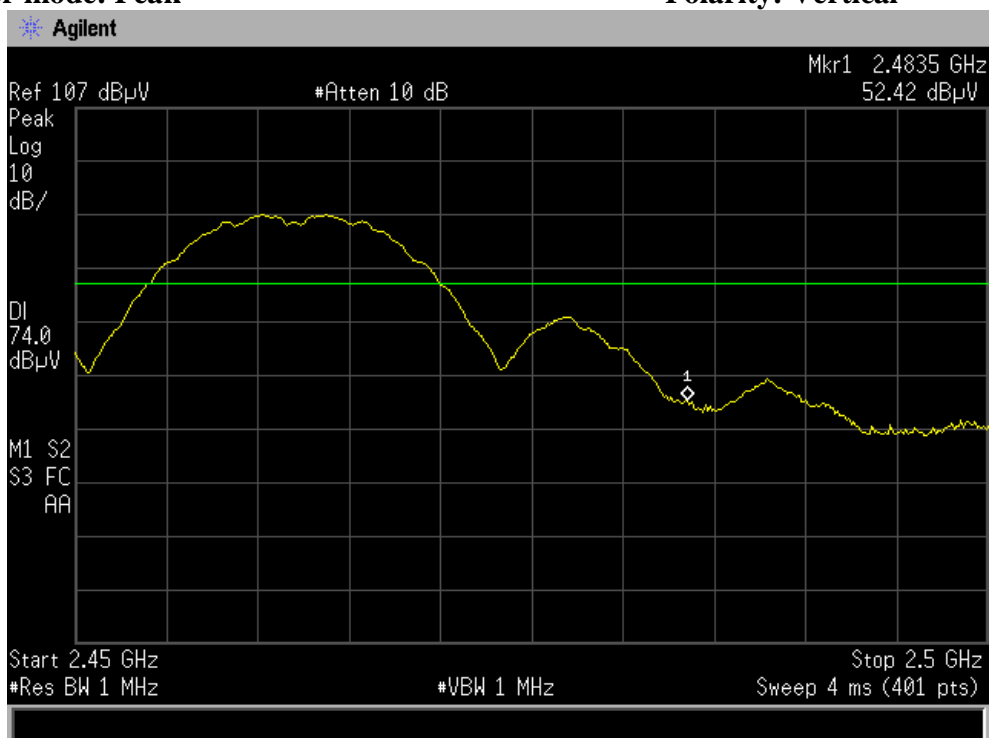

Detector mode: Average

Polarity: Vertical



IEEE 802.11n/HT20:

CH LOW :

Detector mode: Peak

Polarity: Horizontal

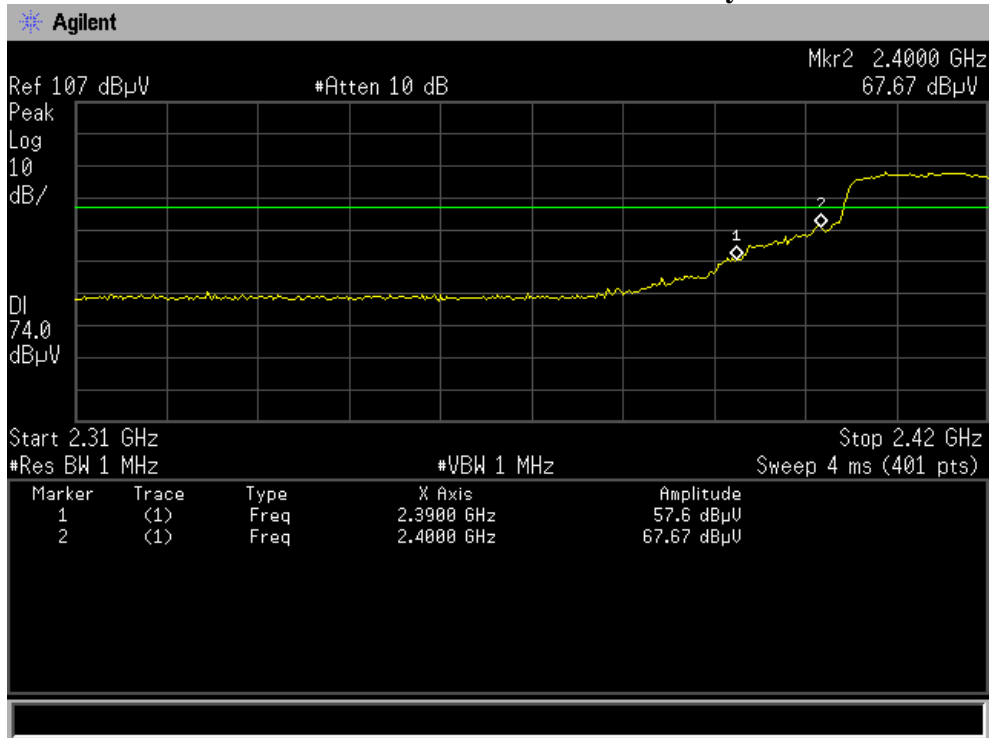

Detector mode: Average

Polarity: Horizontal

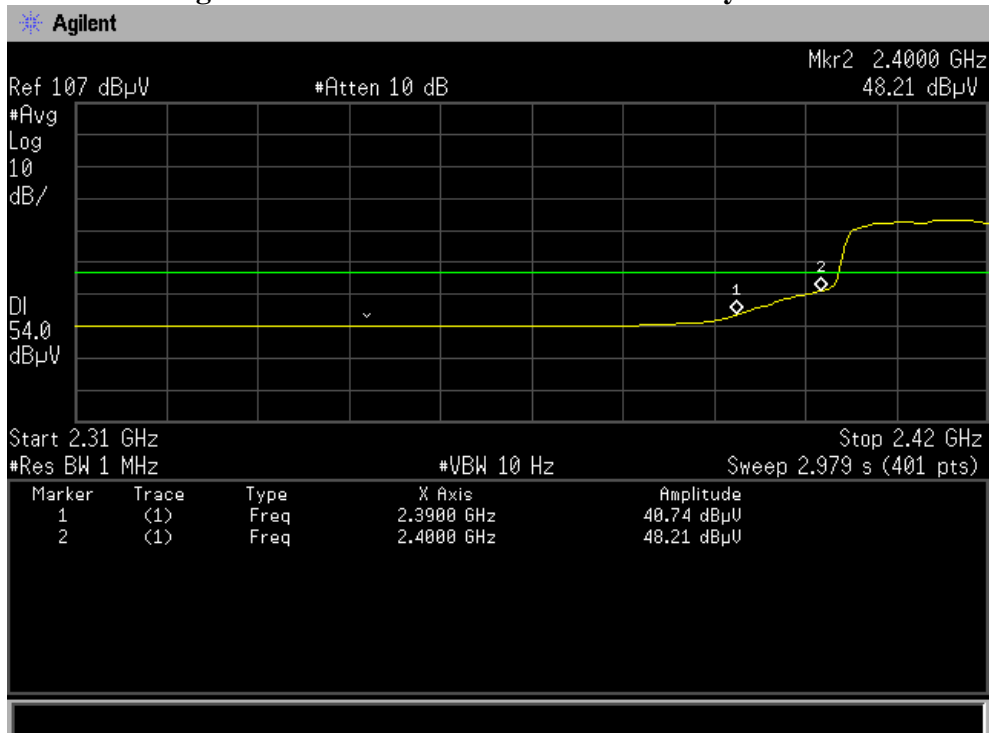

Report No.: STE121108551

CH High :

Detector mode: Peak

Polarity: Horizontal

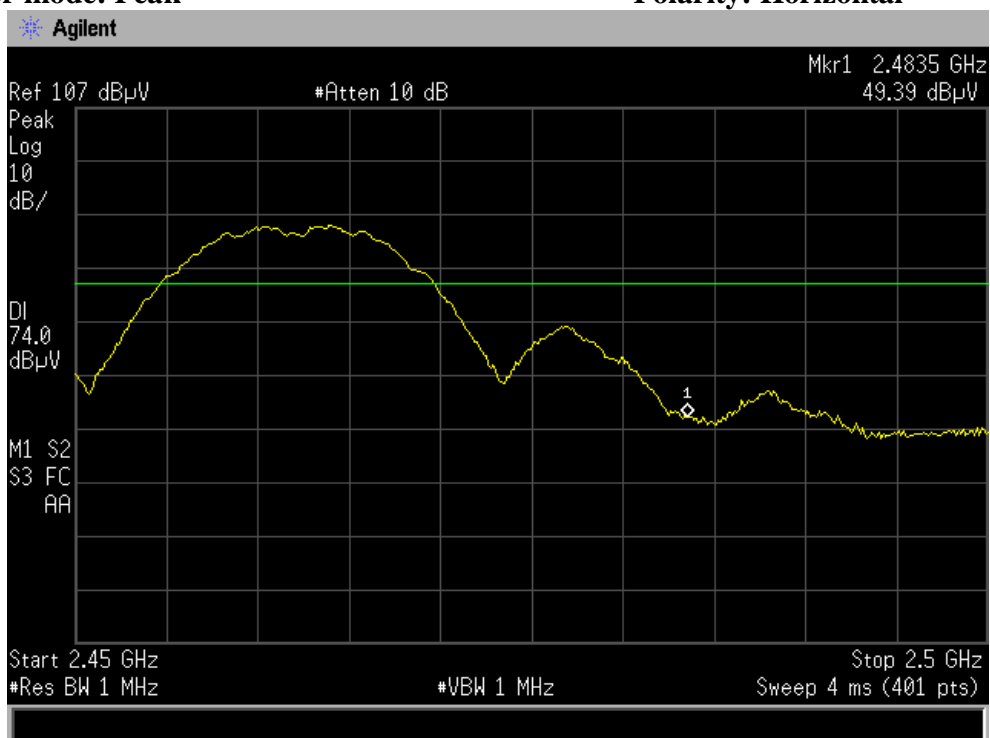

Detector mode: Average

Polarity: Horizontal

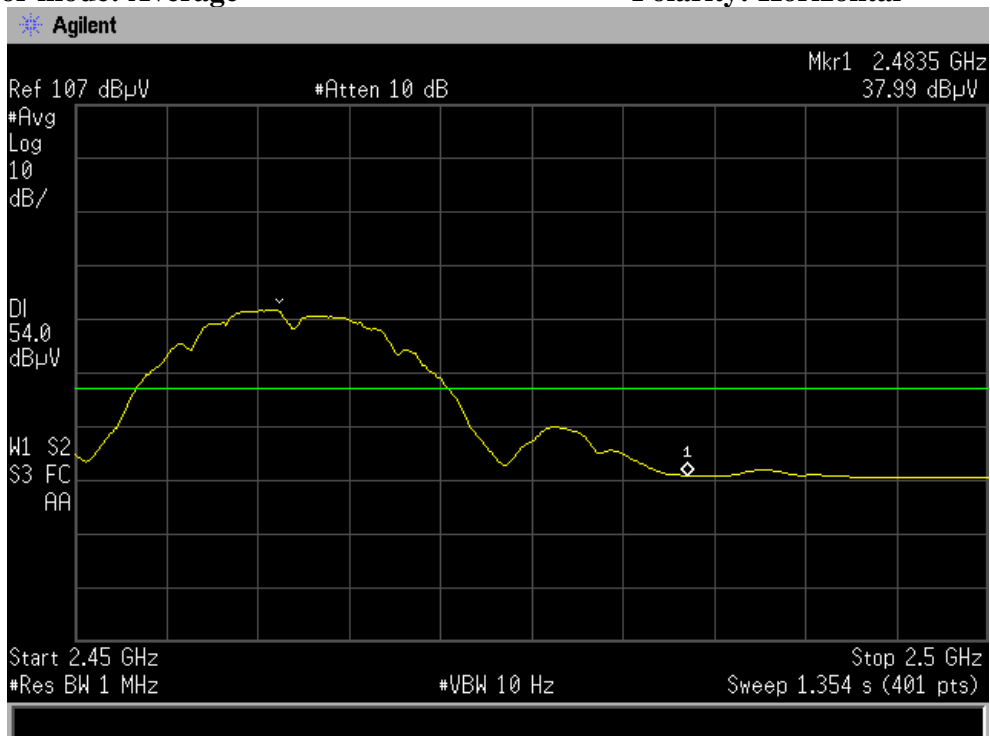

CH LOW :

Detector mode: Peak

Polarity: Vertical

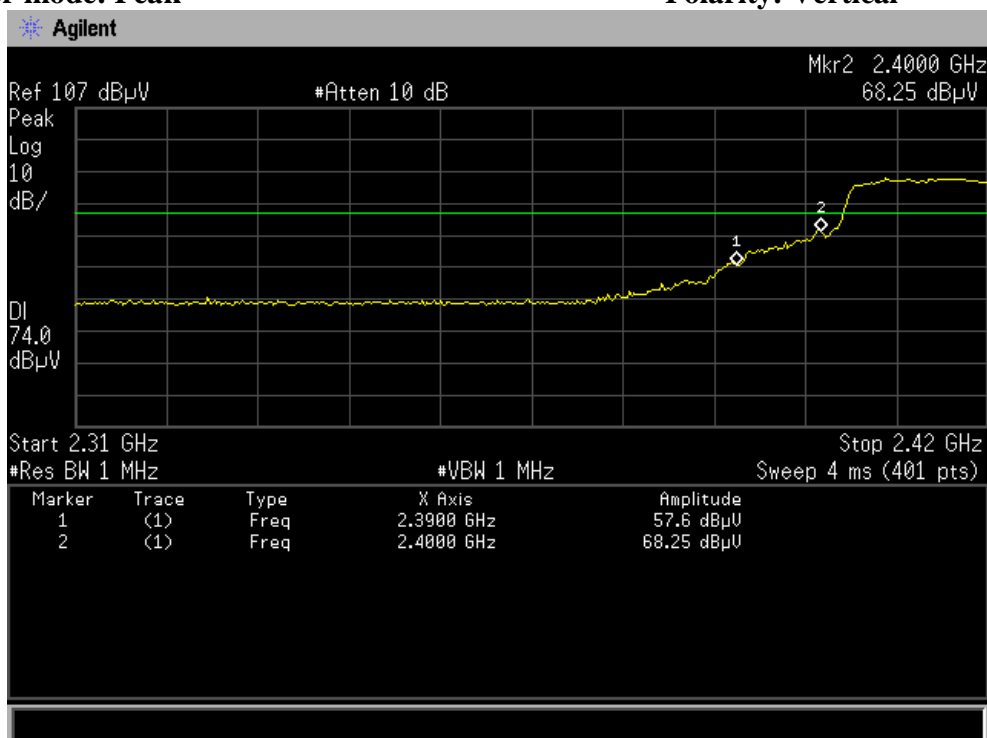

Detector mode: Average

Polarity: Vertical

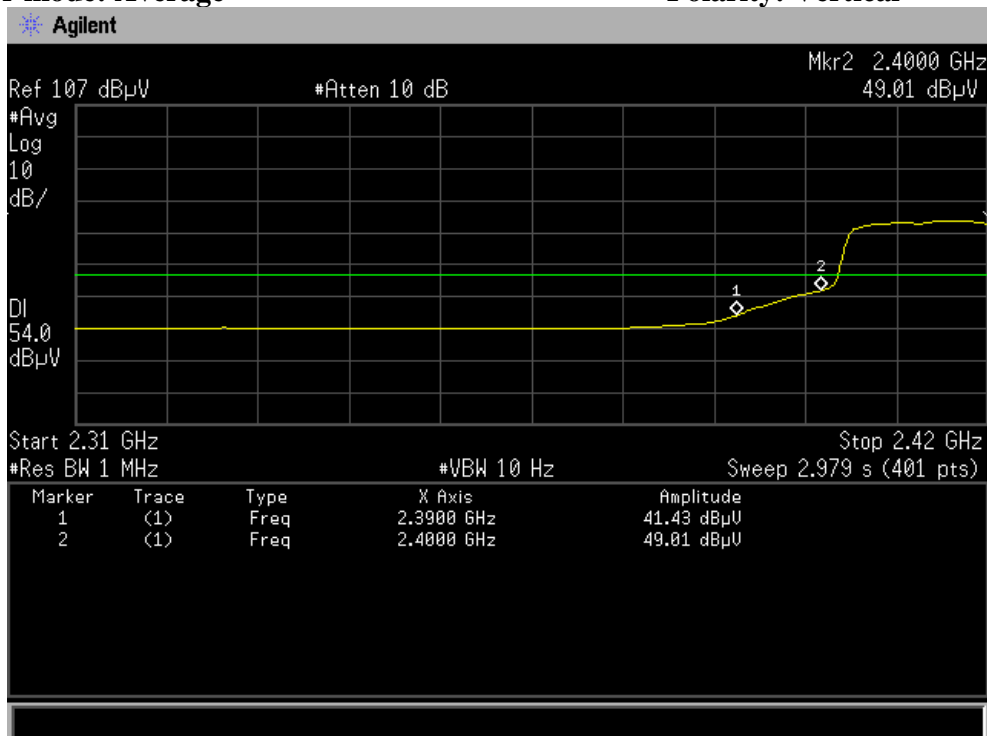

Report No.: STE121108551

CH High :

Detector mode: Peak

Polarity: Vertical

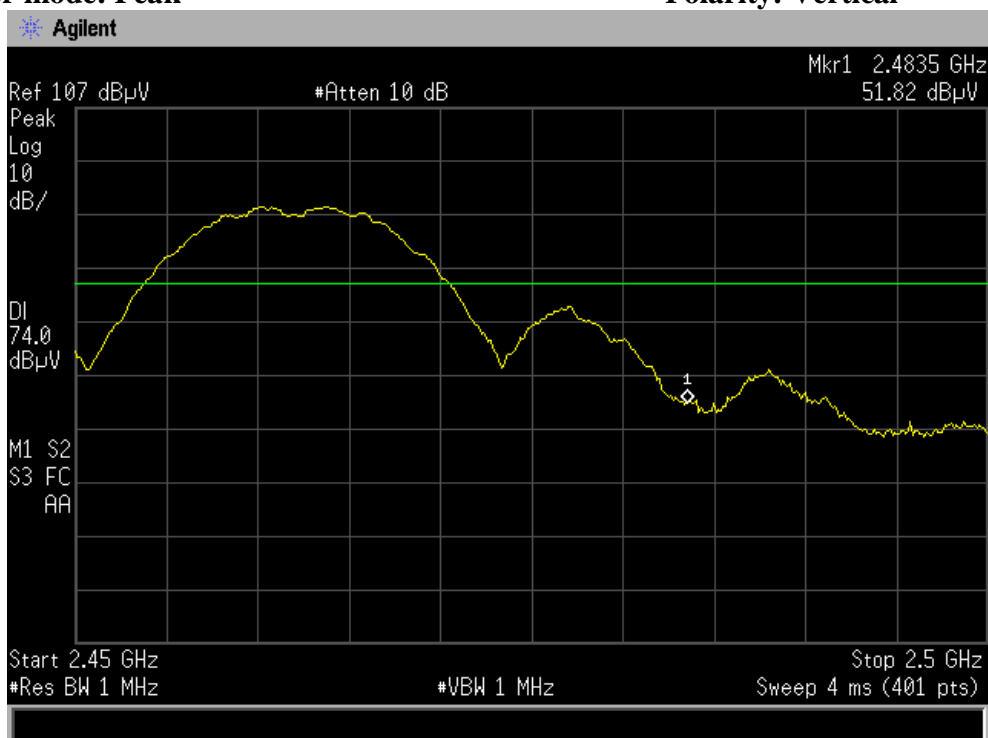

Detector mode: Average

Polarity: Vertical



IEEE 802.11n/HT40:

CH LOW :

Detector mode: Peak

Polarity: Horizontal

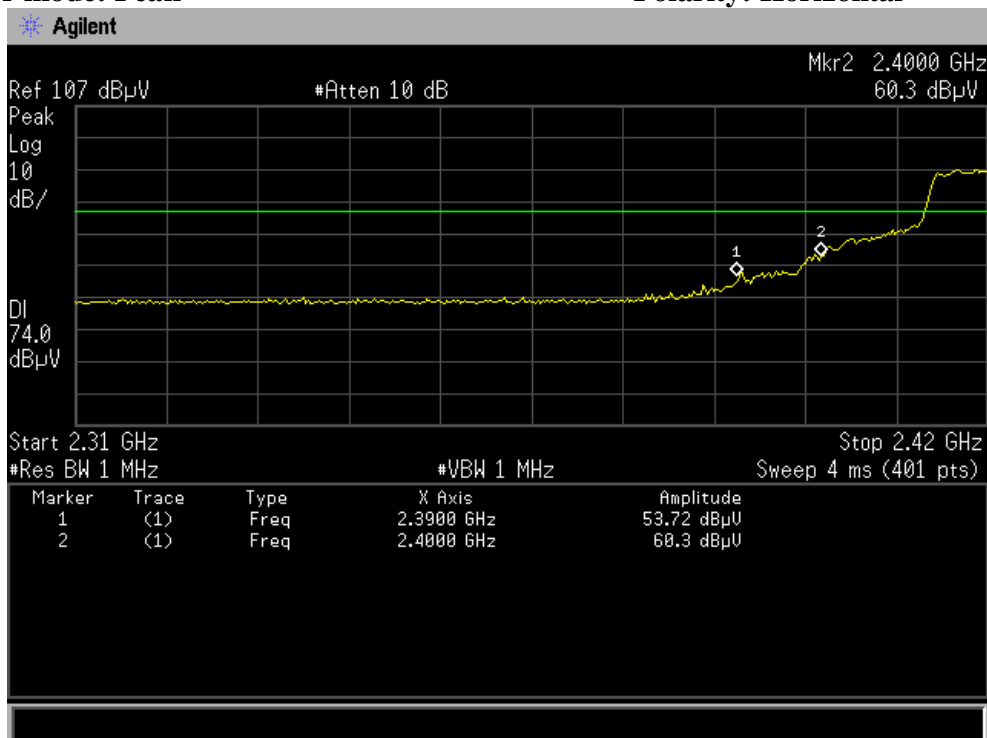

Detector mode: Average

Polarity: Horizontal

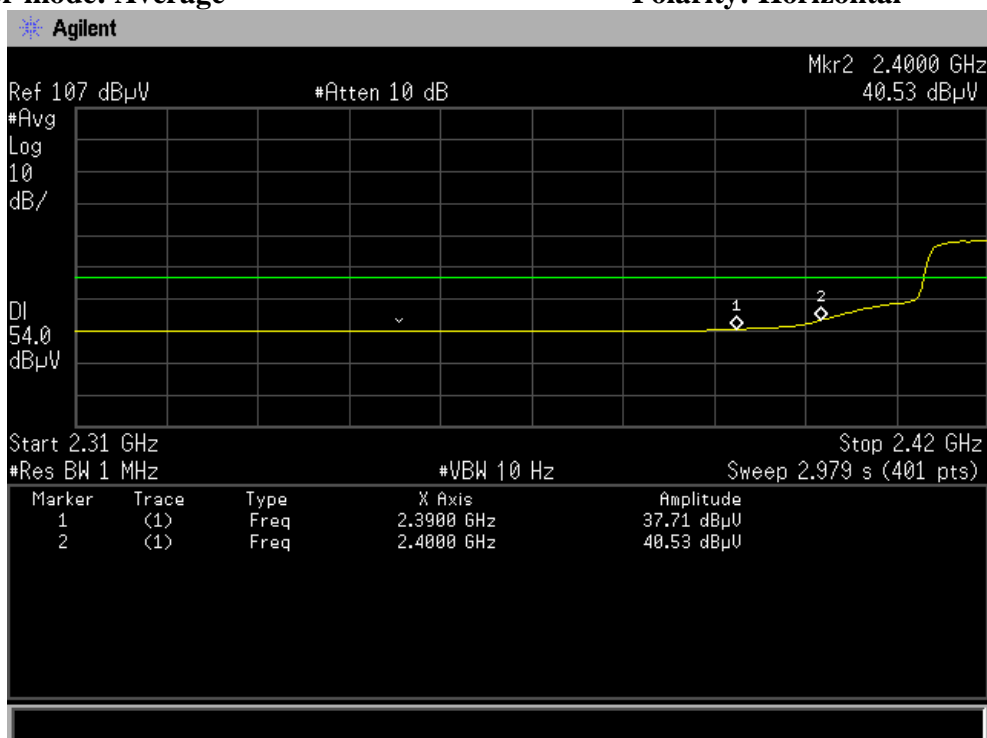

CH High :

Detector mode: Peak

Polarity: Horizontal

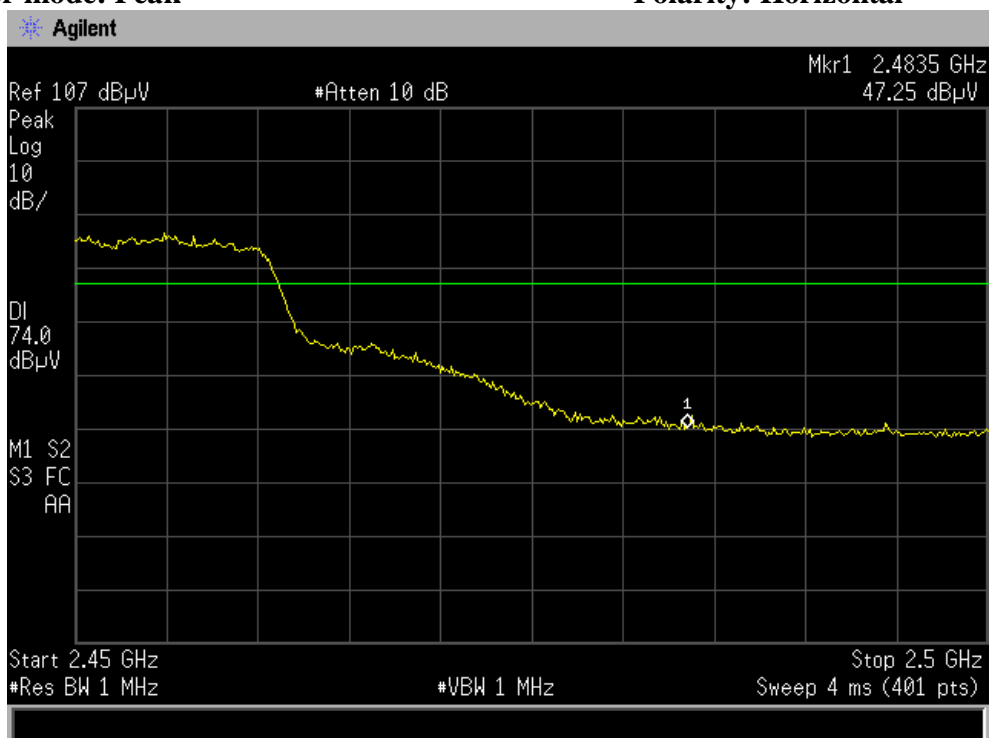

Detector mode: Average

Polarity: Horizontal

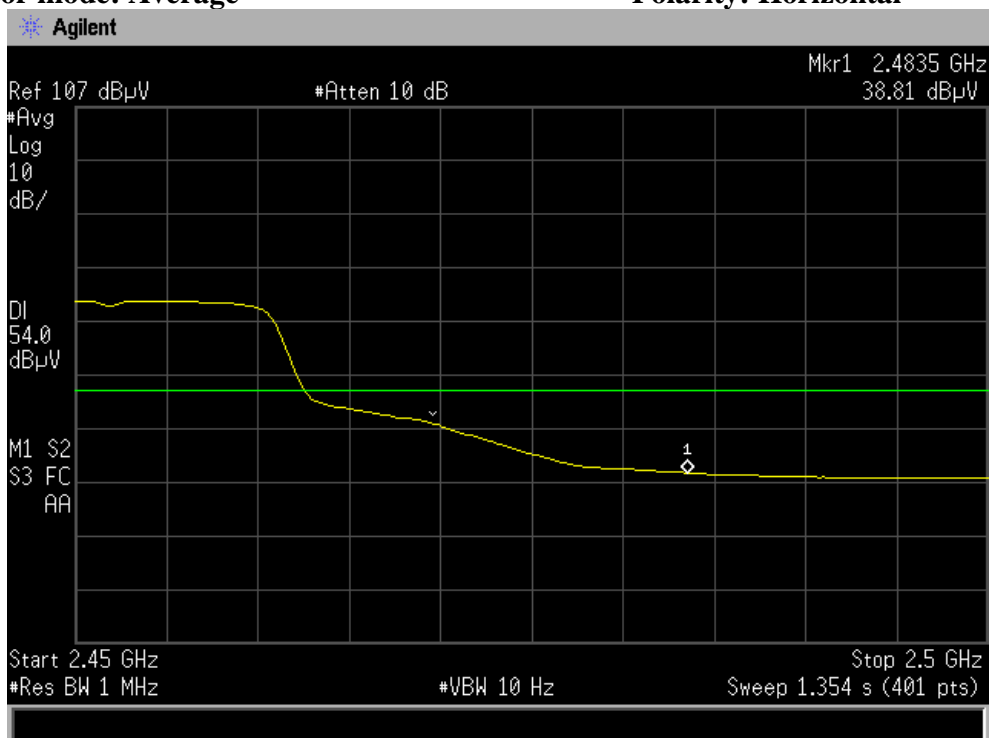

CH LOW :

Detector mode: Peak

Polarity: Vertical

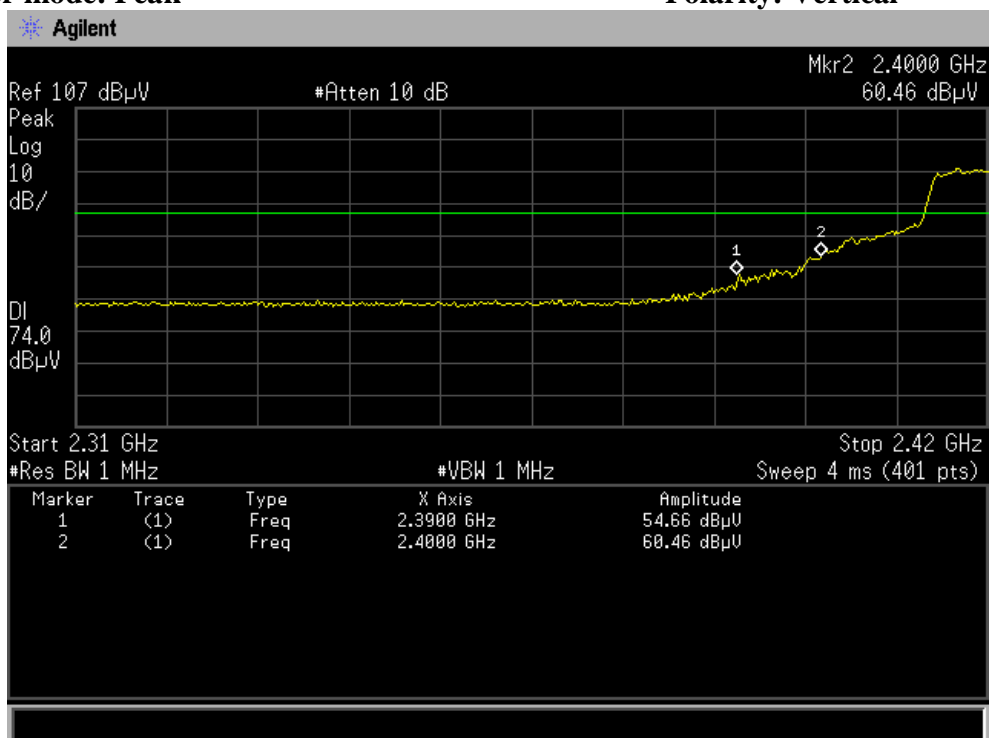

Detector mode: Average

Polarity: Vertical

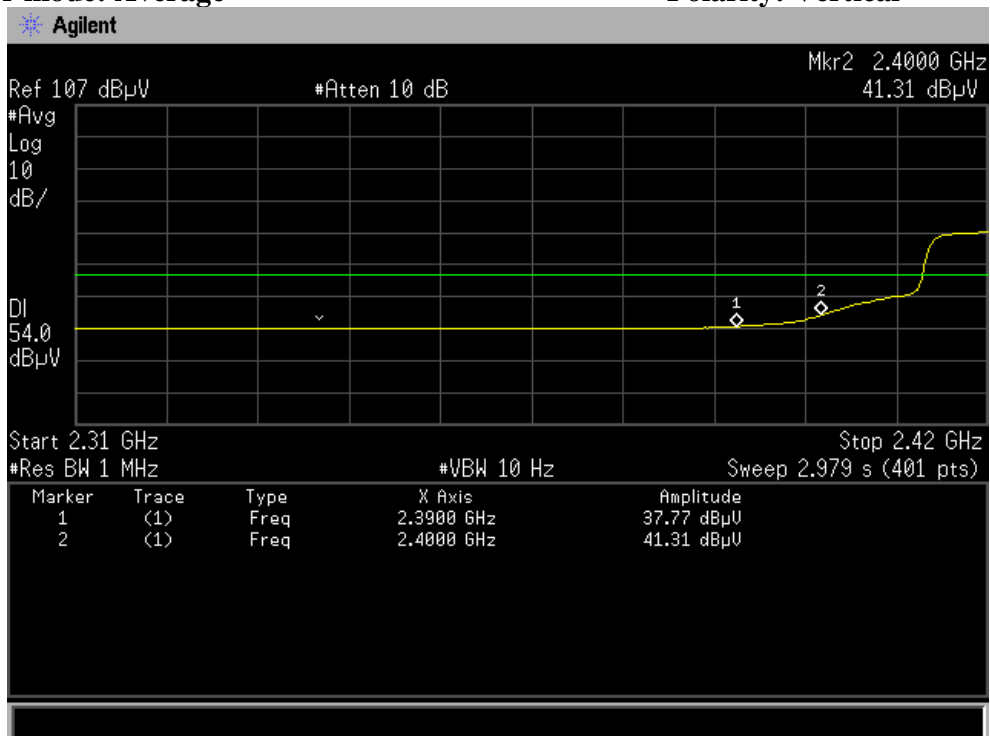

Report No.: STE121108551

CH High :

Detector mode: Peak

Polarity: Vertical

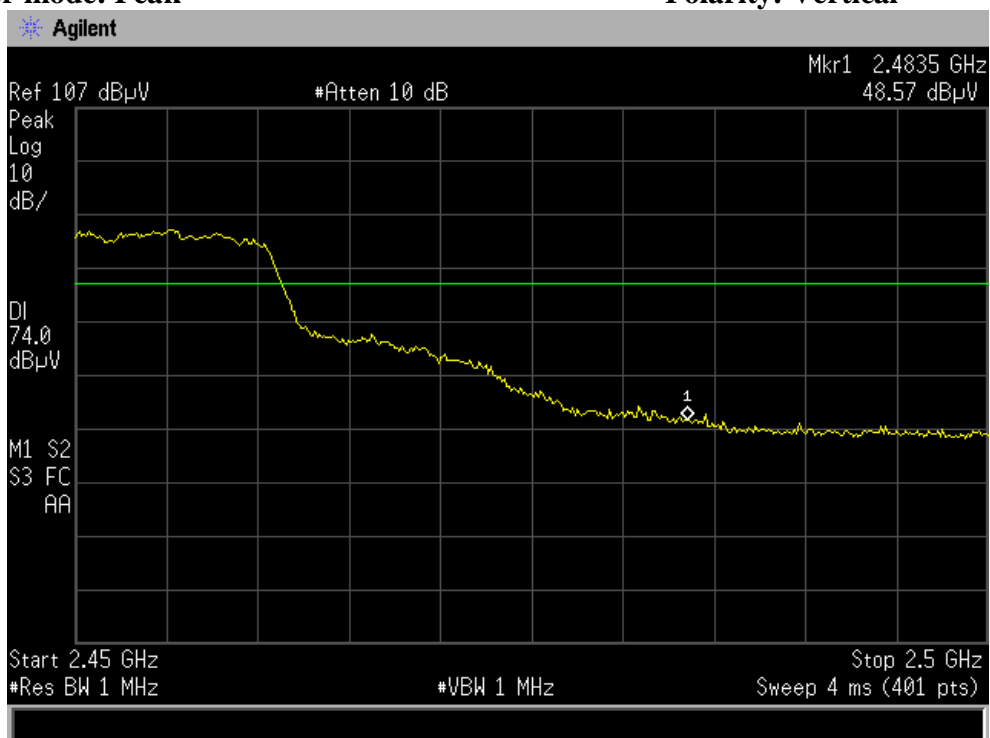

Detector mode: Average

Polarity: Vertical

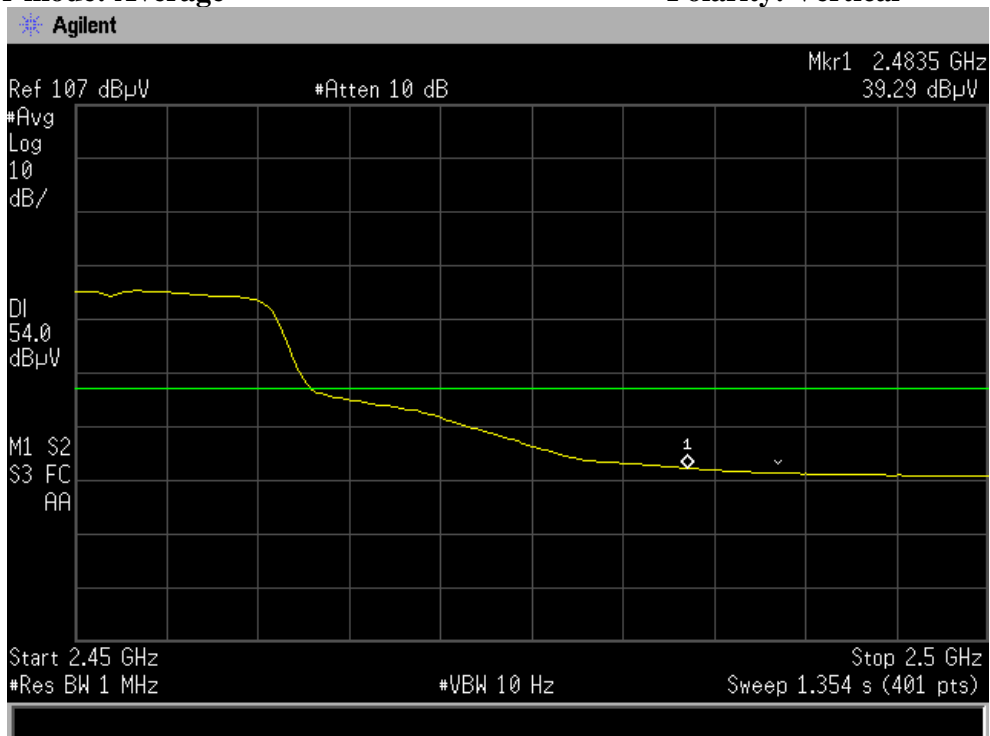

11 Antenna Requirement

11.1 Standard Requirement

An intentional radiator shall be designed to ensure that no antenna other than that furnished by the responsible party shall be used with the device. The use of a permanently attached antenna or of an antenna that uses a unique coupling to the intentional radiator shall be considered sufficient to comply with the provisions of this Section. The manufacturer may design the unit so that a broken antenna can be replaced by the user, but the use of a standard antenna jack or electrical connector is prohibited.

11.2 Antenna Connected Construction

The directional gains of antenna used for transmitting is 1 dBi, and the antenna connector is designed with permanent attachment and no consideration of replacement. Please see EUT photo for details.

11.3 Result

The EUT antenna is integral Antenna. It comply with the standard requirement.

12 Photographs of Test Setup

Photographs-Radiated Emission Test Setup in Chamber

Below 1G

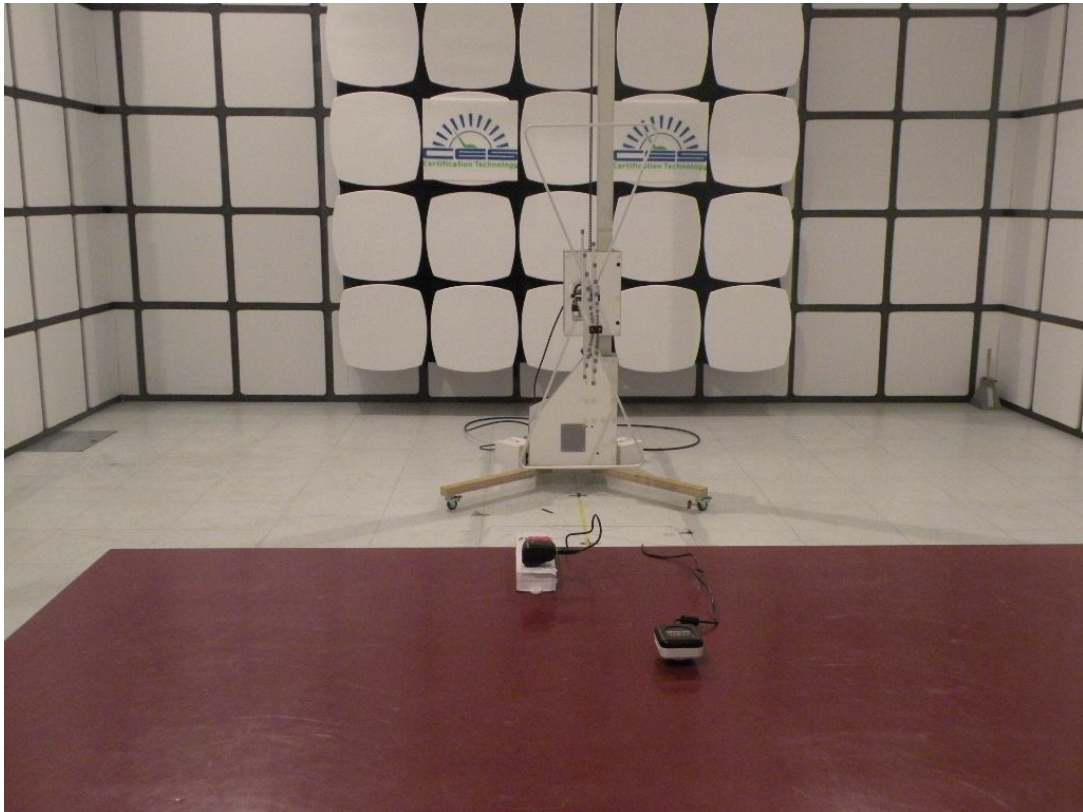

Above 1G

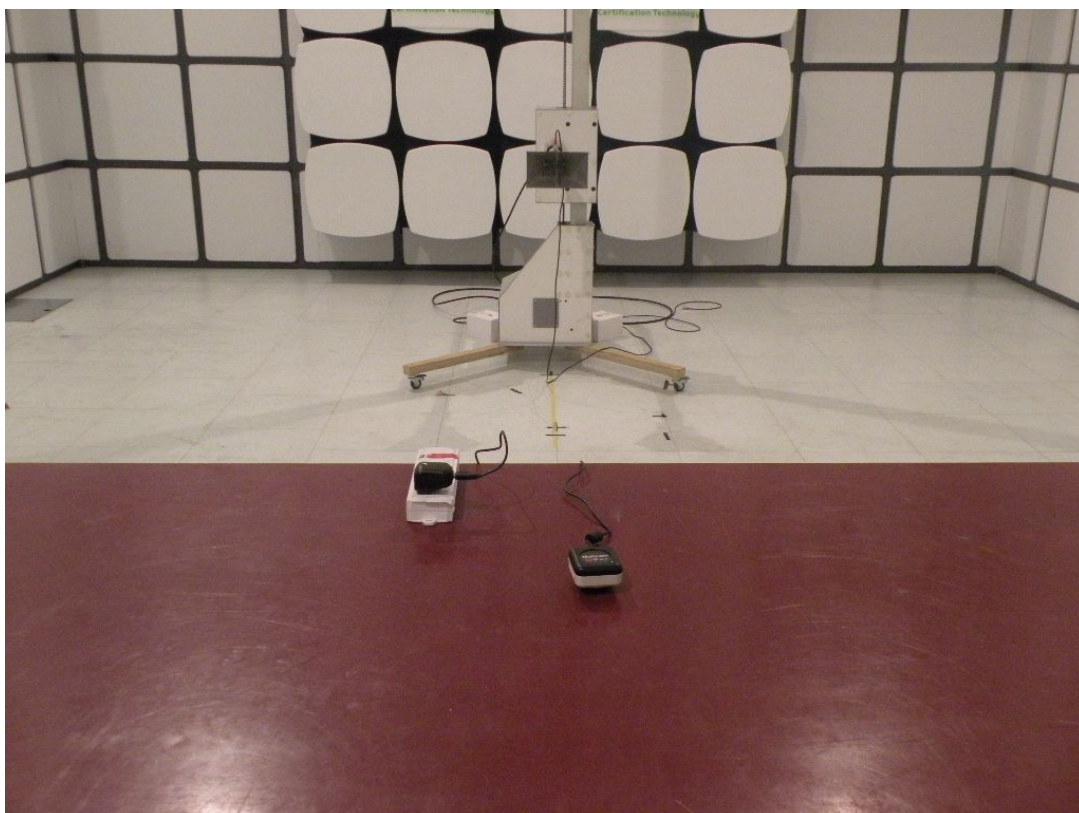

Photographs-Conducted Emission Test Setup



13 Photographs of EUT



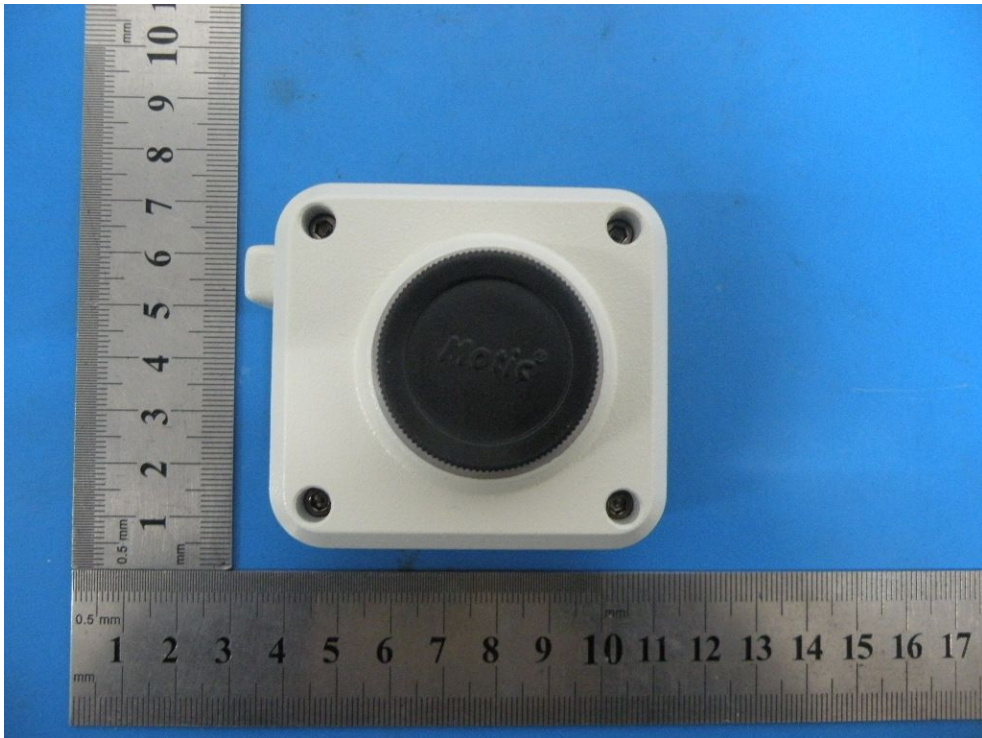



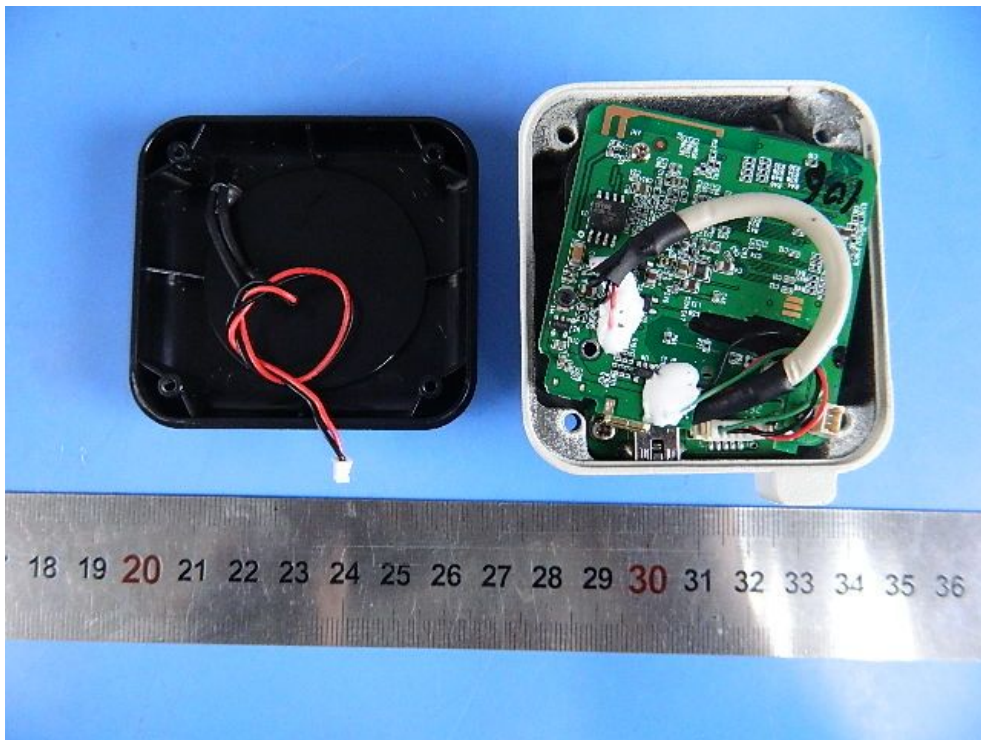
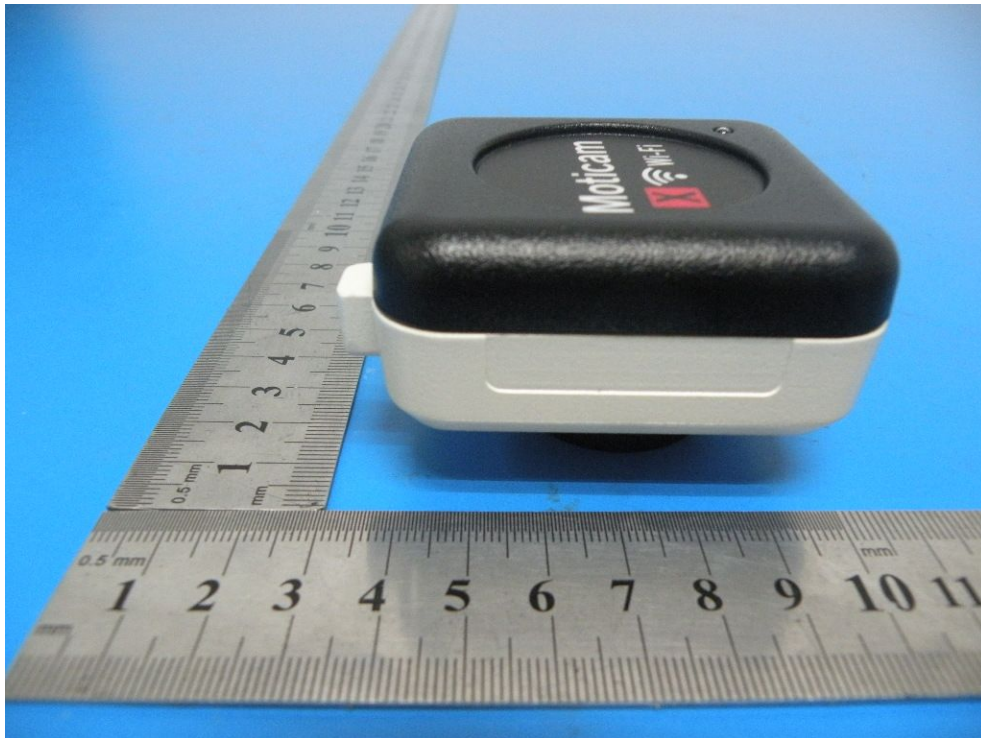

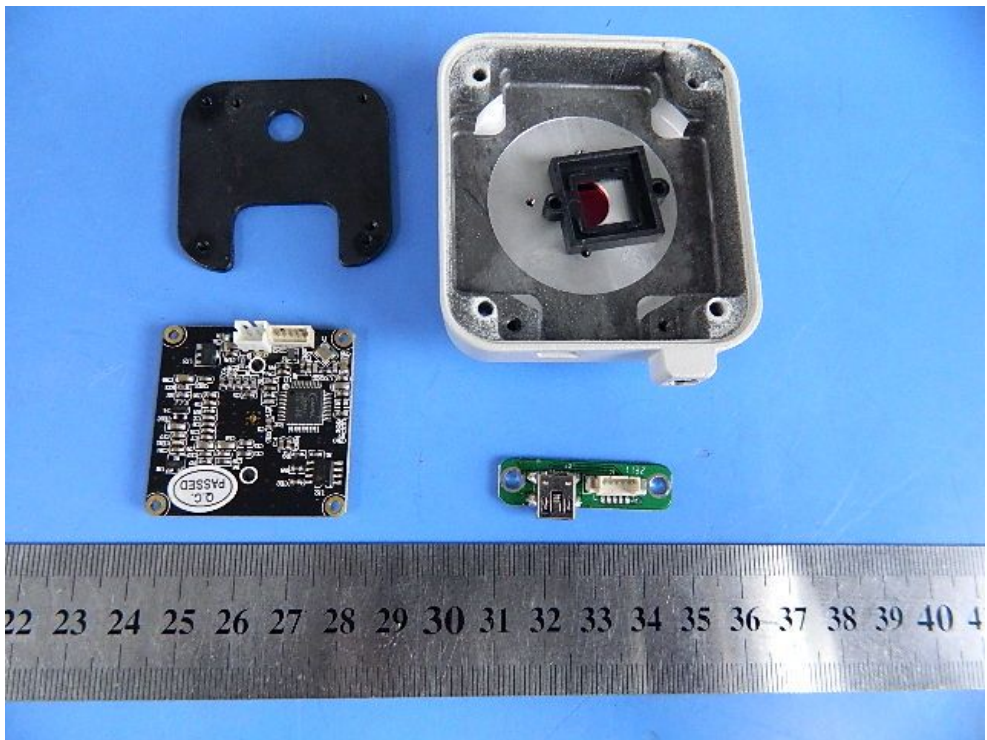
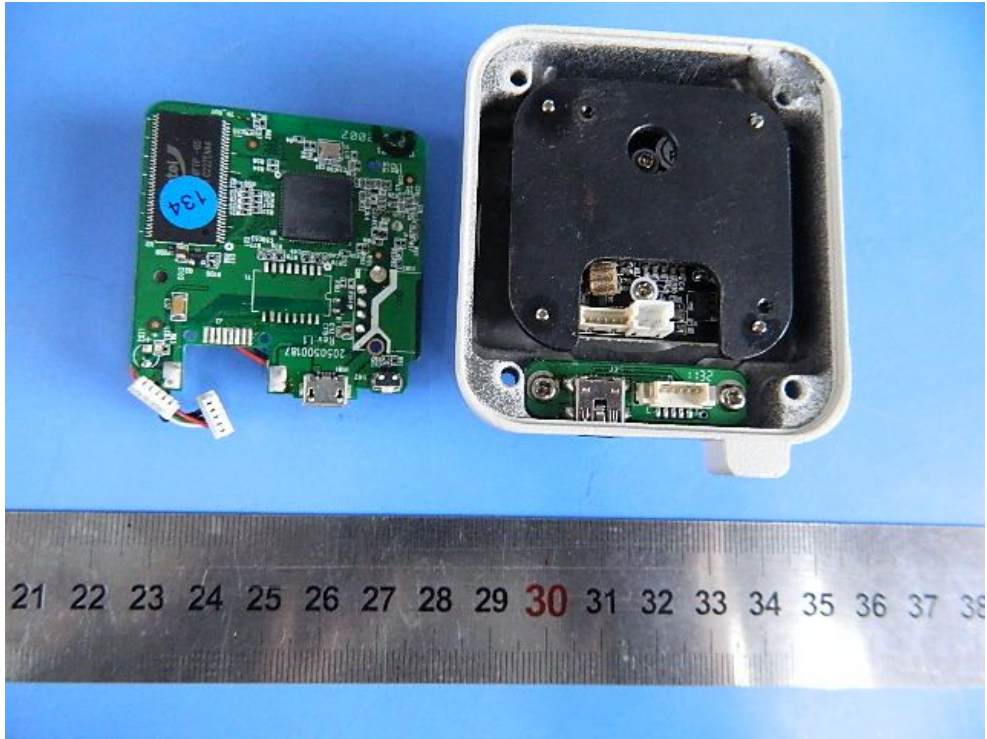

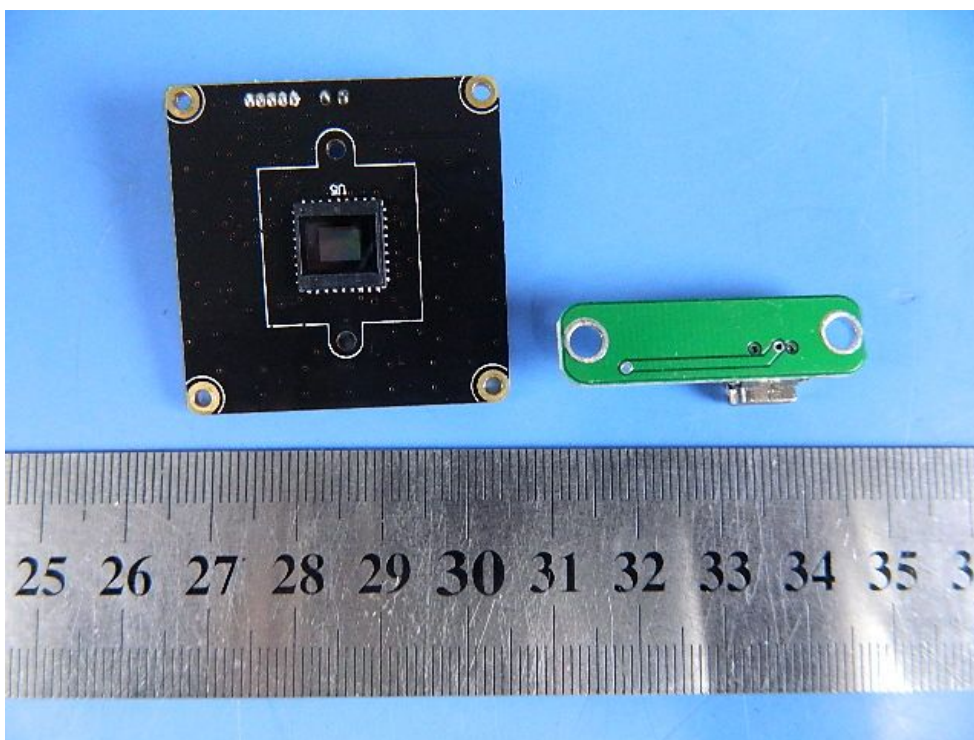
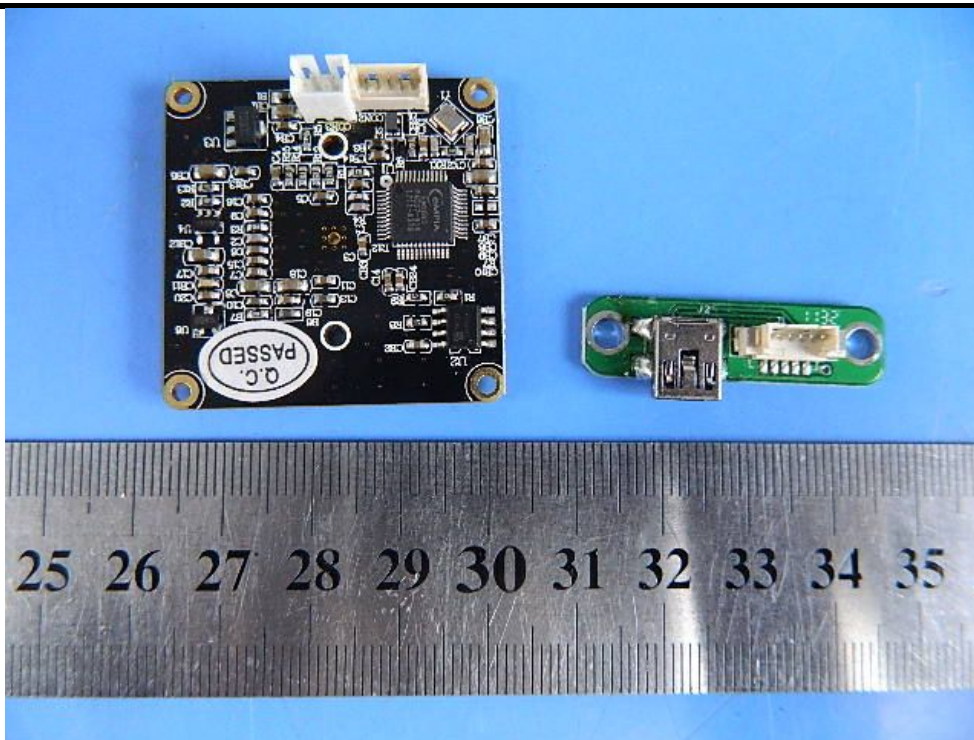

-----END OF THE REPORT-----