



Test Report No.: RF2403WDG0245



TEST REPORT



Applicant	The House of Marley. LLC
Address	3000 Pontiac Trail, Commerce Township, Michigan 48390 United States

Manufacturer or Supplier	The House of Marley. LLC
Address	3000 Pontiac Trail, Commerce Township, Michigan 48390 United States
Product	Uplift
Brand Name	 Marley, MARLEY
Model	EM-JA027
Additional Model & Model Difference	N/A
Date of tests	Mar. 27, 2024 ~ Jun. 03, 2024

the tests have been carried out according to the requirements of the following standards:

FCC Part 15, Subpart C, Section 15.247

CONCLUSION: The submitted sample was found to COMPLY with the test requirement

Tested by Niko Zhang Project Engineer / EMC Department	Approved by Glyn He Assistant Manager / EMC Department
	 Date: Jul. 09, 2024

This report is governed by, and incorporates by reference, the Conditions of Testing as posted at the date of issuance of this report at <http://www.bureauveritas.com/home/about-us/our-business/cps/about-us/terms-conditions/> and is intended for your exclusive use. Any copying or replication of this report to or for any other person or entity, or use of our name or trademark, is permitted only with our prior written permission. This report sets forth our findings solely with respect to the test samples identified herein. The results set forth in this report are not indicative or representative of the quality or characteristics of the lot from which a test sample was taken or any similar or identical product unless specifically and expressly noted. Our report includes all of the tests requested by you and the results thereof based upon the information that you provided to us. Measurement uncertainty is only provided upon request for accredited tests. Statements of conformity are based on simple acceptance criteria without taking measurement uncertainty into account, unless otherwise requested in writing. You have 60 days from date of issuance of this report to notify us of any material error or omission caused by our negligence or if you require measurement uncertainty; provided, however, that such notice shall be in writing and shall specifically address the issue you wish to raise. A failure to raise such issue within the prescribed time shall constitute your unqualified acceptance of the completeness of this report, the tests conducted and the correctness of the report contents.



TABLE OF CONTENTS

RELEASE CONTROL RECORD	5
1 SUMMARY OF TEST RESULTS.....	6
2 MEASUREMENT UNCERTAINTY	6
3 GENERAL INFORMATION	7
3.1 GENERAL DESCRIPTION OF EUT	7
3.2 DESCRIPTION OF TEST MODES	8
3.2.1. CONFIGURATION OF SYSTEM UNDER TEST.....	9
3.2.2. TEST MODE APPLICABILITY AND TESTED CHANNEL DETAIL.....	9
3.3 GENERAL DESCRIPTION OF APPLIED STANDARDS	11
3.4 DESCRIPTION OF SUPPORT UNITS	11
3.5 CONFIGURATION OF SYSTEM UNDER TEST	11
3.6 DUTY CYCLE OF TESET SIGNAL.....	12
4 TEST TYPES AND RESULTS.....	13
4.1 CONDUCTED EMISSION MEASUREMENT	13
4.1.1 LIMITS OF CONDUCTED EMISSION MEASUREMENT	13
4.1.2 TEST INSTRUMENTS	13
4.1.3 TEST PROCEDURE	14
4.1.4 DEVIATION FROM TEST STANDARD	14
4.1.5 TEST SETUP.....	15
4.1.6 EUT OPERATING CONDITIONS.....	15
4.1.7 TEST RESULTS	16
4.2. RADIATED EMISSION AND BANDEDGE MEASUREMENT	18
4.2.1 LIMITS OF RADIATED EMISSION AND BANDEDGE MEASUREMENT	18
4.2.2 TEST INSTRUMENTS	19
4.2.3 TEST PROCEDURES	20
4.2.4 DEVIATION FROM TEST STANDARD	21
4.2.5 TEST SETUP.....	21
4.2.6 EUT OPERATING CONDITIONS.....	22
4.2.7 TEST RESULTS	23
4.3 NUMBER OF HOPPING FREQUENCY USED	31
4.3.1 LIMIT OF HOPPING FREQUENCY USED	31
4.3.2 TEST SETUP.....	31
4.3.3 TEST INSTRUMENTS	31
4.3.4 TEST PROCEDURES	32



Test Report No.: RF2403WDG0245

4.3.5 DEVIATION FROM TEST STANDARD 32

4.3.6 TEST RESULTS 32

4.4 DWELL TIME ON EACH CHANNEL 35

4.4.1 LIMIT OF DWELL TIME USED..... 35

4.4.2 TEST SETUP..... 35

4.4.3 TEST INSTRUMENTS 35

4.4.4 TEST PROCEDURES 35

4.4.5 DEVIATION FROM TEST STANDARD 36

4.4.6 TEST RESULTS 36

4.5 CHANNEL BANDWIDTH 39

4.5.1 LIMITS OF CHANNEL BANDWIDTH 39

4.5.2 TEST SETUP..... 39

4.5.3 TEST INSTRUMENTS 39

4.5.4 TEST PROCEDURE 39

4.5.5 DEVIATION FROM TEST STANDARD 39

4.5.6 EUT OPERATING CONDITION 39

4.5.7 TEST RESULTS 40

4.6 HOPPING CHANNEL SEPARATION 44

4.6.1 LIMIT OF HOPPING CHANNEL SEPARATION 44

4.6.2 TEST SETUP..... 44

4.6.3 TEST INSTRUMENTS 44

4.6.4 TEST PROCEDURES 44

4.6.5 DEVIATION FROM TEST STANDARD 44

4.6.6 TEST RESULTS 45

4.7 CONDUCTED OUTPUT POWER 49

4.7.1 LIMITS OF CONDUCTED OUTPUT POWER MEASUREMENT 49

4.7.2 TEST SETUP..... 49

4.7.3 TEST INSTRUMENTS 49

4.7.4 TEST PROCEDURES 49

4.7.5 DEVIATION FROM TEST STANDARD 49

4.7.6 EUT OPERATING CONDITION 50

4.7.7 TEST RESULTS 50

4.8 OUT OF BAND EMISSION MEASUREMENT 52

4.8.1 LIMITS OF OUT OF BAND EMISSION MEASUREMENT 52

4.8.2 TEST INSTRUMENTS 52

4.8.3 TEST PROCEDURE 52

4.8.4 DEVIATION FROM TEST STANDARD 52



**BUREAU
VERITAS**

Test Report No.: RF2403WDG0245

4.8.5	EUT OPERATING CONDITION	52
4.8.6	TEST RESULTS	52
5	PHOTOGRAPHS OF THE TEST CONFIGURATION	57
6	APPENDIX A - MODIFICATIONS RECORDERS FOR ENGINEERING CHANGES TO THE EUT BY THE LAB.....	58



Test Report No.: RF2403WDG0245

RELEASE CONTROL RECORD

ISSUE NO.	REASON FOR CHANGE	DATE ISSUED
RF2403WDG0245	Original release	Jul. 08, 2024

1 SUMMARY OF TEST RESULTS

The EUT has been tested according to the following specifications:

APPLIED STANDARD: FCC Part 15, Subpart C			
STANDARD SECTION	TEST TYPE AND LIMIT	RESULT	REMARK
15.207	AC Power Conducted Emission	PASS	Meet the requirement of limit.
15.247(a)(1)(iii)	Number of Hopping Frequency Used	PASS	Meet the requirement of limit.
15.247(a)(1)(iii)	Dwell Time on Each Channel	PASS	Meet the requirement of limit.
15.247(a)(1)	1. Hopping Channel Separation 2. Spectrum Bandwidth of a Frequency Hopping Sequence Spread Spectrum System	PASS	Meet the requirement of limit.
15.247(b)	Conducted Output Power	PASS	Meet the requirement of limit.
15.247(d)&15.209	Transmitter Radiated Emission	PASS	Meet the requirement of limit.
15.247(d)	Out of band Emission Measurement	PASS	Meet the requirement of limit.
15.203	Antenna Requirement	PASS	No antenna connector is used.

2 MEASUREMENT UNCERTAINTY

Where relevant, the following measurement uncertainty levels have been estimated for tests performed on the EUT as specified in CISPR 16-4-2:

MEASUREMENT	FREQUENCY	UNCERTAINTY
Conducted emissions	0.15MHz ~ 30MHz	3.36dB
Radiated emissions	9KHz ~ 30MHz	2.80dB
	30MHz ~ 1GMHz	4.65dB
	1GHz ~ 18GHz	5.01dB
	18GHz ~ 40GHz	4.10dB

This uncertainty represents an expanded uncertainty expressed at approximately the 95% confidence level using a coverage factor of k=2.

3 GENERAL INFORMATION

GENERAL DESCRIPTION OF EUT

PRODUCT	Uplift
MODEL NO.	EM-JA027
ADDITIONAL MODELS	N/A
FCC ID	PVB-EMJA027
POWER SUPPLY	DC 15V From Adapter Input AC 100-240V~50/60Hz
MODULATION TECHNOLOGY	FHSS
MODULATION TYPE	GFSK, $\pi/4$ DQPSK, 8DPSK
OPERATING FREQUENCY	2402MHz~2480MHz
NUMBER OF CHANNEL	79
PEAK OUTPUT POWER	2.133mW (Max. Measured)
ANTENNA TYPE	PCB Antenna, 0.26dBi Gain
CABLE SUPPLIED	Refer to user's manual

NOTE:

1. For a more detailed features description, please refer to the manufacturer's specifications or the user's manual.
2. For the test results, the EUT had been tested with all conditions. But only the worst case was shown in test report.
3. Please refer to the EUT photo document (Reference No.: 2403WDG0245) for detailed product photo.
4. The EUT were powered by the following Adapter.

ADAPTER	
BRAND:	N/A
MODEL:	HP24E-1501600-D
INPUT:	AC 100-240V~50/60Hz, 0.8A
OUTPUT:	DC 15V, 1.6A, 24W
DC LINE:	Unshielded, non-detachable, 1.5M

DESCRIPTION OF TEST MODES

79 channels are provided to this EUT:

CHANNEL	FREQ. (MHz)	CHANNEL	FREQ. (MHz)	CHANNEL	FREQ. (MHz)	CHANNEL	FREQ. (MHz)
0	2402	20	2422	40	2442	60	2462
1	2403	21	2423	41	2443	61	2463
2	2404	22	2424	42	2444	62	2464
3	2405	23	2425	43	2445	63	2465
4	2406	24	2426	44	2446	64	2466
5	2407	25	2427	45	2447	65	2467
6	2408	26	2428	46	2448	66	2468
7	2409	27	2429	47	2449	67	2469
8	2410	28	2430	48	2450	68	2470
9	2411	29	2431	49	2451	69	2471
10	2412	30	2432	50	2452	70	2472
11	2413	31	2433	51	2453	71	2473
12	2414	32	2434	52	2454	72	2474
13	2415	33	2435	53	2455	73	2475
14	2416	34	2436	54	2456	74	2476
15	2417	35	2437	55	2457	75	2477
16	2418	36	2438	56	2458	76	2478
17	2419	37	2439	57	2459	77	2479
18	2420	38	2440	58	2460	78	2480
19	2421	39	2441	59	2461		

3.2.1. CONFIGURATION OF SYSTEM UNDER TEST

Please see section 5 photograph of the test configuration for reference.

3.2.2. TEST MODE APPLICABILITY AND TESTED CHANNEL DETAIL

Pre-Scan has been conducted to determine the worst-case mode from all possible combinations between available modulations, data rates, XYZ axis, power supply voltage range and antenna ports. The worst case was found when positioned on X axis for radiated emission. Following channel(s) was (were) selected for the final test as listed below:

EUT CONFIGURE MODE	APPLICABLE TO				DESCRIPTION
	RE<1G	RE≥1G	PLC	APCM	
A	√	√	√	√	DC 15V From Adapter Input AC 230V 50Hz

Where **RE<1G**: Radiated Emission below 1GHz
PLC: Power Line Conducted Emission

RE≥1G: Radiated Emission above 1GHz
APCM: Antenna Port Conducted Measurement

RADIATED EMISSION TEST (BELOW 1 GHz):

- Pre-Scan has been conducted to determine the worst-case mode from all possible combinations between available modulations, XYZ axis, antenna ports (if EUT with antenna diversity architecture) and packet type.
- Following channel(s) was (were) selected for the final test as listed below.

EUT CONFIGURE MODE	AVAILABLE CHANNEL	TESTED CHANNEL	MODULATION TECHNOLOGY	MODULATION TYPE	PACKET TYPE
A	0 to 78	39	FHSS	GFSK	DH5

For the test results, only the worst case was shown in test report.

RADIATED EMISSION TEST (ABOVE 1 GHz):

- Pre-Scan has been conducted to determine the worst-case mode from all possible combinations between available modulations, XYZ axis, antenna ports (if EUT with antenna diversity architecture) and packet type.
- Following channel(s) was (were) selected for the final test as listed below.

EUT CONFIGURE MODE	AVAILABLE CHANNEL	TESTED CHANNEL	MODULATION TECHNOLOGY	MODULATION TYPE	PACKET TYPE
A	0 to 78	0, 39, 78	FHSS	GFSK	DH5
A	0 to 78	0, 39, 78	FHSS	8DPSK	3DH5

POWER LINE CONDUCTED EMISSION TEST:

- Pre-Scan has been conducted to determine the worst-case mode from all possible combinations between available modulations, antenna ports (if EUT with antenna diversity architecture), and packet types.
- Following channel(s) was (were) selected for the final test as listed below.

EUT CONFIGURE MODE	TESTED CONDITION
A	BT Link

ANTENNA PORT CONDUCTED MEASUREMENT:

- This item includes all test value of each mode, but only includes spectrum plot of worst value of each mode.
- Pre-Scan has been conducted to determine the worst-case mode from all possible combinations between available modulations, antenna ports (if EUT with antenna diversity architecture), and packet types.
- Following channel(s) was (were) selected for the final test as listed below.

EUT CONFIGURE MODE	AVAILABLE CHANNEL	TESTED CHANNEL	MODULATION TECHNOLOGY	MODULATION TYPE	PACKET TYPE
A	0 to 78	0, 39, 78	FHSS	GFSK	DH5
A	0 to 78	0, 39, 78	FHSS	8DPSK	3DH5

TEST CONDITION:

APPLICABLE TO	ENVIRONMENTAL CONDITIONS	TEST VOLTAGE (SYSTEM)	TESTED BY
RE<1G	28.3deg. C, 52.4%RH	DC 15V From Adapter Input AC 230V 50Hz	Ludius
RE≥1G	28.3deg. C, 52.4%RH	DC 15V From Adapter Input AC 230V 50Hz	Ludius
PLC	25deg. C, 55% RH	DC 15V From Adapter Input AC 230V 50Hz	Summer
APCM	24.5deg. C, 62%RH	DC 15V From Adapter Input AC 230V 50Hz	Vincent

GENERAL DESCRIPTION OF APPLIED STANDARDS

The EUT is a RF Product. According to the specifications of the manufacturer, it must comply with the requirements of the following standards:

FCC Part 15, Subpart C, Section 15.247
KDB 558074 D01 15.247 Meas Guidance v05r02
ANSI C63.10-2013

All test items have been performed and recorded as per the above standards.

DESCRIPTION OF SUPPORT UNITS

The EUT has been tested as an independent unit without any other necessary accessory or support units.

CONFIGURATION OF SYSTEM UNDER TEST

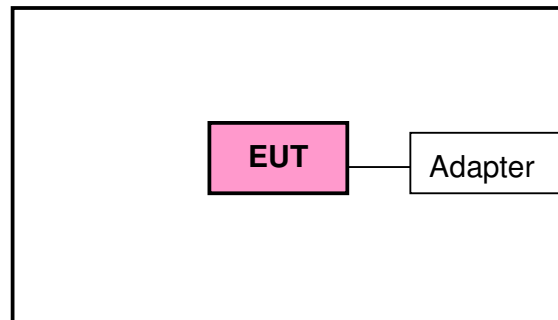



DUTY CYCLE OF TESET SIGNAL

Test Mode	Packet Type	On Time (ms)	Period (ms)	Duty Cycle (%)	1/T Min. VBW (KHz)	VBW Setting (Hz)
BDR(GFSK)	DH5	2.88	3.753	76.74	0.347	500
EDR(8DPSK)	3DH5	2.893	3.755	77.04	0.346	500

GFSK: Duty Cycle= On Time/ Period=2.88/3.753=0.7674

8-DPSK: Duty Cycle= On Time/ Period=2.893/3.755=0.7704

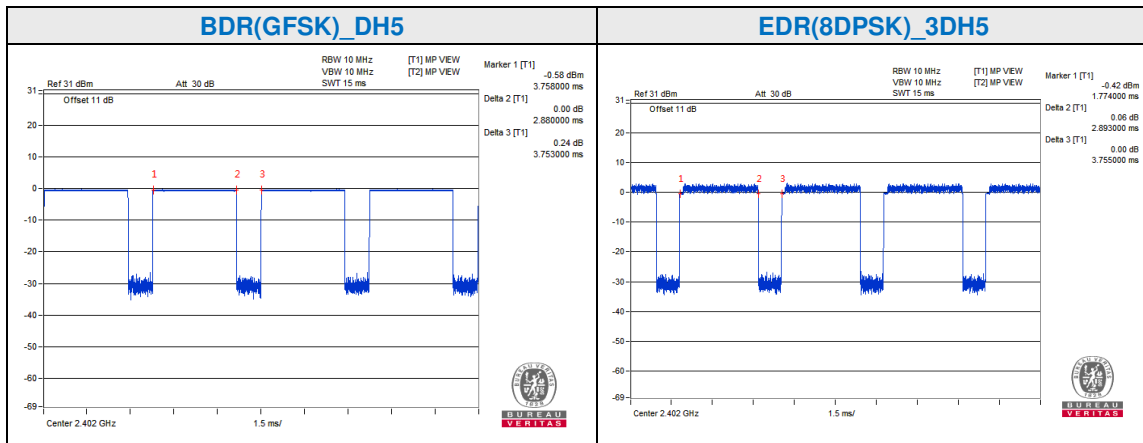

4 TEST TYPES AND RESULTS

4.1 CONDUCTED EMISSION MEASUREMENT

4.1.1 LIMITS OF CONDUCTED EMISSION MEASUREMENT

TEST STANDARD: FCC Part 15, Subpart B (Section: 15.107)

FREQUENCY (MHz)	Class A (dBuV)		Class B (dBuV)	
	Quasi-peak	Average	Quasi-peak	Average
0.15 - 0.5	79	66	66 - 56	56 - 46
0.50 - 5.0	73	60	56	46
5.0 - 30.0	73	60	60	50

- NOTES:**
- (1) The lower limit shall apply at the transition frequencies.
 - (2) The limit decreases in line with the logarithm of the frequency in the range of 0.15 to 0.50 MHz.
 - (3) All emanations from a class A/B digital device or system, including any network of conductors and apparatus connected thereto, shall not exceed the level of field strengths specified above.

4.1.2 TEST INSTRUMENTS

Equipment	Manufacturer	Model No.	Serial No.	Next Cal.
EMI Test Receiver	Rohde&Schwarz	ESR7	101494	Jan. 02, 25
Artificial Mains Network	Rohde&Schwarz	ENV216	101173	Jan. 03, 25
Artificial Mains Network	Rohde&Schwarz	ESH3-Z5	100317	Jan. 02, 25
Artificial Mains Network	SCHWARZBECK	NSLK 8122	8122-05001	Apr. 09, 25
V-LISN (CISPR 25)	SCHWARZBECK	NNBM 8124-200	8124-200 05857	Apr. 09, 25
V-LISN (CISPR 25)	SCHWARZBECK	NNBM 8124-200	8124-200 05858	Apr. 09, 25
Voltage probe	SCHWARZBECK	TK 9421	TK 9421-176	Jul. 16, 24
Coaxial RF Cable	SUHNER	RG 223/U-CE	C2310066DG	Jul. 19, 24
Test software	ADT	ADT_Conc_V7.3.7	N/A	N/A

- NOTES:**
1. The test was performed at Shielded Room 553.
 2. Equipment are calibrated by calibration laboratory accredited to ISO/IEC 17025 by a mutually recognized Accreditation.



4.1.3 TEST PROCEDURE

The basic test procedure was in accordance with ANSI C63.4:2014 amended as per ANSI C63.4a:2017.

- a. The EUT was placed 0.4 meters from the conducting wall of the shielded room with EUT being connected to the power mains through a line impedance stabilization network (LISN). Other support units were connected to the power mains through another LISN. The two LISNs provide 50 Ohm/ 50uH of coupling impedance for the measuring instrument.
- b. Both lines of the power mains connected to the EUT were checked for maximum conducted interference.
- c. The frequency range from 150 kHz to 30 MHz was searched. Emission levels under (Limit – 20dB) were not recorded.

NOTES:

1. Q.P. and AV. are abbreviations of quasi-peak and average individually.
2. "-": The Quasi-peak reading value also meets average limit and measurement with the average detector is unnecessary.
3. Margin value = Emission level - Limit value
4. Correction factor = Insertion loss + Cable loss
5. Emission Level = Correction Factor + Reading Value

4.1.4 DEVIATION FROM TEST STANDARD

No deviation.

4.1.5 TEST SETUP

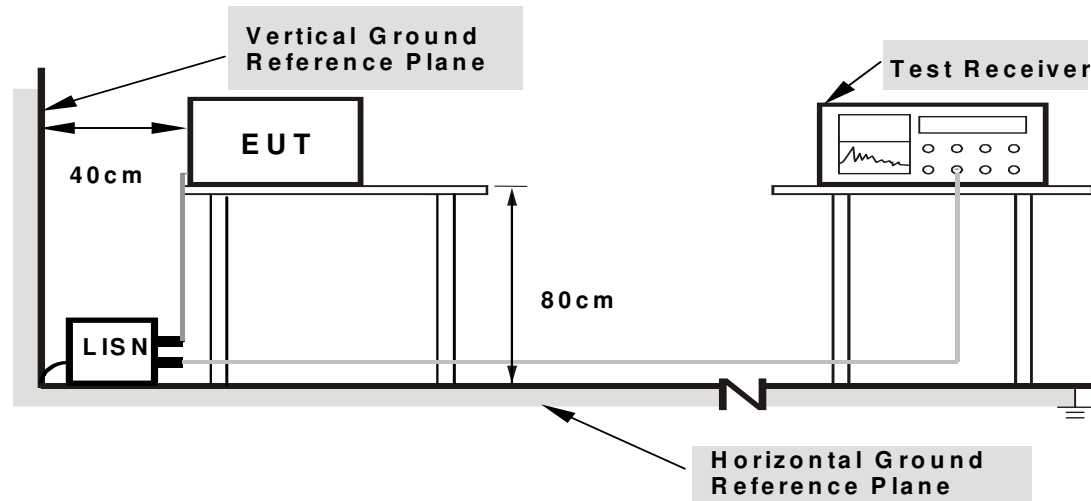

- Note:**
- 1.Support units were connected to second LISN.
 - 2.Both of LISNs (AMN) are 80cm from EUT and at least 80cm from other units and other metal planes support units.

4.1.6 EUT OPERATING CONDITIONS

- a. Turned on the power of all equipment.
- b. EUT was operated according to the type description in manufacturer's specifications or the User's Manual.

4.1.7 TEST RESULTS

CONDUCTED WORST-CASE DATA:

PHASE	Line	6dB BANDWIDTH	9kHz
--------------	------	----------------------	------

No.	Freq. [MHz]	Corr. Factor (dB)	Reading Value		Emission Level		Limit		Margin	
			[dB (uV)]		[dB (uV)]		[dB (uV)]		(dB)	
			Q.P.	AV.	Q.P.	AV.	Q.P.	AV.	Q.P.	AV.
1	0.16125	9.65	44.14	27.51	53.79	37.16	65.40	55.40	-11.61	-18.24
2	0.18267	9.70	49.82	41.26	59.52	50.96	64.36	54.36	-4.85	-3.41
3	0.20850	9.74	38.91	21.27	48.65	31.01	63.26	53.26	-14.62	-22.26
4	0.26022	9.76	36.28	24.81	46.04	34.57	61.42	51.42	-15.38	-16.85
5	0.36375	9.77	27.70	15.53	37.47	25.30	58.64	48.64	-21.18	-23.35
6	4.71241	10.03	30.10	19.79	40.13	29.82	56.00	46.00	-15.87	-16.18

REMARK: The emission levels of other frequencies were very low against the limit.

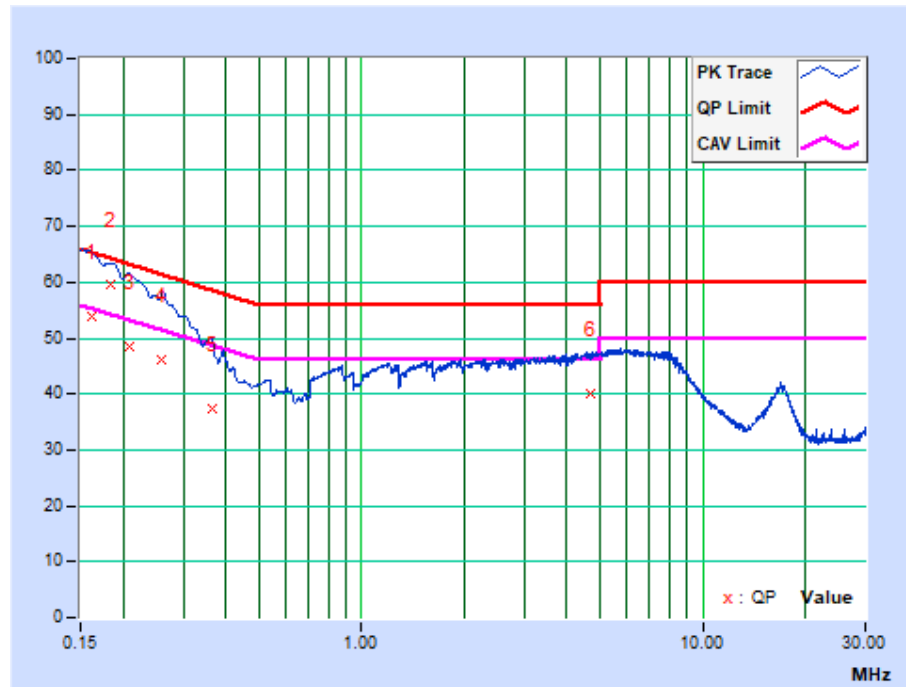

PHASE	Neutral	6dB BANDWIDTH	9kHz
--------------	---------	----------------------	------

No.	Freq. [MHz]	Corr. Factor (dB)	Reading Value		Emission Level		Limit		Margin	
			[dB (uV)]		[dB (uV)]		[dB (uV)]		(dB)	
			Q.P.	AV.	Q.P.	AV.	Q.P.	AV.	Q.P.	AV.
1	0.17838	9.41	49.30	40.90	58.71	50.31	64.56	54.56	-5.85	-4.25
2	0.22151	9.39	40.98	24.46	50.37	33.85	62.76	52.76	-12.39	-18.91
3	0.37263	9.39	29.11	16.86	38.50	26.25	58.44	48.44	-19.94	-22.19
4	2.15119	9.56	32.38	19.76	41.94	29.32	56.00	46.00	-14.06	-16.68
5	4.01775	9.65	31.29	20.31	40.94	29.96	56.00	46.00	-15.06	-16.04
6	4.94700	9.70	32.05	21.62	41.75	31.32	56.00	46.00	-14.25	-14.68

REMARK: The emission levels of other frequencies were very low against the limit.

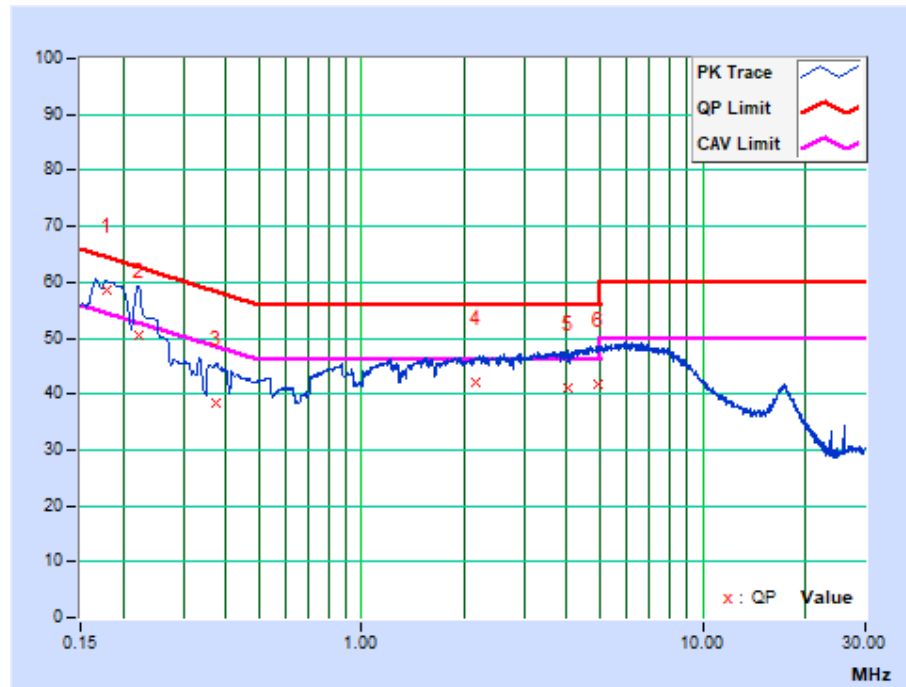

4.2. RADIATED EMISSION AND BANDEDGE MEASUREMENT

4.2.1 LIMITS OF RADIATED EMISSION AND BANDEDGE MEASUREMENT

Radiated emissions which fall in the restricted bands, as defined in Section 15.205(a), must also comply with the radiated emission limits specified in Section 15.209(a). Other emissions shall be at least 20dB below the highest level of the desired power.

FREQUENCIES (MHz)	FIELD STRENGTH (microvolts/meter)	MEASUREMENT DISTANCE (meters)
0.009 ~ 0.490	2400/F(kHz)	300
0.490 ~ 1.705	24000/F(kHz)	30
1.705 ~ 30.0	30	30
30 ~ 88	100	3
88 ~ 216	150	3
216 ~ 960	200	3
Above 960	500	3

NOTE:

1. The lower limit shall apply at the transition frequencies.
2. Emission level (dBuV/m) = 20 log Emission level (uV/m).
3. As shown in 15.35(b), for frequencies above 1000MHz, the field strength limits are based on average detector, however, the peak field strength of any emission shall not exceed the maximum permitted average limits, specified above by more than 20dB under any condition of modulation.



4.2.2 TEST INSTRUMENTS

Equipment	Manufacturer	Model No.	Serial No.	Next Cal.
EMI Test Receiver	Rohde&Schwarz	ESU40	100449	Jan. 02, 25
Signal and Spectrum Analyzer	Rohde&Schwarz	FSV7	102331	Apr. 07, 25
Active Loop Antenna (9KHz -30MHz)	SCHWARZBECK	FMZB 1519B	1519B-045	Apr. 13, 25
Amplifier (9KHz -1GHz)	Burgeon	BPA-530	100210	Feb. 21, 25
Trilog-Broadband Antenna	SCHWARZBECK	VULB 9168	9168-554	Dec. 25, 25
Horn Antenna (1GHz -18GHz)	ETS -Lindgren	3117	00085519	Oct. 12, 24
Horn Antenna (18GHz -40GHz)	SCHWARZBECK	BBHA 9170	BBHA9170242	Oct. 12, 24
3m Semi-anechoic Chamber	ETS-LINDGREN	9m*6m*6m	NSEMC003	May. 20, 25
Test Software	ADT	ADT_Radiated_V7.6.15.9.2	N/A	N/A
Broadband Preamplifier (1GHz~18GHz)	SCHWARZBECK	BBV9718	305	Apr. 24, 25
Pre-Amplifier (18GHz-40GHz)	EMCI	EMC 184045	980102	Jan. 02, 25
BLUETOOTH TESTER	Rohde&Schwarz	CBT32	100811	N/A

NOTE:

1. The test was performed in 966 Chamber.
2. Equipment are calibrated by calibration laboratory accredited to ISO/IEC 17025 by a mutually recognized Accreditation.
3. The FCC Site Registration No. is 749762.

4.2.3 TEST PROCEDURES

- a. The EUT was placed on the top of a rotating table 1.5 meters (above 1GHz) and 0.8 meters (below 1GHz) above the ground at a 3 meters semi-anechoic chamber. The table was rotated 360 degrees to determine the position of the highest radiation.
- b. The EUT was set 3 meters away from the interference-receiving antenna, which was mounted on the top of a variable-height antenna tower.
- c. For below 1GHz was used bilog antenna, and above 1GHz was used horn antenna, and its height is varied from one meter to four meters above the ground to determine the maximum value of the field strength. Both horizontal and vertical polarizations of the antenna are set to make the measurement.
- d. For each suspected emission, the EUT was arranged to its worst case and then the antenna was tuned to heights from 1 meter to 4 meters and the rotatable table was turned from 0 degrees to 360 degrees to find the maximum reading.
- e. The test-receiver system was set to Peak Detect Function and Specified Bandwidth with Maximum Hold Mode.
- f. For below 30MHz, a loop antenna with its vertical plane is placed 3m from the EUT and rotated about its vertical axis for maximum response at each azimuth about the EUT. And the centre of the loop shall be 1.3m above the ground.
- g. During the test, each emission was maximized by: having the EUT continuously working, investigated all operating modes, rotated about all 3 axis (X, Y & Z) and considered typical configuration to obtain worst position, manipulating interconnecting cables, For battery operated equipment, the equipment tests shall be performed using fresh batteries. The turntable was rotated to maximize the emission level.

NOTE:

1. The resolution bandwidth and video bandwidth of test receiver/spectrum analyzer is 120kHz for Quasi-peak detection at frequency below 1GHz.
2. The resolution bandwidth of test receiver/spectrum analyzer is 1 MHz and video bandwidth is 3MHz for Peak detection at frequency above 1GHz.
3. The resolution bandwidth of test receiver/spectrum analyzer is 1MHz and the video bandwidth is $\geq 1/T$ (Duty cycle < 98%) for Average detection (AV) at frequency above 1GHz.
4. All modes of operation were investigated and the worst-case emissions are reported.
5. The testing of the EUT was performed on all 3 orthogonal axes; the worst-case test configuration was reported on the file test setup photo.

4.2.4 DEVIATION FROM TEST STANDARD

No deviation.

4.2.5 TEST SETUP

Below 30MHz test setup

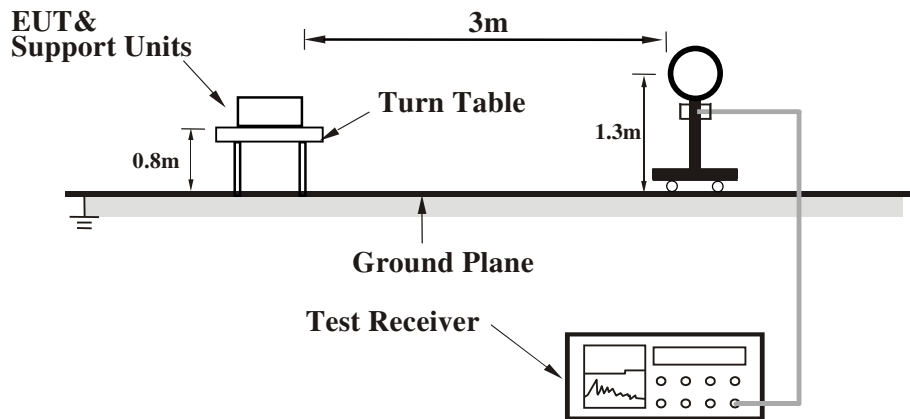

Below 1GHz test setup

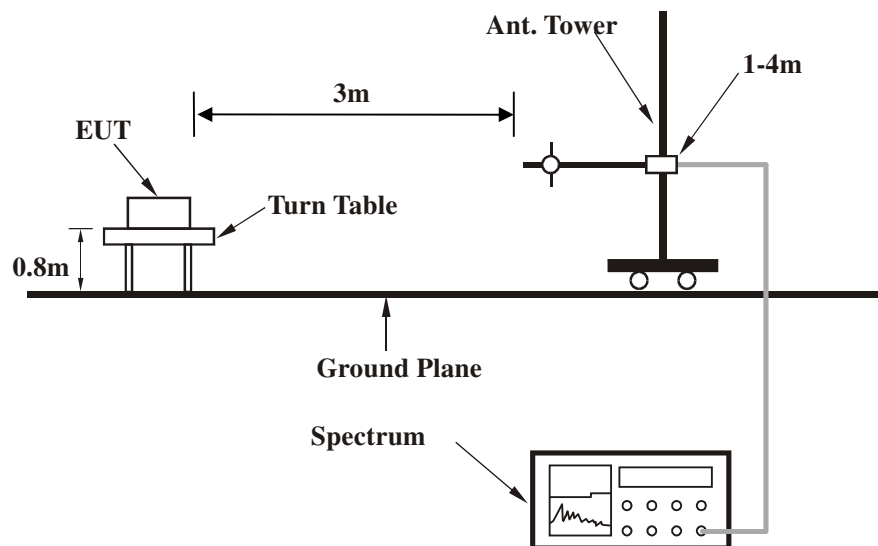

Note: For the actual test configuration, please refer to the attached file (Test Setup Photo).

Above 1GHz test setup

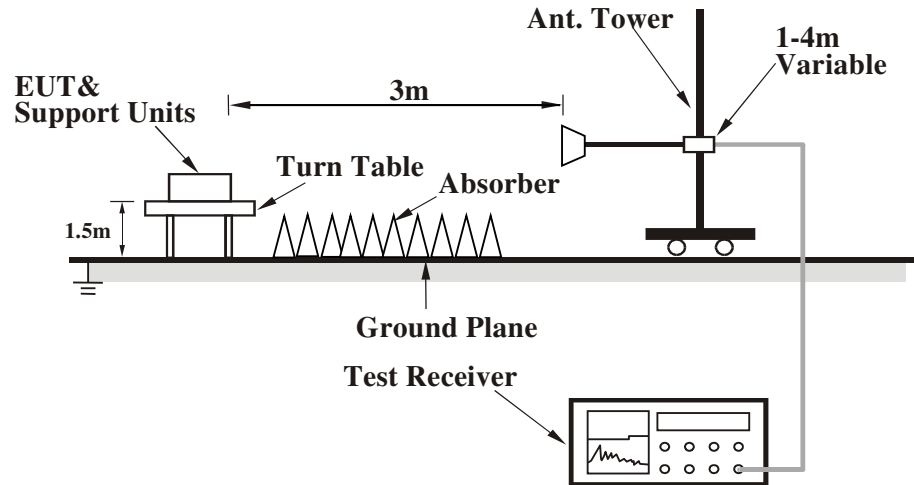

Note: For the actual test configuration, please refer to the attached file (Test Setup Photo).

4.2.6 EUT OPERATING CONDITIONS

- Set the EUT under full load condition and placed them on a testing table.
- Set the transmitter part of EUT under transmission condition continuously at specific channel frequency.
- The necessary accessories enable the EUT in full functions.

4.2.7 TEST RESULTS

BELOW 1GHz WORST-CASE DATA:

GFSK DH5

CHANNEL	Channel 39	DETECTOR FUNCTION	Quasi-Peak (QP)
FREQUENCY RANGE	9KHz ~ 1GHz		

ANTENNA POLARITY & TEST DISTANCE: HORIZONTAL AT 3 M								
NO.	FREQ. (MHz)	EMISSION LEVEL (dBuV/m)	LIMIT (dBuV/m)	MARGIN (dB)	ANTENNA HEIGHT (m)	TABLE ANGLE (Degree)	RAW VALUE (dBuV)	CORRECTIO N FACTOR (dB/m)
1	31.55	22.04 QP	40.00	-17.96	2.00 H	36	41.30	-19.26
2	126.38	23.91 QP	43.50	-19.59	2.00 H	52	43.12	-19.21
3	261.62	22.98 QP	46.00	-23.02	2.00 H	79	40.20	-17.22
4	381.31	23.42 QP	46.00	-22.58	2.00 H	97	37.23	-13.81
5	869.42	29.79 QP	46.00	-16.21	2.00 H	148	34.07	-4.28
6	950.26	33.00 QP	46.00	-13.00	2.00 H	132	36.35	-3.35

REMARKS:

1. Emission level (dBuV/m) = Raw Value (dBuV) + Correction Factor (dB/m).
2. Correction Factor (dB/m) = Antenna Factor (dB/m) + Cable Factor (dB).
3. The emission levels of other frequencies were greater than 20dB margin.
4. 9KHz~30MHz have been test and test data more than 20dB margin.
5. Margin value = Emission level – Limit value

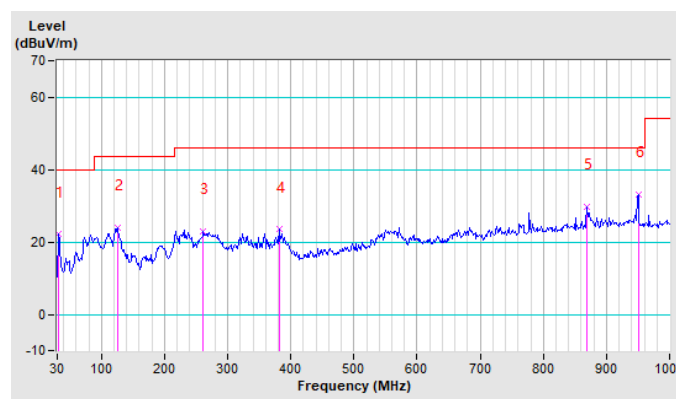

CHANNEL	Channel 39	DETECTOR FUNCTION	Quasi-Peak (QP)
FREQUENCY RANGE	9KHz ~ 1GHz		

ANTENNA POLARITY & TEST DISTANCE: VERTICAL AT 3 M								
NO.	FREQ. (MHz)	EMISSION LEVEL (dBuV/m)	LIMIT (dBuV/m)	MARGIN (dB)	ANTENNA HEIGHT (m)	TABLE ANGLE (Degree)	RAW VALUE (dBuV)	CORRECTIO N FACTOR (dB/m)
1	47.10	27.64 QP	40.00	-12.36	1.00 V	132	45.66	-18.02
2	227.42	25.33 QP	46.00	-20.67	1.00 V	109	44.06	-18.73
3	370.43	31.75 QP	46.00	-14.25	1.00 V	89	45.87	-14.12
4	595.83	35.25 QP	46.00	-10.75	1.00 V	72	43.97	-8.72
5	766.83	34.25 QP	46.00	-11.75	1.00 V	53	39.74	-5.49
6	948.70	38.29 QP	46.00	-7.71	1.00 V	34	41.64	-3.35

REMARKS:

1. Emission level (dBuV/m) = Raw Value (dBuV) + Correction Factor (dB/m).
2. Correction Factor (dB/m) = Antenna Factor (dB/m) + Cable Factor (dB).
3. The emission levels of other frequencies were greater than 20dB margin.
4. 9KHz~30MHz have been test and test data more than 20dB margin.
5. Margin value = Emission level – Limit value

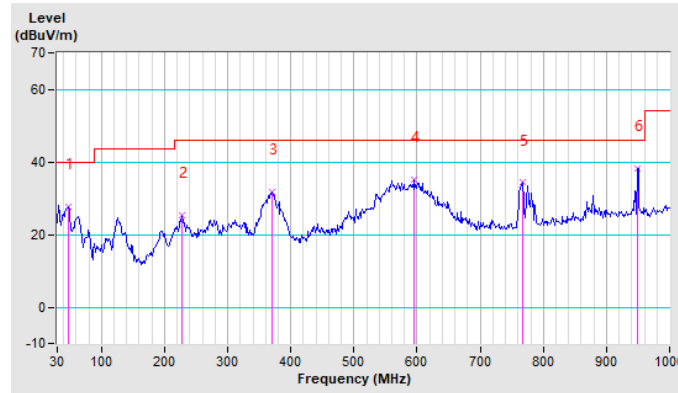



ABOVE 1GHz DATA

BT_GFSK

CHANNEL	TX Channel 0	DETECTOR FUNCTION	Peak (PK)
FREQUENCY RANGE	1GHz ~ 25GHz		Average (AV)

ANTENNA POLARITY & TEST DISTANCE : HORIZONTAL AT 3 M

NO.	FREQ. (MHz)	EMISSION LEVEL (dBuV/m)	LIMIT (dBuV/m)	MARGIN (dB)	ANTENNA HEIGHT (m)	TABLE ANGLE (Degree)	RAW VALUE (dBuV)	CORRECTION FACTOR (dB/m)
1	2390.00	45.95 PK	74.00	-28.05	1.36 H	65	42.96	2.99
2	2390.00	32.88 AV	54.00	-21.12	1.36 H	65	29.89	2.99
3	*2402.00	92.75 PK			1.33 H	65	89.74	3.01
4	*2402.00	92.36 AV			1.33 H	65	89.35	3.01
5	4804.00	52.96 PK	74.00	-21.04	2.92 H	179	45.13	7.83
6	4804.00	39.68 AV	54.00	-14.32	2.92 H	179	31.85	7.83
7	7206.00	52.69 PK	74.00	-21.31	1.54 H	55	42.36	10.33
8	7206.00	38.97 AV	54.00	-15.03	1.54 H	55	28.64	10.33

ANTENNA POLARITY & TEST DISTANCE : VERTICAL AT 3 M

NO.	FREQ. (MHz)	EMISSION LEVEL (dBuV/m)	LIMIT (dBuV/m)	MARGIN (dB)	ANTENNA HEIGHT (m)	TABLE ANGLE (Degree)	RAW VALUE (dBuV)	CORRECTION FACTOR (dB/m)
1	2390.00	43.41 PK	74.00	-30.59	1.02 V	254	40.42	2.99
2	2390.00	32.22 AV	54.00	-21.78	1.02 V	254	29.23	2.99
3	*2402.00	88.35 PK			1.02 V	254	85.34	3.01
4	*2402.00	88.03 AV			1.02 V	254	85.02	3.01
5	4804.00	50.52 PK	74.00	-23.48	1.35 V	5	42.69	7.83
6	4804.00	38.11 AV	54.00	-15.89	1.35 V	5	30.28	7.83
7	7206.00	51.20 PK	74.00	-22.80	1.36 V	6	40.87	10.33
8	7206.00	38.26 AV	54.00	-15.74	1.36 V	6	27.93	10.33

REMARKS:

1. Emission level (dBuV/m) = Raw Value (dBuV) + Correction Factor (dB/m).
2. Correction Factor (dB/m) = Antenna Factor (dB/m) + Cable Factor (dB).
3. The emission levels of other frequencies were greater than 20dB margin.
4. Margin value = Emission level – Limit value.
5. " * ": Fundamental frequency.



Test Report No.: RF2403WDG0245

CHANNEL	TX Channel 39	DETECTOR FUNCTION	Peak (PK)
FREQUENCY RANGE	1GHz ~ 25GHz		Average (AV)

ANTENNA POLARITY & TEST DISTANCE : HORIZONTAL AT 3 M								
NO.	FREQ. (MHz)	EMISSION LEVEL (dBuV/m)	LIMIT (dBuV/m)	MARGIN (dB)	ANTENNA HEIGHT (m)	TABLE ANGLE (Degree)	RAW VALUE (dBuV)	CORRECTION FACTOR (dB/m)
1	*2441.00	92.87 PK			1.33 H	12	89.78	3.09
2	*2441.00	92.40 AV			1.33 H	12	89.31	3.09
3	4882.00	51.35 PK	74.00	-22.65	1.03 H	55	43.33	8.02
4	4882.00	41.20 AV	54.00	-12.80	1.03 H	55	33.18	8.02
5	7323.00	51.35 PK	74.00	-22.65	1.06 H	5	40.61	10.74
6	7323.00	40.28 AV	54.00	-13.72	1.06 H	5	29.54	10.74
ANTENNA POLARITY & TEST DISTANCE : VERTICAL AT 3 M								
NO.	FREQ. (MHz)	EMISSION LEVEL (dBuV/m)	LIMIT (dBuV/m)	MARGIN (dB)	ANTENNA HEIGHT (m)	TABLE ANGLE (Degree)	RAW VALUE (dBuV)	CORRECTION FACTOR (dB/m)
1	*2441.00	88.36 PK			1.36 V	6	85.27	3.09
2	*2441.00	88.01 AV			1.36 V	6	84.92	3.09
3	4882.00	50.36 PK	74.00	-23.64	1.35 V	35	42.34	8.02
4	4882.00	38.29 AV	54.00	-15.71	1.35 V	35	30.27	8.02
5	7323.00	51.25 PK	74.00	-22.75	1.54 V	44	40.51	10.74
6	7323.00	39.20 AV	54.00	-14.80	1.54 V	44	28.46	10.74

REMARKS:

1. Emission level (dBuV/m) = Raw Value (dBuV) + Correction Factor (dB/m).
2. Correction Factor (dB/m) = Antenna Factor (dB/m) + Cable Factor (dB).
3. The emission levels of other frequencies were greater than 20dB margin.
4. Margin value = Emission level – Limit value.
5. " * " : Fundamental frequency.

Bureau Veritas Shenzhen Co., Ltd.
Dongguan Branch

No. 96, Guantai Road (Houjie Section), Houjie
Town, Dongguan City, Guangdong Province.
523942. People's Republic of China.

Tel: +86 769 8998 2098
Fax: +86 769 8593 1080
Email: customerservice.dg@bureauveritas.com



Test Report No.: RF2403WDG0245

CHANNEL	TX Channel 78	DETECTOR FUNCTION	Peak (PK)
FREQUENCY RANGE	1GHz ~ 25GHz		Average (AV)

ANTENNA POLARITY & TEST DISTANCE : HORIZONTAL AT 3 M

NO.	FREQ. (MHz)	EMISSION LEVEL (dBuV/m)	LIMIT (dBuV/m)	MARGIN (dB)	ANTENNA HEIGHT (m)	TABLE ANGLE (Degree)	RAW VALUE (dBuV)	CORRECTION FACTOR (dB/m)
1	*2480.00	88.25 PK			3.00 H	18	85.08	3.17
2	*2480.00	87.51 AV			3.00 H	18	84.34	3.17
3	2483.50	47.96 PK	74.00	-26.04	3.00 H	18	44.79	3.17
4	2483.50	40.59 AV	54.00	-13.41	3.00 H	18	37.42	3.17
5	4960.00	51.26 PK	74.00	-22.74	1.03 H	55	43.05	8.21
6	4960.00	41.25 AV	54.00	-12.75	1.03 H	55	33.04	8.21
7	7440.00	51.35 PK	74.00	-22.65	1.65 H	44	40.22	11.13
8	7440.00	41.25 AV	54.00	-12.75	1.65 H	44	30.12	11.13

ANTENNA POLARITY & TEST DISTANCE : VERTICAL AT 3 M

NO.	FREQ. (MHz)	EMISSION LEVEL (dBuV/m)	LIMIT (dBuV/m)	MARGIN (dB)	ANTENNA HEIGHT (m)	TABLE ANGLE (Degree)	RAW VALUE (dBuV)	CORRECTION FACTOR (dB/m)
1	*2480.00	84.32 PK			2.95 V	143	81.15	3.17
2	*2480.00	83.99 AV			2.95 V	143	80.82	3.17
3	2483.50	46.61 PK	74.00	-27.39	2.95 V	143	43.44	3.17
4	2483.50	39.38 AV	54.00	-14.62	2.95 V	143	36.21	3.17
5	4960.00	50.20 PK	74.00	-23.80	1.35 V	95	41.99	8.21
6	4960.00	38.79 AV	54.00	-15.21	1.35 V	95	30.58	8.21
7	7440.00	51.35 PK	74.00	-22.65	2.35 V	26	40.22	11.13
8	7440.00	40.32 AV	54.00	-13.68	2.35 V	26	29.19	11.13

REMARKS:

1. Emission level (dBuV/m) = Raw Value (dBuV) + Correction Factor (dB/m).
2. Correction Factor (dB/m) = Antenna Factor (dB/m) + Cable Factor (dB).
3. The emission levels of other frequencies were greater than 20dB margin.
4. Margin value = Emission level – Limit value.
5. " * " : Fundamental frequency.



BUREAU VERITAS

Test Report No.: RF2403WDG0245

BT_8DPSK

CHANNEL	TX Channel 0	DETECTOR FUNCTION	Peak (PK)
FREQUENCY RANGE	1GHz ~ 25GHz		Average (AV)

ANTENNA POLARITY & TEST DISTANCE : HORIZONTAL AT 3 M

NO.	FREQ. (MHz)	EMISSION LEVEL (dBuV/m)	LIMIT (dBuV/m)	MARGIN (dB)	ANTENNA HEIGHT (m)	TABLE ANGLE (Degree)	RAW VALUE (dBuV)	CORRECTION FACTOR (dB/m)
1	2390.00	43.00 PK	74.00	-31.00	3.08 H	59	40.01	2.99
2	2390.00	32.32 AV	54.00	-21.68	3.08 H	59	29.33	2.99
3	*2402.00	92.71 PK			3.08 H	59	89.70	3.01
4	*2402.00	88.71 AV			3.08 H	59	85.70	3.01
5	4804.00	50.79 PK	74.00	-23.21	1.15 H	55	42.96	7.83
6	4804.00	38.26 AV	54.00	-15.74	1.15 H	55	30.43	7.83
7	7206.00	49.53 PK	74.00	-24.47	2.35 H	15	39.20	10.33
8	7206.00	38.49 AV	54.00	-15.51	2.35 H	15	28.16	10.33

ANTENNA POLARITY & TEST DISTANCE : VERTICAL AT 3 M

NO.	FREQ. (MHz)	EMISSION LEVEL (dBuV/m)	LIMIT (dBuV/m)	MARGIN (dB)	ANTENNA HEIGHT (m)	TABLE ANGLE (Degree)	RAW VALUE (dBuV)	CORRECTION FACTOR (dB/m)
1	2390.00	44.47 PK	74.00	-29.53	2.53 V	55	41.48	2.99
2	2390.00	32.00 AV	54.00	-22.00	2.53 V	32	29.01	2.99
3	*2402.00	90.27 PK			2.53 V	32	87.26	3.01
4	*2402.00	86.36 AV			2.53 V	32	83.35	3.01
5	4804.00	49.17 PK	74.00	-24.83	1.00 V	55	41.34	7.83
6	4804.00	38.26 AV	54.00	-15.74	1.00 V	55	30.43	7.83
7	7206.00	51.20 PK	74.00	-22.80	1.00 V	55	40.87	10.33
8	7206.00	39.20 AV	54.00	-14.80	1.00 V	55	28.87	10.33

REMARKS:

1. Emission level (dBuV/m) = Raw Value (dBuV) + Correction Factor (dB/m).
2. Correction Factor (dB/m) = Antenna Factor (dB/m) + Cable Factor (dB).
3. The emission levels of other frequencies were greater than 20dB margin.
4. Margin value = Emission level – Limit value.
5. " * ": Fundamental frequency.

Bureau Veritas Shenzhen Co., Ltd.
Dongguan Branch

No. 96, Guantai Road (Houjie Section), Houjie Town, Dongguan City, Guangdong Province. 523942. People's Republic of China.

Tel: +86 769 8998 2098
Fax: +86 769 8593 1080
Email: customerservice.dg@bureauveritas.com



Test Report No.: RF2403WDG0245

CHANNEL	TX Channel 39	DETECTOR FUNCTION	Peak (PK)
FREQUENCY RANGE	1GHz ~ 25GHz		Average (AV)

ANTENNA POLARITY & TEST DISTANCE : HORIZONTAL AT 3 M

NO.	FREQ. (MHz)	EMISSION LEVEL (dBuV/m)	LIMIT (dBuV/m)	MARGIN (dB)	ANTENNA HEIGHT (m)	TABLE ANGLE (Degree)	RAW VALUE (dBuV)	CORRECTION FACTOR (dB/m)
1	*2441.00	92.39 PK			1.35 H	44	89.30	3.09
2	*2441.00	88.65 AV			1.35 H	44	85.56	3.09
3	4882.00	51.37 PK	74.00	-22.63	1.35 H	135	43.35	8.02
4	4882.00	38.98 AV	54.00	-15.02	1.35 H	135	30.96	8.02
5	7323.00	51.89 PK	74.00	-22.11	1.40 H	66	41.15	10.74
6	7323.00	39.78 AV	54.00	-14.22	1.40 H	66	29.04	10.74

ANTENNA POLARITY & TEST DISTANCE : VERTICAL AT 3 M

NO.	FREQ. (MHz)	EMISSION LEVEL (dBuV/m)	LIMIT (dBuV/m)	MARGIN (dB)	ANTENNA HEIGHT (m)	TABLE ANGLE (Degree)	RAW VALUE (dBuV)	CORRECTION FACTOR (dB/m)
1	*2441.00	89.97 PK			1.03 V	2	86.88	3.09
2	*2441.00	85.12 AV			1.03 V	2	82.03	3.09
3	4882.00	52.30 PK	74.00	-21.70	1.34 V	66	44.28	8.02
4	4882.00	41.25 AV	54.00	-12.75	1.34 V	66	33.23	8.02
5	7323.00	51.06 PK	74.00	-22.94	2.01 V	5	40.32	10.74
6	7323.00	40.20 AV	54.00	-13.80	2.01 V	5	29.46	10.74

REMARKS:

1. Emission level (dBuV/m) = Raw Value (dBuV) + Correction Factor (dB/m).
2. Correction Factor (dB/m) = Antenna Factor (dB/m) + Cable Factor (dB).
3. The emission levels of other frequencies were greater than 20dB margin.
4. Margin value = Emission level – Limit value.
5. " * ": Fundamental frequency.



Test Report No.: RF2403WDG0245

CHANNEL	TX Channel 78	DETECTOR FUNCTION	Peak (PK)
FREQUENCY RANGE	1GHz ~ 25GHz		Average (AV)

ANTENNA POLARITY & TEST DISTANCE : HORIZONTAL AT 3 M

NO.	FREQ. (MHz)	EMISSION LEVEL (dBuV/m)	LIMIT (dBuV/m)	MARGIN (dB)	ANTENNA HEIGHT (m)	TABLE ANGLE (Degree)	RAW VALUE (dBuV)	CORRECTION FACTOR (dB/m)
1	*2480.00	88.63 PK			3.00 H	18	85.46	3.17
2	*2480.00	83.74 AV			3.00 H	18	80.57	3.17
3	2483.50	47.19 PK	74.00	-26.81	3.00 H	18	44.02	3.17
4	2483.50	38.79 AV	54.00	-15.21	3.00 H	18	35.62	3.17
5	4960.00	51.20 PK	74.00	-22.80	1.35 H	2	42.99	8.21
6	4960.00	39.78 AV	54.00	-14.22	1.35 H	2	31.57	8.21
7	7440.00	52.60 PK	74.00	-21.40	1.47 H	88	41.47	11.13
8	7440.00	38.20 AV	54.00	-15.80	1.47 H	88	27.07	11.13

ANTENNA POLARITY & TEST DISTANCE : VERTICAL AT 3 M

NO.	FREQ. (MHz)	EMISSION LEVEL (dBuV/m)	LIMIT (dBuV/m)	MARGIN (dB)	ANTENNA HEIGHT (m)	TABLE ANGLE (Degree)	RAW VALUE (dBuV)	CORRECTION FACTOR (dB/m)
1	*2480.00	82.13 PK			1.90 V	221	78.96	3.17
2	*2480.00	77.89 AV			1.90 V	221	74.72	3.17
3	2483.50	44.35 PK	74.00	-29.65	1.90 V	221	41.18	3.17
4	2483.50	34.99 AV	54.00	-19.01	1.90 V	221	31.82	3.17
5	4960.00	51.35 PK	74.00	-22.65	1.35 V	166	43.14	8.21
6	4960.00	41.20 AV	54.00	-12.80	1.35 V	166	32.99	8.21
7	7440.00	51.60 PK	74.00	-22.40	1.05 V	5	40.47	11.13
8	7440.00	40.50 AV	54.00	-13.50	1.05 V	5	29.37	11.13

REMARKS:

1. Emission level (dBuV/m) = Raw Value (dBuV) + Correction Factor (dB/m).
2. Correction Factor (dB/m) = Antenna Factor (dB/m) + Cable Factor (dB).
3. The emission levels of other frequencies were greater than 20dB margin.
4. Margin value = Emission level – Limit value.
5. " * " : Fundamental frequency.

4.3 NUMBER OF HOPPING FREQUENCY USED

4.3.1 LIMIT OF HOPPING FREQUENCY USED

At least 15 channels frequencies, and should be equally spaced.

4.3.2 TEST SETUP

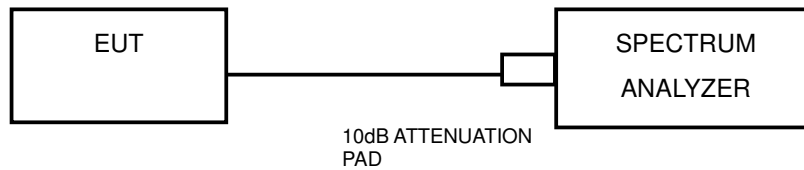

4.3.3 TEST INSTRUMENTS

Equipment	Manufacturer	Model No.	Serial No.	Next Cal.
Power Sensor	Keysight	U2021XA	MY57320002	May. 11, 25
Power Meter	Anritsu	ML2495A	1139001	Jul. 11, 24
Power Sensor	Anritsu	MA2411B	1531155	Jul. 11, 24
Digital Multimeter	FLUKE	15B	A1220010DG	N/A
Humid & Temp Programmable Tester	Haida	HD-225T	110807201	Oct. 15, 24
Oscilloscope	Agilent	DSO9254A	MY51260160	Jul. 11, 24
Signal and Spectrum Analyzer	Rohde&Schwarz	FSV40	101094	Jan. 01, 25
Signal Generator	Agilent	N5183A	MY50140980	Jul. 23, 24
MXG-B RF Vector Signal Generator	Keysight	N5182B	MY56200288	Jul. 11, 24
BLUETOOTH TESTER	Rohde&Schwarz	CBT32	100811	N/A
Attenuator	MINI	BW-S10W2+	S130129FGE2	N/A
DC Source	Keysight	E3642A	MY56146098	N/A
Test software	ADT	ADT_RF Test Software V6.6.5.3	N/A	N/A

NOTE:

1. The test was performed in RF Oven room.
2. Equipment are calibrated by calibration laboratory accredited to ISO/IEC 17025 by a mutually recognized Accreditation.



4.3.4 TEST PROCEDURES

- a. Check the calibration of the measuring instrument (SA) using either an internal calibrator or a known signal from an external generator.
- b. Turn on the EUT and connect its antenna terminal to measurement via a low loss cable. Then set it to any one measured frequency within its operating range and make sure the instrument is operated in its linear range.
- c. Set the SA on MaxHold Mode, and then keep the EUT in hopping mode. Record all the signals from each channel until each one has been recorded.
- d. Set the SA on View mode and then plot the result on SA screen.
- e. Repeat above procedures until all frequencies measured were completed.

4.3.5 DEVIATION FROM TEST STANDARD

No deviation.

4.3.6 TEST RESULTS

There are 79 hopping frequencies in the hopping mode. Please refer to next two pages for the test result. On the plots, it shows that the hopping frequencies are equally spaced.



Test Report No.: RF2403WDG0245

GFSK

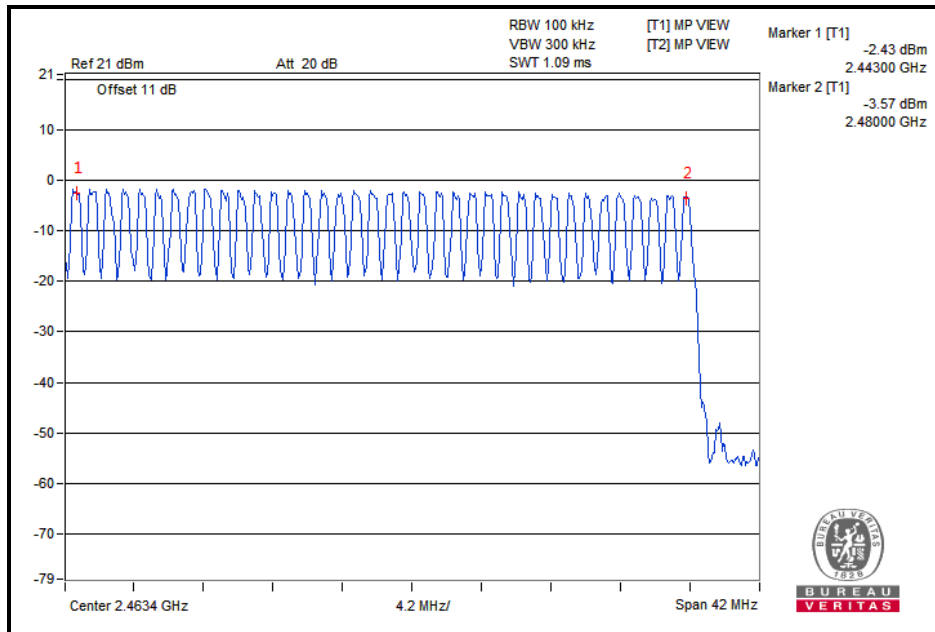
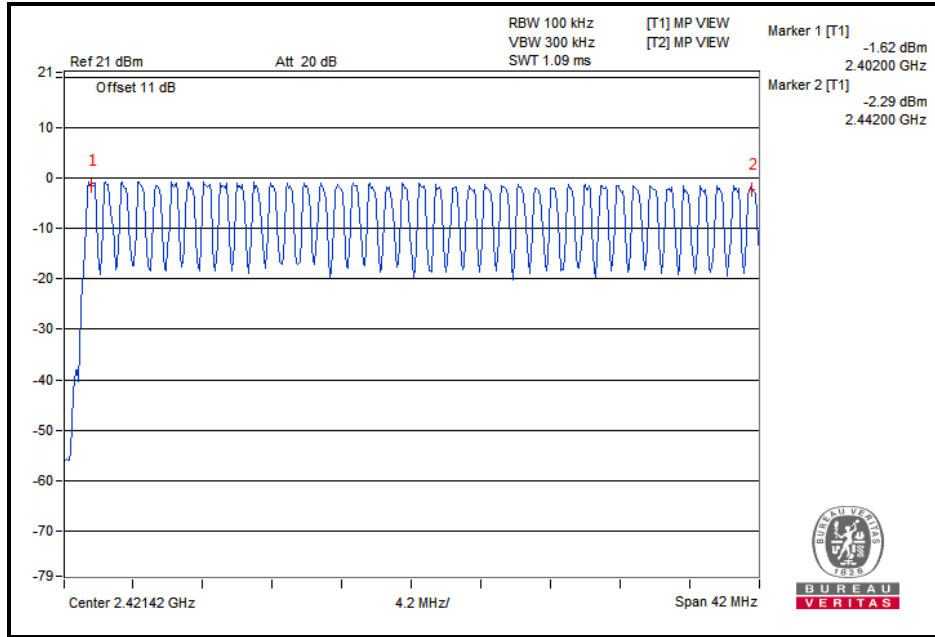

Bureau Veritas Shenzhen Co., Ltd.
Dongguan Branch

No. 96, Guantai Road (Houjie Section), Houjie
Town, Dongguan City, Guangdong Province.
523942. People's Republic of China.

Tel: +86 769 8998 2098
Fax: +86 769 8593 1080
Email: customerservice.dg@bureauveritas.com



Test Report No.: RF2403WDG0245

8DPSK

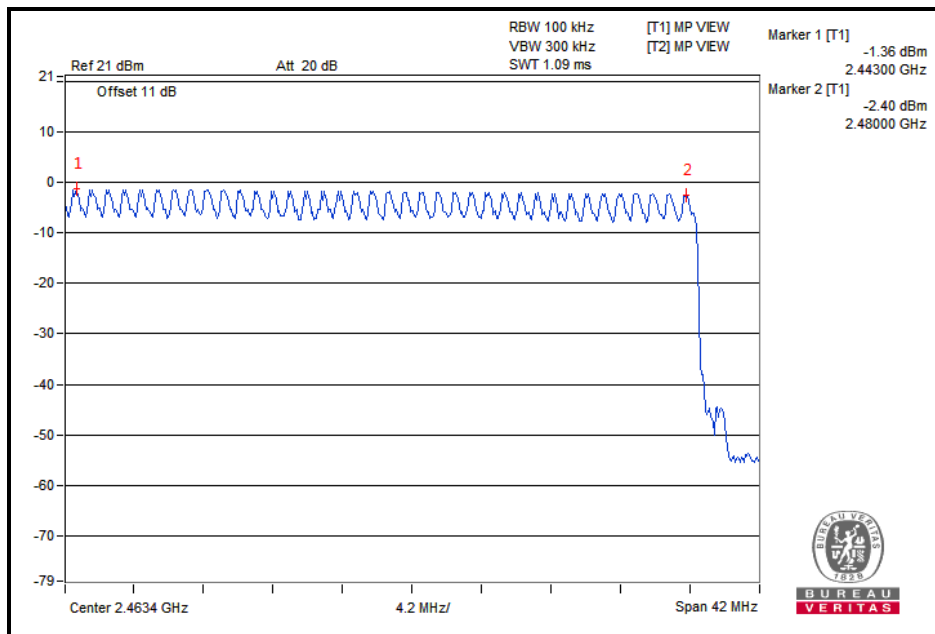
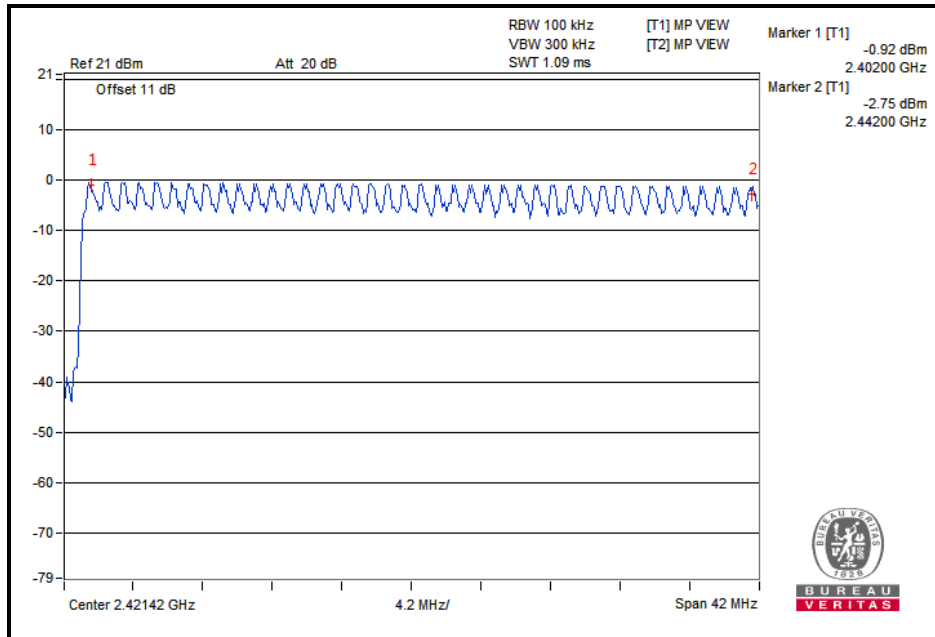

Bureau Veritas Shenzhen Co., Ltd.
Dongguan Branch

No. 96, Guantai Road (Houjie Section), Houjie
Town, Dongguan City, Guangdong Province.
523942. People's Republic of China.

Tel: +86 769 8998 2098
Fax: +86 769 8593 1080
Email: customerservice.dg@bureauveritas.com

4.4 DWELL TIME ON EACH CHANNEL

4.4.1 LIMIT OF DWELL TIME USED

The average time of occupancy on any channel shall not be greater than 0.4 seconds within a period of 0.4 seconds multiplied by the number of hopping channels employed.

4.4.2 TEST SETUP

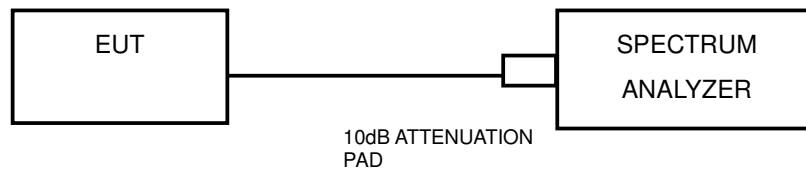

4.4.3 TEST INSTRUMENTS

Refer to section 4.3.3 to get information of above instrument.

4.4.4 TEST PROCEDURES

- a. Check the calibration of the measuring instrument (SA) using either an internal calibrator or a known signal from an external generator.
- b. Turn on the EUT and connect its antenna terminal to measurement via a low loss cable. Then set it to any one measured frequency within its operating range and make sure the instrument is operated in its linear range.
- c. Adjust the center frequency of SA on any frequency be measured and set SA to zero span mode. And then, set RBW and VBW of spectrum analyzer to proper value.
- d. Measure the time duration of one transmission on the measured frequency. And then plot the result with time difference of this time duration.
- e. Repeat above procedures until all different time-slot modes have been completed.



4.4.5 DEVIATION FROM TEST STANDARD

No deviation.

4.4.6 TEST RESULTS

GFSK

Mode	Number of Hopping Channel	Number of transmission in a period(channel number*0.4 sec)				Length of transmission time (msec)	Result (msec)	Limit (msec)	PASS / FAIL
		period (sec)	sweep time (sec)	times in a sweep	times in a period				
DH1	79	31.6	5	47	297.04	0.480	142.58	400	PASS
DH3	79	31.6	5	26	164.32	1.710	280.99	400	PASS
DH5	79	31.6	5	17	107.44	2.976	319.74	400	PASS

8DPSK

Mode	Number of Hopping Channel	Number of transmission in a period(channel number*0.4 sec)				Length of transmission time (msec)	Result (msec)	Limit (msec)	PASS / FAIL
		period (sec)	sweep time (sec)	times in a sweep	times in a period				
3DH1	79	31.6	5	50	316	0.480	151.68	400	PASS
3DH3	79	31.6	5	25	158	1.740	274.92	400	PASS
3DH5	79	31.6	5	18	113.76	3.088	351.29	400	PASS

NOTE: Test plots of the transmitting time slot are shown on next page.

GFSK



8DPSK



4.5 CHANNEL BANDWIDTH

4.5.1 LIMITS OF CHANNEL BANDWIDTH

For frequency hopping system operating in the 2400-2483.5MHz, If the 20dB bandwidth of hopping channel is greater than 25kHz, two-thirds 20dB bandwidth of hopping channel shall be a minimum limit for the hopping channel separation.

4.5.2 TEST SETUP

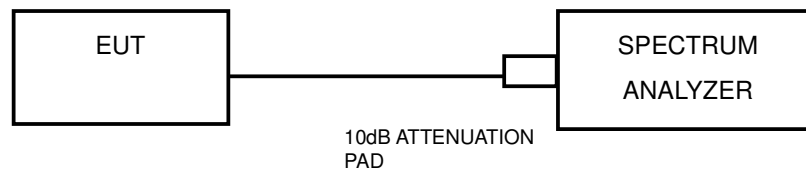

4.5.3 TEST INSTRUMENTS

Refer to section 4.3.3 to get information of above instrument.

4.5.4 TEST PROCEDURE

- a. Check the calibration of the measuring instrument using either an internal calibrator or a known signal from an external generator.
- b. Turn on the EUT and connect it to measurement instrument. Then set it to any one convenient frequency within its operating range. Set a reference level on the measuring instrument equal to the highest peak value.
- c. Measure the frequency difference of two frequencies that were attenuated 20dB from the reference level. Record the frequency difference as the emission bandwidth.
- d. Repeat above procedures until all frequencies measured were complete.

4.5.5 DEVIATION FROM TEST STANDARD

No deviation.

4.5.6 EUT OPERATING CONDITION

The software provided by client to enable the EUT under transmission condition continuously at lowest, middle and highest channel frequencies individually.

4.5.7 TEST RESULTS

GFSK

CHANNEL	CHANNEL FREQUENCY (MHz)	20dB BANDWIDTH (MHz)
0	2402	0.95
39	2441	0.95
78	2480	0.95

CH 0

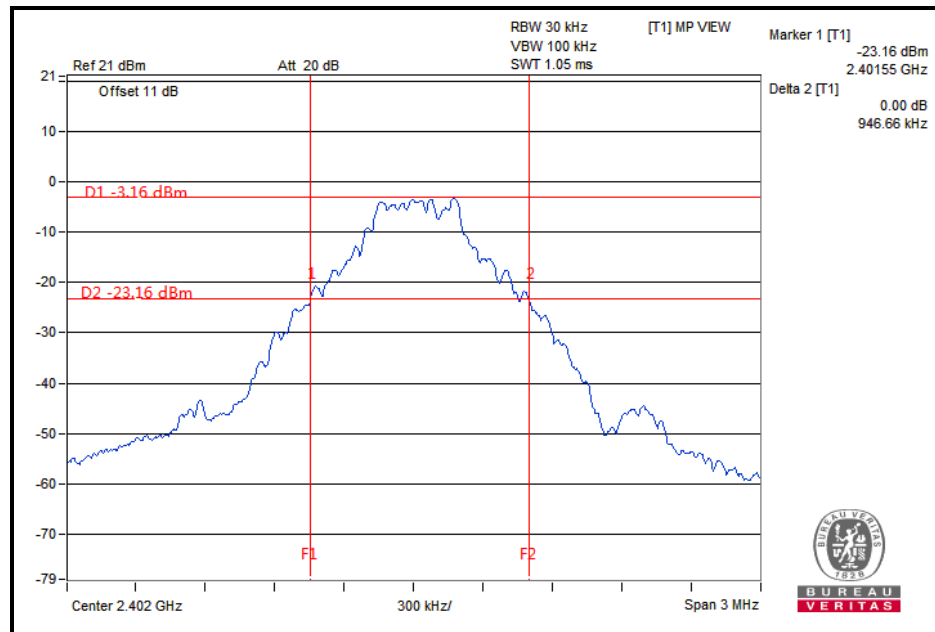

CH 39

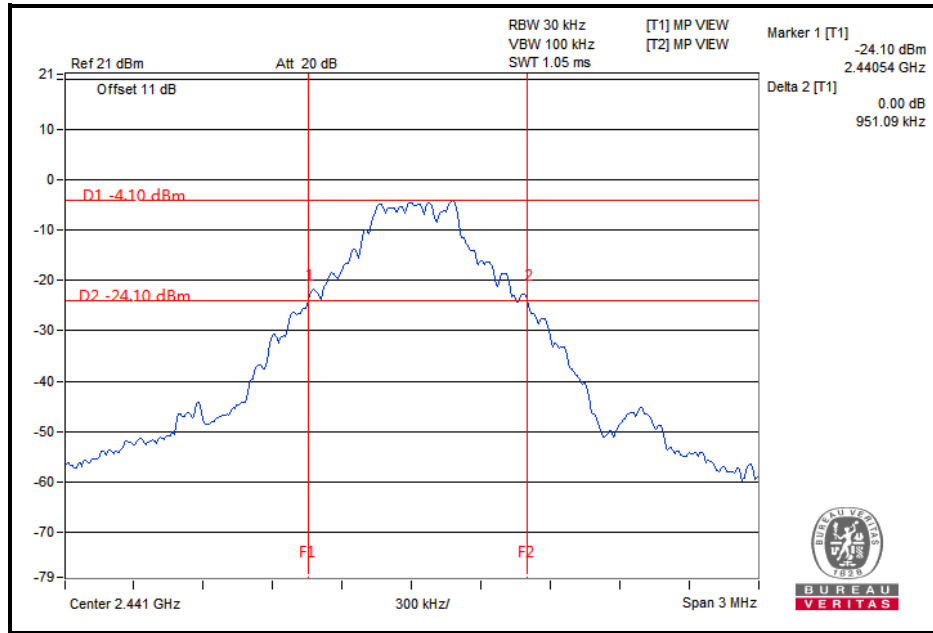

CH 78

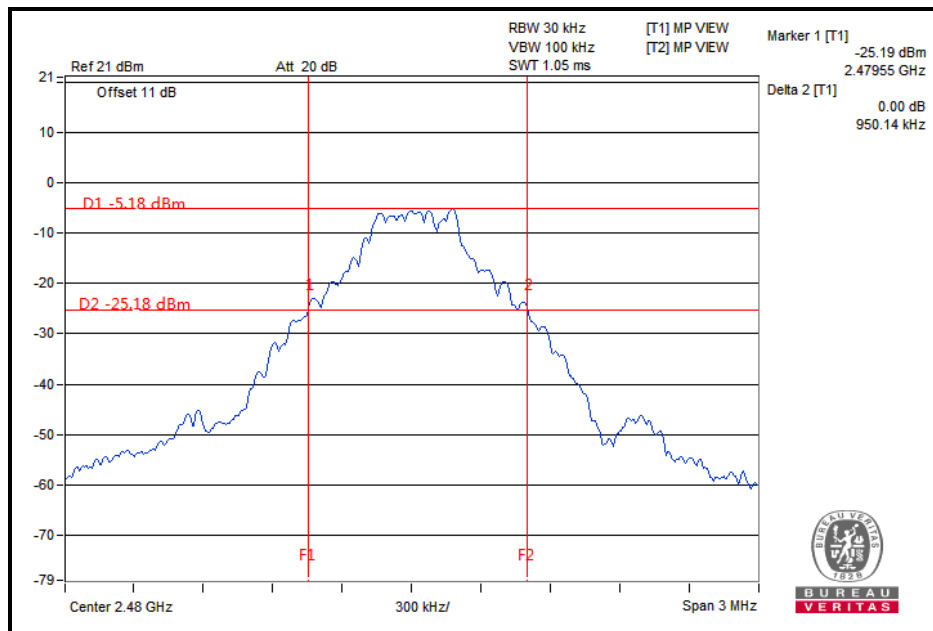

8DPSK

CHANNEL	CHANNEL FREQUENCY (MHz)	20dB BANDWIDTH (MHz)
0	2402	1.29
39	2441	1.29
78	2480	1.29

CH 0

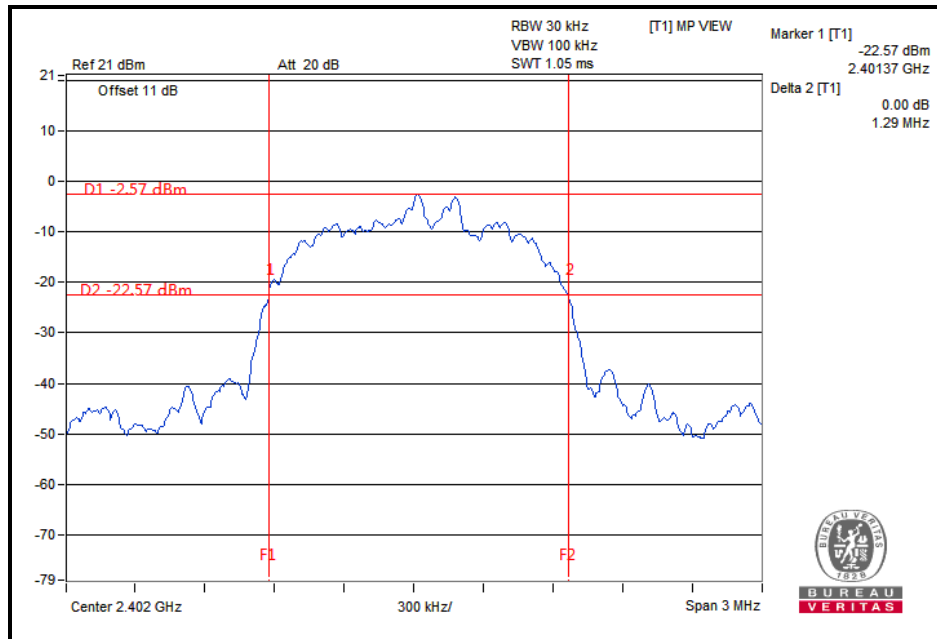

CH 39

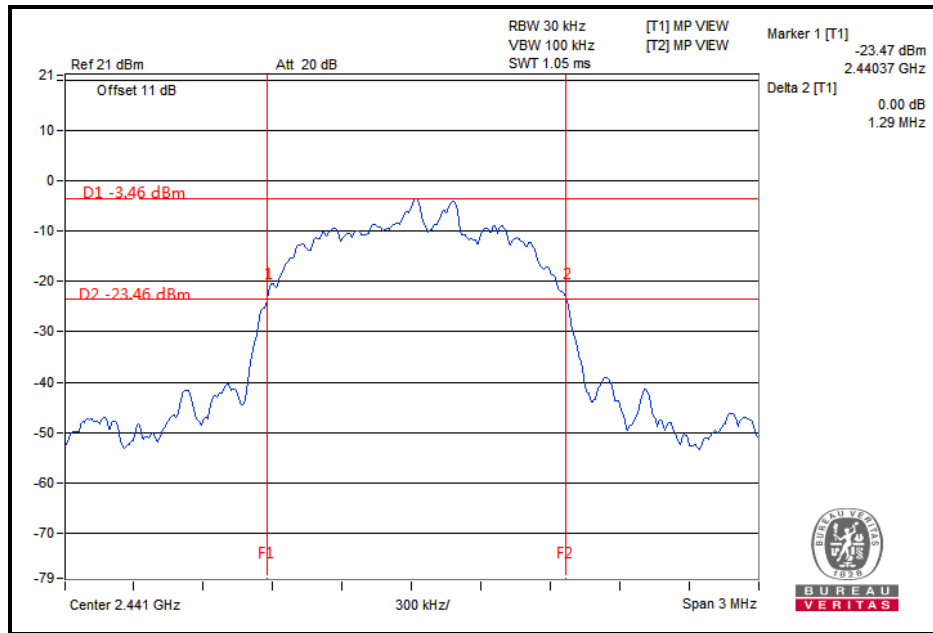

CH 78

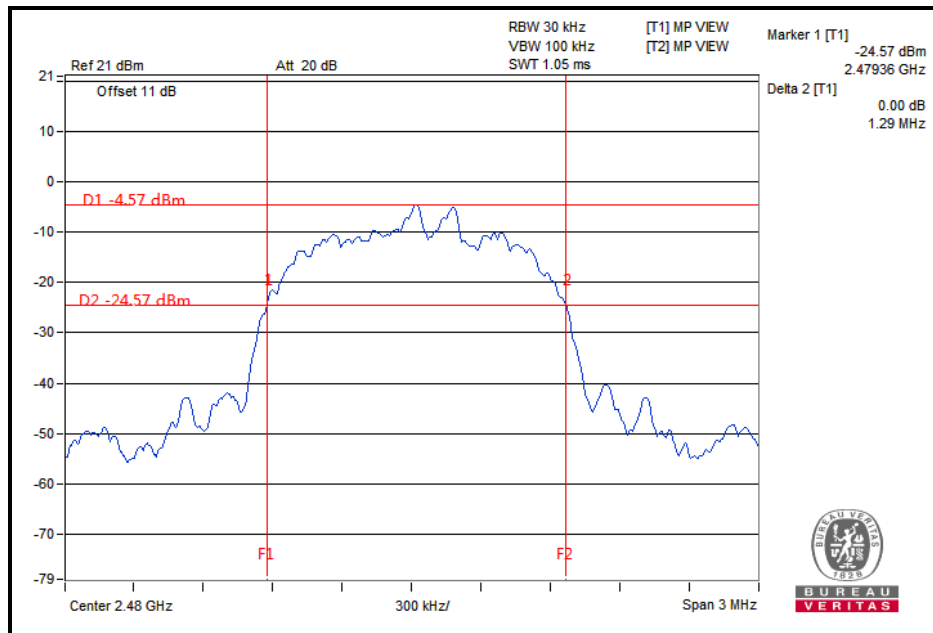

4.6 HOPPING CHANNEL SEPARATION

4.6.1 LIMIT OF HOPPING CHANNEL SEPARATION

At least 25kHz or two-third of 20dB hopping channel bandwidth (whichever is greater).

4.6.2 TEST SETUP

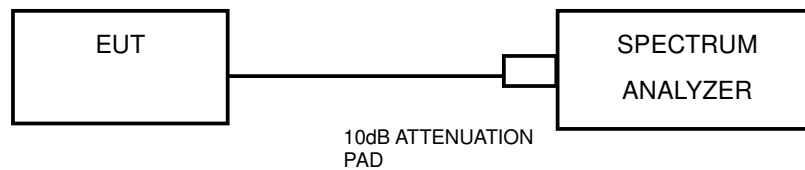

4.6.3 TEST INSTRUMENTS

Refer to section 4.3.3 to get information of above instrument.

4.6.4 TEST PROCEDURES

1. Check the calibration of the measuring instrument using either an internal calibrator or a known signal from an external generator.
2. Turn on the EUT and connect it to measurement instrument. Then set it to any one convenient frequency within its operating range.
3. By using the MaxHold function record the separation of two adjacent channels.
4. Measure the frequency difference of these two adjacent channels by SA MARK function. And then plot the result on SA screen.
5. Repeat above procedures until all frequencies measured were complete.

4.6.5 DEVIATION FROM TEST STANDARD

No deviation.

4.6.6 TEST RESULTS

GFSK

CHANNEL	FREQUENCY (MHz)	ADJACENT CHANNEL SEPARATION (MHz)	20dB BANDWIDTH (MHz)	MINIMUM LIMIT (MHz)	PASS / FAIL
0	2402	1.00	0.95	0.63	PASS
39	2441	1.00	0.95	0.64	PASS
78	2480	1.00	0.95	0.64	PASS

NOTE: The minimum limit is two-third 20dB bandwidth.

CH 0

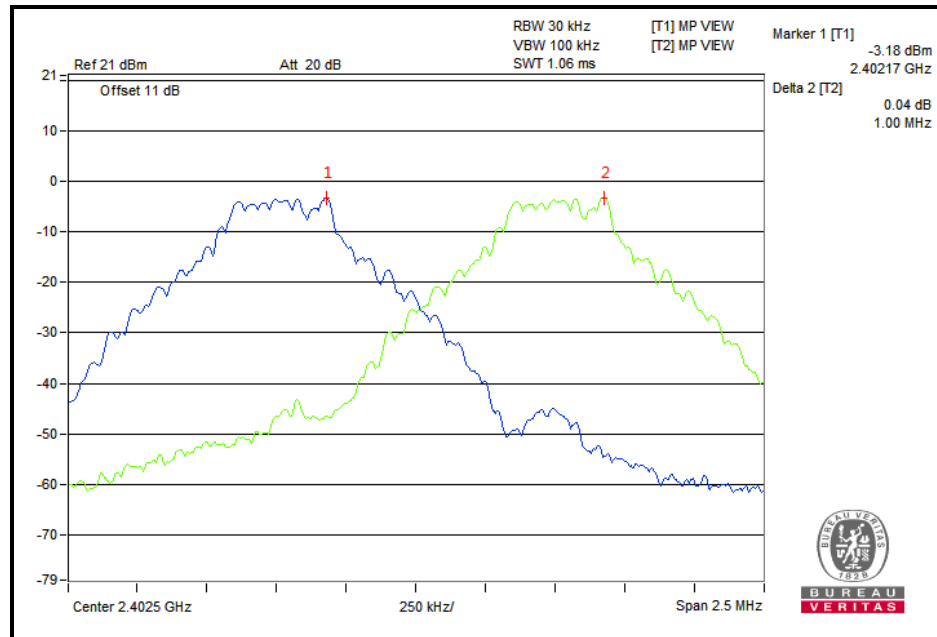

CH 39

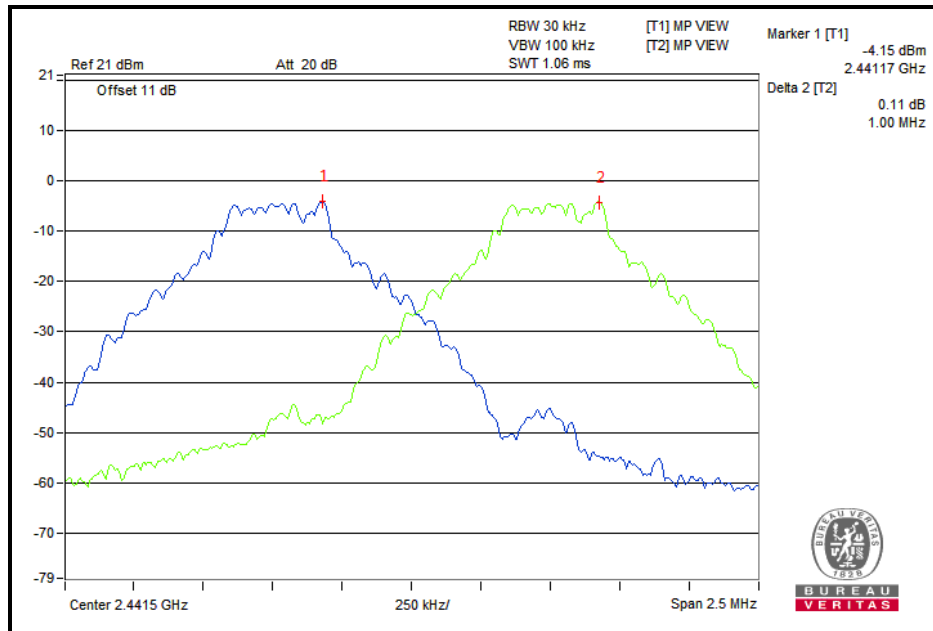

CH 78

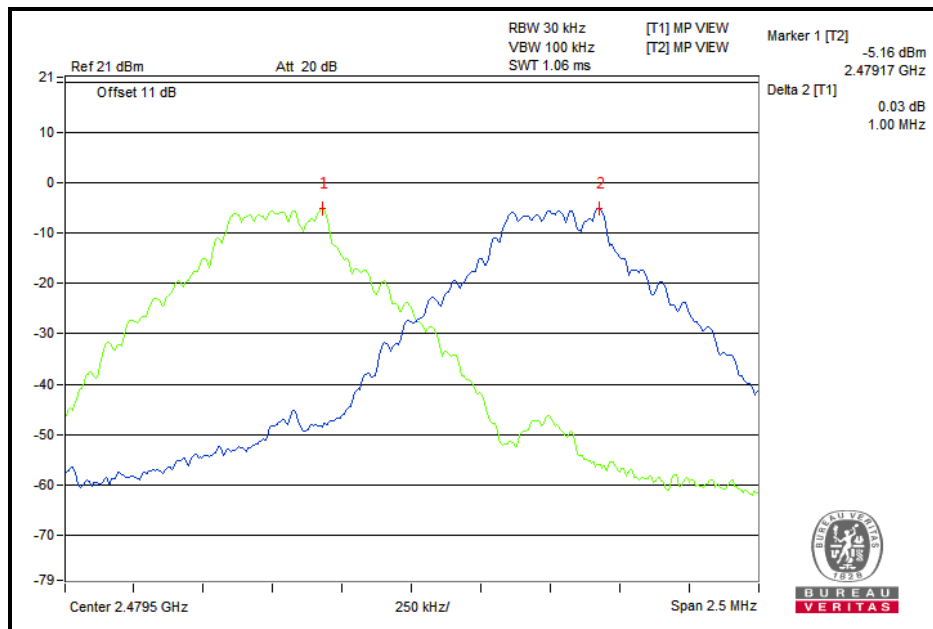

8DPSK

CHANNEL	FREQUENCY (MHz)	ADJACENT CHANNEL SEPARATION (MHz)	20dB BANDWIDTH (MHz)	MINIMUM LIMIT (MHz)	PASS / FAIL
0	2402	1.00	1.29	0.86	PASS
39	2441	1.00	1.29	0.86	PASS
78	2480	1.00	1.29	0.86	PASS

NOTE: The minimum limit is two-third 20dB bandwidth.

CH 0

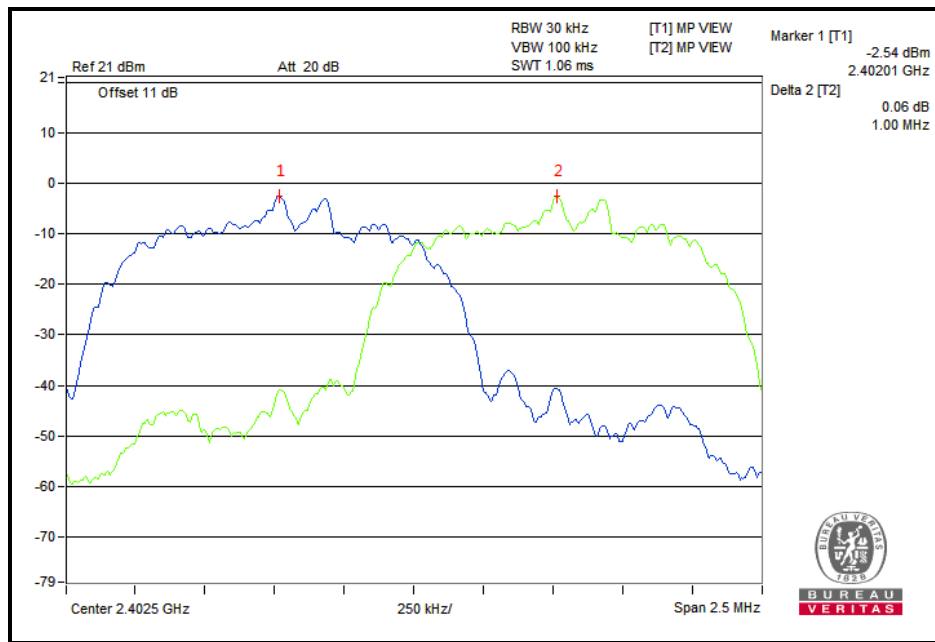

CH 39

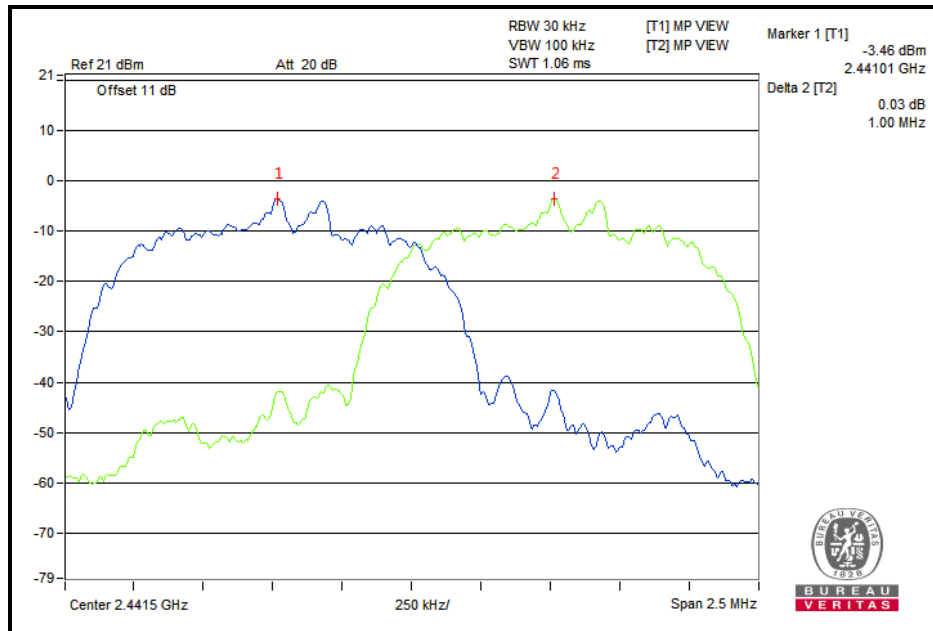

CH 78

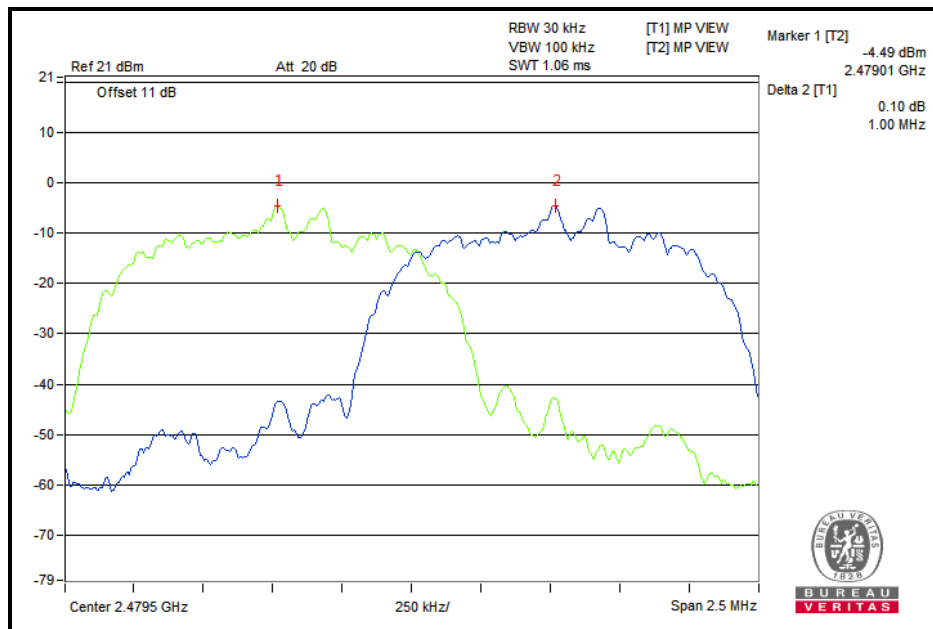

4.7 CONDUCTED OUTPUT POWER

4.7.1 LIMITS OF CONDUCTED OUTPUT POWER MEASUREMENT

The Maximum Output Power Measurement is 0.125W.

4.7.2 TEST SETUP

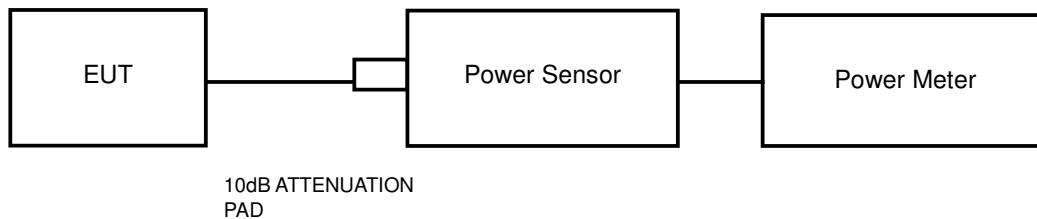

4.7.3 TEST INSTRUMENTS

Refer to section 4.3.3 to get information of above instrument.

4.7.4 TEST PROCEDURES

A peak power sensor was used on the output port of the EUT. A power meter was used to read the response of the peak power sensor and set the detector to PEAK. Record the power level.

An average power sensor was used on the output port of the EUT. A power meter was used to read the response of the average power sensor and set the detector to AVERAGE. Record the power level.

4.7.5 DEVIATION FROM TEST STANDARD

No deviation.



4.7.6 EUT OPERATING CONDITION

The software provided by client to enable the EUT under transmission condition continuously at lowest, middle and highest channel frequencies individually.

4.7.7 TEST RESULTS

MAXIMUM PEAK OUTPUT POWER

GFSK

CHANNEL	CHANNEL FREQUENCY (MHz)	PEAK POWER (dBm)	PEAK POWER (mW)	PEAK POWER LIMIT (W)	PASS/FAIL
0	2402	0.76	1.191	0.125	PASS
39	2441	0.01	1.002	0.125	PASS
78	2480	-0.87	0.8185	0.125	PASS

8DPSK

CHANNEL	CHANNEL FREQUENCY (MHz)	PEAK POWER (dBm)	PEAK POWER (mW)	PEAK POWER LIMIT (W)	PASS/FAIL
0	2402	3.29	2.133	0.125	PASS
39	2441	2.49	1.774	0.125	PASS
78	2480	1.53	1.422	0.125	PASS

AVERAGE OUTPUT POWER(FOR REFERENCE)

GFSK

CHANNEL	CHANNEL FREQUENCY (MHz)	AVERAGE POWER (dBm)	AVERAGE POWER (mW)
0	2402	-0.40	0.912
39	2441	-1.18	0.7621
78	2480	-1.19	0.7603

8DPSK

CHANNEL	CHANNEL FREQUENCY (MHz)	AVERAGE POWER (dBm)	AVERAGE POWER (mW)
0	2402	-0.33	0.9268
39	2441	-1.10	0.7762
78	2480	-2.09	0.618



4.8 OUT OF BAND EMISSION MEASUREMENT

4.8.1 LIMITS OF OUT OF BAND EMISSION MEASUREMENT

Below -20dB of the highest emission level of operating band (in 100KHz RBW).

4.8.2 TEST INSTRUMENTS

Refer to section 4.3.3 to get information of above instrument.

4.8.3 TEST PROCEDURE

The transmitter output was connected to the spectrum analyzer via a low loss cable. of Spectrum Analyzer was set RBW to 100 kHz and VBW to 300 kHz with suitable frequency span including 100 MHz bandwidth from band edge. Detector = PEAK and Trace mode = Max Hold. The band edges was measured and recorded.

4.8.4 DEVIATION FROM TEST STANDARD

No deviation.

4.8.5 EUT OPERATING CONDITION

The software provided by client to enable the EUT under transmission condition continuously at lowest, middle and highest channel frequencies individually.

4.8.6 TEST RESULTS

The spectrum plots are attached on the following images. D1 line indicates the highest level. D2 line indicates the 20dB offset below D1. It shows compliance to the requirement.



BUREAU VERITAS

Test Report No.: RF2403WDG0245

GFSK

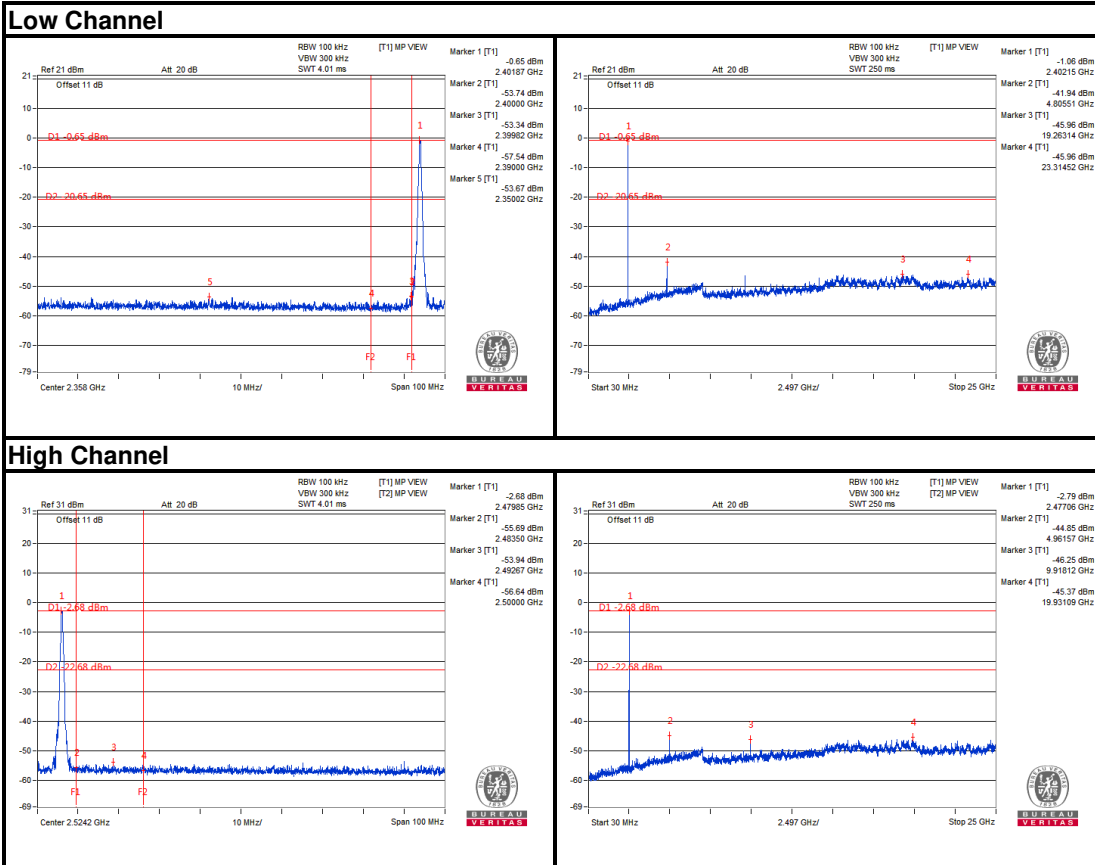

Bureau Veritas Shenzhen Co., Ltd.
Dongguan Branch

No. 96, Guantai Road (Houjie Section), Houjie
Town, Dongguan City, Guangdong Province.
523942, People's Republic of China.

Tel: +86 769 8998 2098
Fax: +86 769 8593 1080
Email: customerservice.dg@bureauveritas.com



BUREAU VERITAS

Test Report No.: RF2403WDG0245

8DPSK

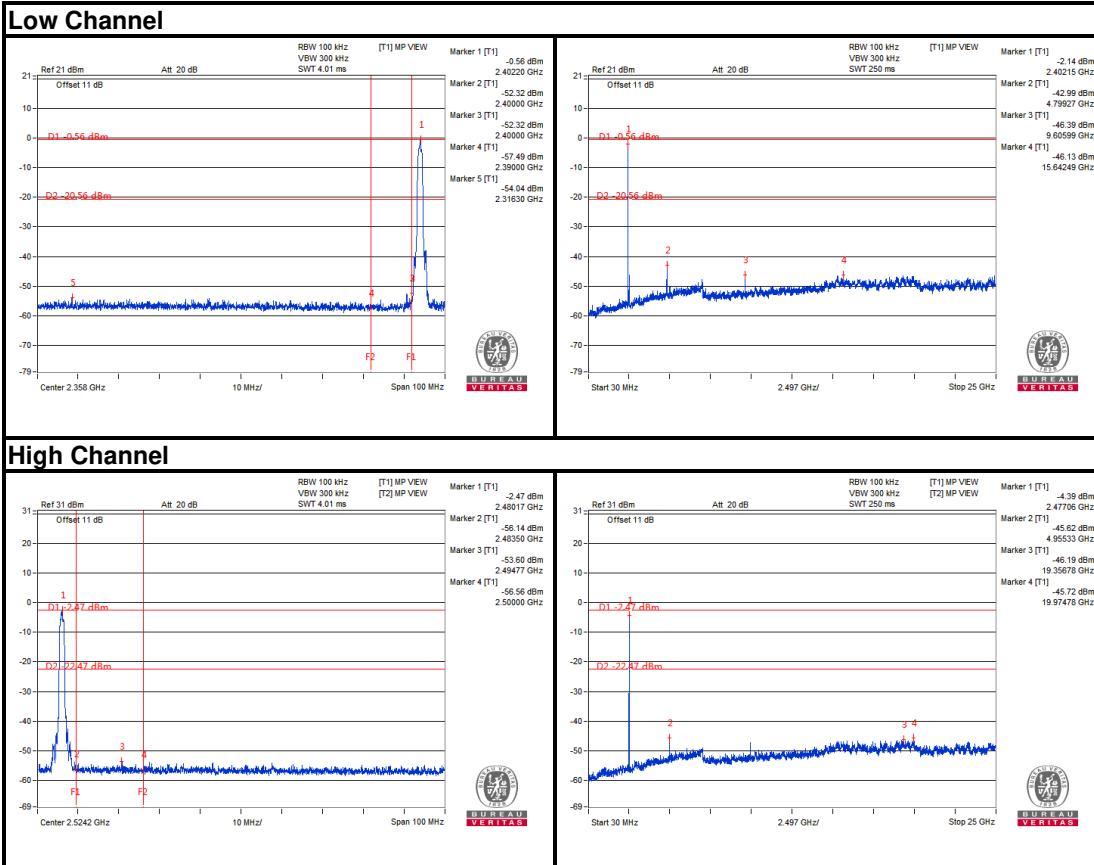

Bureau Veritas Shenzhen Co., Ltd.
Dongguan Branch

No. 96, Guantai Road (Houjie Section), Houjie
Town, Dongguan City, Guangdong Province.
523942, People's Republic of China.

Tel: +86 769 8998 2098
Fax: +86 769 8593 1080
Email: customerservice.dg@bureauveritas.com



GFSK

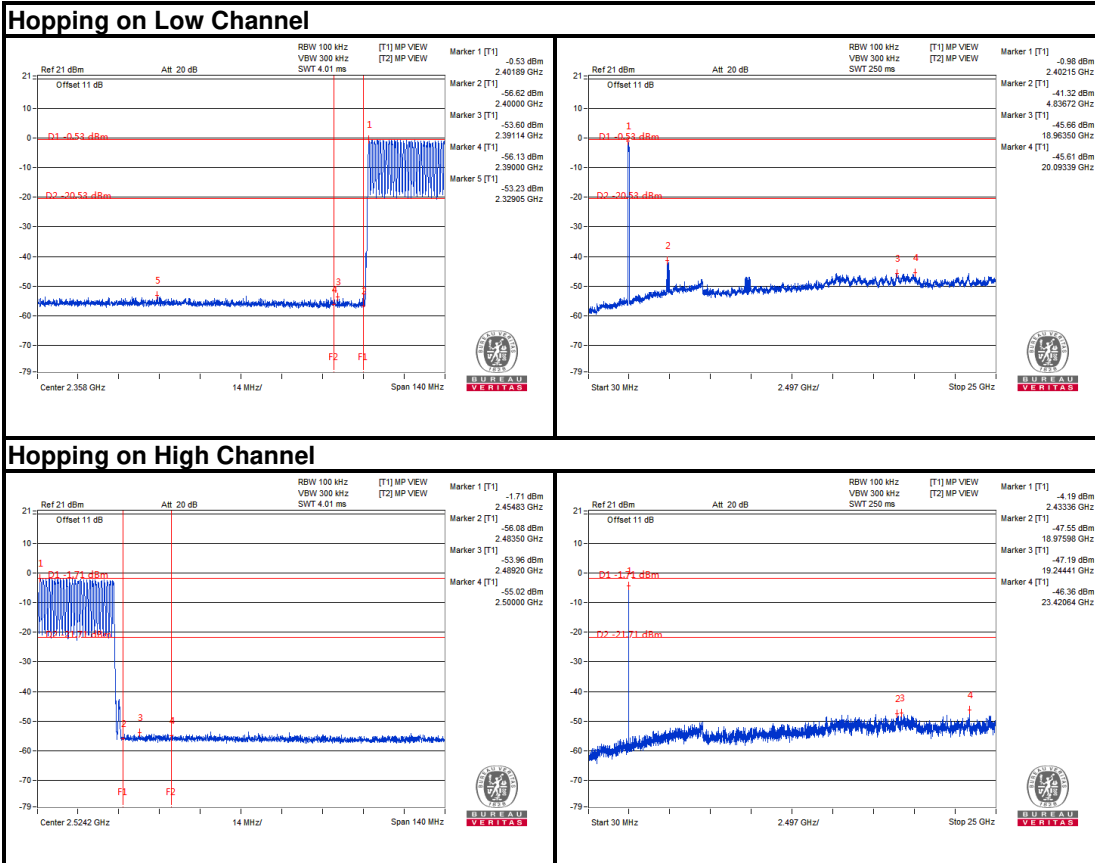



BUREAU VERITAS

Test Report No.: RF2403WDG0245

8DPSK

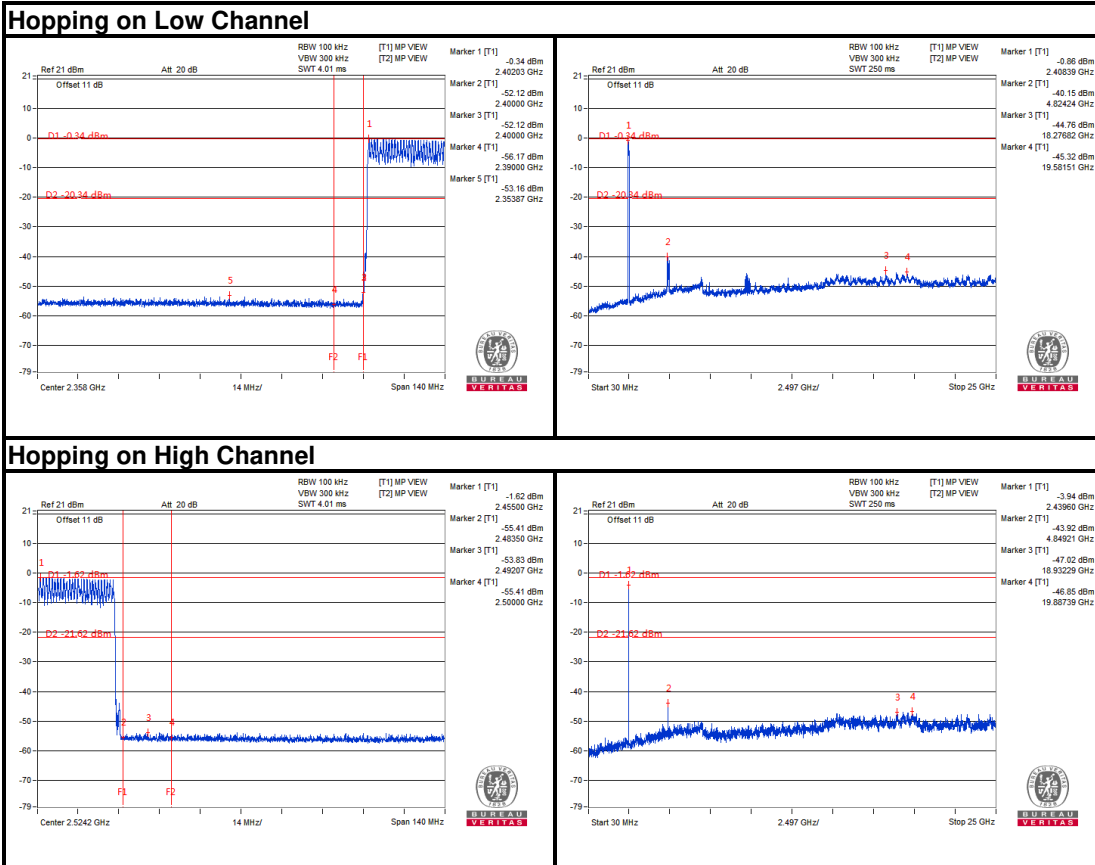

Bureau Veritas Shenzhen Co., Ltd.
Dongguan Branch

No. 96, Guantai Road (Houjie Section), Houjie
Town, Dongguan City, Guangdong Province.
523942, People's Republic of China.

Tel: +86 769 8998 2098
Fax: +86 769 8593 1080
Email: customerservice.dg@bureauveritas.com



Test Report No.: RF2403WDG0245

5 PHOTOGRAPHS OF THE TEST CONFIGURATION

Please refer to the attached file (Test Setup Photo).



Test Report No.: RF2403WDG0245

6 APPENDIX A - MODIFICATIONS RECORDERS FOR ENGINEERING CHANGES TO THE EUT BY THE LAB

No any modifications are made to the EUT by the lab during the test.

---END---