



**MET Laboratories, Inc.** *Safety Certification - EMI - Telecom Environmental Simulation*

914 WEST PATAPSCO AVENUE • BALTIMORE, MARYLAND 21230-3432 • PHONE (410) 354-3300 • FAX (410) 354-3313

33439 WESTERN AVENUE • UNION CITY, CALIFORNIA 94587 • PHONE (510) 489-6300 • FAX (510) 489-6372

3162 BELICK STREET • SANTA CLARA, CALIFORNIA 95054 • PHONE (408) 748-3585 • FAX (510) 489-6372

October 19, 2010

BodyMedia, Inc.  
One Gateway Center  
420 Fort Duquesne Blvd., Suite 1900  
Pittsburgh, PA 15222

Dear Scott Boehmke,

Enclosed is the EMC Wireless test report for compliance testing of the BodyMedia, Inc., Minifly2 - Bluetooth, Model: AB185 as tested to the requirements of Title 47 of the CFR, Ch. 1 (10-1-06 ed.), Part 15, Subpart B, ICES-003, Issue 4 February 2004 for a Class B Digital Device and FCC Part 15 Subpart C, RSS-210, Issue 7, June 2007 for Intentional Radiators.

Thank you for using the services of MET Laboratories, Inc. If you have any questions regarding these results or if MET can be of further service to you, please feel free to contact me.

Sincerely yours,  
MET LABORATORIES, INC.

Jennifer Warnell  
Documentation Department

Reference: (\BodyMedia, Inc.\EMC29476-FCC247 Rev. 1)

Certificates and reports shall not be reproduced except in full, without the written permission of MET Laboratories, Inc.

## **Electromagnetic Compatibility Criteria Test Report**

for the

**BodyMedia, Inc.  
Minify2 - Bluetooth, Model: AB185**

**Tested under**  
the FCC Certification Rules  
contained in  
Title 47 of the CFR, Parts 15 Subpart B & ICES-003  
for Class B Digital Devices  
&  
15.247 Subpart C & RSS-210, Issue 7, June 2007  
for Intentional Radiators

**MET Report: EMC29476-FCC247 Rev. 1**

October 19, 2010

**Prepared For:**

**BodyMedia, Inc.  
One Gateway Center  
420 Fort Duquesne Blvd., Suite 1900  
Pittsburgh, PA 15222**

**Prepared By:**  
**MET Laboratories, Inc.**  
914 W. Patapsco Ave  
Baltimore, MD 21230

## Electromagnetic Compatibility Criteria Test Report

for the

**BodyMedia, Inc.**  
**Minify2 – Bluetooth, Model: AB185**

**Tested under**  
the FCC Certification Rules  
contained in  
Title 47 of the CFR, Parts 15 Subpart B & ICES-003  
for Class B Digital Devices  
&  
15.247 Subpart C & RSS-210, Issue 7, June 2007  
for Intentional Radiators



Len Knight, Project Engineer  
Electromagnetic Compatibility Lab



Jennifer Warnell  
Documentation Department

**Engineering Statement:** The measurements shown in this report were made in accordance with the procedures indicated, and the emissions from this equipment were found to be within the limits applicable. I assume full responsibility for the accuracy and completeness of these measurements, and for the qualifications of all persons taking them. It is further stated that upon the basis of the measurements made, the equipment tested is capable of operation in accordance with the requirements of the FCC Rules Parts 15B, 15.247 and Industry Canada standards ICES-003, Issue 4 February 2004, RSS-210, Issue 7, June 2007 under normal use and maintenance.



Shawn McMillen,  
Wireless Manager, Electromagnetic Compatibility Lab

## Report Status Sheet

Revision	Report Date	Reason for Revision
∅	October 19, 2010	Initial Issue.
1	October 19, 2010	Revised to correct FCC ID and IC ID.

## Table of Contents

<b>I.</b>	<b>Executive Summary .....</b>	<b>1</b>
	A. Purpose of Test .....	2
	B. Executive Summary .....	2
<b>II.</b>	<b>Equipment Configuration .....</b>	<b>3</b>
	A. Overview .....	4
	B. References .....	5
	C. Test Site .....	5
	D. Description of Test Sample .....	6
	E. Equipment Configuration .....	7
	F. Support Equipment .....	7
	G. Ports and Cabling Information .....	8
	H. Mode of Operation .....	8
	I. Modifications .....	8
	a) Modifications to EUT .....	8
	b) Modifications to Test Standard .....	8
	J. Disposition of EUT .....	8
<b>III.</b>	<b>Electromagnetic Compatibility Criteria for Unintentional Radiators .....</b>	<b>9</b>
	§ 15.107(a) Conducted Emissions Limits .....	10
	§ 15.109(a) Radiated Emissions Limits .....	14
<b>IV.</b>	<b>Electromagnetic Compatibility Criteria for Intentional Radiators .....</b>	<b>18</b>
	§ 15.203 Antenna Requirement .....	19
	§ 15.207(a) Conducted Emissions Limits .....	20
	§ 15.247(a) Bandwidth & Channelization Requirements .....	21
	§ 15.247 Carrier Frequency Separation .....	24
	§ 15.247 Number of Hopping Channels .....	25
	§ 15.247 Time of Occupancy .....	27
	§ 15.247(b) Peak Power Output .....	28
	§ 15.247(d) Spurious Emissions Requirements – Radiated .....	32
	Radiated Band Edge Measurements .....	38
	§ 15.247(d) Spurious Emission Requirements – RF Conducted .....	41
	RSS-GEN Receiver Spurious Emissions .....	44
<b>V.</b>	<b>Test Equipment .....</b>	<b>46</b>
<b>VI.</b>	<b>Certification &amp; User’s Manual Information .....</b>	<b>48</b>
	A. Certification Information .....	49
	B. Label and User’s Manual Information .....	53
<b>VII.</b>	<b>ICES-003 Procedural &amp; Labeling Requirements .....</b>	<b>55</b>

## List of Tables

Table 1. Executive Summary of EMC Part 15.247 Compliance Testing .....	2
Table 2. EUT Summary Table.....	4
Table 3. References .....	5
Table 4. Equipment Configuration .....	7
Table 5. Support Equipment.....	7
Table 6. Ports and Cabling Information .....	8
Table 7. Conducted Limits for Radio Frequency Devices calculated from FCC Part 15 Subsections 15.107(a) (b) and 15.207(a) .....	10
Table 8. Conducted Emissions - Voltage, AC Power, Phase Line (120 VAC, 60 Hz).....	11
Table 9. Conducted Emissions - Voltage, AC Power, Neutral Line (120 VAC, 60 Hz).....	12
Table 10. Radiated Emissions Limits calculated from FCC Part 15, §15.109 (a) (b) .....	14
Table 11. Radiated Emissions Limits, Test Results, 30 MHz – 1 GHz, FCC Limits .....	15
Table 12. Radiated Emissions Limits, Test Results, ICES-003 Limits .....	16
Table 13. Conducted Limits for Intentional Radiators from FCC Part 15 § 15.207(a) .....	20
Table 14. Time Occupancy, Test Results .....	27
Table 15. Output Power Requirements from §15.247.....	28
Table 16. RF Output Power Test Results .....	29
Table 17. Restricted Bands of Operation.....	32
Table 18. Radiated Emissions Limits Calculated from FCC Part 15, § 15.209 (a) .....	33
Table 19. Radiated Harmonic Emissions .....	34
Table 20. Spurious Emission Limits for Receivers .....	44
Table 21. Test Equipment List .....	47

## List of Plots

Plot 1. Conducted Emission, Phase Line Plot .....	11
Plot 2. Conducted Emission, Neutral Line Plot.....	12
Plot 3. Radiated Emissions, 30 MHz - 1 GHz, FCC Limits .....	15
Plot 4. Radiated Emissions, ICES-003 Limits.....	16
Plot 5. Occupied Bandwidth, Low Channel .....	22
Plot 6. Occupied Bandwidth, Mid Channel.....	22
Plot 7. Occupied Bandwidth, High Channel.....	22
Plot 8. Channel Separation .....	24
Plot 9. Bottom Half of Frequency Range, 1 .....	25
Plot 10. Bottom Half of Frequency Range, 2 .....	25
Plot 11. Top Half of Frequency Range, 1.....	26
Plot 12. Top Half of Frequency Range, 2.....	26
Plot 13. Time Occupancy .....	27
Plot 14. Peak Output Power, Low Channel, Channel Integration .....	30
Plot 15. Peak Output Power, Mid Channel, Channel Integration .....	30
Plot 16. Peak Output Power, High Channel, Channel Integration.....	30
Plot 17. Radiated Spurious Emissions, Low Channel, 30 MHz – 1 GHz.....	35
Plot 18. Radiated Spurious Emissions, Low Channel, 3 GHz – 26.5 GHz .....	35
Plot 19. Radiated Spurious Emissions, Mid Channel, 30 MHz – 1 GHz .....	35
Plot 20. Radiated Spurious Emissions, Mid Channel, 3 GHz – 26.5 GHz .....	36
Plot 21. Radiated Spurious Emissions, High Channel, 30 MHz – 1 GHz.....	36
Plot 22. Radiated Spurious Emissions, High Channel, 3 GHz – 26.5 GHz.....	36
Plot 23. Radiated Spurious Emissions, Hopping Mode, 30 MHz – 1 GHz.....	37
Plot 24. Radiated Spurious Emissions, Hopping Mode, 3 GHz – 26.5 GHz.....	37
Plot 25. Radiated Restricted Band Edge, Low Channel, Average.....	38

Plot 26. Radiated Restricted Band Edge, Low Chanel, Peak .....	38
Plot 27. Radiated Restricted Band Edge, High Chanel, Average .....	38
Plot 28. Radiated Restricted Band Edge, High Chanel, Peak.....	39
Plot 29. 20dBc Requirement, Low Channel.....	39
Plot 30. 20dBc Requirement, High Channel .....	39
Plot 31. Conducted Spurious Emissions, Low Channel .....	42
Plot 32. Conducted Spurious Emissions, Mid Channel .....	42
Plot 33. Conducted Spurious Emissions, High Channel.....	42
Plot 34. Conducted Spurious Emissions, Hopping Mode.....	43
Plot 35. Receiver Spurious Emission, 30 MHz – 1 GHz.....	45
Plot 36. Receiver Spurious Emission, 1 GHz – 26.5 GHz .....	45

## List of Figures

Figure 1. Block Diagram of Test Configuration, Mode 1 .....	7
Figure 2. Block Diagram of Test Configuration, Mode 2 .....	7
Figure 3. Block Diagram, Occupied Bandwidth Test Setup.....	21
Figure 4. Peak Power Output Test Setup.....	28
Figure 5. Block Diagram, Conducted Receiver Spurious Emissions Test Setup .....	44

## List of Photographs

Photograph 1. BodyMedia, Inc. Minify2 - Bluetooth, Model: AB185.....	6
Photograph 2. Conducted Emissions, Test Setup .....	13
Photograph 3. Radiated Emission, Test Setup.....	17
Photograph 4. Occupied Bandwidth, Test Setup .....	23
Photograph 5. Conducted Power, Test Setup .....	31
Photograph 6. Radiated Spurious Emissions, Test Setup .....	40

## List of Terms and Abbreviations

AC	Alternating Current
ACF	Antenna Correction Factor
Cal	Calibration
<i>d</i>	Measurement Distance
dB	Decibels
dB $\mu$ A	Decibels above one <b>microamp</b>
dB $\mu$ V	Decibels above one <b>microvolt</b>
dB $\mu$ A/m	Decibels above one <b>microamp per meter</b>
dB $\mu$ V/m	Decibels above one <b>microvolt per meter</b>
DC	Direct Current
E	Electric Field
DSL	Digital Subscriber Line
ESD	Electrostatic Discharge
EUT	Equipment Under Test
<i>f</i>	Frequency
FCC	Federal Communications Commission
GRP	Ground Reference Plane
H	Magnetic Field
HCP	Horizontal Coupling Plane
Hz	Hertz
IEC	International Electrotechnical Commission
kHz	kilohertz
kPa	kilopascal
kV	kilovolt
LISN	Line Impedance Stabilization Network
MHz	Megahertz
$\mu$ H	microhenry
$\mu$	microfarad
$\mu$ s	microseconds
NEBS	Network Equipment-Building System
PRF	Pulse Repetition Frequency
RF	Radio Frequency
RMS	Root-Mean-Square
TWT	Traveling Wave Tube
V/m	Volts per meter
VCP	Vertical Coupling Plane



# I. Executive Summary

## A. Purpose of Test

An EMC evaluation was performed to determine compliance of the BodyMedia, Inc. Minify2 - Bluetooth, Model: AB185, with the requirements of Part 15, §15.247. All references are to the most current version of Title 47 of the Code of Federal Regulations in effect. In accordance with §2.1033, the following data is presented in support of the Certification of the Minify2 - Bluetooth, Model: AB185. BodyMedia, Inc. should retain a copy of this document which should be kept on file for at least two years after the manufacturing of the Minify2 - Bluetooth, Model: AB185, has been **permanently** discontinued.

## B. Executive Summary

The following tests were conducted on a sample of the equipment for the purpose of demonstrating compliance with Part 15, §15.247, in accordance with BodyMedia, Inc., purchase order number 11278. All tests were conducted using measurement procedure ANSI C63.4-2003.

FCC Reference 47 CFR Part 15.247:2005	IC Reference RSS-210 Issue 7: 2007	Description	Compliance
47 CFR Part 15.107 (a)	ICES-003 Issue 4 February 2004	Conducted Emission Limits for a Class B Digital Device	Compliant
47 CFR Part 15.109 (a)	ICES-003 Issue 4 February 2004	Radiated Emission Limits for a Class B Digital Device	Compliant
Title 47 of the CFR, Part 15 §15.203	N/A	Antenna Requirement	Compliant
Title 47 of the CFR, Part 15 §15.205	RSS-210(A8.5)	Emissions at Restricted Band	Compliant
Title 47 of the CFR, Part 15 §15.207(a)	RSS-210(7.2.2)	Conducted Emission Voltage	Not Applicable
Title 47 of the CFR, Part 15 §15.247(a)(1)	RSS-210(A8.1)	Channel Separation Occupied Bandwidth Number of Hopping Channels Time of Occupancy	Compliant
Title 47 of the CFR, Part 15 §15.247(b)	RSS-210(A8.4)	RF Output Power	Compliant
Title 47 of the CFR, Part 15 §15.209, §15.247(d)	RSS-210(A8.5)	Radiated and Conducted Spurious Emissions	Compliant
Title 47 of the CFR, Part 15 15.247(g)	RSS-210(A8.1)	Hopping Capability	Compliant
Title 47 of the CFR, Part 15 §15.247(h)	RSS-210(A8.1)	Hopping Coordination Requirement	Compliant
Title 47 of the CFR, Part 15 §15.247(i)	RSSGen(5.5)	Maximum Permissible Exposure	Compliant
N/A	RSS-Gen(4.8)	Receiver Spurious Emissions	Compliant

**Table 1. Executive Summary of EMC Part 15.247 Compliance Testing**

## II. Equipment Configuration

## A. Overview

MET Laboratories, Inc. was contracted by BodyMedia, Inc. to perform testing on the Minify2 - Bluetooth, Model: AB185, under BodyMedia, Inc.'s purchase order number 11278.

This document describes the test setups, test methods, required test equipment, and the test limit criteria used to perform compliance testing of the BodyMedia, Inc., Minify2 - Bluetooth, Model: AB185.

The results obtained relate only to the item(s) tested.

<b>Model(s) Tested:</b>	Minify2 - Bluetooth, Model: AB185	
<b>Model(s) Covered:</b>	Minify2 - Bluetooth, Model: AB185	
<b>EUT Specifications:</b>	Primary Power: 120 VAC, 60 Hz	
	FCC ID: PV8-185 IC: 4745A-185	
	Type of Modulations:	FHSS
	Equipment Code:	DSS
	Peak RF Output Power:	1.2 mW
	EUT Frequency Ranges:	2402 – 2480 MHz
<b>Analysis:</b>	The results obtained relate only to the item(s) tested.	
<b>Environmental Test Conditions:</b>	Temperature: 15-35° C	
	Relative Humidity: 30-60%	
	Barometric Pressure: 860-1060 mbar	
<b>Evaluated by:</b>	Len Knight	
<b>Report Date(s):</b>	October 19, 2010	

**Table 2. EUT Summary Table**

## B. References

<b>CFR 47, Part 15, Subpart C</b>	Federal Communication Commission, Code of Federal Regulations, Title 47, Part 15: General Rules and Regulations, Allocation, Assignment, and Use of Radio Frequencies
<b>RSS-210, Issue 7, June 2007</b>	Low-power Licence-exempt Radiocommunications Devices (All Frequency Bands): Category I Equipment
<b>CFR 47, Part 15, Subpart B</b>	Electromagnetic Compatibility: Criteria for Radio Frequency Devices
<b>ICES-003, Issue 4 February 2004</b>	Electromagnetic Compatibility: Criteria for Radio Frequency Devices
<b>ANSI C63.4:2003</b>	Methods and Measurements of Radio-Noise Emissions from Low-Voltage Electrical And Electronic Equipment in the Range of 9 kHz to 40 GHz
<b>ANSI/NCSL Z540-1-1994</b>	Calibration Laboratories and Measuring and Test Equipment - General Requirements
<b>ANSI/ISO/IEC 17025:2000</b>	General Requirements for the Competence of Testing and Calibration Laboratories
<b>ANSI C63.10-2009</b>	American National Standard for Testing Unlicensed Wireless Devices

**Table 3. References**

## C. Test Site

All testing was performed at MET Laboratories, Inc., 914 W. Patapsco Ave., Baltimore, MD 21230. All equipment used in making physical determinations is accurate and bears recent traceability to the National Institute of Standards and Technology.

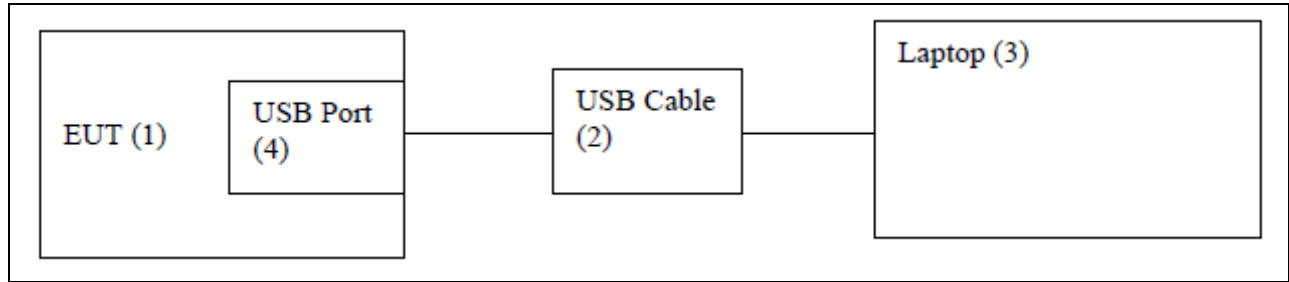
Radiated Emissions measurements were performed in a 3 meter semi-anechoic chamber (equivalent to an Open Area Test Site). In accordance with §2.948(a)(3), a complete site description is contained at MET Laboratories.

## D. Description of Test Sample

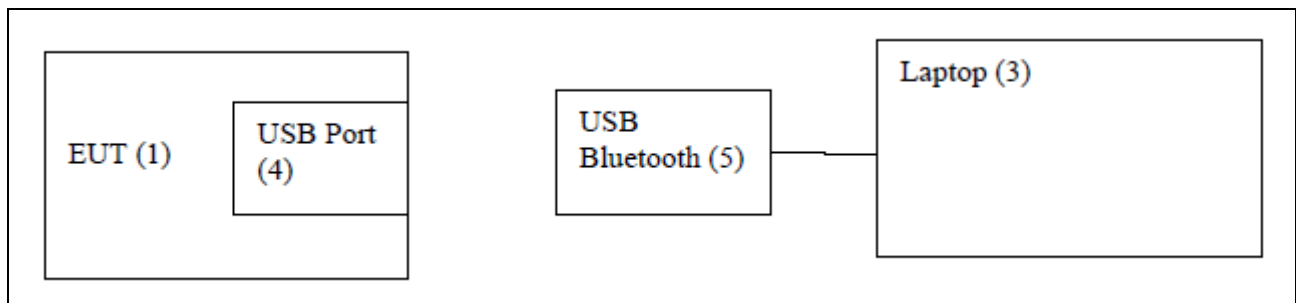
The BodyMedia, Inc. Minify2 - Bluetooth, Model: AB185, Equipment Under Test (EUT), is an update to the Minify (a computer worn on the arm which collects physiological data for wireless transmission to an accessory or PC). The Minify 2 updates the PCB to include Bluetooth instead of the previous proprietary 2.4 GHz wireless transceiver. The antenna has been changed and relocated to accommodate the new transceiver.



**Photograph 1. BodyMedia, Inc. Minify2 - Bluetooth, Model: AB185**



**Figure 1. Block Diagram of Test Configuration, Mode 1**



**Figure 2. Block Diagram of Test Configuration, Mode 2**

### E. Equipment Configuration

The EUT was set up as outlined in Figure 1, Block Diagram of Test Setup.

Ref. ID	Name / Description	Model Number	Serial Number
1	BodyMedia Minify2 - Bluetooth	AB185	9 and 10

**Table 4. Equipment Configuration**

### F. Support Equipment

Support equipment necessary for the operation and testing of the EUT is included in the following list.

Ref. ID	Name / Description	Manufacturer	Model Number	Serial Number
2	USB Cable	BodyMedia	100467	N/A
3	PC Laptop	Dell	Lattitude D620	6Q4QWC1
5	USB Bluetooth Dongle	Generic	none	none

**Table 5. Support Equipment**

## G. Ports and Cabling Information

Ref. ID	Port Name on EUT	Cable Description	Qty.	Length (m)	Shielded (Y/N)	Termination Point
4	Mini-USB	2m mini-USB B to USB A	1	2m	Y	N/A

Table 6. Ports and Cabling Information

## H. Mode of Operation

**Mode 1:** Under normal operation, the user would plug the armband into the USB port of a PC/Mac using the provided 2m cable to charge the internal battery and retrieve data from the device. The internal radio transceiver of the armband would automatically be disabled when the USB connection is detected. For the purposes of the tests, the EUT is plugged into the USB port of a provided laptop computer and monitored for proper communications over the USB connection using a program provided. This represents real world operation because the same recharger supply, USB signaling, and communications protocol are exercised as would be under normal operation.

**Mode 2:** Under normal operation, the user would pair the armband to a smartphone with Bluetooth wireless technology. For the purposes of wireless testing, the sample provided was programmed to transmit continuously. The sample could transmit on low, mid, and high channels as well as hopping mode.

## I. Modifications

a) **Modifications to EUT**

No modifications were made to the EUT.

b) **Modifications to Test Standard**

No modifications were made to the test standard.

## J. Disposition of EUT

The test sample including all support equipment submitted to the Electro-Magnetic Compatibility Lab for testing was returned to BodyMedia, Inc. upon completion of testing.



### **III. Electromagnetic Compatibility Criteria for Unintentional Radiators**

## Electromagnetic Compatibility Criteria

### § 15.107 Conducted Emissions Limits

**Test Requirement(s):** **15.107 (a)** Except for Class A digital devices, for equipment that is designed to be connected to the public utility (AC) power line, the radio frequency voltage that is conducted back onto the AC power line on any frequency or frequencies within the band 150 kHz to 30 MHz shall not exceed the limits in Table 7. Compliance with this provision shall be based on the measurement of the radio frequency voltage between each power line and ground at the power terminals.

**15.107 (b)** For a Class A digital device that is designed to be connected to the public utility (AC) power line, the radio frequency voltage that is conducted back onto the AC power line on any frequency or frequencies within the band 150 kHz to 30 MHz shall not exceed the limits in Table 7. Compliance with this provision shall be based on the measurement of the radio frequency voltage between each power line and ground at the power terminals. The lower limit applies at the band edges.

**15.207(a)**, Except as shown in paragraphs (b) and (c) of this section\*, charging, AC adapters or battery eliminators the radio frequency voltage that is conducted back onto the AC power line on any frequency or frequencies, within the band 150 kHz to 30 MHz, shall not exceed the limits in the Table 7, as measured using a 50  $\mu$ H/50 ohms line impedance stabilization network (LISN). Compliance with the provisions of this paragraph shall be based on the measurement of the radio frequency voltage between each power line and ground at the power terminal. The lower limit applies at the boundary between the frequencies ranges.

Frequency range (MHz)	Class A Conducted Limits (dB $\mu$ V)		*Class B Conducted Limits (dB $\mu$ V)	
	Quasi-Peak	Average	Quasi-Peak	Average
* 0.15- 0.45	79	66	66 - 56	56 - 46
0.45 - 0.5	79	66	56	46
0.5 - 30	73	60	60	50

Note 1 — The lower limit shall apply at the transition frequencies.  
 Note 2 — The limit decreases linearly with the logarithm if the frequency in the range 0.15 MHz to 0.5 MHz.  
 \* -- Limits per Subsection 15.207(a).

**Table 7. Conducted Limits for Radio Frequency Devices calculated from FCC Part 15 Subsections 15.107(a) (b) and 15.207(a)**

**Test Results:** The EUT was compliant with the Class B requirement(s) of this section. Measured emissions were below applicable limits.

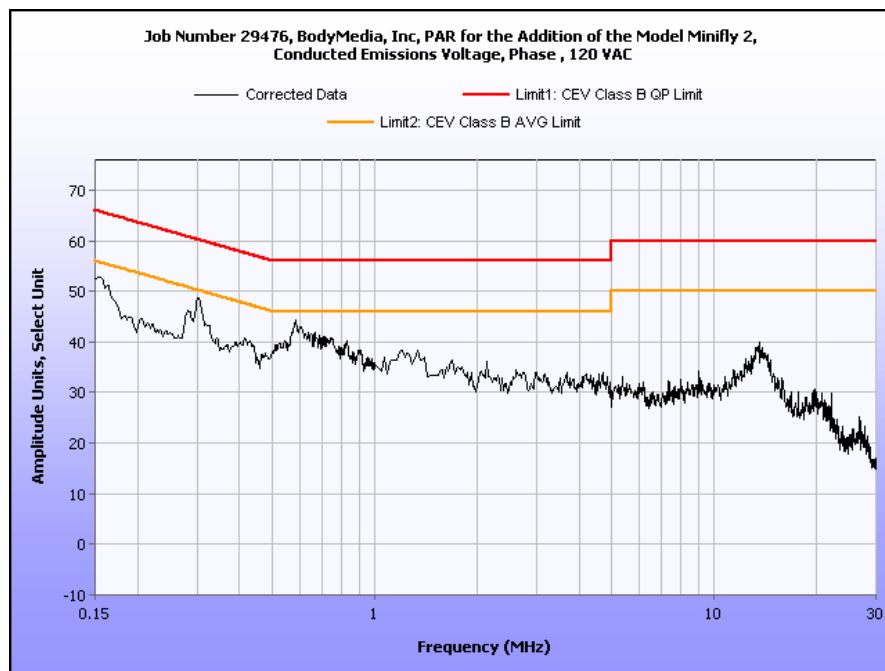
**Test Engineer(s):** Zijun Tong

**Test Date(s):** 08/11/10

### Conducted Emissions - Voltage, AC Power, Phase Line (120 VAC, 60 Hz)

Frequency (MHz)	Uncorrected Meter Reading (dBuV) QP	Cable Loss (dB)	Corrected Measurement (dBuV) QP	Limit (dBuV) QP	Margin (dB) QP	Uncorrected Meter Reading (dBuV) Avg.	Cable Loss (dB)	Corrected Measurement (dBuV) AVG	Limit (dBuV) AVG	Margin (dB) AVG
0.1593	47.81	0	47.81	65.5	-17.69	37.59	0	37.59	55.5	-17.91
0.3024	45.57	0	45.57	60.18	-14.61	40.29	0	40.29	50.18	-9.89
0.584	40.41	0	40.41	56	-15.59	34.07	0	34.07	46	-11.93
0.7512	35.56	0	35.56	56	-20.44	23.38	0	23.38	46	-22.62
1.267	31.2	0	31.2	56	-24.8	23.16	0	23.16	46	-22.84
13.79	32.17	0.07	32.24	60	-27.76	22.85	0.07	22.92	50	-27.08

Table 8. Conducted Emissions - Voltage, AC Power, Phase Line (120 VAC, 60 Hz)

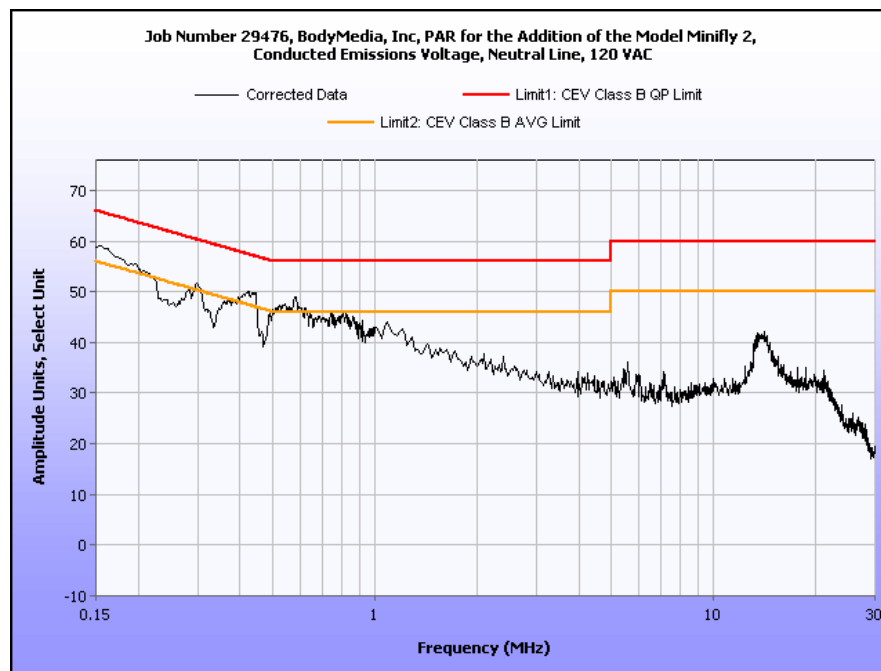


Plot 1. Conducted Emission, Phase Line Plot

### Conducted Emissions - Voltage, AC Power, Neutral Line (120 VAC, 60 Hz)

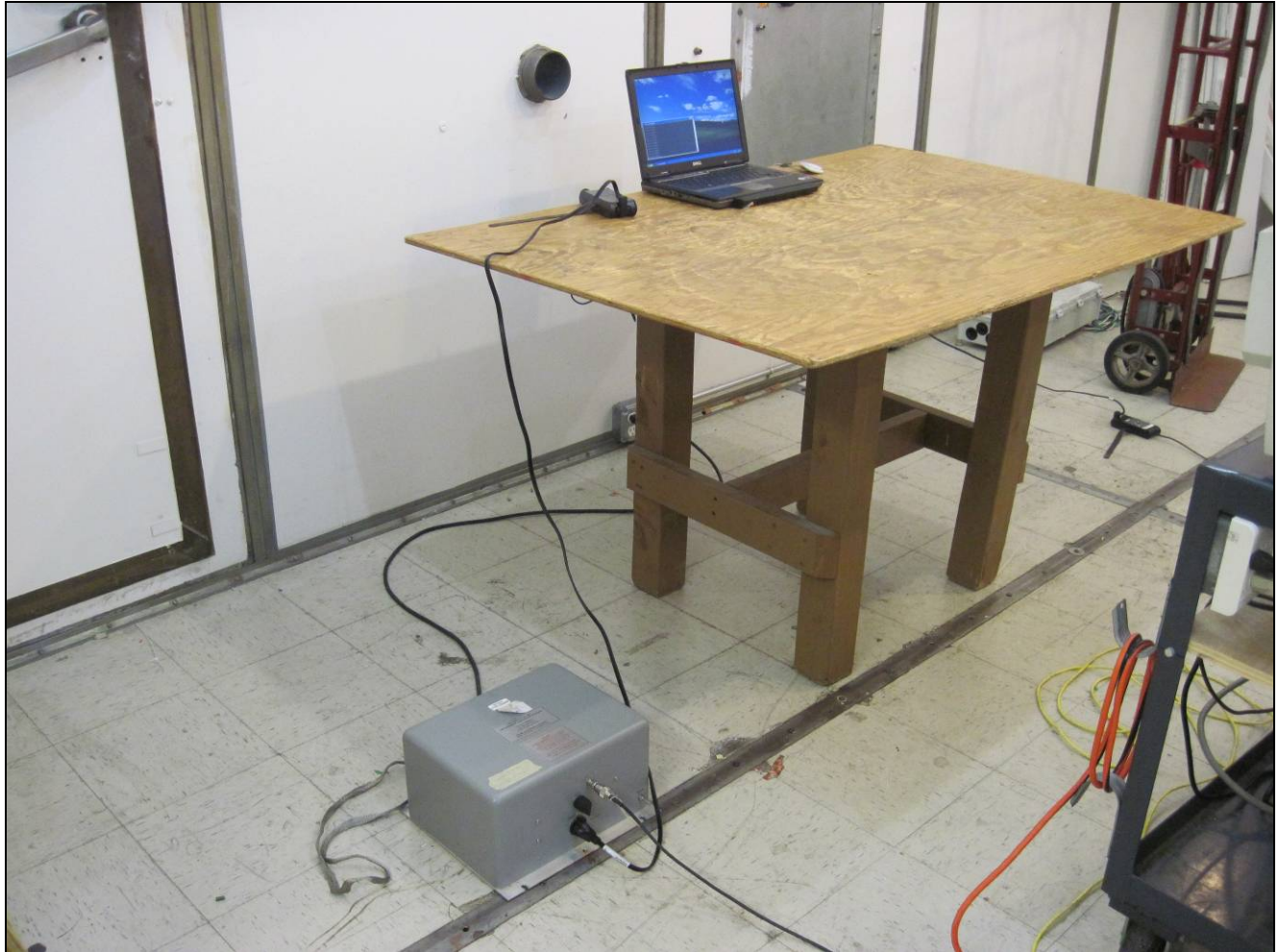
Frequency (MHz)	Uncorrected Meter Reading (dBuV) QP	Cable Loss (dB)	Corrected Measurement (dBuV) QP	Limit (dBuV) QP	Margin (dB) QP	Uncorrected Meter Reading (dBuV) Avg.	Cable Loss (dB)	Corrected Measurement (dBuV) AVG	Limit (dBuV) AVG	Margin (dB) AVG
0.1544	55.23	0	55.23	65.76	-10.53	43.01	0	43.01	55.76	-12.75
0.181	53.03	0	53.03	64.44	-11.41	40.51	0	40.51	54.44	-13.93
0.2175	49.95	0	49.95	62.91	-12.96	39.58	0	39.58	52.91	-13.33
0.302	46.98	0	46.98	60.19	-13.21	45.16	0	45.16	50.19	-5.03
0.4266	46.55	0	46.55	57.32	-10.77	30.86	0	30.86	47.32	-16.46
0.5846	44	0	44	56	-12	39.95	0	39.95	46	-6.05
0.7974	41.17	0	41.17	56	-14.83	29.7	0	29.7	46	-16.3
1.159	35.9	0	35.9	56	-20.1	27.91	0	27.91	46	-18.09

Table 9. Conducted Emissions - Voltage, AC Power, Neutral Line (120 VAC, 60 Hz)



Plot 2. Conducted Emission, Neutral Line Plot

## Conducted Emission Limits Test Setup



**Photograph 2. Conducted Emissions, Test Setup**

## Radiated Emission Limits

### § 15.109 Radiated Emissions Limits

**Test Requirement(s):** **15.109 (a)** Except for Class A digital devices, the field strength of radiated emissions from unintentional radiators at a distance of 3 meters shall not exceed the Class B limits expressed in Table 10.

**15.109 (b)** The field strength of radiated emissions from a Class A digital device, as determined at a distance of 10 meters, shall not exceed the Class A limits expressed in Table 10.

Frequency (MHz)	Field Strength (dB $\mu$ V/m)	
	§15.109 (b), Class A Limit (dB $\mu$ V) @ 10m	§15.109 (a), Class B Limit (dB $\mu$ V) @ 3m
30 - 88	39.00	40.00
88 - 216	43.50	43.50
216 - 960	46.40	46.00
Above 960	49.50	54.00

**Table 10. Radiated Emissions Limits calculated from FCC Part 15, §15.109 (a) (b)**

**Test Procedures:** The EUT was placed on a non-metallic table, 80 cm above the ground plane inside a semi-anechoic chamber. The method of testing and test conditions of ANSI C63.4 were used. An antenna was located 3 m from the EUT on an adjustable mast. A pre-scan was first performed in order to find prominent radiated emissions. For final emissions measurements at each frequency of interest, the EUT was rotated and the antenna height was varied between 1 m and 4 m in order to maximize the emission. Measurements in both horizontal and vertical polarities were made and the data was recorded. Unless otherwise specified, measurements were made using a quasi-peak detector with a 120 kHz bandwidth.

**Test Results:** The EUT was compliant with the Class B requirement(s) of this section. Measured emissions were below applicable limits.

**Test Engineer(s):** Zijun Tong

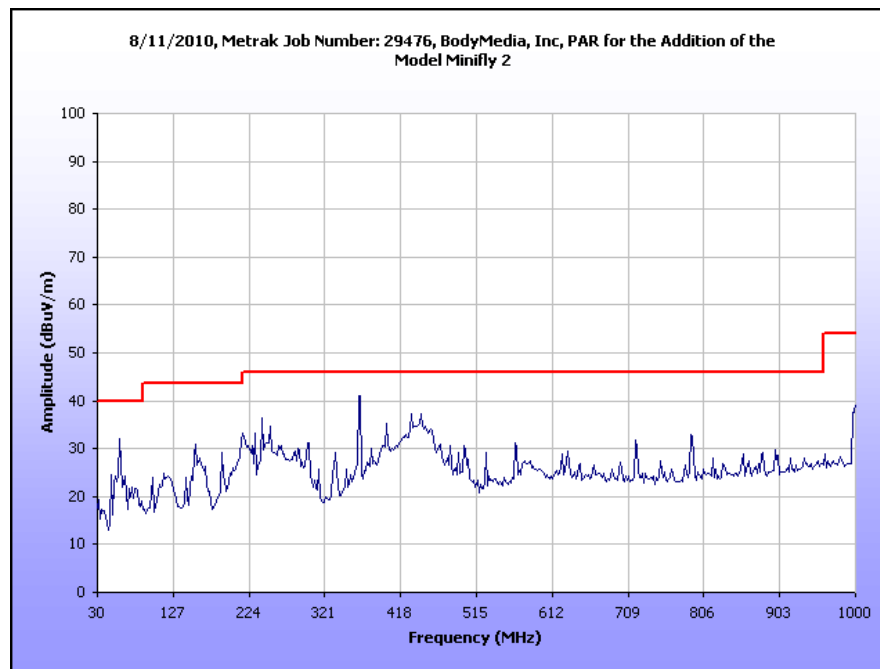
**Test Date(s):** 08/11/10

### Radiated Emissions Limits Test Results, Class B

Frequency (MHz)	EUT Azimuth (Degrees)	Antenna Polarity (H/V)	Antenna HEIGHT (m)	Uncorrected Amplitude (dBuV)	Antenna Correction Factor (dB) (+)	Cable Loss (dB) (+)	Distance Correction Factor (dB) (-)	Corrected Amplitude (dBuV/m)	Limit (dBuV/m)	Margin (dB)
60.006792	212	H	1.59	9.20	10.10	0.23	0.00	19.53	40.00	-20.47
60.006792	360	V	1.00	19.76	10.90	0.23	0.00	30.89	40.00	-9.11
156.06265	51	H	1.99	19.52	8.14	0.23	0.00	27.89	43.50	-15.61
156.06265	261	V	0.99	21.42	7.91	0.23	0.00	29.56	43.50	-13.94
220.70084	281	H	0.99	18.31	10.51	0.23	0.00	29.05	46.00	-16.95
220.70084	360	V	1.81	16.10	10.66	0.23	0.00	26.99	46.00	-19.01
239.992	254	H	1.00	24.83	11.50	0.39	0.00	36.72	46.00	-9.28
239.992	173	V	1.00	21.00	11.80	0.39	0.00	33.19	46.00	-12.81
366.33718	333	H	2.07	22.91	14.80	0.83	0.00	38.54	46.00	-7.46
366.33718	333	V	1.36	25.64	15.10	0.83	0.00	41.57	46.00	-4.43
431.76376	172	H	1.00	13.41	16.30	1.00	0.00	30.71	46.00	-15.29
431.76376	198	V	1.00	17.24	16.44	1.00	0.00	34.68	46.00	-11.32
995.73909	0	H	1.44	10.63	23.61	1.83	0.00	36.07	54.00	-17.93
995.73909	262	V	1.00	13.09	23.59	1.83	0.00	38.51	54.00	-15.49

**Table 11. Radiated Emissions Limits, Test Results, 30 MHz – 1 GHz, FCC Limits**

Note: The EUT was tested at 3 m.



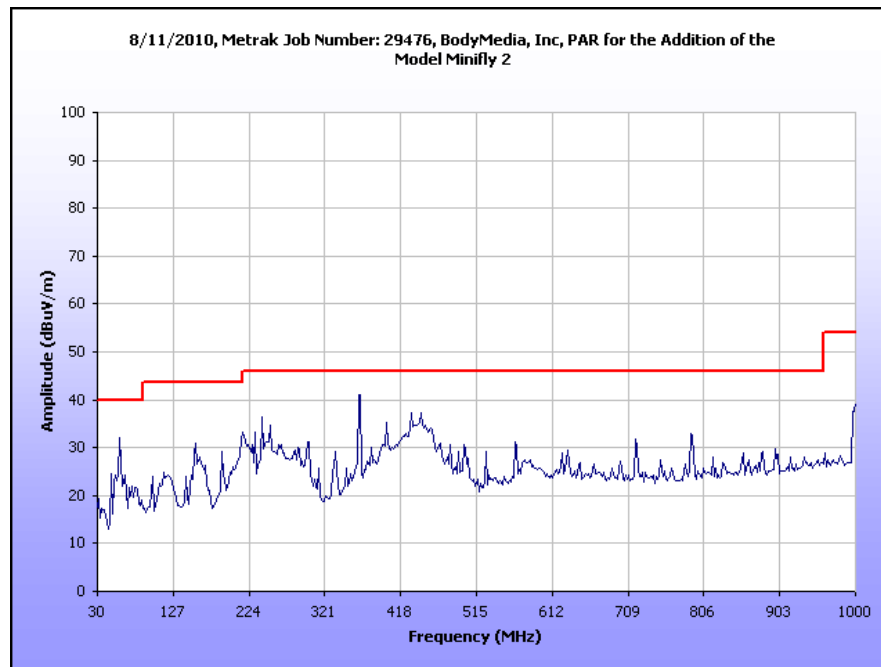
**Plot 3. Radiated Emissions, 30 MHz - 1 GHz, FCC Limits**

## Radiated Emissions Limits Test Results, Class B

Frequency (MHz)	EUT Azimuth (Degrees)	Antenna Polarity (H/V)	Antenna HEIGHT (m)	Uncorrected Amplitude (dBuV)	Antenna Correction Factor (dB) (+)	Cable Loss (dB) (+)	Distance Correction Factor (dB) (-)	Corrected Amplitude (dBuV/m)	Limit (dBuV/m)	Margin (dB)
60.006792	212	H	1.59	9.20	10.10	0.23	10.46	9.07	30.00	-20.93
60.006792	360	V	1.00	19.76	10.90	0.23	10.46	20.43	30.00	-9.57
156.06265	51	H	1.99	19.52	8.14	0.23	10.46	17.43	30.00	-12.57
156.06265	261	V	0.99	21.42	7.91	0.23	10.46	19.10	30.00	-10.90
220.70084	281	H	0.99	18.31	10.51	0.23	10.46	18.59	30.00	-11.41
220.70084	360	V	1.81	16.10	10.66	0.23	10.46	16.53	30.00	-13.47
239.992	254	H	1.00	24.83	11.50	0.39	10.46	26.26	37.00	-10.74
239.992	173	V	1.00	21.00	11.80	0.39	10.46	22.73	37.00	-14.27
366.33718	333	H	2.07	22.91	14.80	0.83	10.46	28.08	37.00	-8.92
366.33718	333	V	1.36	25.64	15.10	0.83	10.46	31.11	37.00	-5.89
431.76376	172	H	1.00	13.41	16.30	1.00	10.46	20.25	37.00	-16.75
431.76376	198	V	1.00	17.24	16.44	1.00	10.46	24.22	37.00	-12.78
995.73909	0	H	1.44	10.63	23.61	1.83	10.46	25.61	37.00	-11.39
995.73909	262	V	1.00	13.09	23.59	1.83	10.46	28.05	37.00	-8.95

**Table 12. Radiated Emissions Limits, Test Results, ICES-003 Limits**

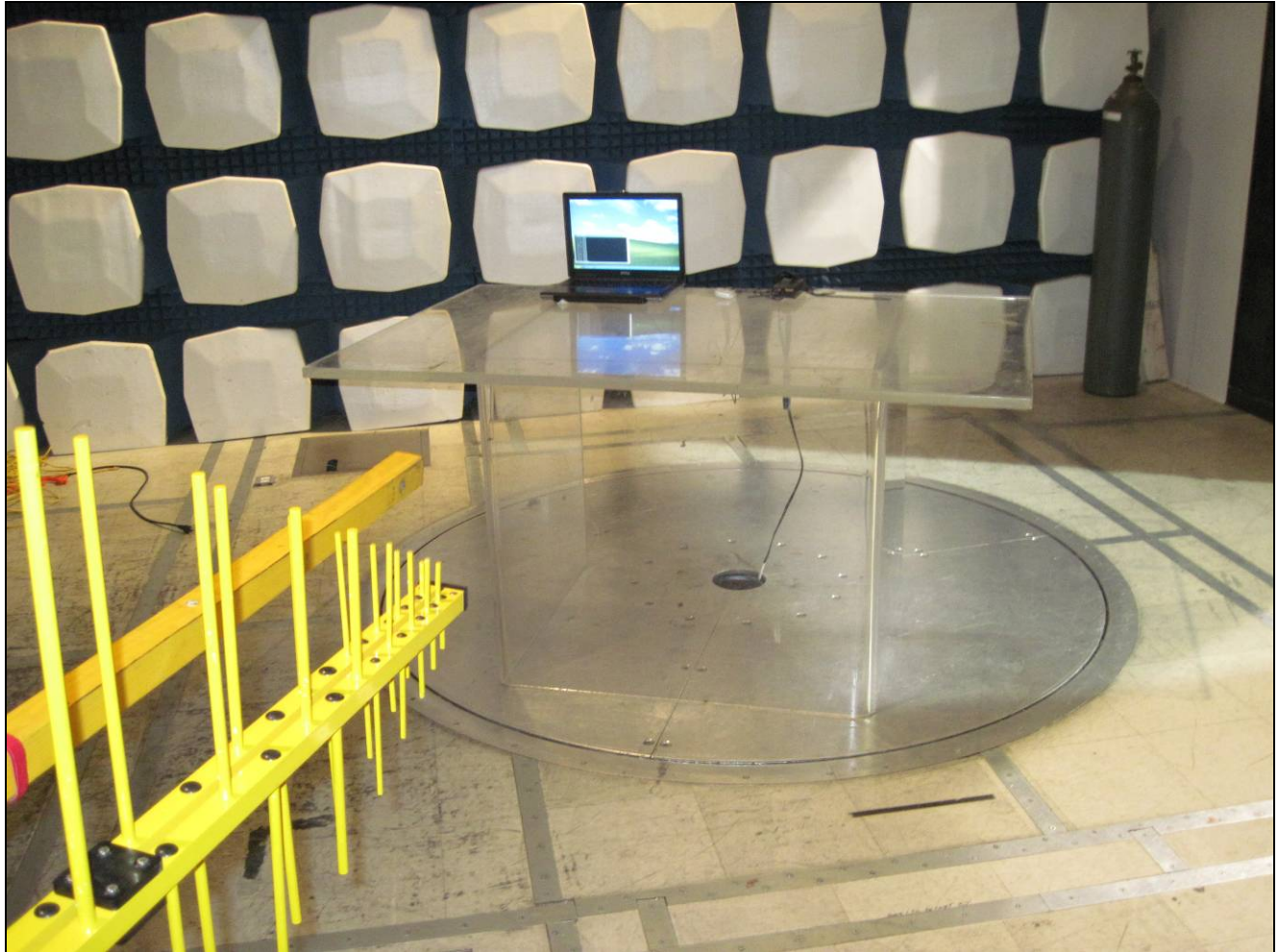
Note: The EUT was tested at 3 m.



**Plot 4. Radiated Emissions, ICES-003 Limits**



## Radiated Emission Limits Test Setup



**Photograph 3. Radiated Emission, Test Setup**

## **IV. Electromagnetic Compatibility Criteria for Intentional Radiators**

## Electromagnetic Compatibility Criteria for Intentional Radiators

### § 15.203 Antenna Requirement

**Test Requirement:**

**§ 15.203:** An intentional radiator shall be designed to ensure that no antenna other than that furnished by the responsible party shall be used with the device. The use of a permanently attached antenna or of an antenna that uses a unique coupling to the intentional radiator shall be considered sufficient to comply with the provisions of this section. The manufacturer may design the unit so that a broken antenna can be replaced by the user, but the use of a standard antenna jack or electrical connector is prohibited.

The structure and application of the EUT were analyzed to determine compliance with Section 15.203 of the Rules. Section 15.203 states that the subject device must meet at least one of the following criteria:

- a.) Antenna must be permanently attached to the unit.
- b.) Antenna must use a unique type of connector to attach to the EUT.
- c.) Unit must be professionally installed. Installer shall be responsible for verifying that the correct antenna is employed with the unit.

**Results:**

The EUT as tested is compliant the criteria of §15.203. The EUT has an integral antenna of -0.5 dBi gain.

**Test Engineer(s):**

Len Knight

**Test Date(s):**

07/20/10

## Electromagnetic Compatibility Criteria for Intentional Radiators

### § 15.207 Conducted Emissions Limits

**Test Requirement(s):** § 15.207 (a): For an intentional radiator that is designed to be connected to the public utility (AC) power line, the radio frequency voltage that is conducted back onto the AC power line on any frequency or frequencies, within the band 150 kHz to 30MHz, shall not exceed the limits in the following table, as measured using a 50  $\mu$ H/50  $\Omega$  line impedance stabilization network (LISN). Compliance with the provisions of this paragraph shall be based on the measurement of the radio frequency voltage between each power line and ground at the power terminal. The lower limit applies at the boundary between the frequency ranges.

Frequency range (MHz)	§ 15.207(a), Conducted Limit (dB $\mu$ V)	
	Quasi-Peak	Average
* 0.15- 0.45	66 - 56	56 - 46
0.45 - 0.5	56	46
0.5 - 30	60	50

**Table 13. Conducted Limits for Intentional Radiators from FCC Part 15 § 15.207(a)**

**Test Results:** The EUT was not applicable with this requirement. The unit is powered by a rechargeable battery. When the unit is plugged into the computer for either data download or charging, the transmitter is disabled.

## Electromagnetic Compatibility Criteria for Intentional Radiators

### § 15.247(a) Bandwidth & Channelization Requirements

**Test Requirements:** § 15.247(a): Operation under the provisions of this section is limited to frequency hopping and digitally modulated intentional radiators that comply with the following provisions:

For systems using digital modulation techniques, the EUT may operate in the 902-928 MHz, 2400-2483.5 MHz and 5725-5850 MHz bands. For DTS, the minimum 6 dB bandwidth shall be at least 500 kHz. For frequency hopping systems, the EUT shall have hopping channel carrier frequencies separated by a minimum of 25 kHz or the 20 dB bandwidth of the hopping channel, whichever is greater.

**Test Procedure:** The bandwidth of the fundamental frequency was measured with the spectrum analyzer using a RBW approximately equal to 1% of the total emission bandwidth. The 20 dB bandwidth was measured and recorded.

**Test Results** The EUT was compliant with § 15.247 (a).

**Test Engineer(s):** Len Knight

**Test Date(s):** 08/02/10

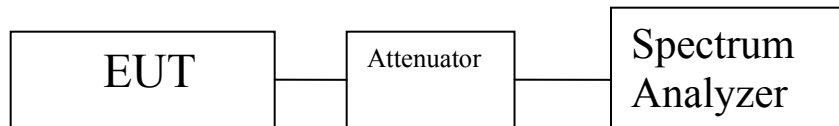
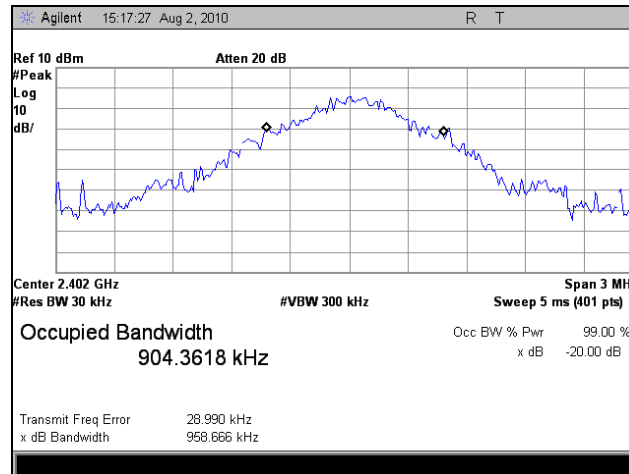
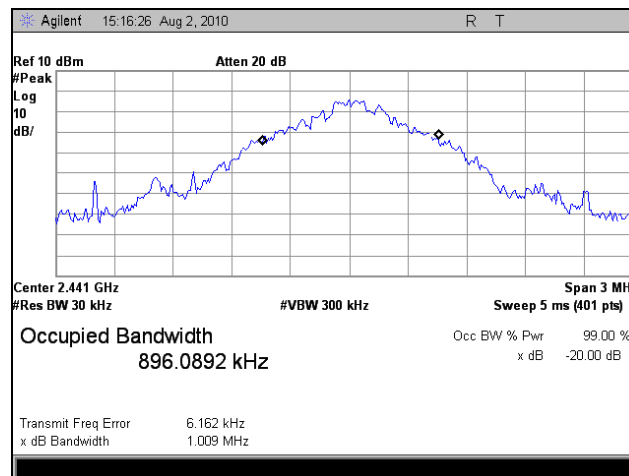


Figure 3. Block Diagram, Occupied Bandwidth Test Setup

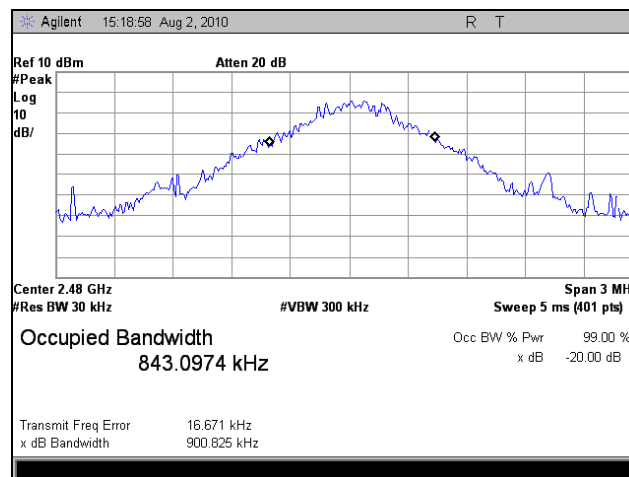
## Occupied Bandwidth Test Results



Plot 5. Occupied Bandwidth, Low Channel



Plot 6. Occupied Bandwidth, Mid Channel



Plot 7. Occupied Bandwidth, High Channel



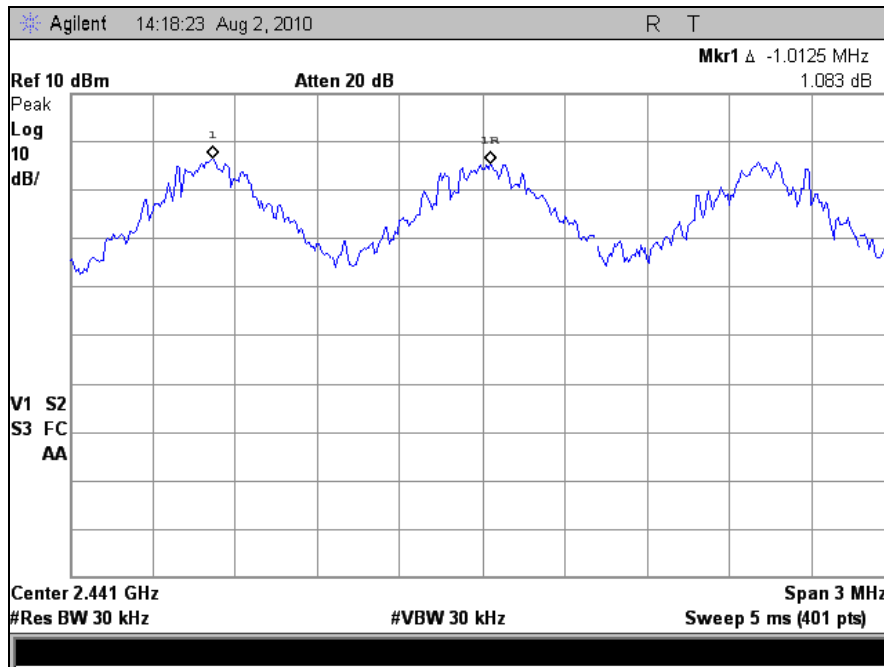


**Photograph 4. Occupied Bandwidth, Test Setup**

## Electromagnetic Compatibility Criteria for Intentional Radiators

### § 15.247 Carrier Frequency Separation

**Remarks:** Total hopping channels = 60. The EUT meets the specifications of **Section 15.247(a) (1) (iii)** for Number of Hopping Channels.

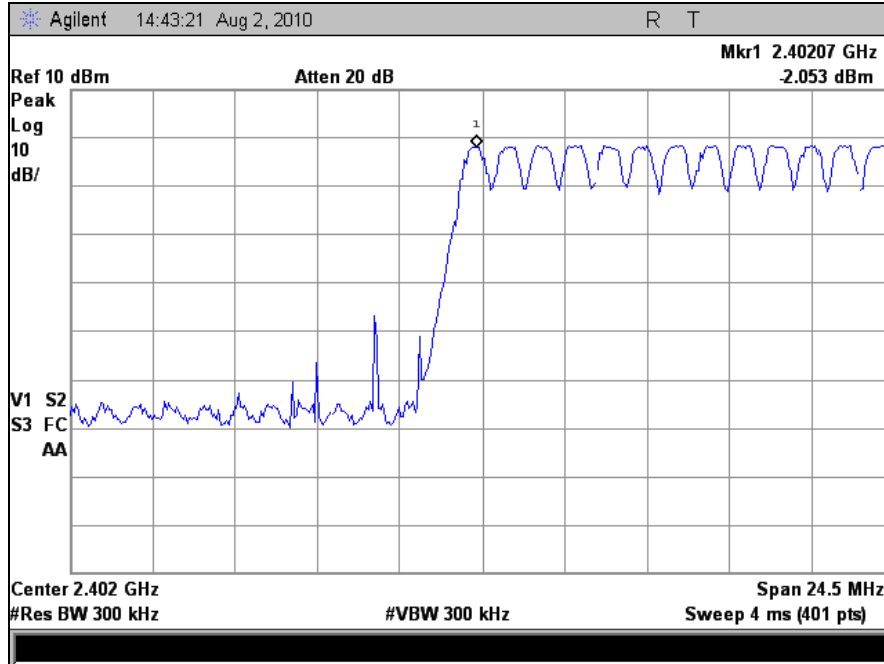


Plot 8. Channel Separation

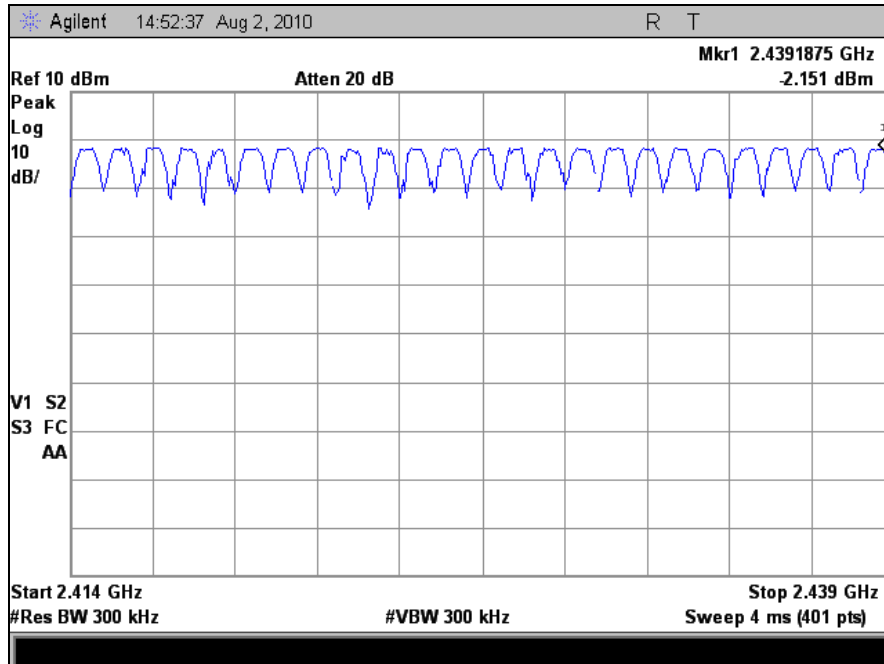


## Electromagnetic Compatibility Criteria for Intentional Radiators

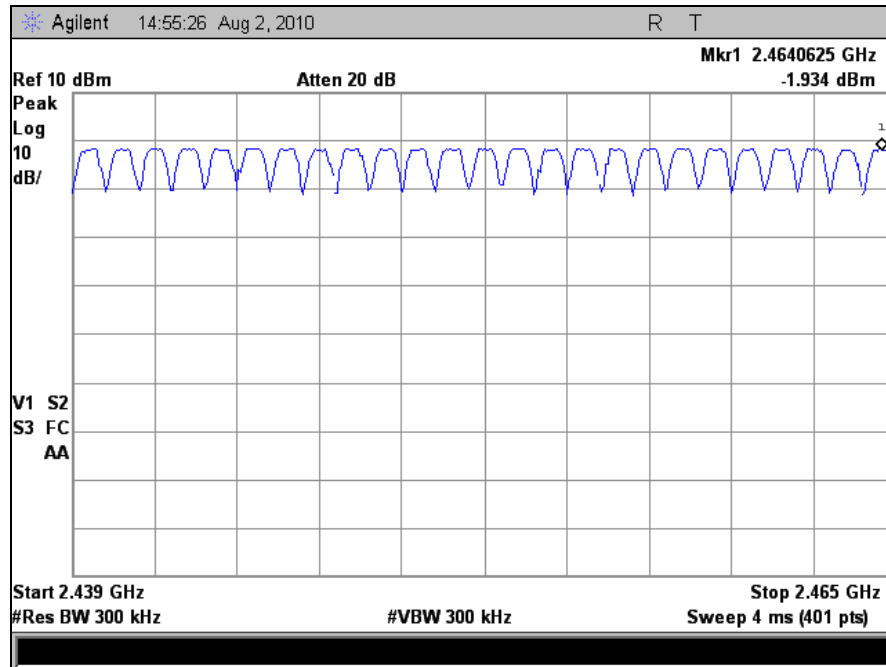
### § 15.247 Number of Hopping Channels



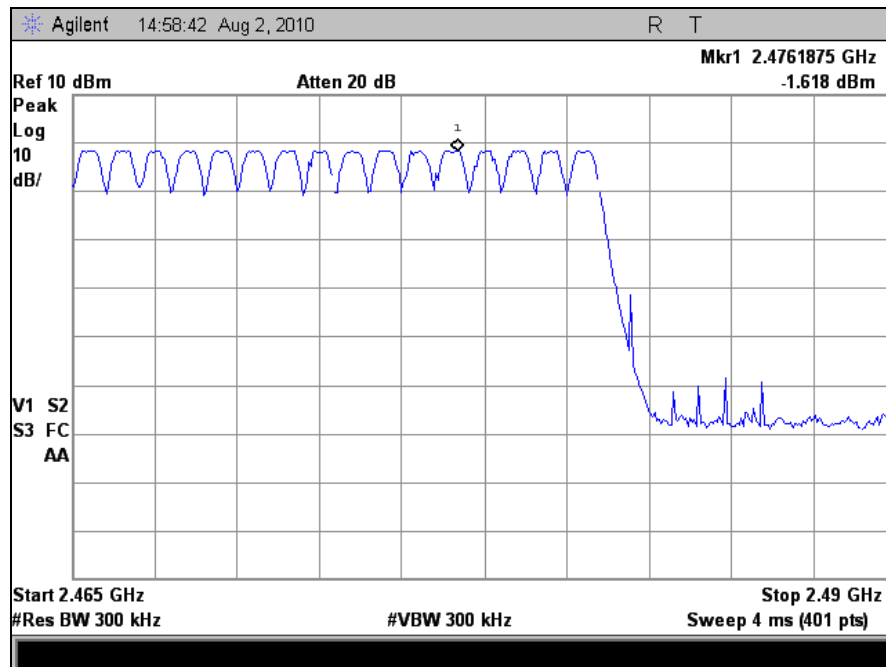
Plot 9. Bottom Half of Frequency Range, 1



Plot 10. Bottom Half of Frequency Range, 2



Plot 11. Top Half of Frequency Range, 1



Plot 12. Top Half of Frequency Range, 2

## Electromagnetic Compatibility Criteria for Intentional Radiators

### § 15.247 Time of Occupancy

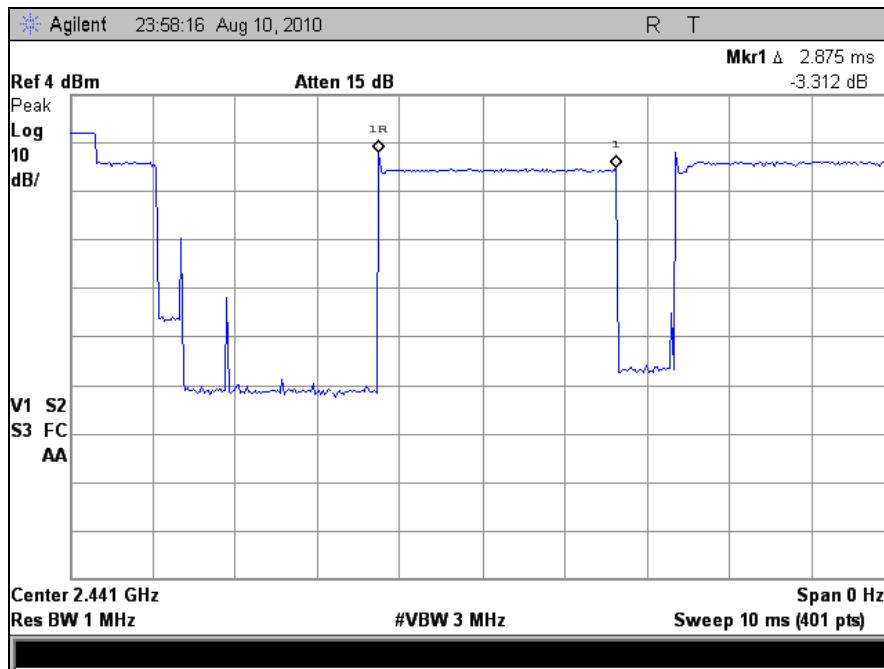
**Remarks:** The average time of occupancy on any frequency shall not be greater than 0.4 seconds within a 20 second period.

1 event was captured in 20 seconds.

Packet Type	Burst Duration in one hop (us)	Test Results		
		Dwell Time (ms)	Limit (ms)	Result
DH 5	2875	306.67	400	Pass

**Table 14. Time Occupancy, Test Results**

$$2.875 * (1600/6) / 79 * 31.6 = 306.67(\text{ms})$$



**Plot 13. Time Occupancy**

Note: The sample provided for testing only operated with Packet Type DH 5.

## Electromagnetic Compatibility Criteria for Intentional Radiators

### § 15.247(b) Peak Power Output

**Test Requirements:** §15.247(b): The maximum peak output power of the intentional radiator shall not exceed the following:

Digital Transmission Systems (MHz)	Output Limit (Watts)
902-928	1.000
2400-2483.5	1.000
5725- 5850	1.000

**Table 15. Output Power Requirements from §15.247**

§15.247(c): if transmitting antennas of directional gain greater than 6 dBi are used the peak output power from the intentional radiator shall be reduced below the stated values in the Table 15, as appropriate, by the amount in dB that the directional gain of the antenna exceeds 6 dBi.

Systems operating in the 2400 – 2483.5 MHz band and using a point to point application may employ transmitting antennas with directional gain greater than 6 dBi provided the maximum peak output power of the intentional radiator is reduced by 1 dB for every 3 dB that the directional gain of the antenna exceeds 6 dBi.

Systems operating in the 5725 – 5850 MHz band that are used exclusively for fixed, point-to-point operations may employ transmitting antennas with directional gain greater than 6 dBi without any corresponding reduction in transmitter peak output power.

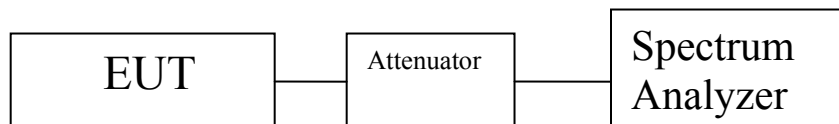
Fixed, point-to-point operation excludes the use of point-to-multipoint systems, omnidirectional applications, and multiple co-located intentional radiators transmitting the same information. The operator of the spread spectrum intentional radiator or, if the equipment is professionally installed, the installer is responsible for ensuring that the system is used exclusively for fixed, point-to-point operations. The instruction manual furnished with the intentional radiator shall contain language in the installation instructions informing the operator and the installer of this responsibility.

**Test Procedure:** The transmitter was connected to a calibrated spectrum analyzer. The EUT was measured at the low, mid and high channels of each band at the maximum power level.

**Test Results:** The EUT was compliant with the Peak Power Output limits of §15.247(b).

**Test Engineer(s):** Len Knight

**Test Date(s):** 08/02/10



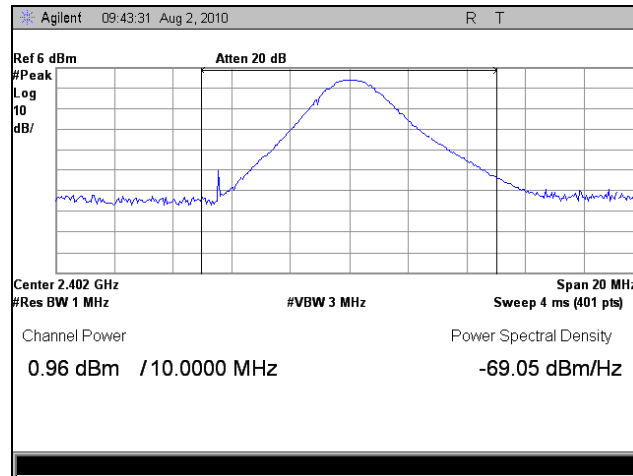
**Figure 4. Peak Power Output Test Setup**

## RF Power Output Test Results

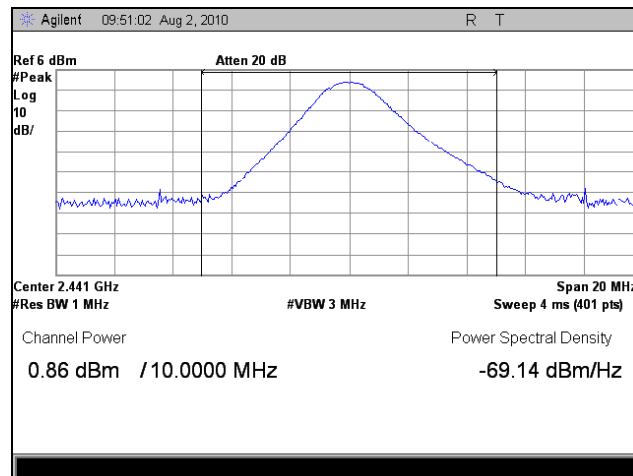
Peak Conducted Output Power		
Carrier Channel	Frequency (MHz)	Measured Peak Output Power dBm
Low	2402	0.96
Mid	2441	0.86
High	2480	0.88

Table 16. RF Output Power Test Results

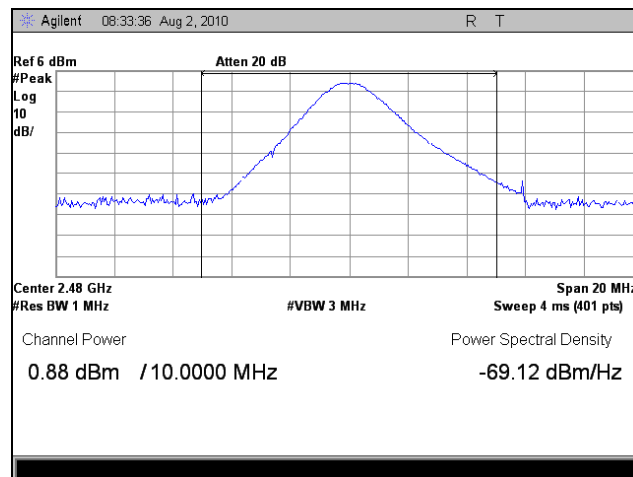
## RF Output Power Test Results



Plot 14. Peak Output Power, Low Channel, Channel Integration



Plot 15. Peak Output Power, Mid Channel, Channel Integration



Plot 16. Peak Output Power, High Channel, Channel Integration



**Photograph 5. Conducted Power, Test Setup**

## Electromagnetic Compatibility Criteria for Intentional Radiators

### § 15.247(d) Harmonic Emissions – Radiated

**Test Requirements:** §15.247(d); §15.205: Emissions outside the frequency band.

**§15.247(d):** In any 100 kHz bandwidth outside the frequency band in which the spread spectrum or digitally modulated intentional radiator is operating, the radio frequency power that is produced by the intentional radiator shall be at least 20 dB below that in the 100 kHz bandwidth within the band that contains the highest level of the desired power, based on either an RF conducted or a radiated measurement. Attenuation below the general limits specified in § 15.209(a) is not required. In addition, radiated emissions which fall in the restricted bands, as defined in § 15.205(a), must also comply with the radiated emission limits specified in § 15.209(a).

**§15.205(a):** Except as shown in paragraph (d) of this section, only spurious emissions are permitted in any of the frequency bands listed below:

MHz	MHz	MHz	GHz
0.090–0.110-----	16.42–16.423	399.9–410	4.5–5.15
<sup>1</sup> 0.495–0.505-----	16.69475–16.69525	608–614	5.35–5.46
2.1735–2.1905-----	16.80425–16.80475	960–1240	7.25–7.75
4.125–4.128-----	25.5–25.67	1300–1427	8.025–8.5
4.17725–4.17775-----	37.5–38.25	1435–1626.5	9.0–9.2
4.20725–4.20775-----	73–74.6	1645.5–1646.5	9.3–9.5
6.215–6.218-----	74.8–75.2	1660–1710	10.6–12.7
6.26775–6.26825-----	108–121.94	1718.8–1722.2	13.25–13.4
6.31175–6.31225-----	123–138	2200–2300	14.47–14.5
8.291–8.294-----	149.9–150.05	2310–2390	15.35–16.2
8.362–8.366-----	156.52475–156.52525	2483.5–2500	17.7–21.4
8.37625–8.38675-----	156.7–156.9	2655–2900	22.01–23.12
8.41425–8.41475-----	162.0125–167.17	3260–3267	23.6–24.0
12.29–12.293-----	167.72–173.2	3332–3339	31.2–31.8
12.51975–12.52025-----	240–285	3345.8–3358 36.	43–36.5
12.57675–12.57725-----	322–335.4	3600–4400	( <sup>2</sup> )

**Table 17. Restricted Bands of Operation**

<sup>1</sup> Until February 1, 1999, this restricted band shall be 0.490 – 0.510 MHz.

<sup>2</sup> Above 38.6



**Test Requirement(s):** § 15.209 (a): Except as provided elsewhere in this subpart, the emissions from an intentional radiator shall not exceed the field strength levels specified in Table 18.

Frequency (MHz)	§ 15.209(a), Radiated Emission Limits (dBµV) @ 3m
30 - 88	40.00
88 - 216	43.50
216 - 960	46.00
Above 960	54.00

**Table 18. Radiated Emissions Limits Calculated from FCC Part 15, § 15.209 (a)**

**Test Procedure:** The transmitter was set to the mid channel at the highest output power and placed on a 0.8 m high wooden table inside in a semi-anechoic chamber. Measurements were performed with the EUT rotated 360 degrees and varying the adjustable antenna mast with 1 m to 4 m height to determine worst case orientation for maximum emissions. Measurement were repeated the measurement at the low and highest channels.

For frequencies from 30 MHz to 1 GHz, measurements were made using a quasi-peak detector with a 120 kHz bandwidth.

For intentional radiators with a digital device portion which operates below 10 GHz, the spectrum was investigated as per §15.33(a)(1) and §15.33(a)(4); i.e., the lowest RF signal generated or used in the device up to the 10th harmonic of the highest fundamental frequency or to 40 GHz, whichever is lower.

In accordance with §15.35(b) the limit on the radio frequency emissions as measured using instrumentation with a peak detector function shall be 20 dB above the maximum permitted average limit for the frequency being investigated unless a different peak emission limit is otherwise specified in the rules.

EUT Field Strength Final Amplitude = Raw Amplitude – Preamp gain + Antenna Factor + Cable Loss – Distance Correction Factor

**Test Results:** The EUT was compliant with the Radiated Spurious Emission limits of § 15.247(d). The data presented is peak data against a quasi-peak limit line.

**Test Engineer(s):** Len Knight

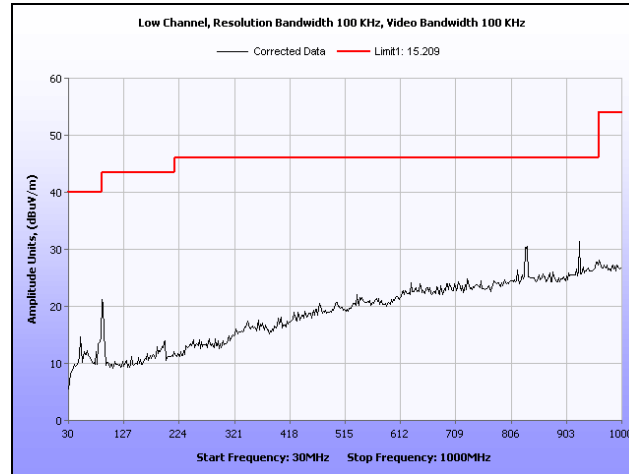
**Test Date(s):** 08/18/10

## Harmonic Emissions Requirements – Radiated

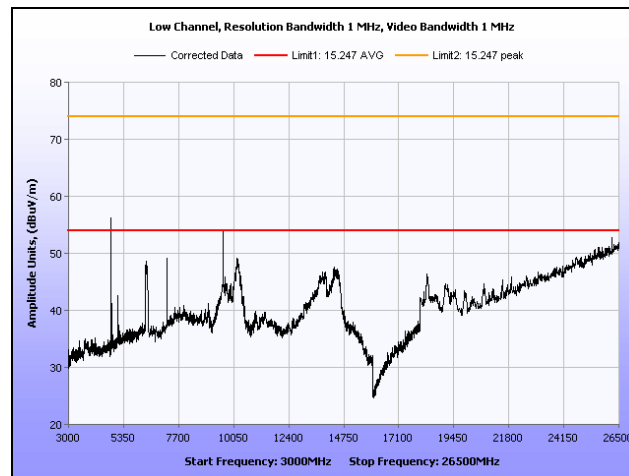
Channel	Frequency (GHz)	Raw Amplitude		Distance Correction Factor (dB)	Antenna Correction Factor (dB/m)	Gain (dB)	Corrected Data		Limit		Margin	
		Peak (dBµV)	Average (dBµV)				Peak (dBµV)	Average (dBµV)	Peak (dBµV)	Average (dBµV)	Peak (dBµV)	Average (dBµV)
Low	4.80391	63.72	54.57	-15.56	34.26	-26.52	55.9	46.75	74	54	-18.1	-7.25
	7.2056	72.33	54.81	-17.5	35.666	-28.24	62.256	44.736	74	54	-11.744	-9.264
	9.6081	49.6	45.07	-20	37.2	-24.7	42.1	37.57	74	54	-31.9	-16.43
Mid	4.8819	65.32	57.28	-15.56	34.08	-26.31	57.53	49.49	74	54	-16.47	-4.51
	7.3222	71.57	52.43	-17.5	35.63	-28.39	61.31	42.17	74	54	-12.69	-11.83
	9.7641	52.09	46.07	-20	37.27	-24.14	45.22	39.2	74	54	-28.78	-14.8
High	4.9599	66.13	57.91	-15.56	34.06	-28.5	56.13	47.91	74	54	-17.87	-6.09
	7.4396	68.06	48.44	-17.5	35.72	-28.22	58.06	38.44	74	54	-15.94	-15.56
	9.92	53.85	47.4	-20	37.39	-25.15	46.09	39.64	74	54	-27.91	-14.36
Hop	4.8561	63.02	47.66	-15.56	34.14	-26.38	55.22	39.86	74	54	-18.78	-14.14
	7.2115	65.01	42.36	-17.5	35.66	-28.25	54.92	32.27	74	54	-19.08	-21.73
	9.732	50.9	39.83	-20	37.24	-24.48	43.66	32.59	74	54	-30.34	-21.41

Table 19. Radiated Harmonic Emissions

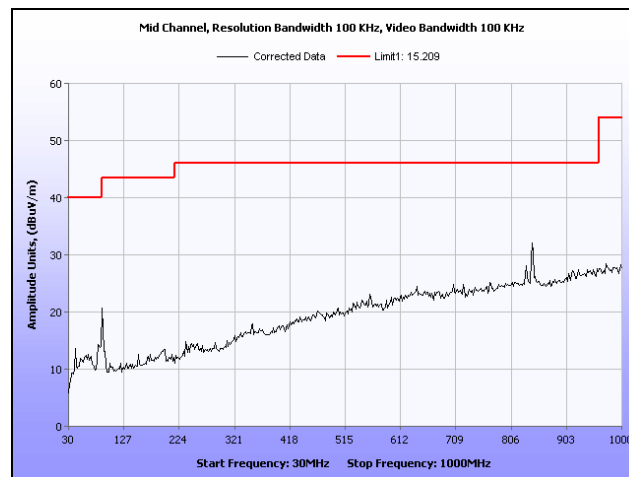
## Radiated Spurious Emissions Test Results



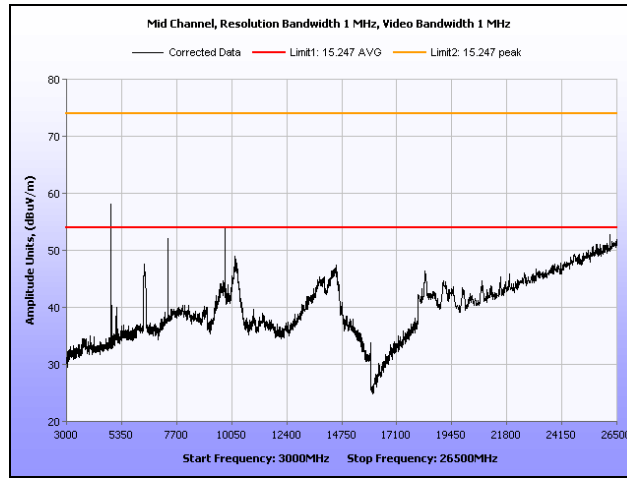
Plot 17. Radiated Spurious Emissions, Low Channel, 30 MHz – 1 GHz



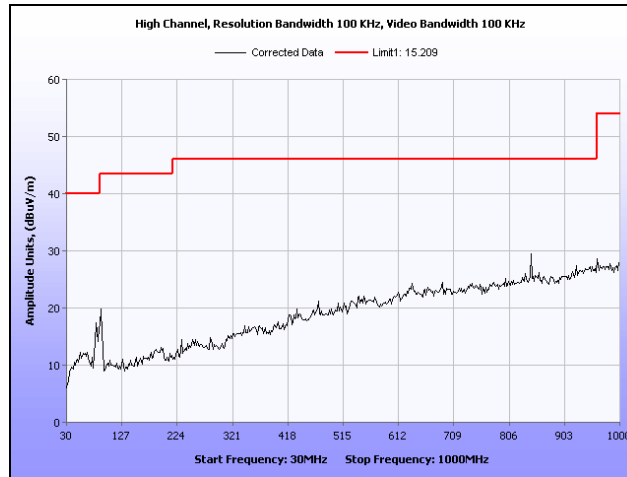
Plot 18. Radiated Spurious Emissions, Low Channel, 3 GHz – 26.5 GHz



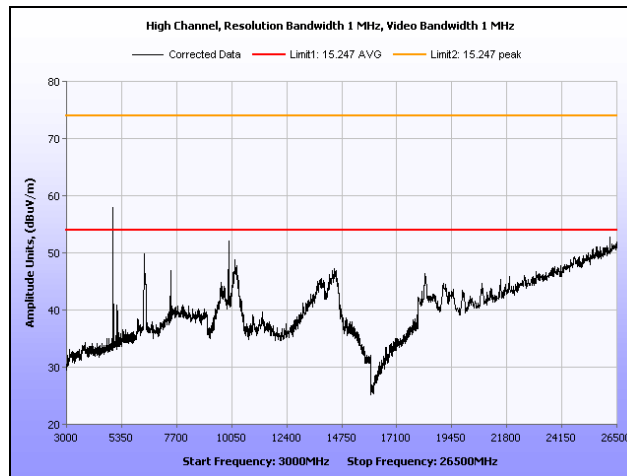
Plot 19. Radiated Spurious Emissions, Mid Channel, 30 MHz – 1 GHz



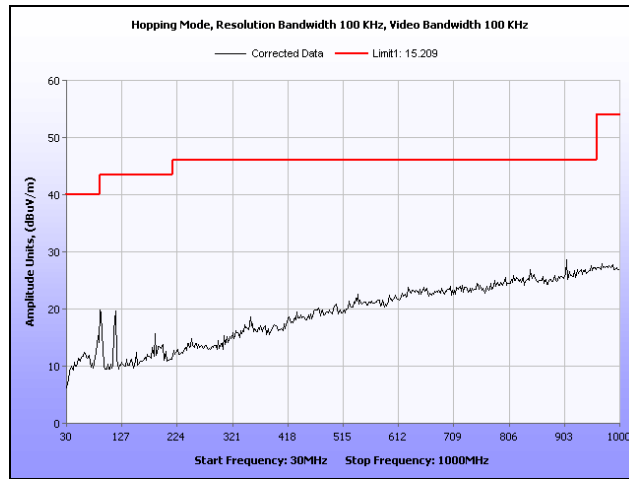
**Plot 20. Radiated Spurious Emissions, Mid Channel, 3 GHz – 26.5 GHz**



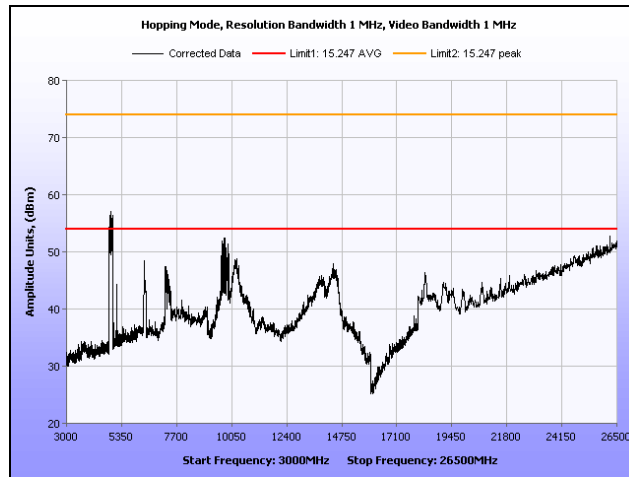
**Plot 21. Radiated Spurious Emissions, High Channel, 30 MHz – 1 GHz**



**Plot 22. Radiated Spurious Emissions, High Channel, 3 GHz – 26.5 GHz**



Plot 23. Radiated Spurious Emissions, Hopping Mode, 30 MHz – 1 GHz

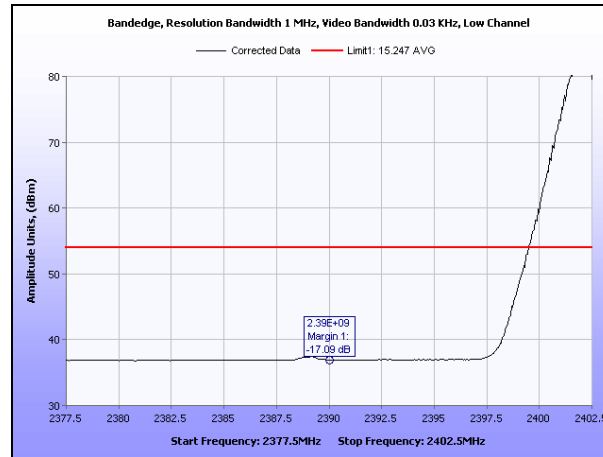


Plot 24. Radiated Spurious Emissions, Hopping Mode, 3 GHz – 26.5 GHz

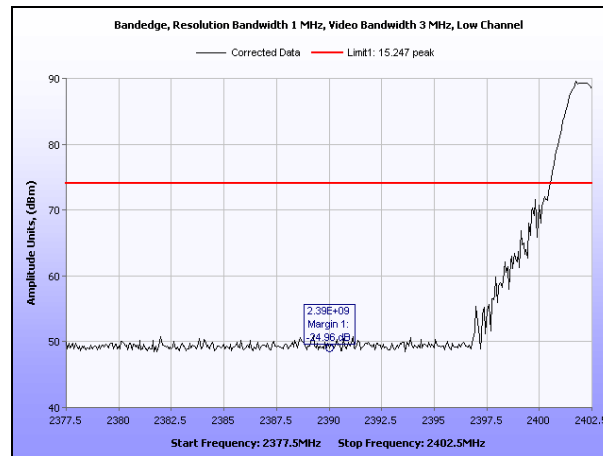
## Radiated Band Edge Measurements

### Test Procedures:

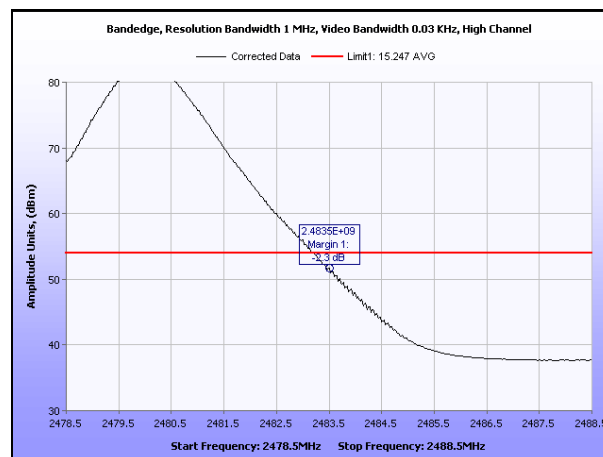
The transmitter was turned. Measurements were performed of the low, mid and high Channels. The EUT was rotated orthogonally through all three axes. Plots shown are corrected for both antenna correction factor and distance and compared to a 3 m limit like.



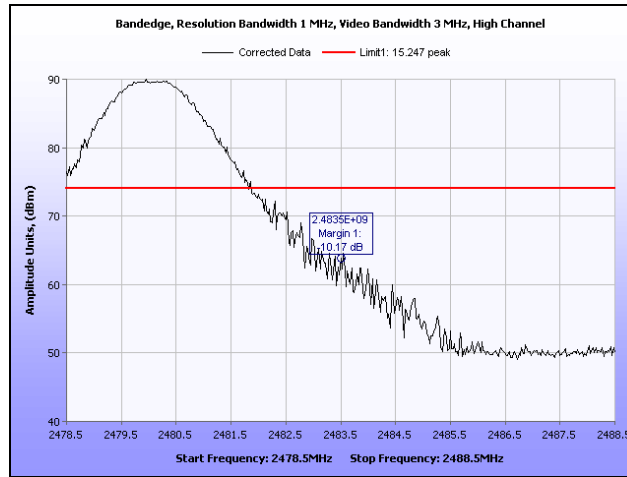
Plot 25. Radiated Restricted Band Edge, Low Channel, Average



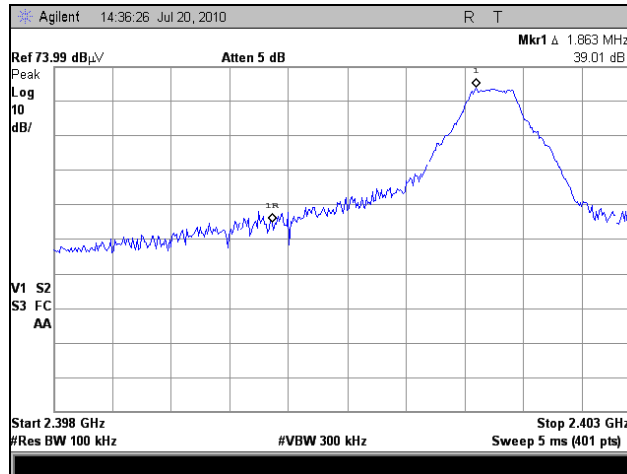
Plot 26. Radiated Restricted Band Edge, Low Channel, Peak



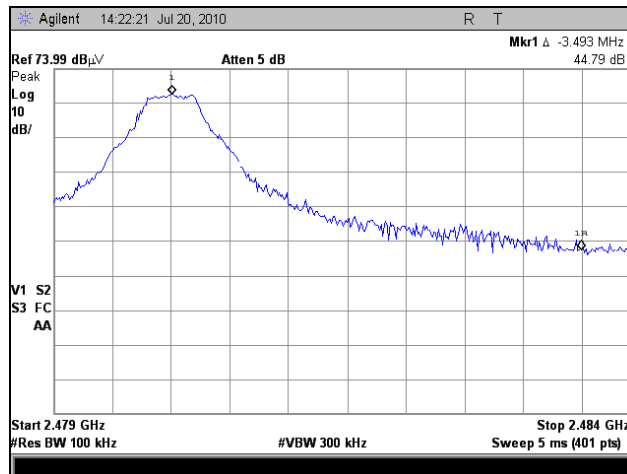
Plot 27. Radiated Restricted Band Edge, High Channel, Average



Plot 28. Radiated Restricted Band Edge, High Chanel, Peak

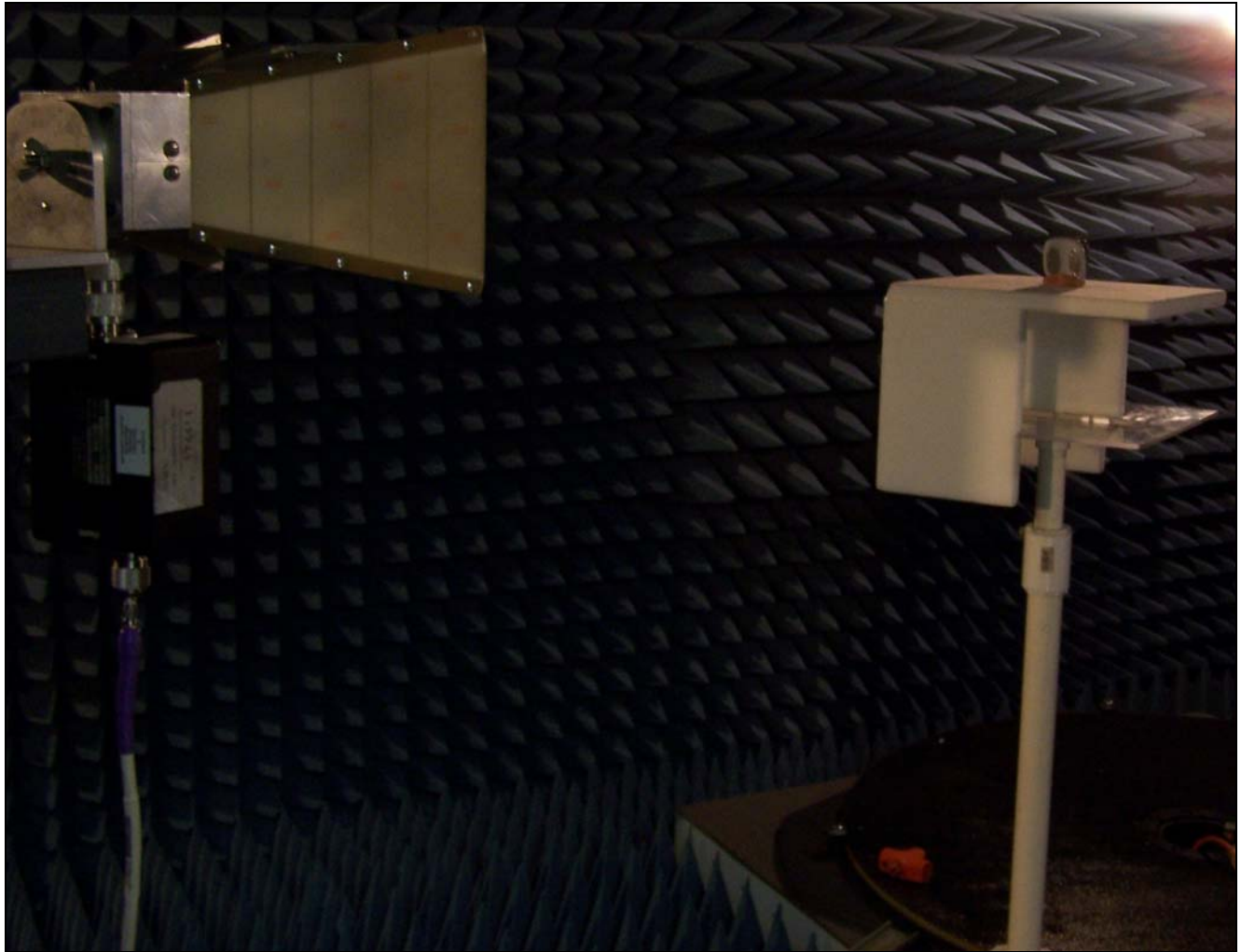


Plot 29. 20dBc Requirement, Low Channel



Plot 30. 20dBc Requirement, High Channel

## Radiated Spurious Emissions Test Setup



**Photograph 6. Radiated Spurious Emissions, Test Setup**



## Electromagnetic Compatibility Criteria for Intentional Radiators

### § 15.247(d) Spurious Emissions Requirements –RF Conducted

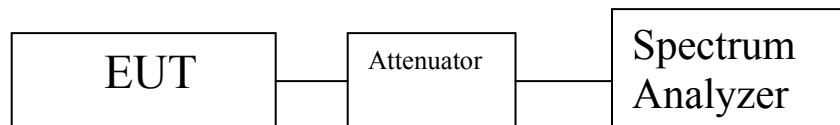
**Test Procedure:** For intentional radiators with a digital device portion which operates below 10 GHz, the spectrum was investigated as per §15.33(a)(1) and §15.33(a)(4); i.e., the lowest RF signal generated or used in the device up to the 10<sup>th</sup> harmonic of the highest fundamental frequency or to 40 GHz, whichever is lower.

For frequencies 1-18GHz, measurements were made at coupler port of a 20dB directional coupler. The output of the coupler was terminated by a 50Ω load. For frequencies 18-40GHz a HP11970A and HP11970K harmonic mixer was used. Each harmonic mixer was fed with a SMA to wave guide adapter.

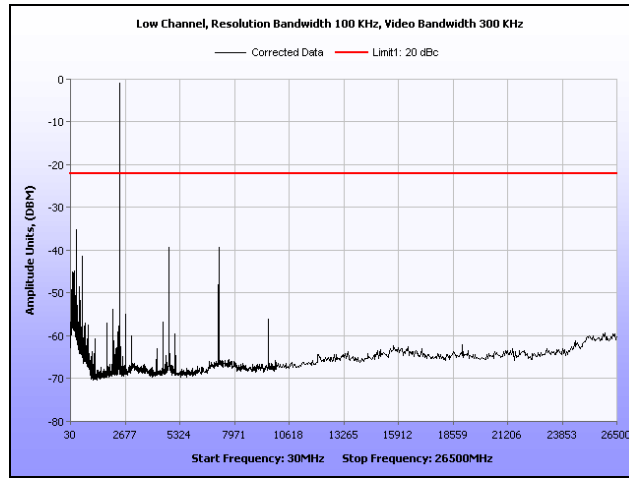
**Test Results:** Equipment complies with the Spurious Emissions Requirements – Radiated and RF Conducted limits of § 15.247 (d). For Radiated Emissions result, refer to section “§15.209: Radiated Emission Limits”. See following pages for detailed test results with RF Conducted Spurious Emissions and §15.205.

**Test Engineer(s):** Len Knight

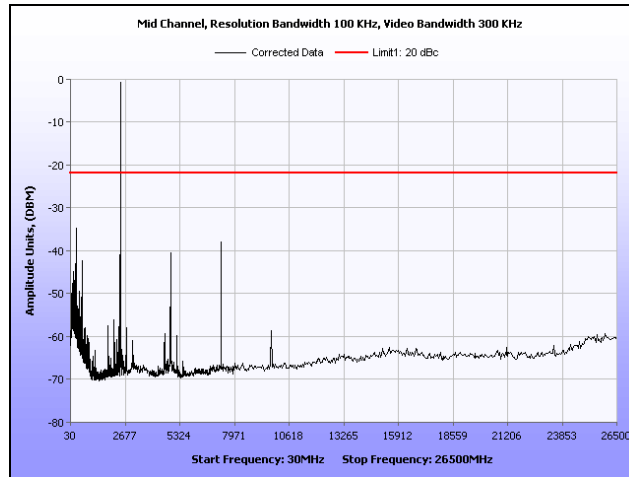
**Test Date(s):** 08/02/10



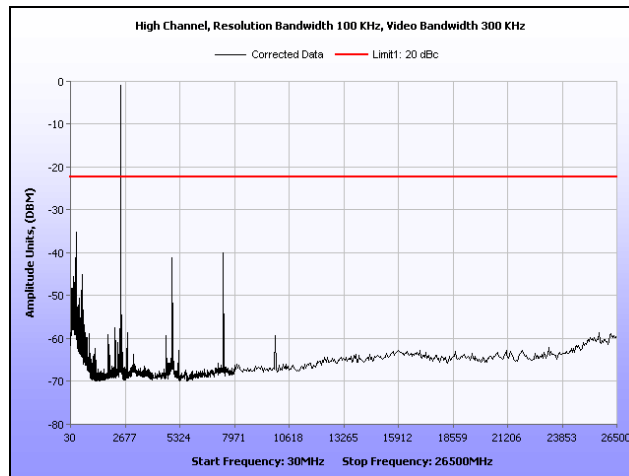
**Block Diagram 1. Spurious Conducted Emissions Test Setup**



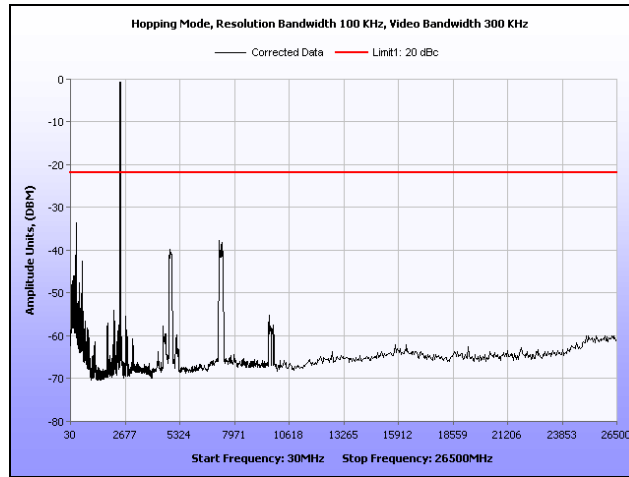
Plot 31. Conducted Spurious Emissions, Low Channel



Plot 32. Conducted Spurious Emissions, Mid Channel



Plot 33. Conducted Spurious Emissions, High Channel



**Plot 34. Conducted Spurious Emissions, Hopping Mode**

## Electromagnetic Compatibility Criteria for Intentional Radiators

### RSS-GEN Receiver Spurious Emissions Requirements

**Test Requirements:** The following receiver spurious emission limits shall be complied with:

- (a) If a radiated measurement is made, all spurious emissions shall comply with the limits of Table 20.

Spurious Frequency (MHz)	Field Strength (microvolt/m at 3 metres)
30 – 88	100
88 – 216	150
216 – 960	200
Above 960	500

**Table 20. Spurious Emission Limits for Receivers**

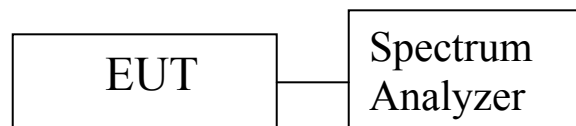
- (b) If a conducted measurement is made, no spurious output signals appearing at the antenna terminals shall exceed 2 nanowatts per any 4 kHz spurious frequency in the band 30-1000 MHz, or 5 nanowatts above 1 GHz.

**Test Procedures:** The EUT was programmed for receive mode only. Conducted measurements were taken at the antenna port of the EUT. 100 kHz resolution bandwidth was used from 30 MHz - 1 GHz and 300 kHz resolution was used for measurements done above 1 GHz. All plots are corrected for cable loss.

**Test Results:** Equipment is compliant with the Receiver Spurious Emissions Requirements of RSS-GEN.

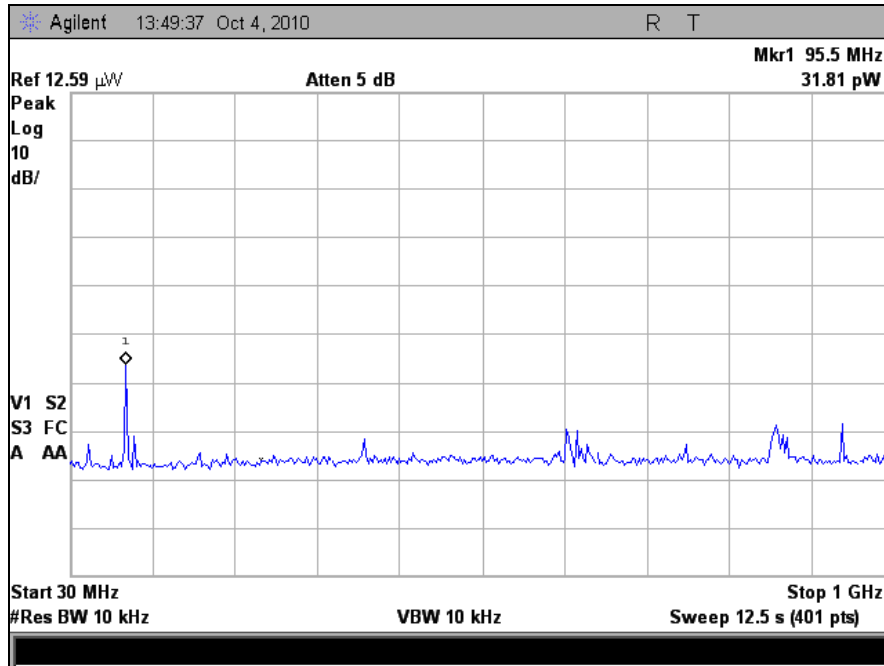
**Test Engineer(s):** Len Knight

**Test Date(s):** 10/04/10

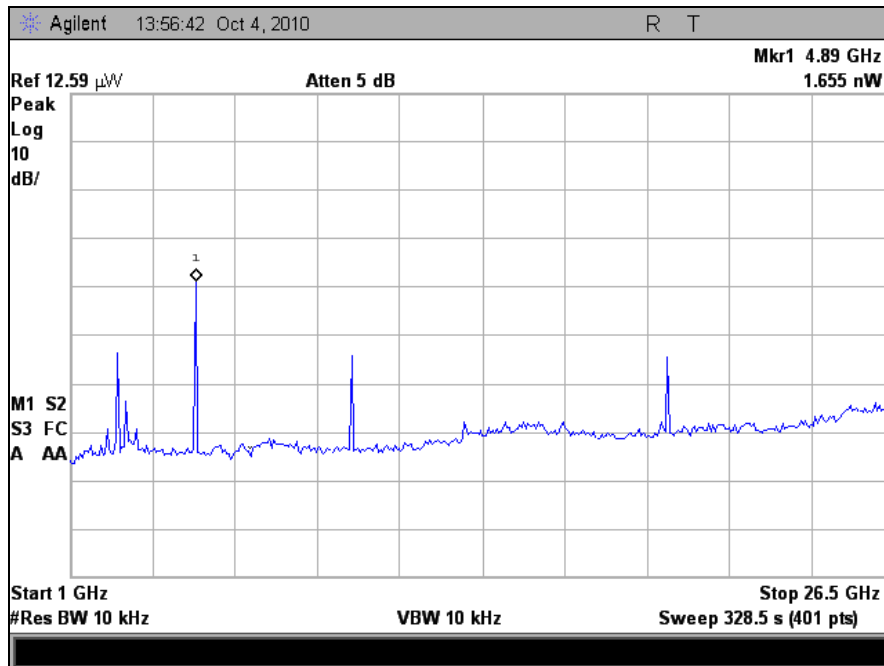


**Figure 5. Block Diagram, Conducted Receiver Spurious Emissions Test Setup**

### Conducted Receiver Spurious Emissions



**Plot 35. Receiver Spurious Emission, 30 MHz – 1 GHz**



**Plot 36. Receiver Spurious Emission, 1 GHz – 26.5 GHz**

## IV. Test Equipment

## Test Equipment

Calibrated test equipment utilized during testing was maintained in a current state of calibration per the requirements of ANSI/NCSL Z540-1-1994 and ANSI/ISO/IEC 17025:2000.

MET Asset #	Equipment	Manufacturer	Model	Last Cal Date	Cal Due Date
1T4409	EMI RECEIVER	ROHDE & SCHWARZ	ESIB7	05/25/2010	05/25/2011
1S2485	BILOG ANTENNA	TESEQ	CBL 6112D	05/07/2010	05/07/2011
1T2511	ANTENNA; HORN	EMCO	3115	08/31/2010	08/31/2011
1T4414	MICROWAVE PRE-AMPLIFIER	A.H. SYSTEMS	PAM-0118	SEE NOTE	
1T4612	ESA-E SERIES SPECTRUM ANALYZER	AGILENT	E4407B	09/09/2009	09/09/2010
1T4300	SEMI-ANECHOIC CHAMBER # 1	EMC TEST SYSTEMS	NONE	8/23/2010	8/23/2013

**Table 21. Test Equipment List**

Note: Functionally tested equipment is verified using calibrated instrumentation at the time of testing.

a



## **V. Certification & User's Manual Information**





## Certification & User's Manual Information

### A. Certification Information

The following is extracted from Title 47 of the Code of Federal Regulations, Part 2, Subpart I — Marketing of Radio frequency devices:

#### § 2.801 Radio-frequency device defined.

As used in this part, a radio-frequency device is any device which in its operation is capable of Emitting radio-frequency energy by radiation, conduction, or other means. Radio- frequency devices include, but are not limited to:

- (a) The various types of radio communication transmitting devices described throughout this chapter.
- (b) *The incidental, unintentional and intentional radiators defined in Part 15 of this chapter.*
- (c) The industrial, scientific, and medical equipment described in Part 18 of this chapter.
- (d) Any part or component thereof which in use emits radio-frequency energy by radiation, conduction, or other means.

#### § 2.803 Marketing of radio frequency devices prior to equipment authorization.

- (a) Except as provided elsewhere in this chapter, no person shall sell or lease, or offer for sale or lease (including advertising for sale or lease), or import, ship or distribute for the purpose of selling or leasing or offering for sale or lease, any radio frequency device unless:
  - (1) In the case of a device subject to certification, such device has been authorized by the Commission in accordance with the rules in this chapter and is properly identified and labeled as required by §2.925 and other relevant sections in this chapter; or
  - (2) In the case of a device that is not required to have a grant of equipment authorization issued by the Commission, but which must comply with the specified technical standards prior to use, such device also complies with all applicable administrative (including verification of the equipment or authorization under a Declaration of Conformity, where required), technical, labeling and identification requirements specified in this chapter.
- (d) Notwithstanding the provisions of paragraph (a) of this section, the offer for sale solely to business, commercial, industrial, scientific or medical users (but not an offer for sale to other parties or to end users located in a residential environment) of a radio frequency device that is in the conceptual, developmental, design or pre-production stage is permitted prior to equipment authorization or, for devices not subject to the equipment authorization requirements, prior to a determination of compliance with the applicable technical requirements *provided* that the prospective buyer is advised in writing at the time of the offer for sale that the equipment is subject to the FCC rules and that the equipment will comply with the appropriate rules before delivery to the buyer or to centers of distribution.

- (e)(1) Notwithstanding the provisions of paragraph (a) of this section, prior to equipment authorization or determination of compliance with the applicable technical requirements any radio frequency device may be operated, but not marketed, for the following purposes and under the following conditions:
- (i) *Compliance testing*;
  - (ii) Demonstrations at a trade show provided the notice contained in paragraph (c) of this section is displayed in a conspicuous location on, or immediately adjacent to, the device;
  - (iii) Demonstrations at an exhibition conducted at a business, commercial, industrial, scientific or medical location, but excluding locations in a residential environment, provided the notice contained in paragraphs (c) or (d) of this section, as appropriate, is displayed in a conspicuous location on, or immediately adjacent to, the device;
  - (iv) Evaluation of product performance and determination of customer acceptability, provided such operation takes place at the manufacturer's facilities during developmental, design or pre-production states; or
  - (v) Evaluation of product performance and determination of customer acceptability where customer acceptability of a radio frequency device cannot be determined at the manufacturer's facilities because of size or unique capability of the device, provided the device is operated at a business, commercial, industrial, scientific or medical user's site, but not at a residential site, during the development, design or pre-production stages.
- (e)(2) For the purpose of paragraphs (e)(1)(iv) and (e)(1)(v) of this section, the term *manufacturer's facilities* includes the facilities of the party responsible for compliance with the regulations and the manufacturer's premises, as well as the facilities of other entities working under the authorization of the responsible party in connection with the development and manufacture, but not the marketing, of the equipment.
- (f) For radio frequency devices subject to verification and sold solely to business, commercial, industrial, scientific and medical users (excluding products sold to other parties or for operation in a residential environment), parties responsible for verification of the devices shall have the option of ensuring compliance with the applicable technical specifications of this chapter at each end user's location after installation, provided that the purchase or lease agreement includes a proviso that such a determination of compliance be made and is the responsibility of the party responsible for verification of the equipment.

## Certification & User's Manual Information

The following is extracted from Title 47 of the Code of Federal Regulations, Part 2, Subpart J — Equipment Authorization Procedures:

### § 2.901 Basis and Purpose

- (a) In order to carry out its responsibilities under the Communications Act and the various treaties and international regulations, and in order to promote efficient use of the radio spectrum, the Commission has developed technical standards for radio frequency equipment and parts or components thereof. The technical standards applicable to individual types of equipment are found in that part of the rules governing the service wherein the equipment is to be operated.<sup>1</sup> *In addition to the technical standards provided, the rules governing the service may require that such equipment be verified by the manufacturer or importer, be authorized under a Declaration of Conformity, or receive an equipment authorization from the Commission by one of the following procedures: certification or registration.*
- (b) The following sections describe the verification procedure, the procedure for a Declaration of Conformity, and the procedures to be followed in obtaining certification from the Commission and the conditions attendant to such a grant.

### § 2.907 Certification.

- (a) Certification is an equipment authorization issued by the Commission, based on representation and test data submitted by the applicant.
- (b) Certification attaches to all units subsequently marketed by the grantee which are identical (see Section 2.908) to the sample tested except for permissive changes or other variations authorized by the Commission pursuant to Section 2.1043.

---

<sup>1</sup> In this case, the equipment is subject to the rules of Part 15. More specifically, the equipment falls under Subpart B (of Part 15), which deals with unintentional radiators.

## Certification & User's Manual Information

### § 2.948 Description of measurement facilities.

- (a) Each party making measurements of equipment that is subject to an equipment authorization under Part 15 or Part 18 of this chapter, regardless of whether the measurements are filed with the Commission or kept on file by the party responsible for compliance of equipment marketed within the U.S. or its possessions, shall compile a description of the measurement facilities employed.
- (1) If the measured equipment is subject to the verification procedure, the description of the measurement facilities shall be retained by the party responsible for verification of the equipment.
- (i) *If the equipment is verified through measurements performed by an independent laboratory, it is acceptable for the party responsible for verification of the equipment to rely upon the description of the measurement facilities retained by or placed on file with the Commission by that laboratory. In this situation, the party responsible for the verification of the equipment is not required to retain a duplicate copy of the description of the measurement facilities.*
- (ii) If the equipment is verified based on measurements performed at the installation site of the equipment, no specific site calibration data is required. It is acceptable to retain the description of the measurement facilities at the site at which the measurements were performed.
- (2) If the equipment is to be authorized by the Commission under the certification procedure, the description of the measurement facilities shall be filed with the Commission's Laboratory in Columbia, Maryland. The data describing the measurement facilities need only be filed once but must be updated as changes are made to the measurement facilities or as otherwise described in this section. At least every three years, the organization responsible for filing the data with the Commission shall certify that the data on file is current.

## Certification & User's Manual Information

### Label and User's Manual Information

The following is extracted from Title 47 of the Code of Federal Regulations, Part 15, Subpart A — General:

#### § 15.19 Labeling requirements.

(a) *In addition to the requirements in Part 2 of this chapter, a device subject to certification or verification shall be labeled as follows:*

- (1) Receivers associated with the operation of a licensed radio service, e.g., FM broadcast under Part 73 of this chapter, land mobile operation under Part 90, etc., shall bear the following statement in a conspicuous location on the device:

This device complies with Part 15 of the FCC Rules. Operation is subject to the condition that this device does not cause harmful interference.

- (2) A stand-alone cable input selector switch, shall bear the following statement in a conspicuous location on the device:

This device is verified to comply with Part 15 of the FCC Rules for use with cable television service.

- (3) All other devices shall bear the following statement in a conspicuous location on the device:

*This device complies with Part 15 of the FCC Rules. Operation is subject to the following two conditions: (1) This device may not cause harmful interference, and (2) this device must accept any interference received, including interference that may cause undesired operation.*

- (4) Where a device is constructed in two or more sections connected by wires and marketed together, the statement specified under paragraph (a) of this section is required to be affixed only to the main control unit.

- (5) When the device is so small or for such use that it is not practicable to place the statement specified under paragraph (a) of this section on it, the information required by this paragraph shall be placed in a prominent location in the instruction manual or pamphlet supplied to the user or, alternatively, shall be placed on the container in which the device is marketed. However, the FCC identifier or the unique identifier, as appropriate, must be displayed on the device.

#### § 15.21 Information to user.

The users manual or instruction manual for an intentional or unintentional radiator shall caution the user that changes or modifications not expressly approved by the party responsible for compliance could void the user's authority to operate the equipment.

## Verification & User's Manual Information

The following is extracted from Title 47 of the Code of Federal Regulations, Part 15, Subpart B — Unintentional Radiators:

### § 15.105 Information to the user.

- (a) For a Class A digital device or peripheral, the instructions furnished the user shall include the following or similar statement, placed in a prominent location in the text of the manual:

Note: This equipment has been tested and found to comply with the limits for a Class A digital device, pursuant to Part 15 of the FCC Rules. These limits are designed to provide reasonable protection against harmful interference when the equipment is operated in a commercial environment. This equipment generates, uses, and can radiate radio frequency energy and, if not installed and used in accordance with the instruction manual, may cause harmful interference to radio communications. Operation of this equipment in a residential area is likely to cause harmful interference in which case the user will be required to correct the interference at own expense.

- (b) For a Class B digital device or peripheral, the instructions furnished the user shall include the following or similar statement, placed in a prominent location in the text of the manual:

Note: This equipment has been tested and found to comply with the limits for a Class B digital device, pursuant to Part 15 of the FCC Rules. These limits are designed to provide reasonable protection against harmful interference when the equipment is operated in a residential environment. This equipment generates, uses, and can radiate radio frequency energy and, if not installed and used in accordance with the instruction manual, may cause harmful interference to radio communications. However, there is no guarantee that interference will not occur in a particular installation. If this equipment does cause harmful interference to radio or television reception, which can be determined by turning the equipment off and on, the user is encouraged to try to correct the interference by one or more of the following measures:

- Reorient or relocate the receiving antenna.
- Increase the separation between the equipment and receiver.
- Connect the equipment into an outlet on a circuit different from that to which the receiver is connected.
- Consult the dealer or an experienced radio/TV technician for help.

## ICES-003 Procedural & Labeling Requirements

From the Industry Canada Electromagnetic Compatibility Advisory Bulletin entitled, "Implementation and Interpretation of the Interference-Causing Equipment Standard for Digital Apparatus, ICES-003" (EMCAB-3, Issue 2, July 1995):

"At present, CISPR 22: 2002 and ICES technical requirements are essentially equivalent. Therefore, if you have CISPR 22: 2002 approval by meeting CISPR Publication 22, the only additional requirements are: to attach a note to the report of the test results for compliance, indicating that these results are deemed satisfactory evidence of compliance with ICES-003 of the Canadian Interference-Causing Equipment Regulations; to maintain these records on file for the requisite five year period; and to provide the device with a notice of compliance in accordance with ICES-003."

### Procedural Requirements:

According to Industry Canada's Interference Causing Equipment Standard for Digital Apparatus ICES-003 Issue 4, February 2004:

- Section 6.1: A record of the measurements and results, showing the date that the measurements were completed, shall be retained by the manufacturer or importer for a period of at least five years from the date shown in the record and made available for examination on the request of the Minister.
- Section 6.2: A written notice indicating compliance must accompany each unit of digital apparatus to the end user. The notice shall be in the form of a label that is affixed to the apparatus. Where because of insufficient space or other constraints it is not feasible to affix a label to the apparatus, the notice may be in the form of a statement in the user's manual.

### Labeling Requirements:

The suggested text for the notice, in English and in French, is provided below, from the Annex of ICES-003:

This Class [<sup>2</sup>] digital apparatus complies with Canadian ICES-003.

Cet appareil numérique de la classe [<sup>1</sup>] est conforme à la norme NMB-003 du Canada.

---

<sup>2</sup> Insert either A or B but not both as appropriate for the equipment requirements.

# End of Report