



EUROFINS PRODUCT SERVICE GMBH



Testing Cert #1983.01

RADIO TEST- REPORT

Compliance Test Report

**FCC PART 15 SUBPART C
IC RSS 210 ISSUE 7**

FCC ID: PV7-WIBEAR-SF-STA

WLAN/Bluetooth Module

AN00K73534

Bluetooth Radio Part

TEST REPORT NUMBER: G0M21007-3443-P-15



Eurofins Product Service GmbH
Storkower Str. 38c, 15526 Reichenwalde,
Germany

Phone +49-33631-888 0
Fax +49-33631-888 660

TABLE OF CONTENTS

1	General Information	4
1.1	Notes	4
1.2	Testing laboratory	5
1.3	Details of approval holder	6
1.4	Application details	6
1.5	Test item	6
1.6	Test standards	7
1.7	Acronyms and abbreviations	7
2	Technical test	8
2.1	Summary of test results	8
2.2	Test environment	8
2.3	Test equipment utilized	9
2.4	Sample emission level calculation	10
2.5	Test results	11
3	Informational Transmitter parameters	12
3.1	Transmitter Modes for conformance testing	12
4	Transmitter parameters	13
4.1	20dB Bandwidth	13
4.2	Frequency hopping channel number	15
4.3	Frequency hopping channel spacing	17
4.4	Time of occupancy (Dwell time)	19
4.5	Maximum peak conducted output power	21
4.6	Maximum e.i.r.p. output power	23
4.7	Transmitter band-edge compliance	25
4.8	Transmitter conducted spurious emissions	27
4.9	Transmitter radiated spurious emissions	29
5	Power Line parameters	33
5.1	AC power line conducted emissions	33

Annex A	Photos	34
Annex B	Transmitter 20dB bandwidth	39
Annex C	Hopping channels	48
Annex D	Hopping channel separation	52
Annex E	Time of occupancy	53
Annex F	AC Powerline Conducted Emissions	54
Annex G	Transmitter conducted spurious emissions	56
Annex H	Band edge compliance	65

1 General Information

1.1 Notes

The results of this test report relate exclusively to the item tested as specified in chapter "Description of test item" and are not transferable to any other test items.

Eurofins Product Service GmbH is not responsible for any generalisations and conclusions drawn from this report. Any modification of the test item can lead to invalidity of test results and this test report may therefore be not applicable to the modified test item.

The test report may only be reproduced or published in full. Reproducing or publishing extracts of the report requires the prior written approval of the Eurofins Product Service GmbH.

This document is subject to the General Terms and Conditions and the Testing and Certification System of Eurofins Product Service GmbH, available on request or accessible at www.pt.eurofins.com

Operator:

21.09.2010

W. Treffke



Date

Eurofins-Lab.

Name

Signature

Technical responsibility for area of testing:

21.09.2010

J. Zimmermann

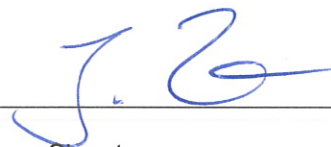

Date

Eurofins

Name

Signature

1.2 Testing laboratory

EUROFINS PRODUCT SERVICE GMBH
Storkower Strasse 38c
D-15526 Reichenwalde b. Berlin
Germany
Telefon : +49 33631 888 00
Telefax : +49 33631 888 660

DAR ACCREDITED TESTING LABORATORY
DAR-REGISTRATION NUMBER: DAT-P-268/08

RECOGNIZED NOTIFIED BODY EMC
REGISTRATION NUMBER: BNetzA-bS EMV-07/61

RECOGNIZED NOTIFIED BODY R&TTE
REGISTRATION NUMBER: BNetzA-bS-02/51-53

FCC FILED TEST LABORATORY
REG.-No. 96970

A2LA ACCREDITED TESTING LABORATORY
CERTIFICATE No. 1983.01

BLUETOOTH QUALIFICATION TEST FACILITY (BQTF)
ACCREDITED BY BLUETOOTH QUALIFICATION REVIEW BOARD

INDUSTRY CANADA FILED TEST LABORATORY
REG. NO. IC 3470

Test location, where different:

Name	: ./.
Street	: ./.
Town	: ./.
Country	: ./.
Telephone	: ./.
Fax	: ./.

1.3 Details of approval holder

Name : lesswire AG
Street : Im Technologiepark 1
Town : 15236 Frankfurt/Oder
Country : Germany
Telephone : 030 6392 8130
Fax : 030 6392 8287

Contact : Frau Angelika Seifert
Telephone : 030 6392 8130

1.4 Application details

Date of receipt of application : 08.07.2010
Date of receipt of test item : 08.07.2010
Date of test : 12. – 13.07.2010

1.5 Test item

Description of test item : WLAN/Bluetooth Module
Type identification : AN00K73534
Brand Name : WiBear-SF1
Serial number : None
Hardware version : 2A
Software version : None
Equipment type : Radio module

Technical data

Frequency range : 2400 - 2483.5MHz
Tested frequencies : F₁ 2402MHz
Tested frequencies : F₂ 2441MHz
Tested frequencies : F₃ 2480MHz
Antenna type : external
Antenna model : Rubber antenna 2.4GHz, SMA, Order number : 17010.0
WiMo Antennen und Elektronik GmbH
Number of antennas : 1
Antenna gain : 2.1dBi (Declared by approval holder)
Power supply : 3.3VDC
Duty cycle : 54%
Operating mode : semi duplex
Spreading technique : FHSS

Modulations : GFSK, PI/4-DQPSK, 8-PSK
Device classification : Mobile Device (Human Body distance > 20 cm)
Additional information : The results in this test report cover only the bluetooth radio part of the EUT. The results for the wireless lan radio part are given in test-report G0M21007-3443-C-1.

Manufacturer:
(if applicable)

Name : PRETTL Elektronik AG
Street : Robert Bosch Straße 10
Town : 01454 Radeberg
Country : Germany

1.6 Test standards

Technical standard : **FCC PART 15 SUBPART C**
 IC RSS 210 ISSUE 7

1.7 Acronyms and abbreviations

EUT : Equipment under Test
TX : Transmission
RX : Reception
RBW : Measurement Resolution Bandwidth
Pol : Measurement Polarization
e.i.r.p. : Equivalent isotropic radiated power
FHSS : Frequency hopping spread spectrum
DSSS : Direct Sequence Spread Spectrum
OFDM : Orthogonal frequency division multiplexing
CCK : Complementary code keying
GFSK : Gaussian frequency shift keying
DQPSK : Differential quadrature phase shift keying
PSK : Phase shift keying
 T_{nom} : Nominal Temperature
 T_{min} : Minimum Temperature
 T_{max} : Maximum Temperature
 V_{nom} : Nominal Supply Voltage
 V_{min} : Minimum Supply Voltage
 V_{max} : Maximum Supply Voltage
VDC : DC voltage
N/A : Not applicable
IC : Industry Canada

2 Technical test

2.1 Summary of test results

No deviations from the technical specification(s) were ascertained in the course of the tests performed.

or

The deviations as specified in 2.4 were ascertained in the course of the tests performed.

2.2 Test environment

Temperature : 22 ... 26°C

Relative humidity content : 20 ... 75%

Air pressure : 86 ... 103kPa

Extreme conditions parameters:

V_{nom} : 3.3VDC

$V_{min} (V_{nom}-15\%)$: -

$V_{max} (V_{nom}+15\%)$: -

T_{nom} : 25°C

Other parameter: None

2.3 Test equipment utilized

Measurement Equipment List					
No.	Measurement device:	Type:	Manufacturer:	Last Cal.	Next Cal.
ETS 0086	Semi-anechoic chamber	AC1	Frankonia	12.03.2010	12.03.2011
ETS 0271	Spectrum Analyzer	FSEK30	Rohde & Schwarz	19.03.2009	19.03.2010
ETS 0012	Biconical Antenna	HK 116	Rohde & Schwarz	29.01.2010	29.01.2011
ETS 0336	LPD Antenna	HL 223	Rohde & Schwarz	28.01.2010	28.01.2011
ETS 0018	Horn Antenna	BBHA 9120D	Schwarzbeck	26.08.2009	26.08.2010
ETS 0432	Amplifier-Matrix			02.06.2010	02.06.2012
ETS 0259	Power Meter	NRVD	Rohde & Schwarz	26.03.2010	26.03.2011
ETS 0278	Power Sensor	NRV-Z31	Rohde & Schwarz	01.08.2008	01.08.2010
ETS 0496	Spectrum Analyzer	FSP30	Rohde & Schwarz	26.08.2009	26.08.2010
ETS 0086	Semi-anechoic chamber	AC1	Frankonia	12.03.2010	12.03.2011

2.4 Sample emission level calculation

The following is a description of terms and a sample calculation, as appears in the radiated emissions data table. The numbers used in the calculation are for example only. There is no direct correlation to the specific data taken for the product described in this document:

Reading:

This is the reading obtained on the spectrum analyzer in dB μ V. Any external preamplifiers used are taken into account through internal analyzer settings.

A.F.:

This is the antenna factor for the receiving antenna. It is a conversion factor, which converts electric fields strengths to voltages, which can be measured directly on the spectrum analyzer. It is treated as a loss in dB. Cable losses have been included with the A.F. to simplify the calculations. The antenna factor is used in calculations as follows:

$$\text{Reading on Analyzer (dB}\mu\text{V)} + \text{A.F. (dB)} = \text{Net field strength (dB}\mu\text{V/m)}$$

Net:

This is the net field strength measurement (as shown above).

Limit:

This is the FCC Class B radiated emission limit (in units of dB μ V/m). The FCC limits are given in units of μ V/m. The following formula is used to convert the units of μ V/m to dB μ V/m:

$$\text{Limit (dB}\mu\text{V/m)} = 20 * \log (\mu\text{V/m})$$

Margin:

This is the margin of compliance below the FCC limit. The units are given in dB. A negative margin indicates the emission was below the limit. A positive margin indicates that the emission exceeds the limit.

Example only:

$$\begin{array}{rclcl} \text{Reading} & + & \text{AF} & = & \text{Net Reading} & : & \text{Net reading} - \text{FCC limit} = \text{Margin} \\ 21.5 \text{ dB}\mu\text{V} & + & 26 \text{ dB} & = & 47.5 \text{ dB}\mu\text{V/m} & : & 47.5 \text{ dB}\mu\text{V/m} - 57.0 \text{ dB}\mu\text{V/m} = -9.5 \text{ dB} \end{array}$$

2.5 Test results

 1st test

 test after modification

 production test

Test case	Clause	Required	Result	Remarks
INFORMATIONAL TRANSMITTER PARAMETERS				
Occupied Bandwidth	IC RSS-Gen. 4.6.1	<input type="checkbox"/>	N/A	IC only
TRANSMITTER PARAMETERS				
20dB Bandwidth	FCC § 15.247(a)(1) IC RSS-210 § A8.1	<input checked="" type="checkbox"/>	PASS	
Frequency hopping channel number	FCC § 15.247(a)(1)(iii) IC RSS-210 § A8.1	<input checked="" type="checkbox"/>	PASS	
Frequency hopping channel spacing	FCC § 15.247(a)(1) IC RSS-210 § A8.1	<input checked="" type="checkbox"/>	PASS	
Time of occupancy (dwell time)	FCC § 15.247(a)(1)(iii) IC RSS-210 § A8.1	<input checked="" type="checkbox"/>	PASS	
Maximum peak conducted output power	FCC § 15.247(b) IC RSS-210 § A8.4	<input checked="" type="checkbox"/>	PASS	
Maximum peak e.i.r.p. output power	FCC § 15.247(b) IC RSS-210 § A8.4	<input checked="" type="checkbox"/>	PASS	
Band-edge Compliance	FCC § 15.247(d) IC RSS-210 § A8.5	<input checked="" type="checkbox"/>	PASS	
Conducted spurious emissions	FCC § 15.247(d) IC RSS-210 § A8.5	<input checked="" type="checkbox"/>	PASS	
Radiated spurious emissions	FCC § 15.247(d) FCC § 15.209 IC RSS-210 § A8.5 IC RSS-Gen § 4.9	<input checked="" type="checkbox"/>	PASS	
RECEIVER PARAMETERS				
Radiated spurious emissions	FCC § 15.109 IC RSS-Gen § 4.10 IC RSS-Gen § 7.2.3	<input type="checkbox"/>	N/A	IC only
POWER LINE PARAMETERS				
AC power line conducted emissions	FCC § 15.207 IC RSS-Gen. 7.2.2	<input checked="" type="checkbox"/>	PASS	

3 Informational Transmitter parameters

3.1 Transmitter Modes for conformance testing

The following transmission modes are elected for compliance testing.

TEST MODE DH5	
Conditions	
Spread Spectrum :	<input checked="" type="checkbox"/> Yes <input type="checkbox"/> No
Spreading Technique :	FHSS
Modulation :	GFSK
Packet Type :	DH5
Data rate :	1Mbps
Duty Cycle :	47%

TEST MODE 2-DH5	
Conditions	
Spread Spectrum :	<input checked="" type="checkbox"/> Yes <input type="checkbox"/> No
Spreading Technique :	FHSS
Modulation :	$\pi/4$ -DQPSK
Packet Type :	2-DH5
Data rate :	2Mbps
Duty Cycle :	47%

TEST MODE 3-DH5	
Conditions	
Spread Spectrum :	<input checked="" type="checkbox"/> Yes <input type="checkbox"/> No
Spreading Technique :	FHSS
Modulation :	8-PSK
Packet Type :	3-DH5
Data rate :	3Mbps
Duty Cycle :	47%

4 Transmitter parameters

4.1 20dB Bandwidth

According FCC rules 47 CFR 15.247(a)(1) and RSS-210 Section A8.1 the 20dB Bandwidth determines the necessary carrier spacing used in the frequency hopping system.

4.1.1 Limits

According FCC and IC rules frequency hopping systems shall have hopping channel carrier frequencies separated by a minimum of 25kHz or the 20dB bandwidth of the hopping channel, whichever is greater. Alternatively, frequency hopping systems operating in the 2400–2483.5 MHz band may have hopping channel carrier frequencies that are separated by 25 kHz or two-thirds of the 20 dB bandwidth of the hopping channel, whichever is greater, provided the systems operate with an output power no greater than 125 mW.

20dB Bandwidth limits	
Output Power	20dB Bandwidth Limit
$\leq 125\text{mW} / 21\text{dBm}$	1.5 * carrier spacing
125mW – 1W / 21 – 30dBm	1.0 * carrier spacing

4.1.2 Measurement procedure

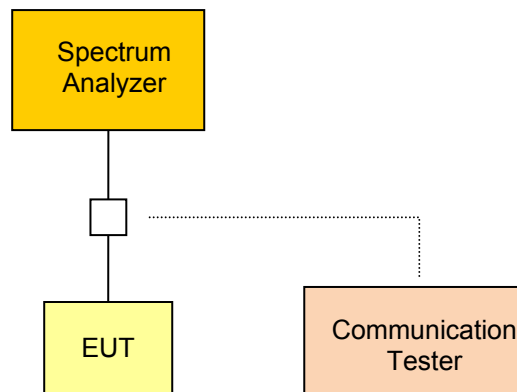

The EUT is connected to a spectrum analyzer and set to transmission mode (using a communication tester if needed) with maximum power under normal test conditions. The resolution bandwidth is set to 1% of the 20dB bandwidth of the emission spectrum ($VBW \geq RBW$). The center frequency is set to the hopping channel center frequency. The span of the analyzer is set to 2 -3 times the 20dB bandwidth. The bandwidth is determined using markers with peak detector and max hold.

According to 47 CFR 15.31 battery power equipment is measured using new batteries and equipment using external power supply is measured with 85%, 100% and 115% of the nominal rated supply voltage.

4.1.3 Results

20dB Bandwidth		
Measurement Conditions		
Max. output power :	9.8dBm	
Carrier spacing :	1MHz	
Channel [MHz]	20dB Bandwidth [MHz]	Bandwidth Limit [MHz]
Test mode DH5		
2402	0.755	≤ 1.5
2441	0.755	≤ 1.5
2480	0.759	≤ 1.5
Test mode 2-DH5		
2402	1.265	≤ 1.5
2441	1.269	≤ 1.5
2480	1.269	≤ 1.5
Test mode 3-DH5		
2402	1.014	≤ 1.5
2441	1.014	≤ 1.5
2480	1.019	≤ 1.5
See attached diagrams in Annex		
Measurement uncertainty		4.22dB
Verdict		PASS

4.2 Frequency hopping channel number

According FCC rules 47 CFR 15.247(a)(1)(iii) and RSS-210 Section A8.1 the number of hopping channels used, determines if the system can be certified as a hopping system and also the power level the system can use.

4.2.1 Limits

According FCC and IC rules frequency hopping systems shall use a minimum of 15 hopping channels. If the hopping system uses at least 75 hopping channels, the maximum conducted output power can be increased from 0.125W to 1W.

Frequency hopping channel number limits	
Max. conducted output Power	Minimum number of channels
$\leq 125\text{mW} / 21\text{dBm}$	15
125mW – 1W / 21 - 30dBm	75

4.2.2 Measurement procedure

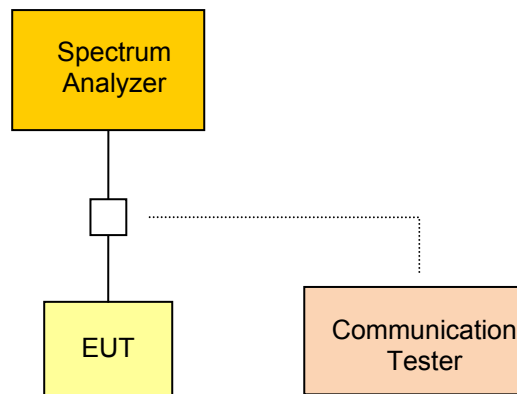

The EUT is connected to a spectrum analyzer and set to transmission mode (using a communication tester if needed) with hopping activated. The resolution bandwidth is set to 1% of the span ($VBW \geq RBW$) and the span is set to 2400 – 2483.5MHz. The power level is measured with peak detector and max hold.

4.2.3 Results

Number of hopping channels	
Measurement Conditions	
Test mode :	DH5
Max. output power :	9.8dBm
Number of channels	Hopping channel limit
79	≥ 15
See attached diagrams in Annex	
Measurement uncertainty	4.22dB
Verdict	PASS

4.3 Frequency hopping channel spacing

According FCC rules 47 CFR 15.247(a)(1) and RSS-210 Section A8.1 the minimum hopping channel frequency spacing is correlated to the 20dB bandwidth of the hopping channel emission and and maximum peak output power.

4.3.1 Limits

According FCC and IC rules frequency hopping systems shall have hopping channel carrier frequencies separated by a minimum of 25kHz or the 20dB bandwidth of the hopping channel, whichever is greater. Alternatively, frequency hopping systems operating in the 2400–2483.5 MHz band may have hopping channel carrier frequencies that are separated by 25 kHz or two-thirds of the 20 dB bandwidth of the hopping channel, whichever is greater, provided the systems operate with an output power no greater than 125 mW.

Frequency hopping channel spacing limits	
Max. conducted output Power	Minimum hopping channel spacing
$\leq 125\text{mW} / 21\text{dBm}$	$\geq 25\text{kHz}$ or $\frac{2}{3}$ of 20dB bandwidth
125mW – 1W / 21 – 30dBm	$\geq 25\text{kHz}$ or 20dB bandwidth

4.3.2 Measurement procedure

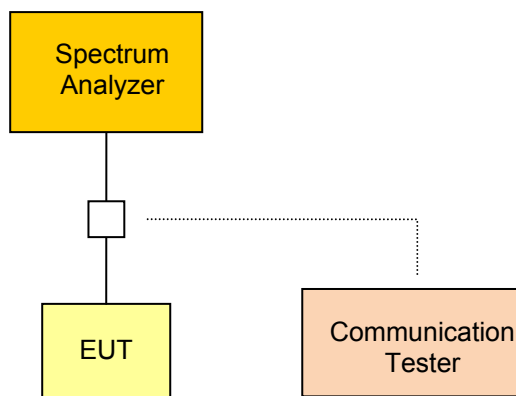

The EUT is connected to a spectrum analyzer and set to transmission mode (using a communication tester if needed) with hopping activated. The resolution bandwidth is set to 1% of the span ($VBW \geq RBW$) and the span is set wide enough to capture two adjacent channels. The power level is measured with peak detector and max hold.

4.3.3 Results

Frequency hopping channel spacing	
Measurement Conditions	
Test mode :	DH5
Tested channels :	2441MHz / 2442MHz
Max. output power :	9.8dBm
Channel spacing [kHz]	Channel spacing limit [kHz]
1000.0	$\geq \frac{2}{3} * 755 = 503$
See attached diagrams in Annex	
Measurement uncertainty	4.22dB
Verdict	PASS

4.4 Time of occupancy (Dwell time)

According FCC rules 47 CFR 15.247(a)(1)(iii) and RSS-210 Section A8.1 the average time of occupancy on any channel is limited.

4.4.1 Limits

According FCC and IC rules the average time of occupancy on any channel shall not be greater than 0.4 seconds within a period of 0.4 seconds multiplied by the number of hopping channels employed.

Time of occupancy limits	
Dwell time limit	Channel occupancy period
0.4s	0.4 * Number of hopping channels

4.4.2 Measurement procedure

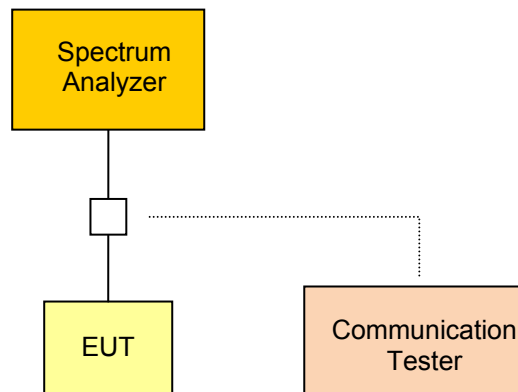

The EUT is connected to a spectrum analyzer and set to transmission mode (using a communication tester if needed) with hopping activated. The resolution bandwidth is set to 1MHz ($VBW \geq RBW$) and the span is set to zero centered on a hopping channel. The sweep time is set large enough to capture the dwell time. The power level is measured with peak detector and max hold.

4.4.3 Results

Time of occupancy (Dwell time)	
Measurement Conditions	
Test mode :	DH5
Tested channel :	2441
Number of hopping channels :	79
Time of occupancy	Channel occupancy periode
63 * 1.69ms = 0.107s	31.6s
See attached diagrams in Annex	
Measurement uncertainty	4.22dB
Verdict	PASS

4.5 Maximum peak conducted output power

According FCC rules 47 CFR 15.247(b)(1) and RSS-210 Section A8.4 the maximum peak conducted output power is limited and has been verified.

4.5.1 Limits

For frequency hopping systems operating in the band 2400-2483.5 MHz employing at least 75 hopping channels, the maximum peak conducted output power shall not exceed 1 W; for all other frequency hopping systems in the band, the maximum peak conducted output power shall not exceed 0.125 W.

Maximum peak conducted output power limits	
Number of Hopping Channels	Conducted Power Limit
≥ 75	1W (30dBm)*
15 - 74	125mW (21dBm)*

*) The conducted output power limit specified above is based on the use of antennas with directional gains that do not exceed 6 dBi. If transmitting antennas of directional gain greater than 6 dBi are used, the conducted output power from the intentional radiator shall be reduced below the stated values in the table, as appropriate, by the amount in dB that the directional gain of the antenna exceeds 6 dBi.

4.5.2 Measurement procedure

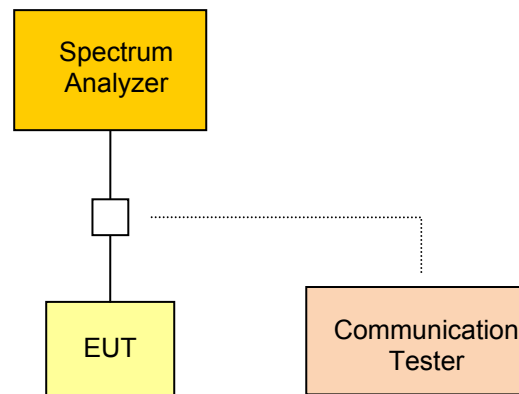

The EUT is connected to a spectrum analyzer and set to transmission mode (using a communication tester if needed) with maximum power under normal test conditions. The resolution bandwidth is set higher than the 20dB Bandwidth of the emission spectrum ($VBW \geq RBW$). The span of the analyzer is set larger than 5 times the resolution bandwidth. The maximum power emitted by the EUT is measured using peak detector and max hold.

According to 47 CFR 15.31 battery power equipment is measured using new batteries and equipment using external power supply is measured with 85%, 100% and 115% of the nominal rated supply voltage.

4.5.3 Results

Maximum peak conducted output power		
Measurement Conditions		
Antenna gain :	2.1dBi	
Power correction :	0dB	
Number of Hopping channels :	79	
Channel [MHz]	Conducted output power [dBm]	Power Limit [dBm]
Test mode DH5		
2402	9.6	≤ 30
2441	9.8	≤ 30
2480	9.0	≤ 30
Test mode 2-DH5		
2402	6.9	≤ 30
2441	7.3	≤ 30
2480	7.6	≤ 30
Test mode 3-DH5		
2402	6.9	≤ 30
2441	7.3	≤ 30
2480	7.6	≤ 30
See attached diagrams in Annex		
Measurement uncertainty		4.22dB
Verdict		PASS

4.6 Maximum e.i.r.p. output power

According to FCC rules 47 CFR 15.247(b)(1) and RSS-210 Section A8.4 the maximum peak e.i.r.p. conducted output power is limited and has to be verified.

4.6.1 Limits

According to the FCC Rules the conducted output power limit specified is based on the use of antennas with directional gains that do not exceed 6 dBi. If transmitting antennas of directional gain greater than 6 dBi are used, the conducted output power from the intentional radiator shall be reduced below the stated values in the table, as appropriate, by the amount in dB that the directional gain of the antenna exceeds 6 dBi. This translates to the following e.i.r.p. power limits.

Maximum e.i.r.p. output power limits	
Number of Hopping Channels	E.I.R.P. Power Limit
≥ 75	4W e.i.r.p. (36dBm e.i.r.p.)
15 - 74	500mW e.i.r.p. (27dBm e.i.r.p.)*

*) According to RSS-210 the e.i.r.p. output power is generally limited to 4W (36dBm) without limit on the number of hopping channels.

4.6.2 Measurement procedure

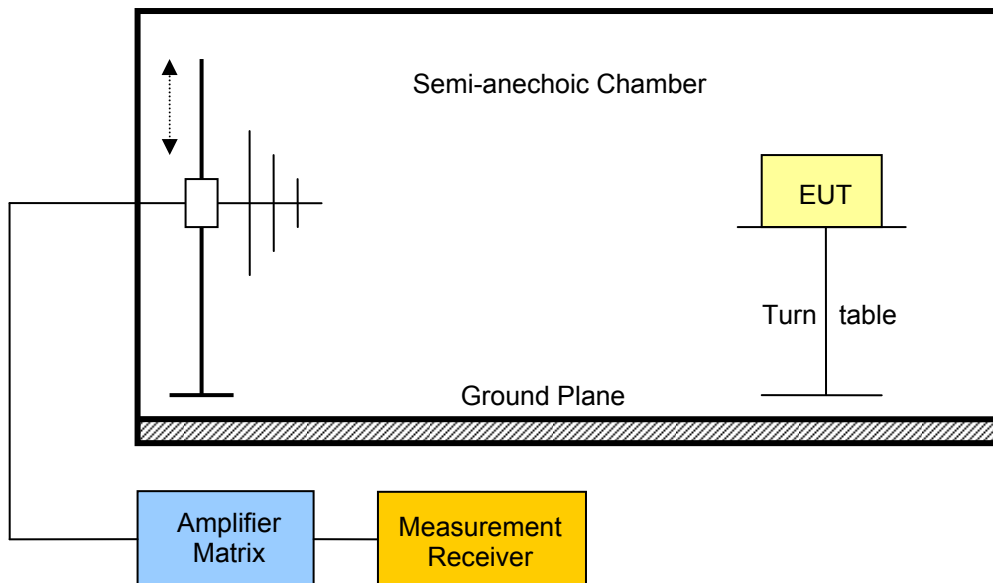

The EUT is placed on a table in a semi-anechoic chamber. The EUT is activated with the transmission modes stated in the test report. The emission level of all emission up to the 10th harmonic is scanned. In the frequency range below 1GHz a resolution bandwidth of 100kHz is used and above 1GHz a resolution bandwidth of 1MHz is used. To obtain the peak emission level the EUT is rotated through 360° and the height of the measurement antenna changed. All emission that come to within 20dB of the limit line are recorded.

Alternate validation procedure

Alternatively the e.i.r.p. power is calculated from the declared antenna gain and the measured maximum peak conducted output power.

Which method has been used is stated in the result table.

4.6.3 Results

Maximum e.i.r.p. output power		
Measurement Conditions		
Validation methode :	<input type="checkbox"/> Measurement <input checked="" type="checkbox"/> Alternate	
Antenna gain :	2.1dBi	
Channel [MHz]	E.I.R.P. output power [dBm e.i.r.p.]	E.I.R.P. Power Limit [dBm e.i.r.p.]
Test mode DH5		
2402	11.7	≤ 36
2441	11.9	≤ 36
2480	11.1	≤ 36
Test mode 2-DH5		
2402	9.0	≤ 36
2441	9.4	≤ 36
2480	9.7	≤ 36
Test mode 3-DH5		
2402	9.0	≤ 36
2441	9.4	≤ 36
2480	9.7	≤ 36
See attached diagrams in Annex		
Measurement uncertainty		4.22dB
Verdict		PASS

4.7 Transmitter band-edge compliance

According FCC rules 47 CFR 15.209, 15.247(d) and RSS-210 Section A8.5 the emission level of out-of-band emissions are limited and has to be validated.

4.7.1 Limits

The emission limit of out of band emission in any 100kHz bandwidth outside the frequency band in which the spread spectrum device is operating, the radio frequency power that is produced shall be at least 20 dB below that in the 100 kHz bandwidth within the band that contains the highest level of the desired power, based on either an RF conducted or a radiated measurement, provided the transmitter demonstrates compliance with the peak conducted power limits. If the transmitter complies with the conducted power limits based on the use of RMS averaging over a time interval the attenuation required shall be 30 dB instead of 20 dB. Attenuation below the general limits (see "Transmitter spurious emissions"-measurement) is not required.

Transmitter band-edge emission limits	
TX-Power Detector	Out of band attenuation
Peak	-20dBc/100kHz
RMS	-30dBc/100kHz

4.7.2 Measurement procedure

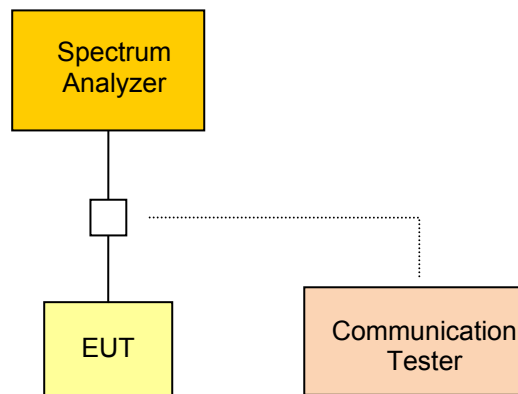

The EUT is connected to a spectrum analyzer and set to transmission mode (using a communication tester if needed) without hopping with maximum power under normal test conditions. The span of the analyzer is set large enough to capture the maximum emission within the emission band as well as any modulation product which fall outside the authorized band of operation. The resolution bandwidth is set to 1% of the span ($VBW \geq RBW$). The

A marker is set on the emission at the bandedge, or on the highest modulation product outside of the band, if this level is greater than that at the bandedge. Using the delta-marker function the highest peak of the in-band emission is measured.

The same measurement procedure is repeated in hopping mode.

4.7.3 Results

Transmitter band-edge emissions		
Measurement Conditions		
Power mode :	Peak	
Mode	Lower edge emission [dBc]	Upper edge emission [dBc]
Test mode DH5		
Hopping	-36.02	-42.86
Single	-	-
Test mode 2-DH5		
Hopping	-46.20	-38.08
Single	-	-
Test mode 3-DH5		
Hopping	-39.21	-45.18
Single	-	-
See attached diagram in Annex		
Verdict	PASS	

4.8 Transmitter conducted spurious emissions

According FCC rules 47 CFR 15.247(d) and RSS-210 Section A8.5 unwanted emissions in the spurious domain are power limited and has to be validated.

4.8.1 Limits

The emission limit of out of band emission in any 100kHz bandwidth outside the frequency band in which the spread spectrum device is operating, the radio frequency power that is produced shall be at least 20 dB below that in the 100 kHz bandwidth within the band that contains the highest level of the desired power, based on either an RF conducted or a radiated measurement, provided the transmitter demonstrates compliance with the peak conducted power limits. If the transmitter complies with the conducted power limits based on the use of RMS averaging over a time interval the attenuation required shall be 30 dB instead of 20 dB. Attenuation below the general limits (see "Transmitter radiated spurious emissions"-measurement) is not required.

Transmitter conducted spurious emission limits	
TX-Power Detector	Out of band attenuation
Peak	-20dBc/100kHz
RMS	-30dBc/100kHz

4.8.2 Measurement procedure

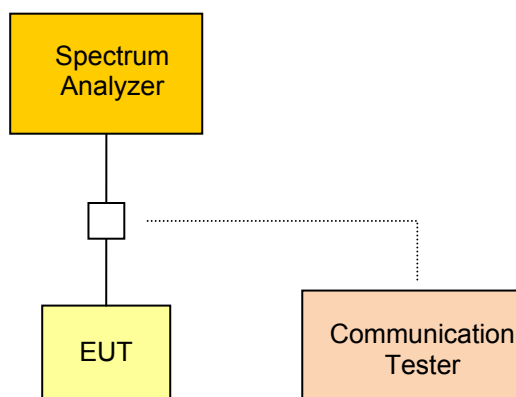

The EUT is connected to a spectrum analyzer and set to transmission mode with maximum power under normal test conditions. The span of the analyzer is set large enough to capture the maximum emission within the emission band as well as any spurious emission outside the authorized band of operation. The resolution bandwidth is set to 100kHz ($VBW \geq RBW$). The emissions are measured using peak detector and max hold.

The measurement is performed over the frequency range of 30MHz up to the tenth harmonic.

4.8.3 Results

Transmitter conducted spurious emissions						
Measurement Conditions						
Modulated :		<input checked="" type="checkbox"/> Yes <input type="checkbox"/> No				
Channel Frequency [MHz]	Emission Frequency [MHz]	Emission Level [dBm]	Peak field Strength [dBm]	Limit [dBm]	Detector	Margin [dB]
Test mode DH5						
2402	10260	-44.21	4.57	-15.43	peak	-28.78
2441	12100	-43.67	4.82	-15.18	peak	-28.49
2480	12120	-43.83	4.51	-15.49	peak	-28.34
See attached diagrams in Annex						
Verdict				PASS		

4.9 Transmitter radiated spurious emissions

According FCC rules 47 CFR 15.209, 15.247(d) and RSS-210 Section A8.5 unwanted emissions in the spurious domain are power limited and has to be validated.

4.9.1 Limits

The emission limit of out of band emission in any 100kHz bandwidth outside the frequency band in which the spread spectrum device is operating, the radio frequency power that is produced shall be at least 20 dB below that in the 100 kHz bandwidth within the band that contains the highest level of the desired power, based on either an RF conducted or a radiated measurement, provided the transmitter demonstrates compliance with the peak conducted power limits. If the transmitter complies with the conducted power limits based on the use of RMS averaging over a time interval the attenuation required shall be 30 dB instead of 20 dB. Attenuation below the general limits (see "Transmitter spurious emissions"-measurement) is not required.

Transmitter out-of-band emission limits	
TX-Power Detector	Out of band attenuation
Peak	-20dBc/100kHz
RMS	-30dBc/100kHz

In addition, radiated emissions which fall in the restricted bands, as defined in Section 15.205(a), must also comply with the radiated emission limits specified in Section 15.209(a) (see Section 15.205(c)).

Tranmitter restricted band spurious emission limits				
Frequency range [MHz]	Detector	Limit [$\mu\text{V}/\text{m}$]	Calculated Limit 3m [dB $\mu\text{V}/\text{m}$]	Measurement Distance [m]
30 – 88	Quasi-Peak	100	40	3
88 – 216	Quasi-Peak	150	43.5	3
216 – 960	Quasi-Peak	200	46	3
960 – 1000	Quasi-Peak	500	54	3
> 1000	Average	500	54	3

When average radiated emission measurements are specified, including average emission measurements below 1000 MHz, there also is a limit on the peak level of the radio frequency emissions. The limit on peak radio frequency emissions is 20 dB above the maximum permitted average emission limit applicable to the equipment under test.

4.9.2 Measurement procedure

The spurious emission measurement is performed on 3m a semi-anechoic test site.

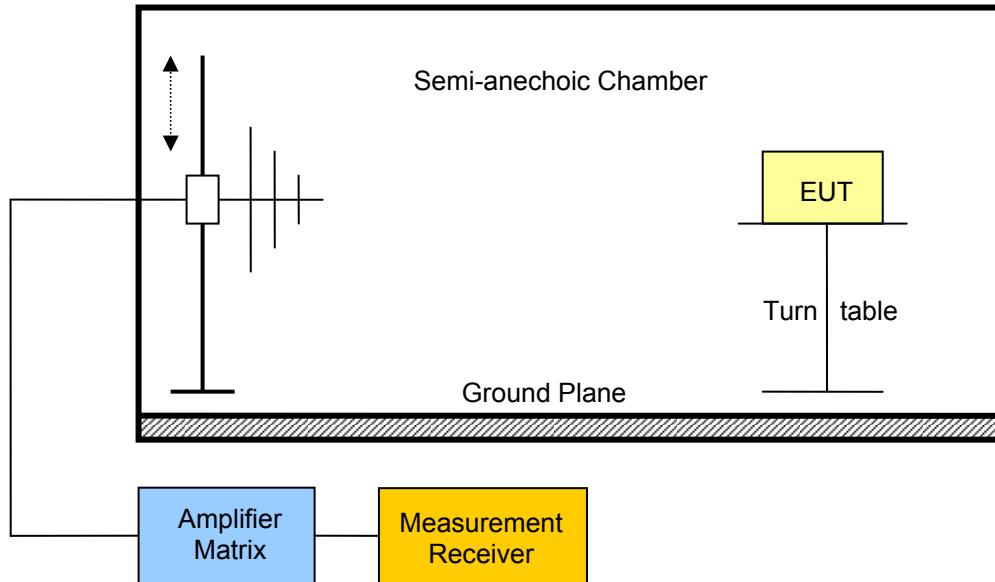

The EUT is placed on a non-metallic table. Any emission is received by the measurement antenna and measured via a measurement receiver connected to the antenna. To obtain the maximum emission the EUT is rotated through 360°.

Due to practical reasons the spurious emission level check is first performed with a peak detector and the quasi-peak and average limits.

If any emission is detected that gets close to the emission limit the detector is changed and the quasi-peak or average detector is used. Which detector is used is determined by the emission frequency. If pulsed transmission is used, averaging over the pulse train is used.

The measurement values are also corrected to obtain the field strength values at the defined measurement distances of the emission limits.

The measurement is performed over the frequency range of 30MHz up to the tenth harmonic.

4.9.3 Results

Transmitter radiated spurious emissions – DH5						
Measurement Conditions						
Measurement distance :		3m				
Modulated :		<input checked="" type="checkbox"/> Yes <input type="checkbox"/> No				
Channel Frequency [MHz]	Emission Frequency [MHz]	Polarization	Measured Field Strength [dB μ V/m]	Limit@3m [dB μ V/m]	Detector	Margin [dB]
Test mode DH5						
2402	2390	v	69.31	74.00	peak	-4.69
2402	2390	v	32.12	54.00	average	-21.88
2402	2390	h	63.33	74.00	Peak	-10.67
2402	2390	h	28.69	54.00	average	-25.31
2441	4882	v	55.38	74.00	Peak	-18.62
2441	4882	v	48.88	54.00	average	-5.12
2441	2390	v	56.22	74.00	peak	-17.78
2441	2390	v	27.78	54.00	Average	-26.22
2441	2483	v	55.32	74.00	peak	-18.68
2441	2483	v	27.57	54.00	average	-26.43
2480	2484	v	72.88	74.00	peak	-1.12
2480	2484	v	49.51	54.00	average	-4.49
2480	2500	v	61.70	74.00	peak	-12.30
2480	2500	v	28.59	54.00	average	-25.41
2480	4954	v	57.30	74.00	peak	-16.70
2480	4960	v	51.42	54.00	average	-2.58
2480	2484	h	70.06	74.00	peak	-3.94
2480	2484	h	42.50	54.00	average	-11.50
2480	2500	h	54.87	74.00	peak	-19.13
2480	2500	h	26.95	54.00	average	-27.05
2480	4962	h	55.38	74.00	peak	-18.62
2480	4960	h	48.12	54.00	average	-5.88
Verdict					PASS	

Transmitter radiated spurious emissions – 3-DH5						
Measurement Conditions						
Measurement distance :		3m				
Modulated :		<input checked="" type="checkbox"/> Yes <input type="checkbox"/> No				
Channel Frequency [MHz]	Emission Frequency [MHz]	Polarization	Measured Field Strength [dB μ V/m]	Limit@3m [dB μ V/m]	Detector	Margin [dB]
Test mode 3-DH5						
2402	2390	v	63.35	74.00	peak	-10.65
2402	2390	v	30.91	54.00	average	-23.09
2402	2390	h	56.86	74.00	peak	-17.14
2402	2390	h	28.20	54.00	average	-25.80
2480	2484	v	71.13	74.00	peak	-2.87
2480	2484	v	43.78	54.00	average	-10.22
2480	2500	v	55.92	74.00	peak	-18.08
2480	2500	v	28.29	54.00	average	-25.71
2480	4962	v	53.70	74.00	peak	-20.3
2480	4959	v	43.59	54.00	average	-10.41
2480	2484	h	64.87	74.00	peak	-9.13
2480	2484	h	38.83	54.00	average	-15.17
2480	4954	h	54.08	74.00	peak	-19.92
2480	4958	h	45.77	54.00	average	-8.23
Verdict					PASS	

5 Power Line parameters

5.1 AC power line conducted emissions

According FCC rules 47 CFR 15.207 and RSS-Gen Section 7.2.2 for any intentional radiator that is designed to be connected to the public utility (AC) power line, the radio frequency voltage that is conducted back onto the AC power line on any frequency or frequencies within the band 150 kHz to 30 MHz shall not exceed the limits given below.

5.1.1 Limits

AC power line emission limits		
Frequency [MHz]	Conducted Limit [dB μ V]	
	Quasi-Peak	Average
0.15 – 0.5	66 to 56	56 to 46
0.5 - 5	56	46
5 - 30	60	50

5.1.2 Measurement procedure

The ac power line emissions are measured using a 50 μ H / 50 Ω line impedance stabilization network (LINS). The radio frequency voltage between each power line and ground at the power terminal is measured.

5.1.3 Results

AC power line emissions	
Conducted emission level	
See attached Diagram	
Verdict	PASS

Annex B Transmitter 20dB bandwidth

FCC part 15.247
20 dB bandwidth

EUT	RF module with BT and WLAN
Model	WiBear-SF1
Approval Holder	lesswire AG
Temperature / Voltage	23°C / Vnom
Test Site / Operator	Eurofins Product Service GmbH / Mr. Treffke
Test Specification	FCC part 15 section 247(a)
Comment 1	20 dB bandwidth
Comment 2	Channel.: 0 / 2402 MHz / GFSK

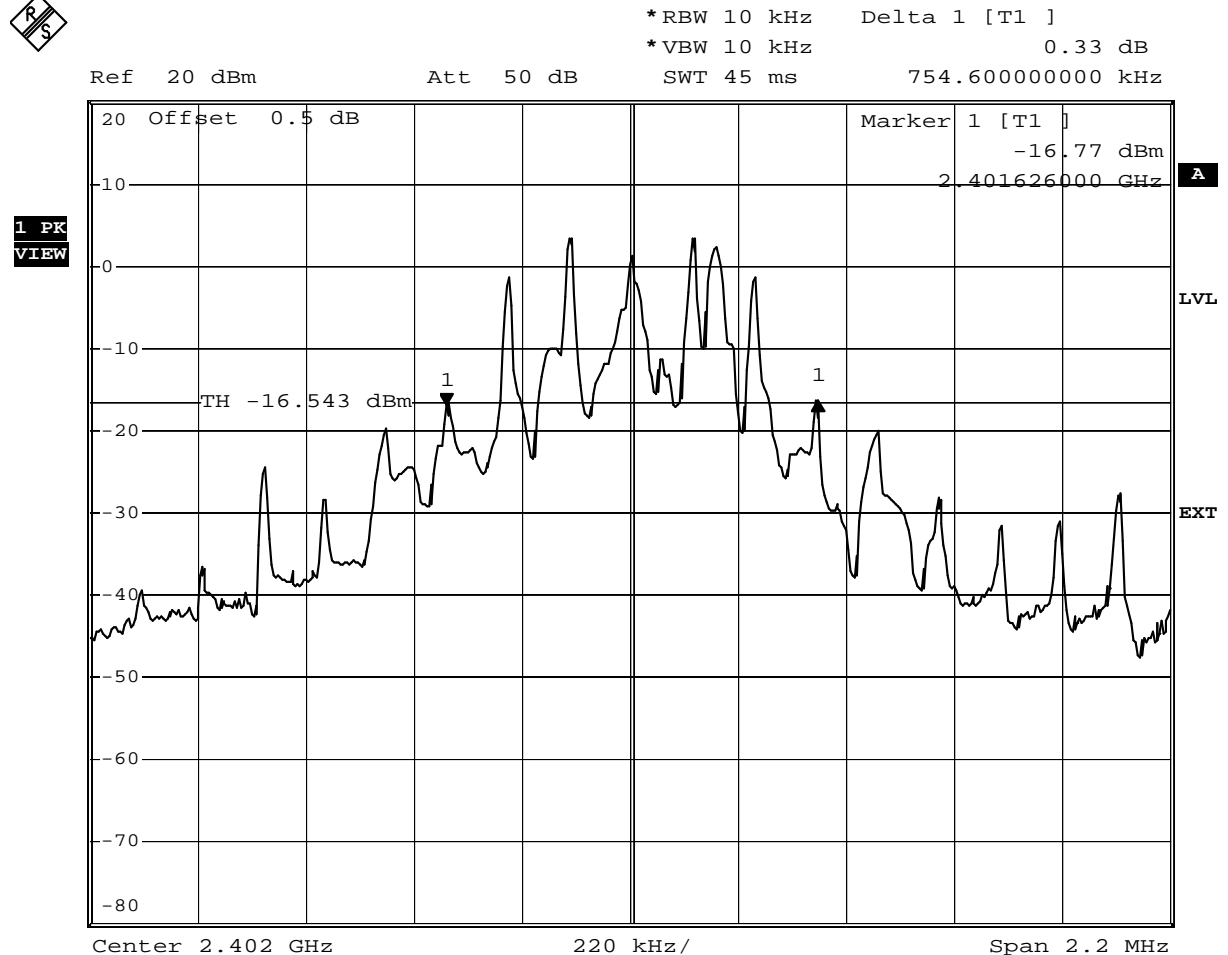

Comment: 20 dB bandwidth: 754.6 KHz
Date: 13.JUL.2010 07:55:32

**FCC part 15.247
20 dB bandwidth**

EUT	RF module with BT and WLAN
Model	WiBear-SF1
Approval Holder	lesswire AG
Temperature / Voltage	23°C / Vnom
Test Site / Operator	Eurofins Product Service GmbH / Mr. Treffke
Test Specification	FCC part 15 section 247(a)
Comment 1	20 dB bandwidth
Comment 2	Channel.: 39 / 2441 MHz / GFSK

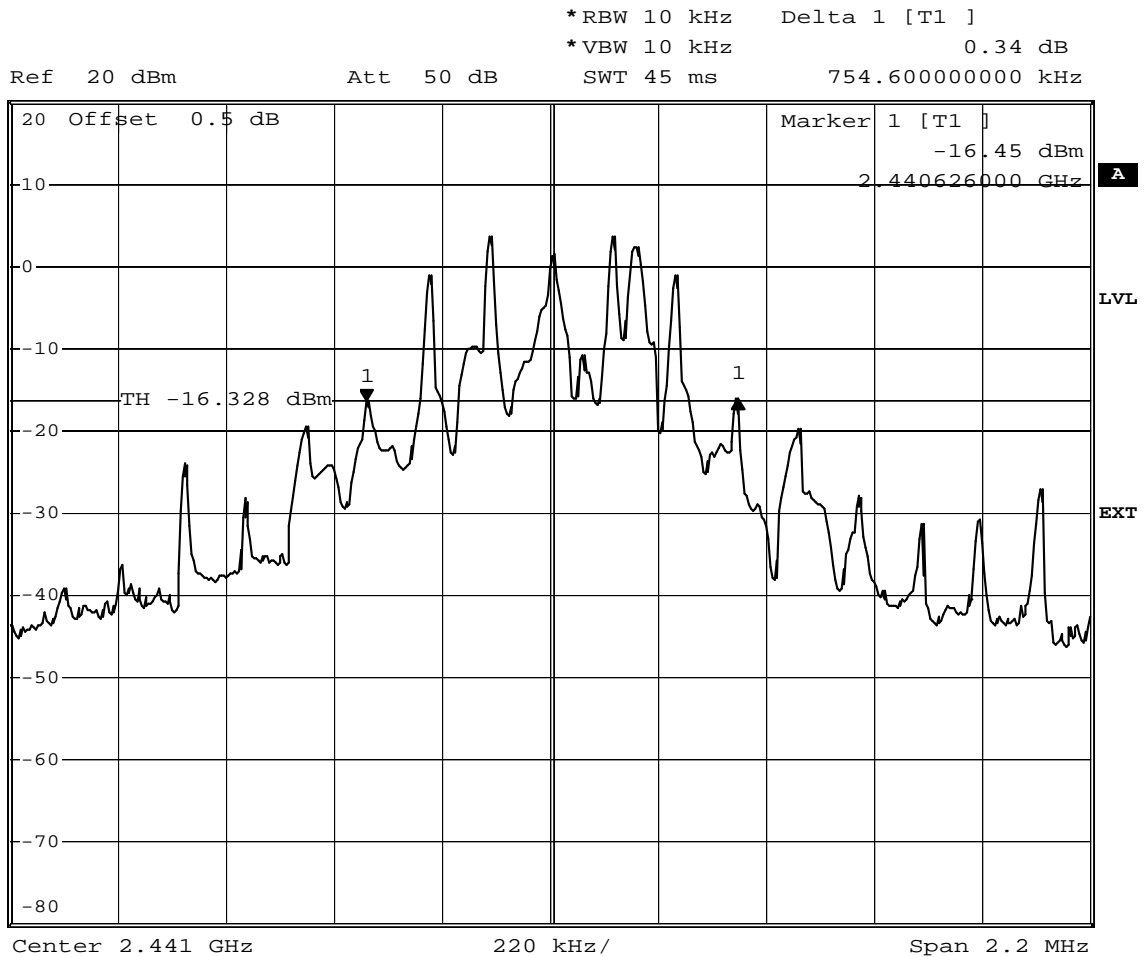

Comment: 20 dB bandwidth: 754.6 KHz
Date: 13.JUL.2010 07:57:46

**FCC part 15.247
20 dB bandwidth**

EUT	RF module with BT and WLAN
Model	WiBear-SF1
Approval Holder	lesswire AG
Temperature / Voltage	23°C / Vnom
Test Site / Operator	Eurofins Product Service GmbH / Mr. Treffke
Test Specification	FCC part 15 section 247(a)
Comment 1	20 dB bandwidth
Comment 2	Channel.: 78 / 2480 MHz / GFSK

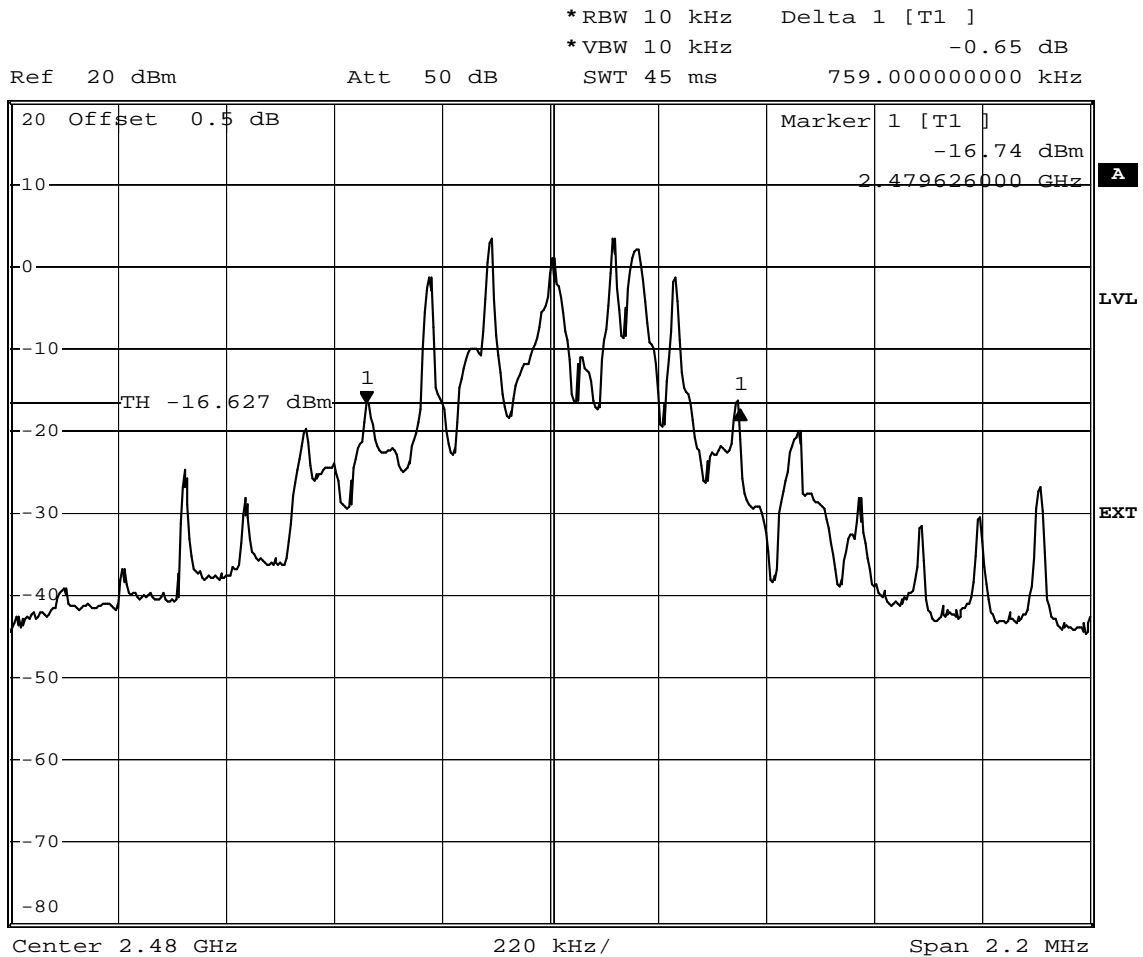

Comment: 20 dB bandwidth: 759 KHz
Date: 13.JUL.2010 08:03:01

FCC part 15.247
20 dB bandwidth

EUT	RF module with BT and WLAN
Model	WiBear-SF1
Approval Holder	lesswire AG
Temperature / Voltage	23°C / Vnom
Test Site / Operator	Eurofins Product Service GmbH / Mr. Treffke
Test Specification	FCC part 15 section 247(a)
Comment 1	20 dB bandwidth
Comment 2	Channel.: 0 / 2402 MHz / $\pi/4$ -DQPSK



*RBW 10 kHz Delta 1 [T1]
*VBW 10 kHz 0.32 dB

Ref 20 dBm Att 50 dB SWT 45 ms 1.265000000 MHz

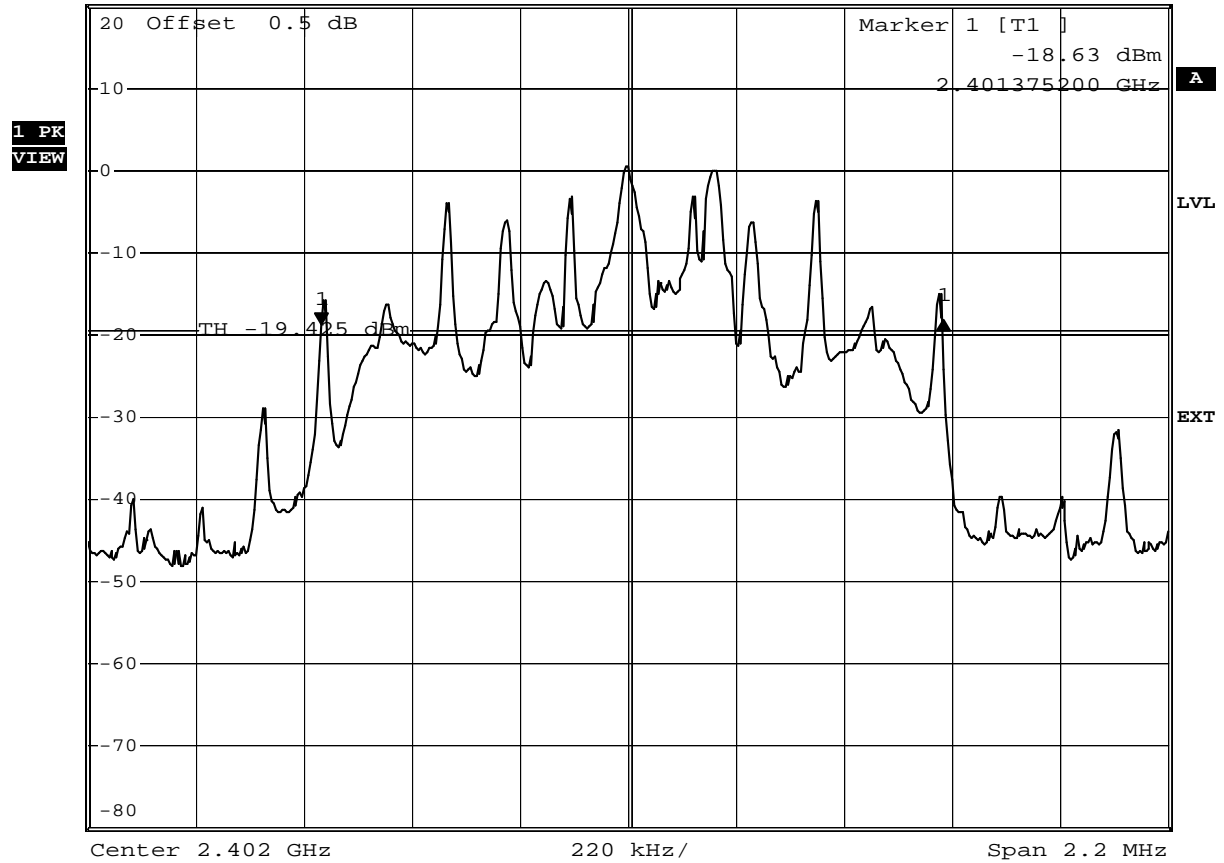

Comment: 20 dB bandwidth: 1265 KHz
Date: 13.JUL.2010 08:07:39

**FCC part 15.247
20 dB bandwidth**

EUT	RF module with BT and WLAN
Model	WiBear-SF1
Approval Holder	lesswire AG
Temperature / Voltage	23°C / Vnom
Test Site / Operator	Eurofins Product Service GmbH / Mr. Treffke
Test Specification	FCC part 15 section 247(a)
Comment 1	20 dB bandwidth
Comment 2	Channel.: 39 / 2441 MHz / $\pi/4$ -DQPSK

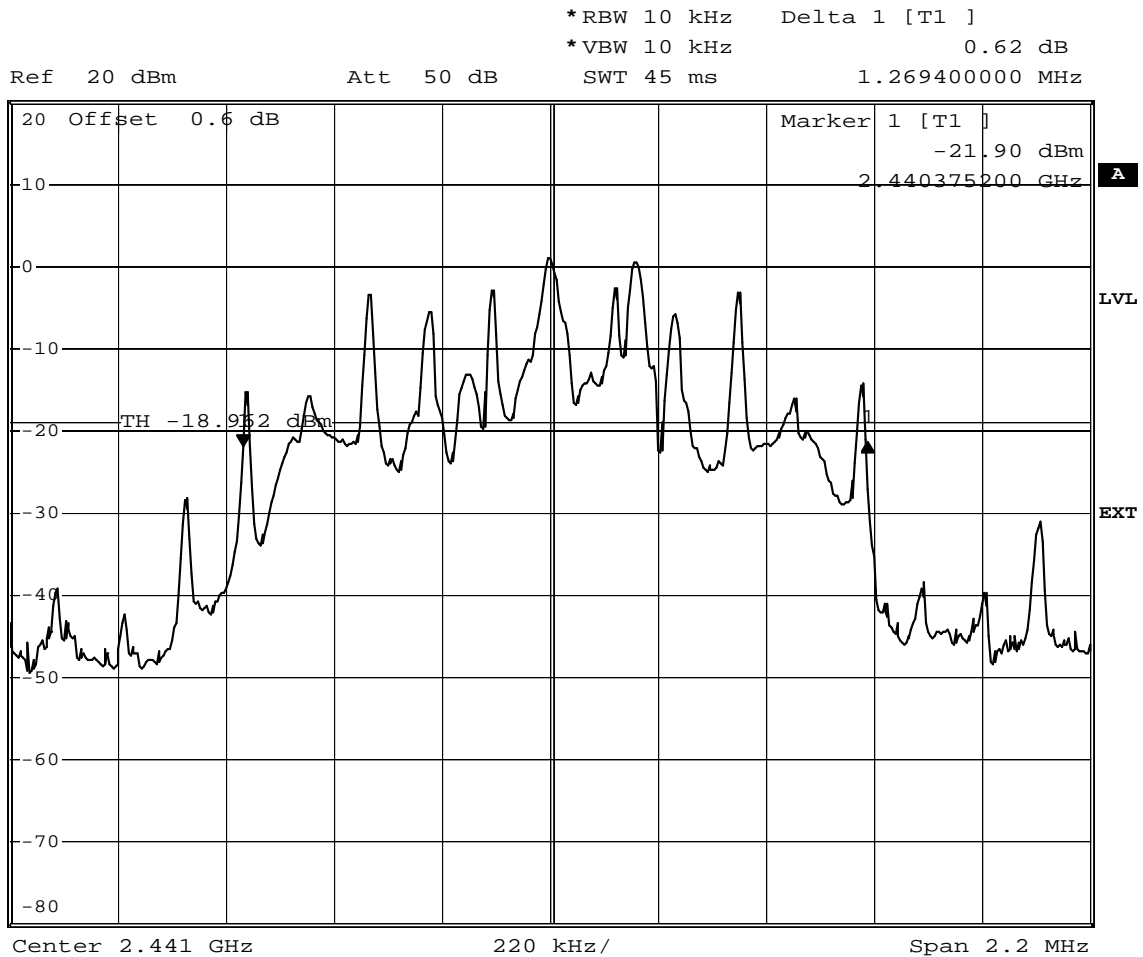

Comment: 20 dB bandwidth: 1269.4 KHz
 Date: 13.JUL.2010 08:11:36

FCC part 15.247
20 dB bandwidth

EUT	RF module with BT and WLAN
Model	WiBear-SF1
Approval Holder	lesswire AG
Temperature / Voltage	23°C / Vnom
Test Site / Operator	Eurofins Product Service GmbH / Mr. Treffke
Test Specification	FCC part 15 section 247(a)
Comment 1	20 dB bandwidth
Comment 2	Channel.: 78 / 2480 MHz / $\pi/4$ -DQPSK
Comment 3	

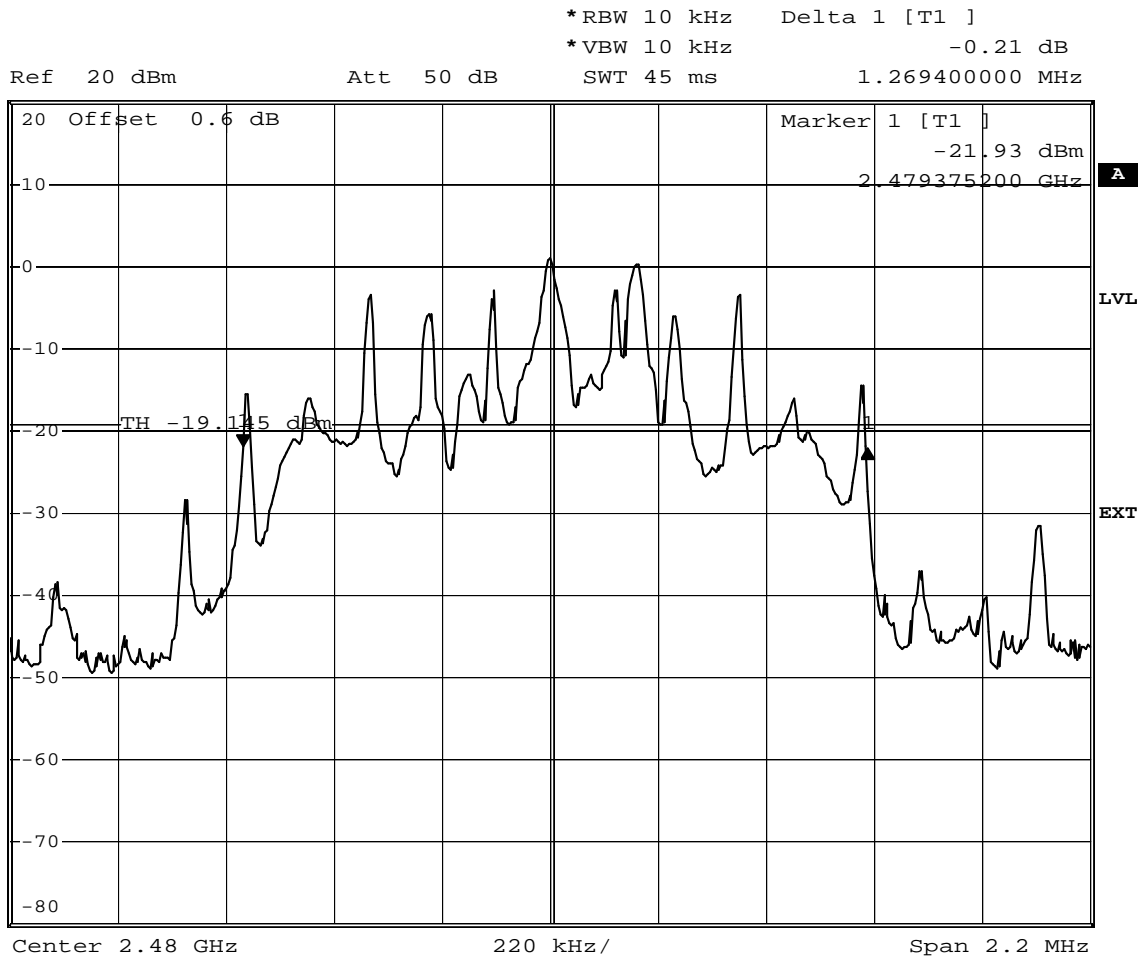

Comment: 20 dB bandwidth: 1269.4 KHz
Date: 13.JUL.2010 08:14:57

FCC part 15.247
20 dB bandwidth

EUT	RF module with BT and WLAN
Model	WiBear-SF1
Approval Holder	lesswire AG
Temperature / Voltage	23°C / Vnom
Test Site / Operator	Eurofins Product Service GmbH / Mr. Treffke
Test Specification	FCC part 15 section 247(a)
Comment 1	20 dB bandwidth
Comment 2	Channel.: 0 / 2402 MHz / 8DPSK



*RBW 10 kHz Delta 1 [T1]
*VBW 10 kHz -1.83 dB

Ref 20 dBm Att 50 dB SWT 45 ms 1.01420000 MHz

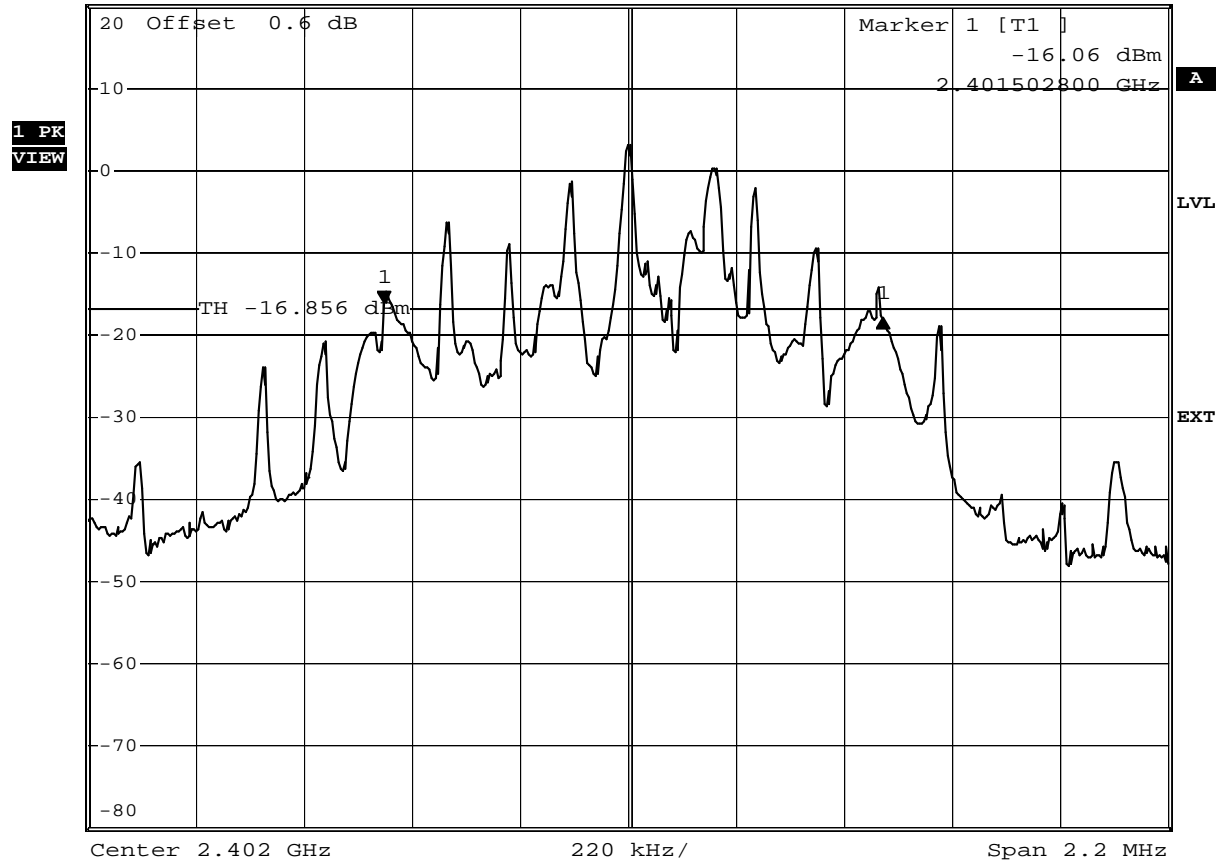

Comment: 20 dB bandwidth: 1014.2 KHz
Date: 13.JUL.2010 08:24:29

FCC part 15.247
20 dB bandwidth

EUT	RF module with BT and WLAN
Model	WiBear-SF1
Approval Holder	lesswire AG
Temperature / Voltage	23°C / Vnom
Test Site / Operator	Eurofins Product Service GmbH / Mr. Treffke
Test Specification	FCC part 15 section 247(a)
Comment 1	20 dB bandwidth
Comment 2	Channel.: 39 / 2441 MHz / 8DPSK
Comment 3	



*RBW 10 kHz Delta 1 [T1]
 *VBW 10 kHz -1.48 dB

Ref 20 dBm Att 50 dB SWT 45 ms 1.01420000 MHz

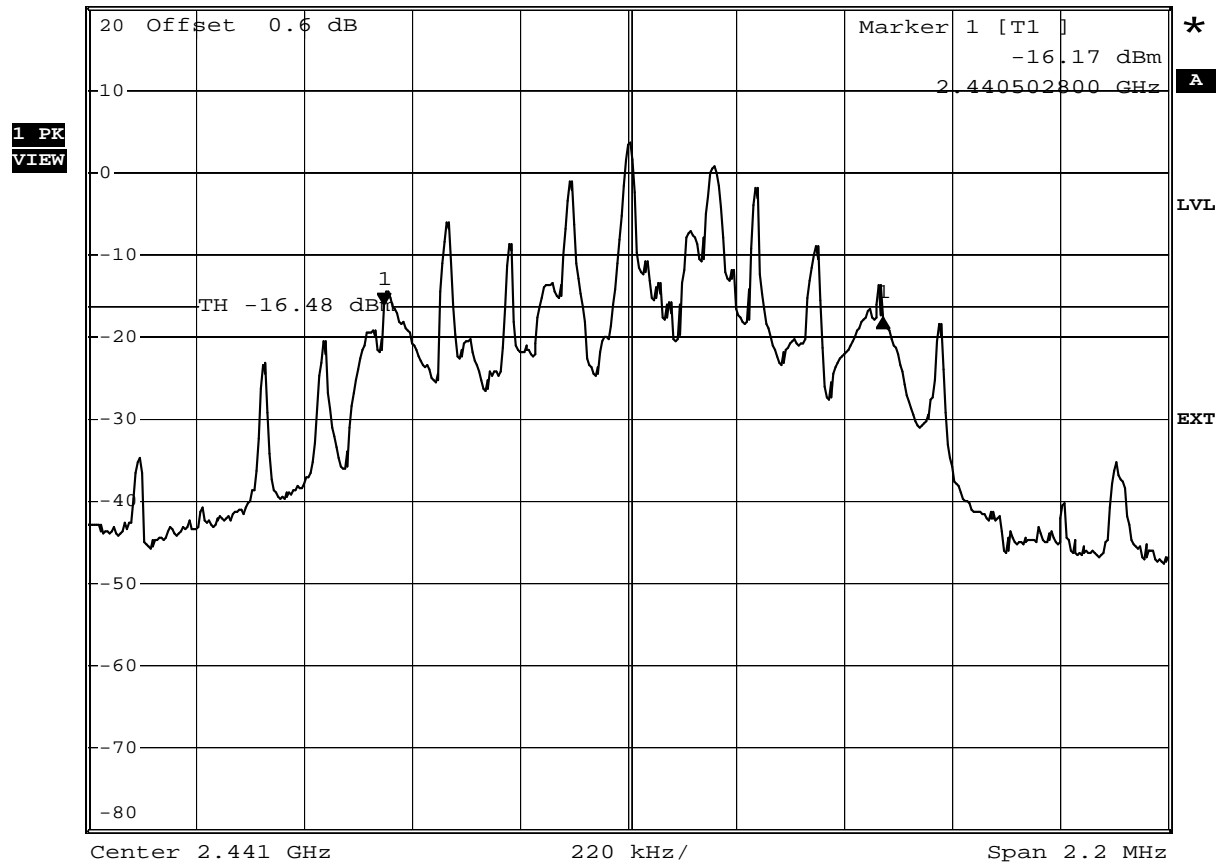

Comment: 20 dB bandwidth: 1014.2 KHz
 Date: 13.JUL.2010 08:20:52

FCC part 15.247
20 dB bandwidth

EUT	RF module with BT and WLAN
Model	WiBear-SF1
Approval Holder	lesswire AG
Temperature / Voltage	23°C / Vnom
Test Site / Operator	Eurofins Product Service GmbH / Mr. Treffke
Test Specification	FCC part 15 section 247(a)
Comment 1	20 dB bandwidth
Comment 2	Channel.: 78 / 2480 MHz / 8DPSK



*RBW 10 kHz Delta 1 [T1]
*VBW 10 kHz 1.94 dB

Ref 20 dBm Att 50 dB SWT 45 ms 1.018600000 MHz

1 PK
VIEW

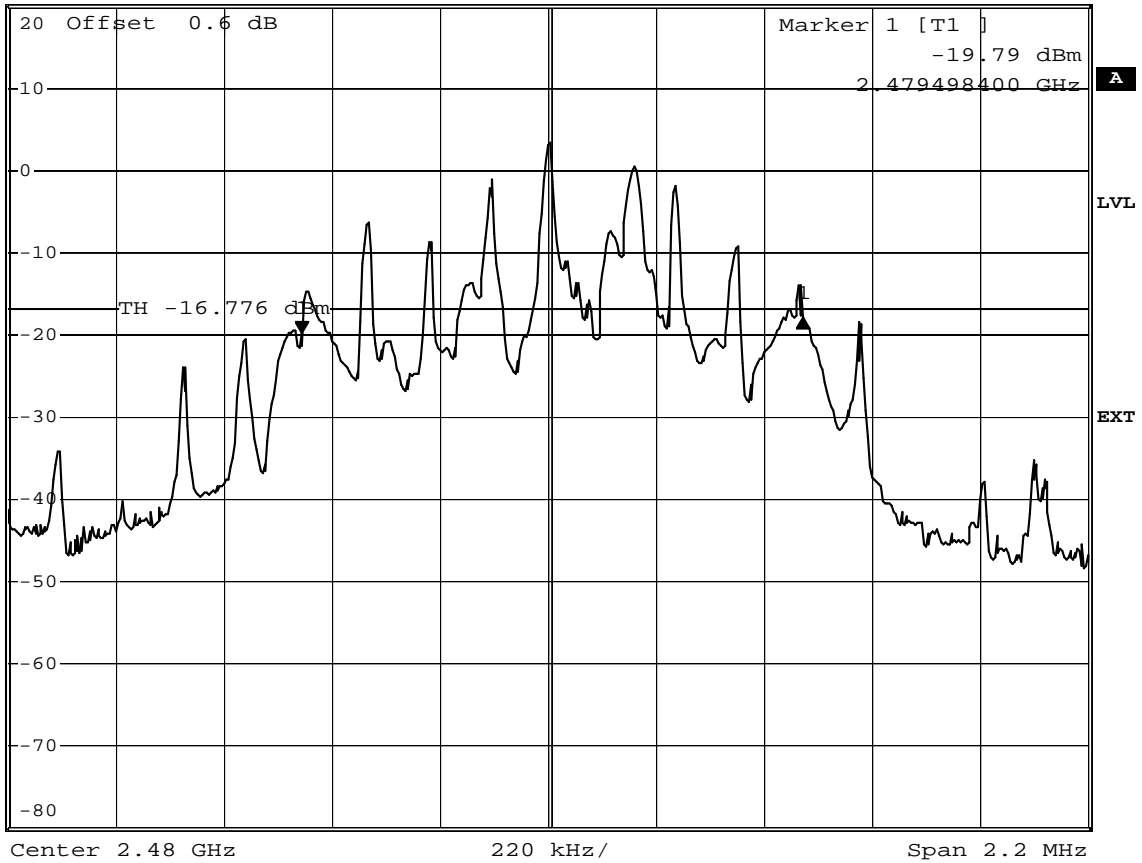

Comment: 20 dB bandwidth: 1018.6 KHz
Date: 13.JUL.2010 08:18:30

Annex C Hopping channels

FCC part 15.247

Number of hopping frequencies

EUT	RF module with BT and WLAN
Model	WiBear-SF1
Approval Holder	lesswire AG
Temperature / Voltage	23°C / Vnom
Test Site / Operator	Eurofins Product Service GmbH / Mr. Treffke
Test Specification	FCC part 15 section 247(a)
Comment 1	Number of hopping frequencies
Comment 2	Channel.: 0-13
Comment 3	



*RBW 300 kHz

*VBW 300 kHz

SWT 2.5 ms

Ref 20 dBm

Att 50 dB

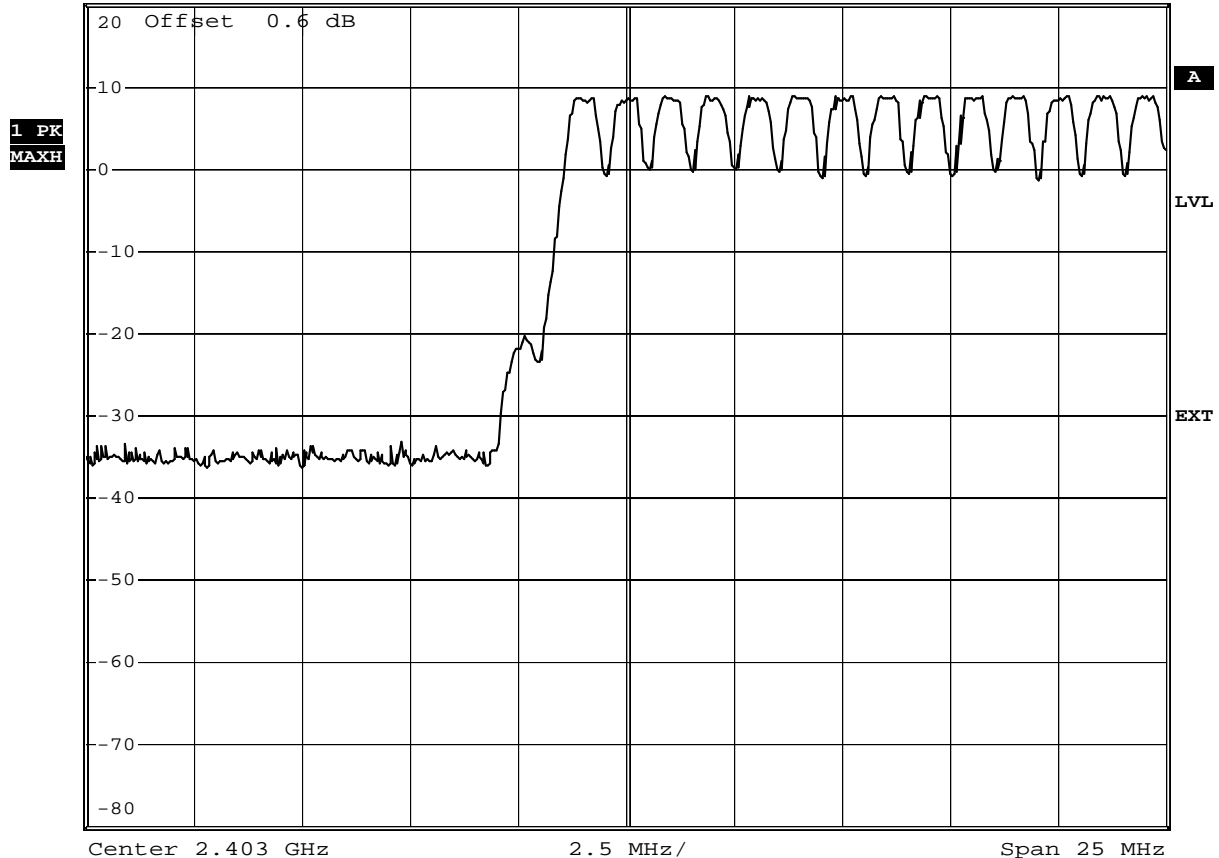

Date: 13.JUL.2010 14:15:30

Test Report No.: G0M21007-3443-P-15

Eurofins Product Service GmbH
Storkower Str. 38c, D-15526 Reichenwalde, Germany

Page 48 of 70

FCC part 15.247
Number of hopping frequencies

EUT	RF module with BT and WLAN
Model	WiBear-SF1
Approval Holder	lesswire AG
Temperature / Voltage	23°C / Vnom
Test Site / Operator	Eurofins Product Service GmbH / Mr. Treffke
Test Specification	FCC part 15 section 247(a)
Comment 1	Number of hopping frequencies
Comment 2	Channel.: 14-38
Comment 3	

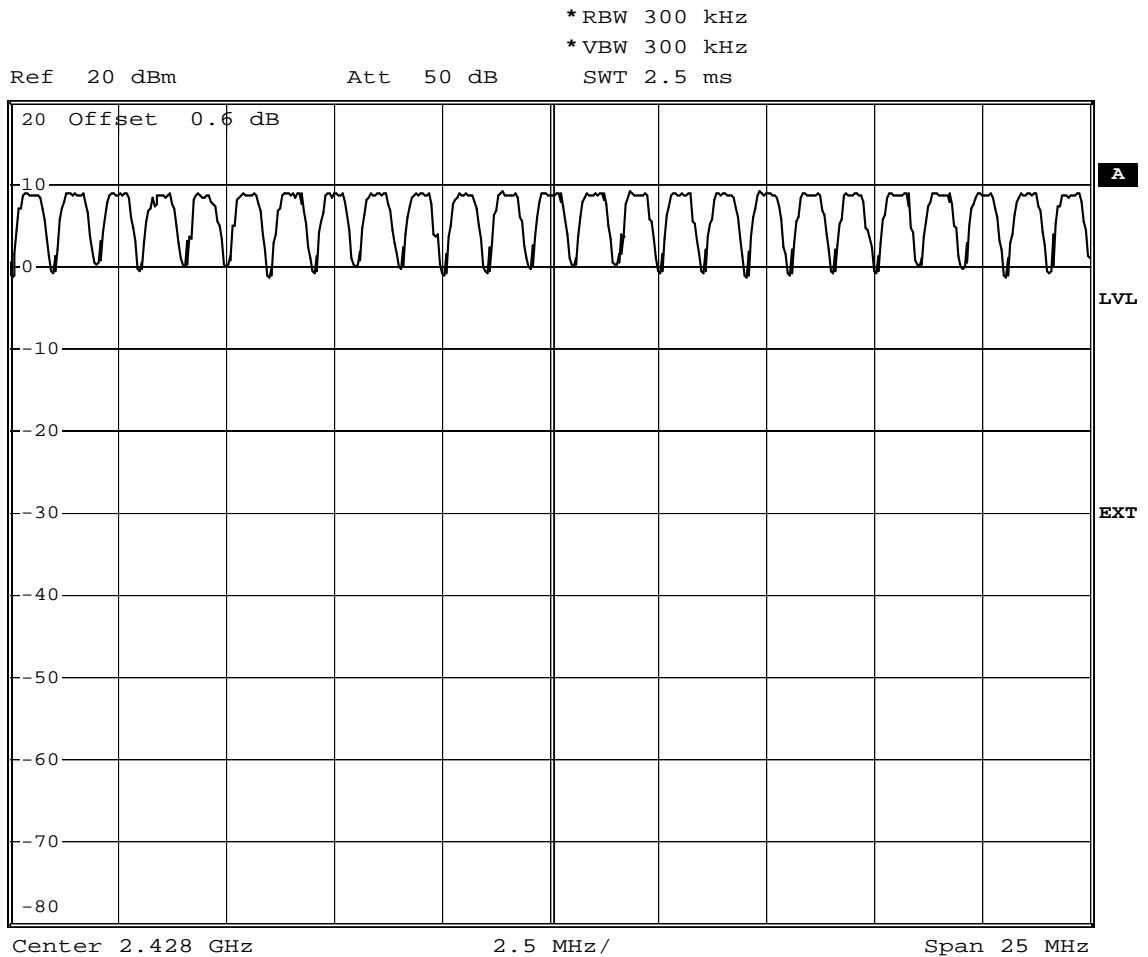

Comment: Number of hopping frequencies
 Date: 13.JUL.2010 14:13:26

FCC part 15.247
Number of hopping frequencies

EUT	RF module with BT and WLAN
Model	WiBear-SF1
Approval Holder	lesswire AG
Temperature / Voltage	23°C / Vnom
Test Site / Operator	Eurofins Product Service GmbH / Mr. Treffke
Test Specification	FCC part 15 section 247(a)
Comment 1	Number of hopping frequencies
Comment 2	Channel.:39-63
Comment 3	



*RBW 300 kHz
 *VBW 300 kHz

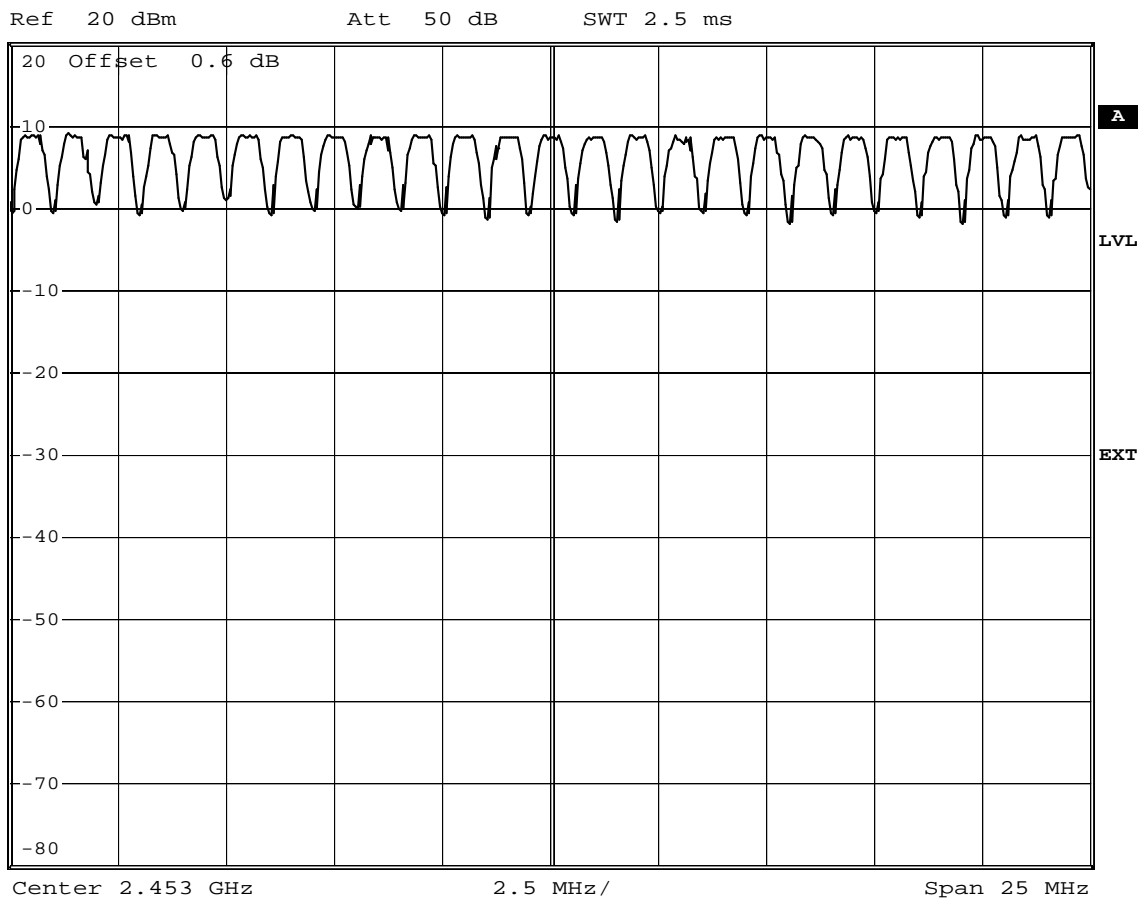

Comment: Number of hopping frequencies
 Date: 13.JUL.2010 14:09:59

FCC part 15.247
Number of hopping frequencies

EUT	RF module with BT and WLAN
Model	WiBear-SF1
Approval Holder	lesswire AG
Temperature / Voltage	23°C / Vnom
Test Site / Operator	Eurofins Product Service GmbH / Mr. Treffke
Test Specification	FCC part 15 section 247(a)
Comment 1	Number of hopping frequencies
Comment 2	Channel.: 64-78
Comment 3	

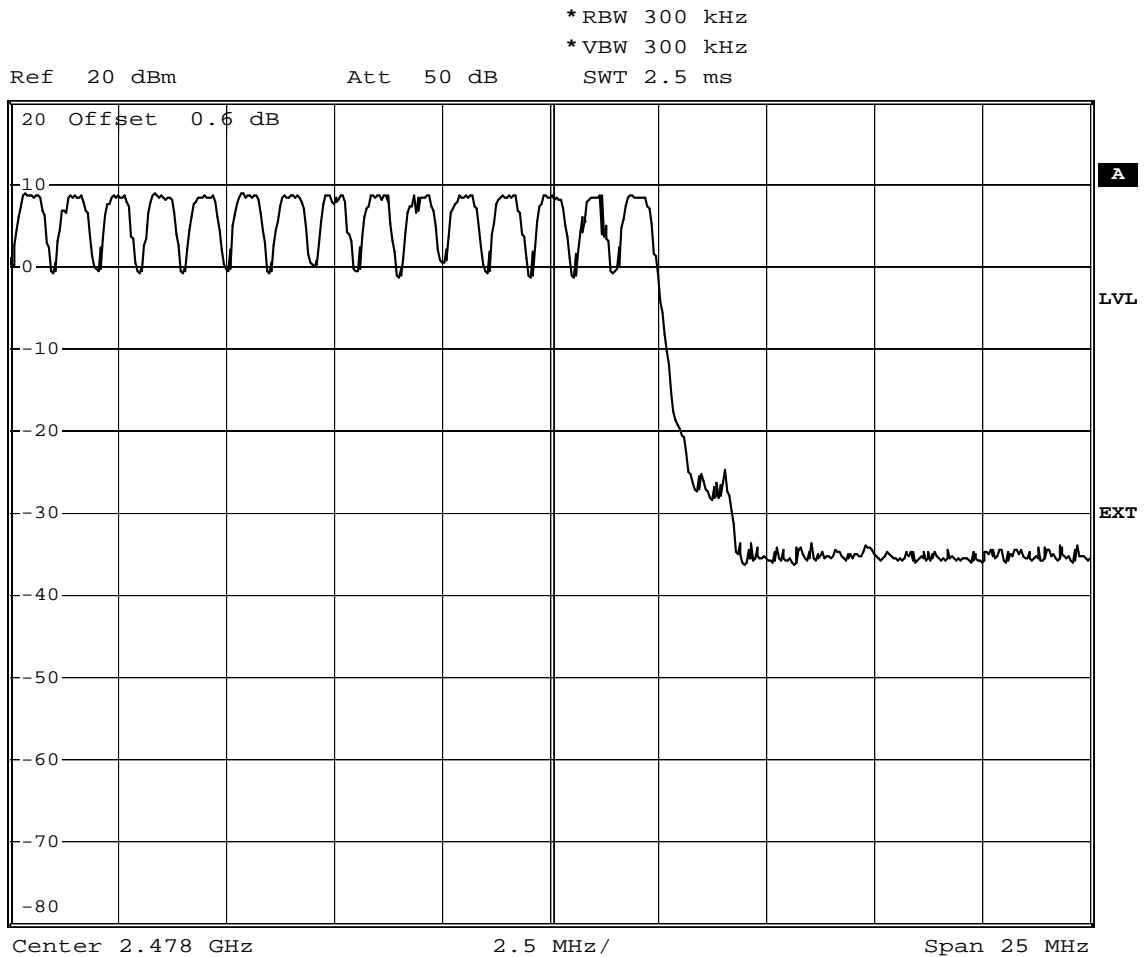

Comment: Number of hopping frequencies
 Date: 13.JUL.2010 14:08:18

Annex D Hopping channel separation

FCC part 15.247

Carrier frequency separation

EUT	RF module with BT and WLAN
Model	WiBear-SF1
Approval Holder	lesswire AG
Temperature / Voltage	23°C / Vnom
Test Site / Operator	Eurofins Product Service GmbH / Mr. Treffke
Test Specification	FCC part 15 section 247(a)(1)
Comment 1	Carrier frequency separation
Comment 2	Channel.: 39/40 / 2441/2442 MHz
Comment 3	Hopping mode



*RBW 100 kHz Delta 1 [T1]
 *VBW 100 kHz 0.01 dB
 Ref 20 dBm Att 50 dB SWT 2.5 ms 1.000000000 MHz

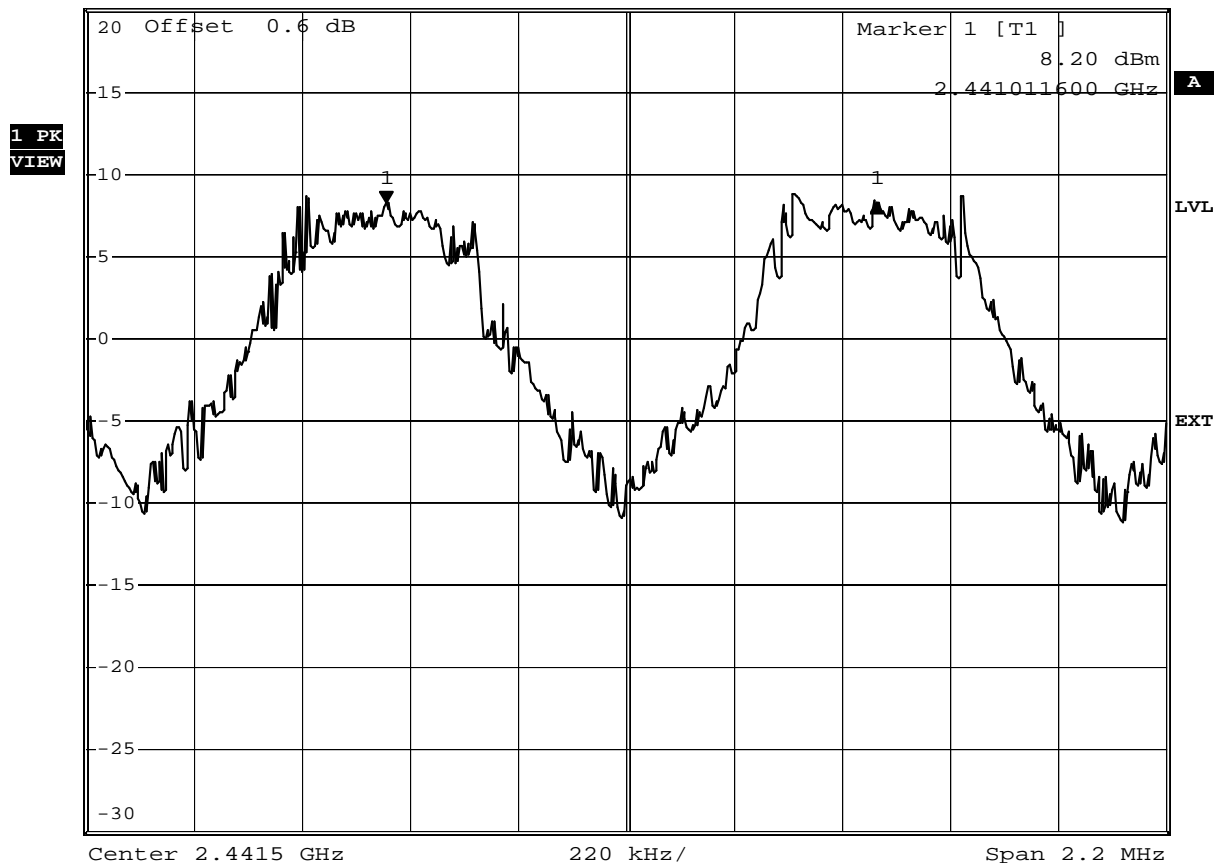

Comment: Limit: > two-thirds of the 20 dB bandwidth ; Result: Pass

Date: 13.JUL.2010 14:19:08

Annex E Time of occupancy

FCC part 15.247

Time of occupancy (dwell time)

EUT	RF module with BT and WLAN
Model	WiBear-SF1
Approval Holder	lesswire AG
Temperature / Voltage	23°C / Vnom
Test Site / Operator	Eurofins Product Service GmbH / Mr. Treffke
Test Specification	FCC part 15 section 247(a)
Comment 1	Time of occupancy
Comment 2	Channel.: 39 / 2441 MHz (Hopping mode)
Comment 3	63 events * 1.69 ms result: 107 ms

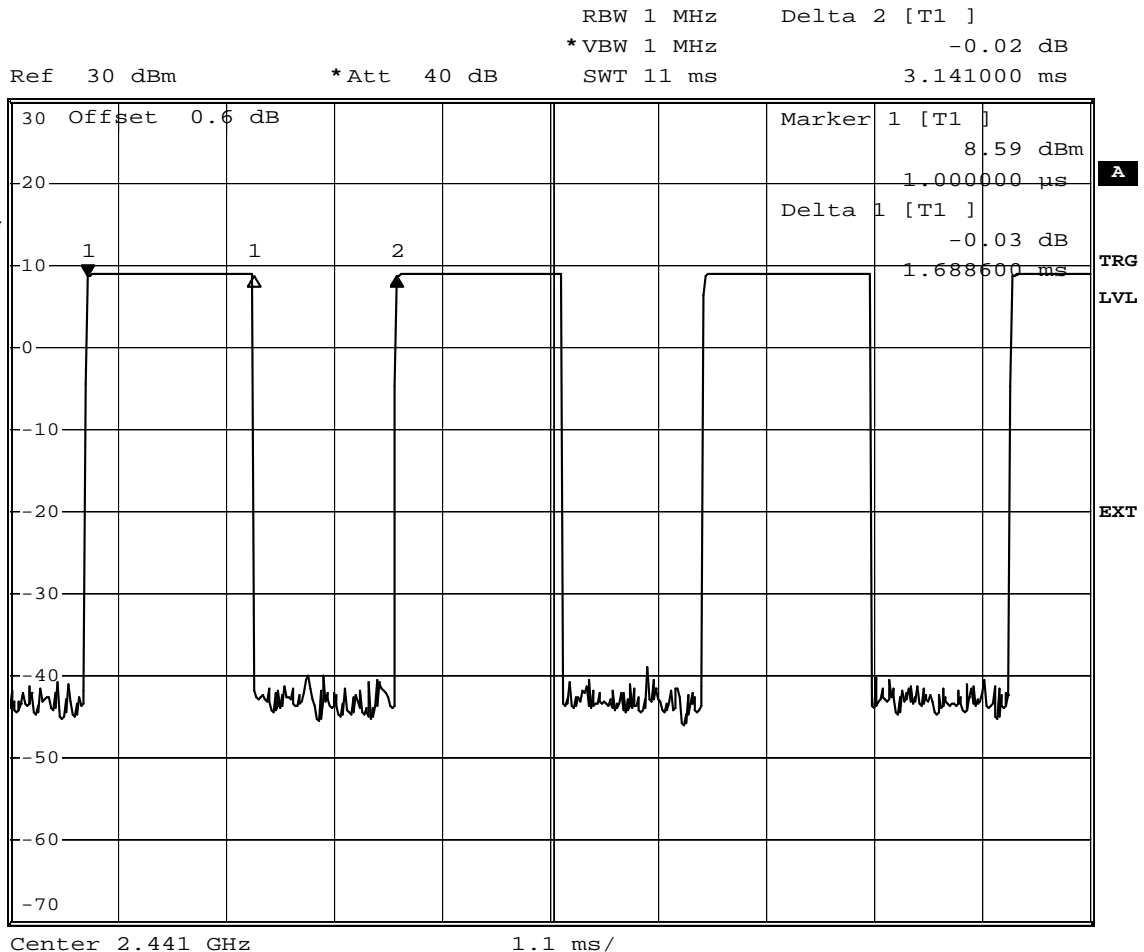

Comment: Duty cycle=0.54

Date: 13.JUL.2010 14:22:32

Annex F AC Powerline Conducted Emissions

EMI voltage test in the ac-mains according to FCC 15B

Order number: G0M21007-3443

Manufacturer: lesswire AG
 EUT Name: RF module with WLAN and BT
 Model: AN00K73535
 Test Site: Eurofins Product Service GmbH
 Operator: Mr. Klein
 Test Conditions: Tnom: 23°C, Unom: 120VAC
 LISN: ESH2-Z5 L
 Mode: powered from notebook
 Test Date: 03.09.2010
 Note:

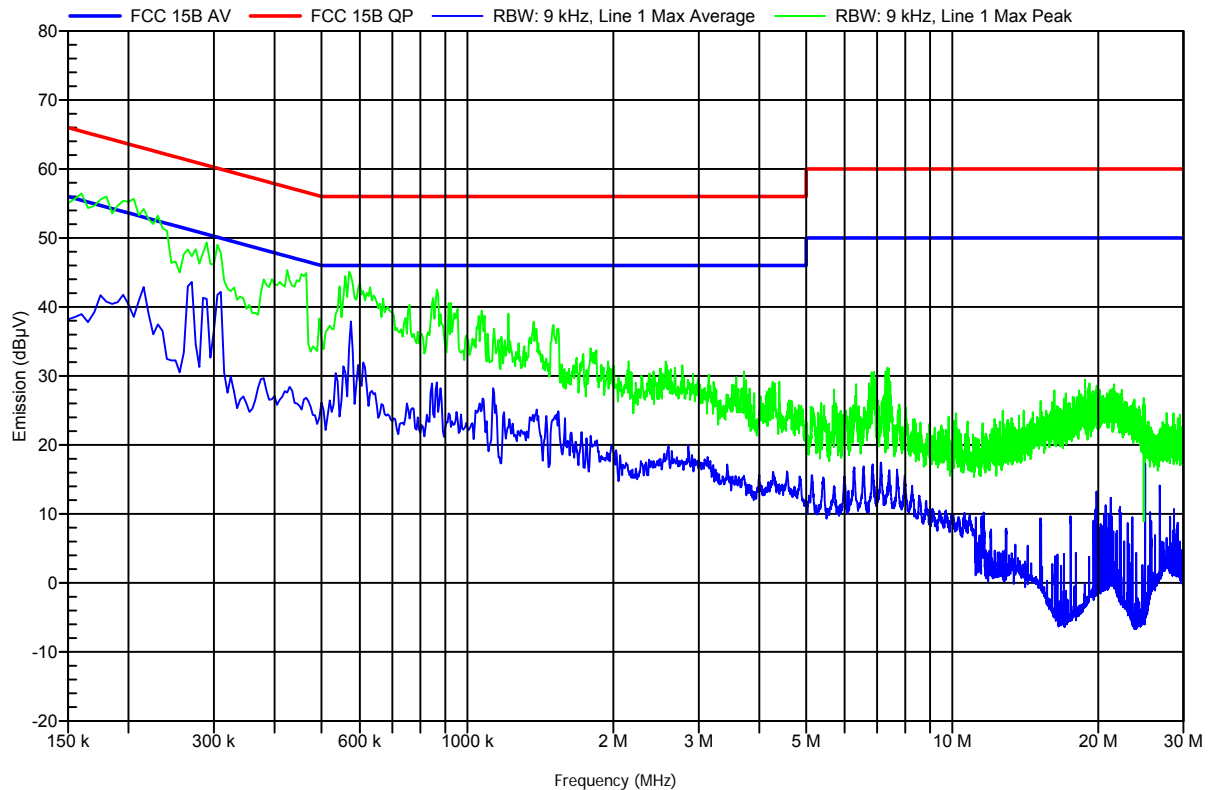

EMI voltage test in the ac-mains according to FCC 15B

Order number: G0M21007-3443

Manufacturer: lesswire AG
 EUT Name: RF module with WLAN and BT
 Model: AN00K73535
 Test Site: Eurofins Product Service GmbH
 Operator: Mr. Klein
 Test Conditions: Tnom: 23°C, Unom: 120VAC
 LISN: ESH2-Z5 N
 Mode: powered from notebook
 Test Date: 03.09.2010
 Note:

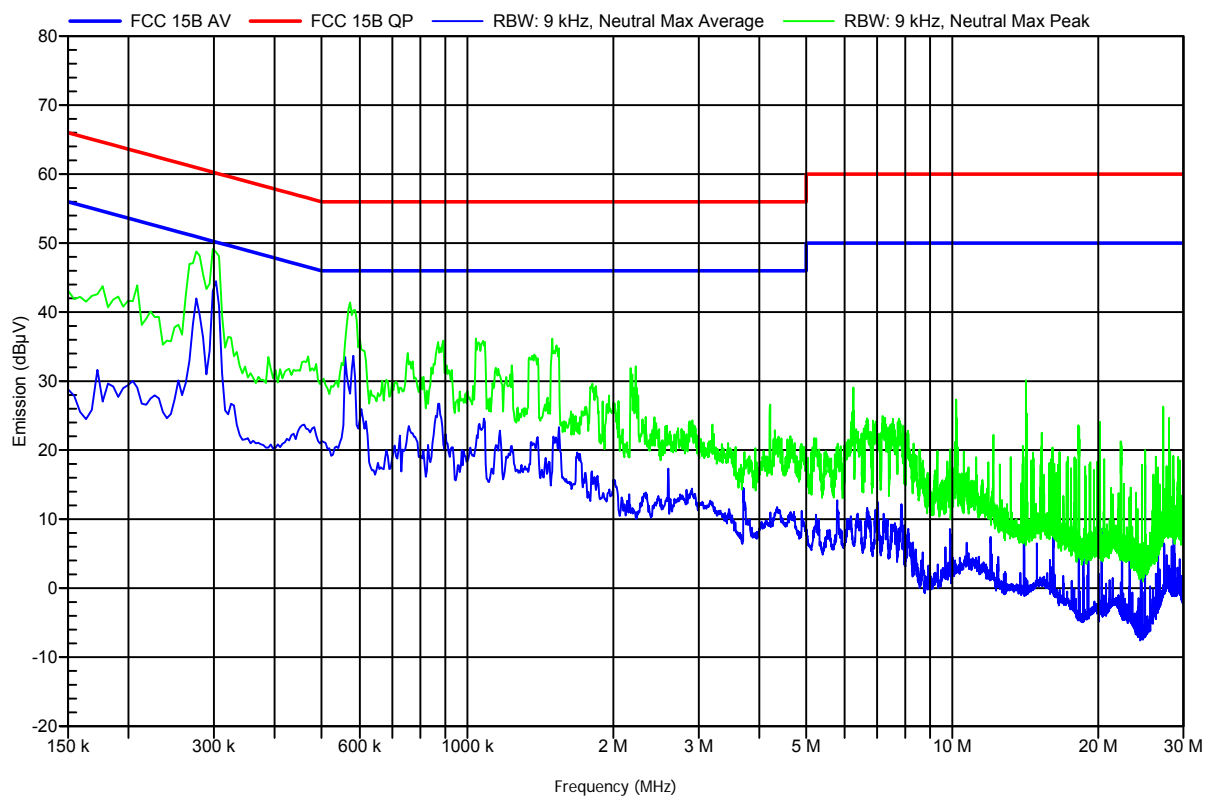

Annex G Transmitter conducted spurious emissions

FCC part 15.247 (d) Spurious Emissions

EUT	RF module with BT and WLAN
Model	WiBear-SF1
Approval Holder	lesswire AG
Temperature / Voltage	23°C / Vnom
Test Site / Operator	Eurofins Product Service GmbH / Mr. Treffke
Test Specification	FCC part 15.247 (d)
Comment 1	Spurious Emissions conducted
Comment 2	Channel : 2402 MHz
Comment 3	GFSK / DH5

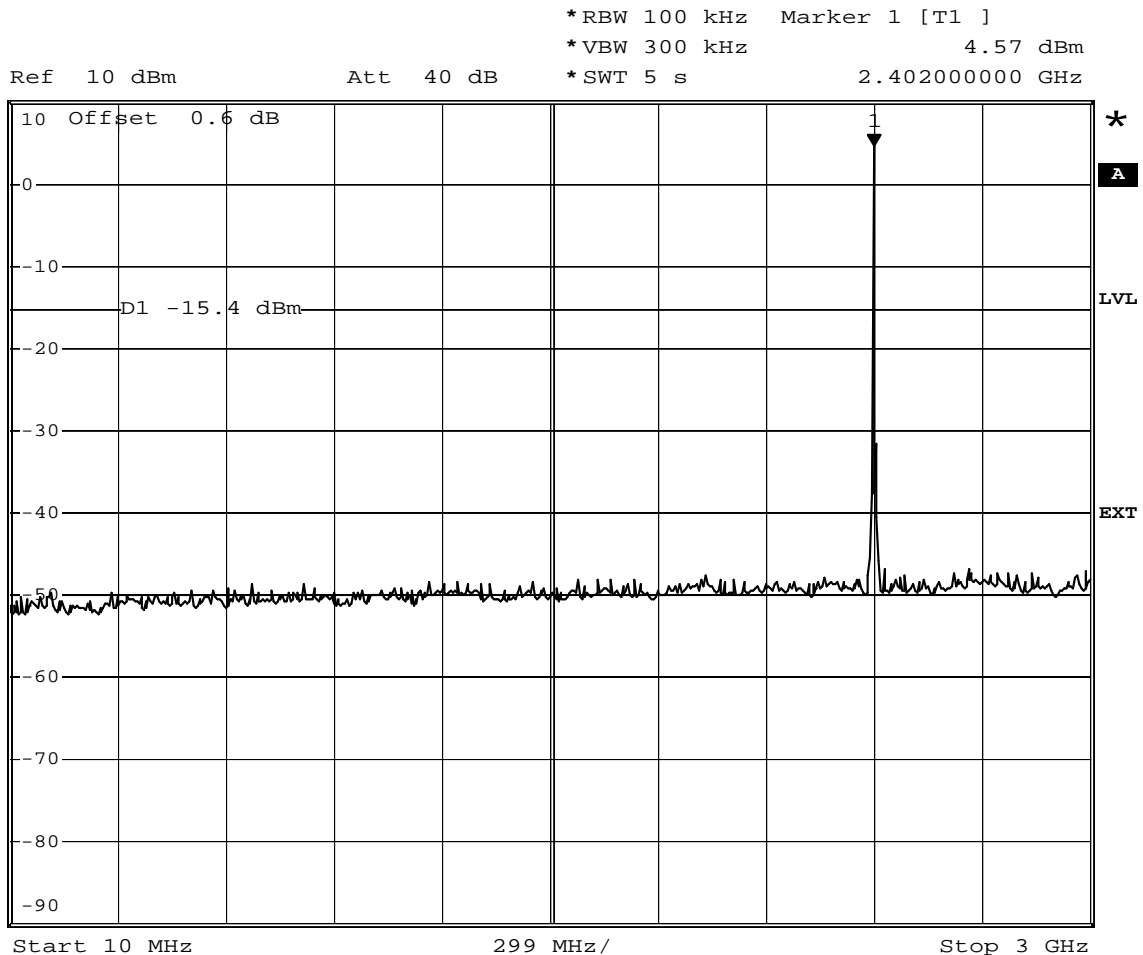

Date: 13.JUL.2010 15:51:52

Test Report No.: G0M21007-3443-P-15

Eurofins Product Service GmbH
 Storkower Str. 38c, D-15526 Reichenwalde, Germany

Page 56 of 70

**FCC part 15.247 (d)
Spurious Emissions**

EUT	RF module with BT and WLAN
Model	WiBear-SF1
Approval Holder	lesswire AG
Temperature / Voltage	23°C / Vnom
Test Site / Operator	Eurofins Product Service GmbH / Mr. Treffke
Test Specification	FCC part 15.247 (d)
Comment 1	Spurious Emissions conducted
Comment 2	Channel : 2402 MHz
Comment 3	GFSK / DH5

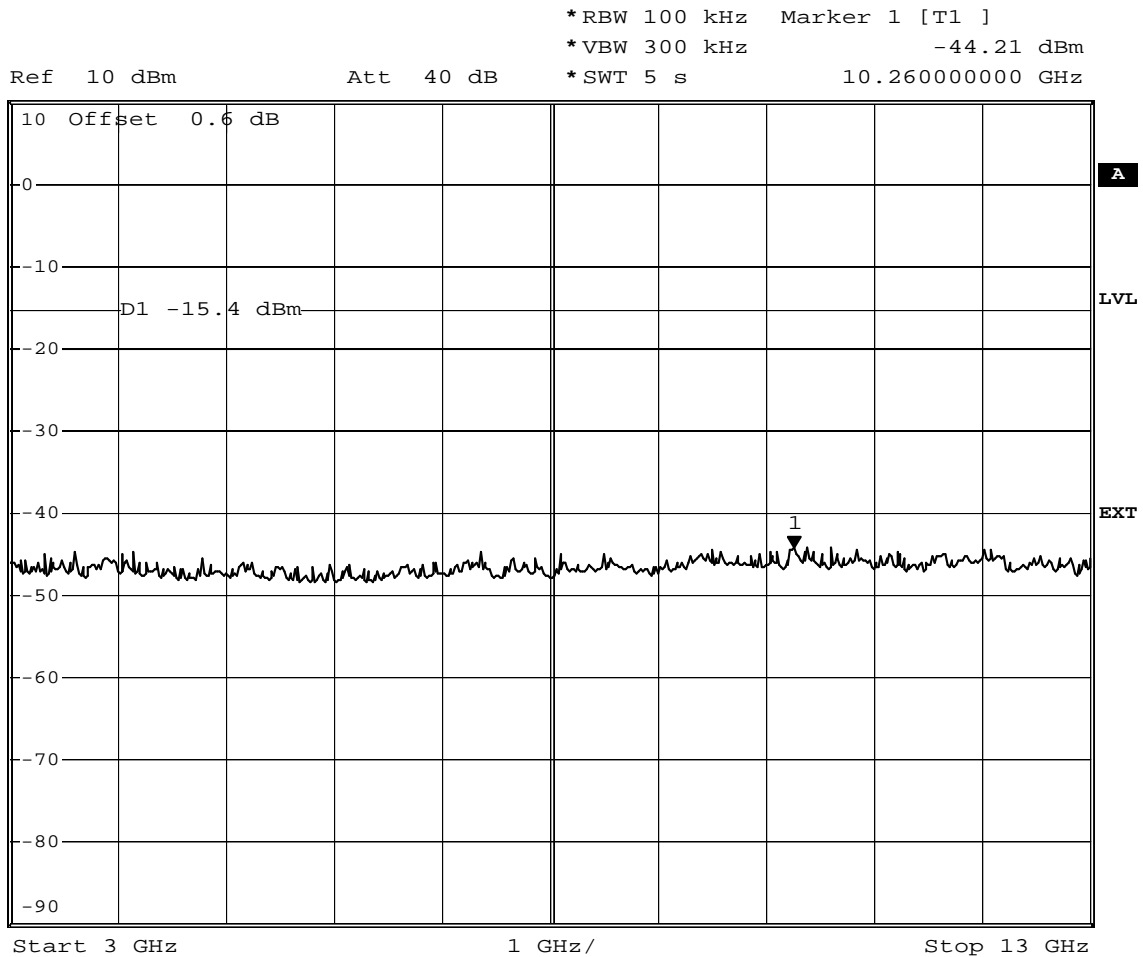

Date: 13.JUL.2010 15:53:07

**FCC part 15.247 (d)
Spurious Emissions**

EUT	RF module with BT and WLAN
Model	WiBear-SF1
Approval Holder	lesswire AG
Temperature / Voltage	23°C / Vnom
Test Site / Operator	Eurofins Product Service GmbH / Mr. Treffke
Test Specification	FCC part 15.247 (d)
Comment 1	Spurious Emissions conducted
Comment 2	Channel : 2441 MHz
Comment 3	GFSK / DH5

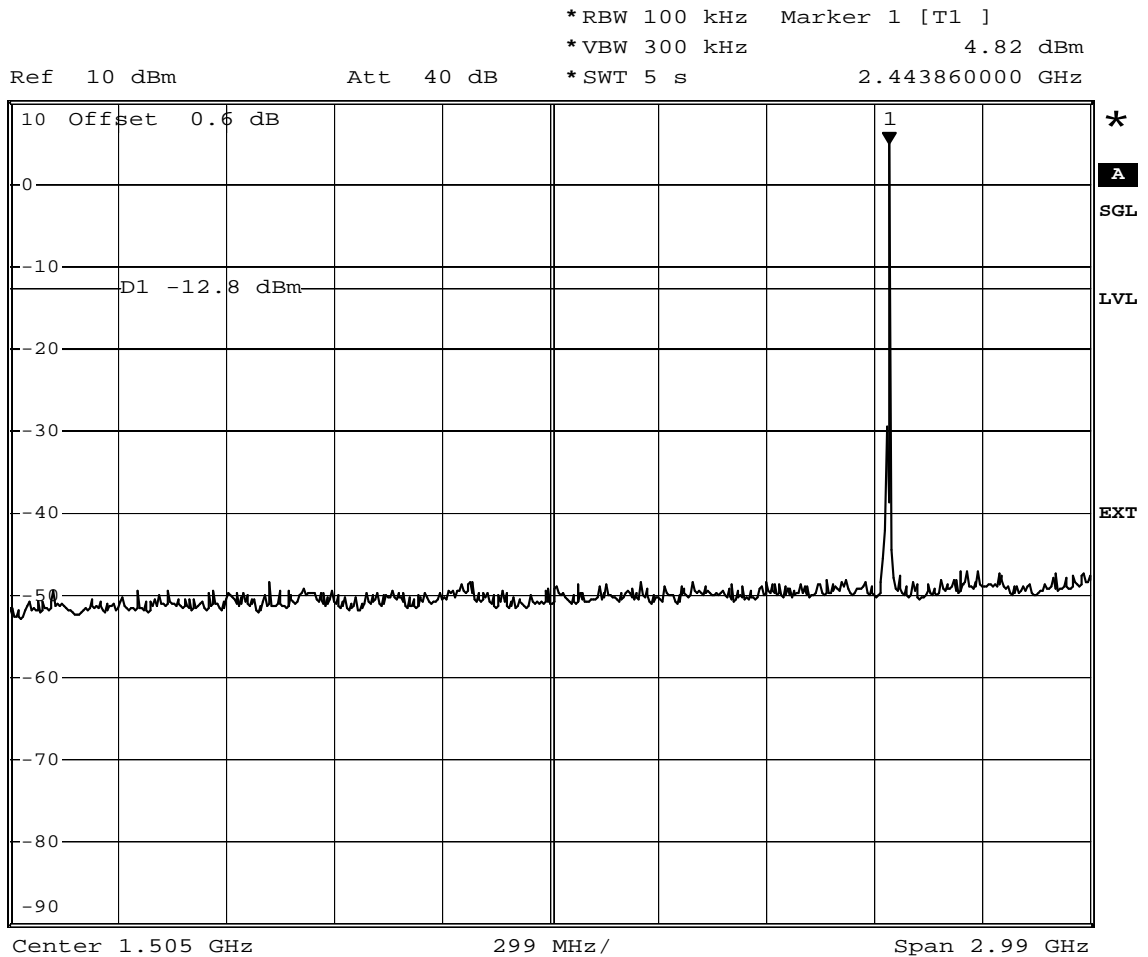

Date: 13.JUL.2010 15:57:32

Test Report No.: G0M21007-3443-P-15

 Eurofins Product Service GmbH
 Storkower Str. 38c, D-15526 Reichenwalde, Germany

Page 59 of 70

**FCC part 15.247 (d)
Spurious Emissions**

EUT	RF module with BT and WLAN
Model	WiBear-SF1
Approval Holder	lesswire AG
Temperature / Voltage	23°C / Vnom
Test Site / Operator	Eurofins Product Service GmbH / Mr. Treffke
Test Specification	FCC part 15.247 (d)
Comment 1	Spurious Emissions conducted
Comment 2	Channel : 2441 MHz
Comment 3	GFSK / DH5

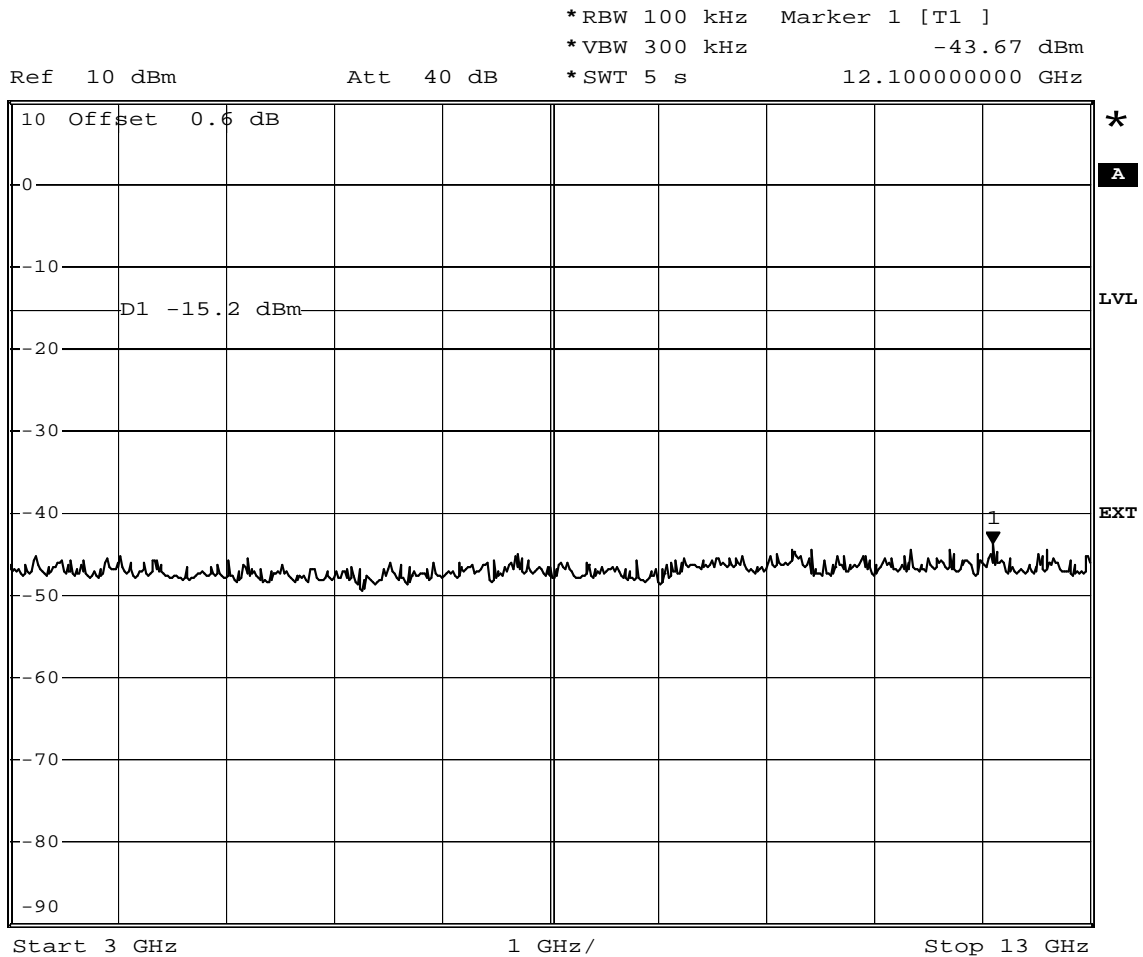

Date: 13.JUL.2010 15:59:45

**FCC part 15.247 (d)
Spurious Emissions**

EUT	RF module with BT and WLAN
Model	WiBear-SF1
Approval Holder	lesswire AG
Temperature / Voltage	23°C / Vnom
Test Site / Operator	Eurofins Product Service GmbH / Mr. Treffke
Test Specification	FCC part 15.247 (d)
Comment 1	Spurious Emissions conducted
Comment 2	Channel : 2441 MHz
Comment 3	GFSK / DH5

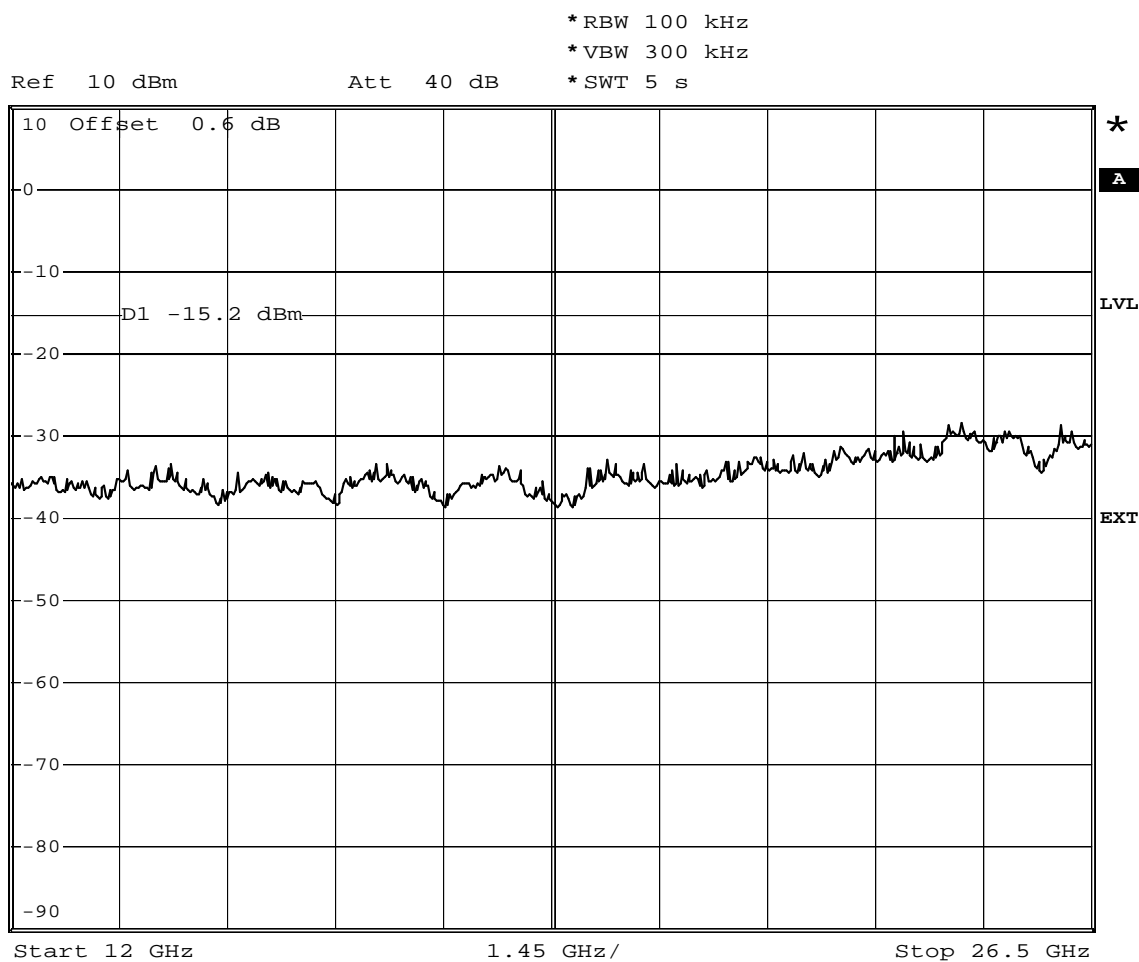

Date: 13.JUL.2010 16:00:20

**FCC part 15.247 (d)
Spurious Emissions**

EUT	RF module with BT and WLAN
Model	WiBear-SF1
Approval Holder	lesswire AG
Temperature / Voltage	23°C / Vnom
Test Site / Operator	Eurofins Product Service GmbH / Mr. Treffke
Test Specification	FCC part 15.247 (d)
Comment 1	Spurious Emissions conducted
Comment 2	Channel : 2480 MHz
Comment 3	GFSK / DH5

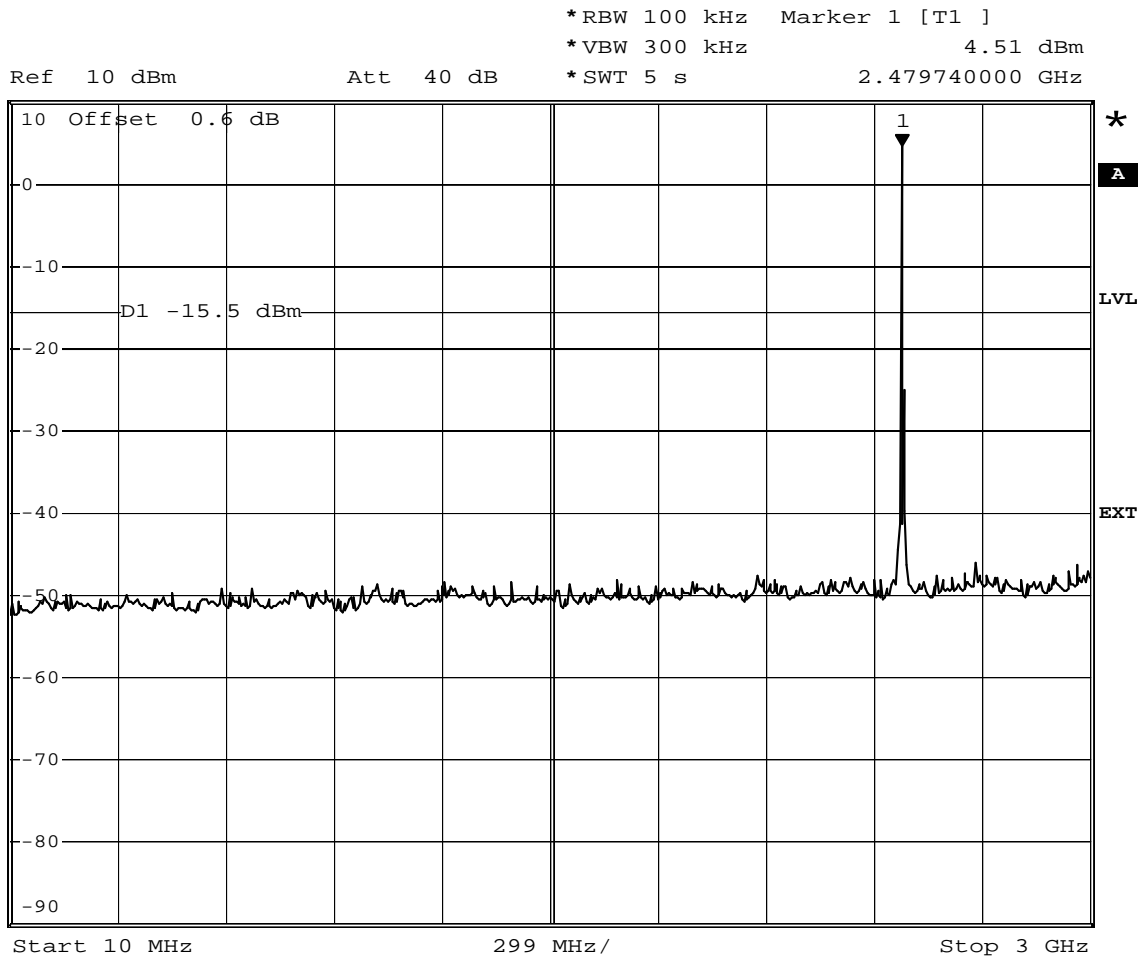

Date: 13.JUL.2010 16:04:59

**FCC part 15.247 (d)
Spurious Emissions**

EUT	RF module with BT and WLAN
Model	WiBear-SF1
Approval Holder	lesswire AG
Temperature / Voltage	23°C / Vnom
Test Site / Operator	Eurofins Product Service GmbH / Mr. Treffke
Test Specification	FCC part 15.247 (d)
Comment 1	Spurious Emissions conducted
Comment 2	Channel : 2480 MHz
Comment 3	GFSK / DH5

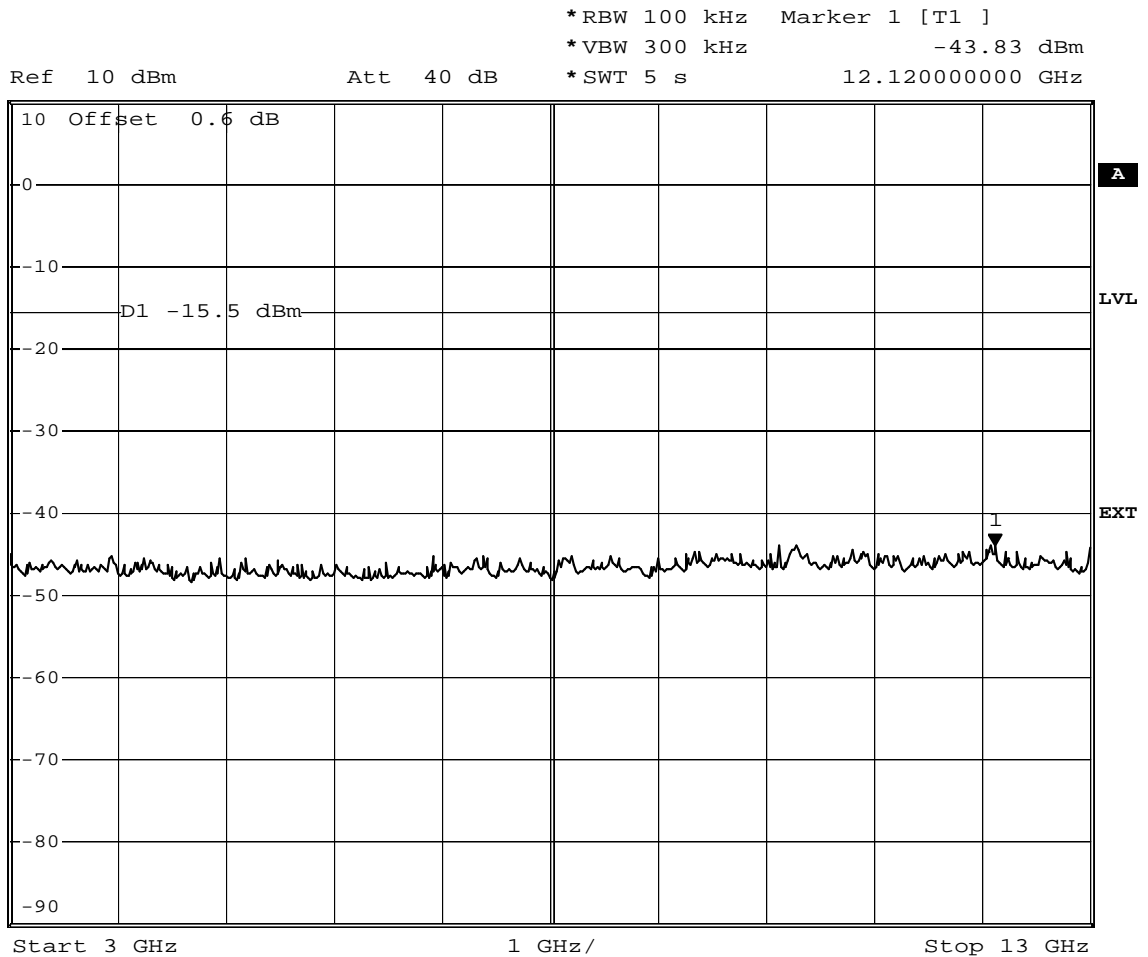

Date: 13.JUL.2010 16:05:50

Test Report No.: G0M21007-3443-P-15

Eurofins Product Service GmbH
Storkower Str. 38c, D-15526 Reichenwalde, Germany

Page 63 of 70

**FCC part 15.247 (d)
Spurious Emissions**

EUT	RF module with BT and WLAN
Model	WiBear-SF1
Approval Holder	lesswire AG
Temperature / Voltage	23°C / Vnom
Test Site / Operator	Eurofins Product Service GmbH / Mr. Treffke
Test Specification	FCC part 15.247 (d)
Comment 1	Spurious Emissions conducted
Comment 2	Channel : 2480 MHz
Comment 3	GFSK / DH5



*RBW 100 kHz
*VBW 300 kHz
*SWT 5 s

Ref 10 dBm

Att 40 dB

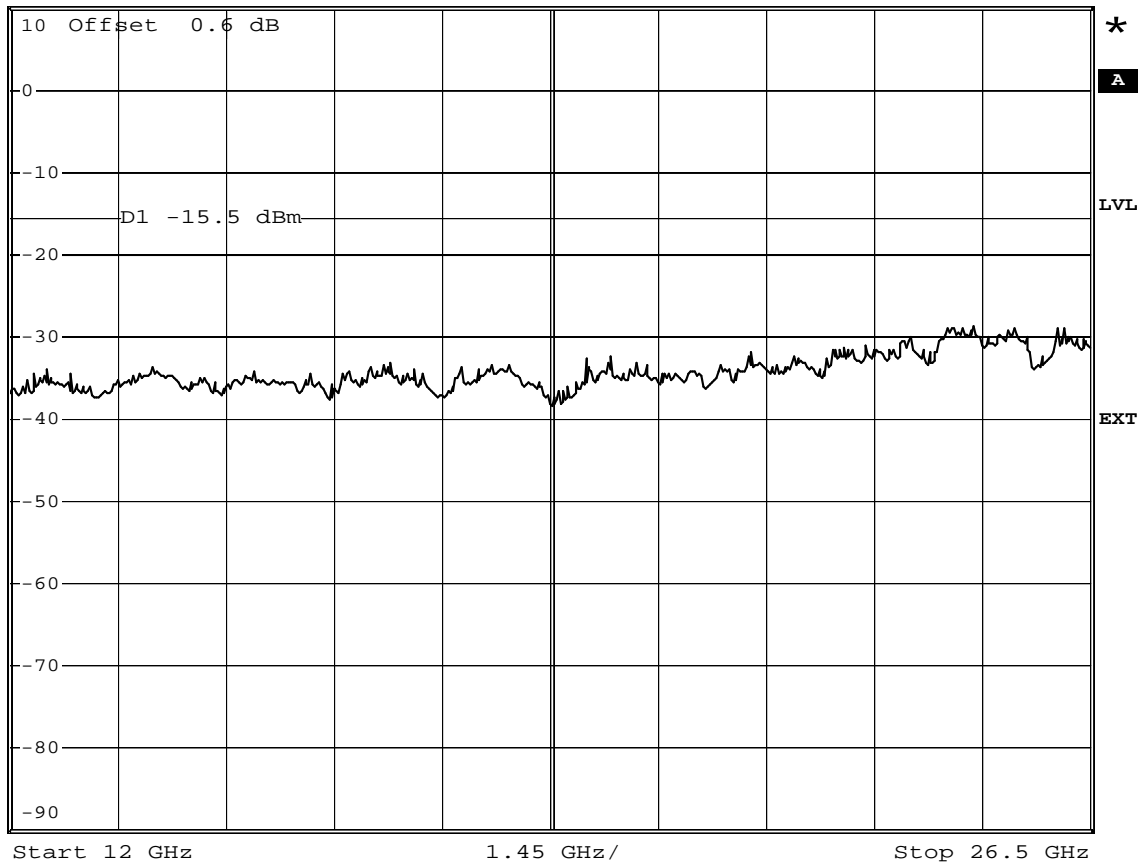
**1 PK
VIEW**

Date: 13.JUL.2010 16:06:55

Annex H Band edge compliance

FCC part 15.247

Band-edge compliance of RF conducted emissions

EUT	RF module with BT and WLAN
Model	WiBear-SF1
Approval Holder	lesswire AG
Temperature / Voltage	23°C / Vnom
Test Site / Operator	Eurofins Product Service GmbH / Mr. Treffke
Test Specification	FCC part 15 section 247(c)
Comment 1	Band-edge compliance
Comment 2	Channel.: 0 / 2402 MHz / GFSK
Comment 3	Hopping mode

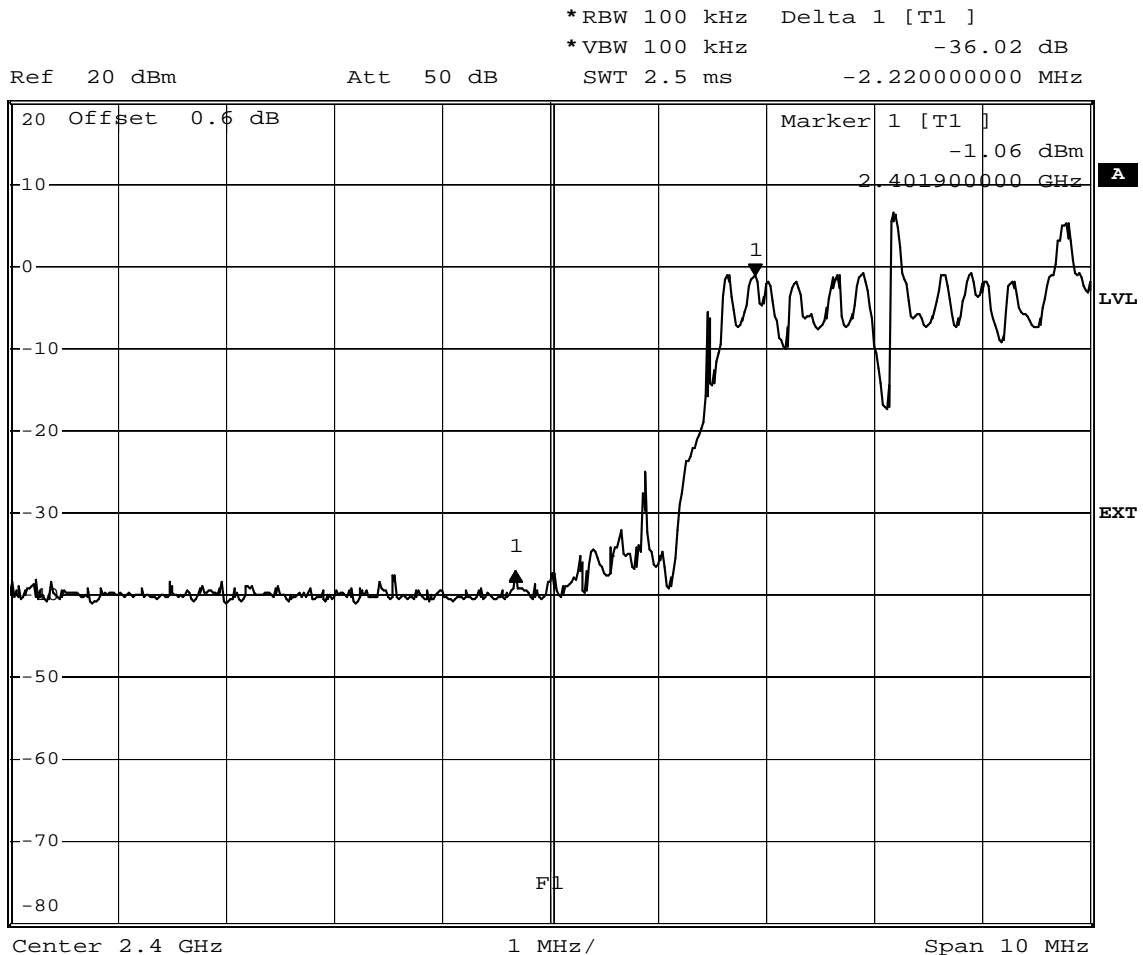

Comment: Limit: Marker Delta value >20 dB; Result: PASS

Date: 13.JUL.2010 09:25:25

FCC part 15.247
Band-edge compliance of RF conducted emissions

EUT	RF module with BT and WLAN
Model	WiBear-SF1
Approval Holder	lesswire AG
Temperature / Voltage	23°C / Vnom
Test Site / Operator	Eurofins Product Service GmbH / Mr. Treffke
Test Specification	FCC part 15 section 247(c)
Comment 1	Band-edge compliance
Comment 2	Channel.: 78 / 2480 MHz / GFSK
Comment 3	Hopping mode

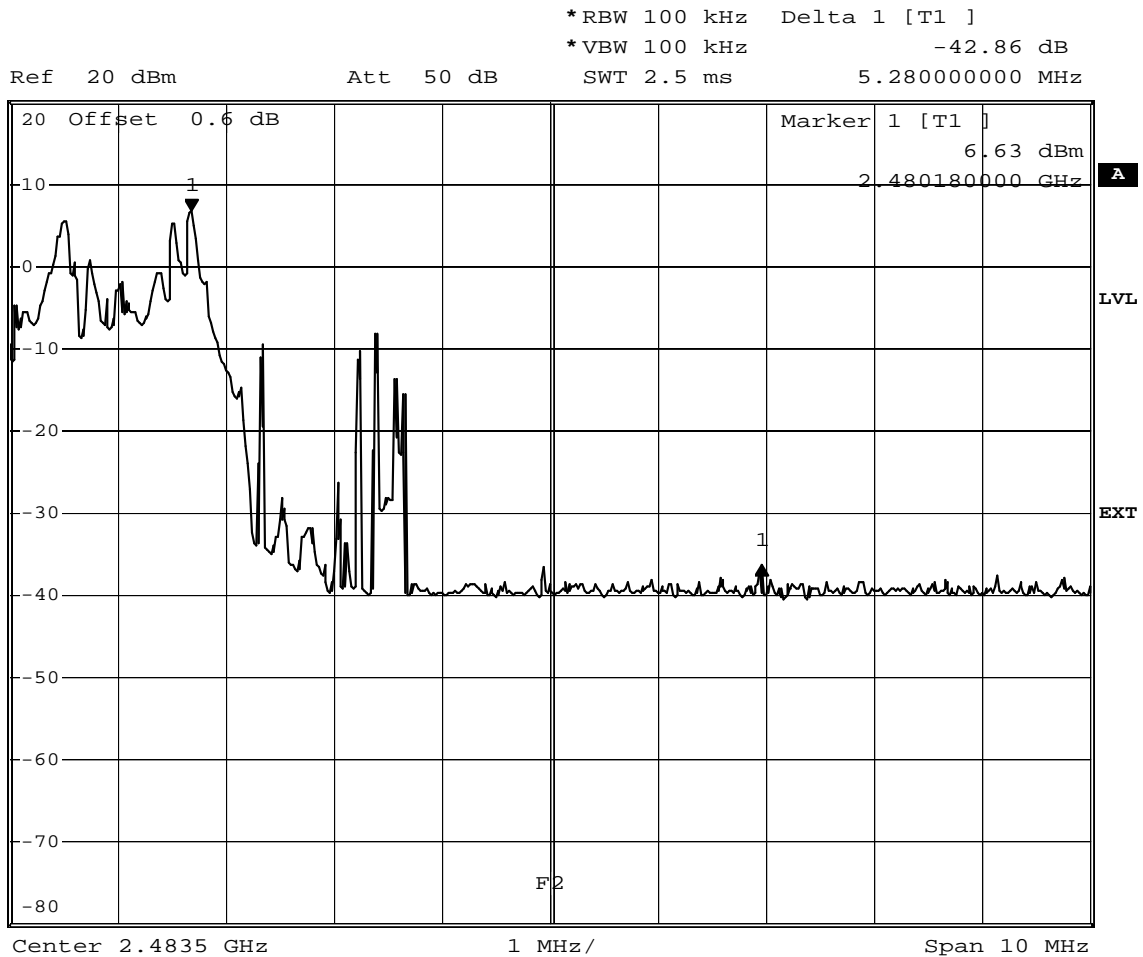

Comment: Limit: Marker Delta value >20 dB; Result: PASS
 Date: 13.JUL.2010 09:21:26

FCC part 15.247
Band-edge compliance of RF conducted emissions

EUT	RF module with BT and WLAN
Model	WiBear-SF1
Approval Holder	lesswire AG
Temperature / Voltage	23°C / Vnom
Test Site / Operator	Eurofins Product Service GmbH / Mr. Treffke
Test Specification	FCC part 15 section 247(c)
Comment 1	Band-edge compliance
Comment 2	Channel.: 0 / 2402 MHz / $\pi/4$ -DQPSK
Comment 3	Hopping mode

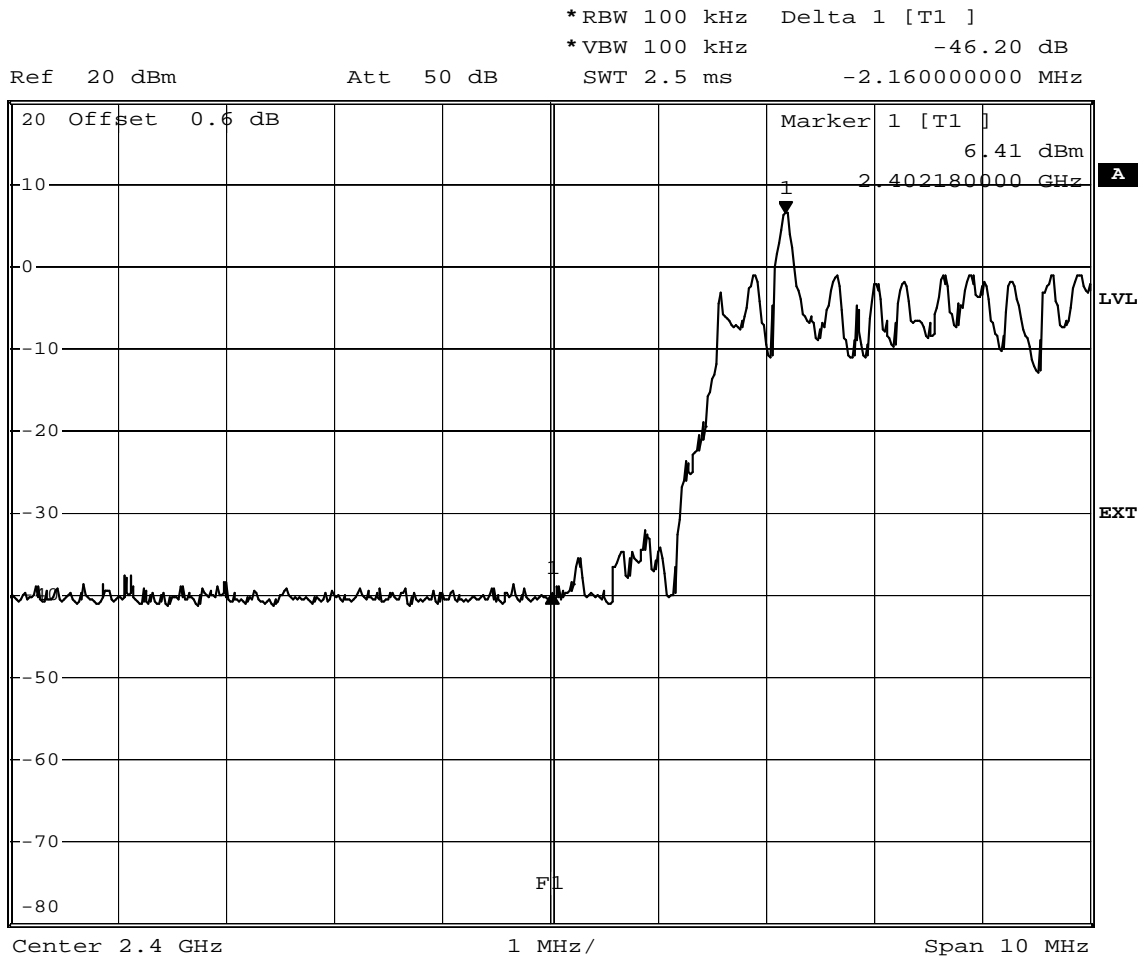

Comment: Limit: Marker Delta value >20 dB; Result: PASS
 Date: 13.JUL.2010 09:31:10

FCC part 15.247
Band-edge compliance of RF conducted emissions

EUT	RF module with BT and WLAN
Model	WiBear-SF1
Approval Holder	lesswire AG
Temperature / Voltage	23°C / Vnom
Test Site / Operator	Eurofins Product Service GmbH / Mr. Treffke
Test Specification	FCC part 15 section 247(c)
Comment 1	Band-edge compliance
Comment 2	Channel.: 78 / 2480 MHz /
Comment 3	Hopping mode

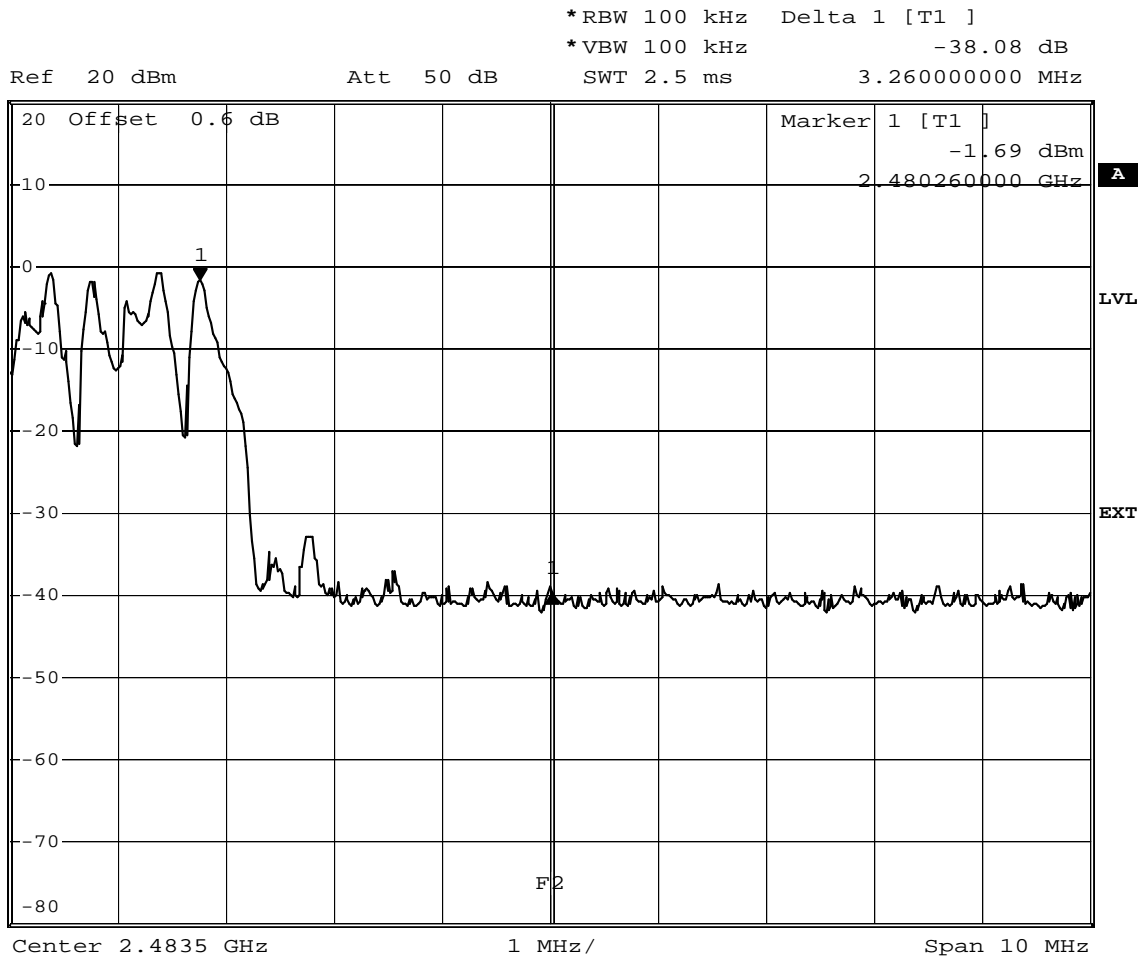

Comment: Limit: Marker Delta value >20 dB; Result: PASS
 Date: 13.JUL.2010 09:33:39

FCC part 15.247
Band-edge compliance of RF conducted emissions

EUT	RF module with BT and WLAN
Model	WiBear-SF1
Approval Holder	lesswire AG
Temperature / Voltage	23°C / Vnom
Test Site / Operator	Eurofins Product Service GmbH / Mr. Treffke
Test Specification	FCC part 15 section 247(c)
Comment 1	Band-edge compliance
Comment 2	Channel.: 0 / 2402 MHz / 8DPSK
Comment 3	Hopping mode

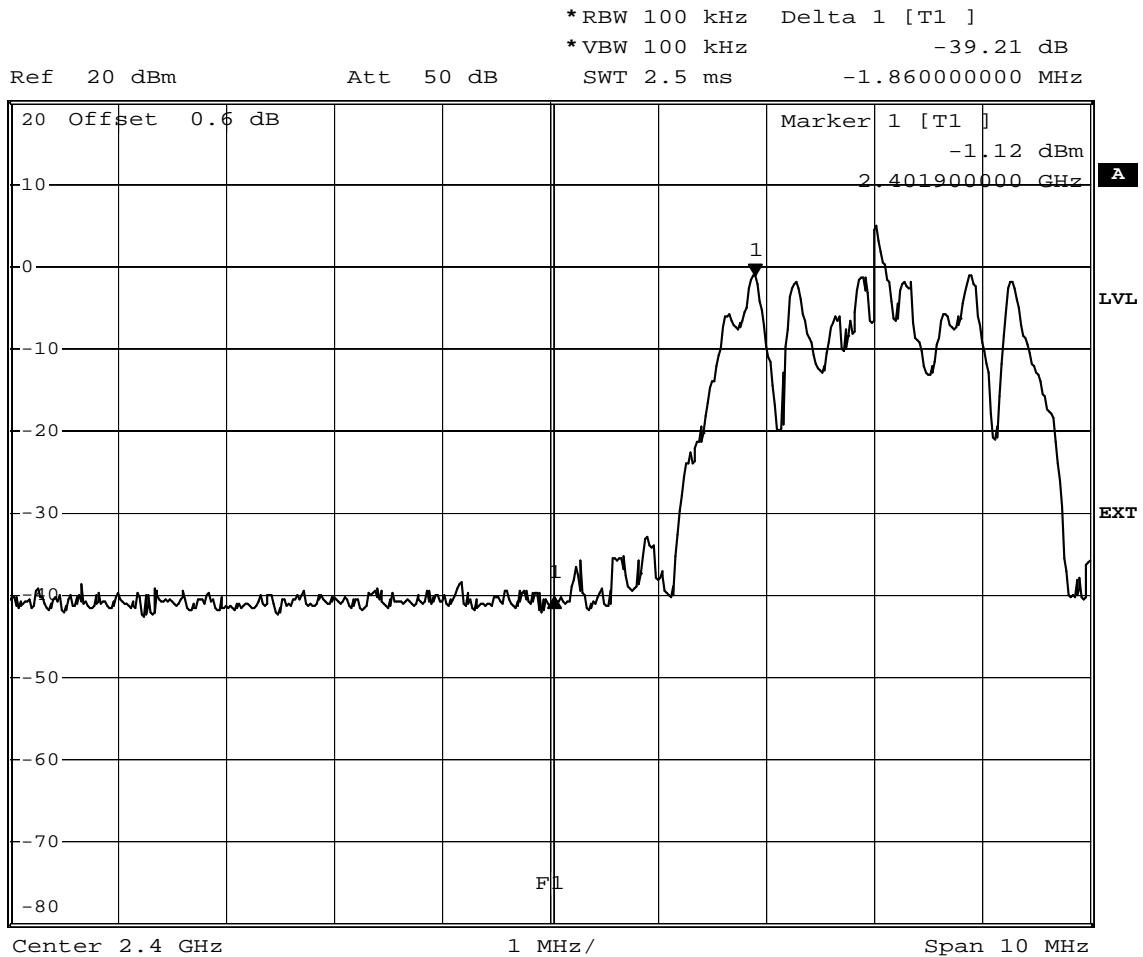

Comment: Limit: Marker Delta value >20 dB; Result: PASS
 Date: 13.JUL.2010 09:37:53

FCC part 15.247
Band-edge compliance of RF conducted emissions

EUT	RF module with BT and WLAN
Model	WiBear-SF1
Approval Holder	lesswire AG
Temperature / Voltage	23°C / Vnom
Test Site / Operator	Eurofins Product Service GmbH / Mr. Treffke
Test Specification	FCC part 15 section 247(c)
Comment 1	Band-edge compliance
Comment 2	Channel.: 78 / 2480 MHz / 8DPSK
Comment 3	Hopping mode

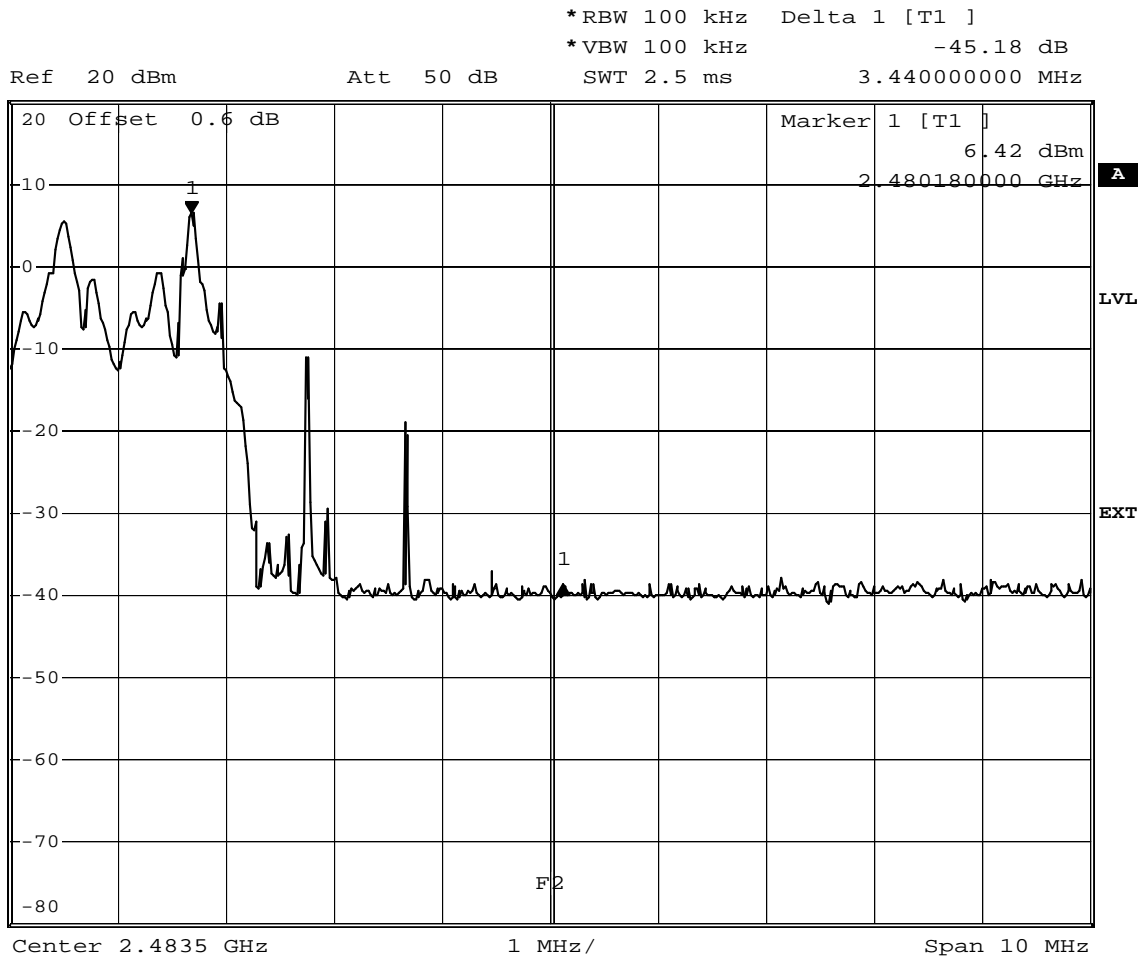

Comment: Spectrum_Analyzer_FSP
 Date: 13.JUL.2010 09:40:26