

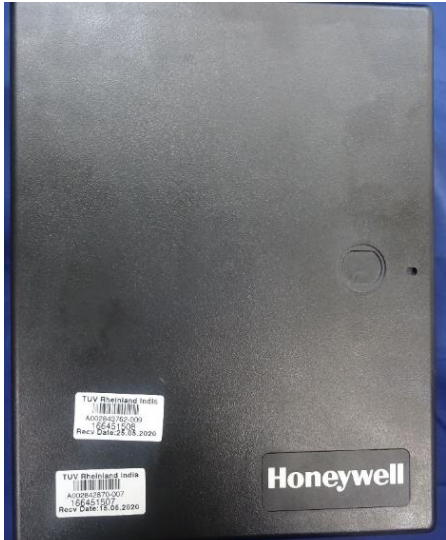

Prüfbericht-Nr.: <i>Test report no.:</i>	ULR-TC568820300000026F	Auftrags-Nr.: <i>Order no.:</i>	166451508 0030	Seite 1 von 37 Page 1 of 37
Kunden-Referenz-Nr.: <i>Client reference no.:</i>	NA	Auftragsdatum: <i>Order date:</i>	2019-05-14	
Auftraggeber: <i>Client:</i>	Honeywell International Inc 12, Clintonville Rd, Northford, CT, USA 06472; +1 203 4847161			
Prüfgegenstand: <i>Test item:</i>	CLSS Gateway			
Bezeichnung / Serien-Nr.: <i>Identification / Serial no.:</i>	HON-CGW-MBB			
Auftrags-Inhalt: <i>Order content:</i>	Testing and Issue of FCC and IC certification			
Prüfgrundlage: <i>Test specification:</i>	FCC Part 15 Subpart E 15.407,15.207 RSS 247 Issue 2 and RSS GEN Issue 5			
Wareneingangsdatum: <i>Date of sample receipt:</i>	2020-05-15			
Prüfmuster-Nr.: <i>Test sample no.:</i>	A002843762-001 A002843762-003			
Prüfzeitraum: <i>Testing period:</i>	2020-05-15 - 2020-06-19			
Ort der Prüfung: <i>Place of testing:</i>	Wireless laboratory, Bangalore			
Prüflaboratorium: <i>Testing laboratory:</i>	TÜV Rheinland (India) Pvt. Ltd. 27/B,2 nd Cross, Electronic City Phase I, Bangalore – 560100, India			
Prüfergebnis*: <i>Test result*:</i>	Pass			
geprüft von: <i>tested by:</i>	genehmigt von: <i>authorized by:</i>			
Datum: <i>Date:</i> 2020-05-21		Ausstellatum: <i>Issue date:</i> 2020-08-28		
Stellung / Position:	Raviraj Kamati Engineer	Stellung / Position:	Mahammadgouse Kaladagi Assistant Manager	
Sonstiges / Other:	FCC ID: PV3CGWMB IC:1609A-CGWMB Contains FCC IDs: R17LE910NAV2, R17LE910SVV2 Contains IC:5131A-LE910NAV2; 5131A-LE910SVV2			
Zustand des Prüfgegenstandes bei Anlieferung: <i>Condition of the test item at delivery:</i>	Prüfmuster vollständig und unbeschädigt <i>Test item complete and undamaged</i>			
* Legende:	1 = sehr gut P(ass) = entspricht o.g. Prüfgrundlage(n)	2 = gut F(ail) = entspricht nicht o.g. Prüfgrundlage(n)	3 = befriedigend N/A = nicht anwendbar	4 = ausreichend N/T = nicht getestet
* Legend:	1 = very good P(ass) = passed a.m. test specification(s)	2 = good F(ail) = failed a.m. test specification(s)	3 = satisfactory N/A = not applicable	4 = sufficient N/T = not tested
<p>Dieser Prüfbericht bezieht sich nur auf das o.g. Prüfmuster und darf ohne Genehmigung der Prüfstelle nicht auszugsweise vervielfältigt werden. Dieser Bericht berechtigt nicht zur Verwendung eines Prüfzeichens. <i>This test report only relates to the a. m. test sample. Without permission of the test center this test report is not permitted to be duplicated in extracts. This test report does not entitle to carry any test mark.</i></p>				

v05

TEST SUMMARY

Test Item	Applicable Standard		Result
	FCC	ISED	
Maximum conducted output power	15.407 (a)	RSS 247 Issue 2 Section 6.2.1.1 & Section 6.2.4.1	Pass
Emission Bandwidth	15.407 (a)	RSS 247 Issue 2 Section 6.2.1.1	NT
Maximum Power spectral density	15.407 (a)	RSS 247 Issue 2 Section 6.2.1.1	NT
Dynamic Frequency Selection	15.407(h)	RSS 247 Issue 2 Section 6.3	NT
Spurious Radiated Emissions & Restricted Bands of Operation	15.407 (b) / (15.205 & 15.209)	RSS 247 Issue 2 Section 6.2.1.2 & 6.2.4.2 RSS Gen Issue 5 Section 8.9 & 8.10	Pass
Conducted AC Power Lines	15.207	RSS Gen Issue 5 Section 8.8	Pass

Note: N/T: Not Tested

CLSS Gateway product was certified with FCC ID: PV3CGWMB , IC:1609A-CGWMB, hence other test cases are excluded which can be found in the test report ULR-TC568819300000100F and ULR-TC568819300000087F issued to Honeywell by TUV Rheinland India.

Product Category: Electronics Testing
Test Discipline: EMC Test Facility

REVISION HISTORY OF THIS REPORT

Report Number	Version	Description	Issue date
ULR-TC568820300000026F	01	Initial issue of report	01.07.2020
ULR-TC568820300000026F	02	Correction in the module identification from CGW-MB to HON-CGW-MBB Note: the Model HON-CGW-MBB covers the addition of Cellular module, hence the changes done to CLSS gateway under C2PC approach shall be only applicable to this model	10.08.2020
ULR-TC568820300000026F	03	Change in HVIN from CCM-BM28 RevA to HON-CGW-MBB	28.08.2020

Table of Contents

1	GENERAL REMARKS	5
1.1	Attachments	5
2	TEST SITES	6
2.1	Testing Facilities.....	6
2.2	List of Test and Measurement Instruments.....	6
3	GENERAL PRODUCT INFORMATION.....	8
3.1	Product Function and Intended Use.....	8
3.2	Ratings and System Details of Equipment under Test	8
3.3	Simultaneous operation	9
3.4	Measurement Uncertainty:	9
4	TEST SET-UP AND OPERATION MODE	10
4.1	Principle of Configuration Selection	10
4.2	Operation and Software of the EUT	10
4.3	Test modes – data rates and modulations.....	10
4.4	Special Accessories and Auxiliary Equipment	10
4.5	Countermeasures to achieve EMC Compliance	10
4.6	Report references.....	10
4.7	List of frequencies	11
5	Operational Description of the product	12
6	Block Diagram of the product	12
7	TEST METHODOLOGY	13
7.1	Conducted Spurious Emission AC Power line Test.....	13
7.1.1	Test Setup Configuration	13
7.2	Radiated Emission Test	14
7.2.1	Test Setup Configuration	14
8	TEST RESULTS	16
8.1	Maximum Conducted Output Power	16
8.2	Spurious Radiated Emissions & Restricted Bands of Operation	18
9	Conducted Spurious Emission test on AC Power Line.....	32
10	LIST OF TABLES.....	37

1 GENERAL REMARKS

1.1 Attachments

All attachments are part of this test report and are issued in separate document

- 1: TEST SETUP PHOTOS
- 2: EUT EXTERNAL PHOTOS
- 3: EUT INTERNAL PHOTOS
- 4: FCC LABEL AND LABEL LOCATION
- 5: BLOCK DIAGRAM
- 6: SPECIFICATION OF EUT
- 7: SCHEMATIC DIAGRAM
- 8: BILL OF MATERIAL
- 9: USER MANUAL
- 10: MAXIMUM PERMISSIBLE EXPOSURE INFORMATION

2 TEST SITES

2.1 Testing Facilities

1. TÜV Rheinland (India) Private Limited.
27/B, 2nd Cross,
Electronic City Phase1
Bangalore – 560 100,
India
2. TUV Rheinland (India) Private Limited.
108 , Beside ISBR Business School,
Electronic City Phase1
Bangalore - 560 100.
India

2.2 List of Test and Measurement Instruments

Table 1: List of test and measurement instruments

Equipment	Manufacturer	Model Name	Serial Number	Firmware Versions	Calibration Due Date	Periodicity	Test Facility
EMI Receiver	Rohde & Schwarz	ESU 40	100288	4.43 SP3	11.10.2020	Yearly	Radiated Spurious Emission
Active loop antenna	Frankonia	LAX-10	LAX-10-800	-	15.07.2020	Yearly	
Biconical Antenna	Schwarzbeck	VHBB9124+BBA9106	9124-1208+9106-0525	-	16.01.2021	Yearly	
Log - Periodical Antenna	Schwarzbeck	VUSLP9118 A	VULP9118A-0733	-	17.01.2021	Yearly	
Horn Antenna	Schwarzbeck	BBHA9120 D	9120D-1944	-	17.07.2020	Yearly	
Horn Antenna	Schwarzbeck	BBHA9170	BBHA9170-0904	-	29.01.2021	Yearly	
Semi Anechoic Chamber	Frankonia	-	-	-	-	-	
Fully Anechoic Chamber	Albatross	-	-	-	-	-	
USB Wideband Power Sensor	Boonton	55006	10231	-	07.09.2020	Yearly	Antenna - Port Measurements
Spectrum Analyser	Agilent Technologies	E4407B	US41192772	A.14.06	28.09.2020	Yearly	
EMI Receiver	Rohde & Schwarz	ESW 44	101732	-	10.12.2020	Yearly	AC Power line conducted emission
LISN	Rohde & Schwarz	ENV216	100022	-	05.09.2020	Yearly	
Pulse Limiter	Rohde & Schwarz	ESH3-Z2	100811	-	01.08.2020	Yearly	

Prüfbericht - Nr.:
Test Report No.:

ULR-TC56882030000026F

Seite 7 von 37
Page 7 of 37

Table 2: Instrument application Software versions

SL. No.	Test Type	Application software	Version
1	Radiated spurious emission measurement in SAC	EMC 32	10.60.00
2	Radiated spurious emission measurement in FAC	EMC 32	10.60.00

3 GENERAL PRODUCT INFORMATION

3.1 Product Function and Intended Use

The gateway acts as a portal among fire alarm panels, and peripheral devices. The gateway connection with the fire alarm panel enables reading the inventory and transmitting the data. The connection with Cloud facilities remotely monitoring and managing the fire detection systems.

3.2 Ratings and System Details of Equipment under Test

Table 3: Ratings and System Details as declared by the Client*

Radio Protocol	WI-FI
Operating Frequency Range	5180MHz to 5240MHz 5260MHz to 5340MHz 5500MHz to 5700MHz
No. of Channels	4 (Refer Table 6)
Channel Spacing	10MHz
Modulation	802.11a: OFDM 802.11n: OFDM
Number of antennas	2
Antenna Gain	6.5 dBi
Antenna Type	Printed F Antenna
Supply Voltage to Product	24V DC (powered through USB Port / NUP(RS232) Port)
Environmental Conditions	Storage
	Operating
-10°C to +60° C	
EUT Dimension (L x W x H)	200mm x 70mm x 255mm

Cellular Module	AT & T	Verizon
FCC ID	RI7LE910NAV2	RI7LE910SVV2
IC ID	5131A-LE910NAV2	5131A-LE910SVV2
HVIN	LE910-NA V2	LE910-SV1
PMN	LE910-NA V2	LE910-SV1

Supply Voltage to Product : CLSS gateway can be powered with the following ports

Port	Powered through
USB Port	Fire alarm control panel
NUP (RS232) Port	Fire alarm control panel

***Disclaimer:** The information/data is supplied by the client and the same is considered to arrive at the final value. Any changes made apart from the specified specification, can directly impact on the tests results.

Note: Product CLSS Gateway has multiple protocols. All the supported wireless protocols and their respective test results are issued in separate test reports, refer clause 4.6 for report reference.

3.3 Simultaneous operation

Mode 1 Combinations of Simultaneous Operations	WiFi - LTE (AT&T) WiFi – WCDMA (AT&T)
Mode 2 Combinations of Simultaneous Operations	Wi-Fi – LTE (Verizon)

Cellular Module	AT & T	Verizon
FCC ID	R17LE910NAV2	R17LE910SVV2
IC ID	5131A-LE910NAV2	5131A-LE910SVV2
HVIN	LE910-NA V2	LE910-SV1
PMN	LE910-NA V2	LE910-SV1

Note: Simultaneous Operation was performed with the above mentioned combination and worst case test results are mentionrd in this report.

3.4 Measurement Uncertainty:

Reported uncertainties represent expanded uncertainties expressed at approximately the 95% confidence level using a coverage factor of $k = 2$

Table 4: Measurement Uncertainty

Parameter	Uncertainty
RF output power, conducted	±0.51 dB
Power Spectral Density, conducted	±0.85 dB
Unwanted Emissions, conducted	±2.58 dB
SAC, radiated measurement	±3.67 dB
FAC, radiated measurement	±4.95 dB
Temperature	±3 °C
Supply Voltages	±3 %
Time	±5 %

Note: The listed uncertainties are the worst case uncertainty for the entire range of measurements and are for the reporting purpose only and are not used in determining the PASS/FAIL of the results.

4 TEST SET-UP AND OPERATION MODE

4.1 Principle of Configuration Selection

Transmission was enabled with highest possible duty cycle on Low, Mid and High channels.

4.2 Operation and Software of the EUT

Software Name: FW 2.5
Software Version: 3.0.1.16
Hardware Name: CLSS Gateway
Hardware version: HON-CGW-MBB
Hardware Reference: CCM-BM28 RevA

4.3 Test modes – data rates and modulations

Conducted and Radiated spurious emissions tests were performed and reported only for EUT worst case operating modes

4.4 Special Accessories and Auxiliary Equipment

- Test laptop and USB cable
- Fire Alarm control panel (to power up CLSS gateway through USB or NUP(RS232) Port)

4.5 Countermeasures to achieve EMC Compliance

- None

4.6 Report references

Note: Product CLSS Gateway has multiple protocols. All the supported wireless protocols and their respective test results are issued in separate test reports.

SL. No.	RF Protocol / Frequency Bands	Report No.
1	LTE, WCDMA	ULR-TC568820300000023F
2	WLAN 2.4GHz & BLE	ULR-TC568820300000024F
3	BT	ULR-TC568820300000025F
4	WLAN 5GHz	ULR-TC568820300000026F

Table 5: TUV Sample identification details

Samples used for Testing	S/N Number
Antenna port measurement	A002842870-001
Radiated mode test	A002842870-009

4.7 List of frequencies

Frequency Band	Channel No.	Frequency (MHz)
5160–5340 MHz	36	5180
	48	5240
	64	5320
5500-5700 MHz	100	5500
	140	5700

Table 6: List of Wi-Fi 5GHz center Frequencies

5 Operational Description of the product

The gateway acts as a portal among fire alarm panels, and peripheral devices. The gateway connection with the fire alarm panel enables reading the inventory and transmitting the data. The connection with Cloud facilities remotely monitoring and managing the fire detection systems.

6 Block Diagram of the product

The Gateway Board's Layout

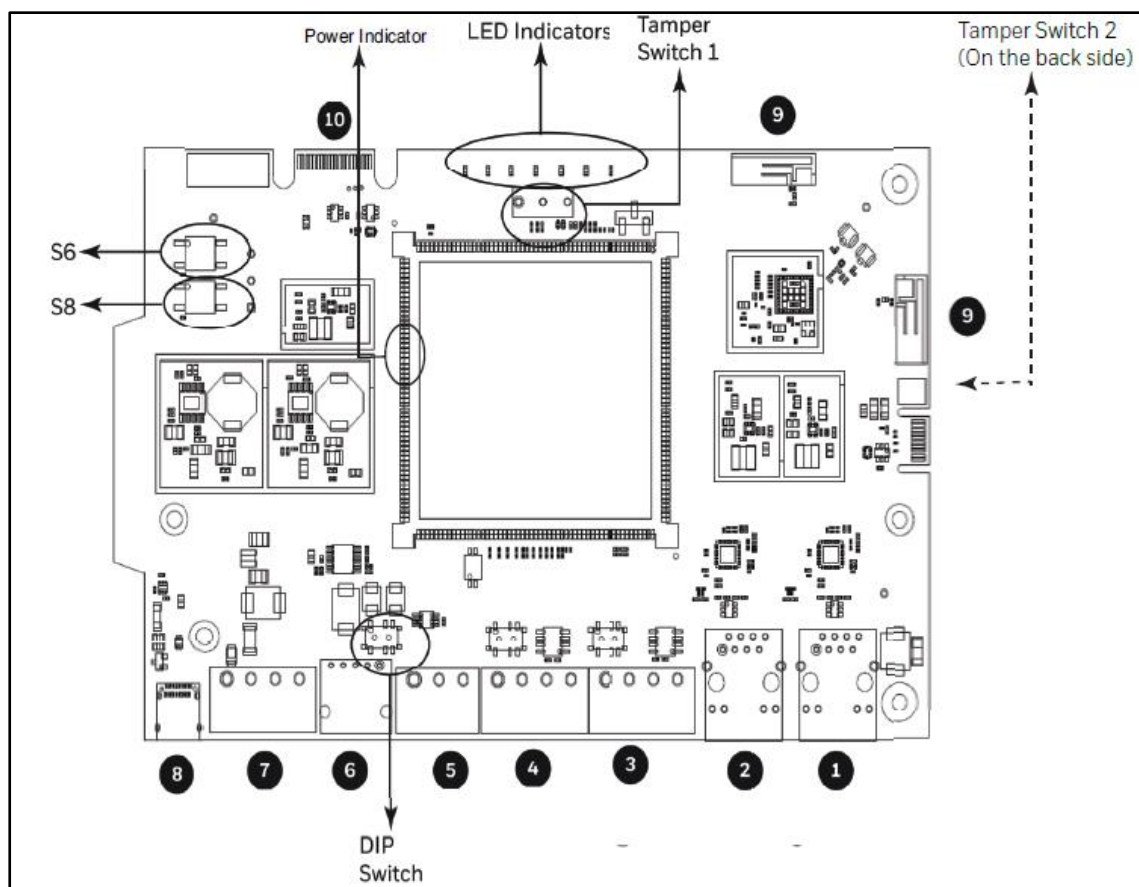

PCB Layout

7.2 Radiated Emission Test

The radiated emission measurement was performed according to the procedures in ANSI C63.10-2013. The equipment under test (EUT) was placed at the middle of the 80 cm high turntable for below 1 GHz & 1.5 m height for above 1 GHz measurement, and the EUT is 3 meters far from the measuring antenna. The turntable was rotated 360° for obtaining the maximum emission. The height of the measuring antennas was scanned between 1 m and 4 m, and the antenna rotated to repeat the measurements for both the horizontal and vertical antenna polarizations. Repeat the measurement steps until the maximum emissions were obtained. The measurement above 1000 MHz was performed by horn antenna, The measurement below 30 MHz was performed by loop antenna, Measurement from 30 MHz to 200 MHz was performed by Baloon and Biconical Antenna, and mesurement from 200 MHz to 1 GHz was performed by Log-Periodic Antenna.

The EUT was rotated around the X-, Y-, and Z-Axis and the results from worst case axis are recorded.
Field Strength (dB μ V/m) = Measured Value(dB μ V) + Antenna Factor(dB) + Cable Loss(dB) – Pre Amplifier Gain (dB)

7.2.1 Test Setup Configuration

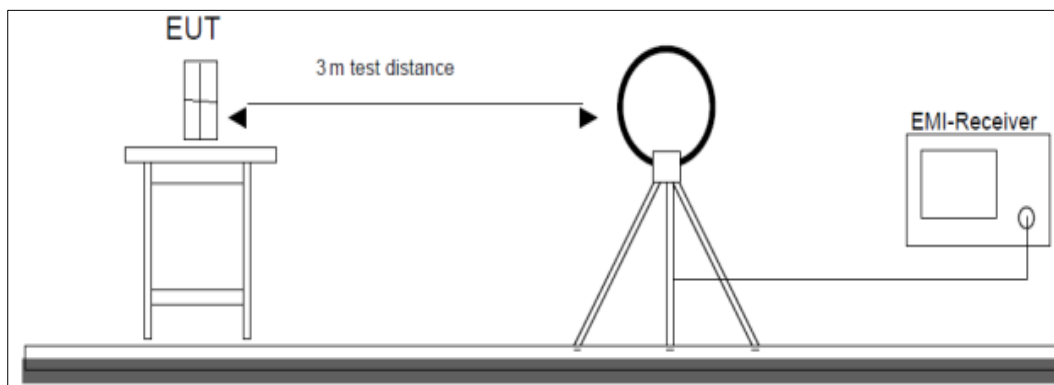

Figure 1: Frequency Range 9 kHz- 30 MHz

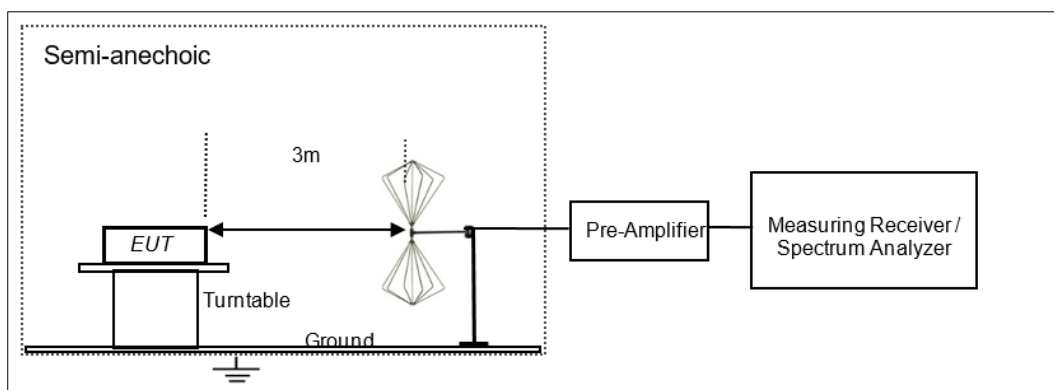

Figure 2: Frequency Range 30 MHz – 200 MHz

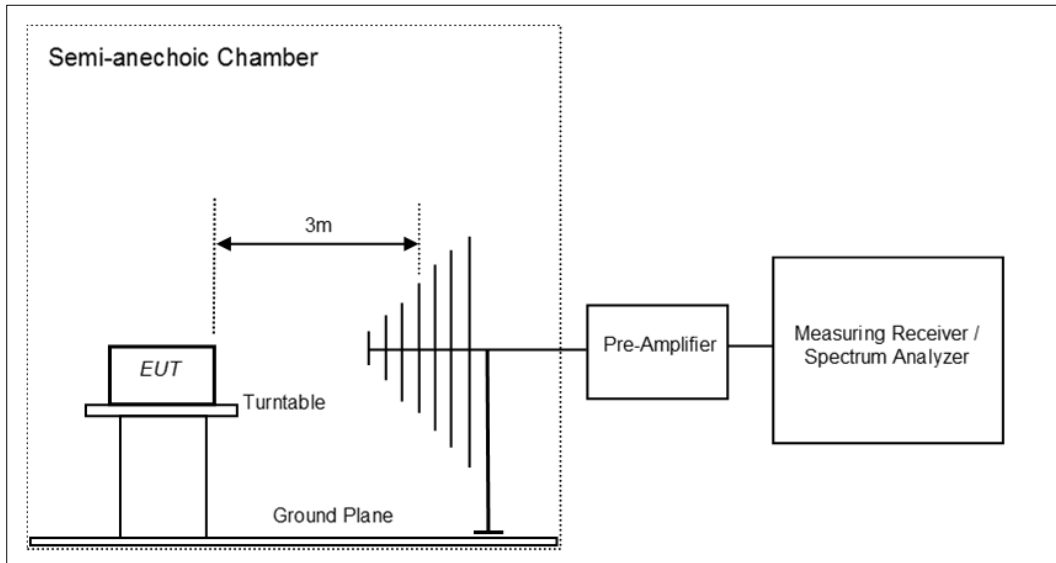

Figure 3: Frequency Range 200 MHz - 1GHz

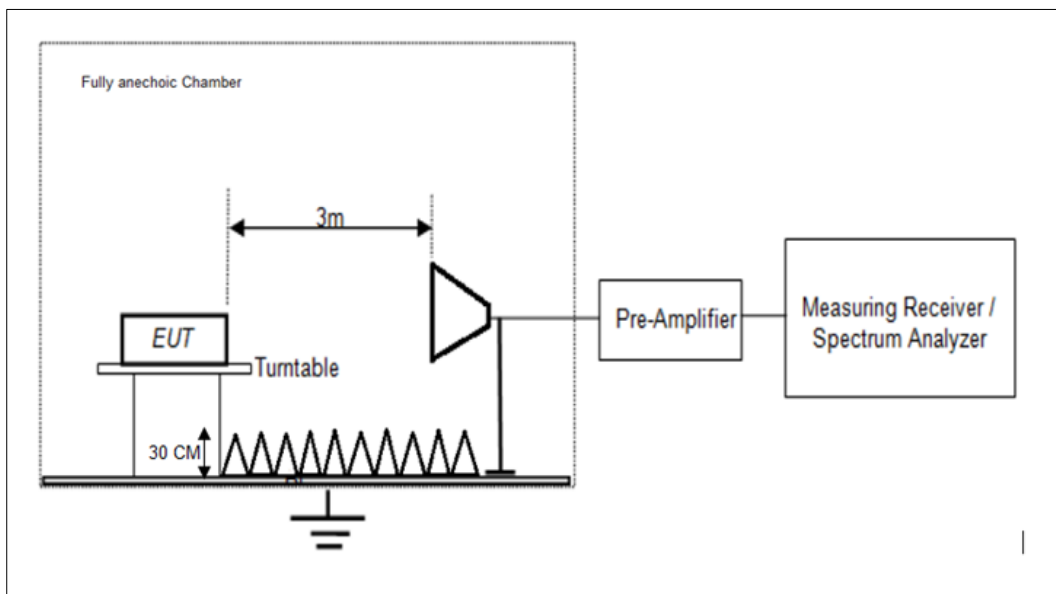

Figure 4: Frequency Range above 1 GHz

8 TEST RESULTS

8.1 Maximum Conducted Output Power

Result

Pass

Test Specification	FCC part 15 Subpart E 15.407 (a) / RSS 247 Issue 2, Section 6.2.1.1 & Section 6.2.4.1
Test Method	Subclause 12.3.2.4 of ANSI C63.10
Detector	Average sample detector
Port of testing	Antenna port
Requirement for FCC	For devices in the 5.15-5.25 GHz band, the maximum conducted output power over the frequency band of operation shall not exceed 250 mW provided the maximum antenna gain does not exceed 6 dBi & for the 5.25-5.35 GHz and 5.47-5.725 GHz bands, the maximum conducted output power over the frequency bands of operation shall not exceed the lesser of 250 mW or 11 dBm + 10 log B
Requirement for IC	For devices in the 5.15-5.25 GHz band, the maximum e.i.r.p. shall not exceed 200 mW or 10 + 10 log10B, dBm, whichever power is less, for the frequency band 5.25-5.35GHz band, the maximum conducted output power shall not exceed 250 mW or 11 + 10 log10B, dBm, whichever is less, for the frequency band 5.5-5.58GHz and 5.66-5.7GHz, The maximum conducted output power shall not exceed 250 mW or 11 + 10 log10B, dBm, whichever is less.

Test Method

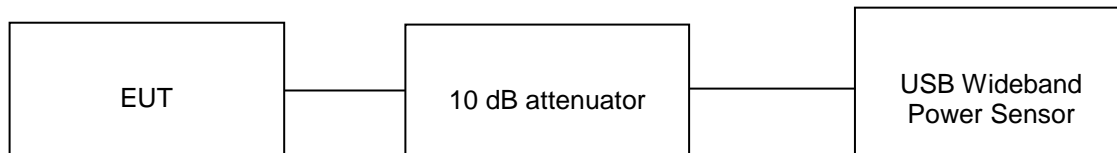

Measurements may be performed using a wideband RF power meter with a thermocouple detector or equivalent if all of the following conditions are satisfied:

1. The EUT is configured to transmit continuously or to transmit with a constant duty cycle.
2. At all times when the EUT is transmitting, it must be transmitting at its maximum power control level.
3. The integration period of the power meter exceeds the repetition period of the transmitted signal by at least a factor of five.
 - (ii) If the transmitter does not transmit continuously, measure the duty cycle, x, of the transmitter output signal as described in II.B.
 - (iii) Measure the average power of the transmitter. This measurement is an average over both the on and off periods of the transmitter.
 - (iv) Adjust the measurement in dBm by adding 10 log (1/x) where x is the duty cycle (e.g., 10 log (1/0.25) if the duty cycle is 25%).

Prüfbericht - Nr.:
Test Report No.:

ULR-TC56882030000026F

Seite 17 von 37
Page 17 of 37

Test Condition:

Normal Test Condition:

Temperature (Norm) = + 22.3 °C Voltage = 24V DC (through UAB Port) Relative humidity = 62 %

KDB Guidelines applied:

Measurements were made as per section 3 sub-section (a) in KDB 789033 D02 General UNII Test Procedures New Rules v02r01

Test results:

Note:

- All the losses are included during measurement and final values are mentioned in the test report
10 dB attenuator + 2.5 dB Cable loss = 12.5 dB total offset
- Duty cycle correction factor is considered in Final Average power
Duty cycle Correction factor = $10 \cdot \text{LOG} (1/X)$ Where X is Duty Cycle
- This product do not support additional beamforming gain / directional gain, it uses signal antenna and hence directional gain of the single antenna is 6.5 dBi
- e.i.r.p = Maximum Average output power (dBm) + Antenna gain in dBi (6.5 dBi)
- The transmitting antenna gain of the EUT is 6.5 dBi, which exceeds 6dBi antenna gain by 0.5 dB. Therefore the conducted output power limit is reduced by 0.5 as mentioned in the below table.

Data rate	Measured Frequency (MHz)	Measured Average Power (dBm)	Duty Cycle X (%)	Duty cycle correction factor (dB)	Maximum Average output power (dBm)	e.i.r.p (dBm)	FCC Power Limit (dBm)	IC Power Limit (dBm)	IC e.i.r.p Limit (dBm)
6Mbps	5180	11.90	95	0.24	12.14	18.64	23.50	/	22.30
	5240	10.77	95	0.24	11.01	17.51	23.50	/	22.30
	5320	13.19	95	0.24	13.43	19.93	23.50	23.30	29.30
	5500	10.12	95	0.24	10.36	16.86	23.50	23.30	29.30
	5700	8.40	95	0.24	8.64	15.14	23.50	23.30	29.30
MCS0	5180	12.16	94	0.28	12.44	18.94	23.50	/	22.60
	5240	11.52	94	0.28	11.80	18.30	23.50	/	22.60
	5320	9.01	94	0.28	9.29	15.79	23.50	23.60	29.60
	5500	9.54	94	0.28	9.82	16.32	23.50	23.60	29.60
	5700	9.11	94	0.28	9.39	15.89	23.50	23.60	29.60

8.2 Spurious Radiated Emissions & Restricted Bands of Operation

Result

Pass

Test Specification	FCC part 15 Subpart C Section 15.407 (b) (15.205 & 15.209) / RSS 247 Issue 2 Section 6.2.1.2 & 6.2.4.2 / RSS Gen Issue 5 Section 8.9 and 8.10
Test Method	ANSI C 63.10 – 2013
Measurement Bandwidth	100kHz for below 1GHz 1MHz for above 1GHz
Measurement Location	Semi Anechoic Chamber 30MHz - 1 GHz Fully Anechoic Chamber 1 GHz - 40GHz
Measuring Distance	3 m
Detector	Refer Remark
Requirement	As per the limits mentioned in the below table
Test setup	Refer TEST METHODOLOGY

Limit:

Table 7: Undesirable emission limits

Frequency Band	Limit
5.15-5.25 GHz	e.i.r.p. -27dBm [68.2 dBuV/3m]
5.25-5.35 GHz	e.i.r.p. -27dBm [68.2 dBuV/3m]
5.47-5.725 GHz	e.i.r.p. -27dBm [68.2 dBuV/3m]
5.725-5.85 GHz	5.715 GHz to 5.725 GHz - e.i.r.p. -17dBm [78.2 dBuV/3m] 5.85 GHz to 5.86 GHz - e.i.r.p. -17dBm [78.2 dBuV/3m] other frequency range - e.i.r.p. -27dBm [68.2 dBuV/3m]

Table 8: Transmitter limits for Radiated emission

Frequency (MHz)	Field strength ($\mu\text{V/m}$)	Field strength ($\text{dB}\mu\text{V/m}$)	Distance of Measurement (m)
0.009 – 0.490	2400/F(kHz)	48.50 – 13.80	300*
0.490 – 1.705	24000/F(kHz)	33.80 – 23.00	30*
1.705 -30	30	29.54	30*
30-88	100	40.0	3
88-216	150	43.5	3
216-960	200	46.0	3
Above 960	500	54.0	3

Remark: * The limit shows in the table above of frequency range 0.009 – 0.490, 0.490 – 1.705 MHz and 1.705-30MHz is at 300 meter, 30 meter and 30 meter range respectively, which corresponds to 128.51 – 93.80, 73.80 – 62.96 and 69.54 $\text{dB}\mu\text{V/m}$ at 3m range by extrapolation calculation and the measurement of loop antenna.

The emission limits shown in the above table are based on measurements employing a CISPR quasi-peak detector except for the frequency bands 9–90 kHz, 110–490 kHz and above 1000 MHz Radiated emission limits in these three bands are based on measurements employing an average detector.

Environmental conditions:

Temperature (Norm) = + 24 °C Voltage = 24 V DC (through USB Port and NUP(RS232) Port)

Relative humidity = 62 %

Note: For the above 1 GHz worst case test results observed in power mode 24 V DC (through USB Port)

Test results:

Note: All the losses are included during measurement and final values are mentioned in the test report. Refer TEST METHODOLOGY for more details

Test Results:

Test results for frequency range 9kHz – 30MHz

No emissions found in frequency range 9 kHz to 30 MHz, and measured levels are below 20dB from the limit line, have not reported

Test results for frequency range 30MHz – 200MHz

Power Mode: 24V DC Through NUP(RS232) Port

Antenna Polarization	Frequency (MHz)	Peak Emission (dBµV/m)	Limit (dBµV/m)	Margin (dB)
Vertical	30.758	25.16	40.00	-14.84
	97.569	25.02	43.50	-18.48
	113.785	28.78	43.50	-14.72
	120.038	24.97	43.50	-18.53
Horizontal	95.913	17.54	43.50	-25.96
	125.008	34.21	43.50	-9.29
	150.002	36.60	43.50	-6.90

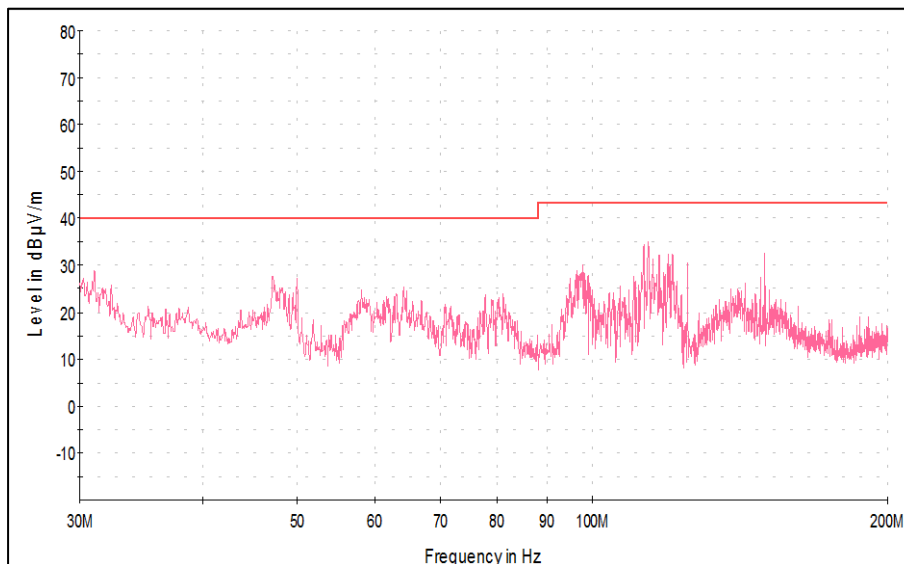

Polarization: Vertical

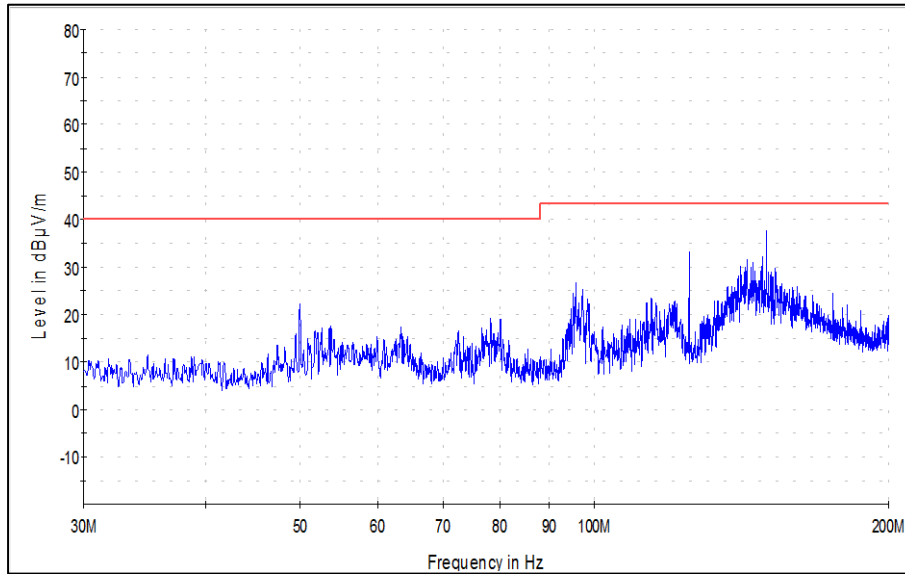

Polarization: Horizontal

Power Mode: 24V DC Through (USB Port)

Antenna Polarization	Frequency (MHz)	Peak Emission (dBµV/m)	Limit (dBµV/m)	Margin (dB)
Vertical	38.69	22.30	40.00	-17.70
	49.99	28.12	40.00	-11.88
	124.98	32.09	43.50	-11.41
	149.98	35.02	43.50	-8.48
Horizontal	50.00	21.85	40.00	-18.15
	125.00	30.86	43.50	-12.64
	149.99	34.41	43.50	-9.09
	155.61	32.12	43.50	-11.38

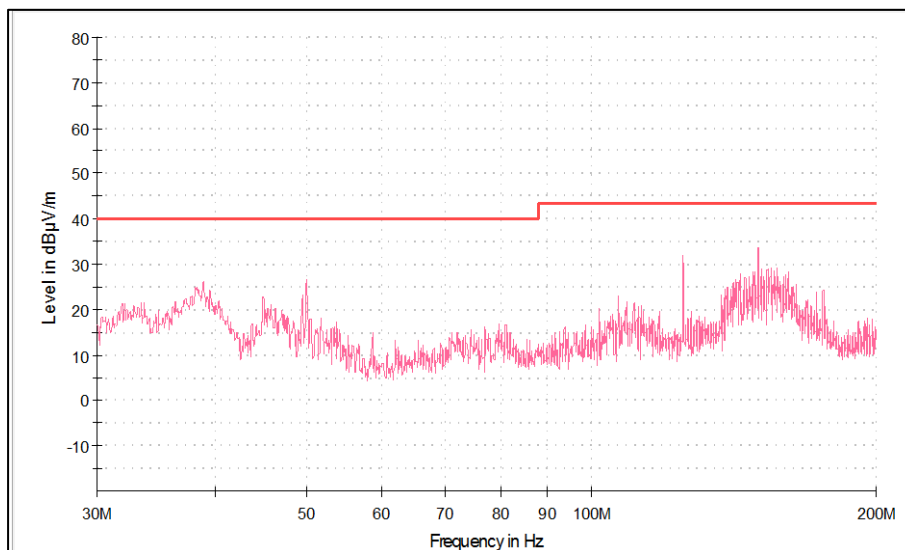

Polarization: Vertical

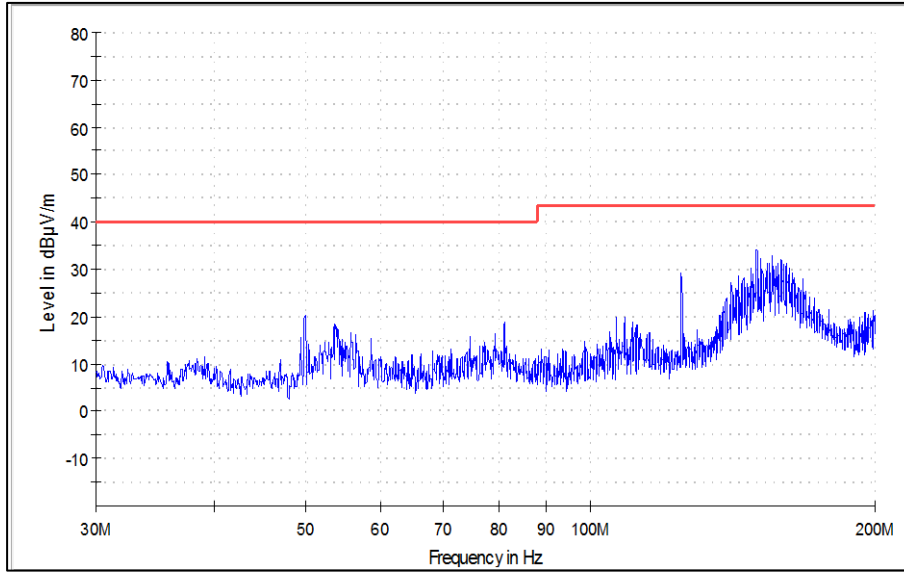

Polarization: Horizontal

Test results for frequency range 200MHz – 1GHz

Power Mode: 24V DC Through NUP(RS232) Port

Antenna Polarization	Frequency (MHz)	Peak Emission (dB μ V/m)	Limit (dB μ V/m)	Margin (dB)
Vertical	346.48	28.11	46.00	-17.89
	544.48	32.95	46.00	-13.05
	841.49	32.57	46.00	-13.43
	940.49	37.21	46.00	-8.79
Horizontal	249.97	34.80	46.00	-11.20
	346.49	28.97	46.00	-17.03
	742.48	30.84	46.00	-15.16
	841.50	32.19	46.00	-13.81

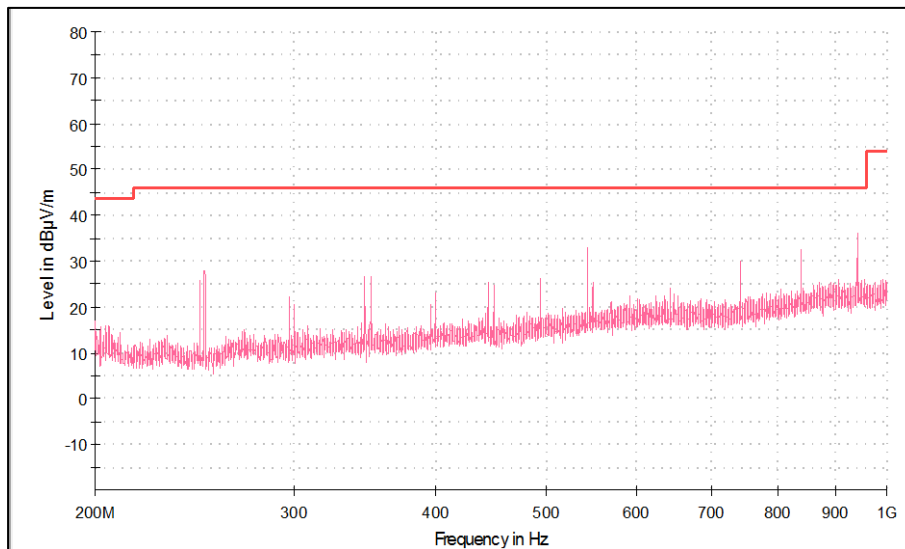

Polarization: Vertical

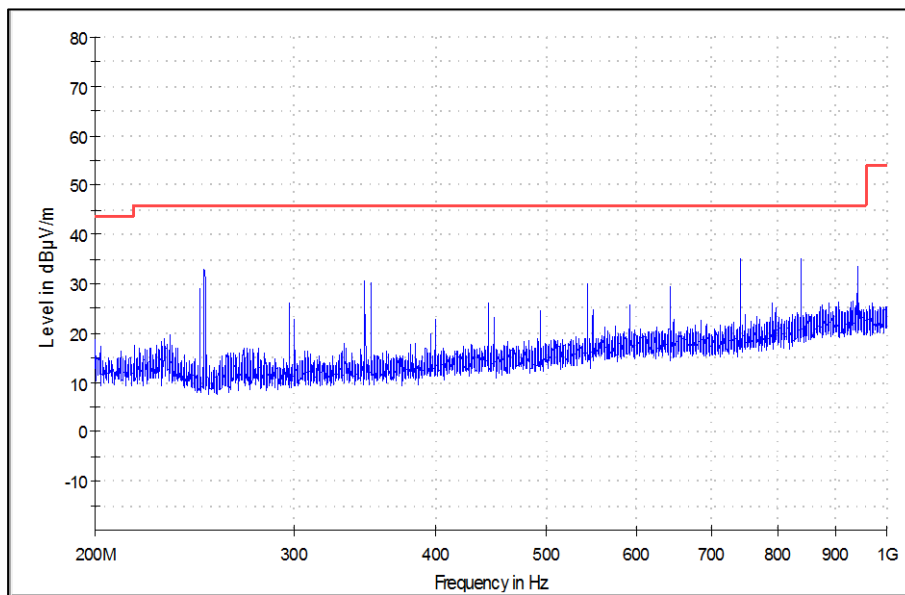

Polarization: Horizontal

Power Mode: 24V DC Through (USB Port)

Antenna Polarization	Frequency (MHz)	Peak Emission (dB μ V/m)	Limit (dB μ V/m)	Margin (dB)
Vertical	346.49	25.12	46.00	-20.88
Vertical	445.50	30.54	46.00	-15.46
Vertical	940.50	32.85	46.00	-13.15
Horizontal	249.96	32.76	46.00	-13.24
Horizontal	544.49	34.07	46.00	-11.93
Horizontal	841.49	31.88	46.00	-14.12

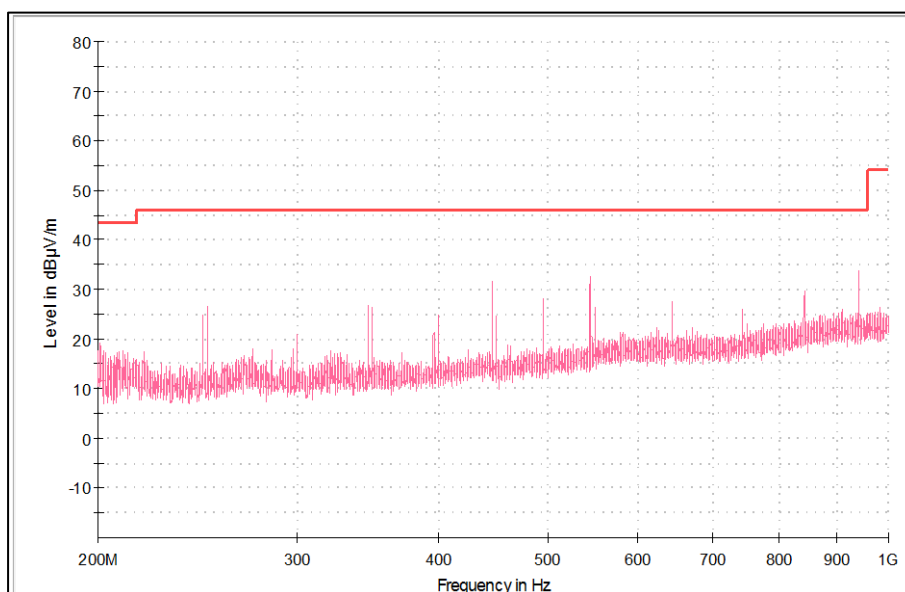

Polarization: Vertical

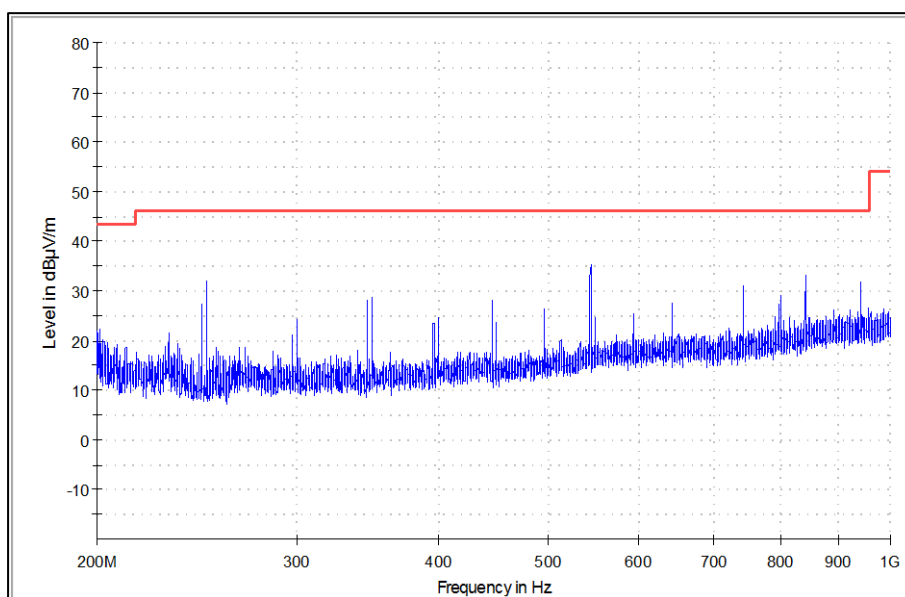

Polarization: Horizontal

Test results for frequency range – 1GHz to 40 GHz

Modulation: 802.11n
Data rate: MCS0

Frequency Band	Channel No. or Frequency (MHz)	Polarization	Measured Frequency (MHz)	Measured Emission Level (dBµV/m)	Limit (dBµV/m)	Margin (dB)
5150-5250 (UNII-1)	36(5180)	Vertical	5150(Pk)	65.97	74.00*	-8.03
			5150(Av)	46.21	54.00*	-7.79
			5180(Pk)	101.88	-	-
			5180(Av)	91.39	-	-
			10360(Pk)	50.21	68.20	-17.99
			10360(Av)	38.07	68.20	-30.13
			15540(Pk)	53.17	68.20	-15.03
		15540(Av)	40.57	68.2	-27.63	
		Horizontal	5150(Pk)	72.33	74.00*	-1.67
			5150(Av)	50.87	54.00*	-3.13
			5180(Pk)	107.24	-	-
			5180(Av)	95.98	-	-
			10360(Pk)	50.23	68.20	-17.97
			10360(Av)	38.09	68.20	-30.11
	15540(Pk)		53.93	68.20	-14.27	
	15540(Av)	41.08	68.20	-27.12		
	48(5240)	Vertical	5240(Pk)	101.75	-	-
			5240(Av)	91.93	-	-
			5350(Pk)	50.15	74.00*	-23.85
			5350(Av)	37.24	54.00*	-16.76
			10480(Pk)	50.11	68.20	-18.09
			10480(Av)	38.54	68.20	-29.66
			15720(Pk)	51.42	68.20	-16.78
		15720(Av)	40.36	68.20	-27.84	
		Horizontal	5240(Pk)	106.02	-	-
			5240(Av)	94.58	-	-
			5350(Pk)	50.21	74.00*	-23.79
			5350(Av)	37.48	54.00*	-16.52
10480(Pk)			51.59	68.20	-16.61	
10480(Av)			38.79	68.20	-29.41	
15720(Pk)	51.77		68.20	-16.43		
15720(Av)	40.34	68.20	-27.86			

Note:
* :- Indicate restricted band frequency in 15.205
Pk: Peak Detector; Av: Average Detector

Frequency Band	Channel No. or Frequency (MHz)	Polarization	Measured Frequency (MHz)	Measured Emission Level (dBµV/m)	Limit (dBµV/m)	Margin (dB)
5250-5350 (UNII-2A)	52(5260)	Vertical	5260(Pk)	103.12	-	-
			5260(Av)	92.04	-	-
			5350(Pk)	50.56	74.00*	-23.44
			5350(Av)	37.47	54.00*	-16.53
			10520(Pk)	48.66	68.20	-19.54
			10520(Av)	36.94	68.20	-31.26
			15780(Pk)	51.73	68.20	-16.47
		15780(Av)	38.38	68.20	-29.82	
		Horizontal	5260(Pk)	106.75	-	-
			5260(Av)	95.99	-	-
			5350(Pk)	49.97	74.00*	-24.03
			5350(Av)	37.97	54.00*	-16.03
			10520(Pk)	49.73	68.20	-18.47
			10520(Av)	36.94	68.20	-31.26
	15780(Pk)		50.93	68.20	-17.27	
	15780(Av)	38.51	68.20	-29.69		
	64(5320)	Vertical	5320(Pk)	102.56	-	-
			5320(Av)	91.75	-	-
			5350(Pk)	60.22	74.00*	-13.78
			5350(Av)	48.07	54.00*	-5.93
			10640(Pk)	51.7	68.20	-16.5
			10640(Av)	39.22	68.20	-28.98
			15960(Pk)	52.72	68.20	-15.48
		15960(Av)	41.03	68.20	-27.17	
		Horizontal	5320(Pk)	106.54	-	-
			5320(Av)	96.93	-	-
			5350(Pk)	65.01	74.00*	-8.99
			5350(Av)	52.833	54.00*	-1.167
10640(Pk)			50.74	68.20	-17.46	
10640(Av)			39.32	68.20	-28.88	
15960(Pk)	52.88		68.20	-15.32		
15960(Av)	41.67	68.20	-26.53			

Note:

* :- Indicate restricted band frequency in 15.205

Pk: Peak Detector; Av: Average Detector

Frequency Band	Channel No. or Frequency (MHz)	Polarization	Measured Frequency (MHz)	Measured Emission Level (dBµV/m)	Limit (dBµV/m)	Margin (dB)
5470-5725 (UNII-2C)	5500	Vertical	5500(Pk)	99.34	-	-
			5500(Av)	89.16	-	-
			11000(Pk)	49.77	68.20	-18.43
			11000(Av)	38.14	68.20	-30.06
			16500(Pk)	53.25	68.20	-14.95
			16500(Av)	41.09	68.20	-27.11
		Horizontal	5500(Pk)	103.78	-	-
			5500(Av)	92.77	-	-
			11000(Pk)	51.04	68.20	-17.16
			11000(Av)	38.23	68.20	-29.97
			16500(Pk)	53.68	68.20	-14.52
			16500(Av)	41.19	68.20	-27.01
	5700	Vertical	5700(Pk)	97.48	-	-
			5700(Av)	87.48	-	-
			11400(Pk)	54.2	68.20	-14
			11400(Av)	41.17	68.20	-27.03
			17100(Pk)	56.03	68.20	-12.17
			17100(Av)	43.77	68.20	-24.43
		Horizontal	5700(Pk)	101.63	-	-
			5700(Av)	91.38	-	-
			11400(Pk)	53.86	68.20	-14.34
			11400(Av)	41.38	68.20	-26.82
			17100(Pk)	56.37	68.20	-11.83
			17100(Av)	44.05	68.20	-24.15

Note:

* :- Indicate restricted band frequency in 15.205

Pk: Peak Detector; Av: Average Detector

Table 9: RSE Test Results of Simultaneous Operation with Cellular and Non-Cellular:

Note: As specified under the section 3.3 simultaneous combinations mode 1 and mode 2 are performed for AT&T and Verizon Cellular modules, respectively. Only worst-case reported.

Worst case result for Wi-Fi and LTE Combination: LTE Band 2 and Wi-Fi 5GHz
Worst case mode : - Mode 2 with Verizon cellular module

Frequency Band	Channel No. or Frequency (MHz)	Polarization	Measured Frequency (MHz)	Measured Emission Level (dBµV/m)	Limit (dBµV/m)	Margin (dB)
5150-5250 (UNII-1)	36(5180)	Vertical	10360(Pk)	50.41	68.20	-23.59
			10360(Av)	38.21	68.20	-15.79
			15540(Pk)	53.13	68.20	-20.87
			15540(Av)	40.98	68.20	-13.02
		Horizontal	10360(Pk)	52.87	68.20	-21.13
			10360(Av)	38.69	68.20	-15.31
			15540(Pk)	52.87	68.20	-21.13
			15540(Av)	38.69	68.20	-15.31

Worst case emissions for restricted band of operation

Modulation: 802.11n
Data rate: MCS0

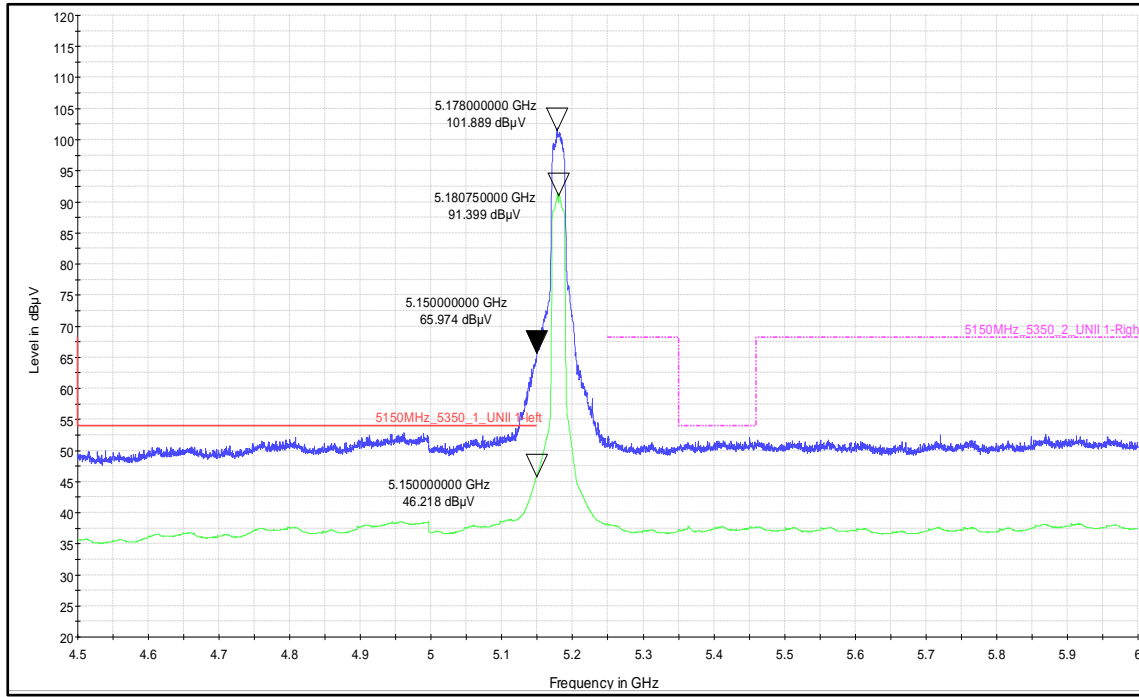

Fundamental Frequency

Polarization: Vertical

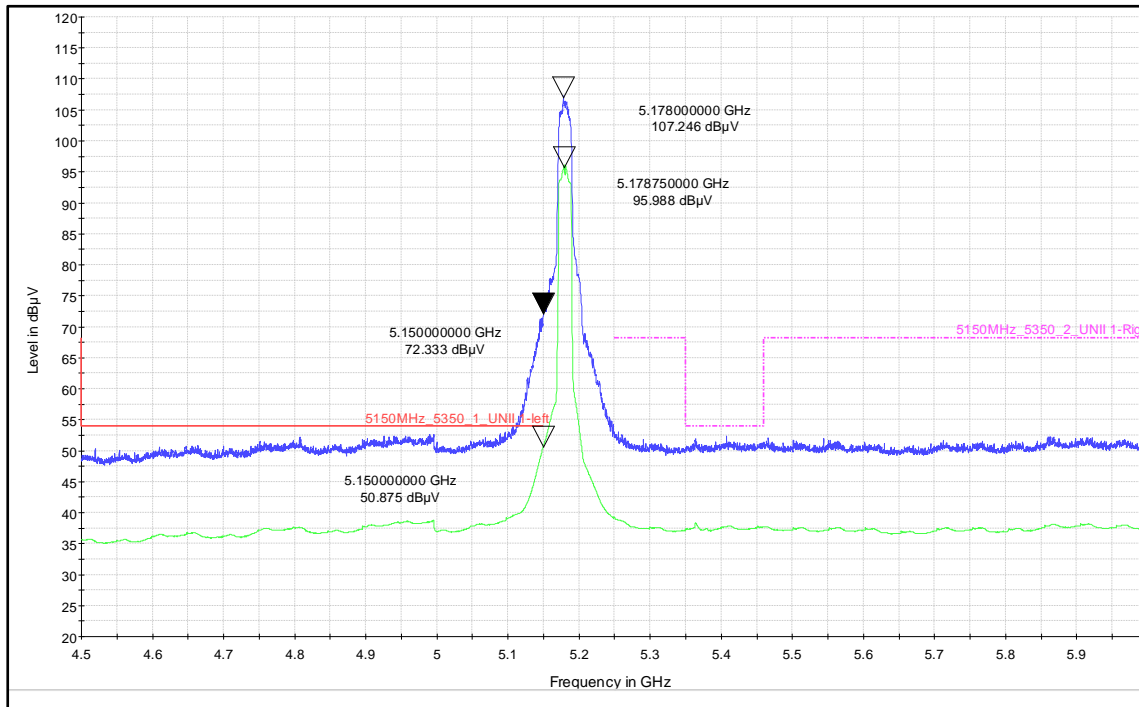

Fundamental Frequency

Polarization: Horizontal

Worst case emissions for Spurious radiated emissions above 1GHz

Data rate: MCS0

Channel Frequency: 5180MHz

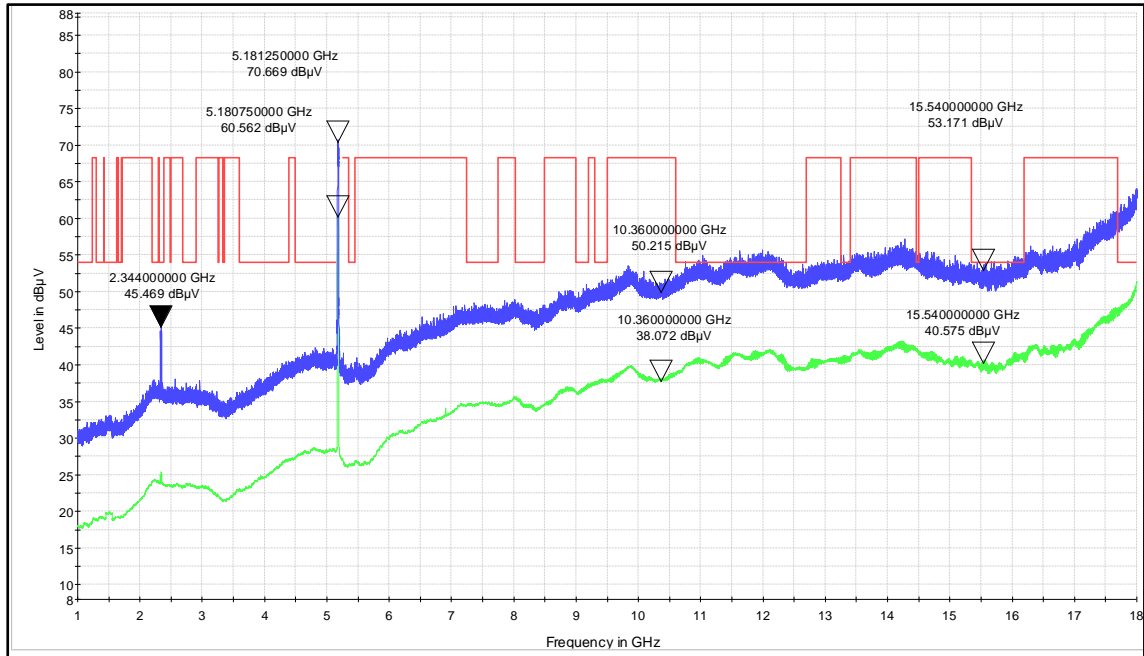

Frequency range: 1GHz to 18GHz

Polarization: Vertical

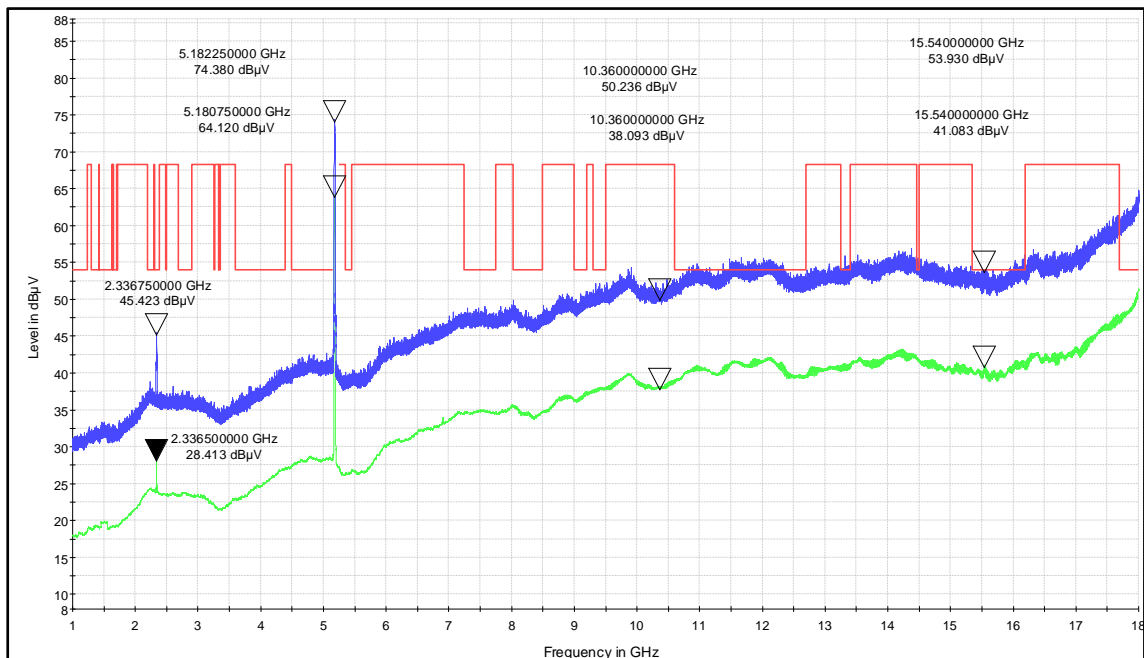

Frequency range: 1GHz to 18GHz

Polarization: Horizontal

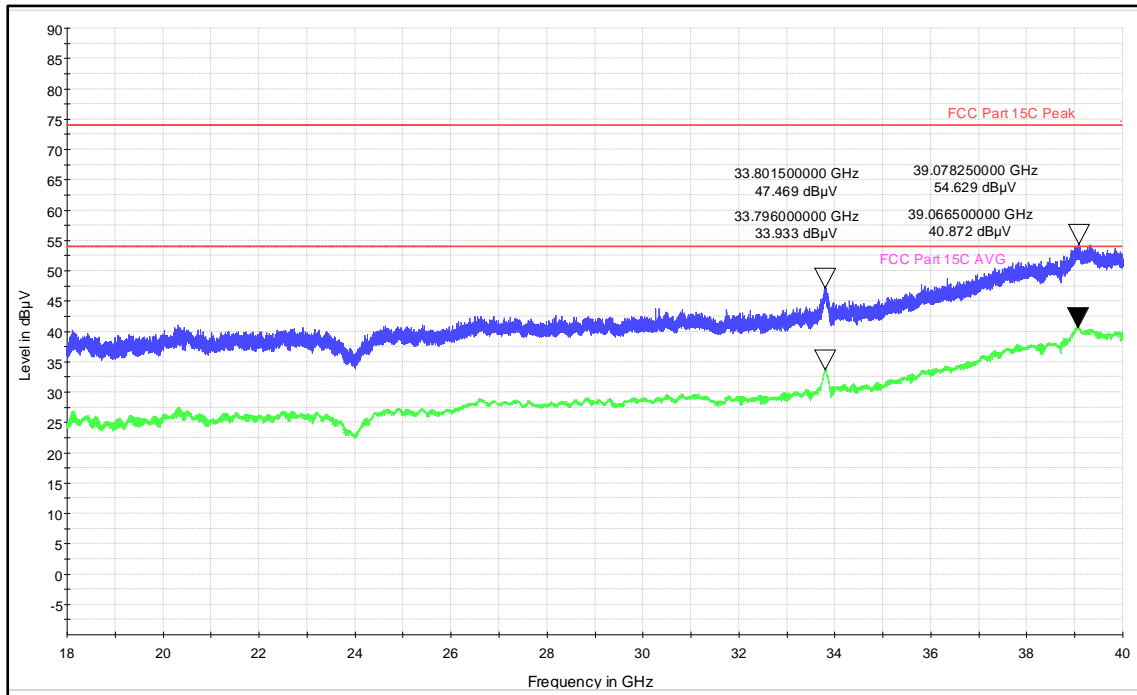

Frequency range:18GHz-40GHz

Polarization: Vertical

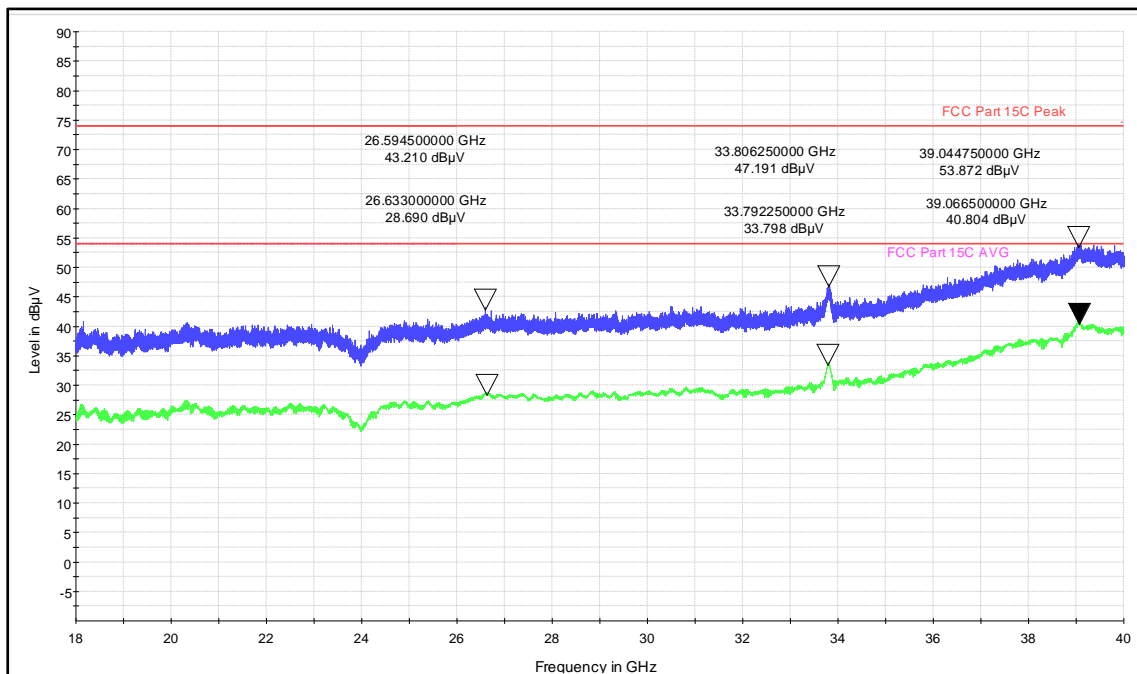

Frequency range:18GHz-40GHz

Polarization: Horizontal

Prüfbericht - Nr.:
Test Report No.:

ULR-TC56882030000026F

Seite 32 von 37
Page 32 of 37

9 Conducted Spurious Emission test on AC Power Line

Result

Pass

Test Specification : FCC Part 15 Section 15.207 / RSS Gen Issue 5 Section 8.8
 Test Method : ANSI C 63.10-2013
 Testing Location : Screened room
 Measurement Bandwidth : 9kHz
 Frequency Range : 150kHz – 30MHz
 Supply Voltage : 110VAC,60Hz
 Test Method : Refer TEST METHODOLOGY

***Note: The product has tested with 24 V DC (through USB Port and NUP(RS232) Port)**

Limits of section 15.207

Frequency of emission (MHz)	QP Limit (dB μ V)	AV Limit (dB μ V/m)
0.15 – 0.5	66 – 56*	56 – 46*
0.5 – 5	56	46
5 – 30	60	50

* Decreases with the logarithm of the frequency

Test Conditions:

Temperature (Norm) = + 24 °C Voltage = 24 V DC (through USB Port and NUP(RS232) Port)

Relative humidity = 62 %

Test result:

Power Mode: 24V DC Through NUP(RS232) Port

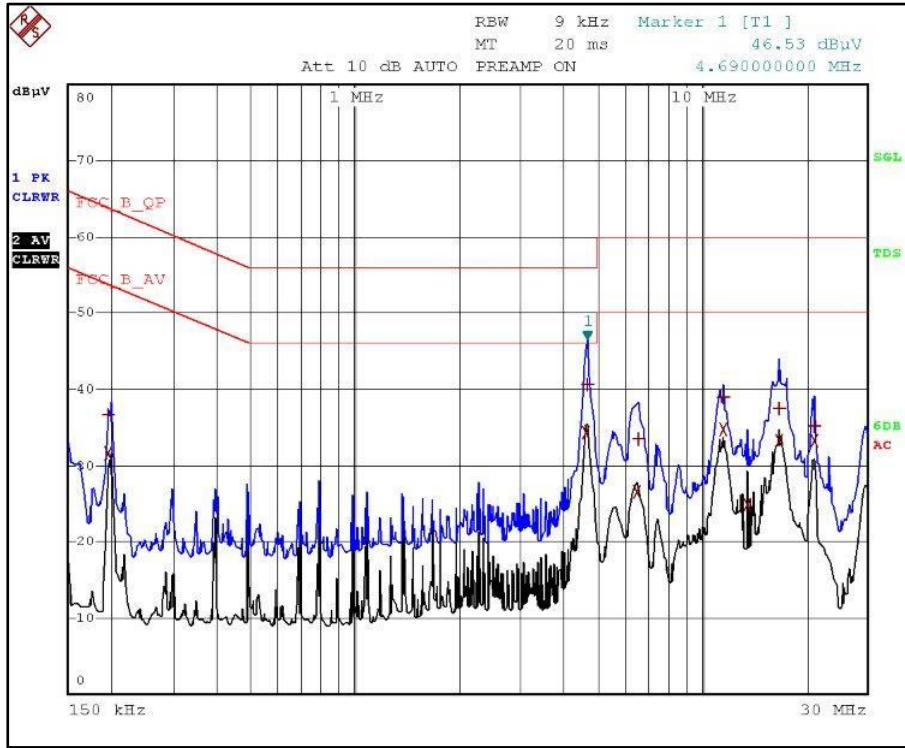

Graph: Line

EDIT PEAK LIST (Final Measurement Results)				
Trace1:	FCC_B_QP			
Trace2:	FCC_B_AV			
Trace3:	---			
TRACE	FREQUENCY	LEVEL dBµV	DELTA	LIMIT dB
2 Average	4.638 MHz	34.41	-11.58	
2 Average	11.554 MHz	34.74	-15.25	
1 Quasi Peak	4.69 MHz	40.67	-15.32	
2 Average	21.038 MHz	33.26	-16.73	
2 Average	16.786 MHz	33.24	-16.75	
1 Quasi Peak	11.554 MHz	38.92	-21.07	
2 Average	198 kHz	31.66	-22.02	
1 Quasi Peak	16.786 MHz	37.53	-22.46	
2 Average	6.53 MHz	26.46	-23.53	
1 Quasi Peak	21.042 MHz	35.17	-24.82	
2 Average	13.562 MHz	24.94	-25.05	
1 Quasi Peak	6.554 MHz	33.41	-26.58	
1 Quasi Peak	198 kHz	36.69	-26.99	

Results: Line

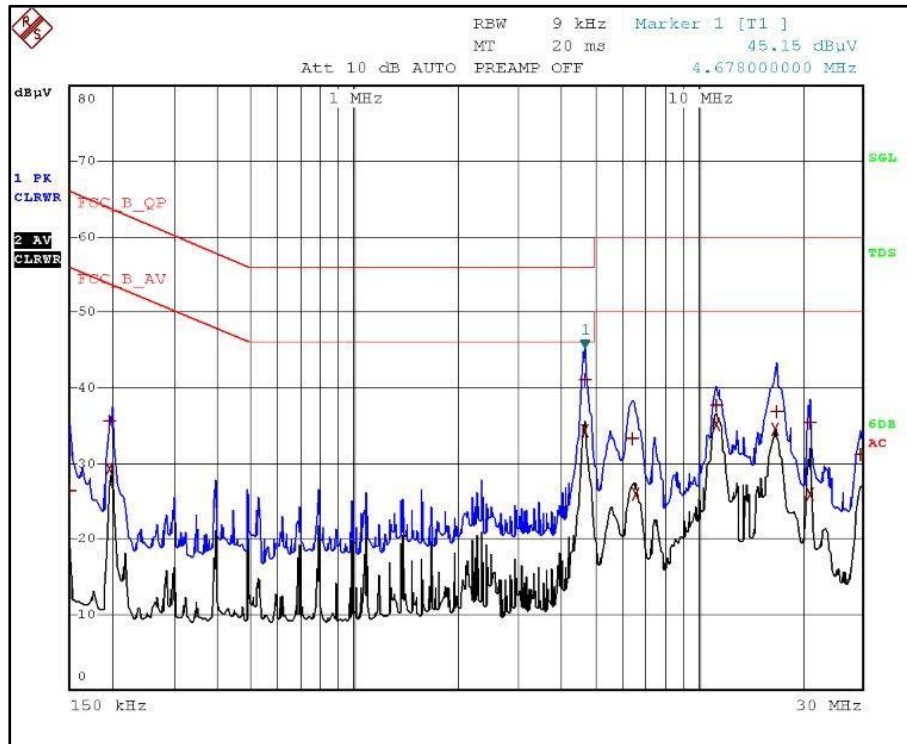

Graph: Neutral

EDIT PEAK LIST (Final Measurement Results)				
TRACE	FREQUENCY	LEVEL dBµV	DELTA	LIMIT dB
Trace1:	FCC_B_QP			
Trace2:	FCC_B_AV			
Trace3:	---			
2 Average	4.678 MHz	34.40	-11.59	
2 Average	11.35 MHz	35.24	-14.75	
1 Quasi Peak	4.678 MHz	41.09	-14.90	
2 Average	16.686 MHz	34.62	-15.37	
1 Quasi Peak	11.35 MHz	37.76	-22.23	
1 Quasi Peak	16.886 MHz	36.88	-23.11	
2 Average	6.57 MHz	25.98	-24.01	
2 Average	21.09 MHz	25.90	-24.09	
2 Average	198 kHz	29.20	-24.49	
1 Quasi Peak	21.086 MHz	35.28	-24.71	
1 Quasi Peak	6.418 MHz	33.26	-26.73	
1 Quasi Peak	198 kHz	35.64	-28.05	
1 Quasi Peak	29.546 MHz	31.18	-28.81	
1 Quasi Peak	150 kHz	26.27	-39.72	

Results: Neutral

Power Mode: 24V DC Through (USB Port)

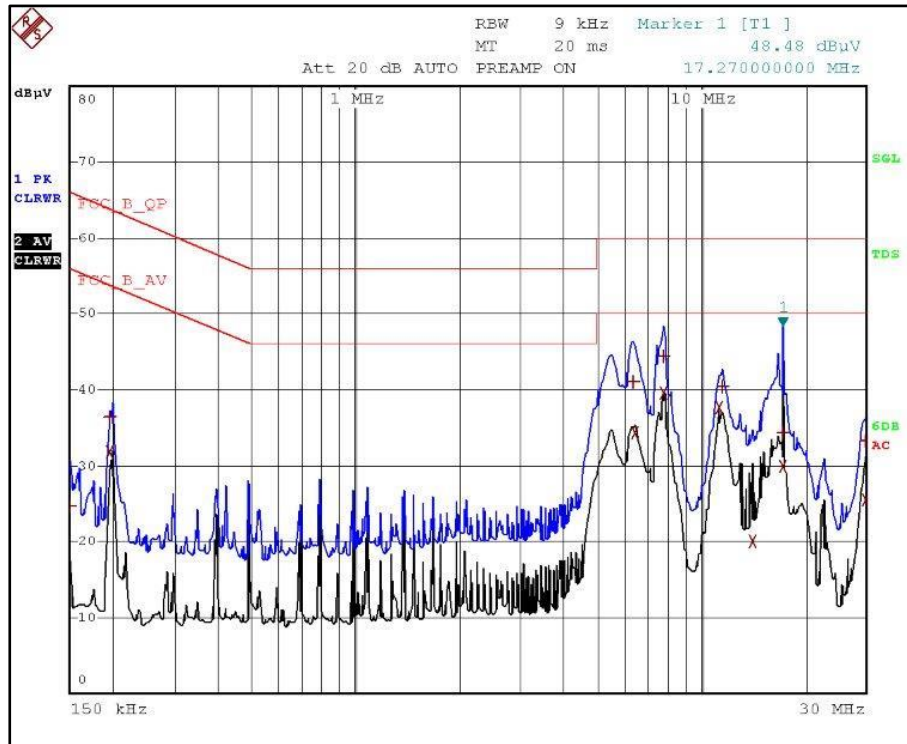

Graph: Line

EDIT PEAK LIST (Final Measurement Results)				
TRACE	FREQUENCY	LEVEL dBµV	DELTA	LIMIT dB
Trace1:	FCC_B_QP			
Trace2:	FCC_B_AV			
Trace3:	---			
2 Average	7.794 MHz	39.57	-10.42	
2 Average	11.35 MHz	37.60	-12.39	
1 Quasi Peak	7.798 MHz	44.40	-15.59	
2 Average	6.426 MHz	34.27	-15.72	
1 Quasi Peak	6.358 MHz	41.10	-18.89	
1 Quasi Peak	11.55 MHz	40.31	-19.68	
2 Average	17.27 MHz	30.02	-19.97	
2 Average	198 kHz	31.76	-21.92	
2 Average	29.878 MHz	25.48	-24.51	
1 Quasi Peak	17.27 MHz	34.26	-25.73	
1 Quasi Peak	29.934 MHz	33.27	-26.73	
1 Quasi Peak	198 kHz	36.36	-27.33	
2 Average	14.078 MHz	19.98	-30.01	
1 Quasi Peak	150 kHz	24.62	-41.37	

Results: Line

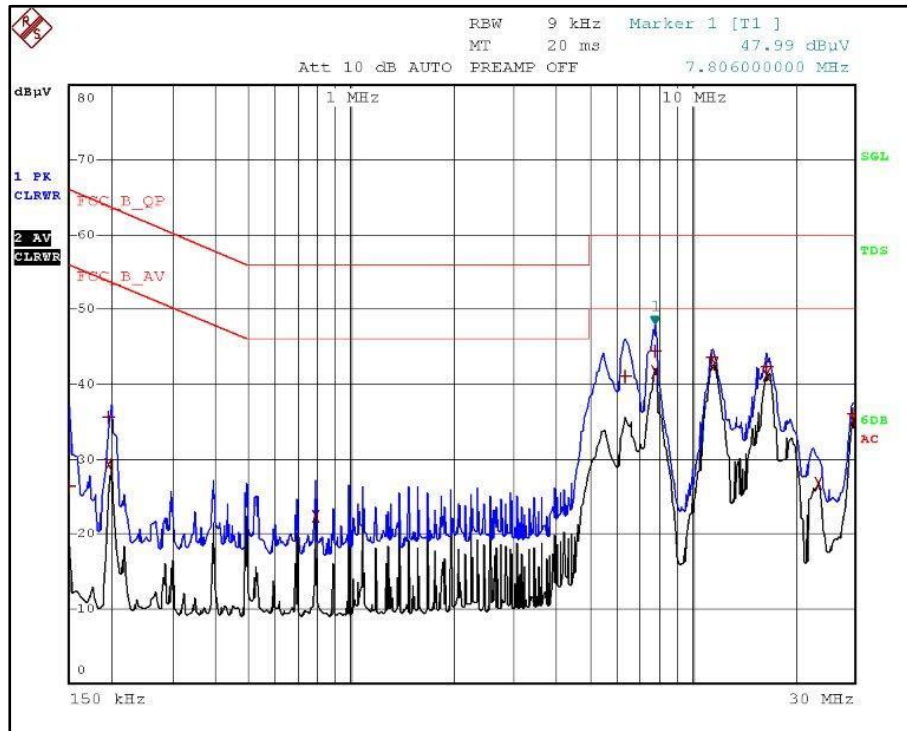

Graph: Neutral

EDIT PEAK LIST (Final Measurement Results)			
TRACE	FREQUENCY	LEVEL dBµV	DELTA LIMIT dB
Trace1:	FCC_B_QP		
Trace2:	FCC_B_AV		
Trace3:	---		
2 Average	11.65 MHz	42.80	-7.19
2 Average	7.81 MHz	41.73	-8.26
2 Average	16.578 MHz	41.17	-8.82
2 Average	29.706 MHz	35.13	-14.86
1 Quasi Peak	7.806 MHz	44.36	-15.63
1 Quasi Peak	11.454 MHz	43.66	-16.33
1 Quasi Peak	16.578 MHz	42.40	-17.59
1 Quasi Peak	6.398 MHz	40.94	-19.05
2 Average	23.498 MHz	26.73	-23.26
2 Average	790 kHz	22.35	-23.64
1 Quasi Peak	29.606 MHz	35.91	-24.08
2 Average	198 kHz	29.20	-24.48
1 Quasi Peak	198 kHz	35.57	-28.12
1 Quasi Peak	150 kHz	26.44	-39.55

Graph: Results

10 LIST OF TABLES

Table 1: List of test and measurement instruments	6
Table 2: Instrument application Software versions	7
Table 3: Ratings and System Details as declared by the Client*	8
Table 4: Measurement Uncertainty	9
Table 5: TUV Sample identification details	10
Table 6: List of Wi-Fi 5GHz center Frequencies	11
Table 7: Undesirable emission limits	18
Table 8: Transmitter limits for Radiated emission	19
Table 9: RSE Test Results of Simultaneous Operation with Cellular and Non-Cellular:	28

*****END OF TEST REPORT*****