

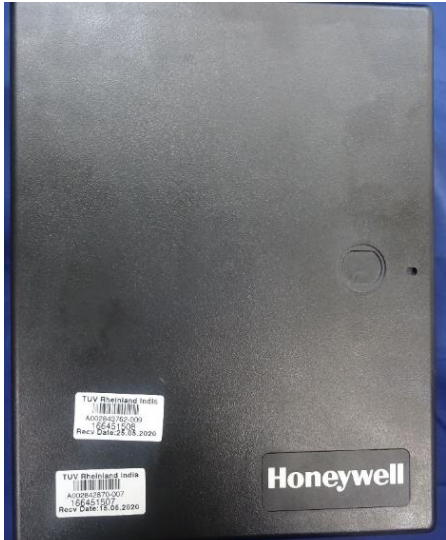

Prüfbericht-Nr.: <i>Test report no.:</i>	ULR-TC568820300000025F	Auftrags-Nr.: <i>Order no.:</i>	166451508 0030	Seite 1 von 34 <i>Page 1 of 34</i>
Kunden-Referenz-Nr.: <i>Client reference no.:</i>	NA	Auftragsdatum: <i>Order date:</i>	2019-05-14	
Auftraggeber: <i>Client:</i>	Honeywell International Inc 12, Clintonville Rd, Northford, CT, USA 06472; +1 203 4847161			
Prüfgegenstand: <i>Test item:</i>	CLSS Gateway			
Bezeichnung / Serien-Nr.: <i>Identification / Serial no.:</i>	HON-CGW-MBB			
Auftrags-Inhalt: <i>Order content:</i>	Testing and Issue of FCC and IC certification			
Prüfgrundlage: <i>Test specification:</i>	FCC Part 15 Subpart C 15.247, 15.207 RSS 247 Issue 2 and RSS Gen Issue 5			
Wareneingangsdatum: <i>Date of sample receipt:</i>	2020-05-15			
Prüfmuster-Nr.: <i>Test sample no.:</i>	A002843762-001 A002843762-009			
Prüfzeitraum: <i>Testing period:</i>	2020-05-15 - 2020-06-19			
Ort der Prüfung: <i>Place of testing:</i>	Wireless laboratory, Bangalore			
Prüflaboratorium: <i>Testing laboratory:</i>	TÜV Rheinland (India) Pvt. Ltd. 27/B, 2 nd Cross, Electronic City Phase I, Bangalore – 560100, India			
Prüfergebnis*: <i>Test result*:</i>	Pass			
geprüft von: <i>tested by:</i>	genehmigt von: <i>authorized by:</i>			
Datum: <i>Date:</i> 2020-05-21		Ausstellatum: <i>Issue date:</i> 2020-08-28		
Stellung / Position:	Raviraj Kamati Engineer	Stellung / Position:	Mahammadgouse Kaladagi Assistant Manager	
Sonstiges / Other:	FCC ID: PV3CGWMB IC:1609A-CGWMB Contains FCC IDs: R17LE910NAV2, R17LE910SVV2 Contains IC:5131A-LE910NAV2; 5131A-LE910SVV2			
Zustand des Prüfgegenstandes bei Anlieferung: <i>Condition of the test item at delivery:</i>	Prüfmuster vollständig und unbeschädigt <i>Test item complete and undamaged</i>			
* Legende:	1 = sehr gut P(ass) = entspricht o.g. Prüfgrundlage(n)	2 = gut F(ail) = entspricht nicht o.g. Prüfgrundlage(n)	3 = befriedigend N/A = nicht anwendbar	4 = ausreichend N/T = nicht getestet
* Legend:	1 = very good P(ass) = passed a.m. test specification(s)	2 = good F(ail) = failed a.m. test specification(s)	3 = satisfactory N/A = not applicable	4 = sufficient N/T = not tested
<p>Dieser Prüfbericht bezieht sich nur auf das o.g. Prüfmuster und darf ohne Genehmigung der Prüfstelle nicht auszugsweise vervielfältigt werden. Dieser Bericht berechtigt nicht zur Verwendung eines Prüfzeichens. <i>This test report only relates to the a. m. test sample. Without permission of the test center this test report is not permitted to be duplicated in extracts. This test report does not entitle to carry any test mark.</i></p>				

v05

TEST SUMMARY

Test Item	Applicable Standard		Result
	FCC	ISED	
Maximum conducted output power	FCC 15.247(b)(3)	RSS 247 Issue 2, Section 5.4 (d)	Pass
Spurious Radiated Emissions and Restricted Bands of Operation	FCC 15.209 / FCC 15.205	RSS-Gen Issue 5, Section 8.9 / 8.10	Pass
Conducted Emissions on a.c Power Lines	FCC 15.207	RSS-Gen Issue 5, Section 8.8	Pass

Note: N/T: Not Tested

CLSS Gateway product was certified with FCC ID: PV3CGWMB , IC:1609A-CGWMB, hence other test cases are excluded which can be found in the test report ULR-TC56881930000099F and ULR-TC568819300000085F issued to Honeywell by TUV Rheinland India.

Product Category: Electronics Testing
Test Discipline: EMC Test Facility

Prüfbericht - Nr.:
Test Report No.:

ULR-TC568820300000025F

Seite 1 von 34
Page 1 of 34

REVISION HISTORY OF THIS REPORT

Report Number	Version	Description	Issue date
ULR-TC568820300000025F	01	Initial issue of report	01.07.2020
ULR-TC568820300000025F	02	Correction in the module identification from CGW-MB to HON-CGW-MBB Note: the Model HON-CGW-MBB covers the addition of Cellular module, hence the changes done to CLSS gateway under C2PC approach shall be only applicable to this model	10.08.2020
ULR-TC568820300000025F	03	Change in HVIN from CCM-BM28 RevA to HON-CGW-MBB	28.08.2020

Table of Contents

1	GENERAL REMARKS	5
1.1	Attachments	5
2	TEST SITES	6
2.1	Testing Facilities.....	6
2.2	List of Test and Measurement Instruments.....	6
3	GENERAL PRODUCT INFORMATION.....	8
3.1	Product Function and Intended Use.....	8
3.2	Ratings and System Details of Equipment under Test	8
3.3	Simultaneous operation	9
3.4	Measurement Uncertainty:	9
4	TEST SET-UP AND OPERATION MODE	10
4.1	Principle of Configuration Selection	10
4.2	Operation and Software of the EUT	10
4.3	Test modes – data rates and modulations.....	10
4.4	Special Accessories and Auxiliary Equipment	10
4.5	Countermeasures to achieve EMC Compliance	10
4.6	Report references.....	10
4.7	List of frequencies	11
5	Operational Description of the product	12
6	Block Diagram of the product	12
7	TEST METHODOLOGY	13
7.1	Conducted Spurious Emission Test on AC Power Line.....	13
7.1.1	Test Setup Configuration	13
7.2	Radiated Emission Test	14
7.2.1	Test Setup Configuration	14
8	TEST RESULTS	16
8.1	Maximum Average Conducted Output Power.....	16
8.2	Spurious Radiated Emissions & Restricted Bands of Operation	19
9	Conducted Spurious Emission Test on AC Power Line	29
10	LIST OF TABLES.....	34

1 GENERAL REMARKS

1.1 Attachments

All attachments are part of this test report and are issued in separate document

1. TEST SETUP PHOTOS
- 2: EUT EXTERNAL PHOTOS
- 3: EUT INTERNAL PHOTOS
- 4: FCC LABEL AND LABEL LOCATION
- 5: BLOCK DIAGRAM
- 6: SPECIFICATION OF EUT
- 7: SCHEMATIC DIAGRAM
- 8: BILL OF MATERIAL
- 9: USER MANUAL
- 10: MAXIMUM PERMISSIBLE EXPOSURE INFORMATION

2 TEST SITES

2.1 Testing Facilities

1. TÜV Rheinland (India) Pvt.Ltd.,
27/B, 2nd Cross,
ElectronicCityPhase1
Bangalore – 560 100,
India
2. TUV Rheinland (India) Private Limited
108 , Beside ISBR Business School,
Electronic city Phase I
Bangalore - 560 100.
India

2.2 List of Test and Measurement Instruments

Table 1: List of test and measurement instruments

Equipment	Manufacturer	Model Name	Serial Number	Firmware Versions	Calibration Due Date	Periodicity	Test Facility
EMI Receiver	Rohde & Schwarz	ESU 40	100288	4.43 SP3	11.10.2020	Yearly	Radiated Spurious Emission
Active loop antenna	Frankonia	LAX-10	LAX-10-800	-	15.07.2020	Yearly	
Biconical Antenna	Schwarzbeck	VHBB91 24+BBA 9106	9124-1208+9106-0525	-	16.01.2021	Yearly	
Log - Periodical Antenna	Schwarzbeck	VUSLP 9118 A	VULP9118A-0733	-	17.01.2021	Yearly	
Horn Antenna	Schwarzbeck	BBHA 9120 D	9120D-1944	-	17.07.2020	Yearly	
Horn Antenna	Schwarzbeck	BBHA 9170	BBHA 9170-0904	-	29.01.2021	Yearly	
Semi Anechoic Chamber	Frankonia	-	-	-	-	-	
Fully Anechoic Chamber	Albatross	-	-	-	-	-	
Spectrum Analyser	Agilent Technologies	E4407B	US41192772	A.14.06	28.09.2020	Yearly	Antenna - Port Measurements
EMI Receiver	Rohde & Schwarz	ESW 44	101732	-	10.12.2020	Yearly	AC Power line conducted emission
LISN	Rohde & Schwarz	ENV 216	100022	-	05.09.2020	Yearly	
Pulse Limiter	Rohde & Schwarz	ESH3-Z2	100811	-	01.08.2020	Yearly	

Prüfbericht - Nr.:
Test Report No.:

ULR-TC568820300000025F

Seite 1 von 34
Page 1 of 34

Table 2: Instrument application Software versions

SL. No.	Test Type	Application software	Version
1	Radiated spurious emission measurement in SAC	EMC 32	10.60.00
2	Radiated spurious emission measurement in FAC	EMC 32	10.60.00

3 GENERAL PRODUCT INFORMATION

3.1 Product Function and Intended Use

The gateway acts as a portal among fire alarm panels, and peripheral devices. The gateway connection with the fire alarm panel enables reading the inventory and transmitting the data. The connection with Cloud facilities remotely monitoring and managing the fire detection systems.

3.2 Ratings and System Details of Equipment under Test

Table 3: Ratings and System Details as declared by Client*

Radio Protocol	Bluetooth	
Operating Frequency Range	2402MHz – 2480MHz	
No. of Channels	79	
Channel Spacing	1MHz	
Modulation	GFSK, pi/4-DQPSK, 8-DPSK	
Number of antennas	1	
Antenna Gain	3 dBi	
Antenna Type	Printed F Antenna	
Supply Voltage to Product	24V DC (powered through USB Port / NUP(RS232) Port)	
Environmental conditions	Storage	-10°C to +60° C
	Operating	
EUT Dimension	200mm x 70mm x 255mm	

Cellular Module	AT & T	Verizon
FCC ID	RI7LE910NAV2	RI7LE910SVV2
IC ID	5131A-LE910NAV2	5131A-LE910SVV2
HVIN	LE910-NA V2	LE910-SV1
PMN	LE910-NA V2	LE910-SV1

Supply Voltage to Product : CLSS gateway can be powered with the following ports	
Port	Powered through
USB Port	Fire alarm control panel
NUP (RS232) Port	Fire alarm control panel

***Disclaimer:** The information/data is supplied by the client and the same is considered to arrive at the final value. Any changes made apart from the specified specification, can directly impact on the tests results. Refer the products user manual for more details.

Note: Product CLSS Gateway has multiple protocols. All the supported wireless protocols and their respective test results are issued in separate test reports, refer clause 4.6.

3.3 Simultaneous operation

Mode 1 Combinations of Simultaneous Operations	BT - LTE (AT&T) BT - WCDMA (AT&T)
Mode 2 Combinations of Simultaneous Operations	BT - LTE (Verizon)

Cellular Module	AT & T	Verizon
FCC ID	RI7LE910NAV2	RI7LE910SVV2
IC ID	5131A-LE910NAV2	5131A-LE910SVV2
HVIN	LE910-NA V2	LE910-SV1
PMN	LE910-NA V2	LE910-SV1

Note: Simultaneous Operation was performed with the above mentioned combination and worst case test results are mentioned in this report.

3.4 Measurement Uncertainty:

Reported uncertainties represent expanded uncertainties expressed at approximately the 95% confidence level using a coverage factor of $k = 2$

Table 4: Measurement Uncertainty

Parameter	Uncertainty
RF output power, conducted	±0.51 dB
Power Spectral Density, conducted	±0.85 dB
Unwanted Emissions, conducted	±2.58 dB
SAC, radiated measurement	±3.67 dB
FAC, radiated measurement	±4.95 dB
Temperature	±3 °C
Supply Voltages	±3 %
Time	±5 %

Note: The listed uncertainties are the worst case uncertainty for the entire range of measurements and are for the reporting purpose only and are not used in determining the PASS/FAIL of the results.

4 TEST SET-UP AND OPERATION MODE

4.1 Principle of Configuration Selection

Transmission was enabled with highest possible duty cycle on Low, Mid and High channels.

4.2 Operation and Software of the EUT

Software Name: FW 2.5
Software Version: 3.0.1.16
Hardware Name: CLSS Gateway
Hardware version: HON-CGW-MBB
Hardware Reference: CCM-BM28 RevA

4.3 Test modes – data rates and modulations

Conducted and Radiated spurious emissions tests were performed and reported only for EUT worst case operating modes

4.4 Special Accessories and Auxiliary Equipment

- Test laptop and USB cable
- Fire Alarm control panel (to power up CLSS gateway through USB or NUP(RS232) Port)

4.5 Countermeasures to achieve EMC Compliance

- None

4.6 Report references

Note: Product CLSS Gateway has multiple protocols. All the supported wireless protocols and their respective test results are issued in separate test reports.

SL. No.	RF Protocol / Frequency Bands	Report No.
1	LTE, WCDMA	ULR-TC568820300000023F
2	WLAN 2.4GHz & BLE	ULR-TC568820300000024F
3	BT	ULR-TC568820300000025F
4	WLAN 5GHz	ULR-TC568820300000026F

Table 5: TUV Sample identification details

Samples used for Testing	S/N Number
Antenna port measurement	A002842870-001
Radiated mode test	A002842870-009

4.7 List of frequencies

Frequency Band (GHz)	Channel No.	Frequency (MHz)
.Bluetooth (2.4-2.4835)	0	2402
	1	2403
	2	2404
	3	2405
	:	:
	:	:
	37	2439
	38	2440
	39	2441
	:	:
	:	:
	74	2476
	75	2477
	.	.
	.	.
78	2480	

Channels used for BT testing

Channel low : 2402MHz

Channel mid : 2440MHz

Channel High : 2480MHz

5 Operational Description of the product

The gateway acts as a portal among fire alarm panels, and peripheral devices. The gateway connection with the fire alarm panel enables reading the inventory and transmitting the data. The connection with Cloud facilities remotely monitoring and managing the fire detection systems.

6 Block Diagram of the product

The Gateway Board's Layout

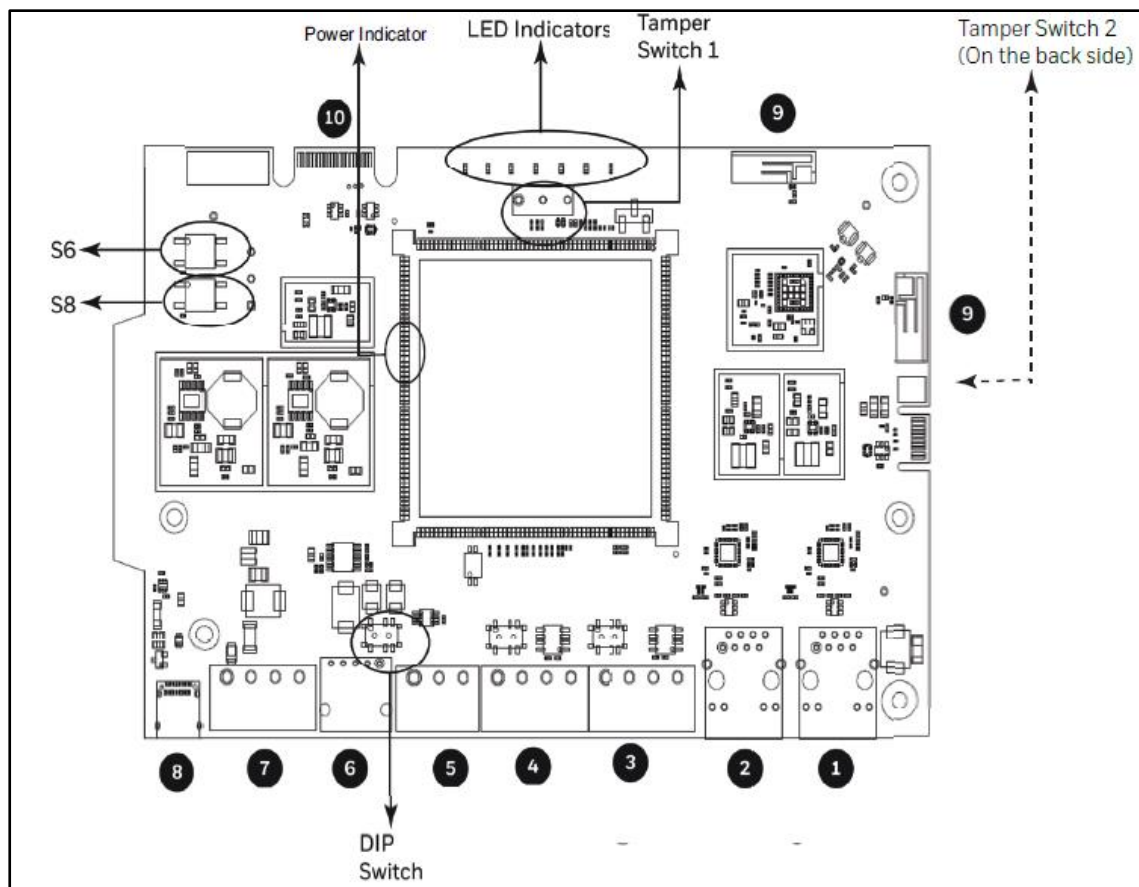

PCB Layout

7 TEST METHODOLOGY

7.1 Conducted Spurious Emission Test on AC Power Line

Measured levels of ac power-line conducted emission across the 50Ω LISN port (to which the EUT is connected). All emission voltage and current measurements shall be made on each current-carrying conductor at the plug end of the EUT power cord by the use of mating plugs and receptacles on the LISN, if used. Equipment shall be tested with power cords that are normally supplied or recommended by the manufacturer and that have electrical and shielding characteristics that are the same as those cords normally supplied or recommended by the manufacturer.

The device is placed on the test table, raised 80cm above the reference ground plane. The vertical conducting plane is located 40cm to the rear of the device. AC Conducted emission measurement is made over frequency range from 150kHz to 30MHz, this measurement was performed with EUT powered by 2 methods and both method are tested individually, one with an AC adaptor with 110V AC 60Hz supply and second with Wireless charger with supply 110V AC 60Hz.

7.1.1 Test Setup Configuration

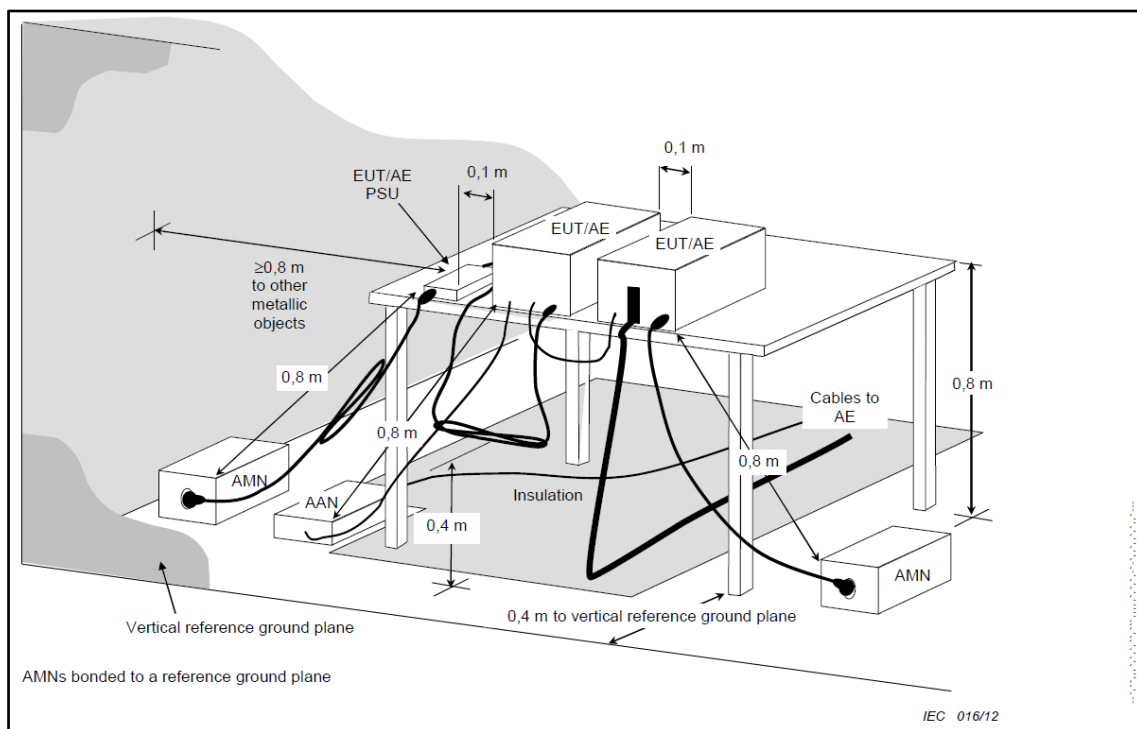

7.2 Radiated Emission Test

The radiated emission measurement was performed according to the procedures in ANSI C63.10-2013. The equipment under test (EUT) was placed at the middle of the 80 cm high turntable for below 1 GHz & 1.5 m height for above 1 GHz measurement, and the EUT is 3 meters far from the measuring antenna. The turntable was rotated 360° for obtaining the maximum emission. The height of the measuring antennas was scanned between 1 m and 4 m, and the antenna rotated to repeat the measurements for both the horizontal and vertical antenna polarizations. Repeat the measurement steps until the maximum emissions were obtained. The measurement above 1000 MHz was performed by horn antenna, The measurement below 30 MHz was performed by loop antenna, Measurement from 30 MHz to 200 MHz was performed by Baloon and Biconical Antenna, and measurement from 200 MHz to 1 GHz was performed by Log-Periodic Antenna.

The EUT was rotated around the X-, Y-, and Z-Axis and the results from worst case axis are recorded.
Field Strength (dBµV/m) = Measured Value(dBµV) + Antenna Factor(dB) + Cable Loss(dB) – Pre Amplifier Gain (dB)

7.2.1 Test Setup Configuration

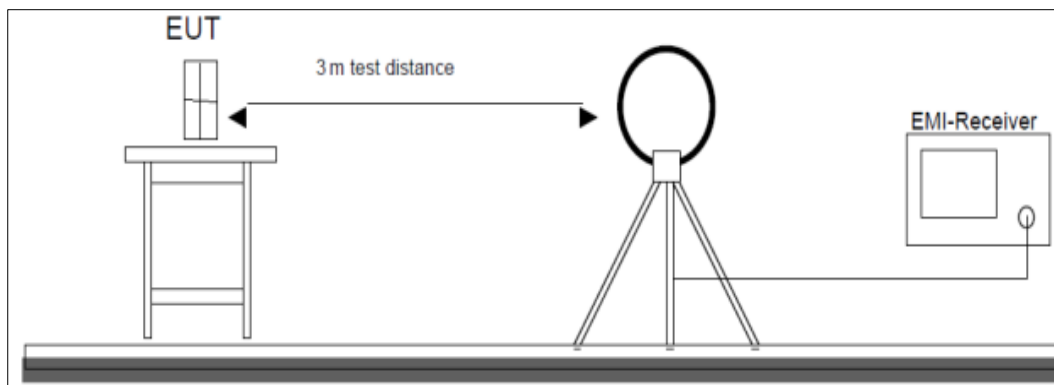

Figure 1: Frequency Range 9 kHz- 30 MHz

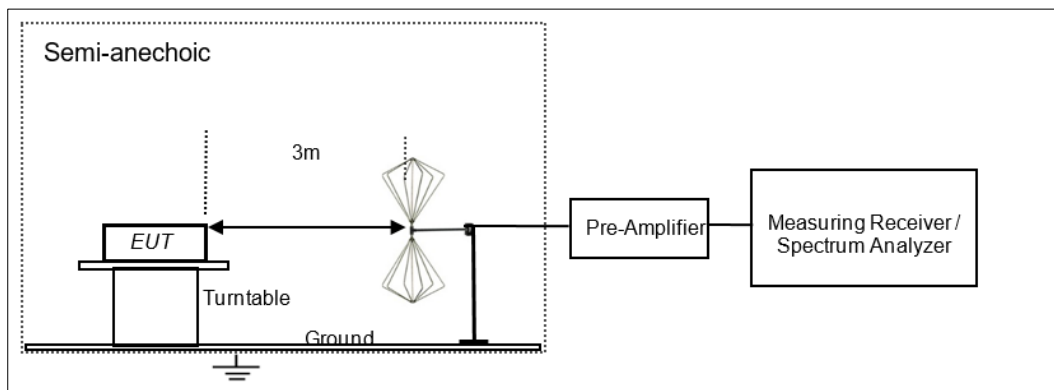

Figure 2: Frequency Range 30 MHz – 200 MHz

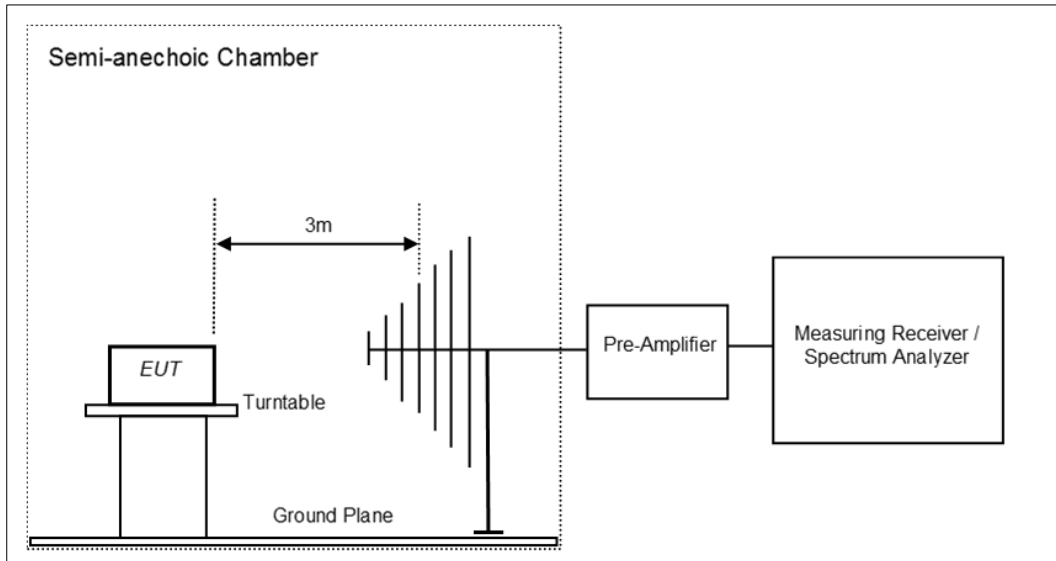

Figure 3: Frequency Range 200 MHz - 1GHz

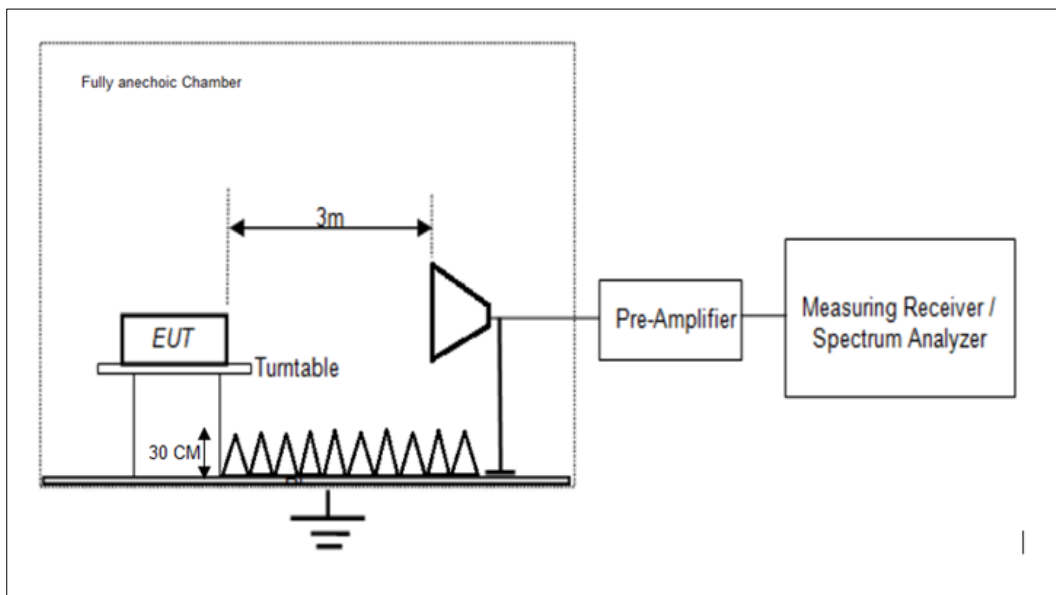

Figure 4: Frequency Range above 1 GHz

8 TEST RESULTS

8.1 Maximum Average Conducted Output Power

Result

Pass

Test Specification	FCC part 15 Subpart C 15.247 (b)(3) / RSS 247 Issue 2, Section 5.4 (d)
Test Method	Subclause 11.9.2.2.4 of ANSI C63.10
Measurement Bandwidth	3 MHz
Detector	Average sample detector
Port of testing	Antenna port
Requirement	Power ≤ 1 W (30 dBm) & e.i.r.p ≤ 4 W (36 dBm)

Test Method

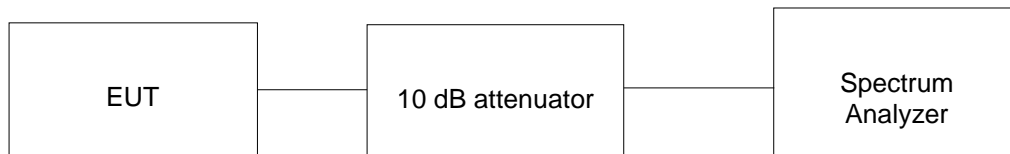

Test Condition

Normal Test Condition:

Temperature (Norm) = + 22.3 °C Voltage = 24V DC (through UAB Port) Relative humidity = 62 %

Test results:

Note:

- All the losses are included during measurement and final values are mentioned in the test report.
- Total Average Output power (dBm) = Measured Average power (dBm) + Attenuator factor (10dB) + Cable loss (2dB)
- This product do not support additional beamforming gain / directional gain, it uses signal antenna and hence directional gain of the single antenna is 3 dBi
- Maximum (e.i.r.p) = Maximum Average output power (dBm) + antenna gain (3 dBi)

Data rate (Mbps)	Channel (MHz)	Maximum Peak Conducted Output Power (dBm)	Maximum (e.i.r.p) (dBm)	Limit (dBm)	e.i.r.p Limit (dBm)
1Mbps	2402	8.31	11.31	30.00	36
	2440	7.33	10.33	30.00	36
	2480	5.90	8.90	30.00	36
2Mbps	2402	9.11	12.11	20.96	36
	2440	7.90	10.9	20.96	36
	2480	6.50	9.50	20.96	36
3Mbps	2402	9.47	12.47	20.96	36
	2440	8.39	11.39	20.96	36
	2480	7.05	10.05	20.96	36

Worst Case Plots for 3Mbps:

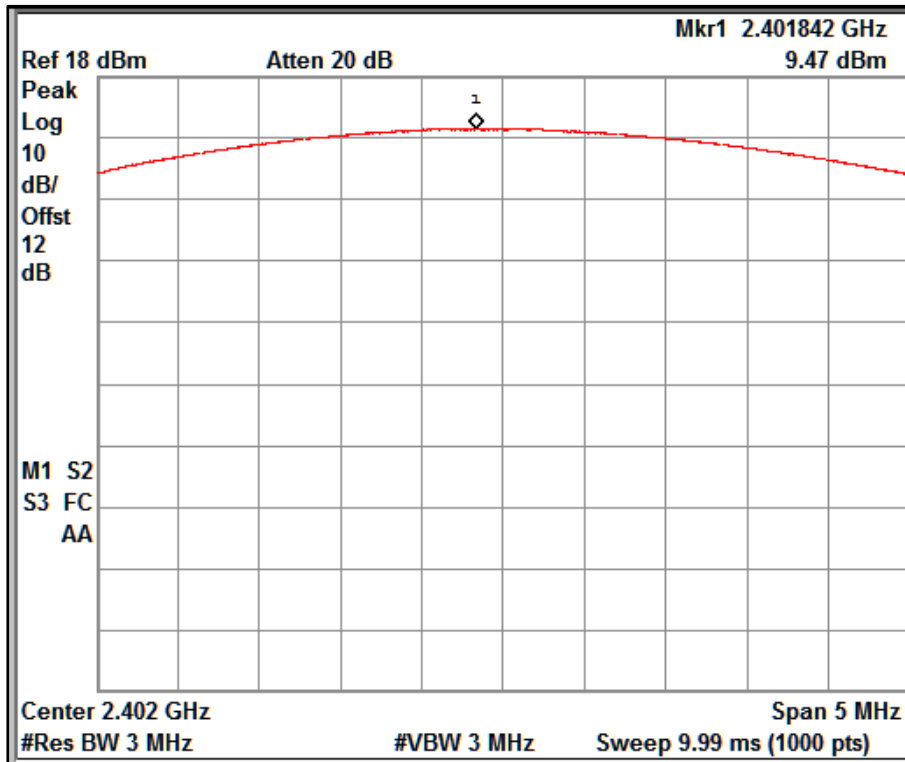

Channel Frequency: 2402MHz

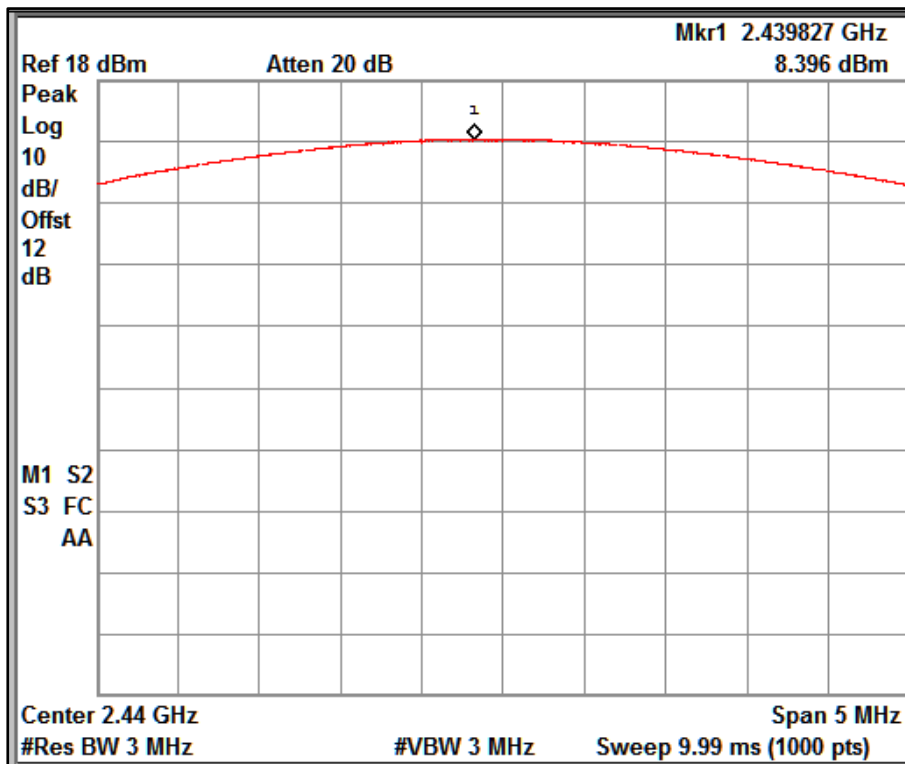

Channel Frequency: 2440MHz

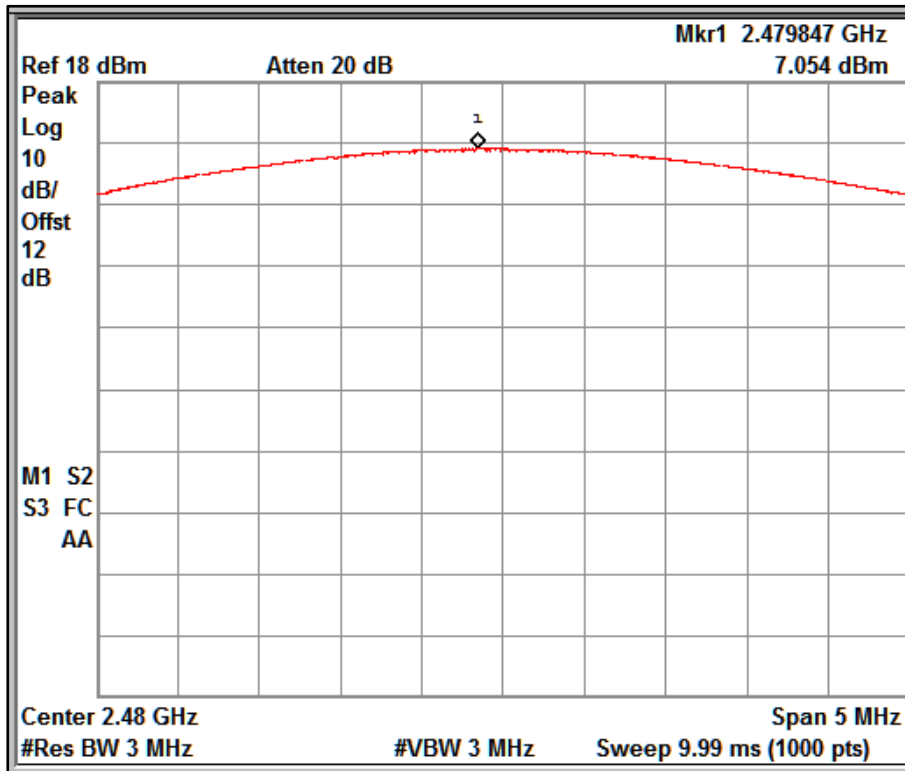

Channel Frequency: 2480MHz

8.2 Spurious Radiated Emissions & Restricted Bands of Operation

Result	Pass
Test Specification	FCC part 15 Subpart C 15.247 (d) / (15.209 & 15.205) / IC RSS-GEN, Section 8.9 and 8.10
Test Method	ANSI C63.10
Measurement Location	Fully anechoic chamber
Measurement Bandwidth	100 kHz for frequency range < 1GHz 1 MHz for Frequency range >1GHz
Detector	Refer remarks below
Measuring Distance	3 m
Requirement	As per the limits mentioned in the below table
Test setup	Reffer TEST METHODOLOGY

Table 6: Transmitter limits for Radiated emission

Frequency (MHz)	Field strength (µV/m)	Field strength (dBµV/m)	Distance of Measurement (m)
0.009 – 0.490	2400/F(kHz)	48.50 – 13.80	300*
0.490 – 1.705	24000/F(kHz)	33.80 – 23.00	30*
1.705 -30	30	29.54	30*
30-88	100	40.0	3
88-216	150	43.5	3
216-960	200	46.0	3
Above 960	500	54.0	3

Remark: * The limit shows in the table above of frequency range 0.009 – 0.490, 0.490 – 1.705 MHz and 1.705-30MHz is at 300 meter, 30 meter and 30 meter range respectively, which corresponds to 128.51 – 93.80, 73.80 – 62.96 and 69.54 dBµV/m at 3m range by extrapolation calculation and the measurement of loop antenna.

The emission limits shown in the above table are based on measurements employing a CISPR quasi-peak detector except for the frequency bands 9–90 kHz, 110–490 kHz and above 1000 MHz Radiated emission limits in these three bands are based on measurements employing an average detector.

Environmental conditions:

Temperature (Norm) = + 24 °C Voltage = 24 V DC (through USB Port and NUP(RS232) Port)

Relative humidity = 62 %

Note: For the above 1 GHz worst case test results observed in power mode 24 V DC (through USB Port)

Prüfbericht - Nr.:
Test Report No.:

ULR-TC568820300000025F

Seite 1 von 34
Page 1 of 34

Test results:

Note: All the losses are included during measurement and final values are mentioned in the test report. Refer TEST METHODOLOGY for more details

Test Results:

Test results for frequency range 9kHz – 30MHz

No emissions found in frequency range 9 kHz to 30 MHz, and measured levels are below 20dB from the limit line, have not reported

Test results for frequency range 30MHz – 200MHz

Power Mode: 24V DC Through NUP(RS232) Port

Antenna Polarization	Frequency (MHz)	Peak Emission (dB μ V/m)	Limit (dB μ V/m)	Margin (dB)
Vertical	30.758	25.16	40.00	-14.84
	97.569	25.02	43.50	-18.48
	113.785	28.78	43.50	-14.72
	120.038	24.97	43.50	-18.53
Horizontal	95.913	17.54	43.50	-25.96
	125.008	34.21	43.50	-9.29
	150.002	36.60	43.50	-6.90

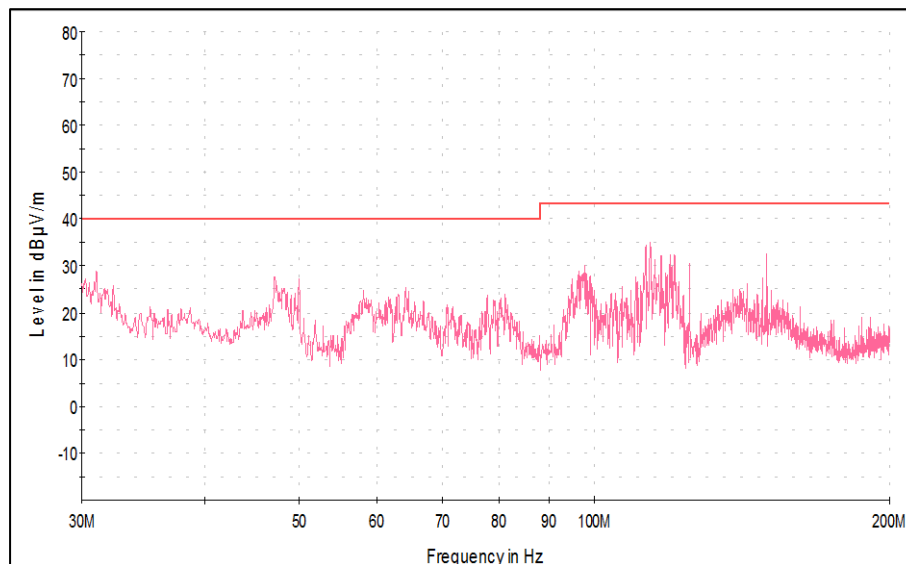

Polarization: Vertical

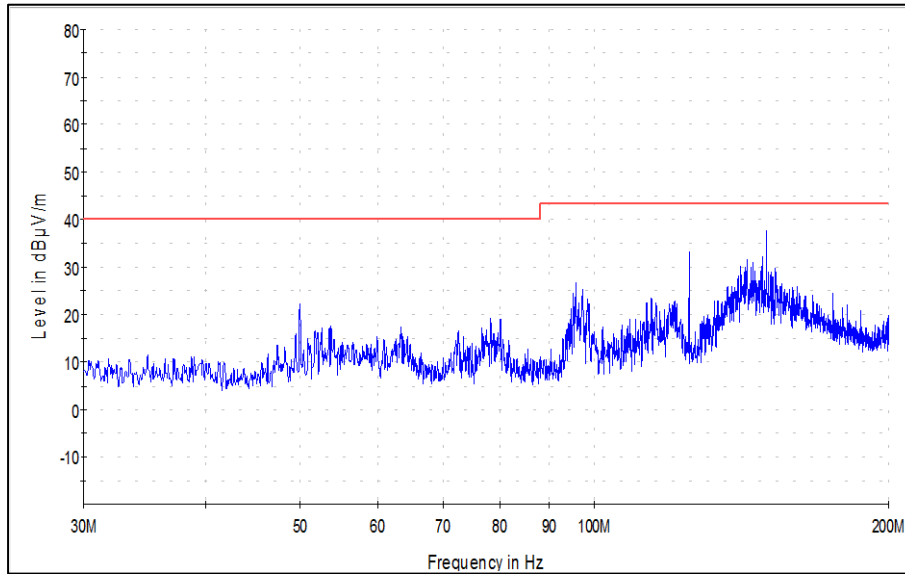

Polarization: Horizontal

Power Mode: 24V DC Through (USB Port)

Antenna Polarization	Frequency (MHz)	Peak Emission (dBµV/m)	Limit (dBµV/m)	Margin (dB)
Vertical	38.69	22.30	40.00	-17.70
	49.99	28.12	40.00	-11.88
	124.98	32.09	43.50	-11.41
	149.98	35.02	43.50	-8.48
Horizontal	50.00	21.85	40.00	-18.15
	125.00	30.86	43.50	-12.64
	149.99	34.41	43.50	-9.09
	155.61	32.12	43.50	-11.38

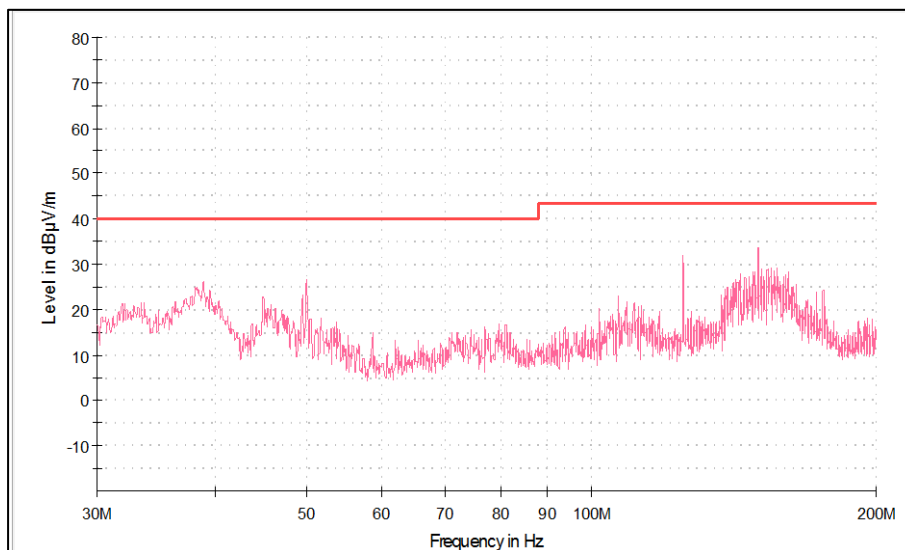

Polarization: Vertical

Prüfbericht - Nr.:
Test Report No.:

ULR-TC568820300000025F

Seite 1 von 34
Page 1 of 34

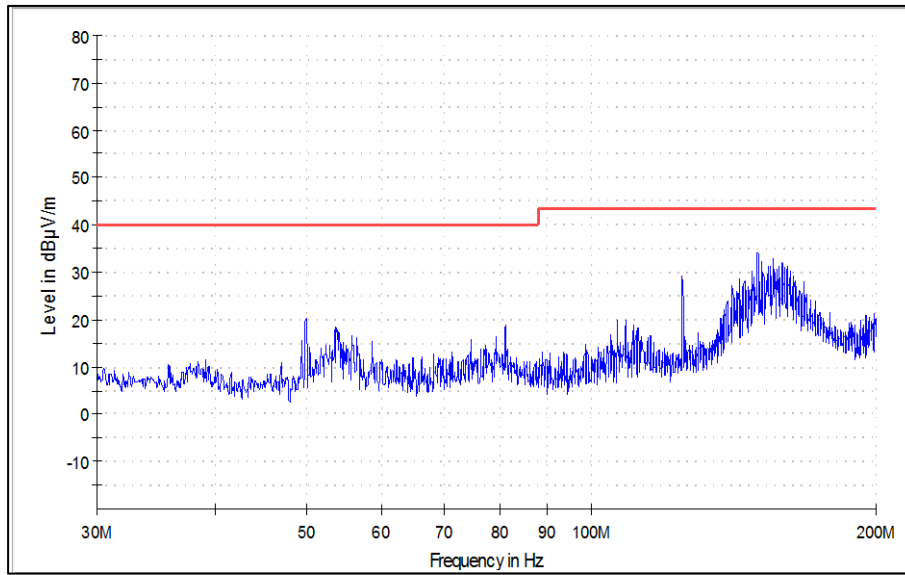

Polarization: Horizontal

Test results for frequency range 200MHz – 1GHz

Power Mode: 24V DC Through NUP(RS232) Port

Antenna Polarization	Frequency (MHz)	Peak Emission (dB μ V/m)	Limit (dB μ V/m)	Margin (dB)
Vertical	346.48	28.11	46.00	-17.89
	544.48	32.95	46.00	-13.05
	841.49	32.57	46.00	-13.43
	940.49	37.21	46.00	-8.79
Horizontal	249.97	34.80	46.00	-11.20
	346.49	28.97	46.00	-17.03
	742.48	30.84	46.00	-15.16
	841.50	32.19	46.00	-13.81

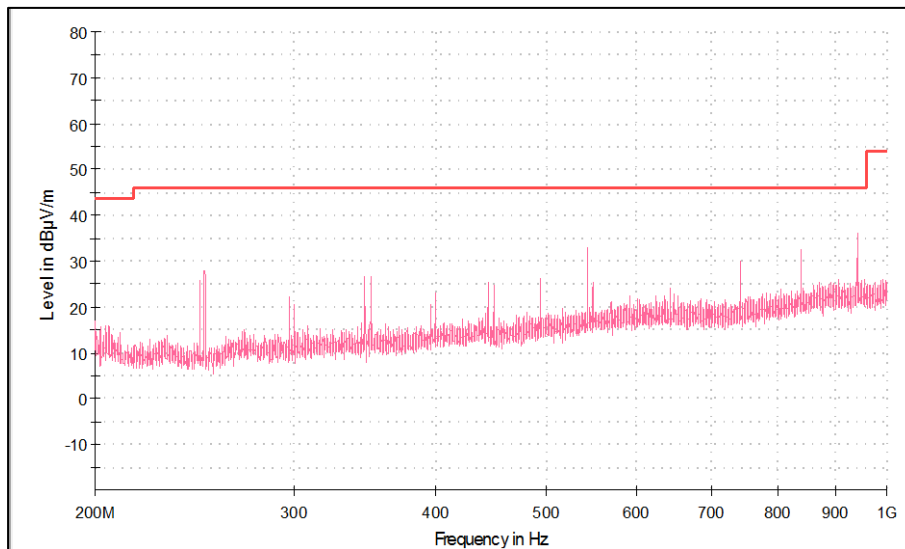

Polarization: Vertical

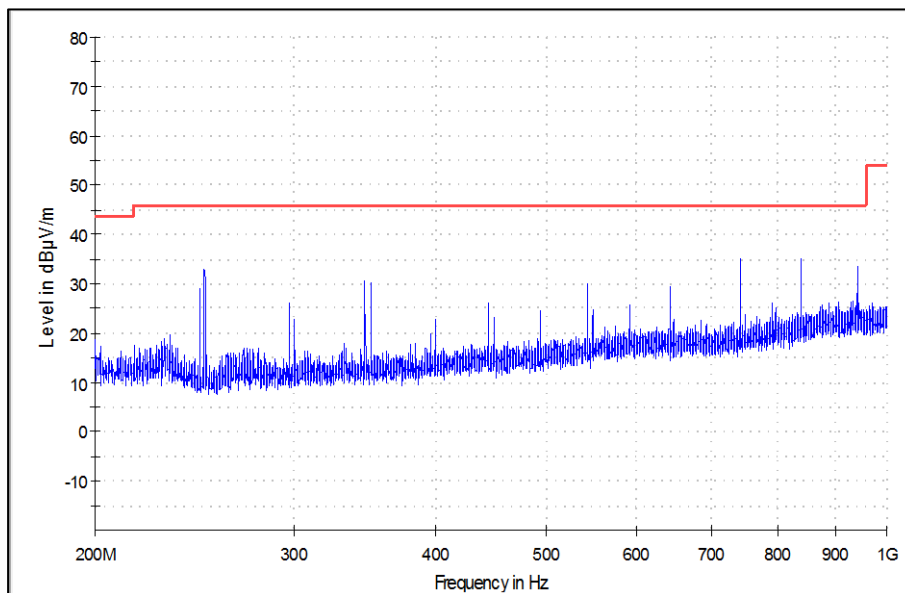

Polarization: Horizontal

Power Mode: 24V DC Through (USB Port)

Antenna Polarization	Frequency (MHz)	Peak Emission (dB μ V/m)	Limit (dB μ V/m)	Margin (dB)
Vertical	346.49	25.12	46.00	-20.88
Vertical	445.50	30.54	46.00	-15.46
Vertical	940.50	32.85	46.00	-13.15
Horizontal	249.96	32.76	46.00	-13.24
Horizontal	544.49	34.07	46.00	-11.93
Horizontal	841.49	31.88	46.00	-14.12

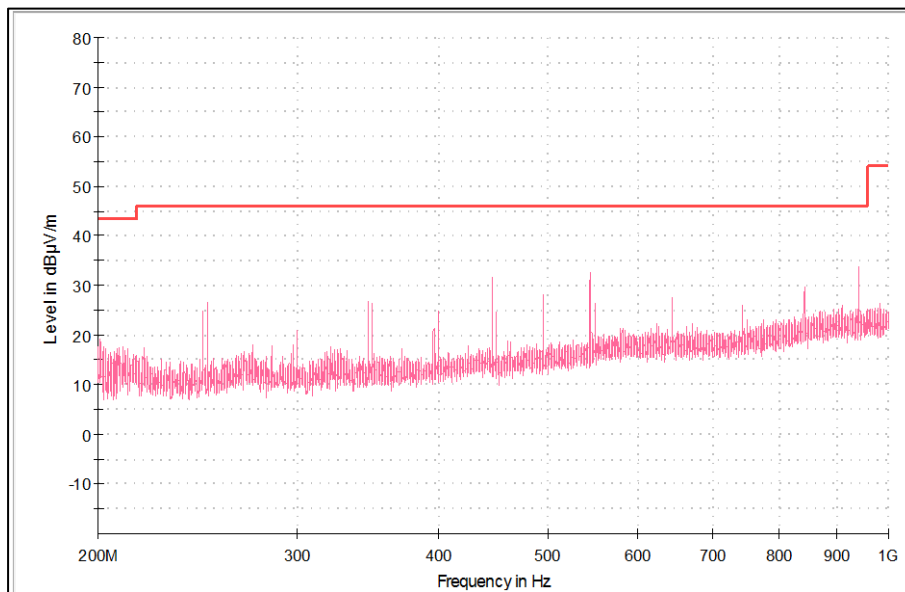

Polarization: Vertical

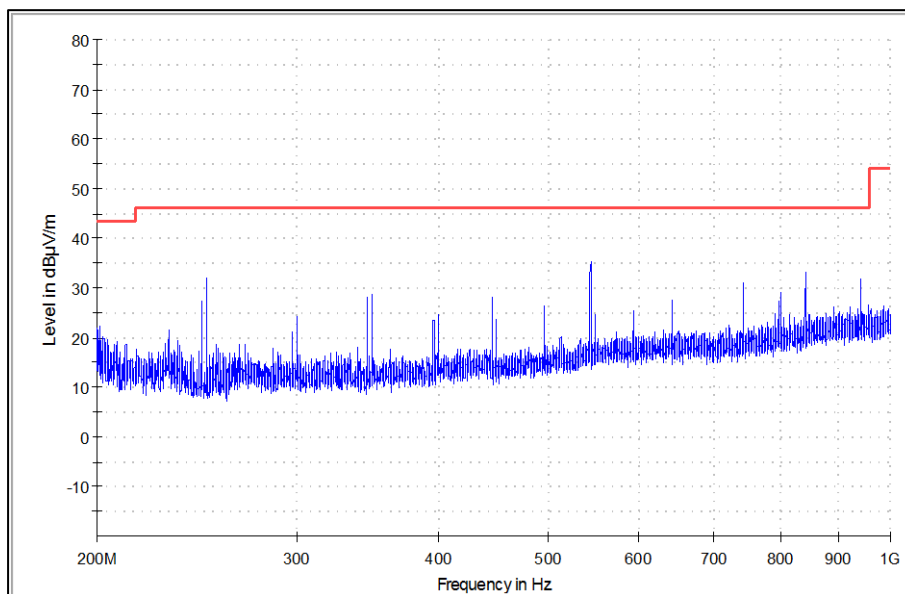

Polarization: Horizontal

Test results for the frequencies in the range 1 GHz to 26.5 GHz

Data rate: 3Mbps

Channel Frequency (MHz)	Antenna Polarization	Measured Frequency (MHz)	Field Strength (dB μ V/m)	Limit (dB μ V/m)	Margin (dB)
2402	Vertical	2390(Pk)	41.58	74*	-32.42
		2390(Av)	27.03	54*	-26.97
		2402(Pk)	105.14	-	-
		2402(Av)	92.72	-	-
		4804(Pk)	41.73	74	-32.27
		4804(Av)	28.43	54	-25.57
		7206(Pk)	47.06	74	-26.94
		7206(Av)	34.21	54	-19.79
	Horizontal	2390(Pk)	39.02	74*	-34.98
		2390(Av)	25.25	54*	-28.75
		2402(Pk)	101.02	-	-
		2402(Av)	87.32	-	-
		4804(Pk)	41.75	74	-32.25
		4804(Av)	29.09	54	-24.91
		7206(Pk)	47.42	74	-26.58
		7206(Av)	34.14	54	-19.86
2440	Vertical	2440(Pk)	103.75	-	-
		2440(Av)	90.48	-	-
		4880(Pk)	41.02	74	-32.98
		4880(Av)	27.94	54	-26.06
		7320(Pk)	46.99	74	-27.01
		7320(Av)	34.22	54	-19.78
	Horizontal	2440(Pk)	100.32	-	-
		2440(Av)	86.41	-	-
		4880(Pk)	40.59	74	-32.98
		4880(Av)	27.87	54	-26.06
		7320(Pk)	47.32	74	-27.01
		7320(Av)	34.21	54	-19.78

*- : Indicate restricted band of operation §15.205
Pk: Peak Detector; Av: Average Detector

Channel Frequency (MHz)	Antenna Polarization	Measured Frequency (MHz)	Field Strength (dBµV/m)	Limit (dBµV/m)	Margin (dB)
2480	Vertical	2480(Pk)	102.46	-	-
		2480(Av)	89.71	-	-
		2483.5(Pk)	59.83	74*	-14.17
		2483.5(Av)	33.91	54*	-20.09
		4960(Pk)	40.52	74	-33.48
		4960(Av)	28.26	54	-25.74
		7480(Pk)	47.13	74	-26.87
		7480(Av)	34.17	54	-19.83
	Horizontal	2480(Pk)	100.97	-	-
		2480(Av)	88.22	-	-
		2483.5(Pk)	58.61	74*	-15.39
		2483.5(Av)	32.56	54*	-21.44
		4960(Pk)	42.25	74	-31.75
		4960(Av)	29.03	54	-24.97
		7480(Pk)	47.18	74	-26.82
		7480(Av)	34.21	54	-19.79

* - : Indicate restricted band of operation §15.205
Pk: Peak Detector; Av: Average Detector

Table 7: RSE Test Results of Simultaneous Operation with Cellular and Non-Cellular:

Note: As specified under the section 3.3 simultaneous combinations mode 1 and mode 2 are performed for AT&T and Verizon Cellular modules, respectively. Only worst-case reported.

Worst case result for Bluetooth and LTE Combination: LTE Band 2 and Bluetooth
Worst case mode : - Mode 1 with AT&T cellular module

Channel Frequency (MHz)	Antenna Polarization	Measured Frequency (MHz)	Field Strength (dBµV/m)	Limit (dBµV/m)	Margin (dB)
2402	Vertical	4804(Pk)	No Harmonics Found		
		4804(Av)			
		7206(Pk)	No Harmonics Found		
		7206(Av)			
	Horizontal	4804(Pk)	42.52	74	-31.48
		4804(Av)	29.51	54	-24.49
		7206(Pk)	No Harmonics Found		
		7206(Av)			

Worst Case Plots:

Data rate: 3Mbps
Channel Frequency: 2402MHz

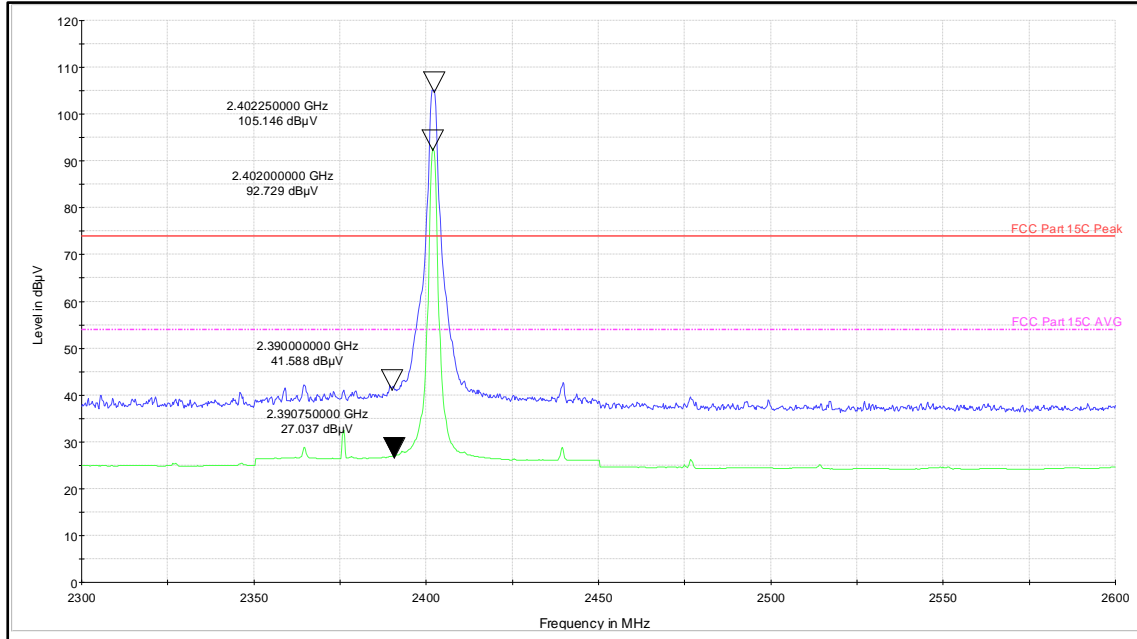

Fundamental Frequency

Polarization: Vertical

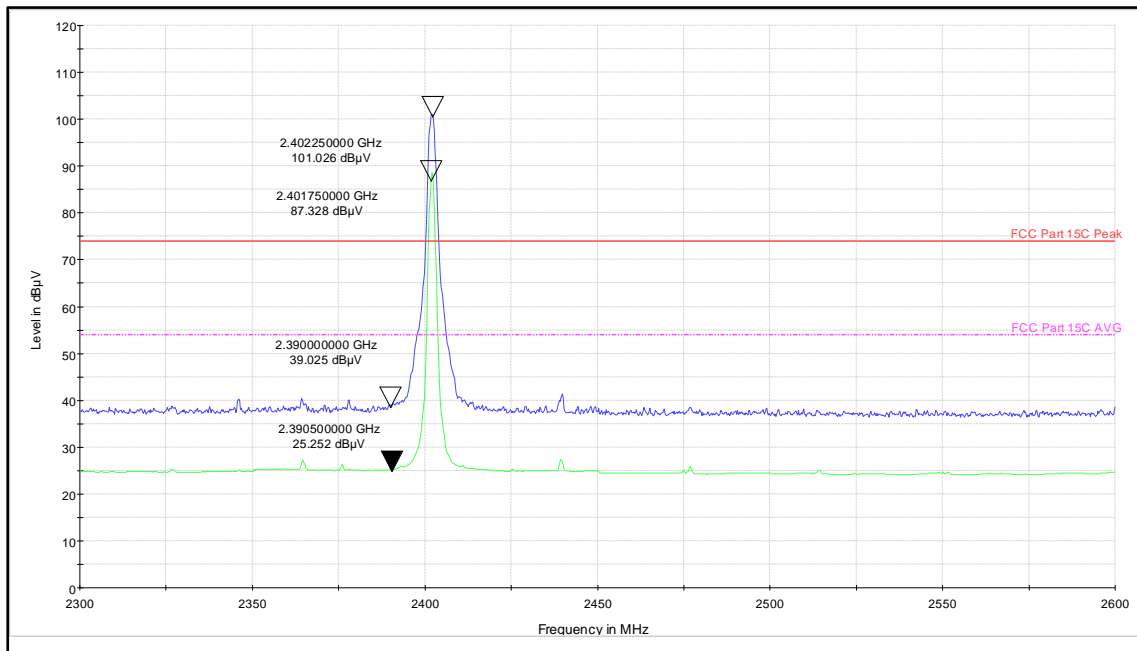

Fundamental Frequency

Polarization: Horizontal

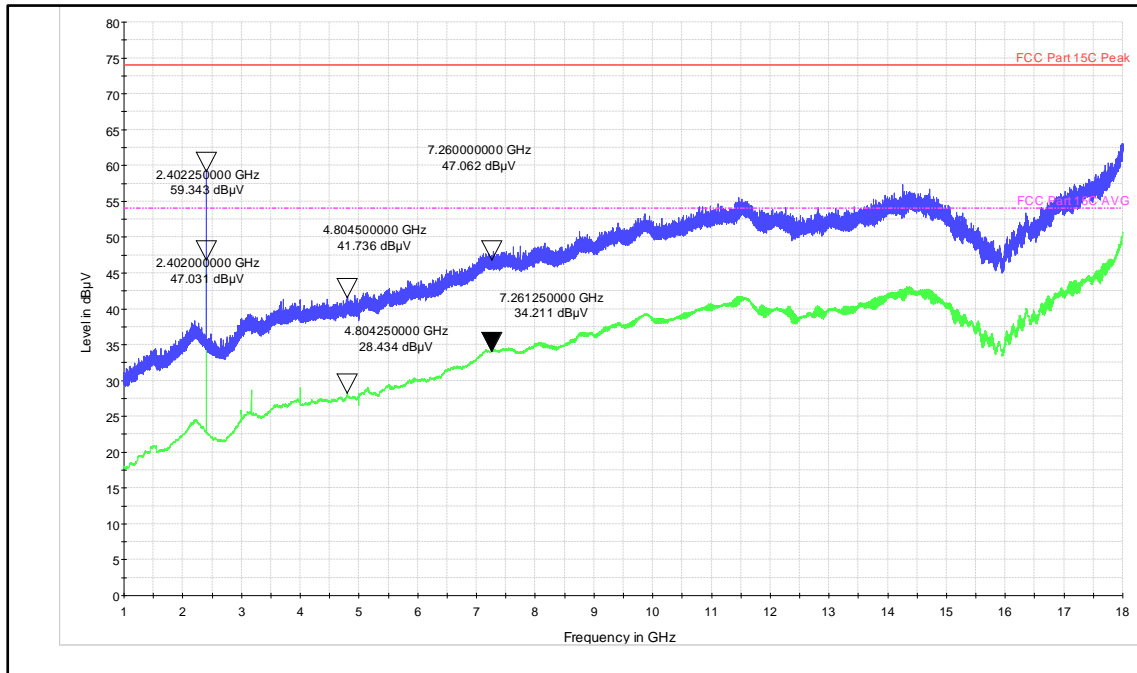

Frequency range: 1GHz to 18GHz

Polarization: Vertical

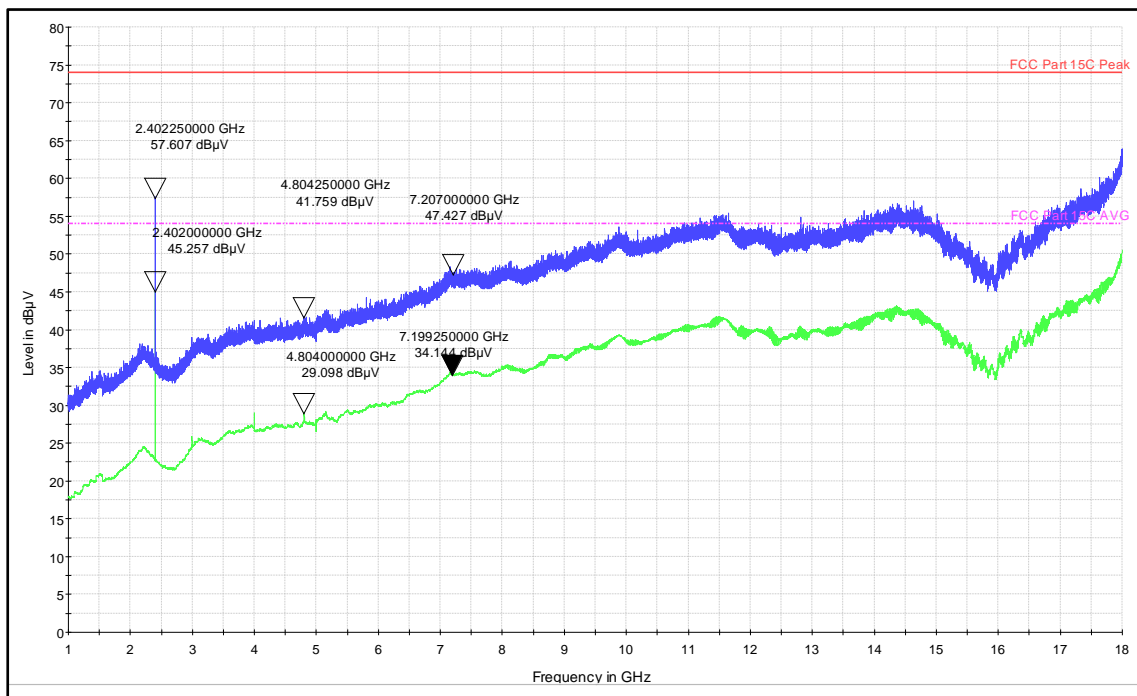

Frequency range: 1GHz to 18GHz

Polarization: Horizontal

9 Conducted Spurious Emission Test on AC Power Line

Result

Pass

Test Specification : FCC Part 15 Section 15.207 / RSS Gen Issue 5 Section 8.8
 Test Method : ANSI C 63.10-2013
 Testing Location : Screened room
 Measurement Bandwidth : 9kHz
 Frequency Range : 150kHz – 30MHz
 Supply Voltage : 110VAC,60Hz
 Test Method : Refer TEST METHODOLOGY

***Note: The product has tested with 24 V DC (through USB Port and NUP(RS232) Port)**

Limits of section 15.207

Frequency of emission (MHz)	QP Limit (dBµV)	AV Limit (dBµV/m)
0.15 – 0.5	66 – 56*	56 – 46*
0.5 – 5	56	46
5 – 30	60	50

* Decreases with the logarithm of the frequency

Test Conditions:

Temperature (Norm) = + 24 °C Voltage = 24 V DC (through USB Port and NUP(RS232) Port)

Relative humidity = 62 %

Test result:

Power Mode: 24V DC Through NUP(RS232) Port

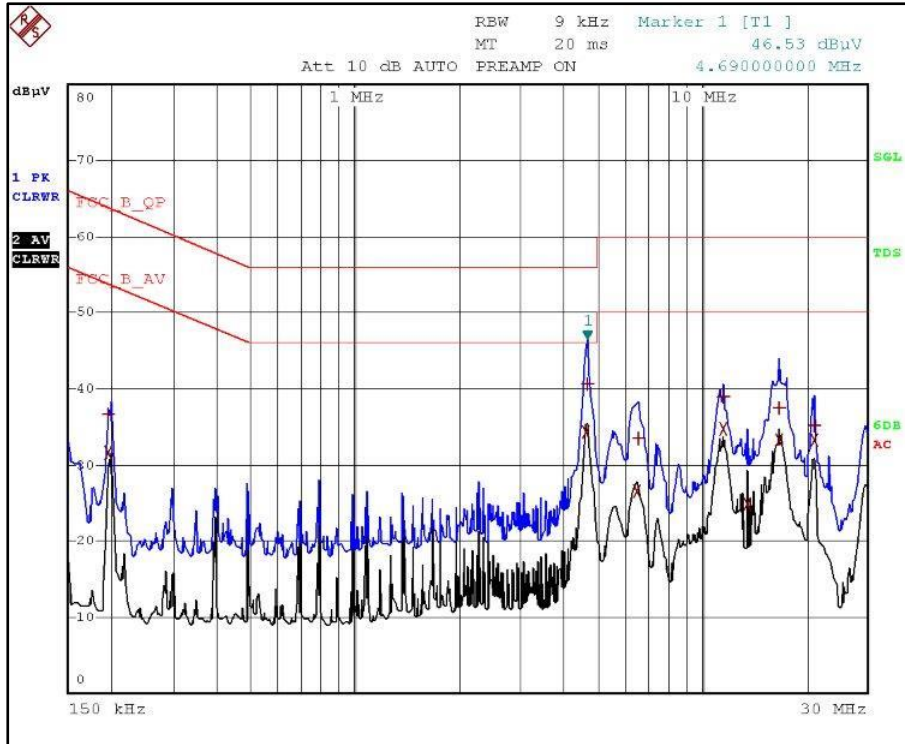

Graph: Line

EDIT PEAK LIST (Final Measurement Results)				
TRACE	FREQUENCY	LEVEL dBµV	DELTA	LIMIT dB
Trace1:	FCC_B_QP			
Trace2:	FCC_B_AV			
Trace3:	---			
2 Average	4.638 MHz	34.41	-11.58	
2 Average	11.554 MHz	34.74	-15.25	
1 Quasi Peak	4.69 MHz	40.67	-15.32	
2 Average	21.038 MHz	33.26	-16.73	
2 Average	16.786 MHz	33.24	-16.75	
1 Quasi Peak	11.554 MHz	38.92	-21.07	
2 Average	198 kHz	31.66	-22.02	
1 Quasi Peak	16.786 MHz	37.53	-22.46	
2 Average	6.53 MHz	26.46	-23.53	
1 Quasi Peak	21.042 MHz	35.17	-24.82	
2 Average	13.562 MHz	24.94	-25.05	
1 Quasi Peak	6.554 MHz	33.41	-26.58	
1 Quasi Peak	198 kHz	36.69	-26.99	

Results: Line

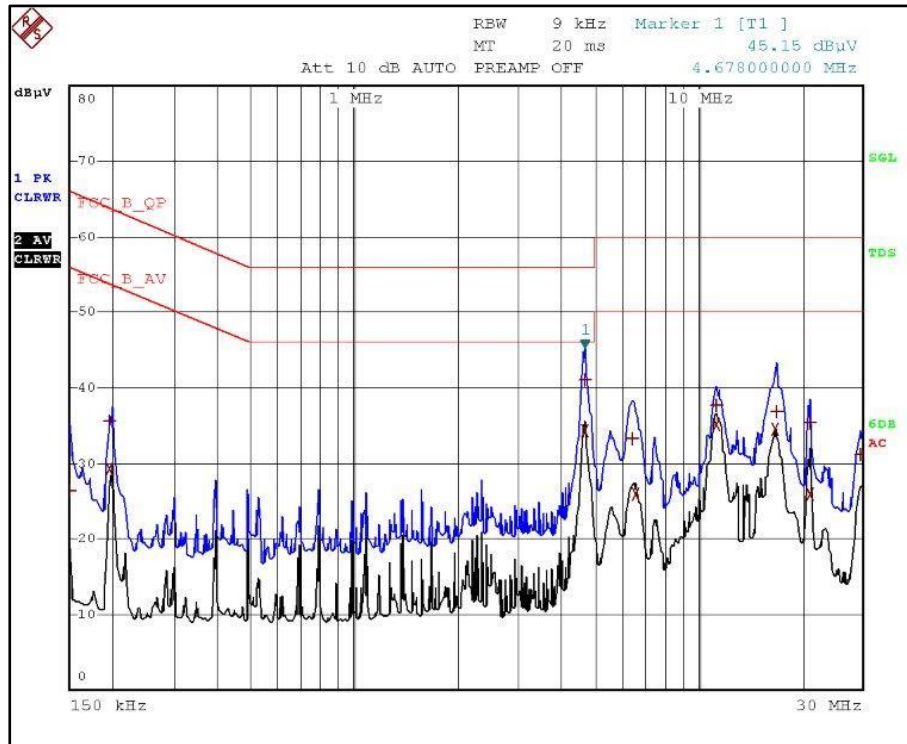

Graph: Neutral

EDIT PEAK LIST (Final Measurement Results)

Trace1: FCC_B_QP
Trace2: FCC_B_AV
Trace3: ---

TRACE	FREQUENCY	LEVEL dBµV	DELTA LIMIT dB
2 Average	4.678 MHz	34.40	-11.59
2 Average	11.35 MHz	35.24	-14.75
1 Quasi Peak	4.678 MHz	41.09	-14.90
2 Average	16.686 MHz	34.62	-15.37
1 Quasi Peak	11.35 MHz	37.76	-22.23
1 Quasi Peak	16.886 MHz	36.88	-23.11
2 Average	6.57 MHz	25.98	-24.01
2 Average	21.09 MHz	25.90	-24.09
2 Average	198 kHz	29.20	-24.49
1 Quasi Peak	21.086 MHz	35.28	-24.71
1 Quasi Peak	6.418 MHz	33.26	-26.73
1 Quasi Peak	198 kHz	35.64	-28.05
1 Quasi Peak	29.546 MHz	31.18	-28.81
1 Quasi Peak	150 kHz	26.27	-39.72

Results: Neutral

Power Mode: 24V DC Through (USB Port)

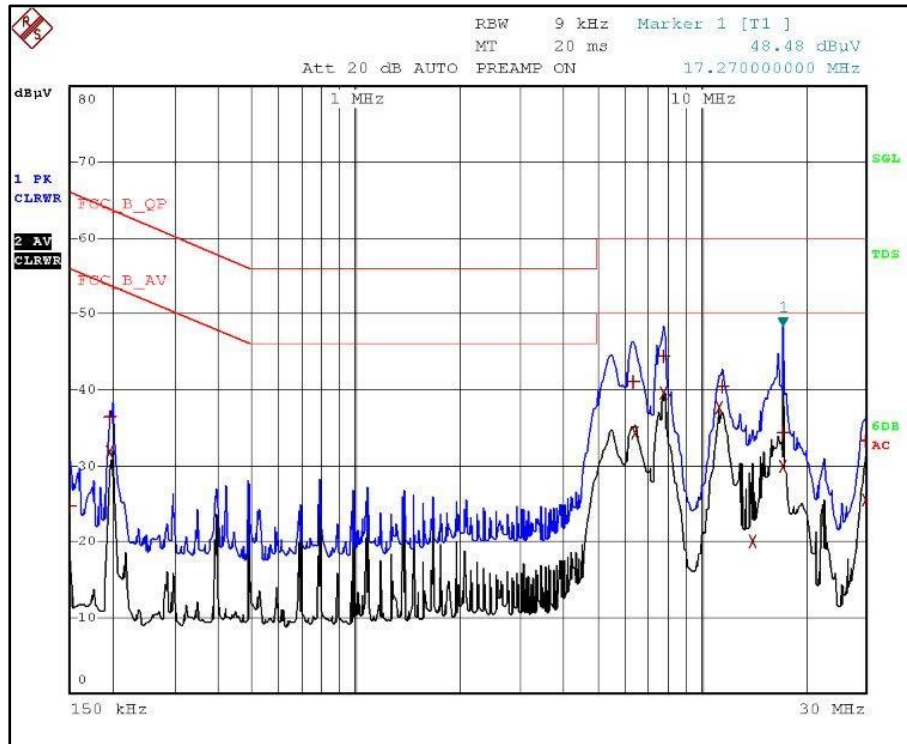

Graph: Line

EDIT PEAK LIST (Final Measurement Results)				
TRACE		FREQUENCY	LEVEL dBµV	DELTA LIMIT dB
Trace1:	FCC_B_QP			
Trace2:	FCC_B_AV			
Trace3:	---			
2	Average	7.794 MHz	39.57	-10.42
2	Average	11.35 MHz	37.60	-12.39
1	Quasi Peak	7.798 MHz	44.40	-15.59
2	Average	6.426 MHz	34.27	-15.72
1	Quasi Peak	6.358 MHz	41.10	-18.89
1	Quasi Peak	11.55 MHz	40.31	-19.68
2	Average	17.27 MHz	30.02	-19.97
2	Average	198 kHz	31.76	-21.92
2	Average	29.878 MHz	25.48	-24.51
1	Quasi Peak	17.27 MHz	34.26	-25.73
1	Quasi Peak	29.934 MHz	33.27	-26.73
1	Quasi Peak	198 kHz	36.36	-27.33
2	Average	14.078 MHz	19.98	-30.01
1	Quasi Peak	150 kHz	24.62	-41.37

Results: Line

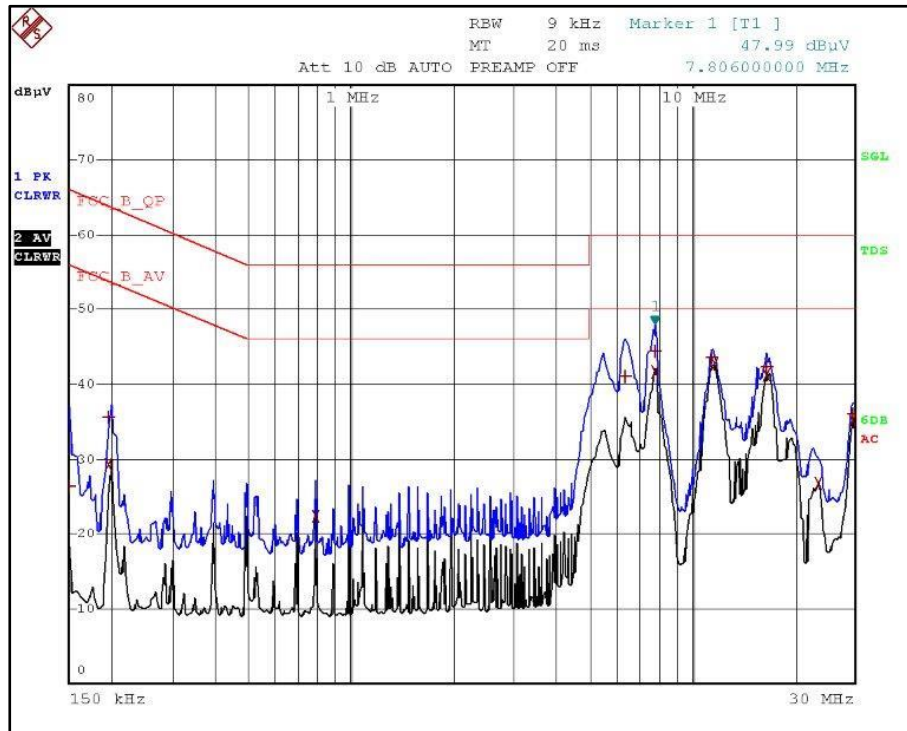

Graph: Neutral

EDIT PEAK LIST (Final Measurement Results)			
TRACE	FREQUENCY	LEVEL dBµV	DELTA LIMIT dB
Trace1:	FCC_B_QP		
Trace2:	FCC_B_AV		
Trace3:	---		
2 Average	11.65 MHz	42.80	-7.19
2 Average	7.81 MHz	41.73	-8.26
2 Average	16.578 MHz	41.17	-8.82
2 Average	29.706 MHz	35.13	-14.86
1 Quasi Peak	7.806 MHz	44.36	-15.63
1 Quasi Peak	11.454 MHz	43.66	-16.33
1 Quasi Peak	16.578 MHz	42.40	-17.59
1 Quasi Peak	6.398 MHz	40.94	-19.05
2 Average	23.498 MHz	26.73	-23.26
2 Average	790 kHz	22.35	-23.64
1 Quasi Peak	29.606 MHz	35.91	-24.08
2 Average	198 kHz	29.20	-24.48
1 Quasi Peak	198 kHz	35.57	-28.12
1 Quasi Peak	150 kHz	26.44	-39.55

Graph: Results

10 LIST OF TABLES

Table 1: List of test and measurement instruments	6
Table 2: Instrument application Software versions	7
Table 3: Ratings and System Details as declared by Client*	8
Table 4: Measurement Uncertainty	9
Table 5: TUV Sample identification details	10
Table 6: Transmitter limits for Radiated emission	19
Table 7: RSE Test Results of Simultaneous Operation with Cellular and Non-Cellular:	26

*****END OF TEST REPORT*****